

CORE™

3x3

User Manual

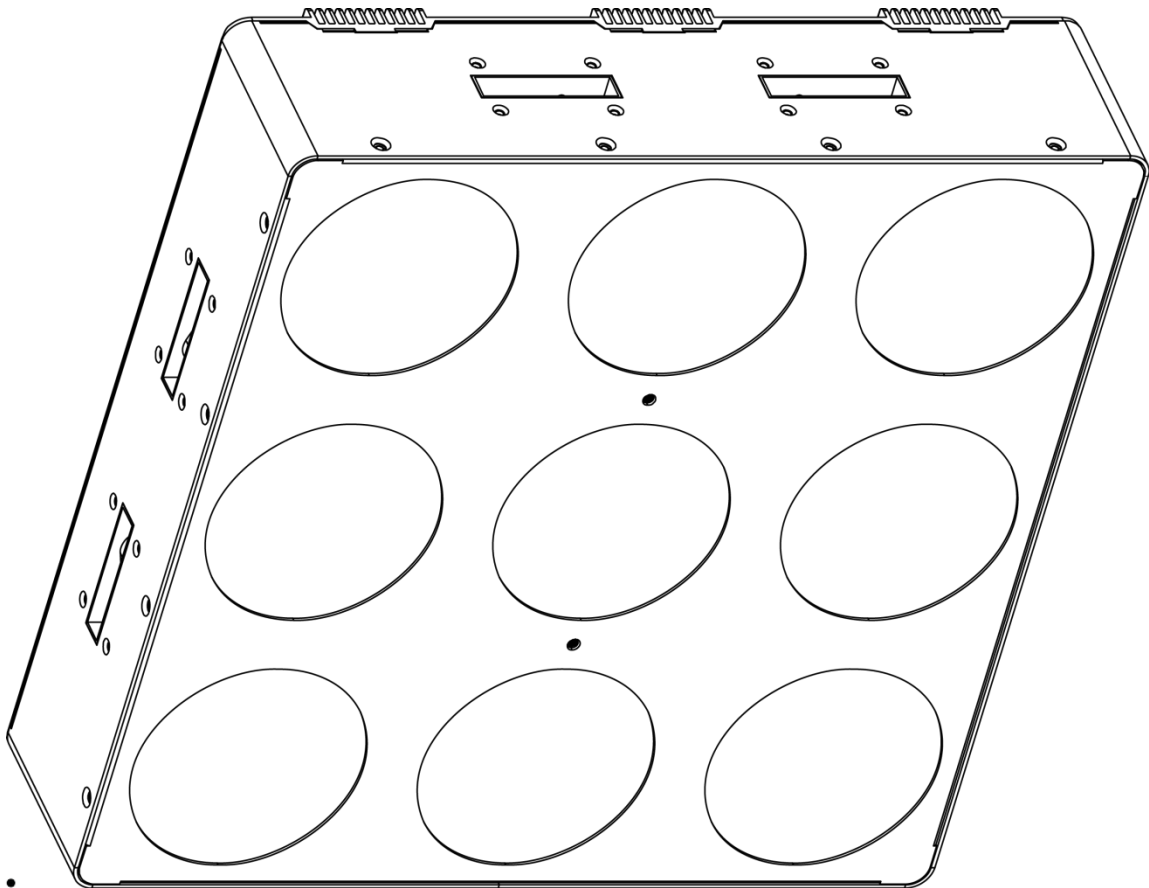

CHAUVET®
It's Green Thinking.™

TABLE OF CONTENTS

1. Before You Begin	3
What Is Included	3
Unpacking Instructions	3
Claims	3
Text Conventions	3
Symbols	3
Disclaimer	3
Product at a Glance	4
Safety Notes	4
2. Introduction	5
Overview	5
Dimensions	6
3. Setup	7
AC Power	7
Fuse Replacement	7
Power Linking	8
Mounting	9
Orientation	9
Rigging	9
Coffin Locks	10
4. Operation	11
Control Panel Operation	11
Menu Map	11
Configuration (DMX)	12
Starting Address	12
CORE™ 3x3 Sections for DMX Control	12
DMX Channel Modes, Assignments, and Values	13
31-Channel	13
DMX Channel Modes, Assignments, and Values (cont.)	14
27-Channel	14
DMX Channel Modes, Assignments, and Values (cont.)	15
9-Channel	15
DMX Channel Modes, Assignments, and Values (cont.)	16
5-Channel	16
3-Channel	16
Configuration (Standalone)	17
Sound-Active Mode	17
Sound Sensitivity	17
Auto Program	17
Program Speed	17
Static Colors	18
Custom Color Mixing	18
Dimmer	18
Fan Settings	18
Master/Slave Mode	19
Two-by-Two (2 x 2) Master/Slave Mode	20
5. Technical Information	21
Product Maintenance	21
6. Technical Specifications	22
Returns	23
Contact Us	24

1. BEFORE YOU BEGIN

What Is Included

- CORE™ 3x3
- 5 mm Allen Key
- Hanging Bracket with Mounting Hardware
- Power Cord
- Warranty Card
- Quick Reference Guide

Unpacking Instructions

Carefully unpack the product immediately and check the container to make sure all the parts are in the package and are in good condition.

Claims



If the box or the contents (the product and included accessories) appear damaged from shipping, or show signs of mishandling, notify the carrier immediately, not CHAUVET®. Failure to report damage to the carrier immediately may invalidate your claim. In addition, keep the box and contents for inspection.

For other issues, such as missing components or parts, damage not related to shipping, or concealed damage, file a claim with CHAUVET® within 7 days of delivery.

Text Conventions

Convention	Meaning
1–512	A range of values
50/60	A set of values of which only one can be chosen
Settings	A menu option not to be modified
Menu > Settings	A sequence of menu options to be followed
<ENTER>	A key to be pressed on the product's control panel
ON	A value to be entered or selected

Symbols

Symbol	Meaning
	Critical installation, configuration, or operation information. Not following these instructions may make the product not work, cause damage to the product, or cause harm to the operator.
	Important installation or configuration information. The product may not function correctly if this information is not used.
	Useful information.

Disclaimer

The information and specifications contained in this User Manual are subject to change without notice. CHAUVET® assumes no responsibility or liability for any errors or omissions, and reserves the right to revise or recreate this manual at any time. Download the latest version from www.chauvetlighting.com.

© Copyright 2014 CHAUVET®. All rights reserved.

Electronically published by CHAUVET® in the United States of America.

Author	Date	Editor	Date
A. Leon	08/06/14	M. Trouard	08/06/14

Product at a Glance

Use on Dimmer	X	Auto Programs	P
Outdoor Use	X	Auto-ranging Power Supply	P
Sound-Activated	P	Replaceable Fuse	P
DMX	P	User-Serviceable	X
Master/Slave	P		

Safety Notes

These notes include important information about the mounting, usage, and maintenance of this product; read before using the product.



- Always connect the product to a grounded circuit to avoid the risk of electrocution.
- Always disconnect the product from the power source before cleaning or replacing the fuse.
- Avoid direct eye exposure to the light source while the product is on.
- Make sure the power cord is not crimped or damaged.
- Never disconnect the product from power by pulling or tugging on the cord.
- If mounting the product overhead, always secure to a fastening device using a safety cable.
- Make sure there are no flammable materials close to the product when operating.
- Do not touch the product's housing when operating because it may be very hot.



- Always make sure that the voltage of the outlet to which you are connecting the product is within the range stated on the decal or rear panel of the product.
- The product is for indoor use only! (IP20) To prevent risk of fire or shock, do not expose the product to rain or moisture.
- Always install the product in a location with adequate ventilation, at least 20 in (50 cm) from adjacent surfaces.
- Be sure that no ventilation slots on the product's housing are blocked.
- Never connect the product to a dimmer.
- Make sure to replace the fuse with another of the same type and rating.
- Never carry the product from the power cord or any moving part. Always use the hanging/mounting bracket.
- The maximum ambient temperature (Ta) is 104 °F (40 °C). Do not operate the product at higher temperatures.
- In the event of a serious operating problem, stop using the product immediately.
- Never try to repair the product. Repairs carried out by unskilled people can lead to damage or malfunction. Contact the nearest authorized technical assistance center.
- This product is not intended for permanent installation.



- Keep this User Manual for future use. If you sell the product to another user, be sure to give this document to the next owner.

2. INTRODUCTION

Overview

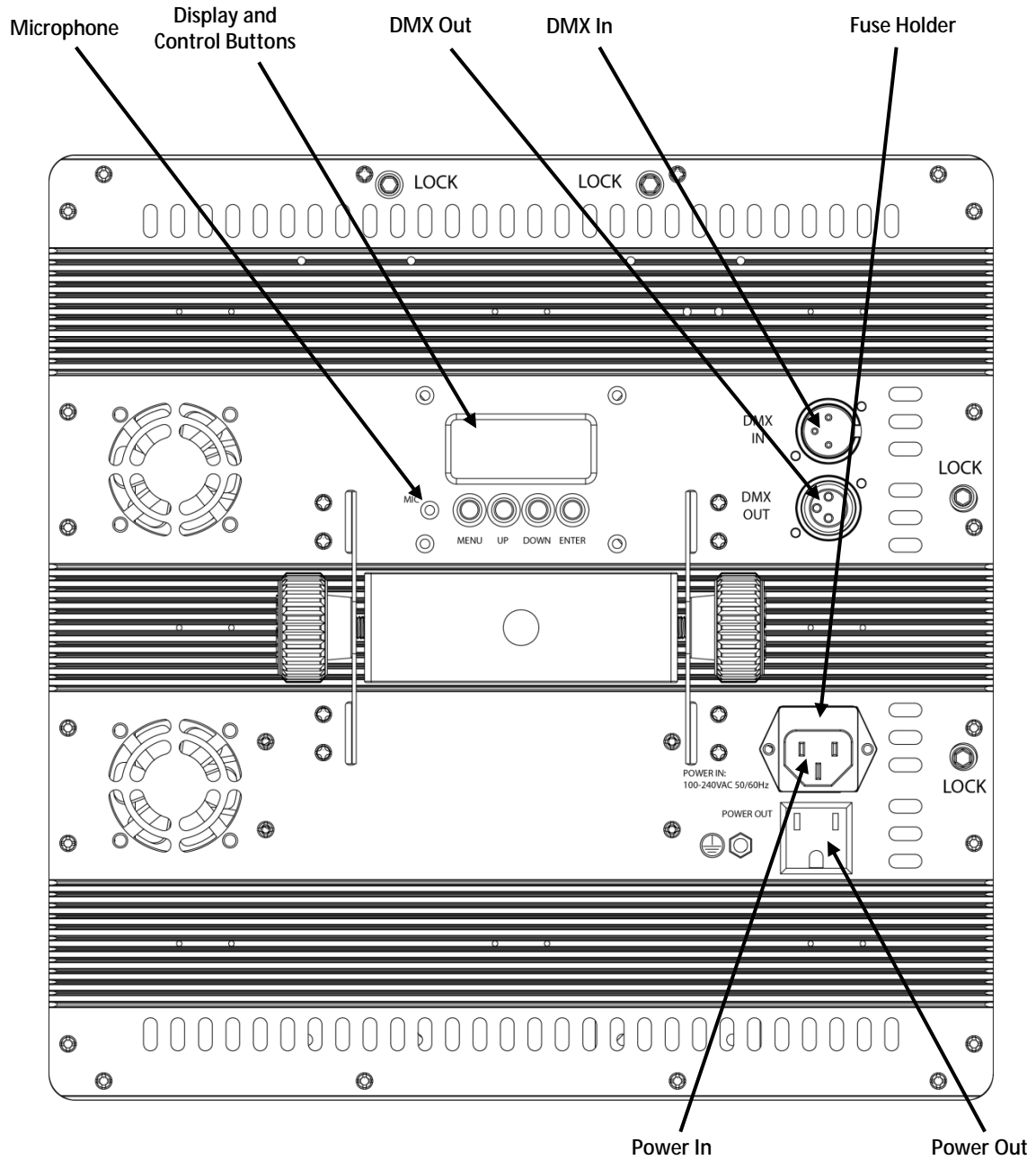

Back Panel View

Dimensions

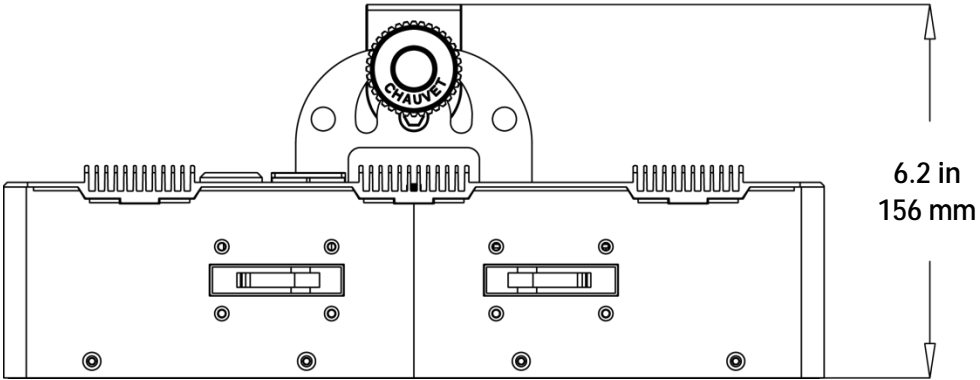
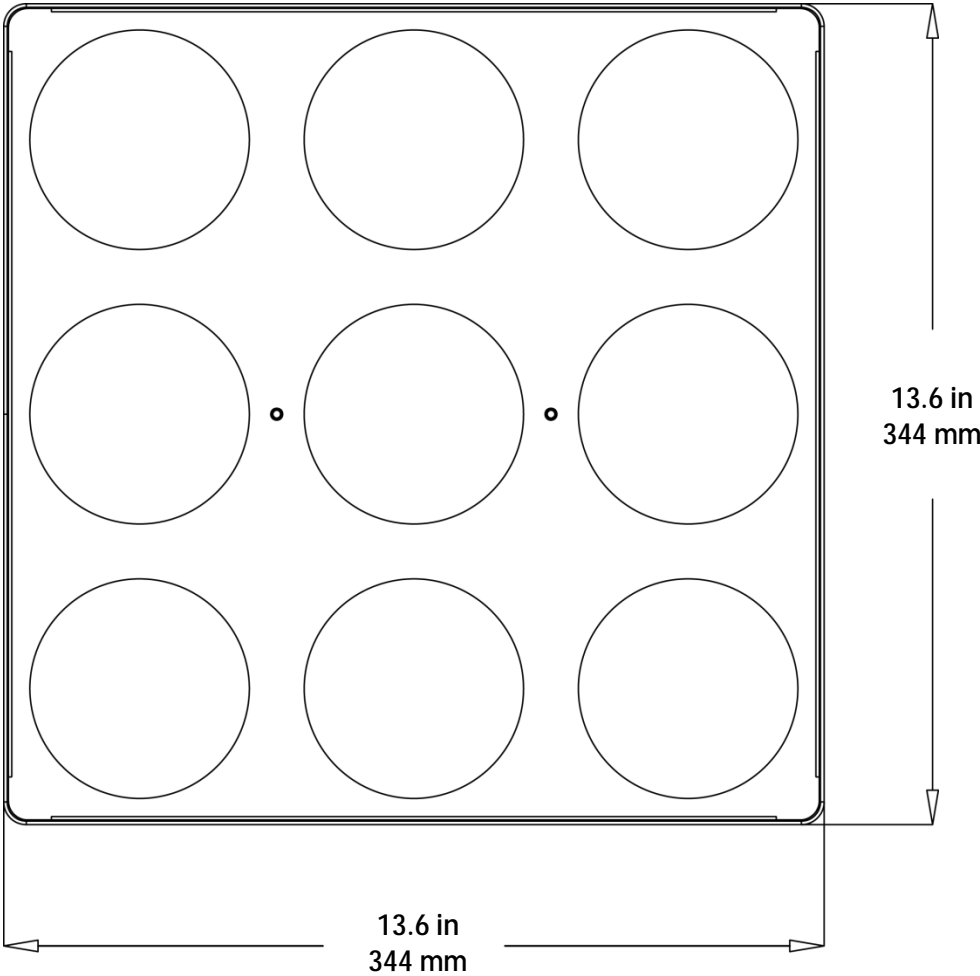

3. SETUP

AC Power The CORE™ 3x3 has an auto-ranging power supply and it can work with an input voltage range of 100 to 240 VAC, 50/60 Hz.

To determine the product's power requirements (circuit breaker, power outlet, and wiring), use the current value listed on the label affixed to the product's back panel, or refer to the product's specifications chart. The listed current rating indicates the product's average current draw under normal conditions.



Always connect the product to a protected circuit (circuit breaker or fuse). Make sure the product has an appropriate electrical ground to avoid the risk of electrocution or fire.



Never connect the product to a rheostat (variable resistor) or dimmer circuit, even if the rheostat or dimmer channel serves only as a 0–100% switch.

Fuse Replacement

1. Disconnect the product from power.
2. Wedge the tip of a flat-head screwdriver into the slot of the fuse holder.
3. Pry the fuse holder out of the housing.
4. Remove the blown fuse from the holder.
5. Replace with a fuse of the exact same type and rating.
6. Insert the fuse holder back in place and reconnect power.



Disconnect the product from power before replacing the fuse.

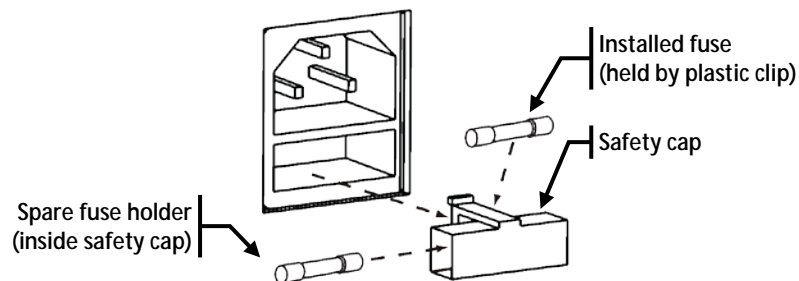

A spare fuse is not included; however, the safety cap has room for a spare.



Always replace a blown fuse with another of the same type and rating.

Power Linking The product provides power linking via the Edison/IEC outlet located in the back of the unit.

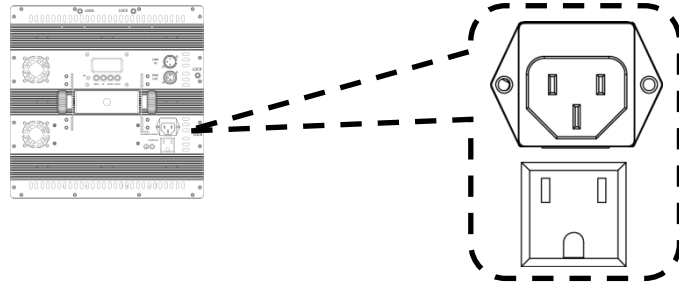

Power Linking Diagram

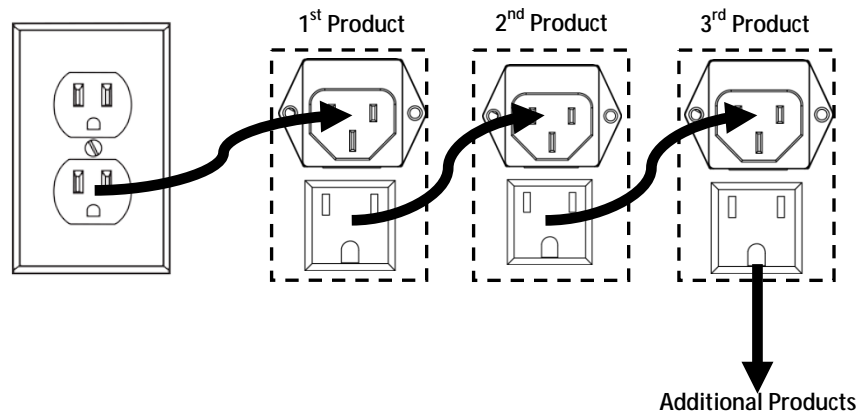

You can power link up to 3 CORE™ 3x3 units on 120 VAC or up to 7 CORE™ 3x3 units on 230 VAC.



The power linking diagram shown above corresponds to the North American version of the product ONLY! If using the product in other markets, you must consult with the local CHAUVET® distributor as power linking connectors and requirements may differ in your country or region.

Mounting Before mounting the product, read and follow the safety recommendations indicated in the Safety Notes.

Orientation The CORE™ 3x3 may be mounted in any position; however, make sure adequate ventilation is provided around the product.

- Rigging**
- Before deciding on a location, always make sure there is easy access to the product for maintenance and programming.
 - Make sure that the structure or surface onto which you are mounting the product can support the product's weight (see the [Technical Specifications](#)).
 - When mounting the product overhead, always use a safety cable. Mount the product securely to a rigging point, such as an elevated platform or a truss.
 - When rigging the product onto a truss, you should use a mounting clamp of appropriate weight capacity. The bracket has a 13 mm hole, which is appropriate for this purpose.
 - When power linking multiple products, you must always consider the length of the power linking cable and mount the products close enough for the cable to reach.
 - The bracket adjustment knobs allow for directional adjustment when aiming the product to the desired angle. Only loosen or tighten the bracket knobs manually. Using tools could damage the knobs.
 - When mounting the product on the floor, make sure that the product and cables are away from people and vehicles.

Mounting Diagram

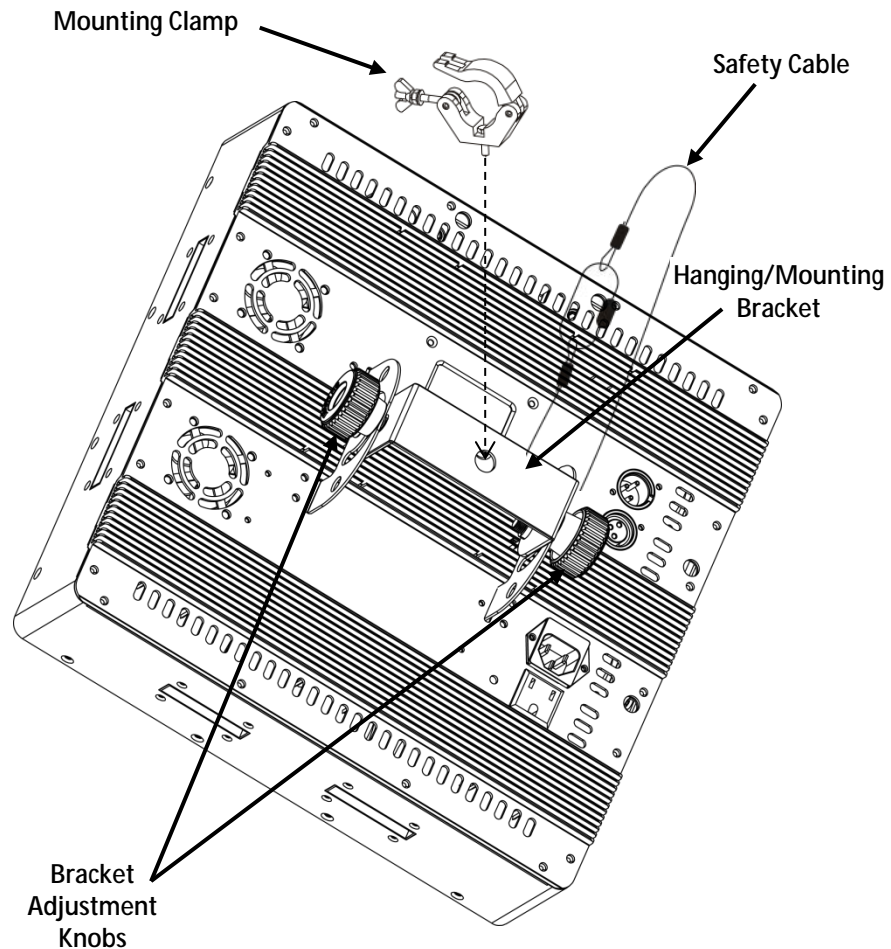

Coffin Locks The CORE™ 3x3 may be attached to another CORE™ 3x3 by using their coffin locks. The coffin locks are for product alignment only and are not weight bearing. **DO NOT** hang product using only the coffin locks.

1. Place one CORE™ 3x3 next to the other, making sure to align the coffin lock's male connector opening to the other product's female connector opening.
2. Use the 5 mm Allen key to operate the locking mechanism. Once locked, the coffin lock hooks hold the CORE™ 3x3 units together.

Note: To unlock the coffin locks, using the Allen key again, simply turn the key in the opposite direction from how it was locked.



When attaching CORE™ 3x3 products together using their coffin locks, be sure each unit is independently mounted.

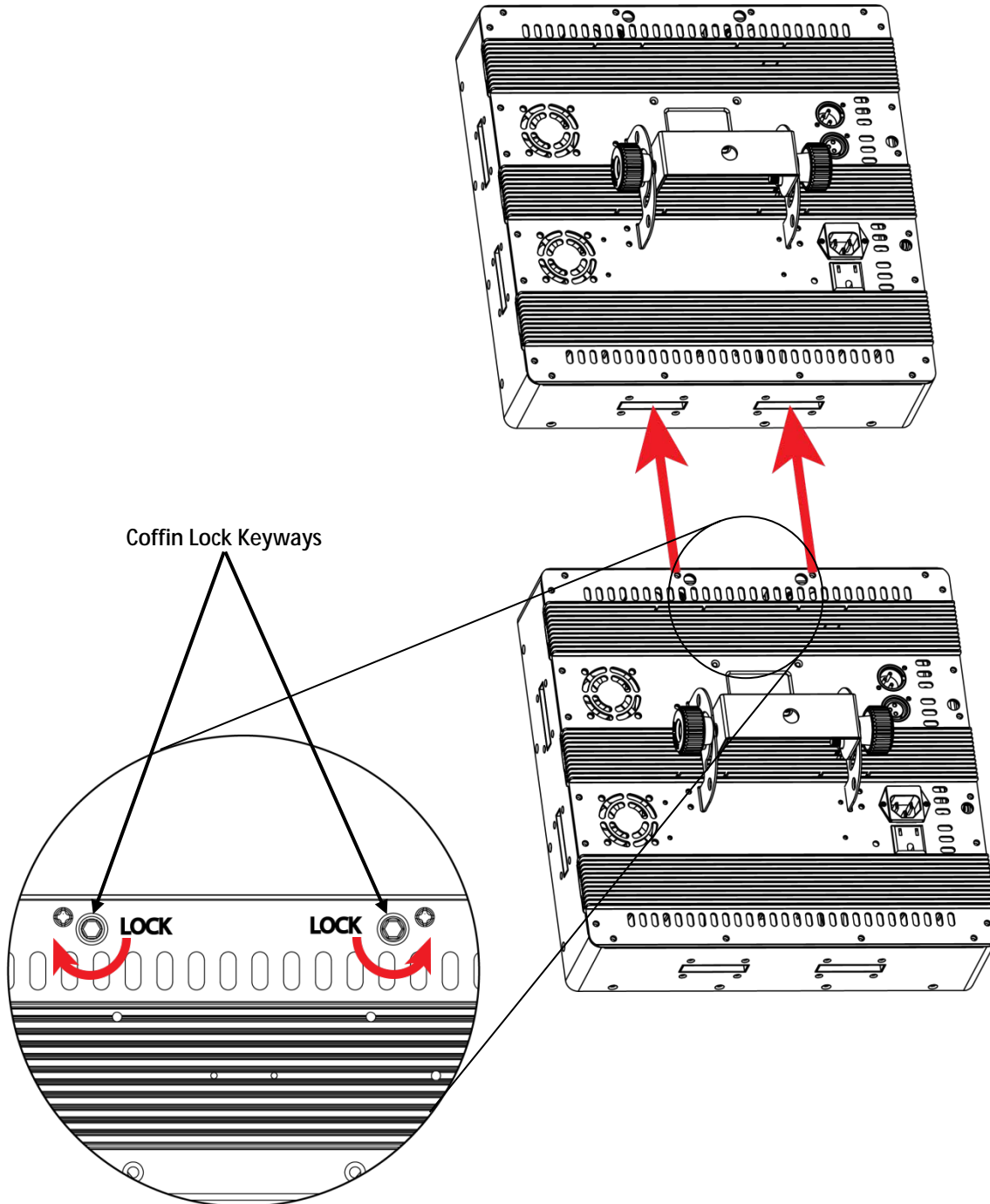

4. OPERATION

Control Panel Operation

To access the control panel functions, use the four buttons located underneath the display.

Button	Function
<MENU>	Selects an operation mode or to backs out of the current menu option
<UP>	Scrolls up the list of options or selects a higher value
<DOWN>	Scrolls down the list of options or selects a lower value
<ENTER>	Activates a menu option or a selected value

Menu Map

Main Level	Programming Levels		Description
DMX Personalities and Starting Address	3-CH	d 1–d512	Selects DMX personality and starting address
	5-CH		
	9-CH		
	27CH		
	31CH		
Static Colors	C--	r	Red
		g	Green
		b	Blue
		gb	Cyan
		r b	Magenta
		rg	Yellow
		rgb	White
Auto Program	P--	P 1–P 6	Auto programs
Program Speed	S--	S 1–S100	Selects auto program speed (slow to fast)
Sound-Active Mode	Snd		Sound-Active mode
Sound Sensitivity	SEnS	u 0–u100	Sound sensitivity control
Custom Color Mixing	U--	r 0–r255	Red (0–100%)
		g 0–g255	Green (0–100%)
		b 0–b255	Blue (0–100%)
Dimmer	dIM	OFF	Dimmer speed off
		dIM1	Dimmer, fast speed
		dIM2	Dimmer, medium speed
		dIM3	Dimmer, slow speed
Fan Settings	FAN	AUTO	Fan automatically turns on
		HIGH	Fan always on
Master Modes	SEnd	SEd1	Mode 1 (see Master/Slave Mode)
		SEd4	Mode 4 (see Two-by-Two Master/Slave Mode)
Slave Modes	SLA	SLA1–SLA4	Slave modes 1–4

Configuration (DMX)

Set the product in DMX mode to control with a DMX controller.

1. Connect the product to a suitable power outlet.
2. Turn the product on.
3. Connect a DMX cable from the DMX output of the DMX controller to the DMX input socket on the product.

Starting Address

When selecting a starting DMX address, always consider the number of DMX channels the selected DMX mode uses. If you choose a starting address that is too high, you could restrict the access to some of the product's channels.

The CORE™ 3x3 uses up to 31 DMX channels in its 31-channel DMX mode, which defines the highest configurable address to **482**.

If unfamiliar with DMX or DIP switches, download the DMX Primer from www.chauvetlighting.com.

To select the starting address, do the following:

1. Press **<MENU>** repeatedly until **3-CH**, **5-CH**, **9-CH**, **27CH**, or **31CH** shows on the display.
2. Press **<ENTER>** to activate the selected DMX personality and **d 1-d512** shows on the display.
3. Use **<UP>** or **<DOWN>** to select the starting address.
4. Press **<ENTER>**.

CORE™ 3x3 Sections for DMX Control

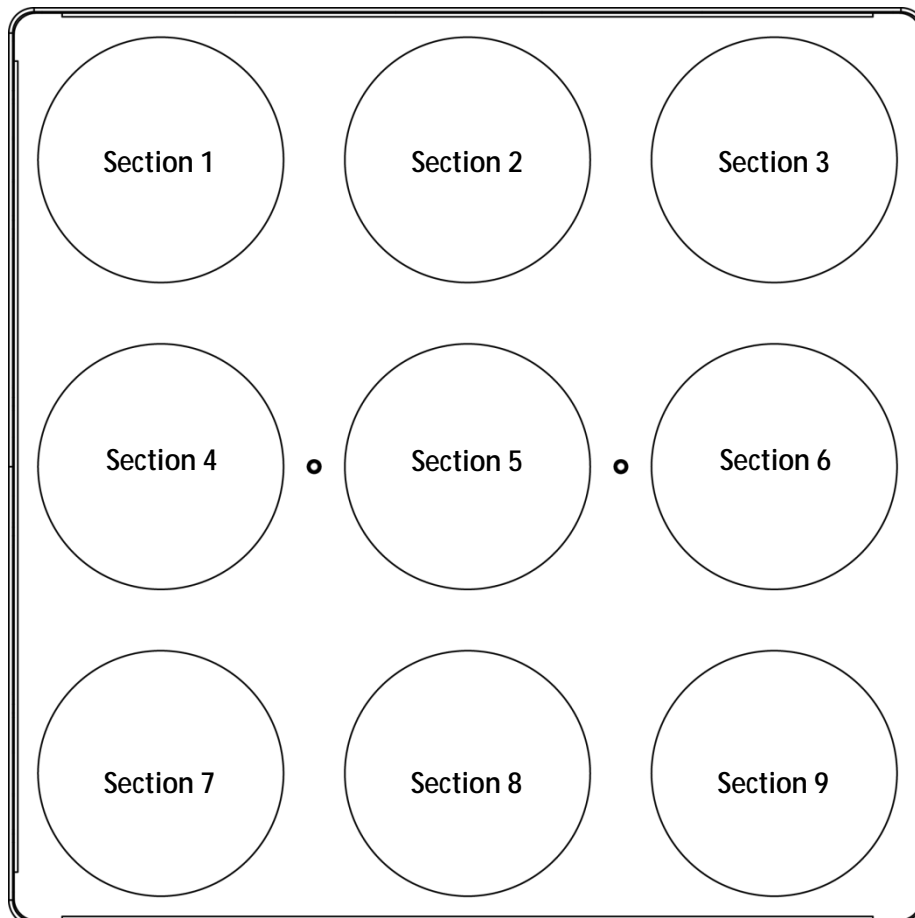

DMX Channel Modes, Assignments, and Values

31-Channel	Channel	Function	Value	Setting
	1	Red	000 ó 255	0-100%
	2	Green	000 ó 255	0-100%
	3	Blue	000 ó 255	0-100%
	4	Red	000 ó 255	0-100%
	5	Green	000 ó 255	0-100%
	6	Blue	000 ó 255	0-100%
	7	Red	000 ó 255	0-100%
	8	Green	000 ó 255	0-100%
	9	Blue	000 ó 255	0-100%
	10	Red	000 ó 255	0-100%
	11	Green	000 ó 255	0-100%
	12	Blue	000 ó 255	0-100%
	13	Red	000 ó 255	0-100%
	14	Green	000 ó 255	0-100%
	15	Blue	000 ó 255	0-100%
	16	Red	000 ó 255	0-100%
	17	Green	000 ó 255	0-100%
	18	Blue	000 ó 255	0-100%
	19	Red	000 ó 255	0-100%
	20	Green	000 ó 255	0-100%
	21	Blue	000 ó 255	0-100%
	22	Red	000 ó 255	0-100%
	23	Green	000 ó 255	0-100%
	24	Blue	000 ó 255	0-100%
	25	Red	000 ó 255	0-100%
	26	Green	000 ó 255	0-100%
	27	Blue	000 ó 255	0-100%
	28	Auto Programs	000 ó 010	No function
011 ó 040			Chase 1	
041 ó 080			Chase 2	
081 ó 120			Chase 3	
121 ó 160			Chase 4	
161 ó 200			Chase 5	
201 ó 240			Chase 6 (run Chases 1-4)	
241 ó 255			Sound-Active mode	
29	Speed	000 ó 255	Auto programs speed (slow to fast)	
30	Dimmer	000 ó 255	0-100%	
31	Shutter	000 ó 010	No function	
		011 ó 255	Strobe (slow to fast)	

DMX Channel Modes, Assignments, and Values (cont.)

27-Channel	Channel	Function	Value	Setting
	1	Red	000 ó 255	0-100%
	2	Green	000 ó 255	0-100%
	3	Blue	000 ó 255	0-100%
	4	Red	000 ó 255	0-100%
	5	Green	000 ó 255	0-100%
	6	Blue	000 ó 255	0-100%
	7	Red	000 ó 255	0-100%
	8	Green	000 ó 255	0-100%
	9	Blue	000 ó 255	0-100%
	10	Red	000 ó 255	0-100%
	11	Green	000 ó 255	0-100%
	12	Blue	000 ó 255	0-100%
	13	Red	000 ó 255	0-100%
	14	Green	000 ó 255	0-100%
	15	Blue	000 ó 255	0-100%
	16	Red	000 ó 255	0-100%
	17	Green	000 ó 255	0-100%
	18	Blue	000 ó 255	0-100%
	19	Red	000 ó 255	0-100%
	20	Green	000 ó 255	0-100%
	21	Blue	000 ó 255	0-100%
	22	Red	000 ó 255	0-100%
	23	Green	000 ó 255	0-100%
	24	Blue	000 ó 255	0-100%
	25	Red	000 ó 255	0-100%
	26	Green	000 ó 255	0-100%
	27	Blue	000 ó 255	0-100%

DMX Channel Modes, Assignments, and Values (cont.)

9-Channel	Channel	Function	Value	Setting
	1	Dimmer	000 ó 255	0–100%
	2	Red	000 ó 255	0–100%
	3	Green	000 ó 255	0–100%
	4	Blue	000 ó 255	0–100%
	5	Shutter	000 ó 010	No function
			011 ó 255	Strobe (slow to fast)
	6	Custom Color and Color Temperature	000 ó 010	No function
			011 ó 030	Red 100% + Green 0–100%
			031 ó 050	Red 100%–0 + Green 100%
			051 ó 070	Green 100% + Blue 0–100%
			071 ó 090	Green 100%–0 + Blue 100%
			091 ó 110	Red 0–100% + Blue 100%
			111 ó 130	Red 100% + Blue 100%–0
			131 ó 150	Red 100% + Green 0–100% + Blue 0–100%
			151 ó 170	Red 100%–0 + Green 100%–0 + Blue 100%
			171 ó 200	Red 100% + Green 100% + Blue 100%
			201 ó 205	Color temperature 1
			206 ó 210	Color temperature 2
			211 ó 215	Color temperature 3
			216 ó 220	Color temperature 4
			221 ó 225	Color temperature 5
			226 ó 230	Color temperature 6
			231 ó 235	Color temperature 7
	236 ó 240	Color temperature 8		
	241 ó 245	Color temperature 9		
	246 ó 250	Color temperature 10		
	251 ó 255	Color temperature 11		
	7	Auto Programs	000 ó 010	No function
			011 ó 040	Chase 1
			041 ó 080	Chase 2
			081 ó 120	Chase 3
			121 ó 160	Chase 4
			161 ó 200	Chase 5
			201 ó 240	Chase 6 (run Chases 1–4)
			241 ó 255	Sound-Active mode
	8	Speed	000 ó 255	Auto programs speed (slow to fast)
	9	Dimmer Mode	000 ó 051	Dimmer mode manually set in Menu Options
			052 ó 101	Dimmer mode off
			102 ó 152	Dimmer mode 1 (fast speed)
			153 ó 203	Dimmer mode 2 (middle speed)
			204 ó 255	Dimmer mode 3 (slow speed)

DMX Channel Modes, Assignments, and Values (cont.)

5-Channel	Channel	Function	Value	Setting
	1	Dimmer	000 ó 255	0–100%
	2	Red	000 ó 255	0–100%
	3	Green	000 ó 255	0–100%
	4	Blue	000 ó 255	0–100%
	5	Shutter	000 ó 010	No function
			011 ó 255	Strobe (slow to fast)

3-Channel	Channel	Function	Value	Setting
	1	Red	000 ó 255	0–100%
	2	Green	000 ó 255	0–100%
	3	Blue	000 ó 255	0–100%

Configuration (Standalone)

Set the product in one of the standalone modes to control without a DMX controller.

1. Connect the product to power.
2. Turn the product on.



Never connect a product that is operating in any standalone mode (either Static, Automatic, or Sound) to a DMX string connected to a DMX controller. Products in standalone mode may transmit DMX signals that could interfere with the DMX signals from the controller.

Sound-Active Mode

To enable the Sound-Active mode, do the following:

1. Press **<MENU>** repeatedly until **Snd** shows on the display.
2. Press **<ENTER>**.

Sound Sensitivity

To set the sound sensitivity, follow the instructions below:

1. Press **<MENU>** repeatedly until **SEnS** shows on the display.
2. Use **<UP>** or **<DOWN>** to select the desired sound sensitivity (**u 0–u100**).
3. Press **<ENTER>**.



The product will only respond to low frequencies of music (bass and drums).

Auto Program

To select an auto program, do the following:

1. Press **<MENU>** repeatedly until **P--** shows on the display.
2. Press **<ENTER>** and **P 1–P 6** shows on the display.
3. Use **<UP>** or **<DOWN>** to select the desired auto program.
4. Press **<ENTER>**.

Program Speed

To set the auto program speed, follow the instructions below:

1. Press **<MENU>** repeatedly until **S--** shows on the display.
2. Use **<UP>** or **<DOWN>** to select the desired auto program speed (**S 1–S100**, slow to fast).
3. Press **<ENTER>**.

-
- Static Colors** To select a static color, do the following:
1. Press **<MENU>** repeatedly until **C--** shows on the display.
 2. Press **<ENTER>**.
 3. Use **<UP>** or **<DOWN>** to select the desired preset color:
 - **r** (red)
 - **g** (green)
 - **b** (blue)
 - **gb** (cyan)
 - **r b** (magenta)
 - **rg** (yellow)
 - **rgb** (white)
 4. Press **<ENTER>**.

- Custom Color Mixing** To custom mix a color, follow the instructions below:
1. Press **<MENU>** repeatedly until **U--** shows on the display.
 2. Press **<ENTER>** and one of the following colors shows on the display: **rXXX** (red), **gXXX** (green), or **bXXX** (blue).
 3. Press **<ENTER>** repeatedly to select the desired color.
 4. Use **<UP>** or **<DOWN>** to select the desired color value (**0–100**).
NOTE: Selecting **0** will turn the color off.
 5. Press **<ENTER>** to select color value and continue to the next color.
 6. Repeat steps 3 to 5 until you create your desired color.

- Dimmer** To select a dimmer mode, do the following:
1. Press **<MENU>** repeatedly until **dIM** shows on the display.
 2. Press **<ENTER>** and one of the following shows on the display:
 - **OFF** (dimmer speed off)
 - **dIM1** (dimmer, fast speed)
 - **dIM2** (dimmer, medium speed)
 - **dIM3** (dimmer, slow speed)
 3. Use **<UP>** or **<DOWN>** to select the desired dimmer mode.
 4. Press **<ENTER>**.

- Fan Settings** To select a fan setting, follow the instructions below:
1. Press **<MENU>** repeatedly until **FAN** shows on the display.
 2. Press **<ENTER>** and either **AUTO** (fan automatically turns on) or **HIGH** (fan always on) shows on the display.
 3. Use **<UP>** or **<DOWN>** to select the desired fan setting.
 4. Press **<ENTER>**.

Master/Slave Mode

The Master/Slave mode allows a single CORE™ 3x3 unit (the master) to control the actions of one or more CORE™ 3x3 units (the slaves) without the need of a DMX controller. The master unit will be set to operate in Master mode 1 (and in either an Auto program or Sound-Active mode), while the slave units will be set to operate in Slave mode 1. Once set and connected, the slave units will operate in unison with the master unit, each slave duplicating the master exactly.

Configure the units as indicated below.

Slave units:

1. Press **<MENU>** on the slave units until **SLA** shows on the display.
2. Press **<ENTER>** and **SLA1–SLA4** shows on the display.
3. Use **<UP>** or **<DOWN>** to select **SLA1** (Slave mode 1).
4. Press **<ENTER>**.
5. Connect the DMX input of the subsequent slave units to the DMX output of the previous slave unit.

Master unit:

1. Press **<MENU>** on the master unit until **SEnd** shows on the display.
2. Press **<ENTER>** and either **SEd1** or **SEd4** shows on the display.
3. Use **<UP>** or **<DOWN>** to select **SEd1** (Master mode 1).
4. Press **<ENTER>**.
5. Set the master unit to operate in either Auto program or Sound-Active mode.
6. Make the master unit the first unit in the DMX daisy chain.

- **Configure all the slave units before connecting the master unit to the DMX daisy chain.**



- **Never connect a DMX controller to a DMX string configured for Master/Slave operation because the controller may interfere with the signals from the master unit.**
- **Do not connect more than 31 slave units to the master unit.**

**Two-by-Two
(2 x 2)
Master/Slave
Mode**

The Two-by-Two (2 x 2) Master/Slave mode allows a single CORE™ 3x3 unit (the master) to control the actions of 3 other CORE™ 3x3 units (the slaves) as if they were one unit, when positioned 2 units across by 2 units down. The master unit will be set to operate in Master mode 4 (and in either an Auto program or Sound-Active mode), while the slave units will be set to operate in Slave modes 2 through 4. Once set and connected, the four units will operate as one.

Configure the units as indicated below.

Slave units:

1. Press <MENU> on the slave units until **SLA** shows on the display.
2. Press <ENTER> and **SLA1–SLA4** shows on the display.
3. Use <UP> or <DOWN> to select **SLA2** for the slave next to the master, **SLA3** for the slave diagonal to the master, and **SLA4** for the slave underneath the master.
4. Press <ENTER> on the slave units.
5. Connect the DMX input of the subsequent slave units to the DMX output of the previous slave unit.

Master unit:

1. Press <MENU> on the master unit until **SEnd** shows on the display.
2. Press <ENTER> and either **SEd1** or **SEd4** shows on the display.
3. Use <UP> or <DOWN> to select **SEd4** (Master mode 4).
4. Press <ENTER>.
5. Set the master unit to operate in either Auto program or Sound-Active mode.
6. Make the master unit the first unit in the DMX daisy chain.

**Placement of Units
for Two-by-Two
Master/Slave Mode**

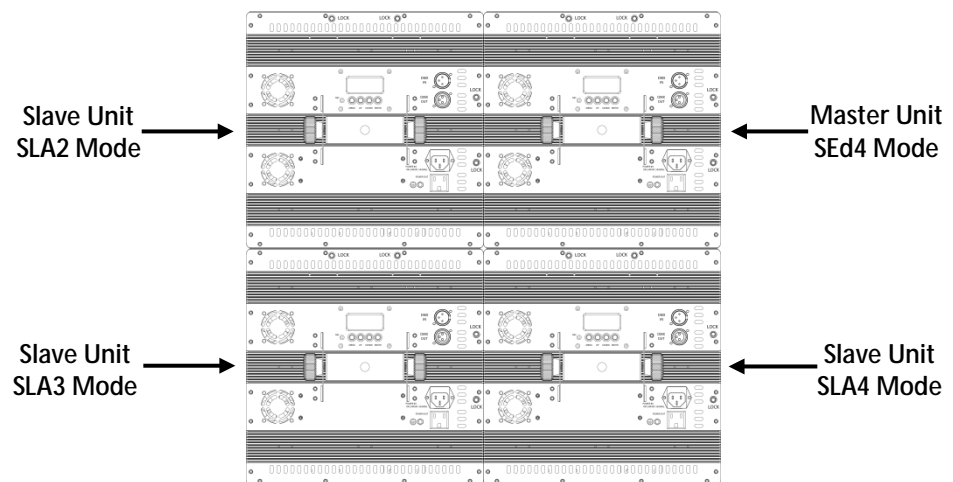

Back Panel View



The SEd4 setting in the master unit is for the two-by-two grid layout only. With this two-by-two configuration, be sure to place the slave units in the positions shown to ensure all 4 units generate a properly coordinated show.

**Additional
Two-by-Two
Configurations**

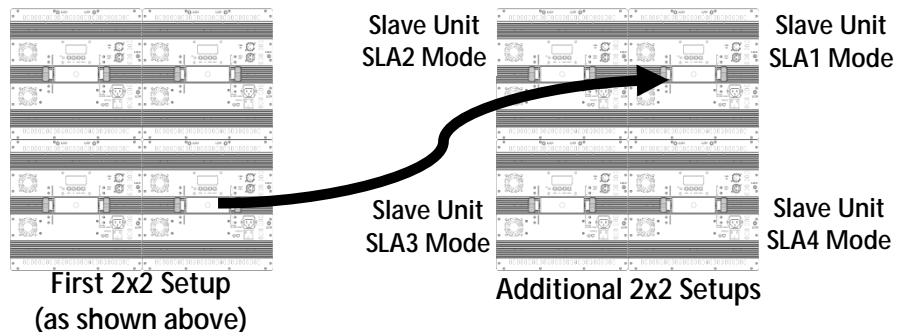

5. TECHNICAL INFORMATION

Product Maintenance

Dust build-up reduces light output performance and can cause overheating. This can lead to reduction of the light source's life and mechanical wear. To maintain optimum performance and minimize wear, clean the product at least twice a month. However, usage and environmental conditions contribute to increased cleaning frequency.

To clean the product, follow the instructions below.

1. Unplug the product from power.
2. Wait until the product is at room temperature.
3. Use a vacuum (or dry compressed air) and a soft brush to remove dust collected on the external surface/vents and reachable internal components.
4. Clean all external optics and glass/transparent surfaces with a mild soap solution, ammonia-free glass cleaner, or isopropyl alcohol.
5. Apply the solution directly to a soft, lint-free cotton cloth or a lens cleaning tissue.
6. Softly wipe any dirt or grime to the outside edges of the external optics or glass/transparent surfaces.
7. Gently polish the external optics and glass/transparent surfaces until they are free of haze and lint.



Always dry the external optics and glass/transparent surfaces carefully after cleaning them.



Do not spin the cooling fans using compressed air because you could damage them.

6. TECHNICAL SPECIFICATIONS

Dimensions and Weight	Length	Width	Height	Weight
	6.2 in (156 mm)	13.6 in (344 mm)	13.6 in (344 mm)	13.6 lb (6.2 kg)
Note: Dimensions in inches rounded to the nearest decimal digit.				
Power	Power Supply Type	Range	Voltage Selection	
	Switching (internal)	100 to 240 V, 50/60 Hz	Auto-ranging	
	Parameter	120 V, 60 Hz	230 V, 50 Hz	
	Consumption	226 W	226 W	
	Operating current	1.9 A	0.9 A	
Power I/O	Power I/O	US/Worldwide	UK/Europe	
	Power input connector	IEC	IEC	
	Power output connector	Edison	IEC	
	Power Cord plug	Edison (US)	Local plug	
	Power linking current (units)	8 A (3 units)	8 A (7 units)	
	Fuse	T 3.15 A, 250 V	T 3.15 A, 250 V	
Light Source	Type	Power	Lifespan	
	LED	9 W	50,000 hours	
	Color	Quantity	Current	
	Tri-color (RGB)	9	1.5 A	
Photo Optic	Parameter			
	Illuminance @ 2 m	1,025 lux		
	Beam angle	47°		
	Field angle	73°		
	Strobe rate	0 to 20 Hz		
Thermal	Maximum External Temp.	Cooling System		
	104 °F (40 °C)	Fan-cooled		
DMX	I/O Connectors	Connector Type	Channel Range	
	3-pin XLR	Sockets	3, 5, 9, 27 or 31	
Ordering	Product Name	Item Code	UPC Number	
	CORE™ 3x3	03030688	781462210366	

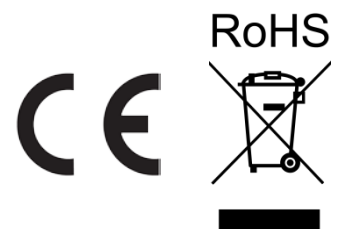

RETURNS

To return a product or request support:

- In the U.S., contact CHAUVET® World Headquarters (see [Contact Us](#)).
- In the UK or Ireland, contact CHAUVET® Europe Ltd. (see [Contact Us](#)).
- In Mexico, contact CHAUVET® Mexico (see [Contact Us](#)).

In any other country, DO NOT contact CHAUVET®. Contact your distributor. See www.chauvetlighting.com for distributors outside the U.S., United Kingdom, Ireland, or Mexico.



If you live outside the U.S., United Kingdom, Ireland, or Mexico, contact your distributor of record and follow their instructions on how to return CHAUVET® products to them. Visit our website for contact details.

Call the corresponding CHAUVET® Technical Support office and request a Return Merchandise Authorization (RMA) number before shipping the product. Be prepared to provide the model number, serial number, and a brief description of the reason for the return.

You must send the merchandise prepaid, in its original box, and with its original packing and accessories. CHAUVET® will not issue call tags.

Clearly label the package with the RMA number. CHAUVET® will refuse any product returned without an RMA number.



Write the RMA number on a properly affixed label. DO NOT write the RMA number directly on the box.

Before sending the product, clearly write the following information on a piece of paper and place it inside the box:

- Your name
- Your address
- Your phone number
- RMA number
- A brief description of the problem

Be sure to pack the product properly. Any shipping damage resulting from inadequate packaging will be your responsibility. FedEx packing or double-boxing are recommended.



CHAUVET® reserves the right to use its own discretion to repair or replace returned product(s).

CONTACT US

WORLD HEADQUARTERS - CHAUVET®

General Information

Address: 5200 NW 108th Avenue
Sunrise, FL 33351
Voice: (954) 577-4455
Fax: (954) 929-5560
Toll free: (800) 762-1084

Technical Support

Voice: (954) 577-4455 (Press 4)
Fax: (954) 756-8015
Email: tech@chauvetlighting.com

World Wide Web www.chauvetlighting.com

UNITED KINGDOM AND IRELAND - CHAUVET® Europe Ltd.

General Information

Address: Unit 1C
Brookhill Road Industrial Estate
Pinxton, Nottingham, UK
NG16 6NT
Voice: +44 (0)1773 511115
Fax: +44 (0)1773 511110

Technical Support

Email: uktech@chauvetlighting.com

World Wide Web www.chauvetlighting.co.uk

MEXICO - CHAUVET® Mexico

General Information

Address: Av. Santa Ana 30
Parque Industrial Lerma
Lerma, Mexico C.P. 52000
Voice: +52 (728) 285-5000

Technical Support

Email: servicio@chauvet.com.mx

World Wide Web www.chauvet.com.mx

Outside the U.S., United Kingdom, Ireland, or Mexico, contact your dealer. Follow their instructions to request support or to return a product. Visit our website for contact details.