

PC3K

Musician's Guide

(includes PC3K6, PC3K7, and PC3K8)

K U R Z W E I L[®]

Kurzweil is a registered trademark of Young Chang Co., Ltd. ©2011 All rights reserved. Young Chang[®], Kurzweil[®], V. A. S. T. [®], PC3K[®], PC3[®], PC3LE[®], KDFX[®], Pitcher[®], LaserVerb[®], KSP8 [™], K2661[™], K2600[™], K2500[™], and K2000[™] are trademarks of Young Chang Co., Ltd. All other products and brand names are trademarks or registered trademarks of their respective companies. Product features and specifications are subject to change without notice.

You may legally print up to two (2) copies of this document for personal use. Commercial use of any copies of this document is prohibited. Young Chang Co. retains ownership of all intellectual property represented by this document.

910523-002 – V2 June 2011

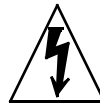
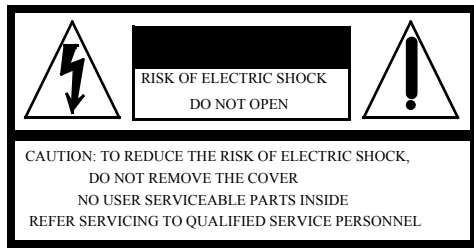

The lightning flash with the arrowhead symbol, within an equilateral triangle, is intended to alert the user to the presence of uninsulated "dangerous voltage" within the product's enclosure that may be of sufficient magnitude to constitute a risk of electric shock to persons.



The exclamation point within an equilateral triangle is intended to alert the user to the presence of important operating and maintenance (servicing) instructions in the literature accompanying the product.

IMPORTANT SAFETY & INSTALLATION INSTRUCTIONS

INSTRUCTIONS PERTAINING TO THE RISK OF FIRE, ELECTRIC SHOCK, OR INJURY TO PERSONS

WARNING: When using electric products, basic precautions should always be followed, including the following:

1. Read all of the Safety and Installation Instructions and Explanation of Graphic Symbols before using the product.
2. This product must be grounded. If it should malfunction or break down, grounding provides a path of least resistance for electric current to reduce the risk of electric shock. This product is equipped with a power supply cord having an equipment-grounding conductor and a grounding plug. The plug must be plugged into an appropriate outlet which is properly installed and grounded in accordance with all local codes and ordinances.
DANGER: Improper connection of the equipment-grounding conductor can result in a risk of electric shock. Do not modify the plug provided with the product - if it will not fit the outlet, have a proper outlet installed by a qualified electrician. Do not use an adaptor which defeats the function of the equipment-grounding conductor. If you are in doubt as to whether the product is properly grounded, check with a qualified serviceman or electrician.
3. **WARNING:** This product is equipped with an AC input voltage selector. The voltage selector has been factory set for the mains supply voltage in the country where this unit was sold. Changing the voltage selector may require the use of a different power supply cord or attachment plug, or both. To reduce the risk of fire or electric shock, refer servicing to qualified maintenance personnel.
4. Do not use this product near water - for example, near a bathtub, washbowl, kitchen sink, in a wet basement, or near a swimming pool, or the like.
5. This product should only be used with a stand or cart that is recommended by the manufacturer.
6. This product, either alone or in combination with an amplifier and speakers or headphones, may be capable of producing sound levels that could cause permanent hearing loss. Do not operate for a long period of time at a high volume level or at a level that is uncomfortable. If you experience any hearing loss or ringing in the ears, you should consult an audiologist.
7. The product should be located so that its location or position does not interfere with its proper ventilation.
8. The product should be located away from heat sources such as radiators, heat registers, or other products that produce heat.
9. The product should be connected to a power supply only of the type described in the operating instructions or as marked on the product.
10. This product may be equipped with a polarized line plug (one blade wider than the other). This is a safety feature. If you are unable to insert the plug into the outlet, contact an electrician to replace your obsolete outlet. Do not defeat the safety purpose of the plug.
11. The power supply cord of the product should be unplugged from the outlet when left unused for a long period of time. When unplugging the power supply cord, do not pull on the cord, but grasp it by the plug.
12. Care should be taken so that objects do not fall and liquids are not spilled into the enclosure through openings.
13. The product should be serviced by qualified service personnel when:
 - A. The power supply cord or the plug has been damaged;
 - B. Objects have fallen, or liquid has been spilled into the product;
 - C. The product has been exposed to rain;
 - D. The product does not appear to be operating normally or exhibits a marked change in performance;
 - E. The product has been dropped, or the enclosure damaged.
14. Do not attempt to service the product beyond that described in the user maintenance instructions. All other servicing should be referred to qualified service personnel.
15. **WARNING:** Do not place objects on the product's power supply cord, or place the product in a position where anyone could trip over, walk on, or roll anything over cords of any type. Do not allow the product to rest on or be installed over cords of any type. Improper installations of this type create the possibility of a fire hazard and/or personal injury.

RADIO AND TELEVISION INTERFERENCE

WARNING: Changes or modifications to this instrument not expressly approved by Young Chang could void your authority to operate the instrument.

IMPORTANT: When connecting this product to accessories and/or other equipment use only high quality shielded cables.

NOTE: This instrument has been tested and found to comply with the limits for a Class B digital device, pursuant to Part 15 of the FCC Rules. These limits are designed to provide reasonable protection against harmful interference in a residential installation. This instrument generates, uses, and can radiate radio frequency energy and, if not installed and used in accordance with the instructions, may cause harmful interference to radio communications. However, there is no guarantee that interference will not occur in a particular installation. If this instrument does cause harmful interference to radio or television reception, which can be determined by turning the instrument off and on, the user is encouraged to try to correct the interference by one or more of the following measures:

- Reorient or relocate the receiving antenna.
- Increase the separation between the instrument and the receiver.
- Connect the instrument into an outlet on a circuit other than the one to which the receiver is connected.
- If necessary consult your dealer or an experienced radio/television technician for additional suggestions.

NOTICE

This apparatus does not exceed the Class B limits for radio noise emissions from digital apparatus set out in the Radio Interference Regulations of the Canadian Department of Communications.

AVIS

Le présent appareil numérique n'émet pas de bruits radioélectriques dépassant les limites applicables aux appareils numériques de la class B prescrites dans le Règlement sur le brouillage radioélectrique édicté par le ministère des Communications du Canada.

SAVE THESE INSTRUCTIONS

Important Safety Instructions

- 1) Read these instructions
- 2) Keep these instructions.
- 3) Heed all warnings.
- 4) Follow all instructions.
- 5) Do not use this apparatus near water.
- 6) Clean only with dry cloth.
- 7) Do not block any of the ventilation openings. Install in accordance with the manufacturer's instructions.
- 8) Do not install near any heat sources such as radiators, heat registers, stoves, or other apparatus (including amplifiers) that produce heat.
- 9) Do not defeat the safety purpose of the polarized or grounding-type plug. A polarized plug has two blades with one wider than the other. A grounding type plug has two blades and a third grounding prong. The wide blade or the third prong are provided for your safety. If the provided plug does not fit into your outlet, consult an electrician for replacement of the obsolete outlet.
- 10) Protect the power cord from being walked on or pinched, particularly at plugs, convenience receptacles, and the point where they exit from the apparatus.
- 11) Only use attachments/accessories specified by the manufacturer.
- 12) Use only with a cart, stand, tripod, bracket, or table specified by the manufacturer, or sold with the apparatus. When a cart is used, use caution when moving the cart/apparatus combination to avoid injury from tip-over.
- 13) Unplug this apparatus during lightning storms or when unused for long periods of time.
- 14) CAUTION: Danger of explosion if battery is incorrectly replaced. Replace only with the same or equivalent type (CR2032).
- 15) Refer all servicing to qualified service personnel. Servicing is required when the apparatus has been damaged in any way, such as power-supply cord or plug is damaged, liquid has been spilled or objects have fallen into the apparatus, the apparatus has been exposed to rain or moisture, does not operate normally, or has been dropped.



Warning- To reduce the risk of fire or electric shock, do not expose this apparatus to rain or moisture. Do not expose this equipment to dripping or splashing and ensure that no objects filled with liquids, such as vases, are placed on the equipment.

To completely disconnect this equipment from the AC Mains, disconnect the power supply cord plug from the AC receptacle.

Kurzweil International Contacts

Contact the Kurzweil office listed below to locate your local Kurzweil representative.

American Music & Sound
22020 Clarendon St, Suite 305
Woodland Hills, CA 91367

Phone: +1 (800) 431-2609
Fax: +1 (818) 597-0411
Email: info@americanmusicandsound.com

Young Chang Co., Ltd.
9th Floor, Bldg 102, I-Park,
Jeongja-Dong, Bundang-Gu, Seongnam-Si, Gyeonggi-Do
463-811 South Korea

Phone: +82 (31) 786-7986~7
Fax: +82 (31) 785-2701

www.ycpiano.co.kr
www.youngchang.com
www.kurzweil.com

TECHNICAL SUPPORT
Email: support@kurzweil.com

Table Of Contents

Kurzweil International Contacts.....	iv
--------------------------------------	----

Chapter 1 Introduction

Keeping Current	1-2
Overview of the PC3K.....	1-2
How the PC3K Works	1-3
VAST Synthesis	1-3
KB3 Tone Wheel Emulation	1-3
VA-1 Programs	1-3
How to Use This Manual.....	1-4
Do I Have Everything?.....	1-4
Boot Loader.....	1-4
Battery.....	1-4
Options.....	1-5
Sound ROM Expansion Card.....	1-5
Pedals.....	1-5
Ribbon Controller	1-5
Breath Controller	1-5
USB Storage Device	1-5

Chapter 2 Startup

Make Connections	2-1
Make Music.....	2-1
Startup—the Details	2-2
Before You Start... ..	2-2
Connecting the Power Cable (Line Cord)	2-2
Connecting Audio Cables.....	2-2
Connecting MIDI	2-3
Pedals.....	2-4
Breath.....	2-4
Ribbon	2-5
Switching On the Power	2-5
USB Storage Port.....	2-6
USB Computer Port.....	2-6
Setting the Clock.....	2-7
PC3K Programs.....	2-7
Selecting Programs.....	2-7
Easy Audition.....	2-7
Program Mode Display	2-8
VAST Programs.....	2-8
KB3 Programs.....	2-9
Setups	2-9
Quick Access.....	2-9
The Other Modes	2-10

Software Upgrades	2-10
-------------------------	------

Chapter 3 User Interface Basics

Mode Selection	3-1
Mode Buttons	3-2
Bank Buttons.....	3-2
Sliders	3-3
Program and Category Buttons.....	3-4
Picking favorites	3-4
Pitch Wheel and Mod Wheel	3-5
Navigation	3-6
The Display.....	3-6
Pages.....	3-6
The Top Line.....	3-6
The Bottom Line.....	3-6
The Soft Buttons.....	3-7
The Cursor Buttons	3-7
The Chan/Layer Buttons.....	3-7
The Edit Button	3-8
The Exit Button	3-8
Data Entry.....	3-9
The Alpha Wheel.....	3-9
The Plus/Minus Buttons	3-9
The Alphanumeric Pad	3-9
Double Button Presses	3-10
Intuitive Data Entry	3-11
Changing the Current Layer in Multi-Layer Programs	3-11
Search.....	3-12
Quick Song Recording and Playback.....	3-12

Chapter 4 The Operating Modes

What the Modes Are	4-1
Selecting Modes	4-1
Finding Square One.....	4-2
Using the Modes	4-2
Program Mode	4-2
Setup Mode.....	4-2
Quick Access Mode	4-3
Effects Mode	4-3
MIDI Mode	4-3
Master Mode	4-3
Song Mode	4-3
Storage Mode	4-3

Chapter 5 Editing Conventions

Introduction to Editing	5-1
What's an Object?.....	5-1
Object Type and ID	5-2

Saving and Naming.....	5-3
ROM Objects	5-4
Memory Objects.....	5-4
Keyboard Naming.....	5-5
Deleting Objects.....	5-6
Dependent Objects	5-6
Saving and Loading Files—Storage Mode.....	5-6
Special Button Functions	5-7

Chapter 6 Program Mode

The Program Mode Page.....	6-1
Selecting Programs.....	6-1
The Soft Buttons in Program Mode	6-2
The Info Box.....	6-2
Controllers Assignments For Factory ROM Programs	6-2
Saving Controller Settings in Program Mode	6-3
The Arpeggiator In Program Mode	6-3
MIDI Channels.....	6-3
VAST and KB3 Programs.....	6-4
VAST Program Structure	6-4
KB3 Program Structure	6-6
KB3 Mode	6-6
KB3 Effects And Real-time Controls.....	6-6
MIDI Control of KB3 Programs.....	6-8
Control Setup.....	6-9
Control Setup Overview.....	6-9
Control Setup Advanced Features	6-10
Selecting And Editing The Control Setup.....	6-10
Editing VAST Programs.....	6-12
The Soft Buttons in the Program Editor	6-12
The MODE Buttons in the Program Editor.....	6-13
Assigning Program Parameters to Control Sources	6-13
The KEYMAP Page.....	6-14
Keymap	6-14
Transpose (Xpose).....	6-14
Key Tracking (KeyTrk).....	6-14
Velocity Tracking (VelTrk).....	6-15
Method (AltMethod).....	6-15
Stereo	6-15
Timbre Shift	6-16
Playback Mode.....	6-16
Alternative Controller (AltControl).....	6-16
Alternative Switch (AltControl and AltMethod).....	6-16
The LAYER Page	6-17
Low Key (LoKey).....	6-18
High Key (HiKey).....	6-18
Low Velocity (LoVel).....	6-18
High Velocity (HiVel).....	6-18
Pitch Bend Mode (Bend).....	6-18
Trigger (Trig)	6-18

Delay Control (DlyCtl).....	6-18
Minimum Delay (MinDly), Maximum Delay (MaxDly)	6-19
Enable	6-19
Enable Sense (S)	6-19
Opaque.....	6-20
Sustain Pedal (SusPdl)	6-20
Sostenuto Pedal (SosPdl)	6-20
Freeze Pedal (FrzPdl)	6-20
Ignore Release (IgnRel).....	6-20
Hold Through Attack (ThrAtt).....	6-21
Hold Until Decay (TilDec).....	6-21
The PITCH Page.....	6-21
The AMP Page.....	6-21
The Algorithm (ALG) Page	6-22
Algorithm Basics.....	6-23
Common DSP Control Parameters	6-24
Alt Input for Algorithms (Cascade Mode).....	6-27
Dynamic VAST.....	6-28
The DSP Control (DSPCTL) Page	6-29
The DSP Modulation (DSPMOD) Page	6-30
The OUTPUT Page	6-31
Pan	6-32
Pan Mode	6-32
Output: Pan, Gain, and Mode.....	6-33
Pan Table	6-33
Crossfade and Crossfade Sense (XFadeSense)	6-33
Drum Remap.....	6-33
Exclusive Zone Map	6-34
The COMMON Page	6-35
Pitch Bend Range Up and Down.....	6-35
Monophonic	6-35
Legato Play	6-36
Portamento	6-36
Portamento Rate.....	6-36
Attack Portamento.....	6-36
Mono Sample XFade	6-37
Globals.....	6-37
Output: Gain, Pan, and Pan Mode	6-37
Demo Song.....	6-37
The LFO Page	6-38
Minimum Rate	6-39
Maximum Rate.....	6-39
Rate Control.....	6-39
LFO Shape.....	6-39
LFO Phase	6-39
The ASR Page	6-40
Trigger	6-40
Mode.....	6-40
Delay.....	6-40
Attack	6-41
Release.....	6-41

The Function (FUN) Page	6-41
The Amplitude Envelope (AMPENV) Page.....	6-42
Attack Segment Times	6-43
Attack Segment Levels.....	6-43
Decay Segment.....	6-43
Release Segments.....	6-43
Loop Type	6-44
Number of Loops.....	6-44
The Envelope 2 (ENV2) and Envelope 3 (ENV3) Pages	6-44
The Envelope Control (ENVCTL) Page	6-45
Adjust	6-46
Key Tracking.....	6-46
Velocity Tracking	6-46
Source, Depth	6-46
Impact.....	6-47
The Program FX (PROGFX) Page	6-47
Insert.....	6-47
Aux 1, Aux 2.....	6-47
Output	6-48
Auxiliary Send Parameters.....	6-48
Aux1 Mod, Aux2 Mod	6-49
The Layer FX (LYR_FX) Page	6-49
The Controllers (CTLS) Page.....	6-50
INFO	6-51
Function Soft Buttons	6-51
Set Controllers (SetCtl).....	6-52
New Layer (NewLyr)	6-52
Duplicate Layer (DupLyr)	6-52
Import Layer (ImpLyr).....	6-52
Delete Layer (DelLyr).....	6-52
Name, Save, Delete.....	6-52
Editing VAST Programs With KVA Oscillators.....	6-53
Basic Use of KVA Oscillators	6-53
Setting KVA Oscillator Type	6-54
Advanced Use Of KVA Oscillators	6-55
Editing KB3 Programs.....	6-59
KB3 Editor: The Tone Wheels (TONEWL) Page.....	6-59
Upper Tone Wheel Keymap.....	6-59
Upper Volume Adjust.....	6-60
Number of Tone Wheels.....	6-60
Organ Map.....	6-60
Wheel Volume Map.....	6-60
Globals.....	6-60
Lower Transpose / Upper Transpose	6-60
KB3 Editor: The Drawbars (DRAWBR) Page.....	6-61
Mode.....	6-61
Steps.....	6-61
Volume	6-61
Tune	6-61
KB3 Editor: The Set Drawbars (SetDBR) Soft Button	6-62
KB3 Editor: The PITCH Page	6-62

KB3 Editor: The AMP Page	6-62
KB3 Editor: The PERC1 Page	6-63
Percussion	6-63
Volume	6-63
Decay	6-63
Harmonic	6-64
VelTrack.....	6-64
LowHarm.....	6-64
HighHarm.....	6-64
StealBar.....	6-64
KB3 Editor: The PERC2 Page	6-64
PercLevel, DecayTime, OrgLevel	6-64
KB3 Editor: The KEYCLK Page	6-65
KeyClick.....	6-65
Volume	6-65
Decay	6-65
VelTrk	6-65
Pitch	6-66
Random.....	6-66
ReTrigThresh.....	6-66
Note Attack.....	6-66
Note Release	6-66
KB3 Editor: The MISC Page.....	6-67
PreampResp.....	6-67
Leakage	6-67
LeakMode	6-68
SpeedCtl.....	6-68
VibChorCtl.....	6-68
VibChorSel.....	6-68
VolAdjust	6-68
BendRngUp, BendRngDn	6-68
Sustain	6-68
Sostenuto.....	6-68
LesliePedal.....	6-68
KB3 Editor: The EQ Page	6-69
KB3 Editor: The OUTPUT Page	6-70
Exp Pedal	6-70
KB3 Editor: The Program FX (PROGFX) Page	6-70
KB3 Editor: The LFO, ASR, and FUN Pages.....	6-70
KB3 Programming Tips	6-71

Chapter 7 Setup Mode

Zone-status LEDs in Setup Mode.....	7-2
Soloing a Zone.....	7-3
The Setup Editor	7-3
The Channel/Program (CH/PROG) Page	7-4
Program.....	7-4
Destination.....	7-5
Channel	7-5
MidiBank.....	7-5

MIDI Program (MidiProg)	7-6
Status	7-6
Out	7-6
Input Channel	7-6
MIDI Bank Mode (BankMode)	7-7
Entry Program Change (EntryProgChg).....	7-8
Arpeggiator	7-8
The Key/Velocity (KEY-VEL) Page	7-9
Low Key (LoKey), High Key (HiKey)	7-10
Transpose	7-10
Note Map	7-10
Velocity Scale (VelScale)	7-11
Velocity Offset.....	7-12
Velocity Curve (VelCurve).....	7-14
Low Velocity (LoVel), HighVelocity (HiVel).....	7-16
The Pan/Volume (PAN/VOL) Page	7-17
Entry Volume, Exit Volume.....	7-17
Entry Pan, Exit Pan	7-17
The BEND Page.....	7-18
Bend Range (Semitones) and Bend Range (Cents): Up and Down	7-18
Aux Bend 1 Up and Aux Bend 1 Down	7-19
Aux Bend 2 Range	7-19
Controllers	7-19
Continuous Controllers	7-20
Switch Controllers	7-21
The Controller Destination List.....	7-21
Shift Key Number, Shift Key (ShKeyNum, ShiftKey)	7-26
Continuous Controller Parameters	7-29
Switch Controller Parameters	7-30
The WHEEL Page.....	7-32
The SLIDER and SLID2 Pages.....	7-33
The Continuous Control Pedal (CPEDAL) Page	7-34
The Pressure (PRESS) Page.....	7-35
The Footswitch Pages (FT SW1, FT SW2, FT SW3)	7-36
The Arpeggiator Switch (ARP SW) Page	7-37
The SWITCH Page	7-38
The RIBBON Page.....	7-39
The Ribbon Configuration (RIBCFG) Page	7-40
Ribbon Configuration	7-40
Position Mode (PosMode)	7-41
Spring	7-41
Center	7-41
The ARPEGGIATOR & ARPEGGIATOR 2 (ARP1, ARP2) Pages	7-42
The ARPEGGIATOR Page.....	7-42
The ARPEGGIATOR 2 Page.....	7-49
Real-time Control of Arpeggiator Parameters	7-53
Riffs	7-55
The RIFF1 Page	7-55
The RIFF2 Page	7-58
Real-time Control of Riff Parameters.....	7-63
The FX Pages: FX, AUXFX1, AUXFX2, and MASTFX	7-64

The Programmable Switch Pages: SWPRG1 to SWPRG8	7-64
The COMMON Page	7-65
Tempo	7-65
Clock Source	7-65
Aux FX Channel	7-65
KB3 Channel	7-66
Mutes	7-66
Arpeggiator Global (ArpGlobal)	7-66
TRIGGER KEYS (KEYTRG)	7-67
The Utility Soft Buttons	7-68
Name	7-68
Save	7-68
Delete	7-68
New Zone (NewZn)	7-68
Duplicate Zone (DupZn)	7-68
Import Zone (ImpZn)	7-68
Delete Zone (DelZn)	7-68
Recording A Setup To Song Mode	7-69

Chapter 8 Quick Access Mode

Soft Buttons In Quick Access Mode	8-2
The QA Editor	8-2

Chapter 9 Effects and Effect Mode

Effects Overview	9-1
Insert Effects	9-1
Aux Effects	9-1
Master Effects	9-2
Chains	9-2
Signal Flow	9-2
DSP Units - Manage and Distribute Processor Power for Effects	9-3
Aux Override	9-3
Effect Mode and the Effects Pages	9-4
The EffectsEnable Page	9-4
The Aux 1 Override and Aux 2 Override Pages	9-5
The Master Effects Page	9-8
The Chain Editor	9-9
The MAIN Page	9-9
The MOD Pages	9-10
FXLFO, FXASR, and FXFUN pages	9-11
INFO	9-11
Effects Parameters	9-12
General Parameters	9-12
Reverbs	9-13
Delays	9-14
Equalizers (EQ)	9-15
Compressors, Expanders, and Gates	9-16
Chorus	9-18
Flanger	9-19

Quantize.....	9-19
LaserVerb	9-19
Filters	9-20
Distortion	9-21
Rotating Speakers	9-22
Vibrato/Chorus.....	9-23
Tremolo and AutoPan.....	9-24
Pitcher.....	9-25
Ring Modulation.....	9-25
Stereo Simulation.....	9-25

Chapter 10 MIDI Mode

The TRANSMIT Page.....	10-1
Control Setup	10-2
Destination.....	10-2
Channel	10-2
Transpose	10-2
Velocity Map (Transmit).....	10-3
Pressure Map (Transmit).....	10-4
Program Change (ProgChang).....	10-5
Change Setups (ChgSetups).....	10-5
The RECEIVE Page.....	10-5
Basic Channel.....	10-6
MIDI Receive Mode (MIDI Mode).....	10-6
All Notes Off	10-6
Program Change Mode (PrgChgMode).....	10-6
Velocity Map (Receive)	10-7
Pressure Map (Receive)	10-8
System Exclusive ID (SysExID)	10-9
Bank Select.....	10-9
Local Keyboard Channel (LocalKbdCh)	10-10
The Channels Page.....	10-14
Enable	10-14
Program.....	10-14
Pan	10-15
Volume	10-15
Program Lock, Pan Lock, Volume Lock	10-15
Program Change Formats.....	10-15
Extended Program Changes	10-16
QAccess.....	10-16
The Soft Buttons in MIDI Mode.....	10-18
Program Change (PrgChg).....	10-18
Reset Channels (RsetCh).....	10-18
Panic.....	10-18

Chapter 11 Master Mode

MAIN.....	11-1
Tune	11-2
Transpose	11-2

FX Mode	11-2
Drum Remap	11-2
ID Entry	11-2
Setup Controllers (SetupCtrls)	11-2
Master Table Lock (Master Lock)	11-3
Demo Button	11-3
Buttons Mode (Buttons)	11-3
Display	11-3
MAPS	11-5
Velocity Map (Master)	11-5
Pressure Map (Master)	11-7
Intonation	11-8
Key Action Map	11-9
Intonation Key (Int.Key)	11-9
Default Sequence	11-10
OUTPUT	11-10
Output Clock	11-10
Digital Output Volume (Dig. out volume)	11-10
Digital Output (Dig. Out)	11-10
Aux Out Pair Mode	11-10
Clock Source	11-11
TEMPO	11-11
General MIDI Mode (GM On, GM Off)	11-12
OBJECT	11-13
Rename	11-14
Delete	11-14
UTILS (UTILITIES)	11-16
CLOCK	11-17
Reset	11-18
Loader	11-18
About	11-18
Save	11-18
SAMPLE MEMORY (MEMORY)	11-18
MAP	11-19
Defragment (Defrag)	11-19
Preview Sample (PRVIEW)	11-19

Chapter 12 Song Mode and the Song Editor

Getting Started with the Sequencer	12-1
What is a Sequencer?	12-1
Song Mode: The MAIN Page	12-1
Current Song (CurSong)	12-2
Tempo	12-2
Recording Track (RecTrk)	12-3
Program (Prog)	12-3
Track Number (Trk:#)	12-3
Volume (Vol)	12-4
Pan	12-5
Mode	12-6
Location (Locat)	12-6

Mode Indicators (+ and x):	12-6
Activity Indicators	12-6
Track Status Indicators	12-6
Track Channels	12-7
Soft Buttons on the MAIN Page	12-7
The Save Changes Dialog	12-8
Song Mode: The BIG Page	12-10
Time In	12-10
Time Out	12-10
Song End	12-11
Loop	12-11
RecMode	12-11
Metron	12-11
Song Mode: The FX Pages	12-12
Song Mode: The MIXER Page	12-12
Out	12-12
The Rec, Play, and Stop Soft Buttons	12-13
The Keep Soft Button	12-13
The Done Soft Button	12-13
Song Mode: The METRONOME Page	12-13
Metronome	12-14
CountOff	12-14
Program	12-14
Channel	12-14
Strong Note	12-14
Strong Vel	12-14
Soft Note	12-14
Soft Vel	12-14
The Rec, Play, and Stop Soft Buttons	12-14
The Done Soft Button	12-14
Song Mode: The Filter Pages (RECFLT and PLYFLT)	12-15
Notes	12-15
LoKey	12-15
Hi	12-15
LoVel	12-16
Hi	12-16
Controllers	12-16
Controller	12-16
LoVal	12-16
Hi	12-16
PitchBend	12-16
ProgChange	12-16
MonoPress	12-16
PolyPress	12-16
The Rec, Play, and Stop Soft Buttons	12-16
The Done Soft Button	12-16
Song Mode: The MISC Page	12-17
Control Chase	12-17
Quant	12-17
Grid	12-17
Swing	12-18

Release	12-18
Key Wait	12-18
Song Mode: The STATS Page	12-18
The Song Editor.....	12-19
Song Editor: The COMMON Page	12-19
Tempo	12-19
TimeSig.....	12-19
FX Track	12-20
DrumTrack.....	12-20
MidiDst	12-20
Soft Buttons on the COMMON Page	12-21
Song Editor: The TRACK Page	12-21
Common Parameters for Edit Song: Track Functions	12-22
Region/Criteria Box Parameters	12-22
Soft Buttons on the TRACK Page	12-23
Song Editor: Track Functions	12-24
Erase	12-24
Copy	12-24
Bounce	12-25
Insert.....	12-26
Delete.....	12-26
Quantize.....	12-27
Shift.....	12-28
Transpose	12-28
Grab	12-29
Change	12-30
Remap.....	12-31
Song Editor: The EVENT Page.....	12-31
Initial Program, Volume, Pan.....	12-32
Location.....	12-32
Bar, Beat, and Tick	12-32
Event Type and Value	12-32
Soft Buttons on the EVENT Page	12-33
Tempo Track	12-33

Chapter 13 Storage Mode

Storage Mode Page	13-1
Using USB Devices	13-2
Storage Mode Common Features.....	13-4
Directories.....	13-4
Path	13-4
Common Dialogues.....	13-4
The STORE Page	13-6
Storing Overview.....	13-6
Select Object Type To Store	13-7
Select Object Range To Store	13-7
The Store Advanced Page.....	13-7
The LOAD Page	13-9
Loading .WAV and .AIF Audio Files	13-10
Loading Individual Objects From a .P3K Or Compatible File Type	13-10

Loading Methods.....	13-11
The Utilities (UTILS) Page	13-14
Soft Buttons on the Utilities Page	13-14
Export	13-15
Format	13-15
Tutorial: Load An Audio File, Create A New Keymap And Program	13-16

Chapter 14 Keymap and Sample Editing

The Keymap Editor	14-1
Keymap Editor Parameters	14-3
The Soft Buttons in the Keymap Editor.....	14-5
Special Double Button Presses in the Keymap Editor.....	14-6
Building a Keymap	14-7
Editing Samples	14-9
The Miscellaneous (MISC) Page.....	14-9
The TRIM Page.....	14-12

Chapter 15 Tutorial: Song Mode

Part 1: Assign Instruments To Tracks	15-2
Part 2: Set The Tempo.....	15-3
Part 3: Record Your First Track, Save The Song	15-4
Part 4: Record Additional Tracks.....	15-7
Part 5: Fixing Mistakes	15-8
Part 6: Adjusting The Volume Of Each Instrument	15-10
Part 7: Learning More About Song Mode	15-15

Appendix A Specifications

MIDI Implementation Chart	A-1
Specifications	A-2

Appendix B PC3K Bootloader

Using the Bootloader Menu	B-1
System Update (PC3K Software, Objects, Etc.)	B-2
Run Diags - PC3K Diagnostics Utility	B-2
System Reset.....	B-2
System Utilities	B-3

Appendix C Changing PC3K Voltage

Removing the fuse holder	C-1
--------------------------------	-----

Appendix D PC3K Objects (V 2)

Programs	D-1
Setups	D-13
Effect Chains.....	D-15
Effect Presets with Algorithms	D-21
How to Use These Tables.....	D-21

Reverbs	D-21
Delays	D-25
Chorus	D-27
Flange	D-27
Phaser	D-28
Trem / Panner / Spatial.....	D-29
Rotary	D-29
Distortion	D-30
Dynamics	D-31
EQ / Filters	D-31
Chorus / Combi.....	D-33
Flange / Combi	D-34
Keymaps.....	D-36
Samples	D-42
Arpeggiator Shift Patterns	D-49
Arpeggiator Velocity Patterns.....	D-51

Appendix E PC3K Legacy File Conversion

Object Types and Conversion Details	E-1
Soundblock (Sample Objects)	E-1
Keymap Objects	E-1
Program Objects.....	E-1
Setup Objects.....	E-1

Index

Chapter 1

Introduction

Greetings. Your new instrument offers amazing acoustic, electric, and synthesizer sounds, combined with sample loading and advanced programming features that will let you create almost any sound you can imagine. This manual covers the PC3K in its 88, 76, and 61-note configurations (PC3K8, PC3K7, and PC3K6.) For the most part, anywhere we talk about the PC3K in this manual we mean any of these instruments.

The PC3K comes loaded with 64 MB of ROM sounds, powered by Kurzweil's newest custom chip set. In addition to the great sounds and programming features, the PC3K is fully equipped with performance features you'll use at every gig. For example, there are nine conveniently situated sliders for accurately emulating the drawbars on a tone wheel organ such as a Hammond B3™. And the PC3K's 24 dedicated sound select buttons, along with its Quick Access banks will let you instantly choose and change sounds whenever you like.

In addition to the many impressive features and sounds of the PC3, the PC3K allows users to tap into the massive wealth of samples and programs developed for our legendary K Series over the past 18 years. The PC3K is capable of loading most K series object files (with extensions .KRZ, .K25, or .K26,) including samples, keymaps, programs, and setups, (see Appendix E for details,) once again underscoring our commitment to the concept of non-obsolescence by design. Additionally, the PC3K can load .PC3 files that were created with the PC3. The PC3K can also load WAVE and AIFF files (see page 13-10 for details.) You can choose to delve into the extensive libraries of existing K Series samples or decide to fill the PC3K's flash memory with your own custom samples. In either case, you have the most powerful version of Kurzweil's V.A.S.T technology ever developed at your fingertips to help sculpt your sounds. Sample files can be loaded via USB from a thumb-drive or directly from a computer.

The PC3K offers 128 megabytes of user sample memory, and samples remain loaded even while power is off. Once samples are loaded into the PC3K's flash memory, there is zero load time for those samples when powering on the instrument.

Advanced program, keymap and sample editing features allow you to customize your sounds further. You're able to map any sample to any key, tune individual samples, change the start, alt start, loop point and end point of samples and even assign a controller to adjust sample start point in real-time.

If you've used other Kurzweil gear, you'll have no trouble getting up and running quickly. Bear in mind, however, that the PC3K's beauties are more than skin-deep; you'll want to read this manual, as well as the materials at the www.kurzweil.com website to take full advantage of your instrument.

Keeping Current

Check for new documentation and operating system upgrades before you start using your instrument. When new software is available for the PC3K, it will be posted at www.kurzweil.com. You'll use the PC3K's Boot Loader (described in this manual) to upgrade your instrument to use the new software.

Pictured below is the 88-key PC3K8.

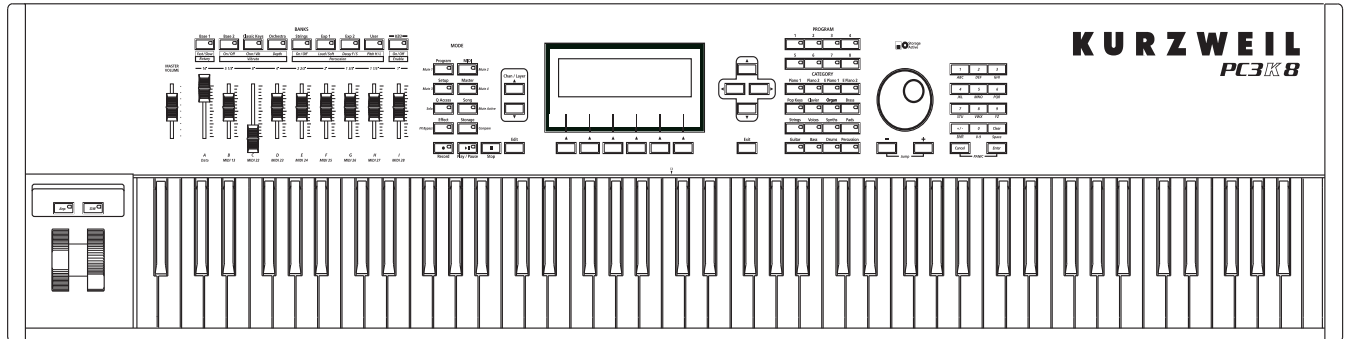

Overview of the PC3K

The PC3K's 800+ programs include the Orchestral and Contemporary sound blocks, General MIDI (GM), Stereo Triple Strike Piano, Classic Keys for realistic vintage electric piano sounds, and new String Sections. Multi-zone performance setups are also provided; many of these setups use note triggers to play factory-recorded songs that provide grooves and arpeggiation that make great templates for performance or recording. An on-board sequencer with front panel transport buttons lets you record your ideas any time inspiration strikes. This sequencer (Song mode) lets you play back MIDI type 0 or 1 sequences, record and play back your own songs, and record multi-timbral sequences received via MIDI.

Before we get into explaining VAST, here are a few of the features that by themselves make the PC3K an impressive stage and studio machine. It has 128-voice polyphony and is fully multi-timbral, so that different programs can be played on each MIDI channel. There's an on-board digital effects processor providing multiple simultaneous effects, including real-time effects control, internally or via MIDI. In fact, the PC3K offers more effects processing power than Kurzweil's much-lauded KSP8 studio effects processor.

The PC3K offers 128 megabytes of user sample memory. Samples can be loaded via USB from a thumb-drive or directly from a computer, and samples remain loaded even while power is off. Once samples are loaded into the PC3K's flash memory, there is zero load time for those samples when powering on the instrument. The PC3K is compatible with most K series object files (with extensions .KRZ, .K25, or .K26,) including samples, keymaps, programs, and setups (see Appendix E for details.) Additionally, the PC3K can load .PC3 files that were created with the PC3. The PC3K can also load WAVE and AIFF files (see page 13-10 for details.)

In addition to the standard stereo audio output pair, there are two additional balanced analog outputs, as well as a digital output. All of the outputs are available to you simultaneously.

For backup, storage, and moving files, there's two types of USB ports on the back panel of the PC3K. A USB storage port allows you to connect a USB device such as a thumb drive, and a second USB Computer port lets you connect the PC3K to a computer for file transfer and MIDI connectivity.

How the PC3K Works

The PC3K integrates three MIDI-driven components: a MIDI controller (the keyboard, or an external MIDI controller), a sound engine, and an effects processor that employs the same effects used in Kurzweil's KSP8. The sound engine responds to the MIDI events generated by the MIDI controller, and turns them into sounds that are processed within the variable architecture of the algorithms—or by oscillators for KB3 programs. The resulting sound can then be routed through the PC3K's effects and to the audio outputs.

VAST Synthesis

The PC3K's Variable Architecture Synthesis Technology (V.A.S.T.) lets you build sounds from realistic instrumental samples and sampled synth waveforms—then modify the nature of those sounds through a wide variety of digital signal-processing (DSP) functions. The PC3K also generates its own synth waveforms, which can be combined with the samples or used on their own.

While many other synthesizers may offer a fixed set of *DSP* tools (typically filtering, pitch, and amplitude modulation) the PC3K's Variable Architecture lets you arrange a combination of DSP functions from a long list of choices. The functions you choose define the type of synthesis you use.

Each layer of every program has its own DSP architecture, which we call an *algorithm*. Within each algorithm, you can select from a variety of DSP functions. Each function can be independently controlled by a variety of sources including LFOs, ASRs, envelopes, a set of unique programmable functions (FUNs), as well as any MIDI control message. The many different DSP functions and the wealth of independent control sources give you an extremely flexible, truly vast collection of tools for sound creation and modification.

The PC3K offers powerful editing features we call **Dynamic V.A.S.T.** and **Cascade Mode**.

- **Dynamic V.A.S.T.** allows you to “wire” your own algorithms, combining different DSP functions in any order you like, including parallel and serial configurations.
- **Cascade Mode** lets you route any layer of a program into the DSP of any other layer. Any of the 32 layers of a program can go into any other layer.

When you're ready to jump in and start creating programs, turn to Chapter 6.

KB3 Tone Wheel Emulation

In addition to VAST synthesis, the PC3K offers many oscillator-based programs that give you the classic sound of tone-wheel organs like the Hammond B3. KB3 mode, as we call it, is completely independent of VAST, and has its own set of editing procedures. Nine dedicated sliders on the PC3K's front panel give you real-time drawbar control over these organ sounds. Buttons above the sliders control rotating speaker speed, percussion, and other organ features.

The quickest way to get to the KB3 programs is by pressing the KB3 button (above the sliders, to the left of the screen). The blue LED in the KB3 button will light when the current program is a KB3 program.

VA-1 Programs

The VA-1 (Virtual Analog Synthesizer) programs included with the PC3K offer realistic emulations of classic analog synthesizers, built from Kurzweil's unique anti-aliased DSP-generated oscillators. The PC3K's power-shaped oscillators let you transition smoothly from one waveform into another in real time, without using cross-fades.

VA-1 programs are scattered throughout the PC3K. Look for them in the Synth Category and the Classic Keys Bank. You'll see "KVA Oscillator" appear in the Keymap screen on the left hand side of the display.

How to Use This Manual

This manual describes how to connect and power up your PC3K, getting around the front panel, and a brief description of the operating modes. For information on editing and advanced programming features, refer to additional material provided on the Kurzweil website:

<http://www.kurzweil.com>

The best way to read this manual is with your PC3K in front of you. By trying the examples we give to illustrate various functions, you can get a quick understanding of the basics, then move on to the more advanced features.

Do I Have Everything?

Your PC3K shipping carton should include the following in addition to your instrument:

- Power cable
- Sustain pedal
- USB cable
- *Getting Started* manual (this book)

If you don't have all of these components, please call your Kurzweil/Young Chang dealer.

You may also want to purchase a USB thumb drive for portable backups and storage.

Boot Loader

When you need to update the PC3K's software or run diagnostic tests, you'll use the Boot Loader. To bring up the Boot Loader, hold down the **Exit** button (below the cursor buttons, to the right of the display) while powering on your PC3K. Refer to Appendix B for details on the Boot Loader.

Battery

The PC3K uses a CR2032 battery to power its clock. The battery should last five years, and a message will tell you when the battery needs replacing. The access panel on the bottom of the PC3K (which you can easily remove with a screwdriver) allows you to get at the battery for removal and replacement.



CAUTION: Danger of explosion if battery is incorrectly replaced. Replace only with the same or equivalent type (CR2032).

Options

Ask your Kurzweil dealer about the following PC3K options:

Sound ROM Expansion Card

The PC3K has a socket for a 64 MB expansion card to add additional Kurzweil ROM sounds. This is user installable (the expansion kit comes with complete instructions).

Pedals

The PC3K has jacks for three switch pedals (for functions like sustain or program/setup changes) and two continuous pedals (for functions like volume control and wah). Your Kurzweil dealer stocks the following optional pedals:

FS-1	Standard box-shaped switch pedal
KFP-1	Single piano-style switch pedal
KFP-2M	Double piano-style switch pedal unit
CC-1	Continuous pedal

Ribbon Controller

There's a dedicated modular jack (like a telephone jack) on the rear panel of the PC3K for connecting this 600-mm (24-inch) ribbon controller. You can configure the PC3K to use the ribbon as a single large controller, or a three-section controller with independent settings for each section.

Breath Controller

You can plug a Yamaha (or equivalent) breath controller into the dedicated jack on the PC3K's rear panel.

USB Storage Device

You can plug a USB mass storage device such as a "thumb drive" into the PC3K for transferring samples, backing up, archiving, sharing your work, and updating your software. Any size USB mass storage device will work, though thumb drives are recommended for their portability, durability, and low price.



Note: Most USB thumb drives are compatible with the PC3K, but some older USB thumb drives and larger USB bus powered drives will not work with the PC3K if they require more than 100 mA of current (high power USB devices.) When attempting to use an incompatible USB device, the PC3K will display the message "USB device requires too much power". The PC3K is designed to work with low power USB devices and can provide a maximum of 100 mA to a USB device. Power requirement specifications for thumb drives are not always made clearly available by the manufacturer, but a newly purchased thumb drive will most likely be compatible. If possible, check the power requirement specifications of your USB device before purchase.

Chapter 2

Startup

If hooking up new gear is familiar to you, and you just want to get going, here's a quick description of what you need to get started with your PC3K. If you need more information, thorough descriptions of each step follow.

Make Connections

1. Set the keyboard on a hard, flat, level surface. Make sure to leave plenty of room for ventilation.
2. Four adhesive-backed rubber feet are provided with your PC3K. If you want to attach them to the bottom of the PC3K (recommended to prevent scratching your tabletop), carefully turn the keyboard over, remove the paper backing from the rubber feet and attach them now, near each corner, all on the same level.
3. Connect the power cable.
4. Make sure your sound system is at a safe volume level. Also make sure that the PC3K's MASTER VOLUME slider (on the far left side of the front panel) is all the way down.
5. Plug in a pair of stereo headphones or run standard (1/4-inch) audio cables from your amplifier or mixer to the MIX audio outputs on the PC3K. (Use the Main Left out for mono.) Balanced ("TRS" or "Stereo") cables are recommended.

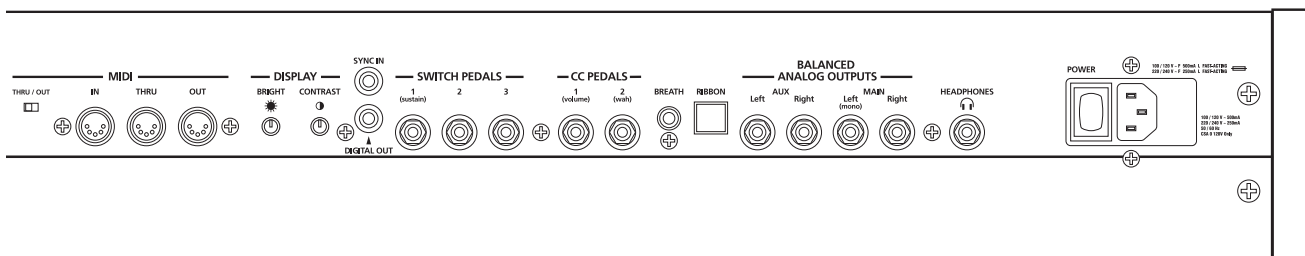

Make Music

1. Power up your PC3K, raise the level of the MASTER VOLUME slider, and check out some of the programs and setups. The PC3K starts up in Program mode by default. Press one of the mode buttons to the left of the display to switch modes.
2. If you hear distortion, reduce the gain on your mixing board, or use the pad if it has one.
3. Scroll through the program list with the Alpha Wheel, or the dedicated Category and Program buttons, and try the PC3K's many sounds.

Startup—the Details

This section walks you through the hookup of your PC3K. We'll take a look at the rear panel, then describe the power, audio, and other cable connections.

Before You Start...

Don't connect anything until you make sure your PC3K is properly and safely situated. Also, if your PC3K has been out in the cold, give it time to warm up to room temperature before starting it, since condensation may have formed inside the PC3K. It is normal for the rear panel near the MIDI jacks to become warm after a while.

Connecting the Power Cable (Line Cord)

The PC3K runs on AC power: 100, 120, 230, or 240 volts at 50–60 Hz. Your dealer will set the voltage switch to match the voltage in your area. The voltage level is set with a selector on the rear panel of the PC3K. Unless you are sure it needs to be changed, you shouldn't adjust this.

When you've connected the cable at the PC3K end (as you face the back of the PC3K, the power connection is at the right), plug it into a grounded outlet. If your power source does not have the standard three-hole outlet, you should take the time to install a proper grounding system. This will reduce the risk of a shock.

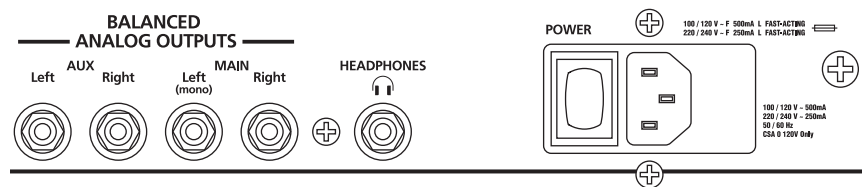

Connecting Audio Cables

Analog

After you've turned down the level on your sound system, connect the PC3K's analog audio outputs to your sound system using a pair of stereo or mono audio cables. Mono cables will always work, but if you're going into balanced inputs, use stereo cables for a better signal-to-noise ratio and a bit more volume. The PC3K's analog outputs are balanced, and generate a "hotter" signal than some previous Kurzweil instruments.

You'll find four 1/4-inch balanced audio output jacks on the rear panel. For now, connect one end of each audio cable to your mixing board or PA system inputs, and connect the other end to the jacks marked Main Left and Right on the rear panel of the PC3K. If you have only one input available, use the PC3K's Main Left output to get the full signal in mono.

In Master mode you can set the Aux outputs to duplicate the Main Outs – useful for monitoring and other operations. They are always in stereo, as is the headphone out.

Digital

For digital audio output from the PC3K, connect a 75-Ohm coaxial cable from the PC3K's RCA Digital Out jack to the AES or S/PDIF input of the receiving device. You may need an RCA-to-XLR adapter to connect with the receiving device. If the receiving device receives only optical signals, you'll need a converter as well. The PC3K's Master Page (press the Master mode button) lets you select a range of useful sample rates for the digital output.

The RCA jack labeled "Sync In" allows you to synchronize the PC3K's S/PDIF Digital Audio output sample rate to an external S/PDIF source. Although no audio signal is received by the "Sync In" jack, its clock is received and may be used to set the output sample rate. For details, see the Master Mode OUTPUT page parameter *Digital Output (Dig. Out)* on page 11-10. NOTE: Sync In is NOT a "Word Clock" input. Only a valid S/PDIF signal is recognized.

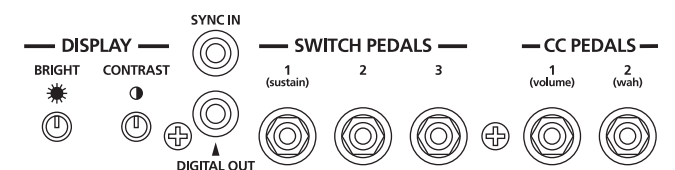

Connecting MIDI

The simplest MIDI configuration uses a single 5-pin MIDI cable: either from the MIDI Out port of your PC3K to the MIDI In port of another instrument, or from the MIDI Out port of another MIDI controller to the MIDI In port of the PC3K. There are all sorts of possible configurations, including additional synths, personal computers, MIDI effects processors, and MIDI patch bays. Depending on your system, you may want to use the PC3K's MIDI Thru port to pass MIDI information from a MIDI controller to the PC3K and on to the next device in your system. You can also connect MIDI devices to the PC3K's MIDI Out port, which can send channelized MIDI information from the keyboard or through the PC3K from your MIDI controller.

The MIDI Thru port can be configured to serve as an additional MIDI Out by sliding the nearby switch to the Out position.

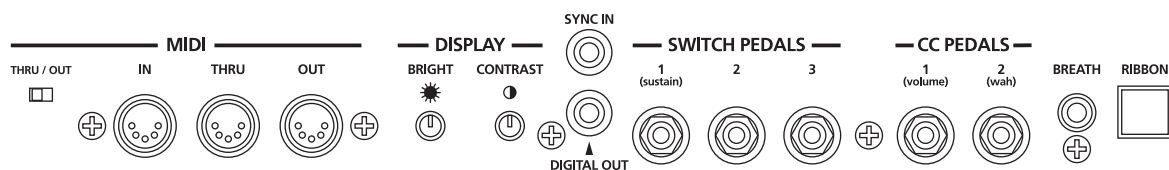

You can also use the PC3K's USB port to send and receive MIDI. By default the PC3K will show up as a USB MIDI device. If you choose USB Temporary Drive from Storage mode, the PC3K will temporarily (while on that Storage mode page) become a "virtual storage device" and USB MIDI will be disabled. Different host programs on your computer may indicate various errors as the USB MIDI device is no longer present. Leaving Storage mode will restore USB MIDI functionality.

USB MIDI and 5-pin MIDI can be used at the same time; the MIDI signals will be combined into a single 16-channel MIDI stream.

Pedals

Plug your switch or continuous pedals into the corresponding jacks on the PC3K's rear panel. We recommend using the Kurzweil pedals described on page 1-5, but you can use almost any switch or continuous pedal, as long as it adheres to the following specifications (as most pedals do):

Switch pedals	1/4-inch tip-sleeve plug
Continuous pedals	10-kOhm linear-taper potentiometer, 1/4-inch tip-ring-sleeve plug with the wiper connected to the tip.

If you use a third-party (non-Kurzweil) switch pedal, make sure it's connected before you turn on your PC3K. This ensures that the pedal will work properly (it might function backward—off when it's down and on when it's up—if you turn on your PC3K before plugging in the pedal). Similarly, don't press any of your switch pedals while powering up, because the PC3K verifies each pedal's orientation during power up. If you're pressing a pedal, you might cause it to work backward.

The pedals are independently programmable within each zone of every setup. Here are the default settings for the five pedals you can use with the PC3K:

Switch Pedal 1	Controller 64 (Sustain)
Switch Pedal 2	Controller 66 (Sostenuto)
Switch Pedal 3	Controller 67 (Soft)
Continuous Control Pedal 1	Controller 11 (Expression / Volume)
Continuous Control Pedal 2	Controller 4 (Foot Pedal) <i>produces a "wah" effect in many setups</i>

Breath

The 3.5mm jack labeled Breath accepts a standard breath controller, which sends standard MIDI Breath (MIDI 2) messages. The PC3K's preset programs and setups don't respond to breath, but if you have other instruments that *do* respond to Breath, you can control them from the PC3K via MIDI.

You can also program the PC3K so that the breath controller sends a different MIDI message. This would enable you to use a breath controller to affect the PC3K, but then other instruments receiving MIDI from the PC3K would no longer respond to the PC3K's breath controller (unless you also programmed them to receive the same MIDI Controller that the PC3K's breath controller is sending).

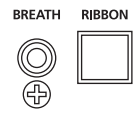

Ribbon

Plug the optional Kurzweil Ribbon Controller into the modular Ribbon jack on the rear panel. The ribbon controller itself should rest on a flat surface; it fits nicely between the keys and the buttons and sliders on the front panel.

The ribbon is a continuous controller. You can program the ribbon controller to send MIDI Controller messages 1–127, as well as several specialized messages. It generates values of 0–127 for whatever MIDI Controllers you assign it to send. Just press it, and slide your finger along the ribbon to change the value of the message it's sending.

You can configure the ribbon to have one control section that runs its entire length, or to have three sections of equal length. It sends its highest values when you press it at the end where the cable connects. When you configure it to have three sections, each section sends its highest values at the end closest to the cable.



Caution: The modular jack is designed for connection to the Kurzweil Ribbon Controller option only. Don't plug any other modular plugs into the Ribbon jack.

Switching On the Power

The PC3K's power switch is on the rear panel, adjacent to the power cable connection.

When you power up, the display briefly shows some startup information. The Program mode display then appears. It looks like the diagram below, though your PC3K may be different from the example.

ProgramMode	%P10st	Basel1s	#Ch:1
1-4/7 layers		1 Standard Grand	
Piano mp Left	∞	2 Studio Grand	
Piano mf Left	∞	3 Rubenstein SW Com	
Piano f Left	∞	4 Horowitz Grand	
Rheadz Thump		5 NYC Jazz Grand	
Octav-	Octav+	Panic	Info
		XPose-	XPose+

The first time you power up (or after a reset), your instrument will be set to operate on MIDI Channel 1 (as shown at the far right of the top line above).

Set the volume at a comfortable level. You'll get the best signal-to-noise ratio if you keep the PC3K at full volume, and adjust the level from your mixing board. You may also want to adjust the display contrast and brightness. There are two small knobs on the rear panel of the PC3K for this purpose.

USB Storage Port

You can plug a USB mass storage device such as a “thumb drive” into the PC3K for backing up, archiving, sharing your work, and updating your software. Any size USB mass storage device will work, though thumb drives are recommended for their portability, durability, and low price. The USB Storage port is on the back panel of the PC3K, but it is easily accessible from the front of the instrument. A USB connector will only fit into the port if oriented properly, so don’t force it into the port, as this may damage your PC3K or USB device. If you are having trouble inserting your USB connector into the port, try flipping the connector over.



Note: Most USB thumb drives are compatible with the PC3K, but some older USB thumb drives and larger USB bus powered drives will not work with the PC3K if they require more than 100 mA of current (high power USB devices.) When attempting to use an incompatible USB device, the PC3K will display the message “USB device requires too much power”. The PC3K is designed to work with low power USB devices and can provide a maximum of 100 mA to a USB device. Power requirement specifications for thumb drives are not always made clearly available by the manufacturer, but a newly purchased thumb drive will most likely be compatible. If possible, check the power requirement specifications of your USB device before purchase.



Caution: Do not remove a USB device while the display says **Loading...** or **Saving...**. Removing a USB device during a file transfer can cause data corruption.

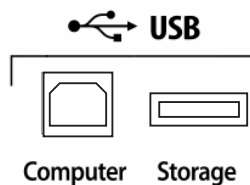

USB Computer Port

Next to the USB Storage port on the back panel of the PC3K is a USB Computer port. The USB Computer port works for MIDI (transmit and receive) or to connect your PC3K to a computer for file transfer. By default, the USB port is set to MIDI mode. When selecting USB PC connection in Storage mode, USB MIDI will temporarily be disabled.

We recommend that you use the USB cable provided with your PC3K and do not use extension USB cables. The PC3K’s USB Computer port is only intended for connection to a USB Type A port.

In USB Storage mode, a “PC3K” *virtual* drive will appear on your computer desktop. One important thing to know here is that this is a virtual drive. You can save to this drive from the PC3K, but you must immediately transfer that file to your desktop (or other folder). **You must copy data from the PC3K virtual drive to your computer’s drive or else the data will be lost.**



Note: When transferring files to and from the PC3K via the USB Computer Port, the maximum size of files that can be transferred is approximately 1.6MB. This is suitable for most objects. For transferring audio sample files, use the USB Storage Port with a USB mass storage device such as a “thumb drive.” When using the USB Storage Port to transfer files, the file size that can be transferred is limited only by the size of the USB mass storage device, and the PC3K’s available object and sample memory.

When you leave Storage Mode, there will be a prompt telling you that the PC3K is turning back into a USB MIDI device - which you have to acknowledge. If you haven't copied the file(s) to your desktop (or other place on the computer) it won't be on the virtual disk when you leave storage mode.

Depending on your computer's operating system, you may sometimes see a scary device removal warning on your desktop (for example, when the PC3K leaves the Boot Loader). You may disregard such a message without worries of damage to your PC3K or computer.

Setting the Clock

The first time you start up your PC3K is probably a good time to set the instrument's clock to your current local time. Do this from the Master mode CLOCK page.

The clock will time-stamp your files that have been stored via USB.

PC3K Programs

The PC3K powers up in Program mode, where you can select and play programs (called patches, presets, or voices on other instruments). Programs are preset sounds composed of up to 32 *layers* of samples or waveforms. If you've left Program mode, just press the **Program** mode button or **Exit** button to return.

Selecting Programs

When you are in Program mode, there are three basic ways to select a PC3K program:

- Press one of the **Bank** buttons (above the sliders on the left side of the front panel) to select a bank, then press a **Category** button and a **Program** button. The Category and Program buttons are on the front panel, between the screen and the alpha wheel. *Note: The instrument names above the Category buttons are relevant for Banks 1 and 2 (**Base 1** and **Base 2**). For all other Banks, the Category buttons select a group of 8 programs to be selected by the Program buttons, but the group of programs may not match the instrument name of the selected Category button. (See *Program and Category Buttons* on page 3-4 for more details.)*
- Type the program's ID (number) on the alphanumeric buttonpad, then press **Enter**. If you make a mistake, press **Clear**, then start over.
- Scroll through the list using the Alpha Wheel, the **Plus** or **Minus** button under the Alpha Wheel, or the cursor buttons (the arrow buttons to the right of the display).

The PC3K has various settings for responding to MIDI Program Change commands from external sources. These are explained in Chapter 10, so we won't go into them here. You should be able to change programs by sending Program Change commands from your MIDI controller.

Easy Audition

Any time you want to hear what a program sounds like, highlight the program's name (while in Program mode) then press the **Play/Pause** button to play a brief sample. The Demo Button parameter on the Master Mode MAIN page must be on for Easy Audition to work; the parameter is on by default. Master mode is described in Chapter 11.

Program Mode Display

Take a minute to familiarize yourself with the Program mode display. It gives you some helpful basic information, like the MIDI transposition, what MIDI channel you're on, and which program is currently selected.

ProgramMode	XPose	BaseIs	#Ch:1
1-4/7 layers		1 Standard Grand	
Piano mp Left	∞	2 Studio Grand	
Piano mf Left	∞	3 RubensteinSWCom	
Piano f Left	∞	4 Horowitz Grand	
Rhoadz Thump		5 NYC Jazz Grand	
Octav-	Octav+	Panic	Info XPose- XPose+

Info Box

There's a box at the left side of the display. The info box, as it's called, displays information about the current program (there's also an info box for Setup mode).

Soft buttons

On most PC3K screens, the bottom line of the display identifies the function of each of the buttons beneath the display. We call these buttons *soft* buttons, because they do different things depending on what's currently showing in the display.

In Program and Quick Access modes, you can change octaves with the **Octav-** and **Octav+** buttons under the display. The **Info** soft button shows you relevant details about the current item. The **Xpose-/Xpose+** buttons are a shortcut for quick transposition in semitone (half step) increments. You can use them to transpose the entire PC3K as much as three octaves up or down. The top line of the display shows the current amount of transposition (Xpose). Press both **Xpose** buttons simultaneously to return transposition to zero.

The **Panic** button (or a double press of Cancel and Enter at the bottom of the alphanumeric keypad) sends an All Notes Off message and an All Controllers Off message—both to the PC3K and over all 16 MIDI channels. You won't need it often, but it's nice to have.

VAST Programs

A "normal" VAST program is what most of the factory programs are. The info box contains details about the different layers in each program, usually indicating the keymap used in each layer. The line under the keymap name indicates the layer's keyboard range. In this case, only the first two displayed layers extend across the entire keyboard (A 0 to C 8). The × symbol to the right of each layer shows that the keymap is a stereo keymap.

ProgramMode	XPose	BaseIs	#Ch:1
1-4/7 layers		1 Standard Grand	
Piano mp Left	∞	2 Studio Grand	
Piano mf Left	∞	3 RubensteinSWCom	
Piano f Left	∞	4 Horowitz Grand	
Rhoadz Thump		5 NYC Jazz Grand	
Octav-	Octav+	Panic	Info XPose- XPose+

KB3 Programs

KB3 (organ) programs differ from VAST programs in that they don't have layers. Instead they rely on oscillators that mimic the tone wheels used in many popular organs. Consequently, the info box shows only the waveform used in the program. Because of their architecture, KB3 programs require different processing within the PC3K. KB3 programs play *only* on a single channel at a time (VAST programs will work fine on that channel, too).

The quickest way to get to the KB3 programs is by pressing the KB3 button that's above the sliders.

When you're ready to start doing your own programming, check out Chapter 6.

Setups

Setups are preset combinations of programs. Setups can have up to 16 zones, each of which can be assigned to any range of the keyboard (overlapping or split). Each zone can have its own program, MIDI channel, and MIDI control assignments, as well as riff and arpeggiator settings.

Press the **Setup** mode button to the left of the display. Its LED will light, telling you that you're in Setup mode. Notice that the Setup mode display is similar to the Program mode display. If the setup has four or fewer zones, the box at the left shows you the programs assigned to each of the setup's zones. If the setup is composed of more than four zones, then the box displays the first four zones; at the top of the box will be text showing the total number of zones. See page 7-1 for a more detailed description.

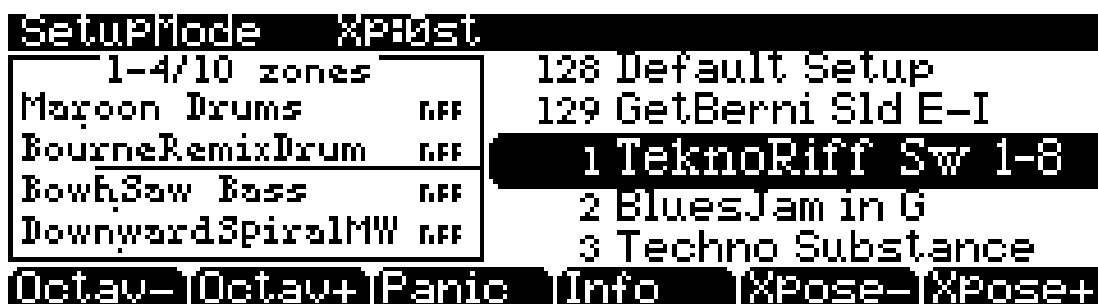

Many setups include arpeggiation and note-triggered songs to create some pretty amazing grooves that you can use as is, or as templates for your own material. As you play with these setups, experiment with the sliders and other controllers for a wide range of effects. Some of these grooves keep playing after you've released the keys that got them going. When you want to stop them, select another setup, or press the **Setup** mode button (or **Stop** for riffs).

Quick Access

A really convenient way to select programs and setups is to use Quick Access mode, where you select a Quick Access *bank* from a list of factory preset or user-programmed banks. Each bank contains ten memory slots, or entries, where you can store any combination of programs or setups. While you're in Quick Access mode, you can select any program or setup in the bank with buttons 0 through 9 or the cursor keys.

The PC3K comes with a few Quick Access banks already programmed so you can get an idea of how they work. You'll probably create your own Quick Access banks to help you select programs and setups with a minimum of searching. Press the **Quick Access** mode button to the left of the display. Its LED lights, to tell you you're in Quick Access mode.

The top line of the display tells you which Quick Access bank is selected. Use the **Chan/Layer** buttons (to the left of the display) to scroll through the banks. The names of each of the ten entries in the bank are listed in the center of the display. Many of their names will be abbreviated. The currently selected entry's full name is shown near the bottom of the display. The amount of transposition is displayed to the left of the entry name. If the current entry is a program, you'll see the current keyboard (MIDI) channel displayed to the right of the entry's name. If it's a setup, you'll see the word Setup.

The entries on the Quick Access page are arranged to correspond to the layout of the numeric buttons on the alphanumeric pad.

When you're ready to create your own Quick Access banks, turn to Chapter 8 to learn about the Quick Access Editor.

The Other Modes

There are five other mode buttons on the front panel. See Chapters 3 and 4 for more detailed descriptions of the modes.

Effects mode	Enable/disable effects presets, and set Aux overrides.
MIDI mode	Configure the PC3K for sending and receiving MIDI information.
Master mode	Define performance and control settings.
Song mode	Record and edit sequences (songs); play Type 0 and Type 1 MIDI sequences.
Storage mode	Load and save programs, setups, sequences, and other objects via USB device.

Software Upgrades

It's easy to upgrade the PC3K's operating system and objects (programs, setup, etc.) using the boot loader to install upgrades into flash ROM. When upgrades are available you can download them from www.kurzweil.com and install them via one of the PC3K's two USB ports.

When you've downloaded an upgrade, you can install it yourself in a matter of minutes. Follow the instructions included with the upgrade files.

Chapter 3

User Interface Basics

This chapter will show you how to get around the front panel of your PC3K. Your interactions can be divided into three primary operations: mode selection, navigation, and data entry. There is also an assignable control section.

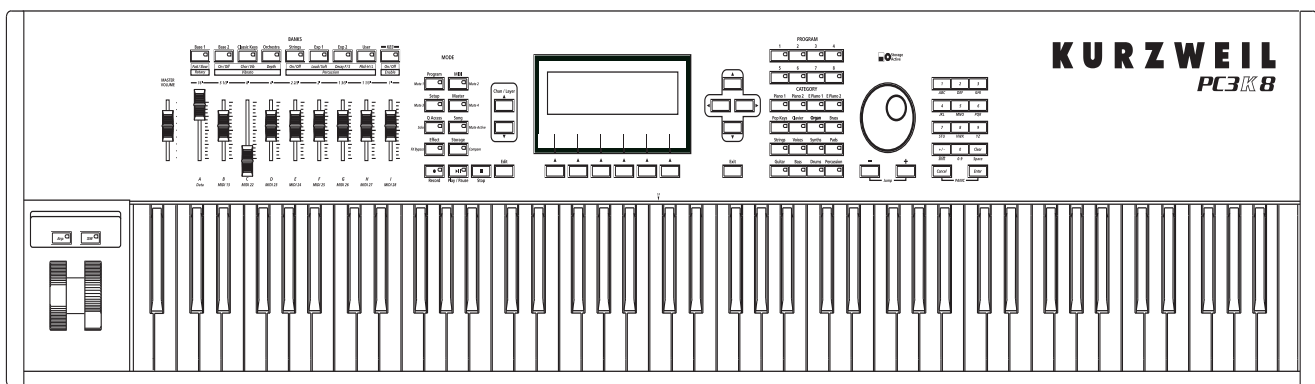

Mode Selection

The PC3K is always in one of eight primary operating modes. Select a mode by pressing one of the mode buttons — they're to the left of the display. Each mode button has an LED that lights to indicate the current mode. Only one mode can be selected at a time.

- | | |
|--------------------------|--|
| Program mode | Select and play programs, and modify them with the <i>Program Editor</i> . |
| Setup mode | Select and play setups (16 keyboard zones with independent MIDI channel, program and control assignments), and modify them with the Setup Editor. |
| Quick Access mode | Select from a list of preset banks, each containing a list of ten programs and/or setups that can be viewed in the display for easy selection. Modify the preset banks and create your own with the Quick Access Editor. |
| Effect mode | Enable/disable effects or set Aux overrides for Program Mode (or a program selected from Quick Access mode.) |
| MIDI mode | Define how your PC3K sends and receives MIDI information, and configure each channel to receive independent program, volume, and pan messages that override the normal Program mode settings. |
| Master mode | Define performance and control characteristics for the entire PC3K. |

Mode Buttons

- Song mode** Use the PC3K’s sequencer to record and play back your keyboard performance, play Type 0 and Type 1 MIDI sequences, and record multi-timbral sequences received via MIDI.
- Storage mode** Interface with the PC3K’s USB storage or computer ports to load and save programs, setups, samples, and more.

The PC3K’s tone wheel organ emulation is called **KB3 mode**. You automatically enter this mode when you select a KB3 program. The KB3 Bank button takes you there directly.

Mode Buttons

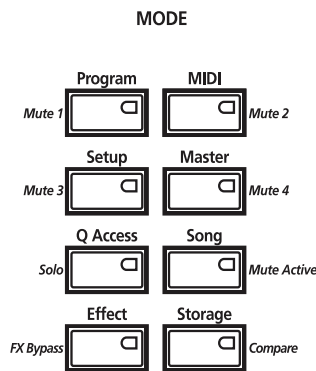

When you press a mode button, its LED lights up to indicate that the mode has been selected. If pressing a mode button does not light its LED, press the **Exit** button one or more times, then try again.

Additional labeling for each mode button indicates special functions that relate to some of the PC3K’s editors.

Bank Buttons

The Bank buttons, situated in the top left corner of the PC3K’s front panel, let you choose different banks of programs (e.g., KB3 programs or Classic Keys programs). Within each bank, you can use the Program and Category buttons (to the right of the display) to select individual programs.

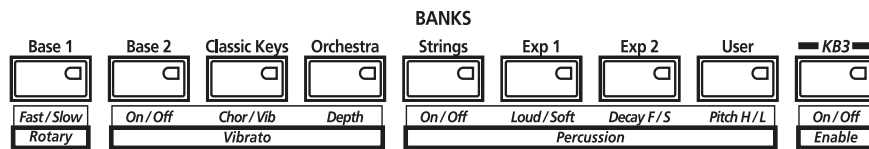

The Bank buttons have special functions in KB3 mode, indicated by labels beneath each button.

Sliders

In KB3 mode, the PC3K's nine sliders emulate an organ's drawbars. For example, slider A emulates an organ's 16' drawbar. In other modes, the sliders can be used to send values for different MIDI controllers. In either case, you may have to move the slider past the current value for its selected function before slider movement will have any effect. Press the **Info** soft button on the Program mode or Setup mode main page to see the slider assignments of the current program or setup.

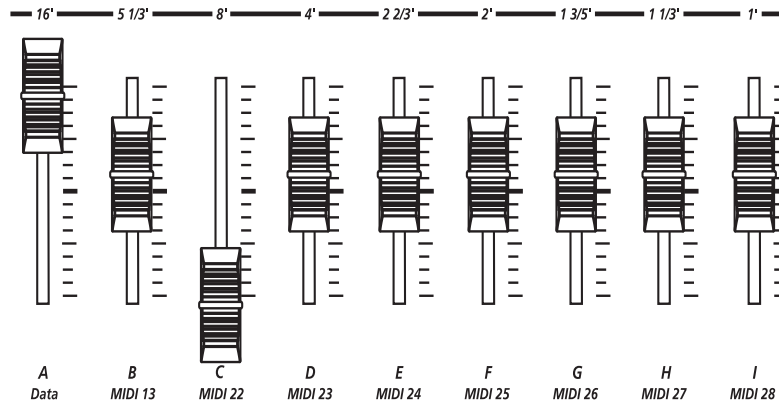

Most VAST programs use the sliders for these functions:

A	Data	Filter frequency, Brightness
B	MIDI 13	Filter resonance, Tremolo rate control
C	MIDI 22	Layer volume, Envelope control, Lo EQ
D	MIDI 23	Layer volume, Envelope control, Hi EQ
E	MIDI 24	Layer volume for thumps and release
F	MIDI 25	FX control 1
G	MIDI 26	FX distortion drive
H	MIDI 27	FX distortion warmth
I	MIDI 28	Reverb / delay control

Program and Category Buttons

Use the **Program** and **Category** buttons, in conjunction with the **Bank** buttons, to select PC3K programs by Bank type and instrument category. Each Bank contains 128 programs divided into 16 categories. Each of the 16 categories contains 8 programs.

To select a program, first press one of the **Bank** buttons (above the sliders on the left side of the front panel) to select a bank, then press a **Category** button and a **Program** button. The Category and Program buttons are on the front panel, between the screen and the alpha wheel.



*Note: The instrument names above the Category buttons are relevant for Banks 1 and 2 (**Base 1** and **Base 2**). For all other Banks, the Category buttons select a group of 8 programs to be selected by the Program buttons, but the group of programs may not match the instrument name of the selected Category button.*

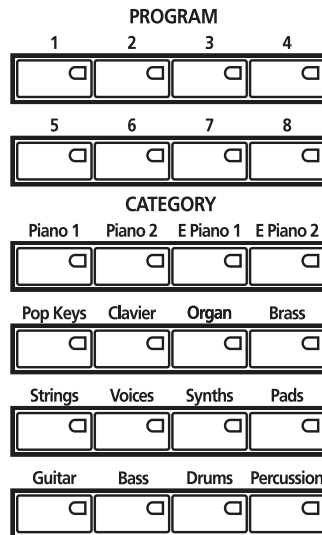

Picking favorites

When you select a program within a category, your selection will be remembered. For example, choose program 3 in the Organ category (press **Category: Organ**, then **Program: 3**). Now move to the strings by pressing the **Category: Strings** button. If you press the **Category: Organ** button again, you will be returned to program 3 in the Organ category. In this way, each category can have a “favorite” program.

You can make program selections within each category ahead of time. This way, you’ll be able to access the program you want in any category simply by pressing appropriate category button.

Important things to remember about your “favorites”:

- You must save your PC3K’s Master Table to remember your selections across power cycles. See Chapter 11 for information about the Master Table.
- Your selections are bank-dependent. In other words, you can save 16 in the Base 1 bank, 16 in the Exp 1 bank, etc.

Pitch Wheel and Mod Wheel

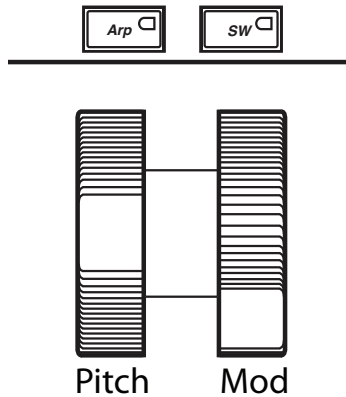

To the left of the PC3K's keyboard are the Pitch Wheel and the Mod Wheel, as well as the SW and Arp buttons.

Push the **Pitch Wheel** away from you to raise the pitch of the note(s) you are playing. Pull it towards you to lower the pitch. Most programs are set so that the pitch wheel will raise and lower pitch by a whole step, although some programs use the pitch wheel to lower pitch by as much as an octave. The Pitch Wheel has a spring so that it will snap back to place (i.e., back to the original pitch) when you release it.

The **Mod Wheel** performs a variety of functions. Different programs may use it for filter sweeps, tremolo/vibrato, wah, or layer volume.

The **Arp** button turns on and off the PC3K's Arpeggiator.

The **SW** button (MIDI 29) can be programmed to do a variety of things. Often it is used for layer enable or effect enable.

Navigation

The navigation section of the front panel consists of the display and the buttons surrounding it. These navigation buttons will take you to every one of the PC3K's programming parameters.

The Display

Your primary interface with the PC3K is its backlit graphic display. As you press various buttons, this fluorescent display reflects the commands you enter and the editing changes you make. The ample size of the display (240-by-64 *pixels*) enables you to view lots of information at one time.

Pages

Within each mode, the functions and parameters are organized into smaller, related groups that appear together in the display. Each one of these groups of parameters is called a *page*. Each mode has what we call an entry-level page; it's the page that appears when you select that mode with one of the mode buttons. Within each mode and its editor(s), the various pages are selected with the navigation buttons. There are many pages, but there are a few features common to each page.

The illustration below shows the entry-level page for Program mode.

ProgramMode	%PI0st	Base1s	#Ch:1
1-4/7 layers		1 Standard Grand	
Piano mp Left	∞	2 Studio Grand	
Piano mf Left	∞	3 RubensteinSWCom	
Piano f Left	∞	4 Horowitz Grand	
Rhoadz Thump		5 NYC Jazz Grand	
Octav-	Octav+	Panic	Info
		XPose-	XPose+

The Top Line

On the top line of most pages, there's a reminder of which mode you're in and which page you're on. Many pages display additional information in the top line, as well. The Program-mode page above, for example, shows you the current amount of MIDI transposition and the currently selected MIDI channel. The top line is almost always "reversed"—that is, it has a white background with blue characters.

The Bottom Line

The bottom line is divided into six (sometimes fewer) sets of reversed characters that serve as labels for the six buttons directly beneath the display. These labels—and the functions of the buttons—change depending on the currently selected page. Consequently the buttons that select these functions are called "soft" buttons.

The Soft Buttons

The soft buttons are called “soft” because their functions change depending on the currently selected mode and page. Sometimes they perform specific functions, like changing MIDI channels in Program mode. In the Program Editor and other editors, they’re also used to move to different pages of programming parameters. If a soft button’s label is in all capital letters (**KEYMAP**, for example), pressing the corresponding soft button takes you to a page of parameters. If the soft button is labeled in lower-case or mixed-case letters (**Save**, for example), the soft button performs some kind of function.

The Cursor Buttons

To the right of the display are four buttons arranged in a diamond fashion. These are called the cursor buttons. They move the cursor around the currently selected page, in the direction indicated by their labels. The cursor is a highlighted (reversed) rectangle (sometimes it’s an underscore). It marks the value of the currently selected parameter.

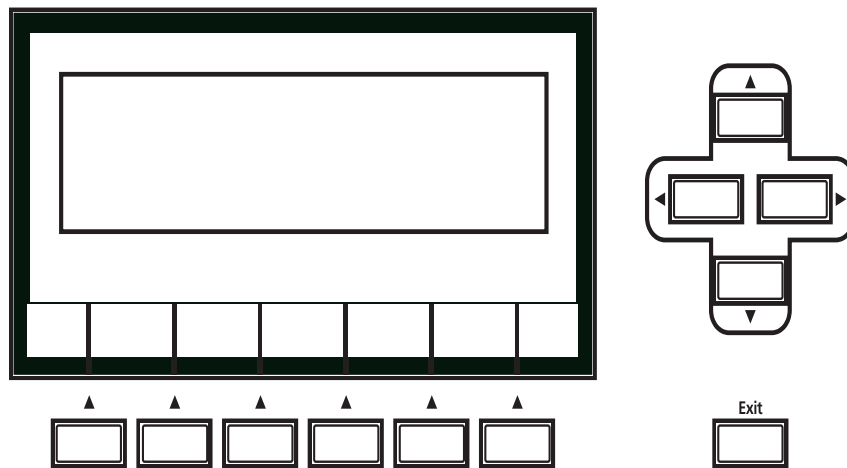

Programming the PC3K involves selecting various parameters and changing their values. Select parameters by highlighting their values with the cursor. You can change the highlighted value with any of the data entry methods described in the data entry section below.

The Chan/Layer Buttons

To the left of the display are two buttons labeled **Chan/Layer**. Their function depends on the current mode. In Program mode, for example, they shift through the MIDI channels, showing the program assigned to each channel. This changes the MIDI channel the PC3K uses internally, as well as the channel you’re using to send information to other synths connected to the PC3K’s MIDI Out port (MIDI slaves). Changing the current MIDI channel also changes the corresponding setting on the MIDI mode TRANSMIT page. When you press both **Chan/Layer** buttons at the same time you will be returned to Channel 1, Check out the chart on page 3-10 for more shortcuts you can make with double button presses.

When you’re in the Program Editor, the **Chan/Layer** buttons let you view each layer in the program. You can see the corresponding parameters in each layer by scrolling through the layers with these buttons. In the Setup Editor, the **Chan/Layer** buttons scroll through the zones in the current setup. In Quick Access mode, they scroll through the Quick Access banks, and in Song mode they scroll through recording tracks.

We’ll let you know, when applicable, what the **Chan/Layer** buttons do.

The Edit Button

The **Edit** button activates each of the PC3K's editors, and acts as a shortcut to many pages within the Program Editor. Pressing the **Edit** button tells the PC3K that you want to change some aspect of the object marked by the cursor. For example, when a program is selected and you press **Edit**, you enter the Program Editor. If a setup is selected, you enter the Setup Editor.

There are editors accessible from just about every operating mode. To enter an editor, choose one of the modes (mode selection), and press **Edit**. An editing page for that mode will appear. You can then select parameters (navigation) and change their values (data entry). If the value of the selected parameter has its own editing page, pressing the **Edit** button will take you to that page. For example, in the Program Editor, on the PITCH page, you might see **LFO1** assigned as the value for Pitch Control Source 1. If you select this parameter (the cursor will highlight its value—**LFO1** in this case), then press the **Edit** button, you'll jump to the page where you can edit the parameters of LFO1. Naturally, you can find every page in the current editor by using the soft buttons, but often it's easier to use the **Edit** button shortcut.

The Exit Button

Press **Exit** to leave the current editor. If you've changed the value of any parameter while in that editor, the PC3K will ask you whether you want to save your changes before you can leave the editor. See Chapter 5 for information on saving and naming. The **Exit** button also takes you to Program mode if you're on the entry level page of one of the other modes. If at some point you can't seem to get where you want to go, press **Exit** one or more times to return to Program mode, then try again.

Data Entry

The data entry section of the front panel includes the Alpha wheel, the **Plus/Minus** buttons, and the 14-button alphanumeric pad.

The Alpha Wheel

The Alpha Wheel is especially useful because it can quickly enter large or small changes in value. If you turn the Alpha Wheel one click to the right, you'll increase the value of the currently selected parameter by one increment. One click to the left decreases the value by one increment. If you turn it rapidly, you'll jump by several increments. You can also use the Alpha Wheel to enter names when you're saving objects.

The Plus/Minus Buttons

These buttons are located just under the Alpha Wheel. The **Plus** button increases the value of the currently selected parameter by one, and the **Minus** button decreases it by one. These buttons are most useful when you're scrolling through a short list of values, or when you want to be sure you're changing the value by one increment at a time. One press of the **Plus** or **Minus** button corresponds to one click to the right or left with the Alpha Wheel. These buttons will repeat if pressed and held.

Pressing the **Plus** and **Minus** buttons simultaneously will move you through the current list of values in large chunks instead of one by one. Don't confuse these buttons with the +/- button on the alphanumeric pad. This button is used primarily for entering negative numeric values and switching from uppercase to lowercase letters (and vice versa).

The Alphanumeric Pad

As its name implies, this set of 14 buttons lets you enter numeric values, and to enter names one character at a time. Depending on where you are, the PC3K automatically enters letters or numerals as appropriate (you don't have to select between alphabetic or numeric entry).

When you're entering numeric values, press the corresponding numeric buttons, ignoring decimal places if any (to enter 1.16, for example, press **1, 1, 6, Enter**). The display will reflect your entries, but the value won't actually change until you press **Enter**. Before pressing **Enter**, you can return to the original value by pressing **Cancel**. Pressing **Clear** is the same as pressing **0** without pressing **Enter**.

When entering names, you can use the **Left/Right** cursor buttons or the <<</>>> soft buttons to move the cursor to the character you want to change. Use the labels under the alphanumeric buttons as a guide to character entry. Press the corresponding button one or more times to insert the desired character above the cursor. The **Cancel** button is equivalent to the >>> soft button, and **Enter** is the same as **OK**. The **Clear** button replaces the currently selected character with a space. The +/- button *toggles* between uppercase and lowercase letters.

There's also a convenient feature called keyboard naming, which lets you use the keyboard to enter characters in names. See page 5-5.

Double Button Presses

Pressing two or more related buttons simultaneously executes a number of special functions depending on the currently selected mode. Make sure to press them at exactly the same time.

In this mode or editor...	...pressing these buttons simultaneously...	...does this:
Program mode	ARP, SW	Brings up quick arpeggiator configuration page.
	Octav-, Octav+	Reset MIDI transposition to 0 semitones. Double-press again to go to previous transposition.
	Chan/Layer	Set current MIDI channel to 1. Sets layer 1 in Program editor.
	Plus/Minus	Step to next Program bank (increments of 128).
	Up/Down cursor buttons	Starts playback of demo song for current Program. Stop with Stop transport button.
	Left/Right cursor buttons	Brings up the TEMPO page.
Setup mode	Plus/Minus	Moves through list of Setups in increments of 128.
	Chan/Layer	Set zone 1.
	Left/Right cursor buttons	Brings up the TEMPO page.
Song mode	Up/Down cursor buttons	Toggle between Play and Stop.
	Chan/Layer	Select all tracks on any TRACK page in Song Editor.
	Left/Right cursor buttons	Brings up the TEMPO page.
Storage mode	Left/Right cursor buttons	Select all items in a list. Move cursor to end of name in naming dialog.
	up/down cursor buttons	Clear all selections in a list. Move cursor to beginning of name in naming dialog.
Program Editor	Chan/Layer	Select Layer 1.
Any Editor	Plus/Minus	Scroll through the currently selected parameter's list of values in regular or logical increments (varies with each parameter).
	2 leftmost soft buttons	Reset MIDI transposition to 0 semitones. Double-press again to go to previous transposition.
	Center soft buttons	Select Utilities menu.
	2 rightmost soft buttons	Reset MIDI transposition to 0 semitones. Double-press again to go to previous transposition.
	Left/Right cursor buttons	Display the TEMPO page.
	Up/Down cursor buttons	Toggle between Play and Stop of current song.
	Cancel/Enter	Panic (sends all notes/controllers off message on all 16 channels).
Save Dialog	Plus/Minus buttons	Toggle between next free ID and original ID.
Rename Dialog	Plus/Minus buttons	Moves cursor to the end of the name.
	Left/Right cursor buttons	Moves cursor to the end of the name.

Intuitive Data Entry

Many parameters have values that correspond to standard physical controllers. In many cases, you can select these values “intuitively,” rather than having to scroll through the *Control Source* list. Do this by selecting the desired parameter, then holding the ENTER button while moving the desired physical control.

For example, on the LAYER page in the Program Editor, you can set the range of the currently selected layer as follows: use the cursor buttons to move the cursor to the value for the LoKey parameter, press (and hold) the **Enter** button, then press the note you wish to be the lowest note for the currently displayed layer. The note you triggered will appear as the value for the LoKey parameter. Repeat the process for the HiKey parameter.

Another example: select Program 199 while in Program mode. Press **Edit** to enter the Program Editor. Press the PITCH soft button to select the PITCH page. Move the cursor to the Src1 parameter. Hold the **Enter** button, and move the Pitch Wheel. **PWheel** will be selected as the value for Src1.

You can also use the keyboard to choose control sources, since most key numbers correspond to a value on the control source list. If you have a certain control source that you use over and over (for example, LFO1), this can be the quickest way to enter its value. To do this: highlight a parameter which uses a value from the control source list, hold down **Enter**, then strike the key corresponding to the control source you want to choose. LFO1, for example, is assigned to B5.

Also, for almost every parameter, you can hold the **Enter** button and move the Data Slider (Slider A) to run through the range of values for the currently selected parameter. This is not as precise as the Alpha Wheel, but much faster.

Changing the Current Layer in Multi-Layer Programs

When editing a multi-layer program, you can quickly switch between layers by holding the **Enter** button, then striking a key. The PC3K will change the current layer to that key’s layer. If the key is part of more than one layer, subsequent key strikes will cycle through each layer that has that key in its range.



***Note:** This method for changing the current layer in a multi-layer program will NOT work if the currently highlighted parameter has a note number or control source for its value. In this case, the key you strike will function as described in Intuitive Data Entry, above.*

Search

There's a convenient way to find any string of characters within the currently selected list, or range of values. Hold the **Enter** button and press any of the numeric buttons. A *dialog* appears.

Type in the string of characters you want to find. For example, if you're looking at the program list and you want to find all programs containing the word "Horn," you would type h-o-r-n. This function is not case-sensitive; it will find upper and lower case characters regardless of what you type.

When you've typed the string of characters you want to find, press **Enter**. The PC3K searches through the current list of objects or values, finds all items that match the string of characters you typed, and displays the first one it finds. Hold **Enter** and press one of the **Plus/Minus** buttons to search for the next higher- or lower-numbered object that contains the string of characters.

The string you select remains in memory. You can store and select a string of characters with each of the numeric buttons. Hold **Enter** and press one of the numeric buttons at any time to select that string for a search. When the string appears, you can change it, or just press **Enter** to find that string.

Quick Song Recording and Playback

There are three buttons—labeled **Record**, **Play/Pause**, and **Stop**—below the mode selection buttons. They control the recording and playback of songs from any mode; you don't have to be in Song mode to record or play back. However, you'll need to make sure that the Demo Button parameter on Master Mode Page 2 is set to "Off." Otherwise these buttons are used for Easy Audition (see page 2-7). Master Mode is described in Chapter 11.



Using these buttons affects the current track of the current song—that is, the song and track that were selected the last time you were in Song mode. When you record, the recording track and recording mode are determined by the current settings in Song mode; likewise for the playback mode when you're playing a song.

When the sequencer status is STOPPED (neither the **Record**-button LED nor the **Play/Pause**-button LED is lit or flashing), press **Record** to put the sequencer in REC READY status. The **Record**-button LED lights (red). Then press **Play/Pause** to start recording. The **Play/Pause**-button flashes (green) to indicate the tempo. Any countoff is determined by the current Song-mode setting for the CountOff parameter. Press **Play/Pause** or **Stop** to end recording and go to the Save dialog, where you can save the song, or discard it.

When the sequencer status is STOPPED, press **Play/Pause** to begin playing the current song. Press **Play/Pause** again to pause playback, and again to resume. Press **Stop** to end playback.

See Chapter 12 for more information on Song Mode.

Chapter 4

The Operating Modes

In this chapter we'll discuss the theory behind the mode concept, and we'll describe the basic operating features of each mode.

What the Modes Are

The modes exist to make the PC3K logical to work with. With as many performance and programming features as the PC3K has, it's helpful to break them into groups. These groups are called modes. There are eight primary modes; they're described briefly in the section called *Using the Modes* on page 4-2, then the rest of the manual is dedicated to explaining each primary mode in turn.

Each mode is named for the kind of operations you perform while in that mode, and each mode's editor (if any) contains all of the parameters related to editing the type of *object* found in that mode. In Setup mode, for example, you select setups (and only setups) for performance or editing. All of the setup-editing parameters are grouped together on the Setup-Editor page, which is accessible through Setup mode.

Selecting Modes

When the PC3K is on, it's always operating in one of the eight primary modes represented by the LED-highlighted buttons to the left of the display—or in one of the editors corresponding to the current operating mode. Pressing one of the mode buttons selects the corresponding mode. This is the mode's entry level. At the entry level, the LED of the selected mode is lit. Only one mode can be selected at a time.

From any primary mode, you can get to any other primary mode simply by pressing one of the mode buttons. If you're in an editor, however, you must press **Exit** to return to the mode's entry level before selecting another mode.

All of the modes except Storage mode give you access to one or more editors for changing the values of the parameters within that mode. Press the **Edit** button to enter the editor of the currently selected mode. When you do this, the mode LED goes out.

It's possible to enter another mode's editor without leaving the currently selected mode. For example, if you press **Edit** while in Setup mode, you'll enter the Setup Editor. The Setup-Editor page will appear, and the Program parameter will be highlighted by the cursor. If you press **Edit** again, you'll enter the Program Editor, where you can edit the currently selected program. While you can edit and save programs as you normally would, you're still in Setup mode, and you can't select another mode at this point. When you exit the Program Editor, you'll return to the Setup Editor page. Press **Exit** again, and you'll leave the Setup Editor, returning to the Setup mode page.

The Operating Modes

Using the Modes

The following table lists the procedures for moving between modes and editors. Note that the **Exit** button won't always take you where the table says it will; it often depends on how you got where you are. The table assumes that you've entered a given editor via its corresponding mode. You'll always return to Program mode eventually if you press **Exit** repeatedly.

Current Mode/ Editor Status	Available Modes/ Editors	How to Get There
Any mode	All other modes	Press corresponding mode button
Program mode	Program Editor	Press Edit
Program Editor	Program mode	Press Exit
	Effects Editor	On PROGFX page, select Insert, then press Edit
Setup mode	Setup Editor	Press Edit
Setup Editor	Setup mode	Press Exit
	Program Editor	On CH/PRG page: select LocalPrg parameter; press Edit
Quick Access mode	Quick Access Editor	Press Edit
Quick Access Editor	Quick Access mode	Press Exit
Song mode	Song Editor	Select CurSong parameter; press Edit
	Program Editor	Select Program parameter; press Edit
Most editors	Previous mode or editor	Press Exit

Finding Square One

If, at any time, you don't know where you are, and the mode LEDs are all unlit, press **Exit** one or more times. This will return you to the entry level of whatever mode you were in, and if you press **Exit** enough times, you will always return to Program mode, the startup mode. If you've made any changes, you'll be asked whether you want to save before leaving any editor. Press the **No** soft button or the **Exit** button if you don't want to save. If you want to save, press the **Rename** or **Yes** soft button, and you'll see the Save dialog, which is described in *Saving and Naming* on page 5-3.

Using the Modes

You can play your PC3K regardless of the mode you're in. The PC3K's MIDI response is almost always active. Even so there are three modes that are more performance-oriented than the others. These are Program, Setup, and Quick Access modes. We'll describe each of the eight modes briefly in this section.

Program Mode

The PC3K starts up in Program mode, where you can select, play, and edit programs. The Program mode entry-level page shows the currently selected program, as well as a small segment of the program list.

The Program Editor takes you to the core of the PC3K's sound editing parameters.

Setup Mode

Setup mode lets you select, play, and edit setups. Setups consist of up to 16 separate zones, split or overlapping, each having its own program, MIDI channel, and control parameters. Setups are great for performance situations, whether you're playing multiple PC3K programs or controlling additional synths connected to the PC3K's MIDI Out port. Chapter 7 describes Setup mode.

If you're using a different MIDI controller, you can make use of Setup mode even if your MIDI controller can transmit on only one MIDI channel at a time. To do this, go to the RECEIVE page in MIDI mode (by pressing the **RECV** soft button while in MIDI mode), and set the Local Keyboard Channel parameter to a value that matches the transmit channel of your MIDI controller. When you select Setup mode, the PC3K will interpret incoming MIDI information according to the settings for the currently selected setup. See the discussion of the Local Keyboard Channel parameter in Chapter 10 for details.

Quick Access Mode

Another feature for live performance, Quick Access mode enables you to combine programs and setups into banks of ten entries. Each of these programs or setups can be selected with a single alphanumeric button. Different banks are selected with the **Chan/Layer** buttons. There's a selection of factory preset banks, and you can use the Quick Access Editor to create your own banks and store them in the PC3K's memory. There's a full description in Chapter 8.

You can also use Quick Access banks as a way to remap incoming or outgoing Program Change commands.

Effects Mode

Effects mode sets the behavior of the PC3K's effects processor. The Effects mode page lets you tell the PC3K how to select effects configurations called chains. Chapter 9 shows you how.

MIDI Mode

You'll use MIDI mode to configure the PC3K's interaction with other MIDI instruments, by setting parameters for transmitting and receiving MIDI. You'll also use it to configure your PC3K for multi-timbral sequencing. On the CHANNELS page, you can assign a program to each channel, and enable or disable each channel's response to three types of MIDI control messages: Program Change, volume and pan. See Chapter 10.

Master Mode

Master mode, described in Chapter 11, contains the parameters that control the entire PC3K. Global settings for tuning, transposition, velocity and aftertouch sensitivity, and other preferences are adjusted here. You can also get to GM Mode from here and set the sample rate for the PC3K's digital output.

Song Mode

Song mode enables you to play sequences (songs) stored in the PC3K's memory, and provides a fully featured sequencer that you can use to record songs. You can also record multi-timbrally via MIDI, or load standard MIDI files (Type 0 or 1). The Song Editor also enables you to modify existing sequences stored in memory. See Chapter 12.

Storage Mode

Storage mode lets you load and save programs and other objects using an USB device. See Chapter 13.

The Operating Modes

Using the Modes

Chapter 5

Editing Conventions

Introduction to Editing

Programming (editing) the PC3K always involves three basic operations: mode selection, navigation, and data entry.

First, select the mode that relates to the object you want to edit—a program, a setup, etc. Then select the object you want to edit, and press the **Edit** button to enter the editor within that mode. For programs, setups, songs, and quick access banks, these objects are “selected” when you are on the main page of their corresponding mode. In these cases you can press the **Edit** button with anything selected on their main page to access their editor. Often there will be more objects inside of these “main page” editors, such as shift patterns and velocity patterns, and they can be edited by selecting their parameter with the cursor and pressing the **Edit** button. An editor contains all the parameters that define the object you’re programming.

Next, you navigate around the editor’s page(s) with the soft buttons, and select parameters with the cursor (arrow) buttons. When you’ve selected a parameter (its value is highlighted by the cursor), you can change its value with one of the data entry methods. When you change a value, you’ll normally hear its effect on the object you’re editing. The PC3K doesn’t actually write your editing changes to memory until you save the object you’re working on. It then allows you to choose between writing over the original object, or storing the newly edited version in a new memory location.

What’s an Object?

If you’ve been wondering what we mean by the term “object,” it’s an expression we use for anything that can be named, saved, deleted, or edited. Here’s a list of all the types of objects:

Programs	Factory-preset or user-programmed sounds stored in ROM or flash memory. A program is one or more layers of sound, with programmable DSP functions applied to the keymaps within each layer.
Algorithms	Factory-preset or user-programmed routing (virtual wiring) for V.A.S.T. DSP Functions.
Setups	Factory-preset or user-programmed MIDI performance presets consisting of up to 16 zones, each with its own program, MIDI channel, and controller assignments, and (optionally) arpeggiation specifications.
Songs	Sequence files loaded into memory, or MIDI data recorded in Song mode.
Chains	Factory-preset or user-programmed configurations of the PC3K’s onboard digital audio effects processor.
Quick Access banks	Factory-preset or user-programmed banks of ten entries each, that store programs and setups for single-button access in Quick Access mode.
Intonation maps	Factory-preset or user-programmed pitch offsets for each note in all octaves. Set from master mode, intonation maps are used to change the PC3K’s intonation in all modes.

- Shift patterns** Factory-preset or user-programmed sequences of note shift information, used by the arpeggiator for detailed arpeggiations, or by the Shift Key Number controller destination.
- Velocity patterns** Factory-preset or user-programmed sequences of note velocity shift information, used by the arpeggiator for detailed velocity triggering in arpeggiation.
- Master tables** The values that are set for the parameters in Master mode, as well as the settings for the parameters on the Transmit, Receive, and Channels pages in MIDI mode, and the programs currently assigned to each MIDI channel.

Object Type and ID

The PC3K stores its objects in memory using a system of ID numbers that are generally organized into banks. Each object is identified by its object type and object ID; these make it unique. An object's type is simply the kind of object it is, whether it's a program, setup, song, or whatever. The object ID is a number from 1 to the maximum that distinguishes each object from other objects of the same type. For example, within a bank you can have a setup, a program, and an effect, all with ID 201; their object types distinguish them. You can't, however, have two *programs* with ID 201.

Object Type	Object ID	Object Name
Program	201	Hot Keys
Setup	404	Silicon Bebop
Velocity Map	1	Linear

ROM (factory preset) objects have ID numbers in a number of banks. When you save objects that you've edited, the PC3K will ask you to assign an ID. If the original object was a ROM object, the PC3K will suggest the first available ID in the User Bank (starting at 1025). If the original object was a memory object, you'll have the option of saving to an unused ID, or replacing the original object. Double press the - and + buttons (beneath the alpha wheel) to select the next available user location.

Objects of different types can have the same ID, but objects of the same type must have different IDs to be kept separate. When you're saving an object that you've edited, you can replace an existing object of the same type by giving it the same ID. The object you are replacing will be deleted permanently. There is one exception to this: If you write over a ROM object (factory preset,) you can always revert to the original factory ROM object by deleting you new object that uses the ID. The object that you had replaced the ROM object with will be permanently deleted, and the original ROM object will appear in its place.

Many parameters have objects as their values—for example, the Intonation parameter in Master mode. In this case, the object's ID appears in the value field along with the object's name. You can enter objects as values by entering their IDs with the alphanumeric pad. This is especially convenient for programs, since their ID numbers are usually the same as their MIDI program change numbers.

The object type and ID enable you to store hundreds of objects without losing track of them, and also to load files from storage without having to replace files you've already loaded.

Saving and Naming

When you've edited an object to your satisfaction, you'll want to store it in memory. There's a standard procedure for saving and naming, which applies to all objects. You can press the **Save** soft button, of course, but it's easier to press the **Exit** button, which means "I want to leave the current editor." If you haven't actually changed anything while in the editor, you'll simply exit to the mode you started from. If you *have* made changes, however, the PC3K will ask you if you want to save those changes. This is the first Save dialog, the Exit page. Press **Cancel** to resume editing, **No** to exit the editor, or **Yes** to save your edits and move to the Save page.

The **Rename** soft button on the Save page takes you immediately to the naming dialog, where you assign a name to the object you're saving. You haven't saved yet, but you'll be able to after you've named the program.

The cursor underlines the currently selected character. Press the <<< or >>> soft buttons to move the cursor without changing characters. Press an alphanumeric button one or more times to enter a character above the cursor. The characters that correspond to the alphanumeric buttons are labeled under each button. If the character that appears is not the one you want, press the button again. Press the +/- button on the alphanumeric pad to switch between upper and lower case characters.

Press **0** one or more times to enter the numerals 0 through 9. Press **Clear** (on the alphanumeric pad) to erase the selected character without moving any other characters. Press the **Delete** soft button to erase the selected character. All characters to the right of the cursor will move one space left. Press the **Insert** soft button to insert a space above the cursor, moving all characters to the right of the cursor one space to the right.

Press the **Cancel** soft button if you decide not to name the object. Press **OK** when the name is set the way you want to save it.

In addition to the letters and numerals, there are three sets of punctuation characters. The easiest way to get to them is to press one of the alphanumeric buttons to select a character close to the one you want, then scroll to it with the Alpha Wheel. Here's the whole list:

! " # \$ % & ' () * + , - . / 0 1 2 3 4 5 6 7 8 9

: ; < = > ? @ A through Z

[\] ^ _ ` a through z. (space).

Pressing the **Plus/Minus** buttons simultaneously is a short cut to the following characters: **0, A, a** and (space).

If you're wondering how we came up with this sequence of characters, it's composed of ASCII characters 33 through 122.

When you press **OK**, the final Save dialog appears, where you assign an ID to the edited object. If you change your mind about the name, press the **Rename** soft button for another try.



Note: For an additional naming method, see *Keyboard Naming* below.

ROM Objects

If the object you started from was a ROM (factory preset) object, the PC3K will automatically suggest the next available (unused) ID as the ID for the edited object. If that's the ID you want, press the **Save** soft button, and the object will be stored in memory with that ID. Otherwise, you can select any ID from 1 to the maximum. This page also gives you the opportunity to return to the naming dialog (as described in the previous section) or, by pressing the **Object** soft button, to access the Object Utilities (see *The Utilities (UTILS) Page* on page 13-14).

If you select an ID that's already in use, the PC3K will tell you that you're going to replace the ROM object that's already been assigned that ID. If you don't want to do that, you can select a different ID. Or you can press the **Plus/Minus** buttons simultaneously to toggle between the ID that the PC3K suggested and the original ID. Or press the **Cancel** soft button to cancel the operation.

If you decide not to cancel or change the ID, and you press the **Replace** soft button, the PC3K will write your newly edited object over the existing ROM object. Actually, it only appears that way, since you can't truly write to ROM. The ROM object will reappear if you delete the newly edited object (there are soft buttons in each editor for deleting objects).

Memory Objects

If the original object was a memory object, the PC3K will assume you want to replace it, and will suggest the same ID as the original object. (In all modes other than Song mode, a diamond icon preceding an item's ID indicates a memory object). As with ROM objects, you can cancel, replace, or change the ID and save to an unused ID. If you replace a memory object, however, it's definitely gone!

Keyboard Naming

The keyboard naming feature makes naming objects convenient, by letting you use the keyboard (or your MIDI controller) to enter the name of the object you're modifying.

When you're in a Rename dialog, use either of the **Chan/Layer** buttons to change between the keyboard naming states: **Off** (disabled), **On**, and **Adv** (Advance).

When set to **On** or **Adv**, the keys (MIDI note numbers, actually) correspond to all the characters shown on page 5-3. There are also equivalents to the cursor movement, insertion, deletion, and **OK (Enter)** buttons.

On requires you to move the cursor to enter each letter, just as you have to do when using the normal data entry methods for naming. **Adv** automatically moves the cursor one space to the right each time you strike a key, just like a typewriter or computer keyboard. This is the most convenient setting.

A0 to C8
(Standard 88-note Keyboard)

	A0	
Move cursor to start of name	C2	Delete; move characters left one space
Move cursor left one space		Insert; move characters right one space
Move cursor right one space		
(Shift)		1 !
(Space)		2 @
a A		3 #
b B		
c C	C3	4 \$
d D		5 %
e E		
f F		6 ^
g G		7 &
h H		8 *
i I		
j J	C4	9 (
k K		0 (zero))
l L		
m M		- (Hyphen) _ (Underscore)
n N		= (Equals) +
o O		(Backspace)
p P		
q Q	C5	:(Semicolon) :(Colon)
r R		' (Apostrophe) " (Quote)
s S		
t T		, (Comma) <
u U		. (Period) >
v V		/ (Slash) ?
w W		
x X	C6	[(Left bracket) ` (Back quote)
y Y] (Right bracket) \ (Backslash)
z Z		
(Space)		(OK, Enter)
(Shift)		
Move cursor left one space		Delete; move characters left one space
Move cursor right one space		Insert; move characters right one space
Move cursor to end of name	C7	
	C8	

Use the (Shift) keys or Sustain pedal to enter upper-case and special characters

Deleting Objects

Within most editors, there are soft buttons for deleting objects. When you want to delete an object, press the **Delete** soft button, and the PC3K will ask you if you want to delete the object. (At this point in the dialog, you can select another object with any of the data entry methods.) Press **OK** if you want to delete it, or press **Cancel** if you don't. The PC3K won't let you delete ROM objects (also known as "factory" objects).

Memory objects, on the other hand, are *gone* when you delete them! If you've "replaced" a ROM object by saving a memory object with the same ID, the ROM object is invisible, but still there. Deleting the memory object stored at the same ID will restore the ROM object.

You'll often delete objects to gain memory space, or to organize the *memory banks* before saving objects to storage. To delete multiple objects, use the Delete Objects utility available in Master mode. It's described on page 11-14.

Dependent Objects

A dependent object is an object that's linked in memory with at least one other object. For example, if you create a setup that uses a program that you also created, that program is a dependent object of the setup.

When you start to delete an object that has dependent objects, the Delete dialog gives you a choice: Delete dependent objects? If you press **Yes**, the PC3K will delete the object and all its dependent objects when you execute the Delete function. In our example, if you were deleting the setup you created, and you chose to delete dependent objects, the dependent program would get deleted as well. If you press **No** at the Delete dependent objects? prompt, the PC3K deletes only the object, but keeps the dependent objects. In our example, the setup would get deleted, but the dependent program would remain.

When deleting objects and their dependents, the PC3K deletes only those dependent objects that aren't dependent on other objects that you're *not* deleting. For example, suppose you have two setups that contain the same program. If you delete one of the setups, and delete dependent objects with it, the setup gets deleted, but the program that's contained in the other setup remains in memory.

Saving and Loading Files—Storage Mode

Saving a file simply involves selecting objects or a complete bank of objects to be stored as a single file. All objects with IDs within that range will be saved to the file. When you *load* a file, the PC3K asks you which bank will receive the file. You can load a file into any of the sixteen banks, regardless of the bank it was saved from. The PC3K will automatically reassign the object IDs.

See Chapter 13 for more information on loading and saving files.

Special Button Functions

The Mode buttons and the **Chan/Layer** buttons have additional functions, depending on the mode or editor you're in. The table below describes some of these special button functions.

Button	Special Function
Program Mute 1	Mutes Layer 1 of current program in Program Editor.
Setup Mute 3	Mutes Layer 3 of current program in Program Editor.
Q Access Solo	Solos current layer in Program Editor.
Effects FX Bypass	In Program Editor, bypasses (mutes) current program's FX preset (plays program dry.) In Chain Editor, mutes/unmutes currently selected effects box, and the Effect Mode button's LED will light when a muted effects box is selected, and unlight when an unmuted effects box is selected.
MIDI Mute 2	Mutes Layer 2 of current program in Program Editor.
Master Mute 4	Mutes Layer 4 of current program in Program Editor.
Song Mute Active	Mutes active layer of current program in Program Editor.
Storage Compare	Negates effect of unsaved edits and plays last-saved (unedited) version of object being edited in Program Editor.
Chan / Layer	In Program Editor, these two buttons scroll through layers of current program; in Setup Editor, scroll through zones of current setup; in Quick Access mode, scroll through entries in current Quick Access bank; In Song Mode, change recording track.
Edit	Whenever cursor is highlighting an editable object or parameter, takes you to corresponding editor or programming page

Editing Conventions

Special Button Functions

Chapter 6

Program Mode

Programs are the PC3K's performance-level sound objects. They're preset sounds equivalent to the patches, presets, voices, or multis that you find on other synths.

Program mode is the heart of the PC3K, where you select programs for performance and editing. The PC3K is packed with great sounds, but it's also a synthesizer of truly amazing depth and flexibility. When you're ready to start tweaking sounds, the Program Editor is the place to start.

The PC3K offers two new powerful editing features: **Cascade Mode** and **Dynamic VAST**.

- **Cascade Mode** lets you route any layer of a program into the DSP of any other layer. Any of the 32 layers of a program can go into any other layer.
- **Dynamic VAST** lets you "wire" your own algorithms. You can combine different DSP functions in any order you like, including parallel and serial configurations.

The Program Mode Page



The top line of the Program mode entry-level page shows your mode location, the current MIDI transposition, the MIDI bank name and MIDI program number of the highlighted program, and the current MIDI channel.

Selecting Programs

When you are in Program mode, there are three basic ways to select a PC3K program:

- Press one of the **Bank** buttons (above the sliders on the left side of the front panel) to select a bank, then press a **Category** button and a **Program** button to choose within the bank. The Category and Program buttons are on the front panel, between the screen and the alpha wheel. (See *Program and Category Buttons* on page 3-4 for more details.)
- Type the program's ID (number) on the alphanumeric buttonpad, then press **Enter**. If you make a mistake, press **Clear**, then start over.
- Scroll through the list using the Alpha Wheel, the **Plus** or **Minus** button under the Alpha Wheel, or the cursor buttons (the arrow buttons to the right of the display).

The Soft Buttons in Program Mode

Use the **Octav-** and **Octav+** soft buttons to transpose up or down by a full octave. Pressing both **Octav** buttons simultaneously returns the transposition to its original setting.

Pressing the **Panic** soft button sends an All Notes Off message and an All Controllers Off message on all 16 MIDI channels.

Press the **Info** soft button to see all of the controller assignments of the current program. Scroll down the page using the Alpha Wheel or the **Plus/Minus** buttons.

The **Xpose-/Xpose+** buttons are a shortcut for quick transposition in semitone (half step) increments. You can use them to transpose the entire PC3K as much as three octaves up or down. The top line of the display shows the current amount of transposition (Xpose). Pressing both **Xpose** buttons simultaneously returns the transposition to zero. The **Xpose** buttons transpose the PC3K, as well as any MIDI devices connected to the PC3K's MIDI Out port. Changing the transposition with the soft buttons also changes the corresponding setting on the MIDI mode TRANSMIT page.

The Info Box

The info box at the left of the Program mode page gives you information about the current program. Generally, the info box shows the keymap assigned to each layer (*for KB3 programs, the info box shows the keymap used for the upper tone wheels.*) The line beneath the name of the keymap indicates the keyboard range of that layer. In the diagram above, for example, there's one layer that extends from C 0 to C 8—the default range. The representation of these layer ranges is approximate; they're intended to let you know if you have a layered keyboard (lines overlapping) or a split keyboard (lines not overlapping). Stereo keymap layers are indicated in the info box with a double circle symbol. The info box can display up to four layers at a time. If the current program has more than four layers, you can view their keymaps by pressing and holding down the **Enter** button and scrolling with the **Chan/Layer** buttons.



***Note:** For VAST layers using KVA oscillators, the info box may or may not show the name of the oscillator being used. See *Advanced Use Of KVA Oscillators* on page 6-55 for more details.*

The info box can also be set to show the assignment and current MIDI CC value for the last moved controller, see *Display* on page 11-3 for details.

Controllers Assignments For Factory ROM Programs

Many of the programs included with the PC3K (factory ROM programs) can be controlled by using the PC3K's physical controllers (sliders, wheels, switches, pedals, etc.) Press the **Info** soft button to see all of the controller assignments of the current program. Here is a list of controllers and their commonly assigned program parameters:

- **Slider I** (MIDI 28) - Slider I usually controls the program's send level to an Aux effect (usually reverb or delay.) In this case, use slider I to control the reverb or delay level.
- **SW Switch** - The SW switch often enables a layer (like strings for piano program) or an effect.
- **Mod Wheel** - The Mod Wheel often works with the parameter assigned to the SW switch and controls the level of a layer or the level or intensity of an effect such as tremolo, vibrato, or wah.
- **Sliders A-H** - Sliders A and B often control filter or EQ parameters that change the "brightness" of the program. Sliders C through H usually control parameters specific to the current programs amplitude envelopes, layer volumes, and insert effect parameters. Press the **Info** soft button to see all of the controller assignments of the current program.

See *Assigning Program Parameters to Control Sources* on page 6-13 for details on making your own controller assignments.

Saving Controller Settings in Program Mode

Many programs have parameters assigned to the PC3K's sliders, mod wheel, and the SW button above the mod wheel. You can change the settings of these controllers to change the sound of the current program. If you switch to a different program, the alterations that you made to the previous program will be lost without warning.

To save a program with its current controller settings, you must save entry values for the controllers. Entry values are values sent for each controller setting when a program is loaded. To capture entry values for the current program, press the **Edit** button to the left of the display to enter the Program Editor. Next, use the **more** soft buttons to find the **SetCtl** soft button, then press the **SetCtl** soft button. Lastly, press the **Exit** button to the right of the display and follow the prompt to choose an ID# and save the program.

Similarly, when using a KB3 program, you can capture the entry values for the drawbars (the sliders) by pressing the **SetDBR** soft button in the KB3 program editor.

The Arpeggiator In Program Mode

In Program Mode, you can use an arpeggiator for the Program on the currently selected MIDI channel. The arpeggiator can be turned on and off by pressing the **Arp** button above the wheels (so long as the default Control Setup is being used, see Control Setup below for details.)

To access the arpeggiator parameters, press the **Arp** and **SW** buttons (above the wheels) simultaneously. See *The ARPEGGIATOR Page* on page 7-42 for details on the arpeggiator parameters. The arpeggiator plays at the tempo set on the TEMPO page. Press the left and right cursor buttons simultaneously to view the TEMPO page (see TEMPO on page 11-11 for details.)

In Program Mode, you can change the program on the current MIDI channel, or change the current MIDI channel, and the current arpeggiator settings will remain the same. If you enter Setup Mode and then return to Program Mode, the arpeggiator in Program Mode will be returned to its default settings. The default settings for the arpeggiator in Program Mode are set on Zone 1 of the Control Setup (see Control Setup below for details.)



Note: Settings for the arpeggiator in Program Mode are not saved with each program. Settings for the arpeggiator in Program Mode can only be saved by editing arpeggiator settings for Zone 1 of the Control Setup. Because arpeggiator settings are not saved with each program, Setup Mode should be used when you wish to save a program with specific arpeggiator settings. A Setup can contain up to 16 programs, each with their own arpeggiator settings (see Chapter 7, Setup Mode for details.)

MIDI Channels

To select a MIDI channel to use in Program mode, use the **Chan/Layer** buttons at the left of the display. The current MIDI channel is displayed in the top right corner of the Program mode main page. Notes played on the PC3 keyboard are sent to the MIDI out port on the currently selected MIDI channel. For basic use of Program mode (playing a single Program,) the MIDI channel can usually be ignored. For multitimbral use of Program mode (playing multiple different programs at once,) select each MIDI channel then select a Program for each. In Program mode, when sending MIDI data to the PC3 from an external MIDI device, the PC3 can play up to 16 different programs at once (one on each MIDI channel.) See *Save* on page 11-18 for details on saving the Program selection for each channel. For more advanced multitimbral features and easier saving and recalling of multitimbral program selections, see Chapter 7, Setup Mode, and Chapter 12, Song Mode and the Song Editor.

VAST and KB3 Programs

It is important to understand the difference between VAST programs and KB3 programs.

VAST programs contain up to 32 layers, each of which contains a keymap or KVA oscillator. Keymaps consists of a number of samples assigned to a particular keyboard range. KVA oscillators use powerful DSP to generate a range of simple and complex waveforms (see *Editing VAST Programs With KVA Oscillators* on page 6-53 for more details.) See *VAST Program Structure* below for more details on VAST programs.

KB3 programs use a much different architecture. There are no layers or algorithms, just a set of oscillators (designed to emulate the tonewheels in a Hammond Organ) that start running as soon as you select a KB3 program. See *KB3 Program Structure* on page 6-6 for more details on KB3 programs.

VAST Program Structure

You might want to take a look at Figure 6-1 on page 6-5, which depicts the hierarchy of a VAST program, from individual samples all the way up to setups, which can contain up to 16 programs.

Every VAST program contains at least one layer. A layer consists of a keymap and an algorithm for processing the samples contained in the keymap. Each sample is a separate digital recording of some kind of sound: musical, vocal, industrial, any sound at all. Individual samples are assigned to specific key ranges (from A 2 to D 3, for example), and are also assigned to be triggered at specific attack velocities. These assignments constitute the keymap.

When you trigger a note, the PC3K looks to the keymap of each layer of the currently active VAST program(s) to determine which samples to play. The sound engine then fetches the requested samples and generates a digital signal representing the sound of the samples. This signal first passes through the DSP functions that make up the algorithm. It then passes through the PC3K's effects processor, and finally appears—with some level of effects applied to it—at one or more of the audio outputs.

The layer is the VAST program's basic unit of polyphony, that is, each layer constitutes one of the 128 voice channels the PC3K can activate at any time. If you have a program that consists of two layers covering the note range from A 0 to C 8, each key you strike triggers two voice channels.



Note: One exception to this structure is when using a KVA oscillator, the sound source for that layer is not derived from a keymap, but is generated at the algorithm stage (though keymap information is still used to set key range and maximum amplitude.) After this, the structure is the same as described above. See *Editing VAST Programs With KVA Oscillators* on page 6-53 for more details.

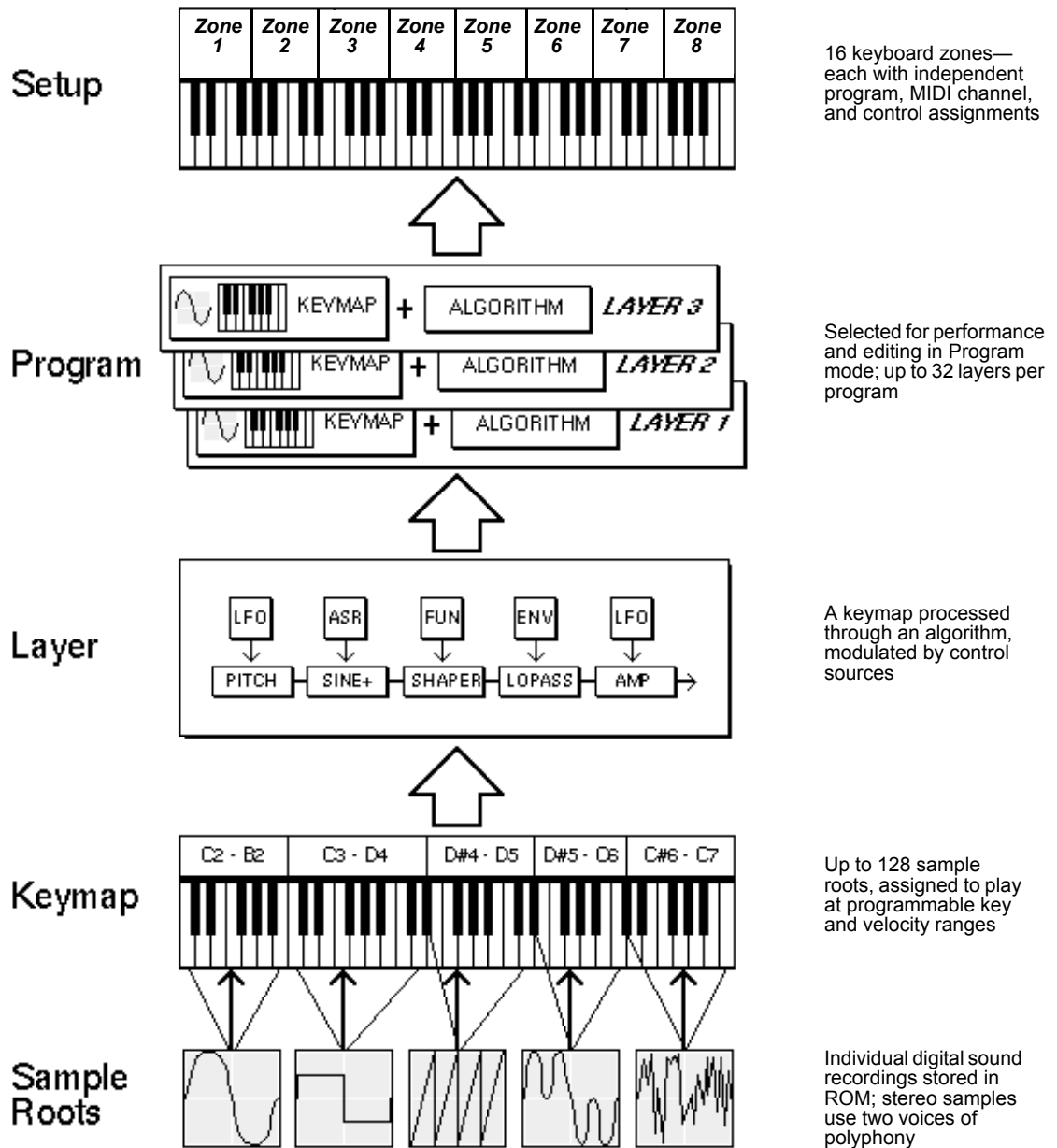

Figure 6-1 VAST Program Structure

KB3 Program Structure

There’s nothing quite like the sound of the classic Hammond™ B-3 tone wheel organ, especially when played through a Leslie™ rotating speaker system. We’ve done extensive testing and analysis with several tone wheel organs, and created our own models to emulate the unique tone wheel sound. We even took into account the way that older organs start to sound different (and arguably better) as their capacitors begin to leak—and we included a parameter that lets you vary the amount of grunge (leakage) in your sound.

KB3 programs use oscillators to emulate the tone wheel sound. Each oscillator operates independently, and has its own pitch and amplitude control. You can control how many oscillators are used for a KB3 program. There are two oscillators per voice, for a total of 256. You can use up to 91 of them in a KB3 program (the 92nd is reserved to produce key click). Because the oscillators start running as soon as you select a KB3 program, there are always voices available—unlike VAST programs, which start “stealing” notes when you reach the polyphony limit.

The oscillators—we’ll call them tone wheels from here on—are divided into an upper and lower group. The upper tone wheels use the samples in the PC3K’s keymaps to generate sound, while the lower tone wheels use sine waves. You can change the keymap of a KB3 program’s upper tone wheels to produce a large array of sounds. By changing the keymap from sine to a saw wave it is possible to emulate the sound of classic combo organs like the Vox™ and Farfisa™ models.

KB3 programs are also routed through vibrato, rotary speaker, preamp and distortion effects, see below for details.

KB3 Mode

KB3 programs are different enough from VAST programs that we use the term KB3 mode to describe what’s going on when you play a KB3 program. Whenever you play a KB3 program, you are in KB3 mode. The blue LED in the KB3 button will light when the current program is a KB3 program. **You can play KB3 programs only on a single channel at a time.**

If you want to create your own KB3 program, start by editing an existing KB3 program.

KB3 Effects And Real-time Controls

You have real-time control over many components of KB3 programs directly from the front panel. The sliders emulate the drawbars that are so essential to the tone wheel sound, while the buttons above them (the Bank Buttons) can control the KB3 effects: Leslie, vibrato, chorus, and percussion. When using a KB3 program in Setup Mode, you must set the *Mutes* parameter to KB3 Control in order to use the Bank buttons for controlling KB3 effects (see *Mutes* on page 7-66 for details.)

Drawbars

One of the standard performance features of many tone wheel organs is the set of drawbars for emulating the stops on a pipe organ. Moving the drawbars controls the amplitude of either the fundamentals or the harmonics of the notes. The PC3K’s sliders serve as the nine drawbars found on most tone wheel organs. Pushing the sliders up is the equivalent of pushing the drawbars in (removing fundamentals or harmonics).

Subharmonics		Fundamental	Harmonics					
16'	5 1/3'	8'	4'	2 2/3'	2'	1 3/5'	1 1/3'	1'
Slider A	Slider B	Slider C	Slider D	Slider E	Slider F	Slider G	Slider H	Slider I

Table 6-1 Standard Drawbar Settings for the Hammond B3

KB3 Mode Effects Buttons (Bank Buttons)

When using a KB3 program, the Bank buttons (above the sliders) control KB3 effects, instead of choosing program banks as they usually do in program mode. The KB3 function is labeled below each button, their LEDs indicate the status of the various effects for the current KB3 program. This status is saved as part of each program. You can change the effects in real time by pressing the buttons.

The KB3 effects return to their programmed settings the next time you select the program. If, however, you're in the Program Editor when you change the effects, you're actually editing the program. (Each effect also has a corresponding parameter in the Program Editor, see the table below.) If you like the changes, you can save the program with the new KB3 effects settings. If you don't like the changes, you can exit without saving, and the program will revert to its previous settings.

In KB3 mode the Bank buttons also respond to and send MIDI Controller messages. See Table 6-3 on page 6-8 for details.

Effect Category	Button Name	LED Color (relative to button name/state)	Corresponding Page and Parameter	Comments
Rotary	Fast / Slow	red/green	MISC: SpeedCtl	
Vibrato	On / Off	red/off	MISC: VibChorCtl	
	Chorus / Vibrato	red/green	MISC: VibChorSel	Disabled if Button 2 is off
	Depth 1 / 2 / 3	green/orange/red	MISC: VibChorSel	Disabled if Button 2 is off
Percussion	On / Off	red/off	PERC: Percussion	
	Volume Loud / Soft	red/green	PERC: Volume	Disabled if Button 5 is off
	Decay Fast / Slow	red/green	PERC: Decay	Disabled if Button 5 is off
	Pitch High / Low	red/green	PERC: Harmonic	Disabled if Button 5 is off

Table 6-2 KB3 Mode Effects Buttons and Corresponding Parameters

Additional Controller Assignments In KB3 Mode

Other default assignments for factory KB3 programs include:

CC Pedal 1 (volume) controls **preamp volume**, which emulates the volume control of an organ preamp. The **PreampResp** parameter must be set to On for this to work (the default setting.) See *PreampResp* on page 6-67 for details.

The **Mod Wheel** controls **Distortion Drive**.

Switch Pedal 1 (sustain) controls the **SpeedCtl** parameter, which toggles the Rotary speed between slow or fast. See *SpeedCtl* on page 6-68 for details. This has the same effect as using Bank Button 1 (labeled Rotary Fast/Slow.)

MIDI Control of KB3 Programs

Controller Numbers

Table 6-3 lists the MIDI Controller numbers that control KB3 features. Send the listed controller number and appropriate controller value to control each KB3 feature via MIDI. The PC3K also sends these Controller numbers to its MIDI Out port when using each of these KB3 features.

KB3 Program Feature	MIDI Controller Number	Values	
Distortion Drive (Mod Wheel)	1	0 = Minimum Distortion Drive. 127 = Maximum Distortion Drive. Values between 0 and 127 scale between minimum and maximum Distortion Drive.	
Preamp Volume (Volume/Expression Pedal)	11	0 = Minimum Preamp volume. 127 = Maximum Preamp volume. Values between 0 and 127 scale between minimum and maximum volume.	
Drawbar1	6	With Steps parameter set to (0-8) (See <i>Steps</i> on page 6-61 for details)	With Steps parameter set to (0-127) (See <i>Steps</i> on page 6-61 for details)
Drawbar2	13		
Drawbar3	22		
Drawbar4	23		
Drawbar5	24		
Drawbar6	25		
Drawbar7	26		
Drawbar8	27		
Drawbar9	28		
Rotating Speaker Fast/Slow	68	64-127 = Fast, 0-63 = Slow	
Chorus/Vibrato On/Off	95	64-127 = On, 0-63 = Off	
Chorus/Vibrato Selector and Chorus/Vibrato Depth	93	54-71 = select chorus with depth 1 72-89 = select chorus with depth 2 90-127 = select chorus with depth 3 0-17 = select vibrato with depth 1 18-35 = select vibrato with depth 2 36-53 = select vibrato with depth 3	
Percussion On/Off	73	64-127 = On, 0-63 = Off	
Percussion Loud/Soft	71	64-127 = Loud, 0-63 = Soft	
Percussion Decay Fast/Slow	70	64-127 = Fast, 0-63 = Slow	
Percussion Pitch High/Low	72	64-127 = High, 0-63 = Low	
Key Click Level	89	0 = -96 dB. 127 = Maximum Key Click Level set in Editor. Values between 0 and 127 scale between -96 dB and maximum Key Click Level.	
Leakage Level	90	0 = -96 dB. 127 = 0 dB. Values between 0 and 127 scale between -96 dB and 0 dB.	

Table 6-3 KB3 MIDI Controller Assignments

Control Setup

Control Setup Overview

The Control Setup is a Setup object edited and stored in Setup Mode but used by Program Mode. The Control Setup defines the CC destinations for the PC3K's physical controllers (*wheels, sliders, pedals, etc.*) in Program mode. These assignments are the MIDI CC numbers that the PC3K's physical controllers *send* while in Program mode. Parameters in the Program Editor can then be assigned to respond to these CC numbers. See the Figure 6-2 below for a visual depiction of the Control Setup's role while in Program Mode. See the sections on page 6-11 for details on physical controller destinations and program parameter sources.

The programs in the PC3K factory ROM have parameters assigned to respond to the controller destinations of the default Control Setup (**126 Internal Voices**). Therefore you'll want to use **126 Internal Voices** as the Control Setup in most cases.



Note: If you don't use the default Control Setup, assigned parameters in the PC3K's factory ROM programs will probably not respond to the PC3K's physical controllers. Don't edit the Control Setup unless you are an advanced MIDI user and know what you're doing.

Advanced users may wish to use a different control setup if they need to send specific MIDI controller numbers to the MIDI out port when in Program mode. You can also program several different control setups and switch among them for different applications.

Table 6-4 below shows which pages and parameters in the Setup Editor of the Control Setup have an effect on Programs in Program mode. Aside from assigning MIDI CC destinations for the PC3K's physical controllers, the Control Setup allows you to set other available parameters for each physical controller, such as Scale, Curve, Add, and Switch Type (*see Continuous Controller Parameters on page 7-29 for details on these parameters.*)

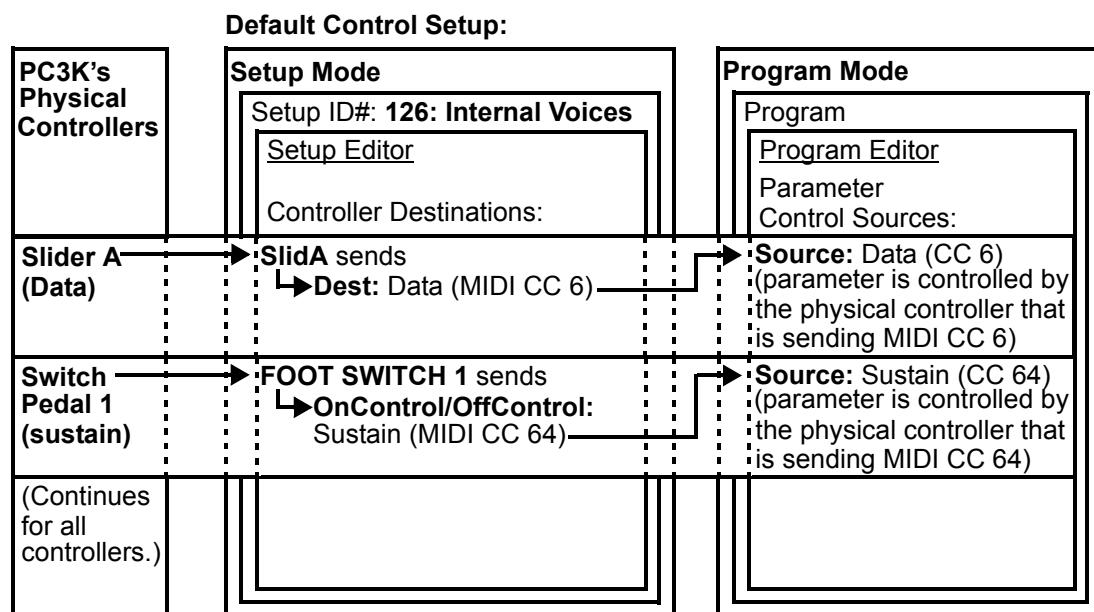

Figure 6-2 Examples Of How The Control Setup Defines The PC3K's Physical Controller Assignments While In Program Mode

Control Setup Advanced Features

The control setup can also be used to set other parameters which affect program mode. See Chapter 7, *Setup Mode* for details on each of these parameters:

- Velocity scaling can be set in the Setup Editor with parameters on the KEY-VEL page. Though a master velocity map can be set with the Velocity Map parameter on the Master Mode MAPS page (see *page 11-5*), setting velocity scaling in the Control Setup provides more options.
- Programmable switch destinations can be set on the Setup Editor PRG SWITCH pages. In Program mode, the Programmable Switches act as Program Select buttons if none of them are assigned to a destination in the control setup. If at least one Programmable Switch is assigned in the control setup, then the assigned Programmable Switch buttons act as assigned, but none of the buttons function as program select buttons.
- Ribbon settings can be set on the Setup Editor RIBBON and RIBBON CONFIGUR pages.
- MIDI aftertouch can be turned off on the Setup Editor PRESSURE page by setting the Dest field to OFF.
- On the CH/PROG page you can set the Bank Mode which determines the type of MIDI bank messages that Program Mode will send to the USB and MIDI out ports when changing programs. See *Program Change (ProgChang)* on page 10-5 to disable the PC3K from sending program change messages.
- The Destination parameter on the CH/PROG page determines where MIDI messages are sent. Usually this should be kept at its default setting USB_MIDI+MIDI+LOCAL, and the MIDI message destination for Program mode should be set with the Destination parameter on the MIDI Mode Transmit page (see page 10-2 for details.) The Destination parameter on the CH/PROG page works in combination with the Destination parameter on the MIDI Mode Transmit page. For example if the Destination parameter on the CH/PROG page is set to MIDI+LOCAL, then MIDI messages will not be sent to the USB port, even if USB_MIDI+MIDI+LOCAL is selected for the Destination parameter on the MIDI Mode Transmit page.

Selecting And Editing The Control Setup

The current control setup can be selected on the MIDI Mode Transmit page using the ControlSetup parameter.

To edit the current control setup, select the ControlSetup parameter on the MIDI Mode Transmit page, then press the Edit button to the left of the display. You can also select the setup in Setup Mode and then press the Edit button to the left of the display. If you edit or overwrite the default Control Setup (**126 Internal Voices**), you can always recall the original control setup by deleting the setup stored at ID# 126. This will return the setup to its default settings. You can delete a setup by using the Delete soft button in the Setup Editor.

When selecting or editing the Control Setup, only Zone 1 of the setup has an effect on program mode. (*Zones 2–16 are not relevant in Program Mode, because the PC3K's physical controllers can only control one MIDI channel at a time in Program Mode.*) See Table 6-4 below for which pages and parameters in the Setup Editor of the Control Setup have an affect on Programs in Program Mode.



Note: The Control Setup doesn't affect the *sound* of a program, only the assignments of certain physical controllers. The samples and keymaps assigned to a program are unaffected by the Control Setup. While you're in Program mode, the PC3K ignores the programs assigned to the setup that you chose as the Control Setup.

Control Setup—Setup Editor Page (Zone 1)	Parameters Affecting Program Mode
CH/PROG	Arpeggiator, Destination, BankMode
KEY-VEL	All
PAN-VOL	ExitVolume, ExitPan
BEND	AuxBend1Up, AuxBend1Dwn, AuxBend2Rng
COMMON	Tempo, ArpSync
ARPEGGIATOR	All
RIBBON CONFIGUR	All
Continuous Controller assignment pages (SLIDER, SLID2, CONT.PEDALS, RIBBON, WHEEL, PRESS)	Dest, Scale, Add, Curv
Switch Controller assignment pages (FOOT SWITCH 1-3, SWITCH ARP, SWITCH SW, PRG SWITCH 1-8)	Type, OnControl, OnValue, OffControl, OffValue, EntryState

Table 6-4 Control Setup Parameters Affecting Program Mode

About PC3K Physical Controller Destinations

PC3K physical controllers transmit controller messages consisting of a destination and a value. The destination allows the physical controller to be identified, while the value represents the current state of the physical controller (*button on/off, slider setting, etc.*) Each destination can be identified as a number (*though some destinations are displayed in the PC3K as the name of their default use.*) Destinations can be MIDI continuous controller numbers (0-127) or PC3K internal destinations (128 and above.) For simplicity, we will refer to both of these types of destinations as CC numbers, or CCs (continuous controller numbers.)

By default, physical controller destinations 0-127 are transmitted internally to program parameters, and to the USB and MIDI Out ports as MIDI continuous controller numbers (*see Destination on page 10-2 to change this behavior.*)

Physical controller destinations 128 and above are only transmitted *internally* to program parameters. Destinations above 127 can not be assigned as a program parameter control source. Some destinations above 127 will still affect Program Mode even though they can not be assigned as a program parameter control source. For example, destination 133 **Tempo** always controls the system tempo. In the control setup, setting a slider to destination 133 Tempo would make that slider always control system tempo while in Program mode. This might be useful to change the tempo when using the arpeggiator in Program mode, though the slider wouldn't be able to control anything else in Program mode. See *The Controller Destination List* on page 7-21 for details on each controller destination.

About Program Parameter Sources

In program mode, when you want to control a parameter with a physical controller, you set the parameters *source* field to the *destination* that the physical controller is sending to. For example, by default the destination for the Mod Wheel is CC 1. If you select a source field in the Program Editor, then press **1** followed by the **Enter** button, that parameter will be controlled by the Mod Wheel. In this case, the parameter could also be controlled by CC 1 being sent from an external MIDI device.

You can assign a destination to a source field by selecting the source field, holding the Enter button, then moving the physical controller that you want to use. For most of the PC3K's physical controllers, their destination name in the source field is displayed with the name of the controller on the PC3K's front panel.

Editing VAST Programs

The Program Editor is where you begin to modify the PC3K’s resident sounds, and to build your own sounds around sample keymaps or KVA oscillators (see *Editing VAST Programs With KVA Oscillators* on page 6-53 for some differences.) There’s virtually no limit to the sounds you can create using the tools in the Program Editor.



Note: This section describes the Program Editor as it applies to VAST programs. See *Editing KB3 Programs* on page 6-59 for information about editing KB3 programs.

To enter the Program Editor, start in Program mode and press **Edit**. The Program-mode LED will go out, and the KEYMAP (Keymap) page will appear.

```

editProgKEYMAP   Prog 999 #Layer:1/1
Keymap: 1 Piano f Left
Stereo: Off
XPose : 0ST          TimbreShift : 0ST
KeyTrk : 100Oct/key  PlaybackMode: Normal
VelTrk : 0Oct       AltControl : OFF
AltMethod : Switched
more KEYMAP LAYER PITCH AMP more
    
```

The top line of the display gives you the usual reminder of your location. It also tells you which layer you’re viewing, and how many layers there are in the program. You can use the **Chan/Layer** buttons to scroll through the layers, if the program has more than one.

Here’s a method for jumping quickly to a specific layer in a program—it’s especially useful in multi-layered drum programs. Hold the **Enter** button and strike a key. The display will show the layer(s) assigned to that key. If more than one layer is assigned to the same key, repeatedly striking the key (while continuing to hold the **Enter** button) will cycle through all layers assigned to that key. This method will work in most places within the Program Editor, but there is an exception: if the parameter you have highlighted has a note number or control source as its value, then holding **Enter** and striking a note will call up that note or control source. For all other parameters, however, this method will switch between layers.

The Soft Buttons in the Program Editor

The Program Editor’s soft buttons are labeled by the words that appear in the bottom line of the display. These buttons have two important jobs in the Program Editor: selecting pages, and selecting specific functions. If a soft button is labeled in all uppercase letters, pressing it will take you to the page it describes. If the button is labeled in mixed uppercase and lowercase letters, pressing it will execute the software function described by the label. Pressing the **LAYER** soft button, for example, will take you to the Layer page, while pressing the **Save** soft button will initiate the process for saving the currently selected program.

There are more pages and functions in the Program Editor than there are soft buttons. Therefore, two of the soft buttons are dedicated to scrolling through the list of pages and functions. If you don’t see the button for the page or function you want to select, press one of the soft buttons labeled **more**, and the labels will change. This doesn’t change the currently selected page, it merely changes the selection of available soft buttons.

Two of the soft buttons in the Program Editor are special cases. They're the soft buttons that select the editing pages for the first and last *DSP functions* (Pitch and Level, respectively) of the current program's algorithm. One of these soft buttons is labeled **PITCH**, and pressing it will take you to the DSPCTL (DSP Control) page with the Pitch parameter highlighted. The other one of these soft buttons is labeled **AMP**, and pressing it will take you to the DSPCTL page with the Level parameter highlighted. Additionally, pressing the **DSPCTL** soft button will take you to the DSPCTL page.

The MODE Buttons in the Program Editor

When in the Program editor, each of the **MODE** select button has a different function. Beside each button is the name of its function in the Program editor. When activated, the button's LED will light up.

Mute 1, 2, 3, and 4

Each of the top four **MODE** select buttons serve to mute one of the current program's first four layers. Pressing the **Program** button mutes layer 1, pressing the **MIDI** button mutes layer 2, pressing the **Setup** button mutes layer 3, and pressing the **Master** button mutes layer 4.

Solo

Pressing the **Q Access** button solos the current layer.

Mute Active

Pressing the **Song** button mutes the current layer.

FX Bypass

Pressing the **Effect** button bypasses all effects. Note, however, that if either of the Aux Overrides in Effects mode are active, then those effects are still applied.

Compare

Pressing the **Storage** button calls up the Compare Editor, which recalls the program pre-edit settings, allowing you to compare your edited program with the original program. Pressing the **Storage** button again returns you to the Program editor. Using the Compare Editor makes no changes to the current program.

Assigning Program Parameters to Control Sources

Many PC3K program parameters can be assigned to be controlled by the PC3K's physical controllers or by MIDI CCs from an external MIDI device. For details on controllable parameters of VAST programs, see the following sections: *The DSP Modulation (DSPMOD) Page* on page 6-30, *The LFO Page* on page 6-38, *The ASR Page* on page 6-40, *The Function (FUN) Page* on page 6-41, *The Envelope Control (ENVCTL) Page* on page 6-45, *The MOD Pages* on page 9-10, and *FXLFO, FXASR, and FXFUN pages* on page 9-11. For KB3 programs, see the following sections: *KB3 Editor: The PITCH Page* on page 6-62, *KB3 Editor: The AMP Page* on page 6-62, *KB3 Editor: The LFO, ASR, and FUN Pages* on page 6-70, *The MOD Pages* on page 9-10, and *FXLFO, FXASR, and FXFUN pages* on page 9-11.

For each program, the Program Editor can be used to assign the PC3K's physical controllers or external MIDI controller CC numbers to control parameters. Controllable parameters each have a source field. Make assignments to the source field for the desired parameter. Source fields are named differently depending on their page: Src1, Src2, RateCt, Trigger, Input a, Input b, and Source. To assign a PC3K physical controller, select the source field for the parameter, hold the **Enter** button and move the controller. To assign a CC number to a source field, enter the number with the alphanumeric pad, then press **Enter**. A CC number for an external controller can also be set by selecting the source field for the parameter, holding the **Enter** button, and sending a CC value from the external MIDI controller. When assigning a CC number to a source field, the number may be displayed in the source field as the name of that CC's default use.

The KEYMAP Page

Press the **KEYMAP** soft button to call up the KEYMAP page. The parameters on this page affect sample root selection, i.e., which samples are played on which keys.

```

EditProgKEYMAP Prog 999 #Layer:1/1
Keymap: 1 Piano f Left
Stereo: Off
Xpose : 0ST      TimbreShift : 0ST
KeyTrk : 100ct/key  PlaybackMode: Normal
VelTrk : 0ct      AltControl : OFF
AltMethod : Switched
more KEYMAP LAYER PITCH AMP more
    
```

Parameter	Range of Values	Default
Keymap	Keymap List	1 Piano f Left
Transpose	-128 to 127 semitones	0
Key Tracking	± 2400 cents per key	100
Velocity Tracking	± 7200 cents	0
Alt Method	Switched, Continuous	Switched
Stereo	Off, On	Off
Timbre Shift	± 60 semitones	0
Playback Mode	Norm, Rvrs, Bidirectional, Noise	Normal
Alt Control	Control Source List	Off

Keymap

Assign a keymap from ROM to the current layer. Keymaps are collections of samples assigned to note and velocity ranges. With the Keymap parameter selected, press the **Edit** button to enter the Keymap editor (see *The Keymap Editor* on page 14-1 for details.)

Transpose (Xpose)

Transpose the current keymap up as much as 127 semitones (ten octaves and a perfect fifth) or down as much as 128 semitones (ten octaves and a minor sixth).

Key Tracking (KeyTrk)

This is one of the six common DSP control parameters. On the KEYMAP page, key tracking affects the interval between notes. The default value of **100 cents** (a cent is a hundredth of a semitone) gives you the normal semitone interval between each note. Higher values increase the interval; lower values decrease it. Negative values will cause the pitch to decrease as you play higher notes.

When you make changes to this parameter, you'll need to keep in mind that KeyTrk on the KEYMAP page works in conjunction with KeyTrk on the PITCH page. Therefore, you'll need to check the KeyTrk value on both pages to see how key tracking works within a program. Unless you're looking for nonstandard note intervals, the values of the KeyTrk parameters on the PITCH and KEYMAP pages should add up to 100 cents.

Velocity Tracking (VelTrk)

This is another common DSP control parameter. As with the other parameters on the KEYMAP page, this shifts the position of the keymap. Different attack velocities will play different pitch shifts of the sample root assigned to that note range. If the shift is great enough, the next higher or lower sample root will be played, which in some cases (many drum programs, for example) will play an entirely different sound. Positive values will play higher pitches of the sample root when you use hard attack velocities (they shift the keymap downward), while negative values will play lower pitches.

Method (AltMethod)

See *Alternative Switch (AltControl and AltMethod)* below.

Stereo

You'll use this parameter when you're working with stereo samples.

When you set this parameter to **On**, the KEYMAP page changes slightly:

```

EditProgKEYMAP Prog 999 #Layer:1/1
Keymap1: 1 Piano f Left
Keymap2: 110 Stereo Strings Stereo: On
XPose : 0ST TimbreShift : 0ST
KeyTrk : 100ct/key PlaybackMode: Normal
VelTrk : 0ct AltControl : OFF
AltMethod : Switched
more KEYMAP LAYER PITCH AMP more

```

An additional Keymap parameter appears. The two keymap parameters are distinguished as Keymap 1 and Keymap 2. The KEYMAP page parameters will affect both keymaps. When the Stereo parameter is set to **On**, the OUTPUT page for the current layer will show an additional pair of Pan parameters.

The PC3K contains both stereo and mono samples. Keymaps designed for stereo use are labeled with names beginning with "Stereo" or ending in "Left," "Right," "L," or "R." For stereo keymap playback, set Stereo "On" and assign corresponding Left and Right keymaps to Keymap1 and Keymap2 respectively. For keymaps beginning with "Stereo," assign the same keymap to both Keymap1 and Keymap2. If you select the same keymap for Keymap1 and Keymap2, the PC3K automatically uses the left side for Keymap1 and the right side for Keymap2.

Once you have the keymaps assigned, go to the OUTPUT page and set the panning for each sample as desired. Keep in mind that using stereo keymaps reduces the polyphony of the program. For example, if you had a two-layer program with stereo keymaps in each layer, each note you play would use 4 of your 128 voices, allowing a total of 32 notes before all the voices have been used.

If you're not using stereo samples, you should set this parameter's value to **Off**.

Timbre Shift

This parameter works only on multi-sample keymaps, and changes the root selection for each key you play. With this parameter you can radically alter the current layer's timbre (basic sound characteristics). The nature of the change depends on the timbre itself, so this parameter calls for experimentation. Basically, timbre shifting changes a note's timbre by imposing different harmonic qualities onto the note. A timbre-shifted note retains its original pitch, but its harmonics are those of the same timbre at a higher or lower pitch. Positive values for this parameter tend to brighten a sound, while negative values darken.

Here's an example. If you shift the timbre up 4 semitones, then playing C 4 will result in the *pitch* C 4, but will actually play the sample normally assigned to G[#] 3, and shift its pitch up four semitones. This will increase the playback rate of the sample, so although the pitch remains normal, the timbre is brighter. You'd get the same effect by setting the Xpose parameter on the KEYMAP page to **-4 semitones**, then setting the Adjust on the PITCH page to **+4 semitones**. For multi-sample layers with narrow key ranges, large amounts of timbre shifting will cause different sample roots to be played back.

Playback Mode

This gives you numerous options for manipulating the samples in the current layer as you trigger them. **Normal** leaves the samples unaffected, while **Reverse** plays them in reverse. At a value of **Reverse**, the samples will continue to loop as long as notes are sustained. To play them just once in reverse, you would adjust the length of the layer's amplitude envelope (explained later in this chapter). **BiDirect** (bidirectional) causes the samples to loop infinitely, alternating between normal and reversed playback. **Noise** replaces the samples with a white noise generator.

Alternative Controller (AltControl)

See *Alternative Switch (AltControl and AltMethod)* below.

Alternative Switch (AltControl and AltMethod)

Many, but not all, PC3K sample roots have been pre-assigned a carefully chosen alternate sample start point that can be selected using the Alternate Switch feature (AltControl and AltMethod parameters). This feature allows you to control the sample playback start/end time triggered by any control source. (The alternate sample start point can be adjusted by editing a sample, see *Editing Samples* on page 14-9 and *The TRIM Page* on page 14-12 for details.)

Use the AltControl parameter to specify a control source that will cause the sample to begin or end at the Alt point. Then use the AltMethod parameter to choose between switched and continuous calculation of the Alt point. If the value of AltMethod is **Switched**, the PC3K will use the Alt point when the relevant control source is at a value greater than 64 at Note Start. If AltMethod is **Continuous**, the Alt point will vary depending on the value of the relevant control source at Note Start.

As an example, suppose you're working with a flute keymap and wish to control the amount of chuff heard at the beginning of the sound. On the KEYMAP page in the Program Editor, set AltControl to MWheel. Now the Mod Wheel controls how much of the initial sample attack is used. If you set AltMethod to **Switched** and move the Mod Wheel at least half-way up, at Note Start the sample will begin at the pre-set alternate start point (in this case, slightly past the initial chuff). If you set the AltMethod to **Continuous**, the PC3K will interpolate the sample's starting point based on the position of the Mod Wheel. If the Mod Wheel is 75% of the way up at Note Start, the sample will begin 75% of the way between normal and alternate start points.

Emulating Legato Play

If you place the Alt point after the initial attack transients of the sample, then you can use the Alt Switch to emulate legato playing in an acoustic instrument. As an example, set Keymap to **14 Flute**. Now set the AltControl parameter to **Chan St** (Channel State). Now if you play notes separately, the initial breathy chiff will be heard. But if you play the notes legato (connecting them smoothly), the Alt point is used and you do not hear the chiff. This is because the Chan St is turned on as long as any note is being held. Most of the PC3K's ROM samples have their Alt points set for purposes of legato play. In most cases the difference in attacks is subtle, but for some sounds, like drums, the difference can be more noticeable.

The LAYER Page

Press the **LAYER** soft button to call up the LAYER page. Here you'll set a number of parameters that affect the current layer's keyboard range, attack and release characteristics, and response to various controls.

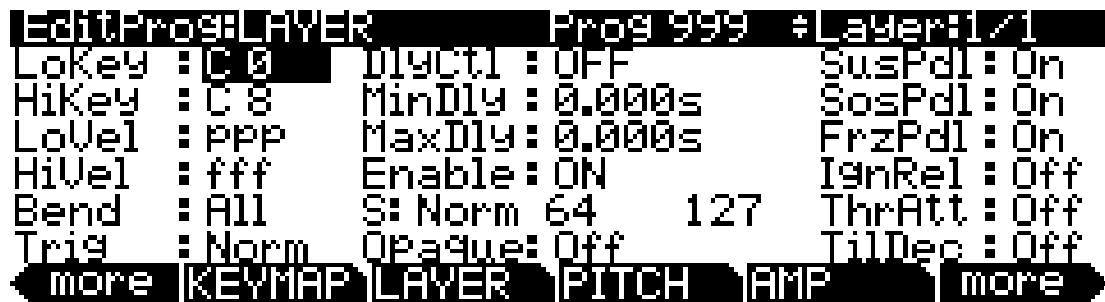

Parameter	Range of Values	Default
Low Key	C -1 to G 9	C 0
High Key	C -1 to G 9	C 8
Low Velocity	ppp to fff	ppp
High Velocity	ppp to fff	fff
Bend	Off, Key, All	All
Trig	Normal, Reversed	Normal
Delay Control	Control Source list	Off
Minimum Delay	0 to 25 seconds	0
Maximum Delay	0 to 25 seconds	0
Layer Enable	Control Source list	On
Enable Sense	Normal, Reversed	Normal
Enable Min	± 127	64
Enable Max	± 127	127
Opaque Layer	Off, On	Off
Sustain Pedal	Off, On, On2	On
Sostenuto Pedal	Off, On	On
Freeze Pedal	Off, On	On
Ignore Release	Off, On	Off
Hold Through Attack	Off, On	Off
Hold Until Sustain	Off, On	Off

Low Key (LoKey)

This sets the lowest active note for the current layer. This parameter's value cannot be set higher than the value for HiKey. The standard MIDI key range is C 1—G 9 (0-127). Middle C is C 4.

High Key (HiKey)

Here you set the highest active note for the current layer. This parameter's value cannot be set lower than the value for LoKey.

Low Velocity (LoVel)

With this parameter you define the lowest attack velocity at which the layer will be enabled (generate a sound). The values for this parameter and the next are expressed in the standard musical dynamics markings, similar to the values available for the velocity maps. Attack velocities that are below this threshold will not trigger notes. If you set this parameter's value higher than the HiVel value, the layer will not play at all.

High Velocity (HiVel)

Similarly, this will set the highest attack velocity at which the layer will be enabled. Attack velocities above this threshold will not trigger notes in this layer.

Using LoVel and HiVel, you can set up velocity switching between up to eight layers. If you need even more, you can do it using the Enable and Enable Sense (S) parameters (page 6-19).

Pitch Bend Mode (Bend)

This determines how Pitch bend control messages will affect the current layer. A value of **All** bends all notes that are on when the Pitch bend message is generated. A value of **Key** bends only those notes whose triggers are *physically* on when the Pitch bend message is generated (notes held with the sustain pedal, for example, won't bend). This is great for playing guitar solos on top of chords—play a chord, hold it with the Sustain pedal, then play your licks and bend them all you want; the chord won't bend with it. A value of **Off** disables Pitch bend for the current layer. To apply the same Pitch Bend Mode setting to the entire program, make sure to set the same setting for each layer.

Trigger (Trig)

Set Trig to **Rvrs** to have notes of the current layer triggered on key-up. The initial velocities of notes triggered this way are determined by the release velocities of the keys that trigger them. The default setting is **Norm**.

Delay Control (DlyCtl)

Here you select, from the Control Source list, a control source that will delay the start of all notes in the current layer. The length of the delay is determined by MinDly and MaxDly (described below). You'll assign a continuous control like MWheel for the DlyCtl parameter when you want to vary the delay time, and a switch control if you want the delay to either be its minimum value (switch off), or its maximum (switch on). The delay control will affect only those notes triggered *after* the delay control source is moved; the delay time is calculated at each note start, based on the status of the delay control source at that time.

Minimum Delay (MinDly), Maximum Delay (MaxDly)

The length of the delay is determined by these two parameters. When the control source assigned to DlyCtl is at its minimum, the delay will be equal to the value of MinDly. The delay will be equal to the value of MaxDly when the control source is at its maximum. If DlyCtl is set to **OFF**, you get the minimum delay. If it's set to **ON**, you get the maximum delay. This doesn't change the note's attack time, just the time interval between the Note On message and the *start* of the attack. The delay is measured in seconds.

Enable

This assigns a control source to activate or deactivate the layer. When the value of the assigned control source is between the minimum and maximum thresholds set by the Sense (S) parameter, the layer is active. When the value of the assigned control source is below the minimum or above the maximum, the layer is inactive. By default, many layers have the Enable parameter set to **ON**, so the minimum and maximum thresholds don't matter. They're relevant only when Enable is set to a specific control source (like MWheel).

Some local control sources (KeyNum and AttVel, for example) are not valid for the Enable parameter. In these cases, you should use the global equivalent (GKeyNum and GAttVel in this example).

Enable Sense (S)

This parameter determines how and when a layer is enabled by the control source assigned for the Enable parameter. Enable Sense has three values: orientation, minimum, and maximum.

Suppose for a moment that you're editing a program, and in the current layer you've set the value of Enable to **MWheel**, which causes the Mod Wheel to control whether the layer is active. The default values for Enable Sense are as follows: orientation is **Norm**; minimum is **64**, and maximum is **127**. This means that when the Mod Wheel is less than halfway up, the layer is disabled. The layer plays only when the Mod Wheel is more than halfway up.

Change the orientation to **Rvrs**, and the layer plays only when the Mod Wheel is *less* than halfway up. Change the orientation back to **Norm**, and change the minimum to **127**. Now the layer plays only when the Mod Wheel is *all* the way up.

You could use this parameter to set up a two-layer program that would let you use a MIDI control to switch between layers, say a guitar sound and a distorted guitar. Both layers would have their Enable parameters set to the same control source, say **MWheel**. One layer would have its Enable Sense orientation set to **Norm**, and the other would have it set to **Rvrs**. Both layers would have their Enable Sense minimums set to 64, and their maximums to 127. The first layer would play when your Mod Wheel was above its midpoint, and the second layer would play when the Mod Wheel was below its midpoint. (You could achieve the same effect by having the Enable Sense orientation in both layers set to **Norm**, and the minimum and maximum values set as follows: minimum **0** and maximum **63** for one layer; minimum **64** and maximum **127** for the other.)

Using this parameter in conjunction with the Enable parameter, you can easily create velocity-switching for as many layers as you have in your program. This is useful for drum programs, since you can define a different velocity-trigger level for each of the 32 layers available in drum programs.

First, set the Enable parameter for the Layer 1 to a value of **GAttVel** (global attack velocity). This causes the layer to play based on the attack velocity of your keystrokes. Then set the Enable Sense (S) parameter to a value of **Norm**, and adjust its minimum and maximum values (the two numerals to the right of **Norm**) to a narrow range. Don't use negative values, since they don't apply when you're using GAttVel as the layer enabler.

Repeat this for each layer in the program. Bear in mind that if you want to set up 32 different velocity levels for a program, with equal intervals between each layer, then you have a range of 4 for each level (Layer 1 is 0–3, Layer 2 is 4–7, and so on). It won't be easy to play precisely enough to trigger the layer you want. On the other hand, if you're using Song mode or an external sequencer, you can edit attack velocity levels, and get exactly the results you want.

Opaque

An opaque layer blocks all higher-numbered layers in its range, allowing only the opaque layer to play. This is an easy way to change a small range of notes in a program, leaving the original sound playing above and below the new sound.

Start with a one-layer program, and create a new layer (Layer 2) with the **NewLyr** soft button. On the KEYMAP page for Layer 2, select the keymap you want to use, then on the LAYER page, set Layer 2's range (say, C 3 to D 3), and set its Opaque parameter to **On**. Then go to Layer 1, and duplicate it (with the **DupLyr** soft button); the duplicate layer becomes Layer 3. You now have a three-layer program. Delete Layer 1 (the original layer); Layer 2 (the new layer you created) becomes Layer 1, and Layer 3 becomes Layer 2. Now Layer 2 blocks out Layer 3 (the duplicate of the original layer) at the notes C 3–D 3.

Sustain Pedal (SusPdl)

When this parameter is on, the layer will respond to all sustain messages (Controller destination 64, Sustain). When off, the current layer will ignore sustain messages. **On2** means that the sustain pedal will not catch the release of a note that is still sounding when the sustain message is received; this can be very useful in a program that uses amplitude envelopes with a long release time.

Sostenuto Pedal (SosPdl)

When Sostenuto is on, the layer will respond to all sostenuto messages (Controller destination 66, Sostenuto). When off, the layer ignores sostenuto messages. Sostenuto, as you may know, is a feature found on pianos that have three pedals. Pressing the Sostenuto pedal on a piano (usually the middle pedal) sustains the notes whose keys you were holding down when you pressed the pedal. Notes played after the pedal is already down do not get sustained.

Freeze Pedal (FrzPdl)

This parameter activates or deactivates the layer's response to Freeze pedal messages (Controller destination 69, Freeze). The Freeze pedal control causes all notes that are on to sustain without decay until the Freeze pedal control goes off. If a note is already decaying, it will freeze at that level.

Ignore Release (IgnRel)

When IgnRel is off, the layer responds normally to Note Off messages. When on, the layer will ignore all Note Off messages that it receives. This should be used only with sounds that decay to silence when a note is held, otherwise the sounds will sustain forever (press the Cancel and Enter buttons simultaneously to stop sustained notes.) This parameter can come in handy when your PC3K is slaved to a drum machine or sequencer, which sometimes generates Note Ons and Note Offs so close together that the envelope doesn't have time to play before the note is released. If used in combination with ThrAtt or TilDec (see below,) IgnRel allows you play staccato, yet still hear the entire length of the attack and decay sections of the amplitude envelope.

Hold Through Attack (ThrAtt)

When on, this parameter causes all notes in the layer to sustain through the entire first attack segment of their amplitude envelopes, even if the notes have been released. If you have a sound with a slow attack, or an attack that's delayed with the delay control, setting this parameter to On will make sure your notes reach full amplitude even if you're playing fast. When set to **Off**, notes will release as soon as you release the note (generate a Note Off). If the first attack segment of the layer's amplitude envelope is very short, you probably won't notice a difference between values of **On** and **Off**.

Hold Until Decay (TilDec)

When on, this parameter causes all notes in the layer to sustain through all three attack segments in their amplitude envelopes even if the notes have been released. Looped amplitude envelopes will not loop, however, if the notes are released before reaching the end of the final attack segment. Notes will go into their normal releases if they are released after the envelope has looped. When set to **Off**, notes will release as soon as a Note Off message is generated.

The PITCH Page

Pressing the **PITCH** soft button takes you to the DSPCTL page with the Pitch function highlighted. See *The DSP Control (DSPCTL) Page* on page 6-29 for more information on the Pitch function.

The AMP Page

Pressing the **AMP** soft button takes you to the DSPCTL page with the Amp function (labeled as "Level") highlighted. See *The DSP Control (DSPCTL) Page* on page 6-29 for more information on the Amp function.

The Algorithm (ALG) Page

Press the **ALG** soft button to call up the Algorithm (ALG) page. The top line of the display gives you the usual mode reminder, and tells you which layer you're looking at, as well as how many layers are in the current program. You can view the ALG pages of any other layers in the program by using the **Chan/Layer** buttons.

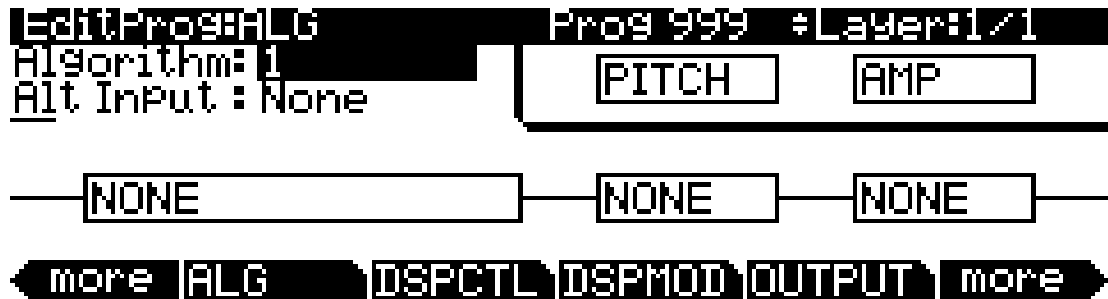

The basic definition: an algorithm is the “wiring” (signal path) of a sample to the audio outputs, through a series of digital signal processing (DSP) functions that you select. The PC3K’s algorithms are the core of Variable Architecture Synthesis Technology. The DSP functions are synthesis tools (filters, oscillators, etc.) that you assign to the various stages of the algorithm. The DSP functions you choose determine the type of synthesis you use.

The central portion of the page shows the algorithm for the currently selected layer. You see the number of the algorithm (from 1 to 28, 101 to 131, and the IDs for any user-defined algorithms) and a graphic representation of the signal path, as well as the currently selected DSP functions within the signal path.

To use a different algorithm, select the Algorithm parameter and use any data entry method to select a different one. To change the DSP function within an algorithm, move the cursor to the block you want to change, then use the Alpha Wheel or **Plus/Minus** buttons. There’s a staggering number of combinations of algorithms and DSP functions alone, not to mention the numerous controls that can be used to modify the DSP functions.



Note: Changing a layer’s algorithm can affect the layer’s sound drastically. It’s a good idea to bring down the volume of your PC3K or your sound system before changing algorithms.

See *Algorithm Basics* below for information on editing algorithms.

Algorithm Basics

Each of the 59 available algorithms represents a preset signal path. With our new Dynamic VAST feature, you can edit any preset signal path and make your own, unique algorithms, but that will be explained further on in this section. Take a look at Algorithm 1 in the diagram below. It's one of the simplest algorithms.

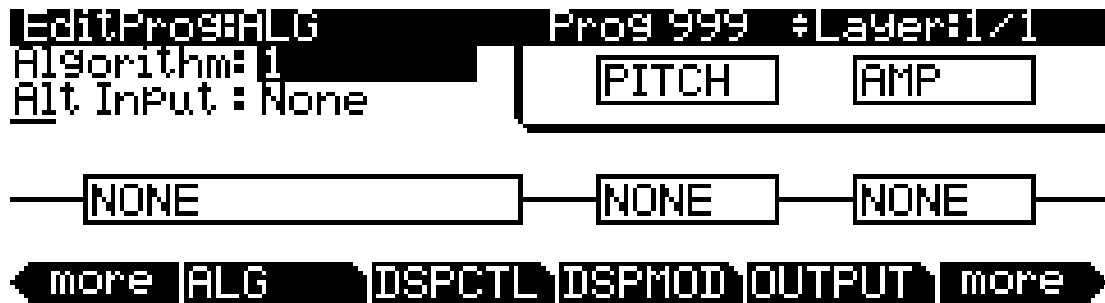

The DSP functions are represented by the rectangular blocks. The lines connecting the blocks together indicates the flow of the digital signal from left to right; they represent what we call the “wire” of the algorithm: the actual physical path that the signal follows through the algorithm. Selecting different algorithms can be compared to connecting different DSP functions with different wiring diagrams.

Think of the left side of each block as its input, and the right side as its output. Depending on the algorithm, the signal may split into two wires, enabling part of the signal to bypass certain portions of the algorithm. Split wires may rejoin within the algorithm, or they may pass all the way through as split signals. If the last block has two wires at its output, we call it a double-output algorithm. If it has one wire, it's a single-output algorithm, even if there are two wires in earlier portions of the algorithm.

Each block of the algorithm represents a certain function in the signal path. In every non-cascaded algorithm (see *Alt Input for Algorithms (Cascade Mode)* below), the signal flows first through a one-stage DSP function that controls the pitch of the samples in the keymap (this function is represented as a block labeled **PITCH** in the upper right-hand corner of the display). In fact, the first DSP function in each algorithm always controls pitch, even though it doesn't apply in every instance and, as will be explained later in this section, it is bypassed in cascaded algorithms. Similarly, the last DSP function always controls the final amplitude of the signal (this function is represented as a block labeled **AMP** in the upper right-hand corner of the display).

The number of *function-parameters* a DSP function can have depends on the relative size of its function-block on the Algorithm page (four slots is the largest block size.) For instance, a function-block that is three slots long can have up to three function-parameters, whereas a function-block that is two slots long can have up to two function-parameters. For each function-parameter, there's a corresponding “subpage” on both the DSPCTL and DSPMOD pages. On the DSPCTL subpages, there are *fine adjust* and *hard-wired parameters* with which you can make fixed adjustments to the function-parameter. On the DSPMOD subpages, there are *programmable parameters* that you can assign to any control source in the Controller List to modulate the function-parameter. The above italicized parameter-types are described in *Common DSP Control Parameters* on page 6-24. More information on the subpages can be found in *The DSP Control (DSPCTL) Page* on page 6-29 and *The DSP Modulation (DSPMOD) Page* on page 6-30.

Highlighting any of the function-blocks on the ALG page and pressing the **Edit** button takes you to the DSPCTL page.

Common DSP Control Parameters

The type of DSP function available for any function block depends on the algorithm. Some of the specialized functions like the PANNER are always located just before the final AMP function. Others, like the two-input functions, appear only in algorithms that are structured for two-input functions.

You can change the nature of each layer of a program simply by assigning different DSP functions to the layer's algorithm. Your level of control goes much deeper than that, however. Each DSP function has one or more parameters to which you can patch a variety of control sources to modify the behavior of the DSP functions themselves.

The parameters on the various control-input pages are very similar; in fact, there are six parameters that appear on almost every page. Consequently we refer to them as the common DSP control parameters. Although the parameters on the control-input pages differ slightly from function to function, you can expect to see some or all of the common DSP control parameters whenever you select the control-input page for any of the DSP functions.

```

EditProgB DSPCTL Prog 999 # Layer:1/1
Pitch      : 0ST      Fine      : 0ct
None       : 0       Hz         : 0.00Hz
None       : 0
None       : 0       KeyTrk    : 0ct/key
None       : 0       VelTrk    : 0ct
Level      : -6dB
more ALG DSPCTL DSPMOD OUTPUT more
    
```

You'll recognize the common DSP control parameters, along with several other parameters. Keep in mind that there's a set of common control parameters for each of the DSP functions; in this case we're describing them only as they apply to the pitch control function.

Function-parameter

Unlike the other five common DSP parameters, the function-parameters are accessible on both the DSPCTL page and the DSPMOD page. They are listed along the left-hand side of each page; any changes made to them on one page are reflected in the other. The label of each function-parameter depends on its function in the current program's algorithm. For example, the Pitch function's function-parameter is labeled **Pitch**; whereas the two-block Lopass function's function-parameters are labeled **LP Frq** and **LP Res**.

By adjusting the function-parameter, you can add a fixed amount of adjustment to any DSP function. For the Pitch function, adjusting the function-parameter will change the pitch in semitone increments. Use this as a starting point to set the pitch where you want it to be normally. *This will shift the pitch of the currently selected layer*, and will affect the playback rate of sampled sounds. Sampled sounds have an upper limit on pitch adjustment. It's normal for the pitches of sampled sounds to "pin" (stop getting higher) when you adjust the pitch upward in large amounts. The oscillator waveforms can be pitched higher. Any sound can be pitched downward without limit.

The primary use of adjusting the function-parameter or fine adjust parameter (which will be explained under the next heading) is to offset the cumulative effects of the other DSP function parameters. For example, you might set a high value for key tracking (defined below) for a dramatic change in effect across the keyboard. The effect might be too much at one end of the keyboard, however, so you could use one of the adjust parameters to reduce the initial amount of that effect.

The PC3K always uses real values of measurement, rather than just arbitrary numbers, for adjustable parameters. This means that you specify pitch in semitones (ST) and cents (ct), and amplitude in decibels (dB).

Remember that the parameters on the control-input pages are cumulative—they can add to or subtract from the effects of the other parameters on the page, depending on their values. For example, even if you've adjusted the pitch of a sample so high that it pins, the effects of the other parameters may bring the pitch back down to a workable range.

Fine Adjust Parameter

You can add slight detuning to the pitch with the fine adjust parameters. Notice that there are actually two fine adjust parameters for the Pitch function: one that changes the pitch in cents (100ths of a semitone), and one that changes it according to its frequency (in increments of Hertz—cycles per second). Since we're discussing the universal control sources here, and not specifically pitch, we'll move on for now, as the Hz parameter applies only to pitch-related functions. See *The PITCH Page on page 6-21* for a more thorough description of Hz.

Hard-wired Parameters

Key Tracking

This is a quick way to get additional control based on the MIDI note number of each note you trigger. Key tracking applies a different control signal value for each note number. In the case of pitch, key tracking enables you to change the tuning of each note relative to its normal pitch.

Middle C is the zero point. Regardless of the key tracking value, there is no effect on Middle C. If you set a nonzero value for key tracking, the effect increases for each note above or below Middle C. In the case of pitch, for example, say you assign a value of **5 cents per key** for the key tracking parameter. Triggering Middle C (C 4 on the PC3K) will play a normal C 4. Triggering C[#] 4 will play a note 5 cents higher than C[#] 4. Triggering D 4 will play a note 10 cents higher than D 4, and so on. Notes below Middle C will be tuned lower than their normal pitches. If you set a negative value for key tracking, notes above Middle C will be tuned lower than their normal pitches.

Keep in mind that key tracking on the PITCH page works in conjunction with the key tracking parameter on the KEYMAP page. This is why you can set the KeyTrk parameter on the PITCH page to **0ct/key**, and notes still increase in pitch by 100 cents/key as you go up the keyboard. It's because the KeyTrk parameter on the KEYMAP page is already set at **100 cents per key**.

Velocity Tracking

A positive value for velocity tracking will raise the pitch as you trigger notes with higher attack velocities. This is great for getting a trace of detuning based on your attack velocity, especially in drum programs, where you can make the pitch of the drum samples rise slightly with higher-velocity Note Ons, just as drums do when you strike them harder. Negative values will lower the pitch as you increase the attack velocity.

Programmable Parameters

Source 1 (Src1)

This parameter takes its value from a long list of control sources including every MIDI control number, a host of LFOs, ASRs, envelopes and other programmable sources.

Src1 works in tandem with the parameter beneath it on the page: Depth. Choose a control source from the list for Src1, then set a value for Depth. When the control source assigned to Src1 is at its maximum, the pitch will be altered to the full depth you set. For example, if you set Src1 to **MWheel**, and set Depth to **1200 ct**, the pitch will rise as you push the Mod Wheel up on your PC3K or MIDI controller, reaching a maximum of 1200 ct (12 semitones, or one octave).

Source 2 (Src2)

This one's even more programmable. Like Src1, you choose a control source from the list. But instead of setting a fixed depth, you can set a minimum and maximum depth, then assign another control source to determine how much depth you get. Try this example. (Make sure Src1 is set to **OFF** first, so the two sources don't interact.) Start with Program 199, and press **Edit**. Press the **PITCH** soft button to select the PITCH page. Set the Src2 parameter to a value of **LFO1**, then set the Minimum Depth parameter to **100 ct**, and Maximum Depth to **1200 ct**. Then set the Depth Control parameter to **MWheel**. This lets you use the Mod Wheel to vary the depth of the oscillation in pitch generated by the LFO.

Now, when the Mod Wheel is down, the pitch will oscillate between a semitone (100 ct) up and a semitone down (the default waveform for LFO1 is a sine wave, which goes positive and negative). With the Mod Wheel up, the pitch will oscillate between an octave up and an octave down.

Since the Mod Wheel is a continuous control, you can achieve any amount of depth control between the minimum and maximum. If you had set the Depth Control to **Sustain**, for example, then you'd get only two levels of depth control: the maximum (1200 cents) with your MIDI controller's sustain pedal down, or the minimum (100 cents) with the sustain pedal up.

Alt Input for Algorithms (Cascade Mode)

Cascade mode is a particularly powerful feature of the PC3K that allows you to create unique algorithms of previously unattainable levels of complexity. The following three figures show the signal path of a program configured using the PC3K's new Cascade mode:

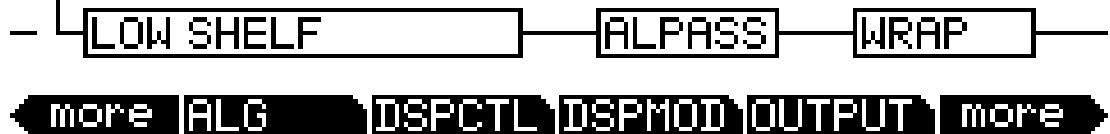
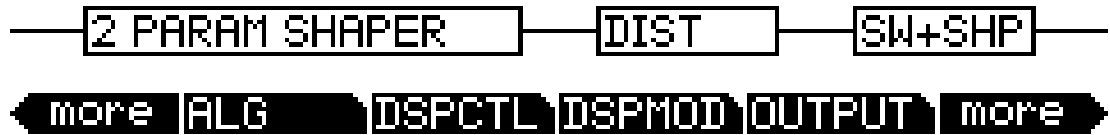

On the ALG (Algorithm) page of every layer, the Alt Input parameter lets you select any other layer to go through the current layer's DSP. You can set it up so that layer 1 goes into layer 2 into 3 (as shown above). If you turn down the volume on layers 1 and 2, then you are hearing true cascading—it's like a big chain with each algorithm feeding into the next, and what you hear is layer 3's output. You can also have the volumes of all three layers turned up, which will mix the signal of all three layers. You could, in the same program, also decide to run layer 4 into 5 into 6 into 13 into 25 if you wanted. Any of the 32 layers can go into any other layer.

The Cascade mode algorithms (very much like triple mode on a K2600) start at ID 101. Note in the above figures how algorithm 101 looks very similar to algorithm 1. Each Cascade mode algorithm corresponds to its non-cascade equivalent, which has the same ID number minus 100. For example, algorithm 105 is a cascade mode version of algorithm 5. On the Alg page, select which layer you want to have running through your cascade layer with the Alt Input parameter. Make sure to turn down the Amp volume on your source layers if you only want to hear what's coming out of the final cascade layer.

Dynamic VAST

The Dynamic VAST editor is yet another particularly powerful feature of the PC3K that allows you to edit the wiring of an algorithm. With Dynamic VAST, literally thousands of wiring schemes are possible. Using Cascade mode in conjunction with Dynamic VAST gives you almost infinite control over your program's sound and behavior by enabling you to create your own unique, complex algorithms.

To enter the Dynamic VAST editor, select the ALG (Algorithm) page by pressing the **ALG** soft button. Highlight the Algorithm parameter, select an algorithm, and press the **edit** button. This action calls up the Edit Algorithm (EditAlg) page in which you can edit the wiring of the selected algorithm.

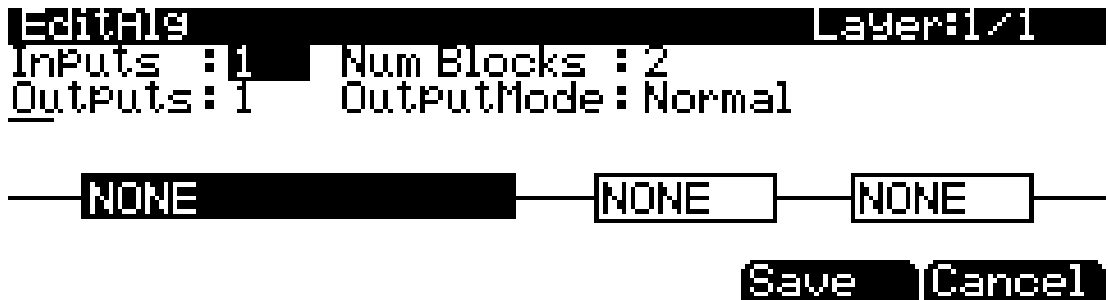

Parameter	Range of Values	Default
Inputs	1, 2	1
Outputs	1, 2	1
Number of Blocks	1 to 4	2
Output Mode	Normal, Sep. L/R	Normal

In addition to having a selectable function, each function block has three editable parameters: number of inputs, number of outputs, and block size (the Output Mode parameter is an editable parameter of the algorithm as a whole). When you first enter the EditAlg page, there will be a cursor in the parameter field, and the first block of the algorithm will be highlighted. To select a block for editing, move the cursor down the display until no parameter field is highlighted; then, using the < and > buttons, highlight the block you wish to edit. Press the ^ button to move the cursor back into the parameter fields, and then select the parameter you wish to edit.

The Output Mode parameter determines the number of outputs from the algorithm. With Output Mode set to **Normal**, the algorithm has one output. With Output Mode set to **Sep. L/R**, the algorithm has two outputs, each of which is sent to a separate stereo channel.

To edit the signal path, select either an input of a block or an output of the entire algorithm. By scrolling with Alpha Wheel or the - and + buttons, you can see every possible configuration for that selected signal path.

The DSP Control (DSPCTL) Page

Before reading further, be sure to read *Algorithm Basics* on page 6-23 and *Common DSP Control Parameters* on page 6-24.

Press the DSPCTL soft button to call up the DSP Control (DSPCTL) page, which is displayed below:

```

editProg DSPCTL Prog 999 #Layer:1/1
Pitch : 0st Fine : 0ct
LP Frq : C 4 262Hz Hz : 0.00Hz
LP Res : 0.0dB
Shp Amt : 0.365 KeyTrk : 0ct/key
None : 0 VelTrk : 0ct
Level : -6dB
more ALG DSPCTL DSPMOD OUTPUT more
    
```

Function	Parameter	Range of Values	Default
Pitch	Pitch	-128 to 127 semitones	0
	Fine Adjust	± 100 cents	0
	Hertz Adjust	± 10.00 Hertz	0
	Key Tracking	± 2400 cents/key	0
	Velocity Tracking	± 7200 cents	0
(Function)	(Function-Parameter)	(Depends on Function)	(Depends on Function)
(Function)	(Function-Parameter)	(Depends on Function)	(Depends on Function)
(Function)	(Function-Parameter)	(Depends on Function)	(Depends on Function)
(Function)	(Function-Parameter)	(Depends on Function)	(Depends on Function)
Level	Level	-96 to 24 decibels	-6
	Key Tracking	± 2.00 decibels/key	0
	Velocity Tracking	± 96 decibels	35

Each field in the left-hand column of the page is a function-parameter of the current layer’s algorithm. You can coarsely adjust the function-parameter in these left-hand fields—as noted in *Common DSP Control Parameters*, any adjustments made to the function-parameters on the DSPCTL page are reflected in the corresponding function-parameters on the DSPMOD page. The right-hand side of the DSPCTL page is the subpage of the highlighted function-parameter—on the subpage are the fine adjust parameters and hard-wired parameters. To access the parameters on the subpage, highlight the function-parameter you wish to edit, and then press the > button to move the cursor into the subpage.

The label of a function-parameter depends on its corresponding function-block in the current layer’s algorithm. The above DSPCTL page corresponds to the following algorithm:

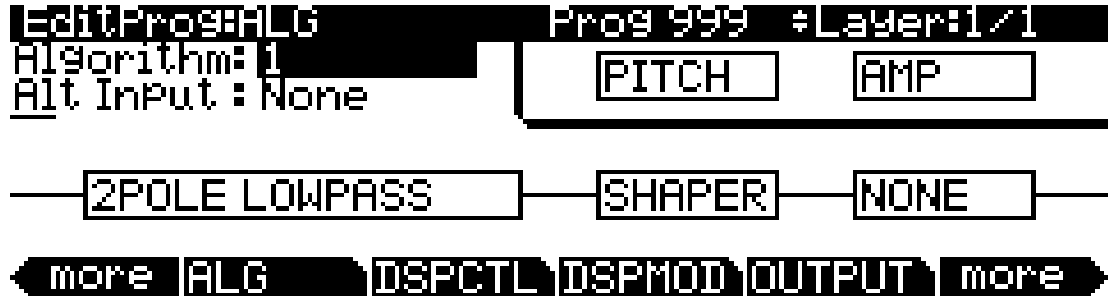

The DSP Modulation (DSPMOD) Page

Before reading further, be sure to read *Algorithm Basics* on page 6-23 and *Common DSP Control Parameters* on page 6-24.

Press the **DSPMOD** soft button to call up the DSP Modulation (DSPMOD) page, which is displayed below:

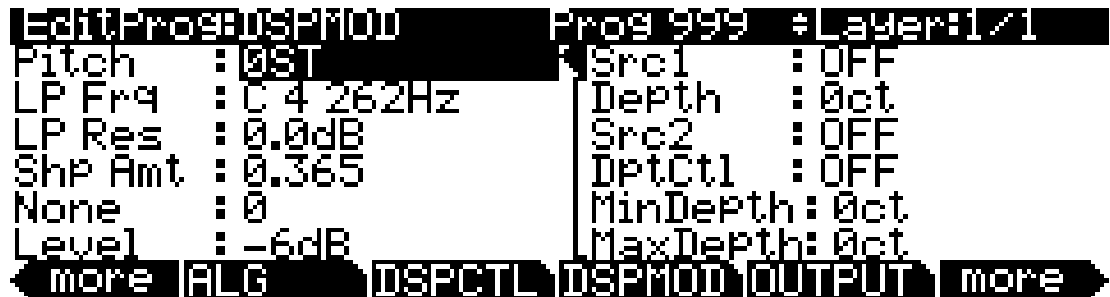

Parameter	Range of Values	Default
Source 1	Control Source List	Off
Depth	(Depends on Function)	0
Source 2	Control Source List	Off
Depth Control	Control Source List	Off
Minimum Depth	(Depends on Function)	0
Maximum Depth	(Depends on Function)	0

Each field in the left-hand column of the page is a function-parameter of the current layer’s algorithm. You can coarsely adjust the function-parameter in these left-hand fields—as noted in *Common DSP Control Parameters*, any adjustments made to the function-parameters on the DSPMOD page are reflected in the corresponding function-parameters on the DSPCTL page. The right-hand side of the DSPCTL page is the subpage of the highlighted function-parameter—on the subpage are the programmable parameters. To access the parameters on the subpage, highlight the function-parameter you wish to edit, and then press the > button to move the cursor into the subpage.

Each function-parameter's subpage contains the programmable parameters of the highlighted function-parameter. By assigning control sources to modulate a function-parameter, you can enable real-time control of your program's sound and behavior. You can assign Src1 to any control source, and can specify its maximum value with the Depth parameter. Src2 is different—you can assign it to any control source, but can also assign a control source to its maximum value with the DptCtl parameter. You can then specify the range of Src2's depth with the MinDepth and MaxDepth parameters.



Note: The PC3K features an easy shortcut for quickly assigning any of the PC3K's realtime controllers (sliders, wheels, buttons, etc.) to a currently selected parameter (such as the Src1 and Src2 parameters above.) Simply hold the **Enter** button and move the desired controller.

The label of a function-parameter depends on its corresponding function-block in the current layer's algorithm. The above DSPMOD page corresponds to the following algorithm:

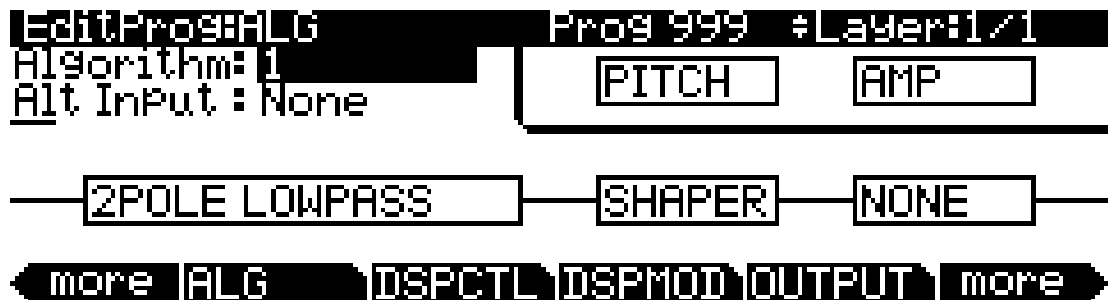

The OUTPUT Page

Press the **OUTPUT** soft button to get to the **OUTPUT** page, where you set the layer's pre- and post-FX panning. There are actually four different configurations of the **OUTPUT** page; which one you see depends on whether the current layer uses a stereo keymap, and whether it uses program FX or layer-specific effects (more on this in *The Program FX (PROGFX)* Page on page 6-47 and *The Layer FX (LYR_FX)* Page on page 6-49).

Regardless of the page's configuration, there are parameters for adjusting the pan position, the pan mode, the pan table (if any), the crossfade control, and the crossfade sense. Layers that use stereo keymaps, or that use layer-specific FX, have additional parameters on their **OUTPUT** pages. The following page is for a mono keymap program that uses program FX:



Parameter	Range of Values	Default
Pan (or Pan 1)	± 64	0
(Pan 2)	± 64	63
Pan Mode	Fixed, +MIDI, Auto, Reverse	+MIDI
(Output Pan)	± 64	0
(Output Gain)	-96 to 48 decibels	0
(Output Pan Mode)	Fixed, +MIDI	+MIDI
Pan Table	Pan Table List	0 None
Crossfade Control	Control Source List	Off
Crossfade Sense	Normal, Reversed	Norm
Drum Remap	Off, Kurz1, Kurz2	Off
Exclusive Zone Map	Zone Map List	0 None

Pan

Use this parameter to position the current layer's *pre-FX* signal. Negative values pan the signal to the left channel, positive values pan to the right, and a value of zero pans to the center. To adjust the *post-FX*, final-stage gain and panning of the current program, go to the COMMON page and adjust the Output parameters (see *The COMMON Page* on page 6-35); or to adjust a layer's *post-FX* audio signal individually, go to the LYR_FX page and set the Layer FX Mode parameter to **Layer-Specific FX** (see *The Layer FX (LYR_FX) Page* on page 6-49), and then return to the OUTPUT page and adjust the output parameters.

An additional pan parameter (Pan2) appears if you have the Stereo parameter on the KEYMAP page set to a value of **On**.

```

EditProg:OU:PU: Prog 999 = Layer:1/1
Pan1 : 0          Crossfade : Off
Pan2 : 63        XFadeSense: Norm
Pan Mode: +MIDI

Pan Table: 0 None      Drum Remap: Off
Exclusive Zone Map: 2 DrExcl01
more |ALG |DSPCTL|DSPMOD|OUTPUT| more
    
```

Pan Mode

When the mode is **Fixed** the pan position remains as defined with the Pan parameter, ignoring MIDI pan messages. When the mode is **+MIDI**, MIDI pan messages (MIDI 10) will shift the sound to the left or right of the Pan parameter setting. Message values below 64 shift it left, while those above 64 shift it right. A setting of **Auto** assigns the pan setting of each note based on its MIDI note number. In this case, Middle C (MIDI note number 60) is equivalent to the Pan parameter's setting. Lower notes shift increasingly left, while higher notes shift increasingly right. A setting of **Reverse** shifts low notes right, and high notes left. MIDI pan messages will also affect the pan position when values of Auto and Reverse are selected.

Output: Pan, Gain, and Mode

When the Layer FX Mode parameter is set to **Layer-Specific FX** on the LYR_FX page, three additional parameters appear on the OUTPUT page: Out Pan, Out Gain, and Out Pan Mode.

```

EditProg:001/001          Prog:999 #Layer:1/1
                                Crossfade :OFF
Pan      : 0                XFadeSense: Norm
Pan Mode: +MIDI            Out Pan   : 0
Out Gain : 0dB             Out Pan Mode: +MIDI
Pan Table: 0 None          Drum Remap: Off
Exclusive Zone Map: 2 DrExcl01
more ALG DSPCTL DSPMOD OUTPUT more

```

These parameters are analogous to the output parameters on the COMMON page, but are layer-specific—the COMMON output parameters apply to all layers. You can use the output parameters on the OUTPUT page to adjust the panning and gain of the *post-FX signal of the current layer*.

Pan Table

The factory preset pan tables are key-specific panning schemes by which the note that each key produces is uniquely panned. These tables are particularly useful for producing the stereo image of a drum set when creating percussion programs, or for producing the stereo image of a piano when creating piano programs.

Crossfade and Crossfade Sense (XFadeSense)

The Crossfade parameter lets you select a control source to fade the current layer's amplitude from zero to maximum. When XFadeSense is **Normal**, the layer is at full amplitude when the Crossfade control is at minimum. With XFadeSense set to **Reverse**, the layer is at zero amplitude when the Crossfade control is at minimum.

This parameter is similar to the Src1 and Depth parameters for the Amp function on the DSPCTL and DSPMOD pages, but the attenuation curve for the Crossfade parameter is optimized specifically for crossfades.

To crossfade two layers in the same program, assign the same control source for the CrossFade parameters in both layers, then set one of their XFadeSense parameters to a value of **Norm**, and the other's to **Rvrs**.

Drum Remap

The Drum Remap parameter should generally not be changed. This parameter lets the PC3K know how drum programs are mapped so that drum sounds can be properly remapped when using the General MIDI (GM) drum map (*see below*.) **Kurz1** designates that the current drum program was originally a PC2 program, and that it uses the PC2 drum map (programs 113-119 use this map.) **Kurz2** designates that the current drum kit uses the new PC3K drum map (all other factory drum programs use this map: 120, 241-248, 369-376.) The new drum map is similar to that of the PC2, except tom-tom sounds have been moved into octave C3-C4, so they are more easily playable with the main kick and snare drum sounds in that octave. When editing a kit, make sure to follow the layout of the drum map being used if you want to be able to properly remap the kit to the GM drum map. Programs that have the Drum Remap parameter set to **Off** will not be viewed by the PC3K as drum programs and will not be affected when remapping to the GM drum map.

In most keyboards and synthesizers, drum programs are mapped as dictated by the General MIDI (GM) industry standard. The GM drum map isn't optimally intuitive in terms of playability, so we developed our own unique keymap that is more intuitive and lends better to performance. However, the GM drum map is so commonplace that many players feel most comfortable playing drum programs with the GM drum map. So, we designed the PC3K such that you can remap drum programs to the GM drum map. You can set drum programs to remap to the GM drum map in Master Mode. On the Master Mode MAIN page set the drum remap parameter to **GM**. To return drum programs to their original maps, set this parameter to **None**. See *Drum Remap* on page 11-2 in the Master Mode chapter for more information.

Exclusive Zone Map

The Exclusive Zone Map is another parameter that applies principally to drum programs. When using a drum program, you may want the closed hi-hat sounds to "cut off" open hi-hat sounds. Since you can remap the keymaps of drum programs, this parameter remaps "cut off keys" accordingly.

Like Drum Remap, you can use this parameter on any program, but you probably won't want to do this.

The COMMON Page

The COMMON page is reached by pressing the **COMMON** soft button in the Program Editor. Here's where you find 12 frequently-used parameters that affect the entire current program, not just the current layer.

```

EditProg: COMMON Prog 999 All Layers
Pitch Bend Range Up: 200ct Down: -200ct
Monophonic : Off Globals: Off
OutGain : 0dB
OutPan : 0
OPanmode: +MIDI

Demo Song: 0 None
more COMMON LFO ASR FUN more

```

Notice that when the Monophonic parameter is set to its default value of **Off**, the five monophonic parameters do not appear on the page.

Parameter	Range of Values	Default
Pitch Bend Range Up	± 7200 cents	200
Pitch Bend Range Down	± 7200 cents	-200
Monophonic	Off, On	Off
(Legato Play)	Off, On	Off
(Portamento)	Off, On	Off
(Portamento Rate)	1 to 3000 keys per second	70
(Attack Portamento)	Off, On	On
(Mono Sample XFade)	Off, On	Off
Globals	Off, On	Off
Output Gain	-96 to 24 decibels	0
Output Pan	± 64	0
Output Pan Mode	Fixed, +MIDI	+MIDI
Demo Song	Demo Song List	0 None

Pitch Bend Range Up and Down

Use these parameters to define how much the pitch will change when you move your Pitch Wheel. For both Pitch Bend Range parameters, positive values will cause the pitch to bend up, while negative values will cause the pitch to bend down. Large positive values can cause samples to bend to their maximum upward pitch shift before the Pitch Wheel is fully up (or down). This will not happen when bending pitch down.

Monophonic

When off, the program is polyphonic—it can play up to 128 notes at a time. Notice that when the Monophonic parameter is off, the LegatoPlay parameter and the three Portamento parameters do not appear on the COMMON page. This is because only monophonic programs can use portamento.

When On, the program will play only one note at a time. This makes it possible to use and to determine the behavior of the portamento feature. Do not set Ignore Release On (page 6-20) when you are using Monophonic programs, since the lack of Note Off messages will prevent you from switching programs properly.

```

EditProgramCOMMON Prog 1 All Layers
Pitch Bend Range UP: 200ct Down: -200ct
MonoPhonic: On Legato: On Globals: Off
Portamento: On AttPt: Off OutGain : 0dB
Portamento Rate: 70.0key/s OutPan : 0
Mono Sample XFade: Off OPanmode: +MIDI
Demo Song: 603 PianoMellow1
more COMMON LFO ASR FUN more
    
```

Legato Play

When Legato Play is on, a note will play its attack only when all other notes have been released. This is useful for realistic instrumental sounds.

Portamento

This parameter is either on or off. The default value of **Off** means that portamento is disabled for the current program.

Portamento is a glide between pitches. On actual acoustic instruments like violin and bass, it's achieved by sliding a finger along a vibrating string. On most keyboards that offer portamento, it's achieved by holding down a key that triggers the starting note, then striking and releasing other keys. The pitch glides toward the most recently triggered note, and remains at that pitch as long as the note remains on. The PC3K gives you two ways to get portamento. See the Attack Portamento parameter below.

When applying portamento to multi-sampled sounds (Acoustic Guitar, for example), the PC3K will play more than one sample root as the pitch glides from the starting pitch to the ending pitch. This may cause a small click at each sample root transition. You can eliminate clicks by using the Mono Sample XFade parameter (see below.)

Portamento Rate

The setting for Portamento rate determines how fast the current note glides from starting pitch to ending pitch. The value of this parameter tells you how many seconds the note takes to glide one semitone toward the ending pitch. At a setting of **12 keys/second**, for example, the pitch would glide an octave every second. The list of values is nonlinear; that is, the increments get larger as you scroll to higher values.

Attack Portamento

This parameter toggles between two types of portamento. When set to **On**, the PC3K remembers the starting pitch so you don't have to hold a note on to achieve portamento. The pitch always glides to each new note from the previously triggered note. When set to **Off**, the pitch will glide to the most recently triggered note only when the previous note is still on (in other words, you must use legato fingering).

Mono Sample XFade

When applying portamento to multi-sampled sounds (Acoustic Guitar, for example), the PC3K will play more than one sample root as the pitch glides from the starting pitch to the ending pitch. This may cause a small click at each sample root transition. You can eliminate clicks by setting the Mono Sample XFade parameter to **On**. When the Mono Sample XFade parameter is set to **On**, the PC3K performs a crossfade at each sample root transition to eliminate clicks.

Globals

This is another toggle, which affects LFO2, ASR2, FUNs 2 and 4. When off, these three control sources are local; they affect each individual note in the layers that use them as a control source. They begin operating each time a note in that layer is triggered.

When the Globals parameter is set to **On**, these control sources become global, that is they affect every note in every layer of the current program, they're not specific to any one layer. When these control sources are global, they begin operating as soon as the program is selected. When Globals are on, LFO2, ASR2, and FUNs 2 and 4 will appear on their respective pages preceded by the letter G to indicate that they're global.

You'll use global control sources when you want to affect all notes in a program uniformly, and local control sources when you want to affect each note independently. For example, you'd use a global LFO controlling pitch to create a *Leslie effect* on an organ sound, since you want the effect applied to all the notes you play. You'd use a local LFO controlling pitch to create a vibrato for a solo violin, since you want to be able to vary the rate and depth of the vibrato for each note.

Output: Gain, Pan, and Pan Mode

The Output parameters on the COMMON page allow you to adjust the final-stage gain and panning of the post-FX signal. Use the OutGain parameter to cut or boost the signal. Use the OutPan parameter to pan the signal; negative values pan the audio signal to the left channel, positive values to the right, and a value of zero pans to the center.

When the OPanMode is set to **Fixed** the pan position remains as defined with the OutPan parameter, ignoring MIDI pan messages. When the OPanMode is set to **+MIDI**, MIDI pan messages (MIDI 10) will shift the sound to the left or right of the Pan parameter setting. Message values below 64 shift it left, while those above 64 shift it right.

Demo Song

The Demo Song parameter allows you to choose the demo song for the current program. The demo song is a short, pre-programmed song that gives you a demonstration of the program in a musical context. You can play a program's demo song in any page in the Program mode by pressing the **Play/Pause** button, and stop the song by pressing the **Stop** button (both buttons are located under the **MODE** buttons on the front panel).

When in the Program mode entry-level page, you can hear a demo song in whatever program you want by pressing the **Play/Pause** button with one program selected, and then selecting another program. None of the KB3 programs have demo songs, but by this method, you could, for example, hear the demo song for program **83 Big Old Jupiter** played with the KB3 program **53 Testify**.



Note: You can also trigger and stop demo songs with a simultaneous double button press of the up and down cursor buttons.

The LFO Page

LFOs are low-frequency oscillators. LFOs are used to automate the modulation of a parameter based on the shape and frequency of an audio waveform. You'll use the LFO page to define the behavior of the two LFOs available to each layer. LFOs are periodic (repeating) control sources. The basic elements are the rate, which defines how frequently the LFO repeats, and shape, which defines the waveform of the modulation signal it generates.

With the PC3K, you can set upper and lower limits on each LFO's rate, and assign a control source to change the LFO's rate in realtime, if you wish.

Because of its periodic nature, the LFO is perfect for creating effects like vibrato (cyclic variation in pitch) and tremolo (cyclic variation in amplitude). When you're editing LFOs, or any control source, remember that it must be assigned to control some parameter before you'll hear the effects of your edits.

LFO1 is always local, meaning that it's triggered with each Note On event, and runs independently for each note in the layer. LFO2 is local by default, but can be made global. This is done on the COMMON page, by setting the Globals parameter to **On**, which causes LFO2, ASR2, FUN2 and FUN4 all to become global. Global controls uniformly affect every note in each layer.

```

EditProg:LFO          Prog 999 #Layer:1/1

      MnRate MxRate RateCt   Shape   Phase
LFO1  0.00H  0.00H  OFF     None   0deg
LFO2  0.00H  0.00H  OFF     None   0deg

more COMMON LFO  ASR  FUN  more
    
```

Parameter Group (Available for each of LFO1 and LFO2)	Range of Values	Default
Minimum Rate	1/4 note, 1/8 note, 1/8 triplet, 1/16 note, 0 to 24 Hz	0.00
Maximum Rate	0 to 24 Hz	0.00
Rate Control	Control Source List	Off
LFO Shape	LFO Shape List (Ref. Guide)	Sine
LFO Start Phase	0, 90, 180, 270 Degrees	0

Minimum Rate

This is the slowest rate at which the LFO runs. When its Rate Control is set to **OFF**, or when the control source assigned to it is at its minimum, the LFO runs at its minimum rate. As previously mentioned, the values 1/4 note, 1/8 note, 1/8 triplet, and 1/16 note sync the Minimum Rate with the PC3K's system tempo. Of course, if you choose to tempo sync your LFO, then the LFO rate is fixed, and you can specify neither Maximum Rate nor Rate Control. The display changes thusly:

```

EditProg:LFO          Prog 999 #Layer:1/1

      MnRate MxRate RateCt   Shape   Phase
LFO1  1/8 tr          None    0deg
LFO2  0.00H  0.00H  OFF     None    0deg

more COMMON LFO  ASR  FUN  more

```

Maximum Rate

This is the fastest possible rate for the LFO. When its Rate Control is set to **ON**, or when the control source assigned to it is at its maximum, the LFO runs at its maximum rate.

Rate Control

Assign any control source in the list to modulate the LFO's rate between its minimum and maximum. A continuous control like the Mod Wheel is a natural choice, enabling you to get just about any rate between minimum and maximum. But you can use a switch control too, to get just the minimum or maximum with nothing in between. Assigning **MPress** (aftertouch) as the rate control for an LFO vibrato gives you an easy way to increase the vibrato rate in realtime, as you can on many acoustic instruments.

LFO Shape

The shape of the LFO waveform determines the nature of its effect on the signal its modulating. An easy way to check the effects of the different LFO shapes is to set **LFO1** as the value for the Src1 parameter on the PITCH page, and set the Depth for Src1 to **400 cents** or so. Then go to the LFO page, set the Min and Max rates for LFO1 at **0.00 Hz** and **4.00 Hz** or so, and set the Rate control to **MWheel**. Now play your MIDI controller and you'll hear the LFO's rate change when you move its Mod Wheel. Select different LFO Shapes and check out the effect on the pitch.

LFO Phase

Use this parameter to determine the starting point of the LFO's cycle. One complete cycle of the LFO is 360 degrees. 0 degrees phase corresponds to a control signal value of 0, becoming positive. Each 90-degree increment in the phase represents a quarter-cycle of the LFO.

When an LFO is local, the phase parameter gives you control over the starting point of the LFO for each note (for example, you could make sure every vibrato started below the pitch you played instead of at the pitch you played). The LFO's phase also affects global LFOs, although it's often indistinguishable, since global LFOs start running as soon as the program containing them is selected, even if you don't play any notes.

The ASR Page

ASRs are three-section unipolar envelopes—attack, sustain, and release. The PC3K’s ASRs can be triggered by a programmable control source, and can be delayed. ASR1 is always a local control. ASR2 is local by default, but becomes global if the Globals parameter on the COMMON page is set to **On**. ASRs are frequently used to ramp the depth of pitch or amplitude in a vibrato or tremolo, enabling delays in those effects. The ASR page consists of two rows of five parameters, one row for each of the ASRs.

```

EditProgASR          Prog 999 #Layer:1/1

      Trigger  Mode  Delay  Attack  Release
ASR1 OFF      Norm  0s    0s     0s
ASR2 OFF      Norm  0s    0s     0s

more COMMON LFO ASR FUN more
    
```

Parameter	Range of Values	Default
Trigger	Control Source List	Off
Mode	Normal, Hold, Repeat	Normal
Delay	0 to 30 seconds	0 seconds
Attack	0 to 30 seconds	0 seconds
Release	0 to 30 seconds	0 seconds

Trigger

This defines the control source that starts the current layer’s ASRs. The ASR starts when the trigger switches from off to on. If the Trigger parameter is set to **ON**, a global ASR starts running immediately when you select a program that contains it. A *local* ASR starts running as soon as you trigger a note in the layer that contains it. Switch controls are better suited for ASR triggers because of their binary (on/off) nature. A continuous control will trigger the ASRs when its signal value is above its midpoint.

Mode

This parameter sets the sustain section of the ASR. The ASR’s mode determines what the ASR does when it finishes its attack section. If the Mode parameter is set to **Normal**, the ASR will run directly from its attack section to its release section (no sustain). At a setting of **Repeat**, the ASR will cycle through the attack and release sections, then loop forward and cycle through again until the ASR’s trigger switches off. If the mode is set to **Hold**, the ASR maintains its position at the end of the attack section until the ASR’s trigger switches off. The ASR then goes into its release section. If the ASR’s trigger switches off before the attack section is complete, the ASR goes directly to its release section.

Delay

When the ASR’s trigger switches on, the ASR will start immediately if this parameter is set to zero. Nonzero values will cause a corresponding delay between the ASR trigger and the start of the ASR.

Attack

This defines how long the ASR takes to ramp up from minimum to maximum effect on whatever it's patched to.

Release

This defines how long the ASR takes to fade to minimum from its maximum. If the ASR's trigger switches off before the ASR has reached maximum, the ASR releases from that level.

The Function (FUN) Page

FUN is short for function. The PC3K's four FUNs greatly extend the flexibility of the control sources. Each FUN accepts input from any two control sources, performs a selectable function on the two input signals, and sends the result as its output, which can be assigned like any other control source. Using the FUNs involves defining them on the FUN page, then assigning one or more of them as control sources. The FUN page looks like this:

```

EditProgFUN          Prog 999 #Layer:1/1
  Input a      Input b      Function
FUN1  OFF      OFF      None
FUN2  OFF      OFF      None
FUN3  OFF      OFF      None
FUN4  OFF      OFF      None
more  COMMON LFO  ASR  FUN  more

```

There are three parameters for each FUN. Inputs **a** and **b** can be any control source from the Control Source list. The control sources you want to combine are the ones you'll assign as the values for these parameters.

The Function parameter determines what mathematical function is applied to the two inputs. When a FUN has been assigned as a control source, the PC3K reads the values of the two control sources defined as Inputs **a** and **b**. It then processes them according to the setting for the Function parameter, and the resulting value is the FUN's output.

The Amplitude Envelope (AMPENV) Page

Amplitude envelopes have three sections: attack, decay, and release. The attack section determines how long each note takes to reach its assigned amplitude level after you trigger a Note On event. The decay section determines how quickly and how much a sustained sound fades before a Note Off is triggered. The release section determines how quickly a sound fades to silence *after* a Note Off is triggered.

Press the **AMPENV** soft button to reach the Amplitude Envelope page. For many programs, it will look like the diagram below, which tells you that the amplitude envelope for the current layer is the sample’s default “natural” envelope. Many factory ROM programs use the natural envelope, which is custom designed for each sample and waveform during its original development process. A natural envelope usually contains more detail than a user envelope, and may make samples of acoustic instruments sound more realistic.



If you want to build your own amplitude envelope, just turn the Alpha Wheel a click. The value **Natural** will change to **User**, and a set of AMPENV parameters will appear. The sound will change when you do this, because the default settings for the User envelope, as shown in the diagram below, take effect as soon as you leave Natural mode. Returning to Natural mode applies the original amplitude envelope once again.

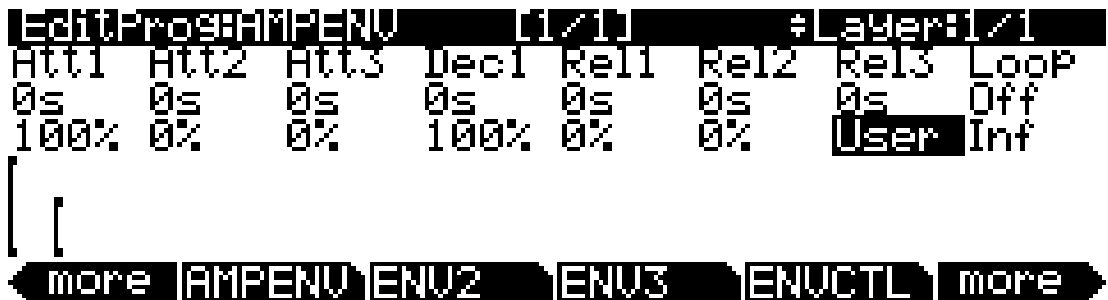

You’ll tweak the parameters on the AMPENV page when you want to shape the amplitude characteristics of your sounds. A graphic view of the amplitude envelope will appear on the display to give you a visual sense of the envelope’s characteristics. The dots along the envelope graphic indicate the breakpoints between the envelope’s various segments.

The AMPENV page’s top line gives you the usual location reminder, points out the currently selected layer, and tells you the relative scale of the envelope’s graphic view. The envelope graphic shrinks in scale as the segment times get longer. This auto-zoom feature maximizes the available display space. Try lengthening one of the segment times. The envelope graphic will stretch to fill the display from left to right. When it fills the display, it will shrink to half its size, and the top line will indicate that the scale has changed (from [1/1] to [1/2], for example).

Each parameter on this page has two values, as listed below. For the envelope segments, the first (upper) value is the duration of the segment, and the second is the amplitude level at the completion of the segment. For the Loop parameter, the values define how the envelope loops, and how many times the loop cycles.

Parameter Group	Parameter	Range of Values
Attack Segment 1, 2, 3	Time	0 to 60 seconds
	Level	0 to 100%
Decay Segment	Time	0 to 60 seconds
	Level	0 to 100%
Release Segment 1, 2, 3	Time	0 to 60 seconds
	Level	0 to 150% (Release Segment 3 is always set to 0%)
Loop	Type	Off, Forward, Bidirectional
	# of loops	Infinite, 1 to 31 times

Attack Segment Times

These indicate how long it takes for the current layer's amplitude to reach its final level from its starting level.

Attack Segment Levels

These are the final levels that each segment achieves at completion. The levels are expressed as percentages of the maximum possible amplitude for the current layer. Attack segment 1 always starts at zero amplitude, and moves to its assigned level in the time specified by its time value. So the default settings of **0 seconds** and **100%** mean that the first segment of the attack section moves instantly from zero amplitude to 100% amplitude. Increase the time of Attack segment 1 if you want the sound to ramp up more slowly.

Attack segments 2 and 3 affect the sound only when you set a nonzero value for time. They will then move to their assigned levels in the time specified. Their starting levels are equal to the final levels of the preceding segment.

Decay Segment

The decay section has only one segment. It has values for time and level, just as for the attack section. The decay section begins as soon as the attack section has been completed. It starts at the same amplitude level as the attack segment preceding it, and moves to its assigned level in the time specified. You'll hear a note's decay section only when the attack section is completed before a Note Off message is generated for that note.

To create a sustaining envelope, simply set the Decay segment's level to a nonzero value.

Release Segments

Like the attack and decay sections, each of the three segments in the release section has values for time and level. Each segment reaches its assigned level in the time specified for that segment. Release segment 1 starts at the Note Off event for each note, at the current amplitude level of that note—whether it's in the attack section or the decay section. It then moves to its assigned level in the time specified. Release segments 2 and 3 start at the final levels of the segments

before them. Release segments 1 and 2 can be set to any level from 0 to 150%. Release segment 3 always has a level of 0%, so you can't adjust its level. In place of its Level parameter you see a parameter that lets you toggle between User envelopes and the sound's preprogrammed natural envelope.

Loop Type

There are seven different values for Loop type.

A value of **Off** disables looping for the current layer's amplitude envelope.

Values of **seg1F**, **seg2F**, and **seg3F** are forward loops. In each case, the amplitude envelope plays through the attack and decay sections, then loops back to the beginning of the first, second, or third attack segments, respectively.

Values of **seg1B**, **seg2B**, and **seg3B**, are bidirectional loops. The amplitude envelope plays through the attack and decay sections, then reverses and plays backward to the beginning of the first, second, or third attack segment, respectively. When it reaches the beginning of the assigned attack segment, it reverses again, playing forward to the end of the decay section, and so on.

Number of Loops

A value of **Inf** makes the amplitude envelope loop until a Note Off is generated. Values of 1 through 31 indicate how many times the loop will repeat after the amplitude envelope has played once through its normal cycle.

Regardless of the loop type and the number of loops, each note goes into its release section as soon as its *Note State* goes off (that is, when a Note Off is generated). The envelope will continue to loop as long as Note State remains on, whether it's held on by a pedal, by the IgnRel parameter (described in the section entitled *The LAYER Page* on page 6-17), or anything else.

The Envelope 2 (ENV2) and Envelope 3 (ENV3) Pages

The PC3K offers two envelopes in addition to AMPENV. Like AMPENV, ENV2 and ENV3 can be assigned like any other control source. Unlike AMPENV, however, ENV2 and ENV3 can be bipolar. This means that you can set negative values for them. (Obviously, you can't have an amplitude less than zero, so AMPENV is unipolar—the values range from either 0 to 100% or 0 to 150%.) A bipolar envelope controlling pitch, for example, could modulate the pitch both above and below its original level.

Another difference is that AMPENV *always* controls the amplitude of the layer, so even if you use it as a control source for other functions, it will still affect the layer's amplitude. ENV2 and ENV3 affect only those layers that have them assigned as a control source. Also, AMPENV uses an exponential attack (the amplitude rises much faster at the end of the attack segment than it does at the beginning), while ENV2 and ENV3 use linear attacks (the attack segment increases at the same rate from start to finish).

EditProgramENV2				L1/L1			#Layer:1/1
Att1	Att2	Att3	Dec1	Rel1	Rel2	Rel3	Loop
0s	0s	0s	0s	0s	0s	0s	Off
100%	0%	0%	100%	0%	0%	0%	Inf
.

more AMPENV ENV2 ENV3 ENVCTL more

The pages for Envelopes 2 and 3 are reached with the soft buttons ENV2 and ENV3. When you select these pages, you'll find a display that looks very much like the AMPENV page. The only differences are that you can program an amount for Rel3; the Rel1 and Rel2 limits, which are $\pm 100\%$; and in the envelope graphic, which has a dotted line running horizontally across the display. This is the zero level line; negative level values for the various envelope segments will cause the envelope graphic to dip below this line.

The Envelope Control (ENVCTL) Page

The Envelope Control page gives you realtime control over the rates of each section of the amplitude envelope for both natural and user envelopes (see *The Amplitude Envelope (AMPENV) Page* on page 6-42.) Press the ENVCTL soft button to reach the ENVCTL page.

EditProgENVCTL		Prog 999		#Layer:1/1		
	Adjust	KeyTrk	VelTrk	Source	Depth	
Attack:	1.000x	1.000x	1.000x	MIDI73	1.000x	
Decay:	1.000x	1.000x		MIDI72	1.000x	
Releas:	1.000x	1.000x		MIDI71	1.000x	
Impact:	0.0dB	0.0dB	0.0dB	MIDI70	0.0dB	
more		AMPENV	ENV2	ENV3	ENVCTL	more

The display's top line reminds you of the current layer. The column on the left lists the three section types of the amplitude envelope, and each corresponding line lists the values for the five DSP control parameters that are available for each section type. The DSP control parameters are: Adjust, Key tracking, Velocity tracking, and Source/Depth, which are listed at the top of each corresponding column. When AMPENV is set to **User** mode, the Attack and Release sections on this page apply to the attack and release sections on the AMPENV page. It's important to keep in mind that the values for the various parameters are cumulative, meaning that if for example you set attack to be controlled by KeyTrk and VelTrk, the resulting change on Attack would be affected by the combination of the values produced by KeyTrk and VelTrk. Also note that unlike previous Kurzweil models, ENVCTL *does* affect the attack sections of natural envelopes. Additionally, the bottom line of this page lets you make use of the Impact feature, which lets you boost or cut the amplitude of the first 20 milliseconds of a note's attack.

The parameters and values in the following parameters list (see below) apply to *each* of the three envelope sections—attack, decay, and release. We'll describe them only once, since their functions are largely the same for each envelope section. The only difference is with velocity tracking, which is only available as a parameter to control attack sections of the amplitude envelope (however, you can assign attack velocity as the value for the Source parameter in each of the sections).

The values of each of these parameters multiply the *rates* of the envelope sections they control. Values greater than **1.000x** make the envelope sections run *faster* (they *increase* the rate), while values less than **1.000x** make the envelope sections run *slower*. Say for example that on the current layer's AMPENV page you had set the Decay section's time at **2.00 seconds**, and its level at **0%**. This sets the layer's amplitude to fade to silence two seconds after the completion of the last attack segment. The decay *time* is two seconds; the decay *rate* is 50% per second. Now if you select the ENVCTL page and set the Decay Adjust parameter to a value of **2.000x**, you've increased the decay *rate* by a factor of two, making it twice as fast. The rate increases to 100% per second, and the decay time is now one second instead of two.



Note: Since 0 multiplied by any number equals 0, the envelope parameters on this page will have no effect on any AMPENV sections set to 0 seconds. A way around this is to change any AMPENV sections set to 0 to 0.02 seconds.

Parameter Group (Available for each of Att, Dec, Rel, Imp)	Range of Values
Adjust	0.018 to 50.000x (-24.0 to 24.0 dB for Imp)
Key Tracking	0.018 to 50.000x (-2.00 to 2.00 dB for Imp)
Velocity Tracking	0.018 to 50.000x (Not available for Dec or Rel; -24.0 to 24.0 dB for Imp)
Source	Control Source List
Depth	0.018 to 50.000x (-24.0 to 24.0 dB for Imp)

Adjust

This is the familiar Coarse adjust found on many other pages. Use it here to change the rate of one of the envelope sections without reprogramming the envelope itself. This parameter doesn't give you realtime control over the envelope. It is, however, a good way to adjust the natural envelopes without switching to a User envelope and trying to approximate the Natural envelope.

Key Tracking

This uses the MIDI note number of each key as the control input for the current layer's corresponding envelope section. When the value of this parameter is greater than **1.000x**, notes above C 4 will make the envelope section run faster, while notes below C 4 will make it run slower. When the value of this parameter is less than **1.000x**, notes above C 4 will make the envelope section run slower, and notes below C 4 will make it run faster. This gives you realtime envelope control right from your MIDI controller. You might use it, for example, to cause an acoustic guitar sound to decay quicker at the high end of the keyboard (set the key tracking to a positive value).

Velocity Tracking

Use your attack velocity as the control input for the current layer's attack section (this parameter doesn't apply to decay or release). When the value of this parameter is greater than **1.000x**, attack velocities greater than 64 make the attack section run faster, and attack velocities below 64 make it run slower. This gives you realtime attack control over the envelope.

Source, Depth

These two parameters work together to let you assign a control like the Mod Wheel to affect the current layer's amplitude envelope in realtime. The value of the Source parameter defines which control affects the envelope section, and the value of the Depth parameter defines how much the rate is multiplied when the control is at its maximum value, 127. No effect is had when the control is at its minimum value, 0, and Depth values are scaled for controller values in between.



Note: For each note triggered, you can only set the controller value that will scale the Depth parameter of an envelope section before that section of the envelope is triggered. For controllers assigned for Attack, the controller value used will be the last received before the note is triggered. For controllers assigned for Decay, the controller value used will be the last received before the final section of the attack envelope reaches its maximum amplitude. For controllers assigned for Release, the controller value used will be the last received before the note is released. To put it another way, for each envelope section, you cannot change the rate of a note's envelope once that section of the envelope has been triggered.

Impact

Impact can boost or cut note volume by up to 24 dB during the first 20 milliseconds of the attack of an envelope. This feature is an easy way to get more “thump” from your bass and drum sounds.

The Program FX (PROGFX) Page

Press the PROGFX soft button to call up the Program FX (PROGFX) page. This is the page that you will use to apply effects to a program, and to configure the routing of the various pre- and post-FX audio signals. Effects chosen on this page affect *every layer* of the current program. The section *The Layer FX (LYR_FX) Page* on page 6-49 contains information on using layer-specific effects. The PROGFX page looks like this:

```

editProgFX PROGFX 0/0 Units All Layers
Insert: 0 None Output: Main
Aux 1: 0 None Output: Main
Aux 2: 0 None Output: Main
Aux1 Send: off Pre/Post ins: Post Type: dB
Aux2 Send: off Pre/Post ins: Post Type: dB
Aux1 Mod : ON Aux2 Mod : ON
more PROGFX LYR_FX CTLs SetCtl more
    
```

Parameter	Range of Values	Default
Insert	Chain List	0 None
Aux 1, Aux 2	Chain List	0 None
Output	Main, Sec.	Main
Auxiliary Send Parameters	Aux Send (dB)	off, -95 to 24 decibels
	Aux Send (%)	0 to 100%
	Aux Pre/Post Insert	Post, Pre
	Type	dB, %
Aux Modulation	Control Source List	On

On the PC3K, a program can have up to 11 insert effects and 2 aux effects using up to 16 DSP “units.” An insert is essentially just an effect that you apply to a program or layer, while aux effects receive signal from all active programs’ aux sends. Note the 0/0 Units in the middle of the top line of the page. This figure indicates how many of the total units are being used by the highlighted insert; the left-hand number is the size of the insert, and the right-hand number is the total number of units being used by the program.

If you exceed the maximum number of DSP units, the PC3K will notify you that you have done so, and no effects will be applied to the program.

Insert

The Insert effect is the effects chain that is applied to the main audio bus.

Aux 1, Aux 2

The Aux effect is the effects chain that is applied to the selected auxiliary audio bus.

Output

The Output specifies the analog output to which the selected bus is routed. Setting the Output to **Main** routes the signal of the selected bus to the main outputs. Setting the Output to **Sec.** routes the signal of the selected bus to the auxiliary outputs.

Auxiliary Send Parameters

The Auxiliary Send parameters determines the level of the program signal sent to the auxiliary effects chain.

Aux Send

The Aux Send parameter determines the level of the program signal sent to the auxiliary effects chain.

Pre/Post Insert

The Pre/Post Insert parameter determines the point at which the auxiliary effect is applied to the signal. When this parameter is set to **Post**, the PC3K applies the auxiliary effect to the signal *post-insert*, i.e., after the insert effect has been applied. When this parameter is set to **Pre**, the PC3K applies the auxiliary effect to the signal *pre-insert*.

To hear a program put through two effects in series (i.e., through two cascaded effects), choose your desired effects for the Insert and either Aux (for whatever Aux you choose, the other should be set to **0 None**), set each bus' Output to **Main**, and set the Aux Send parameter to either **0 dB** or **100%**. Then, set the Pre/Post Insert parameter to **Post**.

To hear a program put through two effects in parallel (i.e., through two distinct effects), choose your desired effects for the Insert and either Aux (again, for whatever Aux you choose, the other should be set to **0 None**), set each bus' Output to **Main**, and set the Aux Send parameter to either **0 dB** or **50%**. Then, set the Pre/Post Insert parameter to **Pre**.

With respect to each other, the Auxes are always in parallel, that is, they cannot be cascaded.

Type

The Type parameter determines how the selected wet aux signal (i.e., with effects applied) is mixed into the final signal. Additionally, it determines the units in which the Aux Send parameter values are.

When Type is set to **dB**, the Aux Send parameter values are in units of decibels (dB). The value specified in the Aux Send parameter is the amount of program signal sent to the aux effects chain. To hear equal parts wet signal and dry signal (the signal with no effects applied) on the main audio output, set the main Insert effect to **0 None** and the Insert Output to **Main**, and set the Aux 1 effect to your desired effect and the Aux 1 Output to **Main**. Then, set the Aux1 Send to **0dB**. If you want only wet signal on the main audio output, set the main Insert Output to **Sec.**—*keep in mind that by this method, the dry signal is sent to the auxiliary audio outputs.*

When Type is set to **%**, the Aux Send parameter values are in units of percent (%). The value specified in the Aux Send parameter is the percentage of which the wet auxiliary signal comprises the final signal—the insert signal comprises the rest of the final signal. To hear equal parts wet signal and dry signal on the main audio output, set the main Insert effect to **0 None** and the Insert Output to **Main**, and set the Aux 1 effect to your desired effect and the Aux 1 Output to **Main**. Then, set the Aux1 Send to **50%**. If you want to hear only the wet signal, set the Aux1 Send to **100%**.

Aux1 Mod, Aux2 Mod

The Aux Mod parameter gives you real-time control over the amount of program signal sent to the aux effects chain. You can set the Aux Mod parameter to any PC3K control source. The amount that you specify for the Aux Send parameter is the maximum value that the Aux Mod control source can send—the minimum value is 0.

The Layer FX (LYR_FX) Page

Press the **LYR_FX** soft button to call up the Layer FX (LYR_FX) page. On this page, you can apply layer-specific effects. There are three Layer FX Modes: **Use Program FX**, **Layer-Specific FX**, and **Use Another Layer's FX**.

Use Program FX Mode

With **Use Program FX Mode** selected, the current layer will use the effects configured on the Program FX (PROGFX) page. See *The Program FX (PROGFX) Page* on page 6-47 for more information on program FX.

Layer-Specific FX Mode

With **Layer-Specific FX** selected, you can configure the effects for the current layer. This mode's parameters are similar to those of the PROGFX page. This mode is shown in the following display:

```

EditProg LAYER FX 0/0 Units ◀Layer:1/1
Layer FX Mode      : Layer-Specific FX
Insert: 0 None           Output: Main
Aux1 Send: off       Pre/Post ins: Post  Type: dB
Aux2 Send: off       Pre/Post ins: Post  Type: dB
Aux1 Mod  : ON        Aux2 Mod  : ON

more  PROGFX  LYR_FX  CTLS  SetCtl  more

```

All of the Layer-Specific FX mode parameters have the same functions and ranges of values as their corresponding parameters on the PROGFX page. See *The Program FX (PROGFX) Page* on page 6-47 for more information on these parameters.

Use Another Layer's FX Mode

With **Use Another Layer's FX** selected, you can put the current layer through the effects of another layer. You can specify the layer through whose effects you wish to put the current layer.

The Controllers (CTLS) Page

Press the **CTLS** soft button to call up the **CONTROLLERS** page. The **CONTROLLERS** page shows a list of the PC3K's controllers (sliders, Mod wheel, switch, etc.) which can be used to control program parameters. Use this page to set values for each controller that will be saved with the program (entry values.) When a program is loaded, the entry values on this page are sent to any program parameters that have been assigned to these controllers.

For example, the electric piano program **25 WoodstockClunker** has Tremolo Depth assigned to be controlled by the Mod Wheel. Turning up the Mod Wheel increases the Tremolo Depth and allows you to hear more of the Tremolo effect. If you look at the **CONTROLLERS** page for **25 WoodstockClunker**, **Modwheel (1)** is set to **37**. This means the Mod Wheel sends a value of 37 to set Tremolo Depth when the program is selected, allowing you to hear the Tremolo effect. If you do not want to hear the Tremolo effect when the program is selected, edit the program and use the **CONTROLLERS** page to set **Modwheel (1)** to **0**, then save the program.

For controllers that have an entry value set to **None**, no value is sent for that controller when a program is loaded. When an entry value of **None** is used, the value last used for that controller (in the previous program or setup) is used. To set a value of **None**, use the alpha wheel or +/- buttons to scroll below 0, or use the alphanumeric pad to enter -1, then press the Enter button.

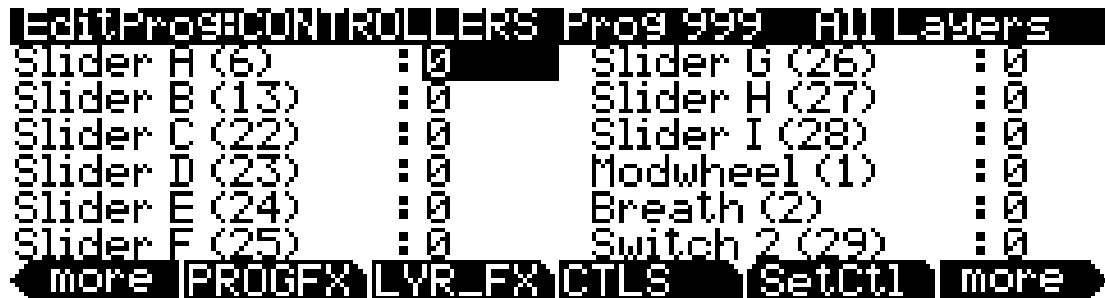

Controller	Range of Values	Default Value
Slider A (6)...Breath (2)	None, 0-127	0
Switch 2 (29)	None, 0, 127	0

You can automatically set the values on the **CONTROLLERS** page to the physical controllers current values by using the **SetCtl** soft button (located to the right of the **CTLS** soft button.) The **SetCtl** soft button captures the positions of the controllers listed on the page.



Note: If you change programs, and then press the **SetCtl** soft button before moving any of the controllers, the parameters on the **CONTROLLERS** page will remain at their previously set values.

The number in parentheses that appears next to each controller name is the MIDI controller number that each controller transmits *by default*, i.e., with the Control Setup set to **126 Internal Voices** on the MIDI mode Transmit page. See *Control Setup* on page 6-9 for details.

INFO

Press the INFO soft button to go to the INFO page where you can edit the controller assignment info for the current program. Each info entry is a description of a program parameter that you have assigned to be controlled by a physical controller or MIDI CC number. Info can be viewed from the Program mode or Setup mode main page by pressing the **Info** soft button. If the Display parameter is set to Ctls on the Master Mode MAIN page, controllers with info text will show the info on the left side of the Program mode or Setup Mode main page when moved (see *Display* on page 11-3 for details.)

On the INFO page, use the **Chan/Layer** buttons to scroll through the current program's list of controller assignment info. Each assignment info entry has a MIDI controller number and a Text parameter to describe what the assignment controls. One info entry can be made for each MIDI CC number.

To edit the text of a controller assignment, press the **Text** soft button. To create a new controller assignment info entry, press the **New** soft button (you will be prompted for a MIDI controller number.) To create a new controller assignment info entry with the same text as the current info entry, press the **Dup** soft button (you will be prompted for a new MIDI controller number, only one info entry can be made for each MIDI CC number.) To delete the current controller assignment info entry, press the **Delete** soft button (you will be prompted to confirm or cancel.) To return to the program editor press the **Done** soft button or the **Exit** button. See *Export* on page 13-15 for details on exporting program info.

Automatic Info Creation



Note: The following does not apply to controller assignments made for effects within the Chains editor. Info text for Chains must be manually created using the INFO page in the Chains Editor.

When assigning a controller to a parameter on any of the Program Editor pages, an Info text entry is automatically created. An **i** appears on the top line of the page to indicate that Info text has been created. If you return the controller assignment to **OFF**, the **i** disappears, indicating that the Info text has been removed (unless you have gone to the INFO page, see note below.) The automatically created info will use the parameter name for the Info text. To rename the Info text, press the Edit button while the controller assignment field is still selected. This will bring you to the Info Editor page (see above) and the Info entry for the assigned controller. From the Info Editor page, press the Exit button to return to the page where you made the controller assignment.



Note: After assigning a controller to parameter, if you go to the INFO page, the Info text entries for each controller assignment will remain set unless you remove them with the Delete soft button on the INFO page. If you change the controller assignment for a parameter after going to the INFO page, the parameter's last Info text entry will remain in addition to the newer Info text entry automatically made for the controller assignment. This is done to ensure that user renamed Info text does not get deleted if a controller assignment was accidentally changed while editing the program. To remove an unused Info text entry, locate the entry on the INFO page and use the Delete soft button.

Function Soft Buttons

This section describes the soft buttons that perform specific functions, as opposed to selecting programming pages. The descriptions below are arranged in the order in which you would see the soft buttons if you pressed the **more>** button repeatedly. You can always get to these buttons, regardless of which page is currently selected.

Set Controllers (SetCtl)

As explained in *The Controllers (CTLS) Page*, the **SetCtl** soft button captures the values of the nine sliders, modwheel, breath controller, and switch.

New Layer (NewLyr)

Create a new layer, numbered one above the highest existing layer. The new layer's parameters are those of the single layer in Program 999, called **Default Program**. When you press this button, the PC3K will tell you that it is creating a new layer, then will return to the page you were on. The new layer becomes the current layer, and is the highest-numbered layer in the program. If the current program already has its maximum number of layers, the PC3K will tell you that you can't add any more.

Program 999 makes a good template for programs that you build from the algorithm up. You might want to edit Program 999 to adjust one or more parameters to values you want to use in your template program. If you like the settings of the default layer as they are, however, remember not to make any permanent changes to Program 999.

Duplicate Layer (DupLyr)

Create a copy of the current layer, duplicating the settings of all its parameters. The copy becomes the current layer, and is the highest-numbered layer in the program.

Import Layer (ImpLyr)

Copy a specific layer from another program into the current program. This button brings up a dialog that prompts you to select a layer number and a program number. The dialog tells you the currently selected layer, and the total number of layers in the program. Use the **Layer-** or **Layer+** soft buttons (or the alpha wheel) to change the layer number. If the current program has only one layer, pressing these buttons will have no effect. Use **Prog-** or **Prog+** soft buttons (or the alpha wheel) to change the program number.

While you are in this dialog, you can listen to the layer you are selecting to import, along with all other layers in the current program. If you want to hear the layer to be imported by itself, you must mute the other layers.

When you have selected the desired layer from the desired program, press the **Import** soft button, and the selected layer will be copied from the selected program, becoming the current layer. Importing layers is a convenient alternative to creating layers from scratch. If you have a favorite string sound, for example, and you want to use it in other programs, just import its layer(s) into the program you're building. This will preserve the envelopes and all the control settings so you don't have to reprogram them.

Delete Layer (DelLyr)

Delete the current layer. When you press this button, the PC3K asks you if you want to delete the layer; press the **Yes** soft button to start the deletion process, or the **No** soft button to cancel it. This prompt prevents you from accidentally deleting a layer.

Name, Save, Delete

Name calls up the page that enables you to change the name of the current program. **Save** starts the process of saving the current program. **Delete** deletes the current program from memory. You can also delete any other program from memory by scrolling through the list that appears when you press the **Delete** soft button, then pressing Delete again when the desired program is selected. If you attempt to delete a ROM program, the PC3K will say it's deleting the program, but it doesn't actually do it.

Editing VAST Programs With KVA Oscillators

The PC3K uses KVA oscillators as another way to generate sounds in VAST programs. Unlike keymaps, which play samples stored in ROM, KVA oscillators create DSP-generated waveforms every time they are triggered. The KVA oscillators can create a range of waveforms, from high quality simple waveforms familiar to users of classic analog synths, to complex waveforms which take advantage of the PC3K's internal processing power and complex signal routing capabilities. Though the PC3K does have keymaps containing samples of basic synth waveforms, the use of KVA oscillators provides users with better portamento, more modulation options, higher sound quality, and other advantages which will be explained in this section. Learning to use KVA oscillators instead of keymaps (where appropriate) is simple and will increase the versatility of your VAST editing capabilities. VAST programs using layers with KVA oscillators can also be combined with other layers using keymaps.

Basic Use of KVA Oscillators

To understand the basic minimal setup of a KVA based program, select the program **1019 VA1NakedPWMPoly**, and press the **Edit** button. If you are familiar with editing VAST programs, the first thing you may notice is that on the KEYMAP page, Keymap is set to **999 Silence** (More on this in *Advanced Use Of KVA Oscillators* on page 6-55.) Next, look at the AMPENV page. The AMPENV mode is set to **User**, which gives you control over the amplitude envelope (more on using **Natural** mode later.) Finally, look at the ALG page. In the current algorithm the 3 block KVA oscillator **PWM** has been selected, which generates the sound for this layer of the program.

Minimal Settings for Basic Use of KVA Oscillators:

The patch described above contains the minimal settings that a KVA layer needs in order to function in the style of a classic analog synth. These minimal settings are:

1. EditProg:KEYMAP Page: Set the Keymap parameter to **999 Silence**.
2. EditProg:AMPENV Page: Set the Envelope mode to **User**, and adjust the amplitude envelope to your liking (see *The Amplitude Envelope (AMPENV) Page* on page 6-42.).
3. EditProg:ALG Page: Pick an Algorithm and set an Oscillator (see *Setting KVA Oscillator Type* below.)

Further basic VAST settings that you will likely want to adjust are:

- Monophonic On/Off (see *The COMMON Page* on page 6-35.)
- Level Velocity Tracking (see *The DSP Control (DSPCTL) Page* on page 6-29.)

Read the *Setting KVA Oscillator Type* section below to learn about how set each type of oscillator. After doing this, you can experiment with making KVA programs by following the above settings, and then setting and listening to each type of oscillator. Once you understand how to do this, read on to the *Advanced Use Of KVA Oscillators* section on page 6-55 (see below) to learn how to make your KVA patches more expressive through the use of DSP modulation.

Pitch Settings for KVA Oscillators

Each oscillator (except for noise functions) has its own pitch parameters, and is unaffected by pitch settings that would normally affect keymaps (such as those on the Keymap page.) On a program layer, the coarse pitch parameter for the oscillator in use can be found on both the DSPCTL and DSPMOD pages, in the parameters list *below* the standard **Pitch** parameter for

keymaps. For each oscillator, its coarse pitch parameter is named by an abbreviation of the oscillator name followed by “Pch.” For example, the coarse pitch parameter for a saw wave oscillator will be called **Saw Pch**. On the DSPCTL sub page for any oscillator **Pch**. parameter, you can adjust fine pitch by cents and Hertz, as well as KeyTrk and VelTrk settings for pitch.



*Note: Be sure to differentiate between the different pitch parameters, each used either only for keymaps or only for KVA oscillators. The Pitch parameter on the top left of the DSPCTL and DSPMOD pages always appears in VAST programs but only affects the pitch of keymaps. If a KVA oscillator is being used, this Pitch parameter will have no affect on the layer’s pitch, in which case the oscillator **Pch**. parameter described above must be used to control the pitch of the oscillator.*

Setting KVA Oscillator Type

The PC3K comes with 22 Different KVA oscillators. There are 11 high quality anti-aliased oscillators (free of digital artifacts,) and 11 oscillators that exhibit some aliasing (digital artifacts) in the higher octaves. The anti-aliased oscillators use up more DSP resources than the ones with aliasing, but the improvement in sound quality is quite noticeable. We strongly recommend using the anti-aliased oscillators for most applications.

The tables below list KVA oscillators by type and function block size. Before setting an oscillator, you must choose an algorithm which includes a block that matches the block size for the oscillator that you wish to use. See *The Algorithm (ALG) Page* on page 6-22 and *Algorithm Basics* on page 6-23 for more on selecting algorithms. Once you have picked an algorithm with the desired block size, highlight the block and use the alpha wheel to scroll through the available functions until you find the desired oscillator.

The **SYNC SQUARE** oscillator is an 8 block oscillator that requires the use of two layers (4 blocks each) and the Alt Input feature of cascade mode. See below for details on setting up the Sync Square oscillator.



Note: If you put more than one oscillator in an algorithm, you will only hear the output of the last oscillator in the algorithm, unless an algorithm is used to route the earlier oscillator around the last oscillator and into a MIX function block, or if the last oscillator processes its audio input.

Anti-Aliased Oscillators	
Size	Name/Type
1 Block	LPNOIZ (noise + low pass filter)
2 Blocks	SINE
	SINE+
	SAW
	RES NOISE (noise + low pass filter with resonance)
	SQUARE
3 Blocks	PWM (Pulse Width Modulation)
4 Blocks	SYNC SAW
	SUPER SAW
	TRIPLE SAW
8 Blocks	SYNC SQUARE (master) >>, >>SYNC SQUARE (slave) (4 blocks each)

Aliased Oscillators	
Size	Name/Type
1 Block	SINE
	SAW
	TRI
	SQUARE
	NOISE
	SINE+
	SAW+
	NOISE+
	SW+SHP (Sawtooth + Shaper)
	2 Blocks
PWM (Pulse Width Modulation)	

Setting Up The Sync Square Oscillator:

The Sync Square oscillator is actually comprised of two oscillators, a master and a slave, set up to emulate the way sync square oscillators worked on classic analog synthesizers. To create a program using Sync Square, select Default Program, #999. Select "none" on the keymap page. Select "user" on the Ampenv page for an amp envelope. On the ALG page, select Algorithm 5 at the top of the page. Use the cursor buttons to select the function block and use the alpha wheel to select the "SYNC SQUARE (master) >>" function. Next, press the << soft button to change soft button pages until you see "DupLyr". Press DupLyr to duplicate the layer, creating layer 2. In layer 2, on the ALG page, change the function block to ">> SYNC SQUARE (slave)", and set the Alt Input parameter to "Layer 1". The final step is to go to Layer 1's DSPCTL page and turn the Level parameter all the way down, to -96dB (this ensures that you will only hear the output of the slave oscillator on layer 2, which is the intended function of Sync Square.)

Now the Sync Square oscillator should be working. The "Syncoff" parameter, Sync Offset, is the main parameter for shaping the tone of this sound. Syncoff sets the sync offset between the master and slave square waves in each corresponding oscillator, which changes the shape of the waveform output by the slave oscillator. The Sync Square oscillator is most expressive when the Syncoff parameter modulated during performance. Use the DSPMOD page to assign an envelope or continuous controller like the Mod Wheel for this parameter to hear the effect (see *The DSP Modulation (DSPMOD) Page* on page 6-30, as well as *The DSP Control (DSPCTL) Page* on page 6-29 and *Common DSP Control Parameters in Algorithm Basics* on page 6-23, for details on setting up modulation and other ways to control parameters, and see *The Envelope 2 (ENV2) and Envelope 3 (ENV3) Pages* on page 6-44 for details on using envelopes as modulation sources.) See *Advanced Use Of KVA Oscillators* below for some similar examples of how to set and control modulation for oscillator specific functions and other parameters.

To add a DSP function to the Sync Square oscillator, you'll need to use cascade mode. For example, to add a filter, duplicate one of the layers to create layer 3. On layer 3, select the ALG page and choose one of the cascade mode algorithms, algorithms 101-131. For this example, let's use alg 105 with the filter "4Pole Mogue LP" selected for the function block. For the Alt Input parameter, select Layer 2. This routes a pre-Level parameter copy of Layer 2's output into Layer 3. Go to layer 2's DSPCTL page and turn its level down to -96dB (otherwise the un-filtered sound from layer 2 will be audible as well as the filtered sound in layer 3.) Now you can hear the Sync Square from layers 1 and 2 running through the filter in layer 3. See *Advanced Use Of KVA Oscillators* below for examples of how to set and control modulation of filter parameters.

Advanced Use Of KVA Oscillators

Read the KVA sections above before moving on to this section.

If you have tried the program described above in *Basic Use of KVA Oscillators*, you may have noticed that there is no variation in the notes played aside from pitch. Layers and programs created with KVA oscillators can become much more expressive by introducing variation with DSP modulation. For a KVA oscillator layer, you can use DSP modulation just as you would for keymap layers (see *Common DSP Control Parameters in Algorithm Basics* on page 6-23, *The DSP Control (DSPCTL) Page* on page 6-29, and *The DSP Modulation (DSPMOD) Page* on page 6-30.) Several KVA oscillators also have their own modulation parameters that must be accessed to control the oscillator's intended function. Aside from these methods, KVA layers can also be altered by using keymaps with natural amplitude envelopes. See below for details on each method.

Examples of Simple DSP Control and Modulation:

Select the program 1019 VA1NakedPWMPoly, and press the **Edit** button. Press the ALG soft button to view the algorithm and function blocks in use. The 3 block **PWM** oscillator that you see is generating the sound in this program. Select the empty function block to the right of the PWM block, and use the alpha wheel to scroll to the **LOPASS** function. You should immediately hear a difference in the sound of the program, because the LOPASS function is set by default to

cut some of the high frequencies from any signal that passes through it, in this case the PWM signal is passing through. With the LOPASS function still selected, press the Edit button. This brings you to the main parameter for the LOPASS object on the DSPCTL page, which is LP Frq (you can also reach this page using the DSPCTL soft button.) Here you can adjust the initial value of the function, in this case it is cut off frequency for the low pass filter. For this example, leave this initial value set to its default. With the LP Frq parameter selected, press right on the cursor button to get to this function's sub page (the right half of the display.) Select the Veltrk parameter and use the alpha wheel or alpha numeric pad to turn it all the way up to **10800ct**. Now keyboard velocities will affect the LP Frq parameter. A velocity of 127 will cause the filter's cut off frequency to move up 10800 cents from its initial value, a velocity of 0 will have no effect on the cut off frequency, and values in between will increase the cut off frequency by a scaling between 0 and 10800 cents. Overall, this will cause higher played velocities to increase the cut off frequency, making the oscillator sound brighter, and lower velocities to lower the cut off frequency, making the oscillator sound duller. This method can be used to control any DSP function that is loaded into an algorithm. See *Common DSP Control Parameters* in *Algorithm Basics* on page 6-23 for other control parameters available on the DSPCTL page.

Alternatively, you could assign cut off frequency to be controlled by any continuous controller, such as the Mod Wheel. Start again with the unedited patch **1019 VA1NakedPWMPoly**. Follow the same steps as above, but instead of changing any parameters on the DSPCTL page, press the DSPMOD soft button to reach the DSP Modulation page. On the left side of the screen, choose the parameter for LP Frq, and then press the right cursor button to reach the LP Frq sub page. On this sub page, you can assign any continuous controller to control the cut off frequency of the LOPASS function (or the main parameter for any function loaded in the current algorithm.) Select the Src1 parameter, hold the **Enter** button and move the Mod Wheel to quickly select **MWheel** (the Mod Wheel) as your control source. Next, press the cursor down button to select the Depth parameter, then use the alpha wheel or alpha numeric pad to turn it all the way up to **10800ct**. Now the Mod Wheel will affect the LP Frq parameter. Moving the Mod Wheel all the way up (a value of 127) will cause the filter's cut off frequency to move up 10800 cents from its initial value, moving the Mod Wheel all the way down (a value of 0) will have no effect on the cut off frequency, and values in between will increase the cut off frequency by a scaling between 0 and 10800 cents. Now you have the same control over cut off frequency as you did in the previous example, but now it is controlled by the Mod Wheel. Overall, moving the Mod Wheel up will increase the cut off frequency, making the oscillator sound brighter, and moving the Mod Wheel down will lower the cut off frequency, making the oscillator sound duller. This is useful to control a classic "filter sweep" sound. The above method can be used to control any DSP function that is loaded into an algorithm, and you can choose any continuous controller as a control source.



Note: When adding programs with controller assignments to a setup in Setup mode, your setup must have its controllers assigned to the same destinations that you assigned as control sources in your program. An easy way to do this is by using the Control Setup that you used when making your program as a template for your new setup (see *Control Setup* on page 6-9.) The setup **126 Internal Voices** is the default Control Setup which should be used as a template in most cases. Be careful not to save over setup ID 126.

Oscillator Specific Control And Modulation Parameters:

Several KVA oscillators also have their own modulation parameters that must be accessed to control the oscillator's intended function. Below is a list of these oscillators and their distinctive parameters, grouped by block size. Though the following parameters could be left at one setting, utilizing one of the DSPCTL or DSPMOD techniques described in the above examples will expose a wider range of expression from each oscillator.

1 Block:**LPNOIZ**

A noise generator combined with a low pass filter. Use the **Noiz Frq** parameter to control the cut off frequency of the filter.

NOISE

A simple noise generator. Use the **Noise** parameter to control the noise initial amplitude.

SW + SHP (Sawtooth + Shaper)

This oscillator is capable of basic FM Synthesis. Its distinctive parameter is **Pch Coar**. This oscillator must come after the sound source in an algorithm (either keymap or oscillator) in order to hear the effect of Pch Coar, which can radically change whatever the oscillator receives as an input. Works well placed after a Sine source.

SINE+ [Aliased (not recommended)]

Same as 2 block version, but without the **Sine+Am** parameter.

SAW+ [Aliased (not recommended)]

A saw oscillator that can add an input signal to its output.

NOISE+ [Aliased (not recommended)]

A noise oscillator that can add an input signal to its output.

2 Block:**SINE+**

A sine oscillator that can add an input signal to its output. The Sin+ Pch and Sine+ Am parameters affect the pitch and amplitude of the sine waveform without affecting the pitch of the input source.

RES NOISE

A noise generator combined with a low pass filter with resonance control. Use the **Noiz Frq** parameter to control the cut off frequency of the filter. Use the **Noiz Q** parameter to control the amplitude of the resonance (a boost or cut at the cut off frequency.) One technique for use of this function is to set a high value for Noiz Q (so that you hear a the resonance create a tone,) and then on the DSPCTL page set C4 as an initial frequency for Noiz Frq, and set Keytrk to 100ct/key on the Noiz Frq sub page. Doing this causes the noise resonance frequency to match the note of the key played.

SHAPED SAW

The Shaped Saw oscillator is a sawtooth oscillator with the ability to morph its output shape between sawtooth and sine wave (without crossfading.) This oscillator's distinctive parameter is **Shape**, which controls the morphing. With Shape set to **0**, the oscillator produces a pure sawtooth wave. With Shape set to **127**, the oscillator produces a pure sine wave. Values in between morph between the two wave shapes.

PWM (Pulse Width Modulation) [Aliased (not recommended)]

This oscillator's distinctive parameter is **PWM Wid**, which adjusts pulse width from values of **1-99**. With **PWM Wid** set to a value of **50**, **PWM** produces a square wave. The further the **PWM Wid** parameter is set from **50**, the narrower the pulse width becomes, changing the shape of the output waveform and thus altering the oscillator's tonal quality.

3 Block:

PWM (Pulse Width Modulation) [*Anti-Aliased (recommended)*]
Same as 2 Block PWM, See above.

4 Block:

SYNC SAW

Sync Saw consists of two saw waves, one that you hear (the slave) and one that controls the slave (the master.) This oscillator's distinctive parameter is **SyncOff**, which controls the offset of the slave and master waves. With SyncOff set to **0**, the master has no effect on the slave. When an offset is set, the slave restarts its wave cycle every time the master wave completes a cycle. Offsets cause the slave to restart its cycle in the middle of normal sawtooth cycles, which causes the slave's waveform shape and sound to be altered.

SUPER SAW

The Super Saw oscillator consists of two saw waves. This oscillator's distinctive parameter is **Detune**, which has settings from 0-50 cents, allowing you to detune both of the saw waves by up to 50 cents away from the root pitch of the key played. Detune affects both saw waves, one is detuned above the original root pitch, and the other is detuned below the original root pitch.

TRIPLE SAW

The Triple Saw oscillator consists of three saw waves. This oscillator's distinctive parameter is **Detune**, which has settings from 0-50 cents, allowing you to detune two of the saw waves by up to 50 cents away from the root pitch of the key played. Detune affects two of the saw waves, one is detuned above the original root pitch, and the other is detuned below the original root pitch. The third saw wave always plays the root pitch and is not affected by Detune.

8 Block:

SYNC SQUARE (master) >>, >>SYNC SQUARE (slave)
See above, Setting Up The Sync Square Oscillator: on page 6-55.

Use Of Keymaps and Natural Amplitude Envelopes With KVA Oscillators:

Keymaps are important in layers using KVA oscillators, even though their samples are not usually heard in these layers (*see the note below for exceptions.*) Keymap selection is important because the maximum amplitude set for each key in the keymap is applied to the oscillator. For most uses of KVA oscillators, users will want to use the **999 Silence** keymap because each key in the keymap is set to the same maximum amplitude, unlike many instrument keymaps. The **999 Silence** keymap ensures uniform amplitude behavior of an oscillator, and with the amplitude envelope set to **user** mode, users can easily shape all aspects of an oscillator's amplitude. The PC3K also has the ability to apply natural amplitude envelopes to oscillators. With an amplitude envelope set to **natural** mode, each oscillator note takes on the amplitude qualities of each sample in a keymap (with each note relative to sample key placement.) Each sample in a keymap has a natural envelope that was created during its original development process. Natural envelopes have much more detail than what is possible to create with the user amplitude envelope, and they are useful when trying to mimic specific instrument amplitude envelopes. When using this technique, remember that the maximum amplitude of each key is set by the current keymap. You can still control the overall parameters of a natural envelope by using the ENVCTL page. See the programs **213 Perc>Morph>Bass** & **315 ElectroPercSynth** for examples of KVA layers that use this technique. Each program uses percussion keymaps with natural envelopes to produce a fast, percussive attack. Also note that when using a KVA oscillator and a keymap other than **999 Silence**, the layer will use the name of the keymap in the info box on the main Program page, even though it is not the true sound source of the layer.



Note: *The samples from a keymap are not heard when using an oscillator, unless an algorithm is used to route the keymap signal around the oscillator and into a MIX function block, or unless it is an oscillator that processes its audio input.*

Editing KB3 Programs

You can edit a wide assortment of any KB3 program's parameters. You can also create your own KB3 programs, though you must start with an existing KB3 program to do this. A regular PC3K program cannot be turned into a KB3 program. If you're not sure whether the current program is a KB3 program, check the **KB3** button (located above the right most slider). If the blue LED is on, then the current program is a KB3 program.

Enter the KB3 program editor by pressing the **Edit** button while a KB3 program is selected in program mode. You'll quickly see that the KB3 editor differs from the standard VAST program editor.

KB3 Editor: The Tone Wheels (TONEWL) Page

KB3 Mode uses DSP-generated waveforms for the lower half of its tone wheels and samples for the upper half of its tone wheels. Using the parameters on the TONEWL page, you can specify which sample you wish to use, the number of tone wheels (which will affect how many other voices are available to you), and other related settings.

```

|=====|=====|=====|=====|=====|=====|=====|=====|=====|=====|
UPPERTonewheelKeymap: 185 Sine Wave alttun
UpperVolAdjust      : 0dB      LowerXPose : 0ST
NumToneWheels      : 79      UPPERXPose : 0ST
OrganMap           : Equal
WheelVolMap        : Junky
Globals: Off
more TONEWL DRAWBR SetDBR PITCH more
  
```

Parameter	Range of Values
Upper Tone Wheel Keymap	Sample List
Upper Volume Adjust	-96 to 96 dB
Number of Tone Wheels	24 to 91
Organ Map	Equal, Peck's, Bob's, Eric's
Wheel Volume Map	Equal, Bright, Mellow, Junky
Globals	On, Off
Lower Transposition	-120 to 127 semitones
Upper Transposition	-168 to 87 semitones

Upper Tone Wheel Keymap

Use this parameter to indicate the keymap (and thereby the samples) to use for the upper tone wheels. You can use any keymap from ROM, though you must specify a keymap that uses looped samples for KB3 Mode to work correctly. When in Program mode, the keymap assigned to the program appears in the info box.

Upper Volume Adjust

Since sample volumes can vary, while the volume of DSP-generated waveforms will remain consistent, you may find it necessary to adjust the level of the sample-based tone wheels. This parameter lets you adjust the amplitude of the upper (sample-based) tone wheels relative to amplitude of the waveform-generated tone wheels.

Number of Tone Wheels

This parameter lets you specify the number of tone wheels used by a KB3 program. The classic tone wheel organs used 91 tone wheels, though the lowest 12 were for the pedals only. Therefore, you may find 79 a good number of tone wheels to specify for realistic organ emulations. This would leave you 88 voices for other programs. You can specify up to 91 tone wheels. The number of PC3K voices used by a KB3 program is $(\text{number of tone wheels} + 1) / 2$, rounded to the next highest whole number if the result is a fraction. So, for example, with 79 tone wheels specified you would use 40 voices. Keep in mind that these voices are permanently allocated and running while the KB3 program is selected, and cannot be stolen. The additional voice used by KB3 programs is for keyclick.

Organ Map

The organ map controls the relative amplitude of each key, per drawbar. Like the wheel volume maps, these maps are based on measurements we've made on actual organs. **Equal** uses the same volume for each key and drawbar, and is not based on a real B3. **Peck's** is a good normal map, from a B3 in good condition. **Eric's** is a bit more idealized; it's smoothed out, but less realistic. **Bob's** is more uneven, based on an old B3.

Wheel Volume Map

The wheel volume map determines the volume level for each tone wheel. We've provided several tone wheel volume maps here, based on measurements we've taken on different organs. **Equal** is a map with all tone wheels at the same volume. It's not based on a real B3. **Bright** is a good normal map, based on a B3 in good condition. **Junky** is based on a B3 with an uneven, rolled-off response. **Mellow** is somewhere between **Bright** and **Junky**.

You can also apply EQ to control wheel volumes based on the frequencies of each tone wheel. See *KB3 Editor: The EQ Page* on page 6-69.

Globals

This is another toggle, which affects LFO2, ASR2, FUNs 2 and 4. When off, these three control sources are local; they affect each individual note in the layers that use them as a control source. They begin operating each time a note in that layer is triggered.

When the Globals parameter is set to **On**, these control sources become global, that is they affect every note in every layer of the current program, not just the one to which they're applied. When these control sources are global, they begin operating as soon as the program is selected. When Globals are on, LFO2, ASR2, and FUNs 2 and 4 will appear on their respective pages preceded by the letter G to indicate that they're global. You'll use global control sources when you want to affect each note in a given layer uniformly, and local control sources when you want to affect each layer's note independently.

Lower Transpose / Upper Transpose

These two parameters let you transpose the upper and/or lower tone wheels in semitone steps away from their default tunings.

KB3 Editor: The Drawbars (DRAWBR) Page

Press the **Drawbr** soft button to view the DRAWBR Page. This page lets you edit KB3's drawbars.

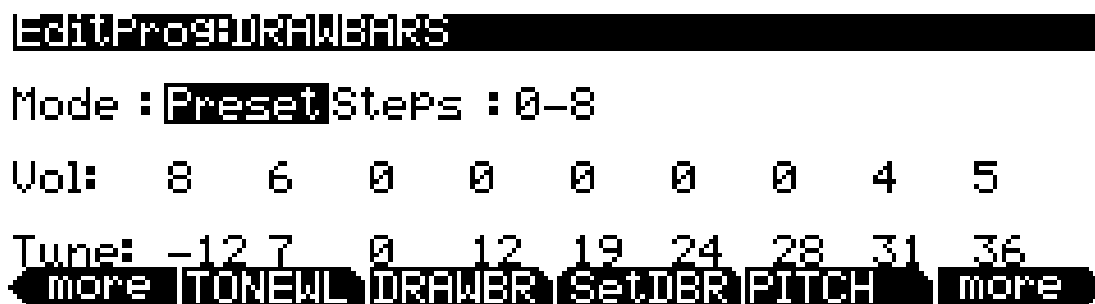

Mode

When you set Mode to **Preset**, the preset drawbar settings on this page will be installed at program selection. The drawbar values will immediately change, however, as soon as you move the corresponding drawbar. Set Mode to **Live** if you want the drawbar volume settings at program selection to be determined by the positions of the drawbar controllers (sliders). With either setting, any engagements of the drawbar controllers subsequent to program selection will affect drawbar volumes.

Steps

This parameter lets you specify the increments by which drawbar volumes will change. Choose either **0-8**, to approximate the drawbar settings on actual organs, or choose **0-127** for a finer degree of resolution.

Volume

This parameter appears only if you've set Mode (see above) to **Preset**. Use the Volume parameter to set the preset volume of each of the nine drawbars. The available values will be **0-8** or **0-127**, depending on the setting of the Steps parameter. See Table 6-3 on page 6-8 for details on the MIDI CC numbers and values that each drawbar sends and receives.

Tune

This parameter lets you tune each of the nine drawbars up or down in semitone steps. The values for the Tune parameter on the DRAWBR page shown above represent standard drawbar settings on a real B3, as shown in the table below.

Subharmonics		Fundamental	Harmonics					
16'	5 1/3'	8'	4'	2 2/3'	2'	1 3/5'	1 1/3'	1'
Slider A	Slider B	Slider C	Slider D	Slider E	Slider F	Slider G	Slider H	Slider I

Figure 6-3 Standard Drawbar Settings for the Hammond B3

KB3 Editor: The Set Drawbars (SetDBR) Soft Button

Press the **SetDBR** soft button to capture the current position of the drawbars, and use those positions as the preset drawbar positions on the DRAWBR page.

KB3 Editor: The PITCH Page

The PITCH page parameters for KB3 programs is much like the PITCH page parameters for VAST programs. The only difference is that for KB3 programs, there are no Hz, KeyTrk, or VelTrk parameters. For a full description of the PITCH-page parameters, see *Common DSP Control Parameters* on page 6-24, *The DSP Control (DSPCTL) Page* on page 6-29, and *The DSP Modulation (DSPMOD) Page* on page 6-30.

```
editProg:PITCH
Coarse:051 Src1 : OFF
Fine :0ct Depth :0ct
Src2 : OFF
DptCtl : OFF
MinDpt :0ct
MaxDpt :0ct
more TONEWL DRAWBR SetDBR PITCH more
```

KB3 Editor: The AMP Page

The AMP page parameters for KB3 programs is much like the AMP page parameters for VAST programs. The only difference is that for KB3 programs, there are no KeyTrk or VelTrk parameters. For a full description of the AMP page parameters, see *Common DSP Control Parameters* on page 6-24, *The DSP Control (DSPCTL) Page* on page 6-29, and *The DSP Modulation (DSPMOD) Page* on page 6-30.

```
editProg:AMP
Coarse:5dB Src1 : OFF
Depth :0dB Src2 : OFF
DptCtl : OFF
MinDpt :0dB
MaxDpt :0dB
more AMP PERC1 PERC2 KEYCLK more
```

KB3 Editor: The PERC1 Page

Percussion is a characteristic feature of tone wheel organs. It's especially useful while soloing, since percussion adds an extra "plink" (actually an extra tone at a defined harmonic) to the attack. You can reach the percussion parameters by pressing the **Perc1** and **Perc2** soft buttons.

```

EditProgPERC1
Percussion: On
Volume      : Soft
Decay       : Fast
Harmonic    : High
VelTrack    : 0%
LowHarm     : DrawBar4
HighHarm    : DrawBar5
StealBar    : DrawBar9
more AMP PERC1 PERC2 KEYCLK more
  
```

Parameter	Range of Values
Percussion	Off, On
Volume	Soft, Loud
Decay	Slow, Fast
Harmonic	Low, High
Velocity Tracking	0 to 100%
Low Harmonic	Drawbar 1 to 9
High Harmonic	Drawbar 1 to 9
Steal Bar	Drawbar 1 to 9

Percussion

This is where you turn the percussion effect on or off. Percussion is created by a decaying envelope applied to one of the nine drawbars. The percussion effect is "single-triggered," which means that once it's triggered, it won't trigger again until all keys (or whatever you're using to trigger notes) go up. So if no keys are down, and you play a chord, percussion gets applied to all notes in the chord (and in fact, to all notes that are triggered during the short duration of the percussion envelope). Once the envelope runs its course, any notes you play while at least one key is held down get no percussion. You can turn percussion on or off by pressing Bank button 5 (labeled **Percussion On/Off.**) Bank button 5 also sends and responds to MIDI CC 73; values 64-127 = On, values 0-63 = Off.

Volume

This parameter switches between loud and soft percussion settings. The actual amplitude is set on the PERC2 page. You can toggle between loud and soft by pressing bank Button 6 (labeled **Percussion Loud/Soft.**) Bank button 6 also sends and responds to MIDI CC 71; values 64-127 = Loud, values 0-63 = Soft.

Decay

This parameter switches between fast and slow percussion settings. The actual decay rate is set on the PERC2 page. You can toggle between slow and fast decay by pressing Bank button 7 (labeled **Percussion Decay F/S.**) Bank button 7 also sends and responds to MIDI CC 70; values 64-127 = Fast, values 0-63 = Slow.

Harmonic

This parameter switches between high and low harmonic percussion settings. The actual pitch is controlled by the LowHarm and HighHarm parameters. You can toggle between low and high harmonics by pressing Bank Button 8 (labeled **Percussion Pitch H/L.**) Bank button 8 also sends and responds to MIDI CC 72; values 64-127 = High, values 0-63 = Low.

VelTrack

Here is where you specify the degree to which key velocity controls percussion volume. A value of zero corresponds to no velocity tracking, which is like a real tone wheel organ. Other values add velocity tracking, so that increased velocity results in louder percussion.

LowHarm

Controls which drawbar is used as the basis for the percussion when Harmonic is set to **Low**. On an actual tone wheel organ, this is Drawbar 4 (2nd harmonic). The actual pitch obtained depends on the drawbar tuning.

HighHarm

Controls which drawbar is used as the basis for the percussion when Harmonic is set to **High**. On an actual tone wheel organ, this is Drawbar 5 (3rd harmonic). The actual pitch obtained depends on the drawbar tuning.

StealBar

Controls which drawbar is disabled when the percussion effect is turned on. On an unmodified tone wheel organ, the ninth drawbar is the one disabled. Any drawbar can be selected.

KB3 Editor: The PERC2 Page

```

EditProgramPERC2
PercLevel  DecayTime  OrgLevel
Loud+Fast  4.0dB  0.44s  -2.0dB
Loud+Slow  4.0dB  0.60s  -2.0dB
Soft+Fast  0.0dB  0.24s  0.0dB
Soft+Slow  0.0dB  0.60s  0.0dB
more AMP PERC1 PERC2 KEYCLK more
    
```

Parameter Group (Available for each combination of the Volume and Decay parameters on the PERC1 page)	Range of Values
Percussion Level	0 to 24.0 dB
Decay Time	0.01 to 5.10 seconds, in 0.02-second increments
Organ Volume Level	-12.0 to 12.0 dB

PercLevel, DecayTime, OrgLevel

With these parameters you can control the amplitude and decay time of the percussion effect for all combinations of the Volume and Decay parameters (on the PERC1 page). You can also adjust the level of the organ relative to the percussion, for accurate emulation of classic organs.

KB3 Editor: The KEYCLK Page

The Key Click feature adds a decaying burst of pitched noise to the attack of notes. Unlike the percussion, the key click is “multi-triggered,” which means that every new note will trigger it. The parameters on this page primarily control the decay, volume, and pitch of the key click.

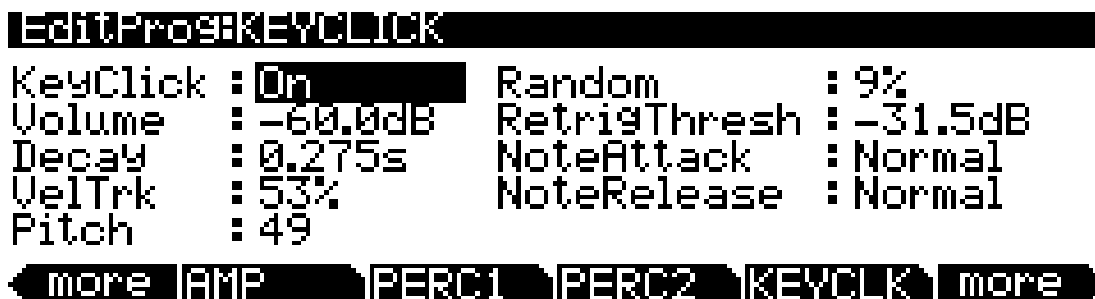

Parameter	Range of Values
Key Click	Off, On
Volume	-96.0 to 0.0 dB, in 0.5-dB increments
Decay	0.005 to 1.280 seconds, in 0.005-second increments
VelTrk	0 to 100%
Pitch	1 to 120
Random	0 to 100%
Retrig Thresh	-96.0 to 0.0 dB, in 0.5-dB increments
Note Attack	Normal, Hard, PercHard
Note Release	Normal, Hard

KeyClick

This is where you turn Key Click on or off. With **KeyClick** set to **Off**, you may still hear a click depending on your **Note Attack** and **Note Release** settings (see below.)

Volume

This parameter sets the level of the keyclick; the noise decays from the level you set here. This level is scaled by the drawbar levels, as well as the expression pedal level. Keyclick volume can also be scaled by MIDI CC 89; value 0 = -96 dB, value 127 = the level set for the **Volume** parameter. Values between 0 and 127 scale between -96 dB and the level set for the **Volume** parameter. When using CC 89, the value displayed for the **Volume** parameter will not change.

Decay

Sets the basic decay time of the noise envelope. Smaller values produce a shorter burst.

VelTrk

Controls the degree to which key velocity affects the key click volume. A value of zero means that the key velocity has no effect on the key click volume (which is like a real tone wheel organ). Other values add volume as the velocity increases.

Pitch

Sets the basic pitch of the key click noise, relative to the highest tonewheel's pitch. The pitch is controlled by a steep lowpass filter applied to white noise. The filter's cut off frequency is controlled relative to key number, higher keys move the cutoff frequency up, lower keys move the cutoff frequency down.

Random

Controls the degree to which a random amount of amplitude variation is added to the key click.

ReTrigThresh

This parameter lets you set the volume level below which key click must decay before it will be retriggered.

Note Attack

Controls the attack characteristic of notes. **Normal** provides a smoothed attack, while a setting of **Hard** has an instant attack and will produce an audible click, in addition to any amount of key click specified with the other parameters on this page (you might prefer not to specify any additional key click when you use this setting). **PercHard** sets a hard attack level for percussion only; notes without percussion use a normal attack.

Note Release

Controls the release characteristic of notes. A setting of **Normal** has a smoothed release, while a setting of **Hard** has an instant release. **Hard** will produce an audible click.

KB3 Editor: The MISC Page

The MISC page contains an assortment of control parameters, including Leslie speed control and vibrato/chorus selection.

```

EditProgMISC
PreampResp : On          VolAdjust    : -9dB
Leakage     : -62.5dB   BendRngUP   : 0ct
LeakMode    : TypeA     BendRngDn   : 0ct
SpeedCtl    : Slow      Sustain      : On
VibChorCtl  : On        Sostenuto    : On
VibChorSel  : Chr3      LesliePedal  : Sost
more MISC   EQ         OUTPUT PROGFX more
  
```

Parameter	Range of Values
Preamp/Expression Response	Off, On
Leakage	-96.0 to 0.0 dB, in 0.5-dB increments
Leak Mode	None, Type A, Type X, Type Y, Type Z, Type R
Speed Control	Slow, Fast
Vibrato/Chorus Control	Off, On
Vibrato/Chorus Type Selection	Vib1, Vib2, Vib3, Chor1, Chor2, Chor3
Volume Adjust	-96 to 96 dB
Bend Range Up	± 7200 cents
Bend Range Down	± 7200 cents
Sustain	Off, On
Sostenuto	Off, On
Leslie Pedal	None, Sustain, Sost, Soft

PreampResp

Set this parameter **On** or **Off** to enable or disable the preamp+expression pedal part of the KB3 model. Turning this **On** (the default) makes KB3 programs function like stock organs. The expression pedal in this case is more than a volume pedal; it actually functions like a “loudness control,” varying the frequency response to compensate for the ear’s sensitivity at different volumes. In addition, the preamp provides a de-emphasis curve to compensate for the built-in tone wheel volume pre-emphasis. Turning preamp response **Off** emulates organs that have been modified to have a direct out (before the preamp and expression pedal).

Leakage

Controls the level of the simulated crosstalk and signal “bleed” of adjacent tone wheels in the model. This is provided to help “dirty up” the sound to make it a bit more realistic. A setting of -96 dB gives the purest tones; other values add more simulated leakage. This level is scaled by the drawbar levels, as well as the expression pedal level. The leakage level can also be controlled by MIDI CC 90; value 0 = -96 dB, value 127 = 0 dB, values between 0 and 127 scale between -96 dB and 0 dB. When using CC 90, the value displayed for the **Leakage** parameter will not change.

LeakMode

Selects between different leakage models, determining which leakage harmonics are emphasized. **TypeA** provides an overall tone wheel leakage, with all tone wheels leaking a small amount. **TypeX**, **TypeY**, **TypeZ**, and **TypeR** emulate different degrees of drawbar leakage, where the leakage components correspond to the nine drawbars, instead of all the tone wheels.

SpeedCtl

Select either **Fast** or **Slow** to choose the speed of the rotary speaker emulation. You can toggle between fast and slow speed using Bank button 1 (labeled **Rotary Fast/Slow**.) Bank button 1 also sends and responds to MIDI CC 68; a value of 64-127 = Fast, and 0-63 = Slow.

VibChorCtl

Choose **On** or **Off** to turn on or off either vibrato or chorus (as selected with the VibChorSel parameter). You can toggle between on and off using Bank button 2 (labeled **Vibrato On/Off**.) Bank button 2 also sends and responds to MIDI CC 95; a value of 64-127 = On, and 0-63 = Off.

VibChorSel

Choose the vibrato or chorus program (there are three of each) you wish to use with this KB3 program. Note that you must set VibChorCtl (also on the MISC page) to **On** to hear the effect. You can select the vibrato or chorus you want using Bank buttons 3 and 4 (labeled **Vibrato Chor/Vib** and **Vibrato Depth**.)

Bank buttons 3 and 4 also send and respond to MIDI CC 93; values 54-71 = chorus with depth 1, values 72-89 = chorus with depth 2, values 90-127 = chorus with depth 3, values 0-17 = vibrato with depth 1, values 18-35 = vibrato with depth 2, values 36-53 = vibrato with depth 3.

VolAdjust

Provides an overall volume adjust for the KB3 model. Use this parameter to “normalize” KB3 programs with other programs.

BendRngUp, BendRngDn

Respectively control the upward and downward pitch bend ranges of the KB3 program.

Sustain

Set **On** or **Off** to enable or disable response to MIDI sustain (MIDI 64). By default MIDI sustain (MIDI 64) is sent by Switch Pedal 1.

Sostenuto

Set **On** or **Off** to enable or disable response to MIDI sostenuto (MIDI 66). By default MIDI sostenuto (MIDI 66) is sent by Switch Pedal 2.

LesliePedal

Set the pedal source (**Sustain**=Switch Pedal 1, CC 64 by default, **Sost**=Switch Pedal 1, CC 66 by default, **Soft**=Switch Pedal 3, CC 67 by default) to toggle between **Fast** and **Slow** for the Leslie™ speaker rotation speed.

KB3 Editor: The EQ Page

The four column headers on this page represent two shelving bands of equalization and two parametric bands. The KB3 EQ offered here, though, is not implemented as a true EQ section; instead, it adjusts the volume of the tone wheels based on frequency. If the tone wheels are based on sine waves, then this acts similarly to a real EQ.

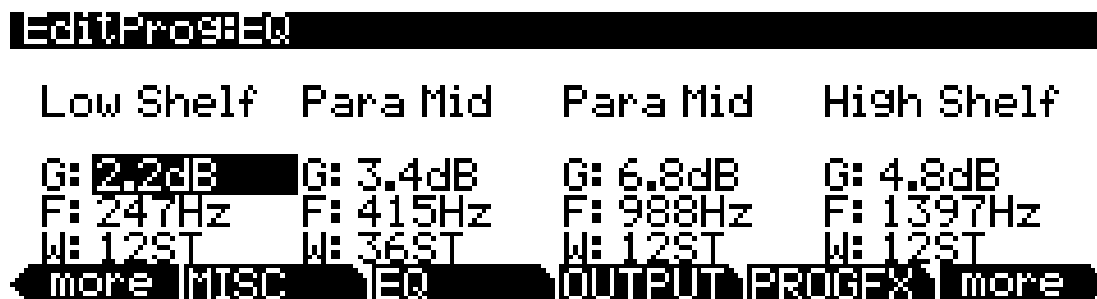

Parameter Group (Available for each EQ band)	Range of Values
Gain	-24.0 to 24.0 dB, in 0.2-dB increments
Frequency	16 to 25088 Hz, in varying increments
Width	-128 to 128 Semitones, in 2-semitone increments

Each EQ section has Gain (G), Frequency (F), and Width (W) controls. Frequency controls the center frequency of the band. Width controls the bandwidth. Gain controls the amount of boost or cut.

KB3 Editor: The OUTPUT Page

Use this page to route the current program’s post-FX signals. The two Pan parameters correspond to those of the VAST Program editor OUTPUT page (See page 6-31). The Out Gain and Demo Song parameters correspond to those of the VAST Program Editor COMMON page (See page 6-35).

```

EditProgOutputPU Prog 49
Pan : 0
Pan Mode : +MIDI
Out Gain : -5dB
Demo Song: 910 Classic Traffic
Exp Pedal: Expression/Foot

more MISC EQ OUTPUT PROGFX more

```

Exp Pedal

Use this parameter to set which rear panel CC Pedal input will control volume for the current KB3 program. With a setting of **Expression/Foot**, volume can be controlled by a CC pedal plugged into either the rear panel input labeled *CC Pedal 1 (volume)*, or the rear panel input labeled *CC Pedal 2 (wah)*. With a setting of **Expression**, volume can be controlled by a CC pedal plugged into the rear panel input labeled *CC Pedal 1 (volume)*. With a setting of **Foot**, volume can be controlled by a CC pedal plugged into the rear panel input labeled *CC Pedal 2 (wah)*. With a setting of **None**, volume control from both CC pedal inputs is disabled.

KB3 Editor: The Program FX (PROGFX) Page

This page is the same as the VAST Program editor PROGFX page (see page 6-47) except for one important difference: there is no Pre/Post insert parameter for the auxiliary sends.

```

EditProgProgFX All Layers
Insert: 754 Good Leslie4 Output: Main
Aux 1: 904 Sax Chamber2 Output: Main
Aux 2: 0 None Output: Main
Aux 1 Send Level: -17dB Type: dB
Aux 2 Send Level: off Type: dB
Aux1 Mod : ON Aux2 Mod : ON

more MISC EQ OUTPUT PROGFX more

```

KB3 Editor: The LFO, ASR, and FUN Pages

The rest of the pages—LFO, ASR, and FUN— are the same for KB3 programs as they are for VAST programs, so we won’t describe them again here. Begin on page 6-38 to find descriptions of these pages.

KB3 Programming Tips

This section provides some starting points for creating your own KB3 programs. Remember that you'll have to start with one of the existing KB3 programs.

As described below, the most prominent difference between organ vintages is the number of tone wheels used. Keep in mind, however, that the sound of an actual tone wheel organ will depend not only on its age, but also on how well it has been maintained.

Octave folding, where an octave (or part of an octave) is repeated at the top or bottom of the keyboard, is handled automatically by KB3 Mode, emulating the folding done on actual tone wheel organs.

Early Tone Wheel Organs. Instruments of this period had 91 tone wheels. To get this sound, go to the TONEWL page, select 91 tone wheels, and set lowest pitch to C 1. Start with the **Junky** Wheel Volume Map and **Bob's** Organ Map. You may also want to increase the Key Click level, since this tends to become louder on older organs.

Middle Period Organs. To model one of these instruments, set 82 tone wheels and a low note of A 1. Use the **Mellow** Wheel Volume Map and **Eric's** Organ Map. Set Key Click to a moderate level.

The Classic B-3. For this sound, choose 79 tone wheels and set the low note to be C 2. The best settings here are the **Bright** Wheel Volume Map and **Peck's** Organ Map. You may also want to reduce the Key Click level.

Program Mode

KB3 Programming Tips

Chapter 7

Setup Mode

In Setup mode, the PC3K can take on the identity of 16 distinct instruments and 16 distinct MIDI transmitters, each of which can use the setup's physical controller assignments (or any subset of those controller assignments). For example, you can create a setup that is split into 16 different keyboard regions (called zones). Each zone can play its own program, while also transmitting on its own MIDI channel. Each zone can also have an independent arpeggiator and one riff. You can also record the output of a setup to Song mode.

Selecting setups in Setup mode is much like selecting programs in Program mode—just use one of the normal data entry methods to scroll through the list of setups. There are, however, some important differences between a program and a setup. A program plays on a single keyboard zone and on a single MIDI channel. A setup enables you to use up to 16 keyboard (or MIDI controller) zones, each of which can have its own program, MIDI channel, and control assignments. The parameters you define for each setup affect programs *only while you are in Setup mode*. An exception to this is the control setup, which we discuss on page 6-9.

Press the Setup mode button to enter Setup mode. You'll see a list of setups, which you can select with any data entry method.



The info box on the left-hand side of the main Setup mode page displays the zones and corresponding programs used in the current setup. Below the program name for each zone is a line representing the zone's key range. For example, in the setup above, "Acoustic Split," the zone for the program "NYC Kits" has a key range that covers the entire keyboard, from approximately C-1 to G9. The zones for the programs "Studio C Strings" and "NYC Jazz Grand" have key ranges that approximately cover the upper two-thirds of the keyboard, and "Upright Growler" covers part of the lower keyboard. You can also see which zones have a riff, indicated by "riFF" to the right of the program name. For example, in the setup above, the zone for the program "NYC Kits" has a riff. If there are more than four zones in the current setup, you can view the other zones by holding down the **Enter** button and using the **Chan/Layer** buttons to scroll through the current setup's zones.

You can transpose the entire setup up or down by octaves with the two **Octav** soft buttons. Use the two **Xpose** soft buttons to transpose the setup up or down by half steps. When you transpose a setup, the split points between zones remain in place; each program is transposed within its respective zone.

The **Panic** soft button sends All Notes Off and Reset All Controllers messages to all zones, and stops all arpeggiators and riffs.

Press the **Info** soft button to see a list of all of the controller assignments for all zones of the current setup. On the Info page, use the Alpha Wheel, cursor buttons, or - / + buttons to scroll through the list.

When you select a setup in Setup mode, the PC3K sends a number of MIDI messages, on each of the MIDI channels used by the setup. Some of these include: Program Change commands, MIDI Bank Select messages, Pan and Volume messages, and entry values for physical controllers (entry values are the values that take effect as soon as you select the setup; there are also controller *exit* values, which are the values of the controllers when you leave the setup—either by selecting another setup or by exiting Setup mode). The values of all these messages depend on the parameters you define in the Setup Editor.

Zone-status LEDs in Setup Mode

Take a minute to scroll through some of the factory setups. As you change setups, you'll notice that the LEDs in the eight Bank buttons above the programmable sliders go on and off and change color. These LEDs indicate the status of zones 1-8 in the setup.

While you're in Setup mode, each of the eight zone-status LEDs will always be in one of four states:

- Off Empty zone—that is, a zone that has no program or MIDI channel associated with it. For example, if you select a setup and only four status LEDs light up (regardless of their color), the setup contains just four zones. Whenever you're in Setup mode, the number of lines in the info box matches the number of zone-status LEDs that are lit.
- Green Active zone. As long as no other zone is soloed, an active zone plays notes— and generates controller information, program changes, and entry/exit controller values. If another zone is soloed, an active zone is “backgrounded”—it's status LED remains green, but it doesn't play notes or generate controller information.
- Orange Muted zone. Muted zones don't play notes or generate controller information, but they do generate program changes and entry/exit controller values.
- Red Solo zone. As you might have guessed, only one zone can be soloed at a time. When a zone is soloed, *only* that zone plays notes and generates controller information. Other zones, if they're not turned off, still generate program changes and entry/exit controller values. If a zone is muted and then subsequently soloed, all other zones are “backgrounded” but the soloed zone remains muted.

In performance situations, the Bank buttons provide a convenient way to temporarily change the status of one or more zones. This can be very effective for bringing voices and/or controller configurations into and out of your performance. The best way to get familiar with this technique is to play with the buttons, as the next few paragraphs describe.

Select a setup (look for one with lots of active zones that cover the whole keyboard), and play a few bars. You'll hear sounds corresponding to each of the active zones (green LEDs). If you see any muted zones (orange LEDs), press their corresponding Bank buttons, and they'll become active; conversely, if you press the Bank button of an active zone, it will become muted. Play around a bit. Try muting all the zones, then bringing them back one by one until all the zones in the setup are active.

Table 7-1 gives you a quick visual reminder of how zones behave depending on their status.

LED Color	Zone Status	Data Generated by Zone			
		Notes	Controllers	Program Number	Entry and Exit Values
Red	Solo, Solo+Muted	Yes	Yes	Yes	Yes
Green (no others are red)	Active	Yes	Yes	Yes	Yes
Green (another is red)	Backgrounded	No	No	Yes	Yes
Orange	Muted	No	No	Yes	Yes
(Off)	Empty	No	No	No	No

Table 7-1 Zone Status in Setup Mode

Remember that any changes you make to zone status in Setup mode are temporary; as soon as you select another setup, that setup's programmed zone status takes over. To change a setup's zone status permanently, use the Setup Editor (see *Status* on page 7-6).

Soloing a Zone

To solo a zone, set the Status parameter on the Setup Editor CH/PROG page (see *The Setup Editor* and *The Channel/Program (CH/PROG) Page* below) to **Solo**. The **Chan/Layer** buttons—in addition to scrolling through the zones of the current setup—now select the soloed zone. If you scroll through zones 1-8, you will see the red solo LED moving across the bank buttons above the sliders. After one zone is soloed, you can solo zones 1-8 by pressing on the corresponding Bank button above the sliders; this action unsolos the previously soloed zone.

Additionally, you can configure a setup such that you can solo zones in real time (from outside of the editor) by assigning a controller on the desired zone to destination **162 SoloZn**. See *Controllers* on page 7-19 for more information on controller destination assignments in Setup mode.

The Setup Editor

From Setup mode, press the **Edit** button to enter the Setup Editor, where you can make changes to the currently selected setup. Use the soft buttons to select the various Setup Editor pages. The upper line of each page displays the usual mode reminder, as well as the current Setup Editor page, and the current zone. Use the **Chan/Layer** buttons to select one of up to sixteen different zones, each having its own set of Setup Editor pages.

The parameters on the Setup Editor pages define what each of a setup's zones sends—both to internal programs and to the MIDI Out port. They also determine how the PC3K responds to MIDI signals received from a MIDI controller connected to the PC3K's MIDI In port (when the Local Keyboard Channel matches the transmit channel of your MIDI controller).

Compare

Pressing the **Storage** button calls up the Compare Editor, which recalls the setup pre-edit settings, allowing you to compare your edited setup with the original setup. Pressing the **Storage** button again returns you to the Setup editor. Using the Compare Editor makes no changes to the current setup.

The Channel/Program (CH/PROG) Page

This is the first page you see when you enter the Setup Editor. Here, you can select programs, MIDI channels, and MIDI Bank numbers for each of the setup's 16 zones. You can also solo or mute each zone.

```

SetupMode:CH/PROG #Zone:1/10
Program      : 129 Piano Stack
Destination: USBMIDI+MIDI+LOCAL Out: Auto
Channel      : 1          InputChannel: None
MidiBank     : 1          BankMode   : Ctl 0/32
MidiProg     : 1          EntryProgChg : On
Status       : Active     Arpeggiator : On
more CH/PRG KEYVEL PANVOL BEND more
  
```

Parameter	Range of Values	Default
Program	Program List	1 Standard Grand
Destination	Destination List	USB_MIDI+MIDI+Local
Channel	1 to 16	1
MIDI Bank	0 to 127	0
MIDI Program (MidiProg)	<i>(Depends on MIDI Bank Mode)</i>	1
Status	Muted, Active, Solo, Solo+Muted	Active
Out	Auto, Pri., Sec.	Auto
InputChannel	None, 1-16	None
MIDI Bank Mode (BankMode)	MIDI Bank Mode List	Ctl 0/32
Entry Program Change (EntryProgChg)	On, Off	On
Arpeggiator	On, Off	On

Program

This selects an internal program to play on each zone. As you change the value of Program, notice that MIDI Program and MIDI Bank match the local program and bank numbers (programs 1–127 fall into MIDI Bank 0, 128–255 fall into MIDI Bank 1, and so on—both MIDI Banks and PC3K banks can hold 128 programs). If you want to transmit different program and bank numbers over MIDI, highlight either MIDI Program or MIDI Bank and select a new value. Note that changing the Program parameter again will reset both the MIDI Program and MIDI Bank parameters to match the local program and bank numbers.

NOTE: MIDI Banks and PC3K banks are not the same, nor is there a direct one-to-one correspondence between the two. As mentioned previously, programs 1–127 fall into MIDI Bank 0, programs 128–255 fall into MIDI Bank 1, and so on; program IDs 1–128 fall into PC3K bank **Base 1**, programs 128–255 fall into **Base 2**, and so on (recall that the PC3K bank names are displayed in left-to-right order above their corresponding Bank buttons above the sliders.) For example, program **127 Magic Celeste** is in PC3K bank **Base 1** and it is Program **127** in MIDI Bank **0**; and program **128 Drums 'n Bells** is in PC3K bank **Base 1**, and it is Program **0** in MIDI Bank **1**.

Destination

This parameter determines whether the currently selected zone transmits only to the PC3K (**Local**), transmits only to the MIDI port (**MIDI**), transmits only to the USB port (**USB_MIDI**), transmits to a pair of destinations (**MIDI+Local**, **USB_MIDI+Local**, or **USB_MIDI+MIDI**), or transmits to all destinations (**USB_MIDI+MIDI+Local**).

Channel

The Channel parameter defines the MIDI transmit channel for the currently selected zone. You can set it to any of the 16 MIDI channels. Normally, you will want each zone on a separate MIDI channel. This is necessary if you want to combine different programs in the setup.

If two zones have the same MIDI channel (and destination), but they have different program settings, there will be conflicts: no MIDI device, including the PC3K, can respond correctly to two different simultaneous Program Change commands on one channel. The result will be that only one Program Change will be recognized, and every note played will sound double (if Note Maps are on). This can create odd and unpredictable timing effects, and will reduce your polyphony by 50%.

Nevertheless, there will be occasions when “stacking” zones on the same MIDI channel might come in handy. Suppose you want a physical controller on the PC3K to send data for two *different* numbered MIDI Controllers on the *same channel*. In this case, you must create two zones assigned to the same channel, but with different controller assignments.

Here’s one example: if a receiving synth is using Controller 1 for modulation depth and Controller #13 for modulation speed, you can increase both the depth and the speed with Slider A. Start by assigning Slider A in Zone 1 to **MWheel** and in Zone 2 to **MIDI 13**; then assign both zones to the same MIDI channel. (You may want to make sure you aren’t sending doubled notes. Use the Note Map parameter on the KEY/VEL page to set one zone’s Note Map to **Linear** and the other zone’s Note Map to **Off**.)

Another example: create two or more zones that are identical except for their transposition settings. Now you can play parallel intervals (or chords) with single keystrokes.

MidiBank

Before reading this section on MIDI Banks, be sure to read the note in the section *Program* on page 7-4.

The PC3K’s programs are divided into 17 MIDI Banks, numbered 0–16. Program 46 in MIDI Bank 3, (which is PC3K bank **Orchestra**), for example, is **430 Lead Oboe**. The MIDI Bank parameter displays which bank the current program is assigned to, and automatically changes to match the Program value you set.

You can send Bank Select messages to external MIDI devices as well, by setting the Destination parameter to a destination including **MIDI** or **USB_MIDI**, then changing MidiBank. Some instruments may have more banks than the PC3K. Bank switching via MIDI makes it easy for the PC3K user to select sounds on external instruments, no matter how many banks they might have.

When you change the value of the Program parameter, the value of MidiBank automatically changes correspondingly. If you want to transmit a MIDI Bank number different from the one corresponding to the local program, select the local program first, then change the MIDI bank.

If you select an empty bank (like Bank 53), the zone will still produce sound on the PC3K, provided that Destination is set to a destination including **Local**. The Program parameter will display whatever internal program you set, but the bank number transmitted over the MIDI Out port will be different from the internal program’s bank number.

MIDI Program (MidiProg)

MidiProg defines which program number is transmitted out the MIDI Out port on the current zone's MIDI channel.

When you change the value of the Program parameter, the value of MIDIProg automatically changes correspondingly. If you want to transmit a MIDI program change number different from the one corresponding to the local program, select the local program first, then change the MIDI program.

Different programs are accessible depending on the value of the BankMode parameter:

Value of BankMode	Available Programs
Ctl 0 or Ctl 32	0 to 127
Ctl 0/32	0 to 127
K2600	0 to 99
None	None

Status

This parameter determines what the current zone does when you select the setup in Setup mode. **Muted** means that the zone sends and receives program changes and entry/exit controller values, but doesn't play notes. If the value is **Active**, the zone sends and receives normally via MIDI. **Solo** causes only the current zone to play, "backgrounding" all other zones (backgrounded zones send and receive program changes and entry/exit controller values, but don't play notes). With a value of **Solo+Muted**, the current zone is both soloed and muted; when the zone isn't soloed, it won't produce sound).

See the section about zone-status LEDs (page 7-2) for more information about muting and soloing zones.

Out

Use the **Out** parameter to set the rear panel audio outputs used for each zone of the current Setup. This parameter determines the output settings for the main program signal and insert effects of each zone (for Aux effects output settings, use the Output parameter on the Setup Mode AUX1 or AUX2 pages.)

A setting of **Auto** will make that zone output audio based on the settings for the program used by that zone. Program output settings are set in the Program Editor using the **Output** parameter on the top line of PROG FX page (see *Output* on page 6-48 for details) or the **Output** parameter on the LAYER FX page (see page 6-49 for details.) A setting of **Pri.** (primary) will output track audio to the **MAIN** Balanced Analog Outputs. A setting of **Sec.** (secondary) will output track audio to the **AUX** Balanced Analog Outputs.

Input Channel

In Setup mode, an external MIDI device (such as a keyboard or sequencer) will play notes of a single program by default (if the Local Keyboard Channel parameter is set to off, see page 10-10 for details.) The played program will be on a Zone that has a **Channel** parameter (on the CH/PROG page) which matches the channel on which the external MIDI device is transmitting. (If no Zone's Channel parameter matches, the external device will play notes of the last program that was using that channel in Program Mode or from a previously loaded Song or Setup.)

When the Program of a Setup Zone is played from an external MIDI device, Setup MIDI parameters (most noticeably key range and transposition) will not be applied. If you want these parameters applied, set the **Input Channel** parameter to match the channel on which the external MIDI device is transmitting. See the *Input Channel Settings* section below for details on setting an Input Channel. (To play the entire Setup from an external MIDI device, see *Local Keyboard Channel (LocalKbdCh)* on page 10-10.) When Local Keyboard Channel is set to something other than **Off**, the **Input Channel** parameter has no effect and will appear in parentheses.

Input Channel basically has the same effect as Local Keyboard Channel, except you can choose to play only one or some Setup Zones from an external device, instead of all Zones. To play more than one Zone from an external device, set each desired Zone's **Input Channel** parameter to match the channel on which the external MIDI device is transmitting. It is also possible to use the **Input Channel** parameter to use multiple external devices which each play a specific Zone or Zones. For details on controlling assignments made to the PC3K's physical controllers (sliders, switches, mod wheel, etc.) from an external MIDI device when using an Input Channel, see *Continuous Controller Messages From External MIDI Devices* on page 10-11.

Input Channel Settings

When setting a MIDI channel number for the Input Channel parameter, channel 1 for example, you can choose **1 L+M** or **1 M** (scroll past 16 L+M to see all the choices.) A channel number with a setting of **L+M** indicates that the zone will be playable from the PC3K keyboard (L for Local) and from the external MIDI controller (M for MIDI.) A channel number with a setting of **M** indicates that the zone will be playable only from the external MIDI controller, and not from the PC3K keyboard. You can also choose **Any L+M** or **Any M** for the Input Channel setting. **Any L+M** and **Any M** will make the zone receive MIDI on any channel that an external device is transmitting. This is useful if you are using a single external MIDI controller and are not sure which channel it is transmitting on.

MIDI Bank Mode (BankMode)

The BankMode you choose determines how bank numbers will be sent over MIDI when the setup is selected, and in what format. It also affects how many MIDI banks and programs you can choose.

None means no bank number is sent, just the program number. **Ctl 0** means that the bank number is sent as a MIDI Controller #0 message. **Ctl 32** means it is sent as MIDI Controller #32. **Ctl 0/32** means it is sent as a dual-controller (two-byte) message, with the most-significant byte (MSB) of the bank number sent as Controller 0 and the least-significant byte (LSB) as Controller 32. Bank Select messages allow you to specify banks numbered 0-127.

The MIDI Specification is a little ambiguous when it comes to Bank Select messages, as to whether they should be only Controller 0, only Controller 32, or both Controllers sent as a pair. Different manufacturers design their instruments to respond to different schemes, and if you send Bank Select in a form an instrument doesn't like, it may ignore it or interpret it incorrectly. The BankMode parameter is designed to allow the greatest flexibility in addressing other MIDI instruments. Usually you can look on the MIDI Implementation chart in the user's manual of an instrument to determine how it's designed to receive Bank Select messages, and then set BankMode for each zone to suit the instrument that is receiving data from it. The default setting, which works with the largest number of other instruments, is **Ctl 0/32**.

A BankMode value of **K2600** is intended for use with the K2000, K2500, or K2600. The Bank Select message is sent as Controller 32, with a value between 0 and 127. The K2000, K2500, and K2600 support only 10 banks, with 99 programs per bank, so Program Changes 100 or higher are sent as Bank Select 1, followed by the last two digits as a Program Change. For example, if Program 124 is assigned to the zone, this will be sent out the MIDI Out port as Bank Select (Controller 32) 1, and then Program Change 24.

Entry Program Change (EntryProgChg)

This parameter enables or disables bank and program change commands sent to internal programs or to the MIDI Out jack when you select setups. If it's set to **On**, the program numbers for the programs in the 16 zones will be sent via MIDI when a setup is selected. By setting this parameter to **Off**, you can select a setup on the PC3K without changing the internal programs or those on MIDI devices receiving from the PC3K. This is useful if you want to send only controller data to the PC3K or to MIDI devices, without changing program assignments.

Arpeggiator

The **Arpeggiator** parameter determines if the current Zone can be played by an arpeggiator. Normally, the **Arpeggiator** parameter should be set to **On**, and the arpeggiator for each Zone should be turned on or off with the *Active* parameter on the ARPEGGIATOR page for each Zone (see *The ARPEGGIATOR Page* on page 7-42 for details.) If the **Arpeggiator** parameter is set to **Off**, the zone will not be arpeggiated even if the *Active* parameter on the ARPEGGIATOR page is set to *On*.

When a global arpeggiator is being used, the **Arpeggiator** parameter can be set to **Off** to exclude a Zone from being played by the global arpeggiator. See *Arpeggiator Global (ArpGlobal)* on page 7-66 for details on setting a global arpeggiator.

The Key/Velocity (KEY-VEL) Page

The Key/Velocity page allows you to set key range, velocity range, transposition, and Note Maps for each zone.



Note: MIDI velocity of notes played on the PC3K keyboard are first affected by any Velocity Scale, Offset, and Curve settings made on each zone's KEY-VEL page. The resulting velocity is then affected by any Vel Map settings made on the Master Mode MAPS page (see page 11-5.) Also, MIDI velocities sent to the USB or MIDI out port are first affected as explained above, and then affected by settings on the MIDI mode Transmit page (see page 10-1.) On each of the pages mentioned above, look at the MIDI signal flow chart to see which velocity maps can affect your velocities depending on which MIDI Sources, MIDI Destinations and operating mode that you are using.

```

SetupMode:KEY-VEL                               #Zone:1/1
LoKey      : C -1                               Transpose: 0ST
HiKey      : G 9                               NoteMap   : Linear
                                                VelScale  : 100%
LoVel      : 1                                 VelOffset : 0
HiVel      : 127                              VelCurve  : Linear
more CH/PRG KEYVEL PANVOL BEND more
  
```

Parameter	Range of Values	Default
Low Key	C -1 to G9	C -1
High Key	C -1 to G9	G9
Transpose	-128 to +127 Semitones	0-
Note Map	Note Map List	Linear
Low Velocity	1 to 127	1
High Velocity	1 to 127	127
Velocity Scale	± 300%	100%
Velocity Offset	-128 to +127	0
Velocity Curve	Velocity Curve List (see <i>Velocity Curve (VelCurve)</i> on page 7-14)	Linear

Low Key (LoKey), High Key (HiKey)

The LoKey and HiKey parameters define the note range of the currently selected zone. The easiest way to change these values is to press and hold the **Enter** button and press the key of the note you wish to enter. You can set these values with normal data entry methods as well.

You can create “negative” ranges as well. To do this, select the HiKey parameter and set its limit *lower* than the LoKey limit. This results in the zone being active at the top and bottom of the keyboard, but being silent in the range between the two limits. This lets you create a layer with a “hole” in the middle, which you can then fill with a different sound on another zone.

The limits of MIDI are C-1 to G9. The untransposed 88-key range is A0 to C8. The untransposed 76-key range is E1 to G7.

Transpose

This changes the pitch of the zone, without changing its position on the keyboard. It changes the MIDI note numbers generated by the keys in the zone, without physically shifting the zone. The range is -128 to 127 semitones. Since there are 12 semitones (or half steps) to an octave, you can transpose up or down over ten octaves. If you transpose out of the range of the active voice, however, no notes will sound; MIDI note numbers will transmit, but notes will not.

Note Map

Note Map lets you change the way notes are sent from the PC3K. The default setting is **Linear**: all notes go out as played. Pressing the **Minus** button takes you to **Off**; no notes are sent, but controllers and other non-note data are.

Setting Note Map to **Inverse** effectively turns the keyboard upside-down, with the highest key being A 0 and the lowest C 9. If you set Note Map to **Constant**, all of the keys on the keyboard will play the same note. The note defaults to C4, but you can change this with the Transpose parameter. This works well when you want the sound from a particular key to play with every note of another zone—for example, playing a ride cymbal with every note in a bass line.

Next are the alternating note maps, which let you divide the keyboard in some unique ways. If you are using two or more MIDI devices (including the PC3K), you can expand polyphony by assigning each zone to a different alternating note map. For example, if you have two PC3Ks, you can assign two zones to each play the same program on a different PC3K, thereby doubling polyphony.

To split a zone into one of two alternating note maps, set Note Map to **1 of 2**; now the zone plays on every second key, starting on C, but won't play on any other keys. Set another zone to **2 of 2**, and this zone will play on every second key, starting on C[#], thus covering the remaining keys.

Three and four-zone alternating notemaps work the same way, but cause each zone to play only on every third and every fourth key, respectively.

Note maps are also used to create drum patterns with the arpeggiator. Several of the ROM setups use this feature.

Velocity Scale (VelScale)

This lets you amplify or diminish velocity response. Normal response is **100%**. Higher values make the keyboard more sensitive (you don't need to play as hard to get higher MIDI velocities) while lower values make it less sensitive (playing harder doesn't change MIDI velocity as much). You can also set the scale to a negative number, in which case the velocity response is turned upside-down: playing harder produces a softer sound and vice versa. This is useful for creating velocity-based crossfades between zones. See the following section on Velocity Offset for ideas about negative scaling.

The following illustration shows what happens when you change Velocity Scale. Note that Velocity Scale is the only parameter changed in this example; the other parameters are set to their defaults (offset = **0**, curve = **linear**, min = **1**, max = **127**).

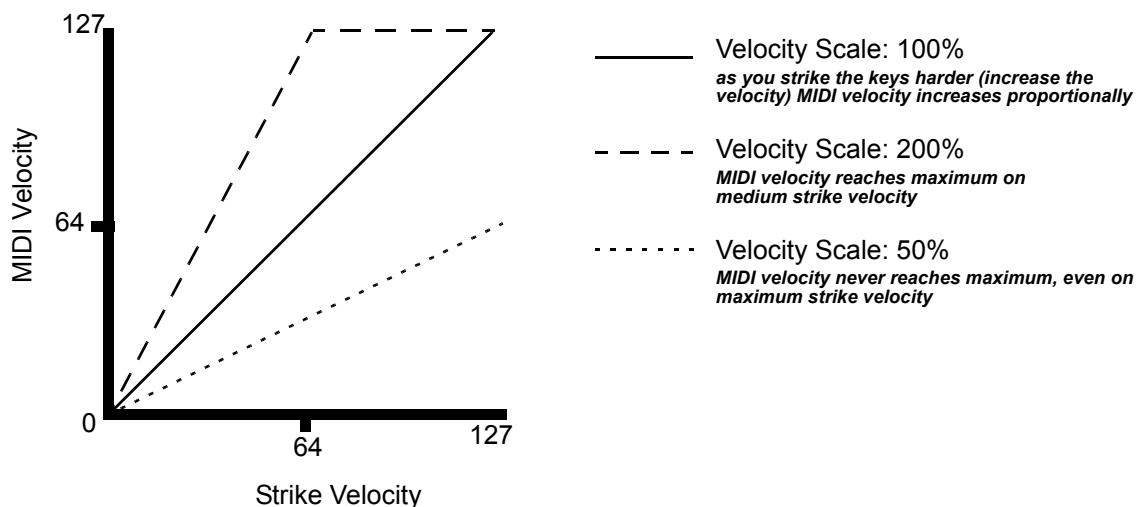

Velocity Offset

VelOffset also changes the response, but in a more direct way, by adding or subtracting a constant to the key velocity. For example, if this is set to **25** (assuming a scale of 100%), then 25 is added to the velocity of every keystroke, usually making the sound that much louder. The softest possible keystroke will have a value of 25, while a keystroke with velocity of 102 will produce the same sound as a note with velocity 127 ($102+25=127$). Negative values diminish the response: a setting of **-25** means the loudest velocity available will be 102, while any keystroke 25 or below will produce a velocity of 1 (a velocity value of zero has a special meaning in MIDI and cannot be used for Note Ons).

You can think of Scale as being a proportional change to the velocity, while Offset is a linear change. The maximum values for Offset are ± 127 . The following illustration shows the effects of Velocity Offset. Note that Velocity Offset is the only parameter changed in this example; the other parameters are set to their defaults (scale = 100%, curve = **linear**, min = 1, max = 127).

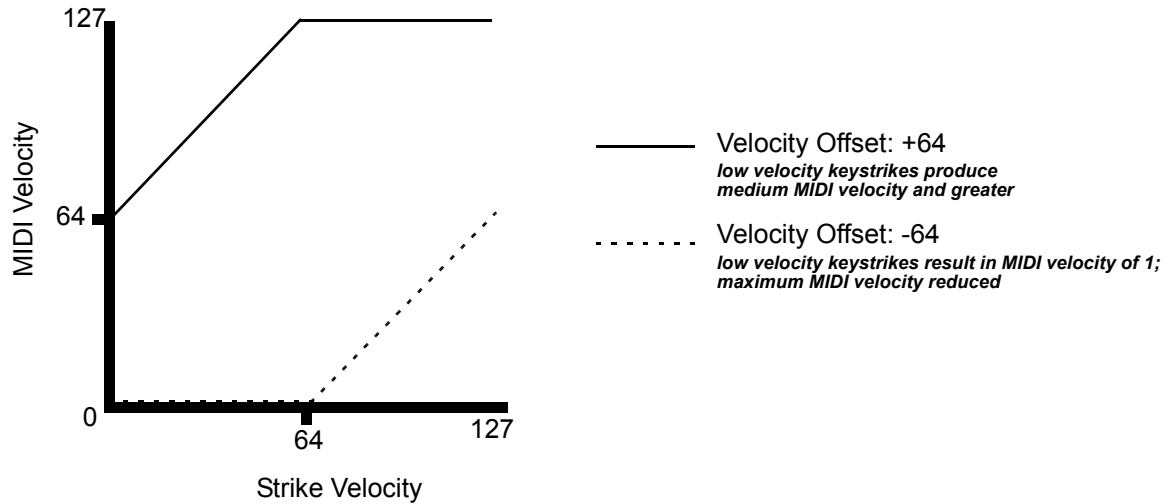

Offset and Scale work together. If scaling takes the velocity out of the ballpark — for example, you want to set it to **300%** but that puts *all* of your notes at maximum velocity — using a negative offset, say around **-60**, can make it possible to still play at different volumes, although your curve will still be a lot steeper than normal. If you use a negative scaling, then you must use an offset: otherwise all of your velocities will end up as zeroes (well, ones actually, since a MIDI note-on with velocity zero is something else). So to get true inverse scaling (that is, minus 100%), you must set an offset of **127** to get the full range of velocities. Setting the offset to **127** and the scale to **-100%** produces a slope like this (which is the same as the reverse linear curve):

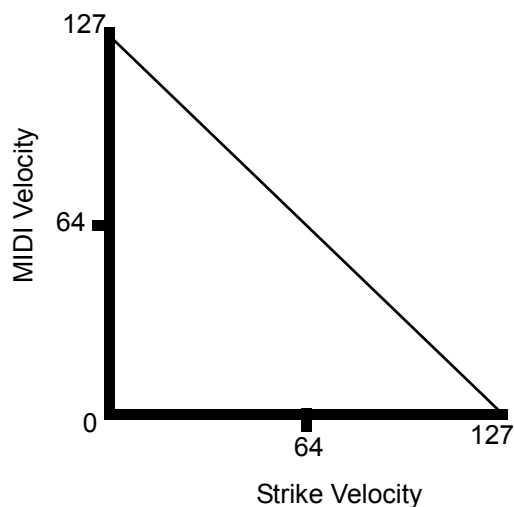

Note that Offset and Scale affect only *MIDI* velocities; that is, these parameters don't change Velocity Tracking in the programs themselves. Therefore, some programs (such as organ sounds, which often have low VelTrk values) may respond only subtly to Offset and Scale, or not at all.

Velocity Curve (VelCurve)

VelCurve lets you taper the velocity response. The default setting is **Linear**, which means that the output velocity changes directly proportionally to the played velocity.

Expand produces a curve that is less steep than the linear curve at keystrike velocities below 64, and steeper than the linear curve at keystrike velocities above 64. In other words, when you're playing softly, you'll notice velocity differences less than with a linear curve, while when you're playing hard, you'll notice velocity differences more.

Compress produces a velocity curve that is the opposite of the expanded curve—that is, you'll notice velocity differences more when you're playing softly than when you're playing hard.

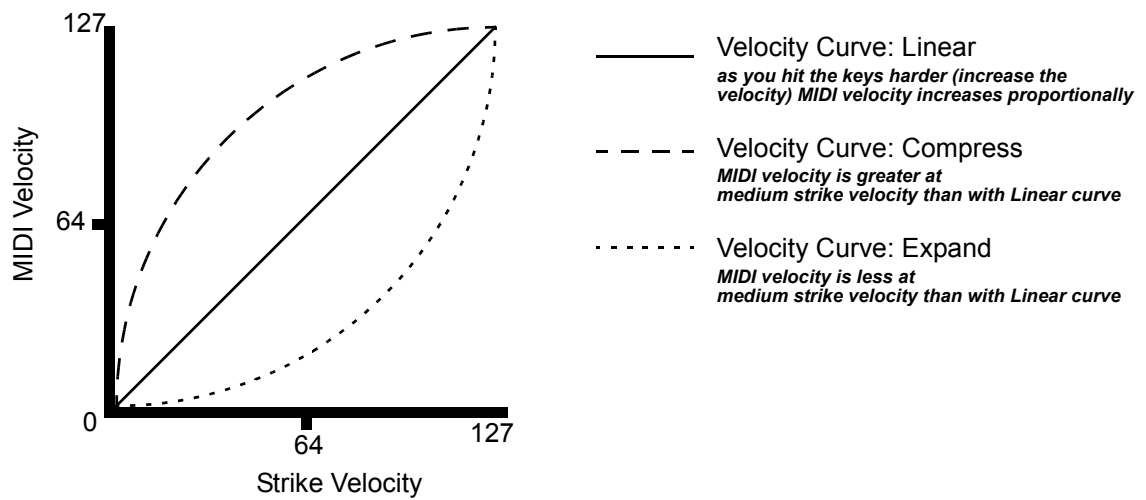

Crossfade is designed to be used in tandem with the Reverse Crossfade curve, enabling you to perform smooth crossfades between different programs.

Bump tapers velocity response to resemble a bell curve, so that notes are loudest when your keystrike velocity is 64. Notes get softer as the keystrike velocity approaches 0 or 127.

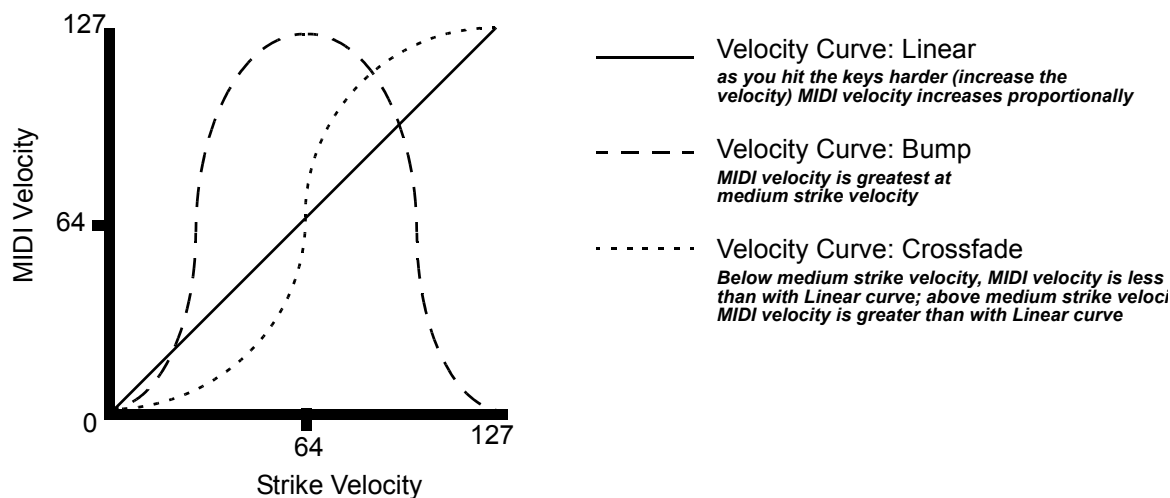

The next four velocity curves are Reverse Linear (**Rvrs Linear**), Reverse Expand (**Rvrs Expand**), Reverse Compress (**Rvrs Compress**), and Reverse Crossfade (**Rvrs Crossfade**). These taper velocity in reverse of the five curves we just covered. For example, Reverse Linear's response is such that striking a key harder will produce a lower volume, striking it softer will produce a higher volume, and so on. This provides a convenient way to achieve negative scaling, by letting you set one parameter instead of two.

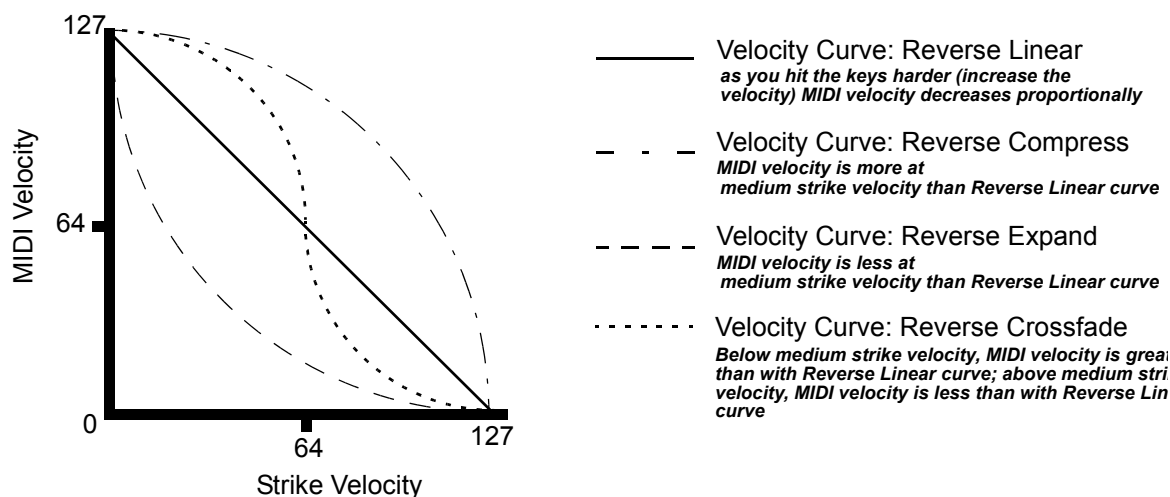

Low Velocity (LoVel), HighVelocity (HiVel)

LoVel and HiVel set the minimum and maximum velocity limits that the current zone transmits. A keystroke in the current zone whose velocity — *after* it has been scaled and offset — is below the minimum does not generate a Note On. Neither does a keystroke whose velocity after processing is above the maximum. These parameters are useful for “velocity switching” — having a key play different sounds depending on how hard you strike it.

The values can be anywhere from 1 to 127. As with other parameters, zones can overlap or be totally discrete, or be identical. Usually, LoVel will have a smaller value than HiVel, but as with LoKey and HiKey, you may also create a gap in velocity response, by setting negative ranges for velocity.

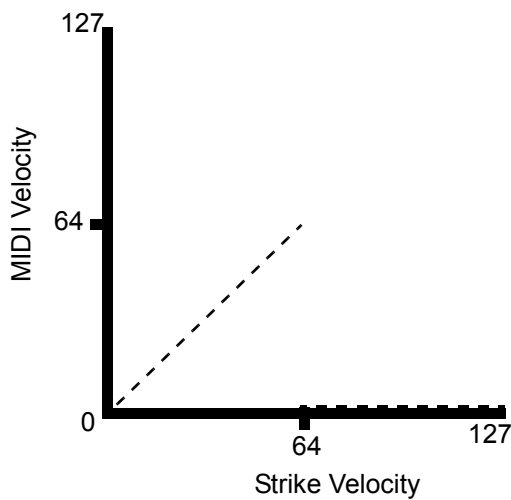

----- Velocity Min: 1, Max: 64
No MIDI Note Ons are transmitted when you strike keys with medium velocity or greater

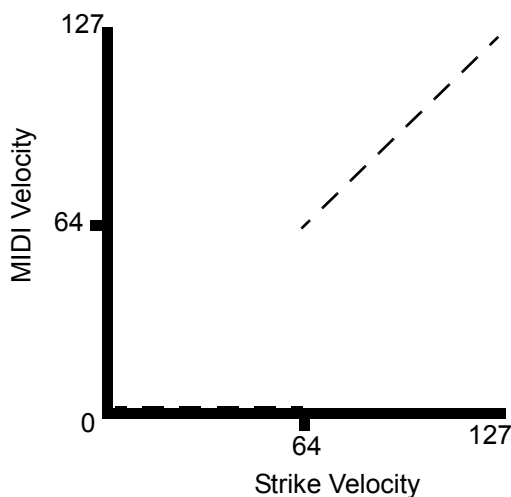

- - - - - Velocity Min: 64, Max: 127
No MIDI Note Ons are transmitted unless you strike keys with velocity of medium or greater

The Pan/Volume (PAN/VOL) Page

By changing the parameters on this page, you can define how each zone sends MIDI volume and pan messages.

```
SetupMode: PAN-VOL #Zone: 1/1
```

```
EntryVolume : None      EntryPan      : None
ExitVolume  : None      ExitPan       : None
```

```
more CH/PRG KEYVEL PANVOL BEND more
```

Parameter	Range of Values	Default
Entry Volume	None, 0-127	None
Exit Volume	None, 0-127	None
Entry Pan	None, 0-127	None
Exit Pan	None, 0-127	None

Entry Volume, Exit Volume

Entry Volume enables you to control the initial MIDI volume setting for each zone of the current setup. When you select a setup in Setup mode, MIDI channels for zones that have an Entry Volume value other than **None** will receive that value as a MIDI volume control message (MIDI Controller 07.) This sets the starting volume level for each zone. Subsequent MIDI volume control signals sent to the setup's MIDI channels affect the volume normally.

When you exit the current setup, each zone sends another volume control message (MIDI Controller 07) to set the volumes on the PC3K's MIDI channels, according to the value of the **Exit Volume** parameter (unless Exit Volume is set to **None**.) The setting of the Volume Lock parameter on the MIDI mode CHANNELS page (see Chapter 10) determines whether this parameter has any effect.

Entry Pan, Exit Pan

You can set entry and exit values for Pan as well. When you select a setup, the PC3K sends a MIDI pan control (MIDI Controller 10) message on each MIDI Channel in each zone; another MIDI pan control message is sent when you exit the setup. The Entry and Exit values for Pan are the same as those for Volume. There is also a Pan Lock parameter on the MIDI-mode CHANNELS page, which overrides the Setup Editor's Pan settings.

If you are trying to set the Pan and the program doesn't seem to be responding, you should check the Mode parameter on the OUTPUT page in the Program Editor. If it is set to **Fixed**, then the PC3K is ignoring the MIDI Pan message; setting Mode to **+MIDI** allows you to control the program's panning from the Setup Editor.

Most programs respond to pan messages on the next keystroke. This means that if you hold a note and change the pan, the current note will stay at its current position until you strike it again. However, a PC3K program that uses the PANNER algorithm will respond to real-time pan adjustments as well.

The BEND Page

The parameters on the BEND page define the bend ranges for each of the three types of pitch bend messages the PC3K can respond to.

```

SetupMode:BEND #Zone:1/1
BendRangeUp(ST) : 2ST  AuxBend1Up   : 12ST
BendRangeUp(ct) : 0ct   AuxBend1Dwn : 12ST
                               AuxBend2Rng : 2ST

BendRangeDown(ST) : 2ST
BendRangeDown(ct) : 0ct

more CH/PRG KEYWEL PANVOL BEND more

```

Parameter	Range of Values	Default
Bend Range Up (semitones)	Prog, 0 to 127 semitones	2
Bend Range Up (cents)	Prog, 100 cents	0
Bend Range Down (semitones)	Prog, 0 to 127 semitones	2
Bend Range Down (cents)	Prog, 100 cents	0
Aux Bend 1 Up	0 to 60 semitones	12
Aux Bend 1 Down	0 to 60 semitones	12
Aux Bend 2 Range	0 to 60 semitones	2

Bend Range (Semitones) and Bend Range (Cents): Up and Down

BendRangeUp(ST) and BendRangeDown(ST) sends a bend range message to an internal program or a MIDI device, telling it how to define subsequent pitch bend messages. Some programs may behave strangely when you change the Bend Range value, because they use FUNs or DSP Functions to affect the pitch wheel. In that case, you should either set the value of Bend Range to **Prog**, or edit the program itself.



NOTE: The settings for BendRangeUp and Down are only reflected in Setup mode. Even if you specify BendRangeUp and Down values for the control setup (setup assignments which are specified in Setup mode and used in Program mode,) bend range values will not be reflected in any mode except Setup mode, and pitch bend messages in the current program (in Program mode) will result in behavior as specified for the Pitch Bend Range parameters on the COMMON page in the Program Editor.

BendRangeUp(ct) and BendRangeDown(ct) lets you fine tune the value for Bend Range (semitones). **100 cents** equals one semitone, or one half-step; you can set this parameter anywhere between **0** and **100** cents.

BendRangeUp, in both semitones and cents, affects all controllers that are set to **PitchUp** (in the default control setup, the PWUp parameter on the WHEEL page is assigned to **PitchUp**). BendRangeDown, in both semitones and cents, affects all controllers that are set to **PitchDwn** (in the default control setup, the PWDn parameter on the WHEEL page is assigned to **PitchDwn**). Any physical controller that uses the Control Destination list can be assigned to **PitchUp** or **PitchDwn**. To keep things simple though, you will normally want to use **PitchUp**

and **PitchDwn** (controller destinations 130 and 131) as a Pitch Wheel destinations (see **PWUp** and **PWDown** on *The WHEEL Page* on page 7-32,) and use **MIDI 21** and **MIDI 15** (controller destinations 21 and 15) for other controllers, such as the Sliders and Ribbon (see **Aux Bend 1 Up/Down** and **Aux Bend 2 Range** below.)

Keep in mind that not all MIDI devices respond to Bend Range messages. With many older MIDI instruments, you must set bend ranges on the devices themselves.

Changing programs sends a Bend Range message with the current program's values. So does pressing **Panic**, which is a quick way to reset your PC3K or MIDI slaves if you've used a controller to modulate the bend range.

Aux Bend 1 Up and Aux Bend 1 Down

Like **BendRangeUp/Down**, **Aux Bend 1** defines the range for Pitch Bend messages, but does so for those physical controllers assigned to controller destination 21, **MIDI 21**. There are two parameters related to **AuxBend 1**: an upward value (**AuxBend1Up**) and a downward value (**AuxBend1Dwn**). Use these parameters to set values for upward and downward pitch-shifting. In most factory setups, **AuxBend 1** is set as the destination for the optional Ribbon controller (see *The RIBBON Page* on page 7-39).

Aux Bend 2 Range

The PC3K allows you to specify a third pitch bend range; this is called **AuxBend 2**, and it defines the range for controllers set to controller destination 15, **MIDI 15**. For **AuxBend 2**, you can set only one range for both upward and downward pitch bending.



A Note About Continuous Controllers and The BEND Page:

Unlike the Pitch Wheel and Ribbon controller, other continuous controllers, such as a slider, will not automatically return to the original center pitch. This can make it hard to accurately return the controller to its center position by hand. In these cases, it is useful to use a separate controller for bending only up or down. For example, to have a slider only bend up, use a slider with an **Add** value of 64 and a **Scale** value of 50%, and **Curv** set to **Linear**. The bottom of the slider will now be the center pitch, and the top of the slider will be the top of your bend range. To have a slider only bend down, use a slider with an **Add** value of -127 and a **Scale** value of 150%, and **Curv** set to **Linear**. The top of the slider will now be the center pitch, and the bottom of the slider will be the bottom of your bend range. See page 7-29 for more on setting continuous controller parameters.

Controllers

Controller editing is one of the strongest aspects of the PC3K's usefulness as the main controller for a sophisticated MIDI studio. In this section, we'll talk about two different types of "controllers" as they apply to the PC3K. One is the *physical* controllers: the wheels, buttons, pedals, etc. that you move with your fingers or feet. The other is *MIDI* Controllers, which are MIDI commands sent by the PC3K. For our purposes, "MIDI Controllers" includes the complete set of Controllers defined by the MIDI Specification, as well as **pitchbend**, **aftertouch**, and a few other useful MIDI commands. To fend off confusion, we'll refer to the PC3K's physical controllers with a lower-case *c*, and MIDI Controllers with an upper-case *C*.

Any *MIDI* Controller can be used as the assignment for any *physical* controller (and for multiple physical controllers, as well). Or in other words, any physical controller like the Mod Wheel can be programmed to send any MIDI control signal. In addition, each controller in each setup zone can be tweaked just like keyboard velocity (or any other Setup-mode parameter). Although controller editing on the PC3K can be somewhat complex, it can also be very rewarding.

To get an idea of the expressive capabilities of Setup mode, explore the factory setups that come with the PC3K.

The PC3K’s physical controllers include the following:

- The nine sliders (A, B, C, D, E, F, G, H, I) in the Assignable Controllers section
- The two Continuous Control Pedal jacks (CC Pedal 1 and CC Pedal 2)
- The optional Ribbon Controller, which you can define as a one- or three-section controller
- The Pitch Wheel
- The Modulation Wheel (Mod Wheel)
- Keyboard aftertouch, or Mono Pressure (MPress)
- The optional Breath Controller (which is connected to Continuous Controller Pedal 2)
- The two Panel Switches above the Pitch and Mod Wheels and Program Buttons 1–8
- The three Footswitch pedal jacks (1, 2, and 3)

The following tables provide an overview of the physical controllers and their parameters.

Continuous Controllers

See *Continuous Controller Parameters* on page 7-29 for information on each parameter.

Physical Controller	Setup Editor Page	Parameter:Values
Sliders A, B, C, D, E, F, G, H, I	SLID, SLID2	Destination: Control Destination List
		Scale: -300% to 300%
		Add: -128 to 127
		Curve: Linear, Compress. Expand
		Entry Value: None, 0 to 127
		Exit Value: None, 0 to 127
CPedals 1 & 2 / Breath	CPEDAL	(same as Sliders)
Ribbon	RIBBON	(same as Sliders)
Pitch Wheel and Mod Wheel	WHEEL	(same as Sliders)
MPressure	PRESS	(same as Sliders)

Table 7-2 Continuous Controllers

Switch Controllers

See *Switch Controller Parameters* on page 7-30 for information on each parameter.

Physical Controller	Setup Editor Page	Parameter:Values
Footswitches 1, 2, and 3	FT SW1, FT SW2, FT SW3	SwType: Toggle, Momentary, Note Toggle, Note Momentary
		Destination: Control Destination List
		On Value: None, 0 to 127
		Off Value: None, 0 to 127
		Entry Value: None, Off, On
Arp and SW switches	ARP SW, SWITCH	(same as Footswitches)
		(same as Footswitches)
Programmable switches 1 to 8	SWPRG1, SWPRG2, SWPRG3, SWPRG4, SWPRG5, SWPRG6, SWPRG7, SWPRG8	(same as Footswitches)

Table 7-3 Switch Controllers

The Controller Destination List

The table below contains the available values for the Destination parameter for each controller, in scrolling order. Note that the PC3K has destinations with Controller Numbers greater than 127—there are 128 MIDI Controllers, as dictated by the MIDI spec. Any data sent to destinations with a Controller number outside of the MIDI range (i.e., more than 127) are sent as a PC3K-specific protocol, and are thus not sent as MIDI data, and not sent through MIDI Out.

Controller Number	Corresponding Destination Name	Description
0	OFF/Bank	By default, when you enter 0 or Clear for the Destination parameter, the destination will be assigned to OFF . To select Bank as the destination, use the Alpha Wheel or -/+ buttons.
1	MWheel	Default assignment for Mod Wheel
2	Breath	Default assignment for Breath Controller
3	MIDI 03	
4	Foot	Default assignment for CC Pedal 2
5	PortTim	Monophonic PC3K programs respond to this Controller if portamento is turned on

Table 7-4 Controller Destination List

Setup Mode

Controllers

Controller Number	Corresponding Destination Name	Description
6	Data	Almost all PC3K programs have this Controller assigned to filter frequency or brightness
7	Volume	MIDI Volume
8	Balance	MIDI Balance
9	MIDI 09	
10	Pan	MIDI Pan—programs which use the PANNER algorithm will respond to real-time pan adjustments; all other programs will respond on the next note start
11	Express	MIDI Expression—Default assignment for CC Pedal 1. An attenuator for fading in and out. It scales between minimum (0) and the current value of Volume
12	MIDI 12	
13	MIDI 13	Default assignment for Slider B
14	MIDI 14	
15	MIDI 15	Controls pitchbend for AuxBend2. (<i>see The BEND Page on page 7-18</i>)
16	Ctl A	
17	Ctl B	
18	Ctl C	
19	Ctl D	
20	MIDI 20	
21	MIDI 21	Default destination for Ribbon, controls pitchbend for AuxBend1. (<i>see The BEND Page on page 7-18</i>)
22–28	MIDI 22–28	Default destinations for Sliders C to I
29	MIDI 29	Default destination for SW button
30, 31	MIDI 30, 31	MIDI Controllers 30, 31
32	Bank	
33–63	33–63	MIDI Controllers 33–63
64	Sustain	Default destination for Footswitch 1
65	MIDI 65	
66	Sostenut	Default destination for Footswitch 2—holds notes that are currently down, but not notes played subsequently (<i>see Sostenuto Pedal (SosPdl) on page 6-20</i>)
67	Soft	Default destination for Footswitch 3—lowers the volume by a preset amount and may soften the timbre as well (<i>see The Footswitch Pages (FT SW1, FT SW2, FT SW3) on page 7-36</i>)
68	Legato	Forces mono playback
69	Freeze	Envelopes freeze at current state
70–83	MIDI 70–83	MIDI Controllers 70–83

Table 7-4 Controller Destination List (Continued)

Controller Number	Corresponding Destination Name	Description
84	Portamen	Portamento control, best with mono voices, value is relative to key range, makes pitch momentarily slide to a note
85–90	MIDI 85–90	MIDI Controllers 85–90
91	GM Reverb	With PC3K in General MIDI mode, controls Reverb send level
92	MIDI 92	
93	GM Chorus	With PC3K in General MIDI mode, controls Chorus send level
94-95	MIDI 94-95	MIDI Controllers 94–95
96	Data Inc	Equivalent to pressing the plus button
97	Data Dec	Equivalent to pressing the minus button
98	NRegParL	Non-Registered Parameter Least Significant Byte
99	NRegParM	Non-Registered Parameter Most Significant Byte
100	RegParL	Registered Parameter Least Significant Byte
101	RegParM	Registered Parameter Most Significant Byte
102-108	MIDI 102-108	MIDI Controllers 102–108
109	MIDI 109	Set's arpeggiator velocity when ARPEGGIATOR velocity is set to MIDI 109 mode
110-119	MIDI 110-119	MIDI Controllers 110–119
120	Sound Off	Stops all sound in the corresponding channel
121	RstCtls	Reset Controllers to defaults in the corresponding channel
122	Local	
123	Notes Off	Sends Note Off Message to all playing notes in the corresponding channel
124	Poly	
125	Omni	
126	Mono On	
127	Mono Off	
128	Pitch	Pitch—values above and below 64 bend the pitch up and down, respectively
129	PitchRev	Pitch—values above and below 64 bend the pitch down and up, respectively
130	PitchUp	Pitch—values above 0 bend the pitch up
131	PitchDwn	Pitch—values above 0 bend the pitch down
132	Pressure	Pressure
133	Tempo	Tempo
134	KeyNum	Triggers playback of notes by Key Number—e.g., C4 is 60
135	KeyVel	Key Velocity
136	ProgInc	Program Increment—increments current program number
137	ProgDec	Program Decrement—decrements current program number
138	ProgGoto	Go to Program—selects program

Table 7-4 Controller Destination List (Continued)

Setup Mode

Controllers

Controller Number	Corresponding Destination Name	Description
139	SetupInc	Setup Increment—increments current setup number
140	SetupDec	Setup Decrement—increments current setup number
141	SetpGoto	Go to Setup—selects setup
142	Start	Sequencer function
143	Stop	Sequencer function
144	Continue	Sequencer function
145	TransUp	Transpose Up (ST)
146	TransDown	Transpose Down (ST)
147	ArpOn	Any value turns Arpeggiator On. (See <i>The ARPEGGIATOR Page</i> on page 7-42)
148	ArpOff	Any Value turns Arpeggiator Off. (See <i>The ARPEGGIATOR Page</i> on page 7-42)
149	MuteZn	Mute Zone – values above 64 will mute the zone, values below or equal to 64 will unmute the zone.
150	ArpOrder	Arpeggiator Order, each range of values selects one of nine options in order on parameters list: 0-14, 15-28, 29-42, 43-56, 57-70, 71-84, 85-98, 99-112, 113-127. (See <i>The ARPEGGIATOR Page</i> on page 7-42)
151	ArpBeats	Arpeggiator Beats, each range of values selects one of seven options in order on parameters list: 0-18, 19-36, 37-54, 55-72, 73-90, 91-108, 109-127. (See <i>The ARPEGGIATOR Page</i> on page 7-42)
152	ArpShift	The 88 Arpeggiator Shift steps are scaled over the 128 MIDI controller values, so that 0 = 0 steps and 127 = 88 steps. (See <i>The ARPEGGIATOR Page</i> on page 7-42)
153	ArpLimit	The 60 Arpeggiator Shift Limit steps are scaled over the 128 MIDI controller values, so that 0 = 0 steps and 127 = 60 steps. (See <i>The ARPEGGIATOR Page</i> on page 7-42)
154	ArpLmtOp	Arpeggiator Shift Limit Option, each range of values selects one of seven options in order on parameters list: 0-18, 19-36, 37-54, 55-72, 73-90, 91-108, 109-127. (See <i>The ARPEGGIATOR Page</i> on page 7-42)
155	ArpVel	Arpeggiator Velocity, each range of values selects one of twenty-three options in order on parameters list: 0-5, 6-10, 11-15...101-105, 106-110, 111-127. (See <i>The ARPEGGIATOR Page</i> on page 7-42)
156	ArpDur	The Arpeggiator Duration % values are scaled over the 128 MIDI controller values, so that 0 = 1% and 127 = 100%. (See <i>The ARPEGGIATOR Page</i> on page 7-42)
157	Latch	For Arpeggiator Latch Pedals mode, 0-63 = off, 64-127 = on. (See <i>The ARPEGGIATOR 2 Page</i> on page 7-49)
158	Latch2	For Arpeggiator Latch Pedals mode, 0-63 = off, 64-127 = on. (See <i>The ARPEGGIATOR 2 Page</i> on page 7-49)

Table 7-4 Controller Destination List (Continued)

Controller Number	Corresponding Destination Name	Description
159	ArpGliss	Arpeggiator Gliss, 0-63 = off, 64-127 = on. (See <i>The ARPEGGIATOR 2 Page</i> on page 7-49)
160	SusLatch	For Arpeggiator Latch Pedals mode, 0-63 = off, 64-127 = on. (See <i>The ARPEGGIATOR 2 Page</i> on page 7-49)
161	Panic	Panic
162	SoloZn	Solo Zone
163	RiffOn	Riff On (See <i>Riffs</i> on page 7-55)
164	RiffOff	Riff Off (See <i>Riffs</i> on page 7-55)
165	RiffDur	Riff Duration (See <i>Riffs</i> on page 7-55)
166	RiffVel	Riff Velocity (See <i>Riffs</i> on page 7-55)
167	RiffDly	Riff Delay (See <i>Riffs</i> on page 7-55)
168	TapTempo	Tap Tempo (See <i>TEMPO</i> on page 11-11)
169	KB3Mutes	KB3 Mutes—in Setup Mode, values of 63 and below disable the Bank buttons for controlling KB3 programs in that setup, and a values above 64 enable them
170	-Arp Shift	Sets ARPEGGIATOR values for Shift to negative. 0-63 = off, 64-127 = on. (See <i>The ARPEGGIATOR Page</i> on page 7-42)
171	ShiftPatt	Selects one of the 128 patterns in the current ARPEGGIATOR ShiftPatt Bank. (See <i>The ARPEGGIATOR Page</i> on page 7-42)
172	ShiftPBank	A controller value selects the corresponding ShiftPatt Bank for the ARPEGGIATOR page of a controller's zone. For example, controller value 2 selects ShiftPatt bank 2, controller value 7 selects ShiftPatt bank 7. (See <i>The ARPEGGIATOR Page</i> on page 7-42)
173	VelPatt	Selects one of the 128 patterns in the current ARPEGGIATOR VelPatt Bank. (See <i>The ARPEGGIATOR Page</i> on page 7-42)
174	VelPBank	A controller value selects the corresponding VelPatt Bank for the ARPEGGIATOR page of a controller's zone. For example, controller value 2 selects VelPatt bank 2, controller value 7 selects VelPatt bank 7. (See <i>The ARPEGGIATOR Page</i> on page 7-42)
175	VelFixed	Set's arpeggiator velocity when ARPEGGIATOR velocity is set to Fixed. (See <i>The ARPEGGIATOR Page</i> on page 7-42)
176	ShKeyNum	Shift Key Number (see below)
177	ShiftKey	Shift Key (see below)
178	ShKeyNuV	Same as 176 ShKeyNum, but the Shift Pattern's velocity will be modified by the current velocity pattern of the zone.

Table 7-4 Controller Destination List (Continued)

Shift Key Number, Shift Key (ShKeyNum, ShiftKey)

These controller destinations allow you to play musical scales and single note patterns on any programmable continuous controller in a setup, without the need of playing the physical keys of the keyboard. These features are especially useful for playing fast arpeggiations. These destinations only work when combined with other destinations and features, so be sure to read this whole section to gain a complete understanding.

Using a Kurzweil Ribbon as a controller gives you the most options, but these destinations can also be controlled by any slider, pedal, key pressure, etc. Using the Kurzweil Ribbon provides more accurate control since it has a longer physical range than other controllers. Also, if you set it in Absolute mode, you can jump from one note to any other note in the pattern in any octave. With a slider you have to go through all the intermediate notes of the pattern. A way of partially doing this with sliders is to assign the Shift Key Number controller to several sliders with different ranges. (See *The Ribbon Configuration (RIBCFG) Page* on page 7-40 for details on Ribbon options, and *Scale and Add* on page 7-29 for details on changing controller ranges.)

Shift Key Number (ShKeyNum, controller destination 176) works in a similar way to **Key Number (KeyNum, controller destination 134)**. Both controllers basically generate a monophonic stream of notes. The difference is that Key Number plays through all notes chromatically, while Shift Key Number only plays notes relative to a Shift Pattern.

For example, when controlling Shift Key Number from a slider, notes are triggered from a Shift Pattern in forwards order as you move the slider up, and backwards order as you move the slider down. If in our zone we have selected the Shift Pattern 2: minor, the notes being played by the slider will be only the root, the minor third and fifth in the chosen key, triggering notes in any octave up and down the keyboard. (See *Shift Key* below for details on selecting the root note and octave.)

Selecting The Desired Notes:

You must select a Shift Pattern for the desired zone in order for Shift Key Number to have an effect. To select a Shift Pattern for the current zone in a setup, enter the setup editor and go to the ARPEGGIATOR page. Select a Shift Pattern from the ShiftPatt field. If using multiple zones, a different pattern can be selected for each. The ShiftPatt field is usually used with the arpeggiator, but can also be used in combination with the controller destinations Shift Key Note, Shift Key, and Key Velocity. These destinations can use a zone's Shift Pattern whether the arpeggiator is on or off without conflict. For more information on Shift Patterns such as editing and saving, see *Shift Pattern (ShiftPatt)* on page 7-47. (Note that the ShiftPatt Up or Down options, as well as any of the arpeggiator parameters other than ShiftPatt do not have an effect on Shift Key Number.) You can also set controllers to destination 171 (**ShiftPatt**) to select a pattern from the current bank of 128 shift patterns, and destination 172 (**ShiftPBank**) to select a bank from banks of 128 shift patterns each.

Selecting The Desired Velocity:

In order to have a note sound when using Shift Key Number, you first need to send a **Key Velocity** message (**KeyVel, controller destination 135**) with a non zero velocity. You must set a controller to this destination, it's useful to set a slider or other continuous controller in order to control velocity while playing. The next notes to be triggered by Shift Key Number will be played with the last received KeyVel velocity. One note triggered by these controllers sounds until another note is triggered or until a KeyVel message with velocity 0 is sent.

Selecting The Desired Key (Root Note):

Shift Key (**ShiftKey**, controller destination 177) allows the user to select the key (root note) of the Shift Pattern triggered by Shift Key Number. A Shift Pattern is a relative pattern based on a root note. All notes triggered by a Shift Pattern are shifted from the root note by the value of each pattern step (in half-steps.)

Shift Key Settings

Value	Key (root note)
0-9	C
10-19	C#
20-29	D
30-39	D#
40-49	E
50-59	F
60-68	F#
69-78	G
79-88	G#
89-98	A
99-108	A#
109-118	B
119-127	Last Note Played

When using a Shift Pattern with Shift Key Number you can select the key with one or more controllers set to the Shift Key destination. You can use a continuous controller such as a slider to cycle through keys, or switches set to predetermined keys. For example, if you are playing a song that moves between 2 or 3 keys, a couple of switches could be programmed in order to send the appropriate Shift Key message for each key change. That way all the notes you are triggering with a Shift Key Number controller will be in the appropriate scale. You could also create a setup for a song with multiple zones, each with its own pre-set key and appropriate shift pattern. That way, for each chord change you could move a different controller that would create the correct harmony.

Another way to choose a key is to set Shift Key to Last Note Played mode, in which the last note played in the zone will set the key. For example, you could set the zone being used for Shift Key Number to have a Key Range that covers only a few of the keyboard's lowest octaves. This would allow you to play root note bass lines that change the key that Shift Key Number plays in, leaving the upper octaves of the keyboard open for use by other zones.

If Shift Key is set to Last Note Played and no note is played, the default key is C. Each zone can have a different Shift Key, so you can have zones preprogrammed with the keys you want to use, or have them all in the same key, or just change the key in real time while you are playing.

A Note About Octave Range:

When using Shift Key Number, shift patterns with more than 12 steps begin triggering notes in higher octaves. This is done because longer shift patterns use up more of a controller's range, and limit the number of octaves that a single controller can trigger. Since the lowest octave of a program is often too low to be musically useful, the PC3K will automatically start triggering notes from longer shift patterns in higher octaves. This saves room in the controller's range of values for triggering more useful octaves. See the table below for Shift Pattern step ranges and their corresponding starting octave.

Default Octave Shifting

Total # of Shift Pattern Steps	Starting Octave
1-12	C0-C1
13-24	C1-C2
25-36	C2-C3
37-48	C3-C4

Selecting The Desired Octave Range:

You adjust the starting octave manually, using the Add parameter on the corresponding controller's setup page. In the Add field, the addition or subtraction of the number of steps in your current shift pattern will raise or lower the starting octave in relationship to the default starting octave. For example, in a shift pattern with 3 steps, an Add value of 9 would cause a controller value of 0 to make Shift Key Number trigger notes in octave C3-C4, 3 octaves above the default C0-C1. Add values that are not multiples of the number of current shift pattern steps will change which step the pattern begins on at controller value 0, thus offsetting the relationship between all of the controller's values and current shift pattern's steps.

Adjusting Controller Range:

When using Shift Key Number, the number of steps in the Shift Pattern also affects the range of values that will cause a controller to trigger a shift pattern step, and in turn affect the useful range of the physical controller. With a shift pattern of 12 notes, the 128 different notes that the PC3K can trigger are evenly spaced over the range of the controller. Patterns with less than 12 steps will trigger notes in every octave over a shorter range of the controller. For example, in a shift pattern with 3 steps, by default the controller values 0 to 2 will trigger notes starting in the lowest possible octave, and controller values 27 to 30 will trigger notes in the highest possible full octave. Using a slider for this controller, only about 1/4th of the length of the slider would be triggering notes. This decreased useful range makes the controller harder to use accurately. To remedy this, you can adjust a controller's behavior by using the Scale parameter on the corresponding controller's setup page (see *Scale* below.) Adjust the Scale value to stretch the useful values of the controller across its whole physical range. A scale value of less than 100% will be helpful for patterns with fewer than 12 steps. Experiment by adjusting the scale value until the highest desired note is triggered at the top of the controller's physical range. See *Scale* in the Continuous Controller Parameters section of this chapter for more details on the Scale parameter. For shift patterns with more than 12 steps, you will run out of controller values before your shift pattern triggers in every octave. If you want to be able to access all of the available octaves, you can achieve this by setting multiple controllers to Shift Key Number. Next, use the Scale and Add parameters for each controller, adjusting each to trigger the desired range of octaves (see *Add* below.)

Continuous Controller Parameters

The continuous (physical) controllers are those that have a *range* of values: the two wheels, the optional ribbon controller, the nine sliders, the two Continuous Control pedals, the optional breath controller (the jack of which is connected to CC pedal 2), and mono pressure (aftertouch). As the table on page 7-20 shows, all of them use the same parameters. Each parameter's function is described below.

Dest

Use this parameter to select a destination from the MIDI Controller Destination list (see page 7-21).

Scale

After you've selected a continuous physical controller, you can modify the controller's response similarly to the ways you can modify velocity response. Refer to the graphs beginning on page 7-11 for illustrations of the velocity scaling parameters.

Scale lets you amplify or diminish the action of the controller. Full scale is 100%. Higher values will make the controller more sensitive, and lower values will make it less so. Setting the scale to a negative number makes the controller action work in reverse. As with velocity, you can use a controller to crossfade between two zones by setting the scaling for one zone positive and the other negative. Maximum scale values are **+300%** and **-300%**.

Add

This adds or subtracts a constant to the controller, and at the same time sets minimum or maximum values (there's no need for separate Max and Min parameters). If Add is **25**, the minimum value of the controller will be 25. If it is **-25** (and scale is **100%**) the first one-fifth of the controller's movement ($25/127 \approx 1/5$) will send value of 0, and the maximum value of the controller will be 102 (= 127-25). As with velocity, Scale is a proportional change to the controller, while Offset is a linear change. The values for Offset range from **-128** to **127**.

Curv

This lets you taper the controller response. The default setting is **Linear**, which means that the response follows a straight line as you move the controller.

Setting Curv to **Expand** produces a curve that is less steep than the linear curve at keystroke velocities below 64, and steeper than the linear curve at keystroke velocities above 64. In other words, when you're playing softly, you'll notice velocity differences less than with a linear curve, while when you're playing hard, you'll notice velocity differences more.

Setting Curv to **Compress** produces a velocity curve that is the opposite of the expanded curve—that is, you'll notice velocity differences more when you're playing softly than when you're playing hard.

You can also create "reverse" versions of the three described curves. First, select your desired curve. Then set the Scale parameter to **-100%**, and set the Add parameter to **127**. This makes the selected controller send a value of 127 when all the way down and a value of 0 when all the way up.

To get an idea of how these curves affect controller response, refer to the Velocity Curve charts, which begin on page 7-11.

Entry (Ent) and Exit Values

Entry value allows you to specify an initial value for a controller in a Setup that will be sent whenever you select that Setup. For example, if you want to make sure that all of the modulation for the Program in a Zone is turned off when you select a Setup, use the Setup Editor to assign a physical controller to a destination of MIDI 01 (MWheel) and set Entry Value to **0**. (The Mod Wheel is usually assigned to destination MIDI 01 MWheel, which is used to control a modulation parameter for most Programs.)

Entry values ignore the current position of the physical controller when the setup is selected. By default, once the Setup is loaded and the entry values have been sent, moving a controller will instantly send new controller values. This can cause a jump in values if the controller happens to be set to a value far from its entry value. To avoid these jumps, change the SetupCtrls parameter in Master Mode to **PassEntry** (see *Setup Controllers (SetupCtrls)* on page 11-2 for details.) With SetupCtrls set to **PassEntry**, moving the controller will have no effect until it moves past its entry value. In this case, continuing the modulation example above, moving the assigned controller won't turn on any modulation until it's pushed all the way *down* (passing entry value 0,) and then up again.

An entry value of **None** is quite different from a value of **0**. **None** means that there will be no initial controller command when the setup is selected, and any subsequent movement of the physical controller will be effective.

Exit Value tells the PC3K to send a value for that controller whenever you leave the setup, either by selecting another setup or by selecting a different mode altogether. It can be very useful when a controller is doing something to the sound, and you don't want that effect to continue after you leave the setup. For example, if you want to make sure a zone's pitch returns to normal whenever you leave a setup, you would set Exit Value to **64** for any controller whose Destination parameter is set to **PitchUp**. Again, **None** means no command is sent.



Note: Programs can also be saved with controller entry values (on the Program Editor CONTROLLERS page.) When a Setup is loaded, entry values for the Programs in the Setup are sent first, followed by the entry values for the Setup. Because of this, if a Setup and a Program used by a Setup have entry values set for the same controller, the entry value for the Setup will be used. If a Program used by a Setup has an entry value set for a controller, but the Setup has an entry value of **None** for the same controller, the entry value from the Program is used.

Switch Controller Parameters

Switch (physical) controllers have only two states: on and off. The PC3K switch controllers are:

- Panel Switches **Arp** and **SW**
- Footswitch Pedals 1, 2, and 3
- Programmable Switches 1–8 (**Program Select** buttons 1–8)

Keep in mind the following two things when working with the PC3K's switches. First, in Setup Mode the Bank buttons above the sliders are dedicated to zone status and muting, and are *not* assignable controllers. (If the setup contains a KB3 Program, the Bank buttons can be used to control KB3 functions, see *Mutes* on page 7-66 for details.) Second, in Program mode, the **Program Select** buttons function as program select buttons if none of them are assigned to a destination in the control setup (see *Control Setup* on page 6-9 for details.) If at least one Programmable Switch is assigned in the control setup, then the assigned **Program Select** buttons act as assigned, but none of the buttons function as program select buttons.

Switch Type (Type)

The parameters for switch controllers are slightly different from those for continuous controllers. The first parameter is Type. The choices available are **Momentary** in which a switch's action lasts only as long as you are pushing it, and **Toggle**, in which the switch's action lasts until you press it again.

Momentary mode is used for functions like sustain or portamento, while Toggle mode is used for functions such as arpeggiator on/off. The buttons show which mode they are in by the behavior of their lights: if a button is in Momentary mode, its light glows only as long as you are holding it, while if it is in Toggle mode, the light stays on until you press it again. Bear in mind that button assignments are independent per zone, and since there's just a single light per button, the light shows the state of the button only for the current zone. When you press the button, however, it executes its assignments for all zones that use that button.

On Control (OnControl)

OnControl determines what MIDI Controller or other message will be sent when the switch is on—that is, either pressed and held or toggled from the off position. The list of available controllers on page 7-21 is the same as for the continuous controllers, and can be accessed the same way.

Off Control (OffControl)

OffControl determines what MIDI Controller or other message will be sent when the switch is off—that is, either unpressed or toggled from the on position. The list of available controllers on page 7-21 is the same as for the continuous controllers, and can be accessed the same way.

OnValue

OnValue sets the value of the Controller when the switch is on. In the case of conventionally switched functions, such as sustain, the OnValue will be **127**. (For example, the default for Footswitch 1 is Controller 64 — **Sustain** — with an On Value of **127**.) However, you might want to use a button or pedal as a “soft” switch, in which case you might set OnControl to 7 (Volume) and OnValue to **50**, and OffControl to 7 and OffValue to **127**. OnControl and OffControl can also both be set to **Off**, so that turning on the switch has no effect at all in this zone. This can be useful when you are using one switch for multiple functions in different zones.

OffValue

OffValue is the value of the Controller when the switch is off. The default value is **0**. You might want to change this, as in the “soft switch” example above: in order to bring the zone up to full volume when you release the pedal, set OffValue to **127**.

Entry (Ent) and Exit States

Entry State determines whether an initial setting for the switch will be sent when the setup is selected. There are three choices: **None** (no change), **Off** (the Off value), and **On** (the On value). With a Panel Switch button, if the Entry State is **On**, the button will light as soon as you select the setup.

Exit State similarly determines whether a setting for the switch will be sent when you leave the setup, either for another setup or for Program mode. The same three choices (**On**, **Off**, and **None**) are available. This is very useful for turning off sustains when changing setups.

The WHEEL Page

The two wheels are typical of what is found on many keyboards. The left one is normally used for pitch bend and springs back to center, while the right wheel is normally used as a standard Mod Wheel. On the Wheel page in the Setup editor, the pitch wheel has two parameters—one for pushing the pitch wheel up and one for pushing it down—whereas the mod wheel has one.

The WHEEL page parameters are described in *Continuous Controller Parameters* on page 7-29.

```

SetupMode:WHEEL                                     #Zone:1/1
      Dest      Scale Add  Curv  Ent  Exit
PWUP PitchUp   100%  0   Linear  None None
PWDn PitchDwn  100%  0   Linear  None None
MWhl MWheel    100%  0   Linear  None None

more WHEEL SLIDER SLID2 CPEDAL more
    
```

Parameter	Range of Values	Default
Destination (PWUp)	Control Destination List	PitchUp
Destination (PWDn)	Control Destination List	PitchDwn
Destination (MWhl)	Control Destination List	MWheel
Scale	± 300%	100%
Add	-128 to 127	0
Curve	Linear, Compress, Expand	Linear
Entry Value	None, 0 to 127	None
Exit Value	None, 0 to 127	None

The SLIDER and SLID2 Pages

You can assign each of the PC3K's nine programmable sliders to a destination on each of the 16 zones. Or, you can assign any combination of sliders to the same zone, allowing you tremendous flexibility. For example, you can assign Sliders A and B to modulate pitch and volume on Zone 1, then assign Slider C to control panning on Zones 2, 3, and 10.

The **SLIDER** soft button gives you access to Sliders A–E. Press the **SLID2** soft button to program Sliders F–I. The SLIDER page parameters are described in *Continuous Controller Parameters* on page 7-29.

```

SetupMode:SLIDER #zone:1/1
  Dest      Scale  Add  Curv  Ent  Exit
SlidA Data    100%  0    Linear  None None
SlidB MIDI13  100%  0    Linear  None None
SlidC MIDI22  100%  0    Linear  None None
SlidD MIDI23  100%  0    Linear  None None
SlidE MIDI24  100%  0    Linear  None None
more WHEEL SLIDER SLID2 CPEDAL more
  
```

```

SetupMode:SLIDER #zone:1/1
  Dest      Scale  Add  Curv  Ent  Exit
SlidF MIDI25  100%  0    Linear  None None
SlidG MIDI26  100%  0    Linear  None None
SlidH MIDI27  100%  0    Linear  None None
SlidI MIDI28  100%  0    Linear  None None
more WHEEL SLIDER SLID2 CPEDAL more
  
```

Parameter	Range of Values	Default
Destination (Slider A)	Control Destination List	Data
Destination (Slider B)	Control Destination List	MIDI 13
Destination (Slider C)	Control Destination List	MIDI 22
Destination (Slider D)	Control Destination List	MIDI 23
Destination (Slider E)	Control Destination List	MIDI 24
Destination (Slider F)	Control Destination List	MIDI 25
Destination (Slider G)	Control Destination List	MIDI 26
Destination (Slider H)	Control Destination List	MIDI 27
Destination (Slider I)	Control Destination List	MIDI 28
Scale	±300%	100%
Add	-128 to +127	0
Curve	Linear, Compress, Expand	Linear
Entry Value	None, 0 to 127	None
Exit Value	None, 0 to 127	None

The Continuous Control Pedal (CPEDAL) Page

If you look at the back of the instrument, you will see that there are two jacks for plugging in two CC (Continuous Control) pedals and a jack labeled Breath Controller. Like the nine programmable sliders, you can assign these controllers on each of the 16 zones, or you can assign any combination of these controllers to the same zone.

The CPEDAL page parameters are described in *Continuous Controller Parameters* on page 7-29.

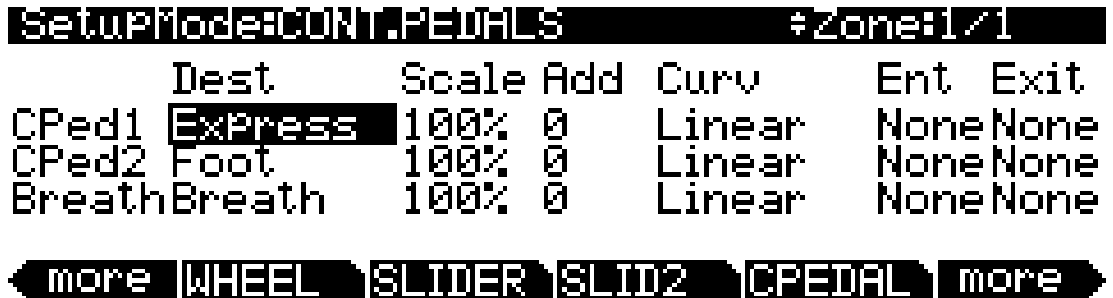

Parameter	Range of Values	Default
Destination (CPed1)	Control Destination List	Express
Destination (CPed2)	Control Destination List	Foot
Destination (Breath)	Control Destination List	Breath
Scale	± 300%	100%
Add	-128 to +127	0
Curve	Linear, Compress, Expand	Linear
Entry Value	None, 0 to 127	None
Exit Value	None, 0 to 127	None

The Pressure (PRESS) Page

The PC3K features mono pressure, commonly called aftertouch on other keyboards.

A word about pressure: Key Range in a zone does *not* define which notes will generate pressure in that zone. If pressure is enabled in a zone, playing with aftertouch *anywhere* on the keyboard will produce data. For example, if Zone 1's Key Range is C3–C5 and you play C2 and push down on the note, pressure messages will be sent from Zone 1. As with any other physical controller, however, you can disable pressure in any zone, or scale it or offset it differently in the various zones. It might help to think of pressure as an extra wheel—wheels operate in a zone regardless of Key Range, and so does pressure.

The PRESS page parameters are described in *Continuous Controller Parameters* on page 7-29.



Note: MIDI pressure generated on the PC3K keyboard is first affected by any Pressure Scale, Offset, and Curve settings made on each zone's PRESSURE page. The resulting pressure values are then affected by any Press Map settings made on the Master Mode MAPS page (see page 11-7.) Also, MIDI pressure messages sent to the USB or MIDI out port are first affected as explained above, and then affected by settings on the MIDI mode Transmit page (see page 10-1.) On each of the pages mentioned above, look at the MIDI signal flow chart to see which pressure maps can affect your velocities depending on which MIDI Sources, MIDI Destinations and operating mode that you are using.

```

SetupMode:PRESSURE #zone:1/1

          Dest      Scale Add  Curv   Ent  Exit
PressPressure 100%  0   Linear None None

more PRESS FT SW1 FT SW2 FT SW3 more
  
```

Parameter	Range of Values	Default
Destination	Control Destination List	MPress
Scale	± 300%	100%
Add	-128 to +127	0
Curve	Linear, Compress, Expand	Linear
Entry Value	None, 0 to 127	None
Exit Value	None, 0 to 127	None

Setup Mode

The Footswitch Pages (FT SW1, FT SW2, FT SW3)

The Footswitch Pages (FT SW1, FT SW2, FT SW3)

On the back of the instrument, there are three jacks for Footswitch pedals.

There are three Footswitch pages, one for each Footswitch. The range of values for their respective Destination parameters is the Control Destination list.

The FT SW page parameters are described in *Switch Controller Parameters* on page 7-30.

```
SetupMode: FOOT SWITCH 1 #zone:1/1
Type:      : Momentary      EntryState : None
OnControl  : Sustain       ExitState  : None
OnValue    : 127
OffControl : Sustain
OffValue   : 0

more PRESS FT SW1 FT SW2 FT SW3 more
```

Parameter	Range of Values	Default
Type	Momentary, Toggle	Momentary
On Control	Control Destination List	Ft Sw1: Sustain Ft Sw2: Sostenut Ft Sw3: Soft
On Value	None, 0 to 127	127
Off Control	Control Destination List	Ft Sw1: Sustain Ft Sw2: Sostenut Ft Sw3: Soft
Off Value	None, 0 to 127	0
Entry State	None, Off, On	None
Exit State	None, Off, On	None

The Arpeggiator Switch (ARP SW) Page

The PC3K keyboard offers two Panel switches, located above the pitch and mod wheels. The left switch is the **Arp** (short for “arpeggiator”) button. By default, the Arp switch functions as the arpeggiator switch, and toggles on and off the PC3K arpeggiator, but you can assign this switch to any Controller.

See *The ARPEGGIATOR Page* on page 7-42 for information on how to configure the PC3K’s arpeggiator.

The ARP SW page parameters are described in *Switch Controller Parameters* on page 7-30.

```

SetupMode>SWITCH ARP #zone:1/1
Type:           : Toggled      EntryState : None
OnControl      : ArpOn        ExitState  : Off
OnValue        : 127
OffControl     : ArpOff
OffValue       : 0

more ARP SW SWITCH RIBBON RIBCFG more

```

Parameter	Range of Values	Default
Type	Momentary, Toggled	Toggled
On Control	Control Destination List	ArpOn
On Value	None, 0 to 127	127
Off Control	Control Destination List	ArpOff
Off Value	None, 0 to 127	0
Entry Value	None, Off, On	None
Exit Value	None, Off, On	None

The SWITCH Page

The right Panel switch is the SW button, located above the Modwheel. By default, this switch is assigned to MIDI29, but you can assign this switch to any MIDI Controller.

The SWITCH page parameters are described in *Switch Controller Parameters* on page 7-30.

```

SetupModePSWITCH SW #zone1/1
Type:      : Toggled      EntryState : None
OnControl  : MIDI29      ExitState  : None
OnValue    : 127
OffControl : MIDI29
OffValue   : 0

more ARP SW SWITCH RIBBON RIBCFG more
    
```

Parameter	Range of Values	Default
Type	Momentary, Toggled	Toggled
On Control	Control Destination List	MIDI29
On Value	None, 0 to 127	127
Off Control	Control Destination List	MIDI29
Off Value	None, 0 to 127	0
Entry Value	None, Off, On	None
Exit Value	None, Off, On	None

The RIBBON Page

```

SetupMode:RIBBON #Zone:1/1
      Dest      Scale Add  Curv  Ent  Exit
Sect1 MIDI21 100% 0   Linear  None None
Sect2 OFF      100% 0   Linear  None None
Sect3 OFF      100% 0   Linear  None None
  
```

more **ARP SW** **SWITCH** **RIBBON** **RIBCFG** **more**

Parameter	Range of Values	Default
Destination	Control Destination List	MIDI21
Scale	± 300%	100%
Add	-128 to +127	0
Curve	Linear, Compress, Expand	Linear
Entry Value	None, 0 to 127	None
Exit Value	None, 0 to 127	None

The RIBBON page lets you define the controller assignment for the PC3K's optional ribbon controller. The Ribbon controller senses movement when you press on it and move your finger left or right; this creates numerous possibilities for controlling pitch, volume, panning, crossfades between zones, or any other uses you might imagine.

In Program mode the ribbon controls an octave of pitch bend by default. This is because when using the default Control Setup **126 Internal Voices**, the ribbon is set to the destination MIDI21, which controls Aux Bend 1 (see *Aux Bend 1 Up and Aux Bend 1 Down* on page 7-19 for details.) See page 6-9 for more about the *Control Setup*.

The optional Ribbon controller can be used as a single long controller, or it can be divided into three separate sections, each with its own controller assignments (this is done on the RIBCFG page, see below). The two small arrows above the strip indicate the boundaries of the three sections. The large arrow above the ribbon points to the center of the ribbon, for when the ribbon is configured in one section.

Note that there are three assignable parameter groups on the RIBBON page. When the Ribbon is set to act as a single section controller, the only parameters that affect its behavior are those of Section 1 (Sect1). When the Ribbon is set to act as a three-section controller, each parameter group affects only its respective Ribbon section.

To modify other ribbon parameters, go to the *The Ribbon Configuration (RIBCFG) Page* (see *The Ribbon Configuration (RIBCFG) Page* below for details.)

The RIBBON page parameters are described in *Continuous Controller Parameters* on page 7-29.



Note: When used as a one section controller, the ribbon sends two MIDI CC numbers (MSB and LSB in the MIDI spec,) giving the ribbon a resolution of 768 steps, instead of the 128 steps that one MIDI CC provides. This allows the ribbon to have finer control of a parameter compared to other continuous controllers. To take advantage of this, assign the destination for Sect1 to a CC number between 0 and 31, and the ribbon will additionally send to a destination 32 higher than the set destination. For example, MIDI22 would also send to the destination MIDI54. In this case, if you set a Program parameter source

field to MIDI22, the parameter will automatically also use MIDI54 as a source, enabling the 768 step resolution when using the one section ribbon. The additional source that is automatically used will not be seen in the Program Editor (this happens behind the scenes,) but both CC numbers will be sent to the MIDI Out and USB port. (Also note, MIDI32 through MIDI63 are not available in the Program parameter source fields, as they are reserved for using CC numbers 0-31 as described above.) When the ribbon is used as a one section controller, if a MIDI CC above 63 is used as the destination for Sect1, only one CC number will be sent and the ribbon will have a resolution of 128 steps. When the ribbon is used as a three section controller, each section will only send one CC number and each section will have a resolution of 128 steps.

The Ribbon Configuration (RIBCFG) Page

Once you've selected a destination for the optional Ribbon controller, you can use the parameters on the RIBCFG page to define how the ribbons respond to finger position and pressure.

```

SetupModeRIBBON CONFIGURATION
Ribbon Configuration: One section
Ribbon:      PosMode   Spring   Center
              Relative  On      64

more ARP SW SWITCH RIBBON RIBCFG more
    
```

Parameter	Range of Values	Default
Ribbon Configuration	One Section, Three Sections	One Section
Position Mode	Relative, Absolute	Relative
Spring	On, Off	On
Center	0 to 127	64

Ribbon Configuration

You can use the Ribbon as one controller, or divide it up into three smaller sections, each with its own controller assignments. Choose a value of **One Section** or **Three Sections** for the Ribbon Configuration parameter. With **Three Sections** chosen, the page changes such that you can adjust the parameters of each section:

```

SetupModeRIBBON CONFIGURATION
Ribbon Configuration: Three sections
Section1:    PosMode   Spring   Center
              Relative  On      64
Section2:    Relative  On      64
Section3:    Relative  On      64

more ARP SW SWITCH RIBBON RIBCFG more
    
```

Position Mode (PosMode)

When you touch the Ribbon, the PC3K responds in one of two ways, depending on the setting of the PosMode parameter. **Relative** means that wherever you touch the Ribbon becomes the “zero point” for whatever the Ribbon is controlling; you won’t notice any change in the sound until you slide your finger. Relative mode tends to be the most natural for performance—just wiggle your finger anywhere on the Ribbon to get vibrato in many factory programs and setups. You get the same effect no matter where you do the wiggling.

Absolute means that the zero point for the Ribbon is always at exactly the same physical location on the ribbon. By default this is the center of the Ribbon, although you can use the Center parameter to put the zero point elsewhere. In Absolute mode, just touching the Ribbon affects the sound (unless you touch it at exactly the zero point). Every movement you make along the Ribbon sends control values based on how far you are from the zero point.

Spring

When Spring is **On**, the Controller to which you’ve assigned the Ribbon “springs” back to its zero point automatically when you lift your finger off the ribbon. This is generally the behavior you want.

When Spring is **Off**, the Controller to which you’ve assigned the Ribbon sticks at its current value when you lift your finger off the Ribbon. While this can be useful, you should be careful with it. When Spring is **Off**, if the Ribbon is doing something when you exit the setup, it’ll continue doing that when you return to the setup. This can be good or bad. If you want to set Spring to **Off** in a setup, but want to be sure of the initial sound of the setup, go to the RIBBON page in the setup, and for each Ribbon for which you’ve set Spring to **Off**, set the entry value (Ent) parameter to a value of **0** (or whatever you like).

Center

This defines the zero point for the Ribbon (or for each section on the Ribbon)—the point at which the Controller to which the Ribbon is assigned has no effect on the sound. You can choose any point between **0** and **127**. A value of **64** puts the zero point in the physical center of the Ribbon. Values of **0** and **127** place the zero point at the section’s extreme left and extreme right. Note that setting the Spring parameter to **Off** disables the Center parameter for that ribbon.

The value you choose for this parameter can have considerable effect. In many factory setups, for example, the Ribbon affects pitch. In these setups, changing the value of the Center parameter would transpose the setup.

The ARPEGGIATOR & ARPEGGIATOR 2 (ARP1, ARP2) Pages

Each zone in a setup has its own Arpeggiator. When activated, each Arpeggiator takes MIDI note input from the PC3K keyboard (or via MIDI) and outputs a rhythmic pattern of MIDI notes. You can control the speed and nature of the pattern in real time. Each Arpeggiator can affect both the PC3K and external MIDI instruments. The notes produced by the Arpeggiator in a given zone go to all of that zone's destinations: local, MIDI, or both. You can also set one zone's arpeggiator to override arpeggiators on other zones using the *Arpeggiator Global (ArpGlobal)* parameter on Setup Mode's COMMON page.

The concept behind the PC3K's Arpeggiators is fairly simple, although the options are extensive. You might think of each Arpeggiator as a "note processor," generating complex output from relatively modest input. You can select any number of notes for the input, and tell the Arpeggiator to recognize and remember them. This is called "latching" the notes. The Arpeggiator then processes them by playing them repeatedly, and/or transposing them up and down the keyboard. You have control over several processing parameters: velocity, order, duration, transposition, orchestration, whether the notes are played simultaneously, and whether the intervals between notes are filled chromatically. You can also tell the Arpeggiator how to deal with new information coming from the keyboard when the Arpeggiator is already processing notes.

The arpeggiator also includes step sequencers for note and velocity shifting, allowing you to more precisely control how your MIDI note input is processed. Set the arpeggiator parameters on the ARPEGGIATOR and ARPEGGIATOR2 pages:

The ARPEGGIATOR Page



Note: In Program Mode, simultaneously press the Arp and SW buttons (above the Wheels) to view the Arpeggiator page for the Contol Setup, which controls arpeggiator settings in Program Mode (see Control Setup on page 6-9 for details.)

```

SetupMode:ARPEGGIATOR #zone:1/1
Active      : Off      Beats      : 1/16
ShiftPattern: 0 None
ShiftLimit  : 24      LimitOpt   : UniPolar
ShiftAmount: 0ST     PlayOrder : Played
Vel: Played  Duration  : 100%

more ARP1 ARP2 RIFF1 RIFF2 more
    
```

Parameter	Range of Values	Default
Active	On/Off	Off
Beats	1/1 (Whole Notes) to 1/384 (96 notes per beat)	1/16 (16th Notes)
Play Order	Played, Upwards, Downwards, UpDown, UpDown Repeat, Random, Shuffle, Walking, Simultaneous	Played
Duration	1% to 100%	100%

Parameter	Range of Values	Default
Velocity	First, Played, Last, Aftertouch, MIDI 109, Fixed, Pattern (1-74 factory patterns, user created patterns,) Human1-4, Chimp1-4, MissNotes1-9	Played
ShiftAmount	± 88 Semitones	0
ShiftLimit	0-60	24
Limit Option	Stop, Reset, Unipolar, Bipolar, Float Res, Float Uni, Float Bip	Unipolar
ShftPattrn (Shift Pattern)	Off, (1-69 factory patterns, user created patterns)	Off

Active

The first parameter on the Arpeggiator menu is **Active**, which specifies whether or not the Arpeggiator is on for the current zone. This parameter can be switched from the ARPEGGIATOR page, or for real-time control, it can be switched on using Controller number 147 (**ArpOn**) and switched off using Controller number 148 (**ArpOff**); these Controllers can, of course, be assigned as the destination of a PC3K physical controller.

Turning **Active** on affects zones whose **ZoneArpeg** values are also set to **On**. By setting the **ZoneArpeg** parameter (on the CH/PRG page) to **Off** or **On** in the individual zones of a setup, you can choose which zones will be controlled by the Arpeggiator when it is on.

Beats

The **Beats** parameter sets the number of notes per beat. The tempo is based on quarter notes. Therefore, if you set it to **1/4**, you will get one note per beat of the clock. At **1/16**, you will get 4 notes per beat, and so forth. You can go all the way to 96 notes per beat (**1/384**), but at most tempos, divisions smaller than 1/64 will sound pretty much the same. To find a **Beats** value, multiply the notes you want per beat by 4. For example, 4 notes per beat (16th notes) would be $4*4=16$, a **Beats** value of 1/16. Three notes per beat (8th note triplets) would be $3*4=12$, a **Beats** value of 1/12. Six notes per beat (16th note triplets) would be $6*4=24$, a **Beats** value of 1/24. Note that when recording arpeggiations to a PC3K MIDI track, you must turn on real-time quantization and set it to the same **Grid** value in order for the selected **Beats** value to sync properly with the tempo grid (see *Quant* and *Grid* on page 12-17.)

Play Order

This parameter determines the order in which the PC3K plays arpeggiated notes. **Played** causes them to play back in the chronological order in which you played and latched them. **Upwards** means that notes play in ascending pitch order, regardless of their chronological order. **Downwards** means descending pitch order. **UpDown** causes notes to play from lowest pitch to highest, then from highest pitch to lowest, repeating the cycle until you stop the arpeggiation. The notes at the very top and very bottom only play once. **UpDown Repeat** is similar to **UpDown**, except that the notes at the top and bottom play *twice* (repeat) when the Arpeggiator reverses direction.

Random plays the currently latched notes in completely random order. **Shuffle** plays them at random, but keeps track of the notes so that no note repeats until all of the others have played. **Walk** is a “random walk” order: each successive note is either the next or previous note (in chronological order). For example, suppose you’ve latched four notes—G 4, B 4, D 5, and F 5—in that order. The first note the Arpeggiator plays is the G 4. The second note will be either B 4 (the next note chronologically), or F 5 (the “previous” note chronologically—that is, the last latched note). If the second note is B 4, the third note will be either D 5 or G 4. If the second note is F 5, the third note will be either G 4 or D 5.

Simultaneous makes the Arpeggiator latch each note you play and repeat it in time with the Tempo value, sort of like a digital delay with no decay. If you play a C and hold it while you play an E and a G, the Arpeggiator will play all three notes at the same time and at the same tempo. Simultaneous also works well with Shift and Limit, allowing you to shift multiple notes simultaneously.

Duration

Duration determines how long each arpeggiated note plays. 100% means that a note sustains until the next one sounds—very legato. 50% means that the note fills half the space between itself and the next note. The lowest value is 1%—*staccatissimo*. This parameter has no effect on percussion sounds or other sounds whose duration is fixed.

Velocity

Velocity sets the attack velocity of the played notes. With Velocity set to **First**, all notes play at the velocity of the first played note. With Velocity set to **Played**, each note repeats with the same velocity you played it at. With Velocity set to **Last**, all notes play at the velocity of the most recently played note. With Velocity set to **Aftertouch**, the velocities are controlled by keyboard pressure: as you hold and push down on any key, the velocities get higher, and as you ease up they get lower.

With Velocity set to **MIDI 109**, MIDI controller 109 continually sets the arpeggiator velocity. This works well when MIDI controller 109 is set to a knob or expression pedal.

With Velocity set to **Fixed**, all notes play with the same velocity. The default **Fixed** velocity is 100. Like **MIDI 109**, You can control this velocity amount in real-time by assigning a controller to **VelFixed**, controller destination number is 175. Input from any physical controller assigned to send VelFixed (or any entry value for a controller assigned to send VelFixed) overrides the programmed value of the Velocity parameter, disabling it until you select a different setup (or in Program mode, until you select a different control setup on the MIDI-mode TRANSMIT page).

Pattern engages a step sequencer for arpeggiator velocity patterns, which shifts the velocity of each arpeggiated note according to a sequenced pattern. There are 74 pre programmed velocity patterns that you can choose from the **VelPatt** field, some of which create rhythms by using velocity values of -127 or “none” to leave rests in the arpeggiation. The sequencer uses the velocity received from the first note played as the center position to shift velocities up or down from. If no other keys are playing, patterns will start over each time a key is pressed (*there are some exceptions to this when using ARPEGGIATOR Latch parameters other than “Keys,” though a newly triggered pattern will always start at step 1.*) When triggering velocity patterns from more than one key at a time, each consecutive step of the pattern shifts the velocity from a different inputted key, the order of which is decided by the **order** parameter on the ARPEGGIATOR page.



Note: For patterns with negative velocity values, if the velocity of the first played note is low enough that a pattern step could result in a velocity of zero, some notes may have a velocity of zero and therefore produce no sound.

You can edit the included patterns by pressing “Edit” with a pattern highlighted in the **VelPatt** field (*see edit screen below.*) The top line of the “EditVelocityPatt” page displays the pattern’s name and total number of steps. This page also shows the full name for a pattern whose name does not fit on the ARPEGGIATOR page. Each pattern can have up to 48 steps, and each step can shift velocities by ± 127 steps. You can insert a step with a value of “none” by entering -127 and then shifting down one more step. A step with the value “none” causes the arpeggiator to play nothing for that step, allowing you to create rhythmic patterns by using “none” to leave spaces. Pressing **Step-** removes the last step in the list, pressing **Step+** inserts a new velocity step at the end of the list (the pattern editor remembers the values of removed steps until you save or exit.) Use the cursor to move between pattern steps, use the alpha wheel, alphanumeric pad, or plus/minus buttons to enter the velocity shift amount for each step. Press **More** to see a second page for patterns with more than 24 steps.

Press **Delete** to delete the pattern from memory. Press **Rename** to rename the pattern and save. Pressing **Save** gives you the option to save the pattern or rename and save. To create a new VelPatt, edit an existing pattern and choose Rename when saving. Press Exit to return to the ARPEGGIATOR page. When exiting the editor, it will automatically give you the option to save the pattern if changes have been made. For more detailed instructions on these functions, see *Saving and Naming* on page 5-3.

Edit Velocity Pattern Pseudosine Steps:24			
Stp1 : 0	Stp7 : -32	Stp13: -1	Stp19: 33
Stp2 : 16	Stp8 : -16	Stp14: -15	Stp20: 18
Stp3 : 32	Stp9 : 1	Stp15: -33	Stp21: 0
Stp4 : 16	Stp10: 18	Stp16: -19	Stp22: -16
Stp5 : 0	Stp11: 34	Stp17: -2	Stp23: -28
Stp6 : -16	Stp12: 14	Stp18: 16	Stp24: -12
Step-	Step+	Delete	Rename
		Save	More

The **Human1** through **Human4** settings randomly change played note velocity within a range in order to make arpeggiation sound more human like, with each note varying slightly in velocity. The Human settings use the velocity received from the first note played as the center of the randomization range. Each note of the arpeggiator will randomly choose a velocity within the given range. (See the table below for velocity ranges.)

The **Chimp1** through **Chimp4** settings function in a similar fashion to the Human settings (see above.) Like the Human settings, the Chimp settings randomly change played note velocity within a range, but the Chimp settings have larger randomization ranges. The Chimp settings use the velocity received from the first note played as the center of the randomization range. Each note of the arpeggiator will randomly choose a velocity within the given range. (See the table below for velocity ranges.)



Note: For Human and Chimp modes, if the velocity of the first played note is low enough that the selected randomization range could result in a velocity of zero, some notes may have a velocity of zero and therefore produce no sound.

Velocity Setting	Velocity Randomization Range
Human1	± 3
Human2	± 6
Human3	± 10
Human4	± 15
Chimp1	± 25
Chimp2	± 35
Chimp3	± 50
Chimp4	± 64

MissNotes1 through **MissNotes9** makes the PC3K randomly miss playing a percentage of inputted notes. See the table below for percentages and their equivalent settings. Each of these settings also randomly changes some of the inputted velocities in a range of ± 5, with the purpose of simulating a more human played sound.



Note: Missed Notes are actually output as notes with a velocity of zero.

Velocity Setting	Approximate % of Notes Missed
MissNotes1	% 10
MissNotes2	% 20
MissNotes3	% 30
MissNotes4	% 40
MissNotes5	% 50
MissNotes6	% 60
MissNotes7	% 70
MissNotes8	% 80
MissNotes9	% 90

Shift Amount

You can tell the Arpeggiator to transpose all of the currently latched notes each time it plays through them. Shift Amount determines how much transposition will occur for each cycle of notes. For example, if you have latched C4 and F4, and you assign a Shift Amount of 2, the Arpeggiator will play C4, F4, D4, G4, E4, A4, and so on until it reaches the Limit value. The Shift Amount values can range from -88 to 88, with 0 (the default) being no transposition.

Shift Limit

Limit determines how far up or down the Arpeggiator shifts from the original note. The minimum value is 0, and the maximum is 60. When the Arpeggiator reaches the limit, the Arpeggiator responds according to the setting for the Limit Option parameter.

Limit Option

This parameter determines what the Arpeggiator does when it has shifted the currently latched notes up (or down) to the shift limit. **Stop** causes the Arpeggiator to stop when it reaches the shift limit. **Reset** causes the Arpeggiator to return to its original pitch and repeat the latched cycle of notes, transposing each cycle according to the settings for Shift Amount and Shift Limit. If the limit allows the notes to go out of MIDI range (for example, if you set Shift to 12, set the limit to 60, and play C6), then those “ghost” notes don’t sound, but they take up rhythmic space: the Arpeggiator waits for the cycle to play itself out before starting over.

Unipolar means that after playing up to the shift limit, the Arpeggiator begins shifting notes in the opposite direction, until it reaches the original pitch, where it reverses again. To determine the next note when it reaches the shift limit, the Arpeggiator calculates the interval between the shift limit and what the next note would be if the shift limit weren’t there. It then plays the note that is the calculated interval lower than the last note before the shift limit. The same thing happens in reverse when the arpeggiated notes get back down to the original pitch. The following table makes this easier to visualize by showing the result of arpeggiating one note (C4) in Unipolar mode, with Shift Amount set to 3 ST and various values for Shift Limit.

Shift Limit	Resulting Arpeggiation (When LimitOption is Unipolar)			Comment
	Up	Down	Up	
6 ST (F#4)	C4, D#4, F#4,	D#4, C4	D#4, ...	Same notes play in both directions when Shift Limit is a multiple of Shift Amount

Shift Limit	Resulting Arpeggiation (When LimitOption is Unipolar)			Comment
	Up	Down	Up	
7 ST (G4)	C4, D [#] 4, F [#] 4,	E4, C [#] 4,	D [#] 4, ...	Last upward note before shift limit is F [#] 4, next upward note would be A4, which is 2 ST from shift limit (G4); therefore first downward note is E4 (2 ST below last upward note)
8 ST (G [#] 4)	C4, D [#] 4, F [#] 4,	F4, D4,	D [#] 4, ...	A4 is 1 ST from shift limit, therefore first downward note is F4 (1 ST lower than last upward note)
9 ST (A4)	C4, D [#] 4, F [#] 4, A4	F [#] 4, D [#] 4, C4,	D [#] 4, ...	All symmetrical again; now A4 is within shift limit
10 ST (A [#] 4)	C4, D [#] 4, F [#] 4, A4,	G4, E4, C [#] 4,	D [#] 4, ...	Next upward note would be C5, which is 2 ST from shift limit
11 ST (B4)	C4, D [#] 4, F [#] 4, A4,	G [#] 4, F4, D4,	D [#] 4, ...	C5 is 1 ST from shift limit
12 ST (C5)	C4, D [#] 4, F [#] 4, A4, C5,	A4, F [#] 4, D [#] 4, C4,	D [#] 4, ...	Symmetrical again, including C5

Bipolar starts out the same way as **Unipolar**, but during downward note shifting, it continues past the original pitch until it hits the shift limit in the *opposite* direction, where it reverses again.

Float Res adds a bit of apparent randomness to the process. “Float” means that when the Arpeggiator reaches the shift limit, it resets—but not to its original pitch as with plain Reset. Like Unipolar and Bipolar, it looks at the first note that would exceed the shift limit, and calculates the interval between that note and the shift limit. It then restarts the cycle of latched notes, transposing the entire cycle by the interval it just calculated, then shifting each subsequent cycle by the value of Shift Amount, until it reaches the shift limit again.

Here’s a very simple example. Suppose that the only note in the Arpeggiator cycle is C4, Shift Amount is 4 (a third), and Shift Limit is 7 (so notes won’t get shifted above G4). The Arpeggiator plays C4, then E4. The next note should be G[#]4, but that’s above the shift limit—so the PC3K calculates the difference between that G[#]4 and the shift limit (G4): one semitone. It adds that difference to the original starting note (C4) and plays that note next—C[#]4. The next note (F4) is within the shift limit, but the next note (A4) isn’t, so it gets translated into D4—and so on.

Float Uni uses the same concept and applies it to Unipolar mode: when the Arpeggiator reaches the shift limit, it calculates the difference between the next note and the limit, and transposes the next cycle of notes down by that interval, then shifts each subsequent cycle down until it reaches the original pitch. **Float Bip** is similar to **Float Uni**, but the downward shift limit isn’t the original pitch, it’s the negative of the Shift Limit value.

The Arpeggiator can be a lot of fun, even if you don’t always understand exactly what it’s doing. Keep in mind that the stranger the algorithm you set up, the more unlikely the notes will stay close to one key, so if you want to create something that’s going to sound at all diatonic, keep it simple.

Shift Pattern (ShiftPatt)

ShiftPatt engages a step sequencer for arpeggiator note patterns. The inputted note number of each played key is shifted according to a sequenced pattern, thus “Shift Pattern.” The PC3K has pre-programmed shift patterns including many useful chords, intervals, and rhythms. You can also create your own custom shift patterns (see below for details.) Each pattern can have up to 48

steps, and each step can shift notes by ± 127 half-steps or play nothing. Steps are played back at the rate set for **Beats** on the ARPEGGIATOR page. Keep in mind that Shift Patterns are effected by every parameter on the ARPEGGIATOR page, which can be the cause of unexpected variation, or a way to add interesting variation to a pattern.

Shift Patterns are most easily used and understood when triggered by only one key at a time. One way to prevent triggering from multiple keys is to use one of the Latch types 1NoteAuto, 1NoteAutoLow, or 1NoteAutoHi when using a shift pattern (see *Latch* on page 7-49, below.) Triggering shift patterns from one key allows the pre programmed patterns to sound like what you would expect from their names. If no other keys are playing, patterns will start over each time a key is pressed (*there are some exceptions to this when using ARPEGGIATOR Latch parameters other than "Keys," though a newly triggered pattern will always start at step 1.*) When triggering Shift Patterns from more than one key at a time, each consecutive step of the pattern shifts the note from a different inputted key, the order of which is decided by the **order** parameter on the ARPEGGIATOR page. This means that each key will not be shifted by every step of the pattern, causing you to only hear part of the pattern from each key, often making the pattern unrecognizable. Though triggering a Shift pattern from multiple keys can be used creatively, it can also make it hard to predict what the output will be.

You can edit the included patterns by pressing "Edit" with a pattern highlighted in the **ShiftPatt** field (see *edit screen below.*) The top line of the "EditShiftPatt" page shows the full name for a pattern whose name does not fit on the ARPEGGIATOR page. This page also displays the pattern's total number of steps, as well as pattern direction. Pressing **Step-** removes the last step in the list, pressing **Step+** inserts a new note step at the end of the list (the pattern editor remembers the values of removed steps until you save or exit.) Use the cursor to move between pattern steps, use the alpha wheel, alphanumeric pad, or plus/minus buttons to enter the note shift amount for each step. Press **More** to see a second page for patterns with more than 24 steps. You can insert a step with a value of "none" by entering -127 and then shifting down one more step. A step with the value "none" causes the arpeggiator to play nothing for that step, allowing you to create rhythmic patterns by using "none" to leave spaces. When the arpeggiator determines the range of pattern notes played with the **Limit** parameter (see below,) steps with a value of "none" will be calculated as a step value of 0.

Use the **chan up/down** buttons to change the direction in which pattern steps are played (indicated by **Up**, **Down**, or **Flat** on the right of the top line.) With pattern direction set to **Up**, the pattern plays as expected, starting at step one and moving up through each step towards step 48. With pattern direction set to **Down**, the pattern starts at step one, but then moves to the last step and continues to move backwards through the steps down towards step 1. Additionally, patterns set to **Down** base all notes after step one in the octave below the first note played. These settings are most useful for arpeggiating chord patterns upwards or downwards from the root note. Patterns set to **Flat** will not repeat in other octaves like those set to **Up** or **Down** (depending on the **Limit** parameter.) Patterns set to **Flat** play without transposition, the **Limit** parameter will not transpose the pattern but it can still restrict note range.

```

EditShiftPatt1 |major          Steps:3  #UP
StP1  : 0
StP2  : 4
StP3  : 7

Step-  Step+  Delete  Rename  Save  More

```

Press **Delete** to delete the pattern from memory. Press **Rename** to rename the pattern and save. Pressing **Save** gives you the option to save the pattern or rename and save. To create a new ShiftPatt, edit an existing pattern and choose Rename when saving. Press Exit to return to the ARPEGGIATOR page. When exiting the editor, it will automatically give you the option to save the pattern if changes have been made. For more detailed instructions on these functions, see *Saving and Naming* on page 5-3.

The ARPEGGIATOR 2 Page

```
SetupModeARPEGGIATOR 2 #Zone:1/2
```

```
Latch : Keys          SyncTo   : First Avail.
LoKey : C -1         SyncType : None
HiKey : G 9          Num Beats: 4
Gliss : Off
```

```
more ARP1 ARP2 RIFF1 RIFF2 more
```

Parameter	Range of Values	Default
Latch	Keys, Overplay, Arpeg, Add, Auto, Pedals, Autohold, 1NoteAuto	Keys
Low Key	C -1 to G9	C -1
High Key	C -1 to G9	G9
Glissando	Off, On	Off
SyncTo	First Avail., Riff1-16, Main Seq., Arp1-16, FirstRiff.Av., FirstArp.Av.,	First Avail.
SyncType	None, DownBeat, AnyBeat, DownBeatWait, AnyBeatWait	None
Num Beats	1-32	4

Latch

Latch determines how the Arpeggiator responds to notes when they are triggered.

Keys means that the Arpeggiator plays only while you are holding one or more keys down (or note triggers on). As you play different notes, they get added to the Arpeggiator, and as you release notes, they get taken out. If you play notes faster than the Arpeggiator's current tempo, each subsequent note will be added to the arpeggiation at the next division of a beat. This can cause a lag between the time you play the note and the time you hear it in the arpeggiation.

In the next three modes, the Arpeggiator latches notes only when MIDI Controller 157 (Latch) sends a value of On (64 or higher). An easy way to experiment with these modes is to assign the Mod Wheel to send MIDI 157.

In **Overplay** mode, the Arpeggiator latches any notes that are being held when Latch turns on, and continues playing them, even after you let them go, until Latch turns off. Any notes that you play after Latch is already on do not get arpeggiated, even if they're in the arpeggiation range.

Arpeg is similar: any notes held when Latch goes on are latched and arpeggiated, and keep going until Latch goes off. Any notes you play outside the arpeggiation range play normally. Notes that you play inside the arpeggiation range do not play normally; rather, if you hold them on, they become part of the arpeggiation. They drop out of the arpeggiation as soon as you release them.

Like Overplay and Arpeggiation, **Add** means that all notes being held when Latch goes on get latched, and keep playing until Latch goes off (even if you've released the notes). Any notes you play after Latch is already on also get latched.

Auto is independent of Latch; every note you play is automatically latched, and the Arpeggiator runs as long as you hold at least one arpeggiated note. As long as you keep holding on at least one note (it doesn't have to be the same note the whole time), every note you play in the arpeggiation range gets latched.

Pedals is sort of a combination of Keys, Add, and Overplay modes. It relies on both Latch (MIDI 157) and Latch2 (MIDI 158). If neither latch controller is on, notes will arpeggiate only while you are holding down keys (similar to Keys mode). If you activate Controller 158, the keys currently held down will latch, and any additional keys played while Controller 158 is on will also latch (similar to Add mode). When Controller 158 is off, any keys that are not currently held down will be removed from the arpeggiation. If you activate Controller 157, keys currently held down will latch, and any additional keys played while Controller 157 is on will play normally (similar to Overplay mode). This mode is called Pedals mode because you might want to assign Footswitch 1 to **Latch** (Controller 157) and Footswitch 2 to **Latch2** (Controller 158) to make the pedals function similarly to sustain and sostenuto pedals. Additionally, you could assign one Footswitch to **SusLatch** (Controller 160)—doing this makes the Footswitch act as a sustain pedal when Arpeggiator is off, and as a Latch pedal when Arpeggiator is on.

Autohold is similar to Auto. Holding at least one arpeggiated note on and playing other notes latches those notes. Unlike in Auto mode, if you stop holding at least one arpeggiated note on, the arpeggiation continues playing (although you can't latch any more notes). In this case, if you strike another key within the setup's arpeggiation range, you start a new arpeggiation sequence. **Autohold** is useful for arpeggiating chords: when you play a chord, it gets latched, and continues arpeggiating after you release the chord. When you play another chord, the previous chord gets unlatched, and the new one gets latched. You can use the **Panic** soft button to stop arpeggiation at any time.

1NoteAuto is similar to Autohold, except only the last note played is latched (even if previously played notes are still being held.) **1NoteAuto** is specifically designed for use with Shift Patterns (see above,) because Shift Patterns are designed to be played from one note at a time (though you can use **1NoteAuto** without a Shift Pattern as well.) Using **1NoteAuto** for zones that use a Shift Pattern ensures that Shift Patterns will sound correct by only allowing one note at a time to trigger the pattern. You can use the **Panic** soft button to stop arpeggiation at any time.

1NoteAutoLow and **1NoteAutoHi** are also designed for use with Shift Patterns. They work similarly to **1NoteAuto**, except **1NoteAutoLow** always latches the lowest note when holding multiple notes, and **1NoteAutoHi** always latches the highest note when holding multiple notes. You can also use these latch types without a Shift Pattern if desired.

Low Key (LoKey) and High Key (HiKey)

The Arpeggiator processes notes within the range of these parameters. Notes outside the specified range play normally, and do not become part of the arpeggiation sequence. Set the LoKey and HiKey parameters using the data entry wheel or buttons.

Glissando

When the Glissando parameter is **On**, the Arpeggiator chromatically fills between latched notes. When Glissando is on, the Arpeggiator ignores the Shift Amount, Shift Limit, and Limit Option parameters.

You must latch at least two notes to get a result. When Glissando is on, all notes played in the arpeggiation range get latched, although you won't necessarily get meaningful results from all latched notes. In general, try to get each subsequent note you latch to be a change in direction. For example, try latching the following sequence of notes: C4, C5, G4, G5, C5, C6, G4, G5. The "glissando" changes direction around each change in direction of the latched notes.

SyncTo

The SyncTo parameter determines what an arpeggiator will sync to. An arpeggiator can sync to another arpeggiator, a riff, or a song playing from Song mode. You can choose a specific arpeggiator or riff to sync to by setting SyncTo to **Arp 1-16** or **Riff 1-16**, and the current arpeggiator will always sync to that arpeggiator or riff. For example, if you have an arpeggiator on a bass sound in zone 1 and an arpeggiator on a lead sound in zone 2, you may always want the lead arpeggiation in zone 2 to sync to the bass arpeggiation in zone 1. In this case you would set the SyncTo parameter in zone 2 to **Arp 1**.

You may want to have a little more freedom and not be tied to the bass arpeggiation in zone 1 as the main "timekeeper." Maybe you want to start with the lead arpeggiation in zone 2 and have the bass arpeggiation in zone 1 start later. In this case you would set the SyncTo parameter for zone 2 to **FirstArp.Av.** With this setting, the arpeggiator will look for the first available arpeggiator to sync to. So if both the bass arpeggiation and the lead arpeggiation have this parameter set to **FirstArp.Av.**, the arpeggiation that is started first will be the main "timekeeper." If the lead arpeggiator starts first, the bass arpeggiator will see that as the first available arpeggiator to sync to and will do so. If the bass arpeggiator is started first, the lead arpeggiator will see that as the first available arpeggiator to sync to and will do so. This can be very handy if you are using multiple arpeggiators and want to do some live improvisation; you can start and stop different arpeggiators and as long as there is one arpeggiator playing, any arpeggiator with SyncTo set to **FirstArp.Av.** will sync back up when triggered again.

You can also choose **FirstRiff.Av.**, which behaves the same way as **FirstArp.Av.**, but makes your arpeggiator look for the first available riff to sync to. A setting of **Main Seq.** will sync the arpeggiator to the song currently loaded in Song mode. You can select a song in Song mode, then play it from setup mode with the front panel **Play/Pause** button. (*Doing this temporarily replaces the programs in your setup's zones with the program used for each channel in the song, so it's best to make a setup that uses the same programs as your song on the same MIDI channels. If you plan on syncing riffs with a song, it may be easier to start by creating a setup, then recording the setup into a song. See Recording A Setup To Song Mode on page 7-69 for details.*) A setting of **First Avail.** will sync the arpeggiator to the first available arpeggiator, riff, or song from Song mode.



*Note: If you have multiple arpeggiators or riffs already playing when using **FirstArp.Av.**, **FirstRiff.Av.**, or **First Avail.** for the current arpeggiator, the current arpeggiator will sync to the arpeggiator or riff of the lowest numbered zone that has an arpeggiator or riff playing.*

SyncType

The SyncType parameter allows you to choose how your arpeggiator will sync to other arpeggiators, riffs, or a song playing from Song mode.

With SyncType set to **None**, your arpeggiator will start playing as soon as it is triggered. It will not sync to anything. With SyncType set to **DownBeat**, if there is already something playing to sync to, the current arpeggiator will wait for the downbeat of the next measure before starting; so, you can trigger the arpeggiator to start ahead of time, and have it start in sync at the downbeat of the next measure. *If Syncing to an arpeggiator, see Num Beats on page 7-53 for details on changing when an arpeggiator's downbeat will occur.* With SyncType set to **AnyBeat**, if there is already something playing to sync to, the arpeggiator will wait only until the next beat. Depending on when you trigger the arpeggiator, it will sync up, but it may be on an upbeat or a downbeat.

With SyncType set to **DownBeatWait**, if there is something playing to sync to, the arpeggiator will wait for the downbeat of the next measure to start. The difference from DownBeat is that if there is nothing to sync to, the arpeggiator will not start. This can be useful if you want to start multiple arpeggiators synced to something else. For example, you could have a bass arpeggiator set to **DownBeatWait**, for instance, and trigger the arpeggiator while no other arpeggiators are running. As soon as you start something else to sync to, the bass arpeggiator will start playing as well (provided that it is set to sync to something else or the first available.) If something to sync to is already running, **DownBeatWait** behaves just like **DownBeat**.

With SyncType set to **AnyBeatWait**, if there is something playing to sync to, the arpeggiator will wait for the next beat to start. The difference from AnyBeat is that if there is nothing to sync to, this arpeggiator will not start. This can be useful if you want to start multiple arpeggiators synced to something else. You could have a bass arpeggiator set to AnyBeatWait, for instance, and trigger the arpeggiator while no other arpeggiators are running. As soon as you start something to sync to, the bass arpeggiator will start playing as well (provided that it is set to sync to something else or the first available). If another arpeggiator is already running, AnyBeatWait behaves just like AnyBeat.

With SyncType set to **Loop**, if there is already a riff or song playing to sync to, the current arpeggiator will wait for the playing riff or song to restart its loop (if it is looped) before starting (see *Loop* on page 7-59 for looping riffs, and *Loop* on page 12-11 for looping songs.) This way you can trigger the arpeggiator to start ahead of time, and have it start in sync at the start of the playing riff or song's loop (provided that it is set to sync to a riff, song, or the first available).

With SyncType set to **Stop**, if there is already something playing to sync to, the current arpeggiator will wait for what is playing to stop before starting. This way you can trigger the arpeggiator to start ahead of time, and have it start in sync at the release (stopping) of the riff, arpeggiator, or song that you are syncing to.

With SyncType set to **StartWait**, if there is nothing playing to sync to, the current arpeggiator will wait for something it can sync to to begin playing first before starting. This is similar to DownBeatWait, but it will only trigger the arpeggiator the first time that whatever it is syncing to starts. This way you can trigger the arpeggiator to start ahead of time, and have it start in sync at the start of the riff, arpeggiator, or song that you are syncing to. If you stop the arpeggiator and try to start it again while the thing you are syncing to is already playing, **StartWait** will not start the arpeggiator.

With SyncType set to **LoopWait**, if there is already a riff or song playing to sync to, the current arpeggiator will wait for the playing riff or song to restart its loop (if it is looped) before starting (see *Loop* on page 7-59 for looping riffs, and *Loop* on page 12-11 for looping songs.) This way you can trigger the arpeggiator to start ahead of time, and have it start in sync at the start of the playing riff or song's loop. The difference from Loop is that if there is nothing playing to sync to, the arpeggiator will not start. If the riff or song that you are syncing to is already running, **LoopWait** behaves just like **Loop**.

With SyncType set to **StopWait**, if there is already something playing to sync to, the current arpeggiator will wait for what is playing to stop before starting. This way you can trigger the arpeggiator to start ahead of time, and have it start in sync at the release (stopping) of the riff, arpeggiator, or song that you are syncing to. The difference from **Stop** is that if there is nothing playing to sync to, the arpeggiator will not start. This can be useful if you want to get your arpeggiator ready to sync before you start whatever you are syncing it to. If the riff or song that you are syncing to is already running, **StopWait** behaves just like **Stop**.

Num Beats

This affects the syncing of other arpeggiator or riff zones to the current zone, only if those other zones have a SyncType setting of Downbeat or DownbeatWait. For zones being synced to the current zone's arpeggiator, this determines how many notes must be played by the current zone's arpeggiator before a downbeat occurs. By decreasing or increasing the value of the Num Beats parameter, you can make zones with a SyncType setting of Downbeat or DownbeatWait behave as if downbeats are occurring less or more frequently.

Real-time Control of Arpeggiator Parameters

You can have real-time control over several arpeggiator parameters, by assigning physical controllers to special arpeggiator Controller Destinations. Any input (or entry value) from a physical controller assigned to an arpeggiator Controller Destination overrides the programmed values for the parameters of the arpeggiator on that controller's zone. The override remains in effect until you select a different setup (or a different program in Program mode.) Remember, each of the following Controller Destinations affects only the arpeggiator for the zone which your controller is assigned to.

Controller Number	Corresponding ARPEGGIATOR Parameter	Operation
147	ArpOn	Any controller value turns the Arpeggiator On.
148	ArpOff	Any controller value turns the Arpeggiator Off.
150	ArpOrder	Arpeggiator Order, each range of values selects one of nine options in order of the parameters list: 0-14 (Played,) 15-28 (Upwards, etc.) 29-42, 43-56, 57-70, 71-84, 85-98, 99-112, 113-127 (Simultaneous.)
151	ArpBeats	Arpeggiator Beats, each range of values selects one of seven options in order of the parameters list: 0-18 (Quarter notes,) 19-36 (8th notes, etc.) 37-54, 55-72, 73-90, 91-108, 109-127(32nd triplets.)
152	ArpShift	The 88 Arpeggiator Shift steps are scaled over the 128 MIDI controller values, so that 0 = 0 steps and 127 = 88 steps.
153	ArpLimit	The 60 Arpeggiator Shift Limit steps are scaled over the 128 MIDI controller values, so that 0 = 0 steps and 127 = 60 steps.
154	ArpLmtOp	Arpeggiator Shift Limit Option, each range of values selects one of seven options in order on parameters list: 0-18 (Stop,) 19-36 (Reset, etc.) 37-54, 55-72, 73-90, 91-108, 109-127 (FloatBip.)
155	ArpVel	Arpeggiator Velocity, each range of values selects one of twenty-three options in order on parameters list: 0-5 First,) 6-10 (Played, etc.) 11-15...101-105, 106-110, 111-127 (MissNotes9.)
156	ArpDur	The Arpeggiator Duration % values are scaled over the 128 MIDI controller values, so that 0 = 1% and 127 = 100%.
157	Latch	For Arpeggiator Latch Pedals mode, 0-63 = off, 64-127 = on.

Setup Mode

The ARPEGGIATOR & ARPEGGIATOR 2 (ARP1, ARP2) Pages

Controller Number	Corresponding ARPEGGIATOR Parameter	Operation
158	Latch2	For Arpeggiator Latch Pedals mode, 0-63 = off, 64-127 = on.
159	ArpGliss	Arpeggiator Gliss, 0-63 = off, 64-127 = on.
160	SusLatch	For Arpeggiator Latch Pedals mode, 0-63 = off, 64-127 = on.
170	-Arp Shift	Sets ARPEGGIATOR values for Shift to negative. 0-63 = off, 64-127 = on.
171	ShiftPatt	Selects one of the 128 patterns in the ShiftPatt Bank for the ARPEGGIATOR page of a controller's zone.
172	ShiftPBank	A controller value selects the corresponding ShiftPatt Bank for the ARPEGGIATOR page of a controller's zone. For example, controller value 2 selects bank 2, controller value 7 selects bank 7.
173	VelPatt	Selects one of the 128 patterns in the VelPatt Bank for the ARPEGGIATOR page of a controller's zone.
174	VelPBank	A controller value selects the corresponding VelPatt Bank for the ARPEGGIATOR page of a controller's zone. For example, controller value 2 selects bank 2, controller value 7 selects bank 7.
175	VelFixed	Set's arpeggiator velocity when velocity is set to Fixed for the ARPEGGIATOR page of a controller's zone.

Riffs

Riffs are full songs or individual tracks of a song created in the PC3K's Song mode that you can trigger in setup mode. Standard MIDI files may also be imported to Song mode and then used as riffs in setups. Every zone in a setup can have its own riff—a completely independent sequence. You can use a setup with many riffs to trigger and stop looped sequences of different instrument parts. Alternatively, a single riff can play multiple instrument parts. Each riff could be used as a different song section of a backing track.

To use a riff, first go to Song mode and note the ID# of the song, section of song and track that you will use for your riff. Next go to Setup mode and create a setup. On the CH/PRG page of the Setup Editor, choose the program that you want to use for the riff on the current zone. Program changes that are recorded in song mode will be ignored when using the song as a riff in a setup. You can also set up the playback event filter in Song mode to ignore other types of events as well. Once you have selected your program, press the **more** soft button until you get to the RIFF1 and RIFF2 pages. The following sections describe the contents of these pages.



Note: By default, setting a zone to trigger a riff will disable the ability to play notes of that zone's program from the keyboard. To re-enable this ability, see *Local* on page 7-59.

The RIFF1 Page

The first Riff page appears as shown below, and has the following parameters:

```

SetupMode:RIFF1 #zone:1/2
Riff      :On
Song      :27 NylonRiff1
Start:    1      :1 :0      SrcTrack   : ALL
Stop:     4      :1 :0      Re Channel : Off
Transpose : Off
Root Note : C 4
more ARP1 ARP2 RIFF1 RIFF2 more
  
```

Parameter	Range of Values	Default	
Riff	Off, On	Off	
Song	Song List	0 None	
Start	(Bar)	(dependent on sequence)	1
	(Beat)	1 to (dependent on time signature)	1
	(Tick)	0 to 959	0
Stop	(Bar)	(dependent on sequence)	2
	(Beat)	1 to (dependent on time signature)	1
	(Tick)	0 to 959	0
Transpose	Off, On	Off	
Root Note	C -1 to G9	C4	
SrcTrack (Source Track)	ALL, 1 to 128	ALL	
Re Channel	Off, On	Off	

Setup Mode

Riffs

Riff

Setting the Riff parameter to On will enable the riff feature for the current zone in setup mode. Setting this parameter to Off will disable the riff for this zone.

Song

Select the song you wish to use in the Song parameter by using the Alpha Wheel, +/- buttons, or the alphanumeric pad.

Start

Use the Start parameter to specify the riff start point. The time format is *Bar : Beat : Tick*. *Bar* can be set to any bar in the sequence, and *Beat* can be set to any beat in that bar (beat range is dependent on time signature.) *Tick* can be set from 0 to 959. Since there are 960 possible start points within a beat, you can specify your riff to start on any common beat subdivision moments (and a few uncommon ones). The following *Tick* values correspond to the following beat subdivision moments:

Beat Subdivision	Beat Subdivision Moment	Tick Value
Quarter note	1st	0
8th note	1st	0
	2nd	480
8th note triplet	1st	0
	2nd	320
	3rd	640
16th note	1st	0
	2nd	240
	3rd	480
	4th	720
16th note quintuplet	1st	0
	2nd	192
	3rd	384
	4th	576
	5th	768
16th note triplet (sextuplets)	1st	0
	2nd	160
	3rd	320
	4th	480
	5th	640
	6th	800

Table 7-5 *Subdivision Values*

Stop

Use the Stop parameter to specify the riff stop point. Like the Start parameter, the time format for Stop is *Bar : Beat : Tick*. *Bar* can be set to any bar in the sequence, and *Beat* can be set to any beat in that bar (beat range is dependent on time signature.) *Tick* can be set from 0 to 959. Refer to Table 7-5 for *Tick* values.

The PC3K restricts the selectable values for the Stop parameter such that the current riff is at least one beat long.

Transpose/Root Note

With the Transpose parameter set to **On**, the riff will transpose to the value set in the Root Note parameter. So, if you have a riff whose root note is C4, you can set a new root note in the setup so that the riff will play in the correct range. In this scenario, if you want to trigger your riff from C1 but it was recorded at C4, you would set Transpose to **On** and Root Note to C1. Your riff will now play in the desired range when triggered from the C1 key, which now corresponds to the note C4.

SrcTrack (Source Track)

The SrcTrack parameter determines the source track of the riff (from the riff's original sequence in Song mode.) Along with the Start and Stop parameters, SrcTrack allows you to use a single sequence as a riff for many zones, and to select a different source track and Start/Stop parameter setting for each zone to avoid having to create a special sequence for each riff.

To create a setup with multiple riffs each playing a single instrument part, set a single track for the SrcTrack parameter, and that track of the sequence will play with the program on the current zone. Repeat the process on other zones using the same song for the riff, but using a different SrcTrack for each zone.

To create a setup with a single riff that plays multiple instrument parts, set SrcTrack to ALL. Each track of the sequence will play its track through the zones which have corresponding MIDI channels (MIDI channels are set for each zone on *The Channel/Program (CH/PROG) Page* of the Setup Editor, see page 7-4.)

Re Channel

Use the Re Channel parameter when the current zone's MIDI channel and the channel that the riff was recorded on are not the same. When Re Channel is set to **On**, the track selected for the SrcTrack parameter will play through the MIDI channel of the current zone. For example, if you want to use a riff on zone 2/MIDI channel 2 and the riff was recorded on track 4/MIDI channel 4, you will need to turn Re Channel on. If you were to do this and keep Re Channel set to **Off**, the riff would play using the program from zone 4 instead of zone 2.

When Re Channel is set to **On** and ALL is selected for SrcTrack, *all* of the tracks of the sequence will play through the MIDI channel of the current zone.



Note: Track numbers don't have to match MIDI channel numbers in Song mode (though they do by default.) A song that uses non default MIDI channels for its tracks can cause some confusion when using it as a riff. For example, using a riff on zone 1, you could set the riff's SrcTrack parameter to 1, and expect the riff to play on zone 1 (if it is set to MIDI channel 1.) But in Song mode, if the song you are using for the riff has track 1 set to a MIDI channel other than 1, the riff will play on the zone that has that track's matching MIDI channel. In this case, set Re Channel to **On** in order for the riff to play through the program of the riff's zone.

The RIFF2 Page

The second Riff page appears as shown below, and has the following parameters:

```

SetupMode:RIFF2 #zone#1/2
Trigger : C -1 G 9 SyncZone: First Avail.
Release : C -1 G 9 SyncType: None
CondRel : Off RelSynZn : First Avail.
Local : Off RelSynTy: None
Loop : Forever Dur: 100% Vel: 100%
BPM : Sequence Offset : 0
more ARP1 ARP2 RIFF1 RIFF2 more
    
```

Parameter	Range of Values	Default	
Trigger	(HiKey)	C -1 to G9	C -1
	(LoKey)	C -1 to G9	G9
Release	(HiKey)	C -1 to G9	C -1
	(LoKey)	C -1 to G9	G9
CondRel	Off, On	Off	
Local	Off, On	Off	
Loop	Once, Forever	Forever	
BPM	Sequence, Setup, External, 20 to 400	Sequence	
Sync Zone	First Avail., Riff 1-16, Main Seq, Arp 1-16, FirstRiff.Av., First Arp.Av	First Avail.	
Sync Type	None, DownBeat, AnyBeat, DownBeatWait, AnyBeatWait, Loop, Stop, StartWait, LoopWait, StopWait	None	
Release Sync Zone (RelSynZn)	First Avail., Riff 1-16, Main Seq, Arp 1-16, FirstRiff.Av., First Arp.Av	First Avail.	
Release Sync Type (RelSynTyp)	None, DownBeat, AnyBeat, DownBeatWait, AnyBeatWait, Loop, Stop, StartWait, LoopWait, StopWait	None	
Duration	1 to 1000%	100%	
Velocity	0 to 255%	100%	
Offset	-32768 to 32767	0	

Trigger

There are a few ways to trigger riffs in setup mode. On the Riff2 page you can use the Trigger field to set a keyboard key to trigger the Riff. Also, any physical controller can be assigned to controller destination 163 **RiffOn**.

To set the key range to trigger your riff, use the cursor buttons to select the left value in the Trigger field (this will be the low end of the trigger key range.) Now you can select the key number by scrolling the Alpha Wheel, or you can use intuitive entry by pressing and *holding* the **Enter** button on the alphanumeric pad and pressing the desired key on your keyboard. You will see this value change as you press a key.

Next, move your cursor to the right to highlight the second value of the Trigger field (this will be the high end of the trigger key range.) Use one of the methods described above to select a key value for this trigger field. If you want to have only one key start a riff, set the Trigger key range from **A#0** to **A#0** for example, and your riff will be triggered to start only by pressing the A#0 key. If you want your trigger key range to be larger, set your Trigger key range to be, for instance, **A#0** to **A#1**. Now any key that is pressed within this range will trigger your riff to start.

Note: the LoKey and HiKey values on the KEYVEL page do affect the riff. If your riff's trigger and release notes are not within the LoKey and HiKey range on the KEYVEL page, your riff will not be able to be triggered from the keyboard.

Release

The way you release riffs is analogous to the way you trigger them. You can assign a physical controller to destination 164 **RiffOff**, or you can select a key or key range with the Release parameter. You set this the same way that you set the trigger range. Move your cursor so that the left field of the Release parameter is highlighted (this will be the low end of the trigger key range.) Now select a key value by using the Alpha Wheel, -/+ buttons or intuitive entry. Move your cursor to the right field and repeat the process (this will be the high end of the trigger key range.) If you set both of the Release values to A0, the Riff will stop when you *release* A0.

So, if you use the settings described above and in the *Trigger* section above, your setup's riff will start when you press A#0, and it will stop when you press *and release* A0.

Note: the LoKey and HiKey values on the KEYVEL page do affect the riff. If your riff's trigger and release notes are not within the LoKey and HiKey range on the KEYVEL page, your riff will not be able to be triggered from the keyboard.

Conditional Release (CondRel)

The CondRel parameter allows you to have a riff play only while a key is pressed and held, and nothing will stop or restart that riff until the key is released. To use conditional release, set the same range for the Trigger and Release ranges on the RIFF2 page. Any key that is pressed and held within this range will play the selected riff. Release the key and the riff will stop. Playing any other key in this zone while triggering a riff with CondRel—even if they are within the Trigger and Release ranges—will not retrigger or stop the zone's riff.

Local

If you want to trigger your riff without playing the current zone's program, set Local to **Off**. Local is set to Off by default since most users won't want to play the program in the zone they are using for a riff, but only wish hear that zone's program as a backing track. With Local set to **On**, you will play the current zone's program any time a key is pressed. This could create undesired "grace notes" if you trigger a riff that has a downbeat at the same time you are playing a note.

Loop

If you want your riff to loop indefinitely, set this parameter to **Forever**. If you want to have it play once and then stop until you retrigger it, set this parameter to **Once**.

BPM

There are four choices here that will determine what controls the tempo of your riff. With BPM set to **Sequence**, the original tempo in which the riff was recorded will be used. With BPM set to **Setup**, the tempo set on the COMMON or TEMPO pages will be used. When syncing multiple riffs it is convenient to set each riff's BPM parameter to **Setup**. Doing this, you can change the tempo of all riffs at once on the TEMPO page (see *TEMPO* on page 11-11.) A value of **Setup** is also useful for syncing riffs to a zone's arpeggiator. With Tempo BPM set to **External**, the riff will

sync to external MIDI clock. You can also manually choose a tempo by selecting a value from **20** to **400** for BPM. Use the Alpha Wheel or -/+ buttons to choose between the options or set a tempo. You can also use the alphanumeric pad followed by pressing the **Enter** button to enter a tempo.

SyncZone

The SyncZone parameter determines which zone a riff will sync to. You can choose to sync to a riff or arpeggio in a specific zone by setting SyncZone to **Riff 1–16** or **Arp1-16**, and the current riff will always sync to the riff or arpeggio in the set zone. For example, if you have a drum riff in zone 1 and a bass riff in zone 2, you may always want the bass riff in zone 2 to sync to the drum riff in zone 1. In this case you would set the bass riff SyncZone to **Riff 1**.

You may want to have a little more freedom and not be tied to the drum riff as the main “timekeeper.” Maybe you want to start with the bass riff and have the drum riff start later. In this case you would set SyncZone to **FirstRiff.Av.** With this setting, the riff will look for the first available riff to sync to. So if both the drum riff and the bass riff have this parameter set to **FirstRiff.Av.**, the riff that is started first will be the master. If the bass riff starts first, the drum riff will see that as the first available riff to sync to and will do so. If the drum riff is started first, the bass riff will see that as the first available riff to sync to and will do so. This can be very handy if you have multiple riffs and want to do some live remixing; you could have the drums drop out, and—as long as there is a riff playing—they will sync back up when triggered again.

You can also choose **FirstArp.Av.**, which behaves the same way as **FirstRiff.Av.**, but makes your riff look for the first available arpeggiator to sync to. A setting of **Main Seq.** will sync the riff to the song currently loaded in Song mode. You can select a song in Song mode, then play it from setup mode with the front panel **Play/Pause** button. (*Doing this temporarily replaces the programs in your setup’s zones with the program used for each channel in the song, so it’s best to make a setup that uses the same programs as your song on the same MIDI channels. If you plan on syncing riffs with a song, it may be easier to start by creating a setup, then recording the setup into a song. See Recording A Setup To Song Mode on page 7-69 for details.*) A setting of **First Avail.** will sync the riff to the first available riff, arpeggiator, or song from Song mode.



*Note: If you have multiple riffs or arpeggiators already playing when using **FirstRiff.Av.**, **FirstArp.Av.**, or **First Avail.** for the current riff, the current riff will sync to the riff or arpeggiator of the lowest numbered zone that has a riff or arpeggiator playing.*

SyncType

The SyncType parameter allows you to choose how your riff will sync to other riffs, arpeggiators, and Songs (depending on your settings made for the SyncZone parameter.) With SyncType set to **None**, your riff will start playing as soon as it is triggered. It will not sync to anything. With SyncType set to **DownBeat**, if there is already something playing to sync to, the current riff will wait for the downbeat of the next measure before starting; so, you can trigger the riff to start ahead of time, and have it start in sync at the downbeat of the next measure. *If Syncing to an arpeggiator, see Num Beats on page 7-53 for details on changing when an arpeggiator’s downbeat will occur.* With SyncType set to **AnyBeat**, if there is already a something playing to sync to, the riff will wait only until the next beat. Depending on when you trigger the riff, it will sync up, but it may be on an upbeat or a downbeat.

With SyncType set to **DownBeatWait**, the riff will wait for the downbeat of the next measure to start. The difference from DownBeat is that if there is nothing playing to sync to, the riff will not start. This can be useful if you want to start multiple riffs synced to one riff. You could have a bass riff set to **DownBeatWait**, for instance, and trigger the riff while no other riffs are running. As soon as you start another riff, the bass riff will start playing as well (provided that it is set to sync to another riff or to the first available riff.) If another riff is already running, **DownBeatWait** behaves just like **DownBeat**.

With SyncType set to **AnyBeatWait**, the riff will wait for the next beat to start. The difference from AnyBeat is that if there is nothing playing to sync to, this riff will not start. This can be useful if you want to start multiple riffs synced to one riff. You could have a bass riff set to AnyBeatWait, for instance, and trigger the riff while no other riffs are running. As soon as you start another riff, the bass riff will start playing as well (provided that it is set to sync to another riff or the first available). If something is already playing to sync to, AnyBeatWait behaves just like AnyBeat.

With SyncType set to **Loop**, if there is already a riff or song playing to sync to, the current riff will wait for the playing riff or song to restart its loop (if it is looped) before starting (see *Loop* on page 7-59 for looping riffs, and *Loop* on page 12-11 for looping songs.) This way you can trigger the riff to start ahead of time, and have it start in sync at the start of the playing riff or song's loop.

With SyncType set to **Stop**, if there is already something playing to sync to, the current riff will wait for what is playing to stop before starting. This way you can trigger the riff to start ahead of time, and have it start in sync at the release (stopping) of the riff, arpeggiator, or song that you are syncing to.

With SyncType set to **StartWait**, if there is nothing playing to sync to, the current riff will wait for something it can sync to to begin playing first before starting. This is similar to DownBeatWait, but it will only trigger the riff the first time that whatever it is syncing to starts. This way you can trigger the riff to start ahead of time, and have it start in sync at the start of the riff, arpeggiator, or song that you are syncing to. If you stop the riff and try to start it again while the thing you are syncing to is already playing, **StartWait** will not start the riff.

With SyncType set to **LoopWait**, if there is already a riff or song playing to sync to, the current riff will wait for the playing riff or song to restart its loop (if it is looped) before starting (see *Loop* on page 7-59 for looping riffs, and *Loop* on page 12-11 for looping songs.) This way you can trigger the riff to start ahead of time, and have it start in sync at the start of the playing riff or song's loop. The difference from Loop is that if there is nothing playing to sync to, the riff will not start. If the riff or song that you are syncing to is already running, **LoopWait** behaves just like **Loop**.

With SyncType set to **StopWait**, if there is already something playing to sync to, the current riff will wait for what is playing to stop before starting. This way you can trigger the riff to start ahead of time, and have it start in sync at the release (stopping) of the riff, arpeggiator, or song that you are syncing to. The difference from **Stop** is that if there is nothing playing to sync to, the riff will not start. This can be useful if you want to get your riff ready to sync before you start whatever you are syncing it to. If the riff or song that you are syncing to is already running, **StopWait** behaves just like **Stop**.

RelSynZn (Release Sync Zone)

RelSynZn has the same settings available as SyncZone (see *SyncZone*, above,) but RelSynZn determines what the releasing (stopping) of the current riff will be synced to when a parameter other than **None** is selected for RelSynTyp (see below.)

RelSynTyp (Release Sync Type)

RelSynTyp has the same settings available as SyncType (see *SyncType*, above,) but RelSynTyp determines how the releasing (stopping) of the current riff will be synced to other riffs, arpeggiators, and Songs (depending on your settings made for the RelSynZn parameter.) With RelSynTyp set to **None**, your riff will stop playing as soon as it is released. It will not sync to anything. With RelSynTyp set to **DownBeat**, if there is already something playing to sync to, the current riff will wait for the downbeat of the next measure before stopping when released; so, you can trigger the riff to stop ahead of time, and have it stop in sync at the downbeat of the next measure. *If Syncing to an arpeggiator, see Num Beats on page 7-53 for details on changing when an*

arpeggiator's *downbeat* will occur. With **RelSynTyp** set to **AnyBeat**, if there is already a something playing to sync to, the riff will wait only until the next beat before stopping when released. Depending on when you release the riff it will stop in sync with a beat, but it may be on an upbeat or a downbeat.

With **RelSynTyp** set to **DownBeatWait**, the riff will wait for the downbeat of the next measure to stop when released. The difference from **DownBeat** is that if there is nothing playing to sync to, the riff won't stop when released. If another riff is already running, **DownBeatWait** behaves just like **DownBeat**.

With **RelSynTyp** set to **AnyBeatWait**, if there is already a something playing to sync to, the riff will wait for the next beat before releasing. The difference from **AnyBeat** is that if there is nothing playing to sync to, this riff will not stop when released. This can be useful if you want to stop a riff in sync only when another riff is playing. If something is already playing to sync to, **AnyBeatWait** behaves just like **AnyBeat**.

With **RelSynTyp** set to **Loop**, if there is already a riff or song playing to sync to, the current riff will wait for the playing riff or song to restart its loop (if it is looped) before stopping when released (see *Loop* on page 7-59 for looping riffs, and *Loop* on page 12-11 for looping songs.) This way you can release the riff to stop ahead of time, and have it stop in sync at the start of the playing riff or song's loop.

With **RelSynTyp** set to **Stop**, if there is already something playing to sync to, the current riff will wait for what is playing to stop before releasing. This way you can trigger the current riff to release ahead of time, and have it stop in sync at the release (stopping) of the riff, arpeggiator, or song that you are syncing to.

With **RelSynTyp** set to **StartWait**, if there is nothing playing to sync to, the current riff will wait for something it can sync to to begin playing first before releasing. This is similar to **DownBeatWait**, but it will only release the riff the first time that whatever it is syncing to starts. This way you can trigger the riff to stop ahead of time, and have it stop in sync at the start of the riff, arpeggiator, or song that you are syncing to. If you restart the riff and try to release it again while the thing you are syncing to is already playing, **StartWait** will not stop the riff.

With **RelSynTyp** set to **LoopWait**, if there is already a riff or song playing to sync to, the current riff will wait for the playing riff or song to restart its loop (if it is looped) before stopping (see *Loop* on page 7-59 for looping riffs, and *Loop* on page 12-11 for looping songs.) This way you can trigger the riff to stop ahead of time, and have it stop in sync at the start of the playing riff or song's loop. The difference from **Loop** is that if there is nothing playing to sync to, the riff will not stop when released. If the riff or song that you are syncing to is already running, **LoopWait** behaves just like **Loop**.

With **RelSynTyp** set to **StopWait**, if there is already something playing to sync to, the current riff will wait for what is playing to stop before releasing. This way you can trigger the riff to stop ahead of time, and have it start in sync at the release (stopping) of the riff, arpeggiator, or song that you are syncing to. The difference from **Stop** is that if there is nothing playing to sync to, the riff will not stop when released. If the riff or song that you are syncing to is already running, **StopWait** behaves just like **Stop**.



Note: For all **RelSynTyp** settings except **Stop**, **StartWait** and **StopWait**, a riff can sync its release with its self. For example, you could use riff 1 and sync it to its self by setting **Riff 1** for the **RelSynZn** parameter. Then, if you set **DownBeat** for the **RelSynTyp** parameter, when released the riff would always wait until its next downbeat to stop.

Duration (Dur)

Duration changes the duration of each MIDI note. The original durations of the notes in the sequence are multiplied by the selected percentage. 100% will cause no change, values smaller than 100% will result in shorter durations, values larger than 100% will result in longer durations.

Velocity

Velocity changes the velocity of each MIDI note. The original velocities of the notes in the sequence are multiplied by the selected percentage. 100% will cause no change, values smaller than 100% will result in lower velocities, values larger than 100% will result in higher velocities.

Offset

You can fine tune the start time of your riff in ticks by using the Offset parameter. A positive value will delay the start time, while a negative value will speed up the start time.

Real-time Control of Riff Parameters

You can have real-time control over several Riff parameters, by assigning physical controllers to special Riff Controller Destinations. Any input (or entry value) from a physical controller assigned to a Riff Controller Destination overrides the programmed values for the parameters of the riff on that controller's zone. The override remains in effect until you select a different setup. Remember, each of the following Controller Destinations affects only the riff for the zone which your controller is assigned to.

Controller Number	Corresponding Riff Parameter	Operation
163	RiffOn	Riff On. Any value triggers the zone's Riff if Riff is set to On on RIFF1 page.
164	RiffOff	Riff Off. Any value stops playback of zone's Riff.
165	RiffDur	Riff Duration, sets the Duration parameter (see above.) The Duration value is calculated by multiplying the received controller value by 1000, and dividing the answer by 128 (any decimal points are taken off the final value.) Here are some example values: 7 = 54%, 13 = 101%, 19 = 148%, 32 = 250%, 64 = 500%, 127 = 992%
166	RiffVel	Riff Velocity, sets the Velocity parameter (see above.) The Velocity value is calculated by multiplying the received controller value by 2. For Example, 25 = 50%, 50 = 100%, 100 = 200%, 127 = 254%.
167	RiffDly	Riff Delay, Controls Offset parameter (see above.) Controller value 64 = 0 offset ticks. Each value away from 64 = 512 offset ticks. For example, 63 = -512 offset ticks, 65 = +512 offset ticks, 0 = -32768 offset ticks, 127 = +32256 offset ticks.

Setup Mode

The FX Pages: FX, AUXFX1, AUXFX2, and MASTFX

The FX Pages: FX, AUXFX1, AUXFX2, and MASTFX

The four Setup mode FX pages—FX, AUX1, AUX2, and MASTER EFFECTS—work the same way as the Effect mode pages—EffectsEnable, Aux 1 Override, Aux 2 Override, and Master Effects. See *Effect Mode and the Effects Pages* on page 9-4 for information on editing these pages. You can use the **Effect (FX Bypass) Mode** button to bypass effects while editing.

The Programmable Switch Pages: SWPRG1 to SWPRG8

The PC3K's eight Programmable Switches are the eight **Program Select** buttons located above the program Category buttons. Each button has its own SWPRG page, but each page is essentially identical.

The SWPRG page parameters are described in *Switch Controller Parameters* on page 7-30

```
SetupModePRG SWITCH1 #zone1/1
Type:      : Toggled      EntryState : None
OnControl  : OFF          ExitState  : None
OnValue    : None
OffControl : OFF
OffValue   : None

more SWPRG1 SWPRG2 SWPRG3 SWPRG4 more
```

Parameter	Range of Values	Default
Type	Momentary, Toggled	Toggled
On Control	Control Destination List	OFF
On Value	None, 0 to 127	None
Off Control	Control Destination List	OFF
Off Value	None, 0 to 127	None
Entry Value	None, Off, On	None
Exit Value	None, Off, On	None

The COMMON Page

The COMMON page contains parameters that affect every zone in the current setup.

```

SetupMode:COMMON
Tempo      : 120.00
ClockSource: Internal
AuxFXChan  : 1
KB3Chan    : 1
Mutes      : Zone Mutes
ArpegGlobal: Off
more Name Save Delete COMMON more
  
```

Parameter	Range of Values	Default
Tempo	20 to 300	120
Clock Source	Internal, External	Internal
Aux FX Channel	1 to 16	1
KB3 Channel	1 to 16	1
Mutes	Zone Mutes, KB3 Control	Zone Mutes
Arpeggiator Global	Off, Arp 1 to 16	Off

Tempo

When Clock Source is set to **Internal**, the Tempo parameter sets the PC3K system's tempo. The Tempo parameter values are in units of BPM (beats per minute). You can also set the tempo using the tap tempo function. Press the left and right cursor buttons simultaneously to access the TEMPO page (see *TEMPO* on page 11-11.)

Clock Source

With the Clock Source parameter, you can set the PC3K—within the current setup—to generate its own tempo by setting Clock Source to **Internal**, or you can set the PC3K to sync up with the tempo from another device—assuming the device is sending MIDI clock data to the PC3K via MIDI or USB—by setting Clock Source to **External**. When Clock Source is set to **External**, the Tempo parameter disappears from the display.

Aux FX Channel

The Aux FX Channel determines the FX channel through which the aux sends of all of the zones in the current setup are sent. For example, if a zone 2 in a setup has a program with **25 Basic Delay 1/8** as an Aux FX, and zone 2 is assigned to channel **5**, then setting the Aux FX Channel to **5** sends the programs of all of the zones in the setup through zone 2's Program's Aux FX (i.e., through **25 Basic Delay 1/8**).

KB3 Channel

With this parameter, you can specify the KB3 channel in the current setup. Note that if you assign a KB3 program to a zone not assigned to the KB3 channel, the PC3K will notify you on the CH/PROG page, and the KB3 program will not load. Before selecting a KB3 program for a Zone, set the KB3 channel to match the channel set for that Zone on its CH/PROG page.

Mutes

The Mutes parameter gives you control over the behavior of the Bank buttons (the buttons above the sliders). By default, in Setup Mode the PC3K uses the Bank buttons to control the muting and unmuting of zones (see page 7-2 for details.) When using a KB3 Program in a Setup, you must change the **Mutes** parameter to **KB3 Control** to use the Bank buttons to control KB3 effects. Set the **Mutes** parameter to **Zone Mutes** to make the Bank buttons control their default functions of muting and unmuting of zones.



Note: For setups with a KB3 program, you can program a switch to toggle back and forth between having the Bank buttons control KB3 effects, and having the Bank buttons Mute Zones. Pick a switch—say **SW**, which is right next to the **Arp** button. Choose a zone and go to the SWITCH page (or corresponding editor page for whatever switch you choose). Set the switch **Type** to **Toggled**, **OnControl** to **KB3Mutes** (enter **169**, or scroll to the end of the Controller List,) **OnValue** to **127**, **OffControl** to **KB3Mutes**, and **OffValue** to **0**. The **SW** switch will now toggle the Bank button functions for the Setup.

Arpeggiator Global (ArpGlobal)

With the ArpGlobal parameter, you can set the Arpeggiator of a single Zone to play notes on all Zones in the Setup. For example, if ArpGlobal is set to **Arp 3**, all zones will be played by the arpeggiator in in Zone 3 (if the arpeggiator in Zone 3 is active.) In addition to **OFF**, there are as many ArpGlobal settings as there are Zones in the current setup. For example, in a seven-zone setup, you can select a value of **OFF**, or **Arp 1–7** for ArpGlobal.

To exclude a Zone from being played by the global arpeggiator, set the *Arpeggiator* parameter to *Off* on the CH/PROG page for that Zone (see *Arpeggiator* on page 7-8 for details.)

For details on the arpeggiator for each Zone, see *The ARPEGGIATOR & ARPEGGIATOR 2 (ARP1, ARP2) Pages* on page 7-42.

TRIGGER KEYS (KEYTRG)

The TRIGGER KEYS page (see below) allows you to set a controller destination to be triggered by playing a specific key.

```

SetupMode: TRIGGER KEYS #Zone:1/1
Key       : C4
Dest      : OFF
Value     : 0
  
```

more KEYTRG more

In addition to generating a standard MIDI note on message, each key of the PC3K can be set to trigger a controller destination. TRIGGER KEYS can be set independently per Zone. By using Zones with overlapping key ranges, a single key can trigger multiple controller destinations. On the TRIGGER KEYS page, select the Key field and choose a note by holding the Enter button and playing the desired key (you can also use the Alpha Wheel, +/- buttons or alphanumeric pad to choose a note.) With the desired note selected, use the Dest field to select a controller destination (see *The Controller Destination List* for details.) Set a value to send to the controller destination with the Value field. Once a destination and value are set, the playing the key will send the value to the controller destination on the Zone's MIDI Channel (see *Channel* on page 7-5 for details on setting each Zone's MIDI channel.) This may also send a continuous controller message to the MIDI or USB out ports, depending on the Zone's Destination parameter (see *Destination* on page 7-5 for details.)

The Utility Soft Buttons

In addition to the Setup Editor's pages, there are basic library and editing soft buttons. Their functions are described below.

Name

This enables you to rename the current setup. Use any data entry method to do this, including the letters on the alphanumeric buttonpad.

Save

Pressing **Save** calls up the standard Save Dialog. Simultaneously pressing the **Plus** and **Minus** data entry buttons toggles between saving the setup to the first available empty location, or replacing a currently existing setup. For more detailed instructions on saving, see *Saving and Naming* on page 5-3.

Delete

This erases a setup from memory, freeing up space to store setups in other locations. (You can check the free memory in the PC3K at any time, on the top line of the pages in Master mode.) Press **Delete**, and you will be given a choice to Delete or Cancel. Press **Delete** again, and an "Are You Sure?" message will appear. Press **Yes** to delete the setup, or **Cancel** to cancel.

Factory ROM setups can not be deleted.

New Zone (NewZn)

Press **NewZn** to create a new zone with default parameters. The PC3K imports this zone from Zone 1 of **128 Default Setup**. If there are parameters or entire pages you use often, you can create your own Default Setup and save it to location 128; pressing **NewZn** will then import zones from your custom Default Setup.

Duplicate Zone (DupZn)

This adds a new zone with the same parameters as the current zone.

Import Zone (ImpZn)

You can import, or "bring in," any zone from any setup in memory. Press **ImpZn**, and use any data entry method to choose a setup to import from. Then use the **Chan/Layer** buttons to select one of that setup's zones. Now press **Import**, and the zone you selected will be added to the current setup.

Note: If you are using all 16 zones in a setup and you try to add, duplicate, or import a zone, a "No More Zones" message appears. You must delete an existing zone before you can add, duplicate, or import any new ones.

Delete Zone (DelZn)

This deletes the current zone from the setup. Use **DelZn** to free up zones so you can add or import new ones.

Recording A Setup To Song Mode

The MIDI output of a setup can be recorded to a song in Song mode. Each MIDI channel that is output from a setup is recorded into each track of a song (if the tracks have corresponding MIDI channels.) Programs from each zone of your setup are automatically assigned to tracks in Song mode. Follow these steps for proper recording of a new song from a setup:

1. Enter Song mode by pressing the **Song Mode** button.
2. On the Song mode MAIN page, select **0*New Song*** in the **CurSng** field by entering **0** on the alphanumeric pad and pressing the **Enter** button. This loads a default empty song file.
3. On the Song mode MAIN page, select **Mult** in the **RecTrk** field.
4. Press the **Setup Mode** button to enter Setup Mode and choose the desired setup.
5. Press the **left** and **right cursor** buttons simultaneously to reach the TEMPO Page. Enter a tempo by tapping the **Tap** soft button or enter a tempo in the **Tempo** field. When you are finished, press the **Done** soft button to return to the Setup mode main page.
6. Press the **Record** button and then the **Play/Pause** button to begin recording. The metronome will count off 1 bar and then recording will begin (you can set metronome and other recording settings in Song mode.)
7. Press the **Stop** button to stop recording. You will see the usual Song mode save changes dialog where you can review, retry, or save your song (see *The Save Changes Dialog* on page 12-8.)
8. After saving your song, you will be returned to the Song mode MAIN page, where your saved song will be loaded. You can continue to record or edit the song in Song mode just as you would with any other song (see *Song Mode and the Song Editor* on page 12-1.) Each program from each zone in your setup is automatically assigned to a track (change the **RecTrk** parameter in order to record to a single track.) You can also continue to record from Setup mode by going back to step 3, above. Remember to set the tempo (step 5 above) before recording, as the song tempo will change if your setup is saved with a different tempo.

Notes About Recording A Setup To Song Mode



Tempo: The tempo of a setup is set on the SetupMode:COMMON page (see *The COMMON Page on page 7-65*.) If you plan to record a song from the same setup several times, it is convenient to set your desired tempo on the SetupMode:COMMON page and save it with your setup. By doing this, you will not need to reset your setup tempo to the desired song tempo every time you load your setup (as in step 5, above.)

Riffs: If you are using Riffs in your setup, do the following to make each Riff play at your setup's tempo (which also becomes your song's tempo.) For each zone that has a riff, go to the SetupMode:RIFF2 page (see *The RIFF2 Page on page 7-58*) and set the **BPM** parameter to **Setup**. Remember to save changes to your setup when exiting the Setup Editor.

Effects: When recording a setup into Song mode, the song will not retain the Aux or Master effects settings of your setup. If you would like your song to use the same effects as your setup, copy the settings of your setup's FX, AUX1, AUX2, and MASTER EFFECTS pages to the FX, AUX1, AUX2, and Master Effects pages in your song. Alternatively, playing your song from setup mode will allow you to hear the effects. To do this, load your song, press the **Setup Mode** button to enter Setup mode and choose your setup, then press the **Play/Pause** button. This will play your song from Setup mode, and the effects will be intact.

Setup Mode

Recording A Setup To Song Mode

Mono Pressure: When recording a setup to Song mode with **Mult** selected for **RecTrk** in Song mode, you may notice that every track has recorded Mono Pressure messages, even if there is nothing else recorded on a track. If this bothers you, you can set the **MonoPress** parameter to **Off** on the Song:Event Filter Recording page (see *Song Mode: The Filter Pages (RECFLT and PLYFLT)* on page 12-15.) This will prevent Mono Pressure messages from being recorded to any track. Alternatively, you can erase Mono Pressure messages from specific tracks after recording. To do this, go to the EditSong: Track page (see *Song Editor: The TRACK Page* on page 12-21.) On the EditSong: Track page, use the **Chan/Layer** buttons to choose the track to edit (visible in the **Track** field at the top right corner of the display.) Set the **Function** parameter to **Erase** and the **Events** parameter to **MonoPress**. Use the **From** and **To** fields to select the entire length of your song, and press the **Go** soft button to erase Mono Pressure messages from the selected track. Repeat this for each desired track. You can also choose **ALL** for the **Track** parameter to erase Mono Pressure messages from all tracks.

Controller Messages: When recording a setup to Song mode with **Mult** selected for **RecTrk** in Song mode, you may often be recording more controller messages than you realize. This can happen because multiple setup zones often respond to the same physical controllers. This is likely to be the case when you use a setup created by duplicating zones and do not change the controller destination assignments for each new zone. Often this is the desired behavior, such as when using zones to create layers. For example, if zone one sends pitch bend messages from the pitch wheel, and you duplicate this zone to create a layered zone two, you will likely want the zone two to send the same messages from the pitch wheel. This way the pitch of these layered zones will bend simultaneously when using the pitch wheel. But say for example that you also have a zone three with a different key range than zones one and two, but which sends the same messages from the pitch wheel. While playing and recording your setup, the function of the pitch wheel will be obvious, but some confusion can arise when you have recorded your setup and you proceed to record more tracks in Song mode. Because you have recorded with **Mult** selected for **RecTrk**, the track for zone three will have pitch bend messages recorded wherever zones one and two have bend messages, even if zone three was not playing any notes at that time. For example, let's say zones one and two were bending during bar 1. If you want to separately record zone three during bars 1 and 2, you will probably want to delete the existing bend messages from zone three's track. You can do this from the EditSong: Track page (see *Song Editor: The TRACK Page* on page 12-21, and an example of its use in the *Mono Pressure* section, above.) Alternatively, if there is nothing to preserve on the track for zone three, you can record it with the song **Mode** parameter set to **Erase**, which will erase any existing events on the track during the time that you record. Just remember to change the **RecTrk** parameter in order to record to a single track.

Chapter 8

Quick Access Mode

In Quick Access mode, you can select programs or setups with a single press of an alphanumeric button (or with other data entry methods). The PC3K offers a number of ways to quickly make selections while performing, but only Quick Access mode lets you store programs and setups together for instant access. On the PC3K, we included several factory preset QA banks that are organized into useful groupings of sounds that we think you'll find convenient. Below is the QA page:

```

QuickAccessMode #Bank: 1 Leads
VA1 Emerson Le MaroonSynBass MwhlClubsweep
VA1 Distlead CC SquareChirPLe Downes Lead
NewOrderPulse Fitty-Fitty Le VA1 Saw Lead
Mono Trekkies
XPose: 0ST Standard Grand Ch:1
Octav- Octav+ Chan+ Info XPose- XPose+

```

The top line of the page displays the current mode and the current QA bank.

Using Quick Access mode involves selecting Quick Access (QA) banks from the list of factory preset or user-programmed banks. Use the **Chan/Layer** buttons to scroll through the QA banks. You can also use the bank selection shortcut: press the +/- or **Clear** button on the alphanumeric pad, and you'll be prompted to enter a bank number. Type the desired number on the alphanumeric pad, then press **Enter**. The bank is selected, and you return to the Quick Access mode page.

Each bank contains ten memory slots, or entries, where you can store programs or setups in any combination. Any program or setup in the currently selected bank can be selected with the numeric buttons **0** through **9**.

If the highlighted entry contains a *program*, the bottom right-hand field of the page displays the channel on which the program entries are transmitted (this channel is the current channel in Program mode). If the highlighted entry contains a *setup*, the bottom right-hand field of the page displays the word "Setup."

The MIDI Program Change commands that the PC3K receives when in Quick Access mode can differ from those in Program or Setup mode. This depends on the setting you have for the **PrgChgMode** parameter on the **MIDIMode:Receive** page in MIDI mode. If **PrgChgMode** is set to **Extended** or **K2600**, the PC3K responds to Program Change commands as it would in Program or Setup mode. If **PrgChgMode** is set to **QAccess**, the PC3K responds to Program Change commands by calling up the corresponding entry in the current QA bank, not the actual program number of the entry.

Soft Buttons In Quick Access Mode

Use the **Octav-** and **Octav+** soft buttons to transpose up or down by a full octave. Pressing both **Octav** buttons simultaneously returns the transposition to its original setting.

Press the **Info** soft button to see all of the controller assignments of the current program. Scroll down the page using the Alpha Wheel, cursor or the **-/+** buttons.

The **Xpose-/Xpose+** buttons are a shortcut for quick transposition in semitone (half step) increments. You can use them to transpose the entire PC3K as much as three octaves up or down. The bottom line of the display shows the current amount of transposition (Xpose). Pressing both **Xpose** buttons simultaneously returns the transposition to zero. The **Xpose** buttons transpose the PC3K, as well as any MIDI devices connected to the PC3K's MIDI Out port. Changing the transposition with the soft buttons also changes the Transpose setting on the MIDIMode:Transmit page in MIDI mode.

The QA Editor

Use the QA Editor to customize existing QA banks. Enter the QA editor from QA mode by pressing the **Edit** button.

```

EditQA Bank: 1 Leads #Entry: 0
1 Standard Grand
2 Studio Grand
3 RubensteinSWComp Type: Program
4 Horowitz Grand Chan 1
5 NYC Jazz Grand

Name Save Delete Type

```

The top line gives you the usual mode reminder, the current QA bank, and the current entry (corresponding numeric button for the highlighted object.) The cursor highlights the object (program or setup) that's stored in the current entry.

Selecting A Quick Access Entry To Edit

Pressing the **Chan/Layer** buttons scrolls through the ten entries—the number of the current entry is displayed in the top-right corner. As the entry number changes, the highlighted objects at the center of the page change as well, showing you what's stored in each entry. On the page above, for example, entry 0 is the current entry.

Selecting A Program For A Quick Access Entry

Above, the Type field tells you that the object stored at entry 0 is a program. The cursor highlights the program's ID and name. Use the Alpha Wheel or **-/+** buttons to scroll through the list of programs.

Selecting A Setup For A Quick Access Entry

If you want to store a setup in the current entry instead of a program, press the **Type** soft button—when you do this, notice that the Type field change from **Program** to **Setup** (also notice that the channel indicator disappears, since setups can transmit over several channels). The list of objects changes from the program list to the setup list. Just as with programs, the cursor highlights the setup's ID and name. Use the Alpha Wheel or **-/+** buttons to scroll through the setups. You can also use the alphanumeric pad followed by the **Enter** button to choose a Setup by ID#.

Keep in mind that you can have both setups and programs in the same QA bank.

Naming And Saving A Quick Access Bank

When you've filled each entry with the object you want, press the **Name** soft button if you want to rename the bank, or press the **Save** soft button to begin the save procedure. Or, press the **Exit** button to exit the QA editor, and the "Save Changes?" dialog comes up.

Quick Access Mode

The QA Editor

Chapter 9

Effects and Effect Mode

The PC3K boasts a powerful effects processor that puts the power of an entire studio at your fingertips. This chapter contains everything you'll need to know to use the PC3K's effects and Chain Editor to their fullest potentials.

- Read the *Effects Overview* section below for a description of the differences between Insert, Aux, and Master effects. This section also explains the concepts of effects Chains, signal flow, and DSP units.
- Read the *Effect Mode and the Effects Pages* section (see page 9-4) for details on quickly changing Aux effects settings in Program mode. This section can also be used as a reference for the effects pages in **Setup mode** and **Song mode**. For details on effects parameters in the **Program Editor** see *The Program FX (PROGFX) Page* on page 6-47, and *The Layer FX (LYR_FX) Page* on page 6-49.
- Read the *The Chain Editor* section (see page 9-9) for instructions on how to edit and create your own effects Chains (presets.)
- Lastly, the *Effects Parameters* section (see page 9-12) contains details on the parameters for each type of effect available in the Chain Editor.

Effects Overview

This section gives an overview of the basic effects types available in the PC3K, PC3K effects Chains (presets,) effects routing in the PC3K, effects processor power management, and overriding the Aux Chains stored with each Program. Read the Insert Effects and Aux Effects sections to learn about the two types of effects that can be applied during different stages of a program's signal path.

Insert Effects

Insert Effects are placed directly in the signal path at the output of a single program. These Insert Effects can apply to either the whole program or only to selected layers within the program. Each program layer and program on a zone/track can have its own Insert Effect chain (up to 11 insert chains can be loaded, depending on available processing power, see *DSP Units - Manage and Distribute Processor Power for Effects* on page 9-3 for details.)

Aux Effects

Aux Effects, unlike Insert FX, are not applied to the whole output of a program, but are blended in with the original unprocessed program sound. Each Program, Setup or Song has two stereo Aux Sends that go to the Aux 1 and Aux 2 Effects. The Aux Effects are global (available to all channels/zones/tracks at the same time,) and there can be only one set of Aux effects (Aux 1 and Aux 2) loaded at a time. Each Aux effect can be set to be applied either pre- or post-Insert Effect (see *Signal Flow* below for details.)

In Program mode, the Aux Effects come from the program loaded on the currently selected MIDI channel. In Song and Setup modes, there is a parameter to select the track or zone whose program specifies the Aux Effects. Alternatively, the Aux Effects stored with each program can be temporarily overridden by using the **Effect** button in Program mode, or set directly on the AUX1 and AUX2 pages in Song or Setup mode (see *Aux Override* on page 9-3 for details.)

Master Effects

After the signal goes through the Insert and Aux effects, the master EQ/compressor effects are applied globally to the signal at the main outputs. Neither the EQ nor the Compressor use up any DSP units, so you needn't account for them when managing DSP units for effects processing power. See *The Master Effects Page* on page 9-8 for details.

Chains

The object used for Insert and Aux Effects is referred to as a "Chain." A Chain contains a single effect-box or is a series of connected effect-boxes. Each program can have one main Insert Chain, or individual layers within a program can have their own Insert Chain that will be used instead of the program's main Insert Chain. Programs, Setups and Songs can each have two Aux Chains. You can select from the same set of Chains to use for both Aux and Insert Effects. (*Up 11 Insert Chains and two Aux Chains can be active at a time, depending on DSP unit usage, see DSP Units - Manage and Distribute Processor Power for Effects on page 9-3 for details.*)

Signal Flow

When using effects, it is important to understand how your signal is being processed. For each Program, zone, or track, your signal can be sent to the Aux effects before or after being processed by the Program's Insert effects. The diagram below is for a program that does not use layer-specific effects, showing the possible routes that the signal of a program can "flow" through to reach the different types of effects. Follow the appropriate route to help visualize the stages in which the signal is being processed. A circle with an arrow through it shows a point where the signal level can be adjusted. Dashed lines indicate different routes that the signal can flow (based on the Aux pre/post settings and Master FX Order settings. A circled sigma (Σ) shows where signals are mixed together.

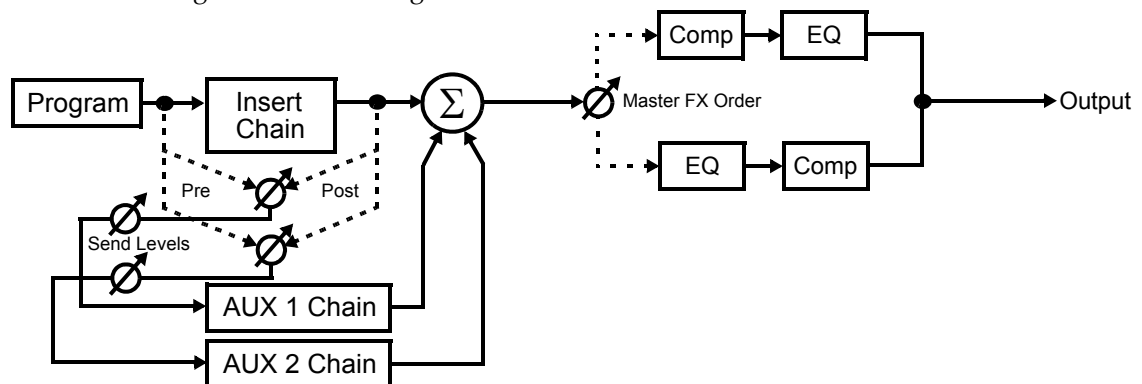

When using effects, the first decision to make is whether you want to use an Insert or Aux effect (see the *Insert Effects* and *Aux Effects* sections above.) If you are using both types of effects for a program, zone, or track in Song Mode, you can choose to have your signal sent to the Aux effects before or after being processed by the Insert effects. (See *Send Levels and Pre/Post Ins.* on page 9-7 for details.) When your signal is sent to the Aux Effects *after* being processed by the Program's Insert Effects, this is called applying the Aux Effect **post-Insert**. When your signal is sent to the Aux Effects *before* being processed by the Program's Insert Effects, this is called applying the Aux Effect **pre-Insert**.

When an Aux Effect is applied **post-Insert**, the wet (processed) Aux signal has a *series* of effects applied to it—i.e., cascaded effects. This means that the signal that is blended back in from the result of the Aux Effect will also contain the result of the Insert Effect.

When an Aux Effect is applied **pre-Insert**, the wet Aux signal has no Insert effect applied to it, and the final output has *parallel* effects—i.e., distinct effects. This means that the signal that is blended back in from the result of the Aux Effect will *not* contain the result of the Insert Effect.

The diagram below shows the signal paths for a multitimbral setup or song. The first two zones (or tracks in Song Mode) are diagrammed as an example (represented by dark lines.) The 14 additional available zones (or tracks in Song mode) are represented by gray lines (labeled as *Etc.*) Notice that each Program has its own Insert Chain, but all Programs share the same two Aux Chains:

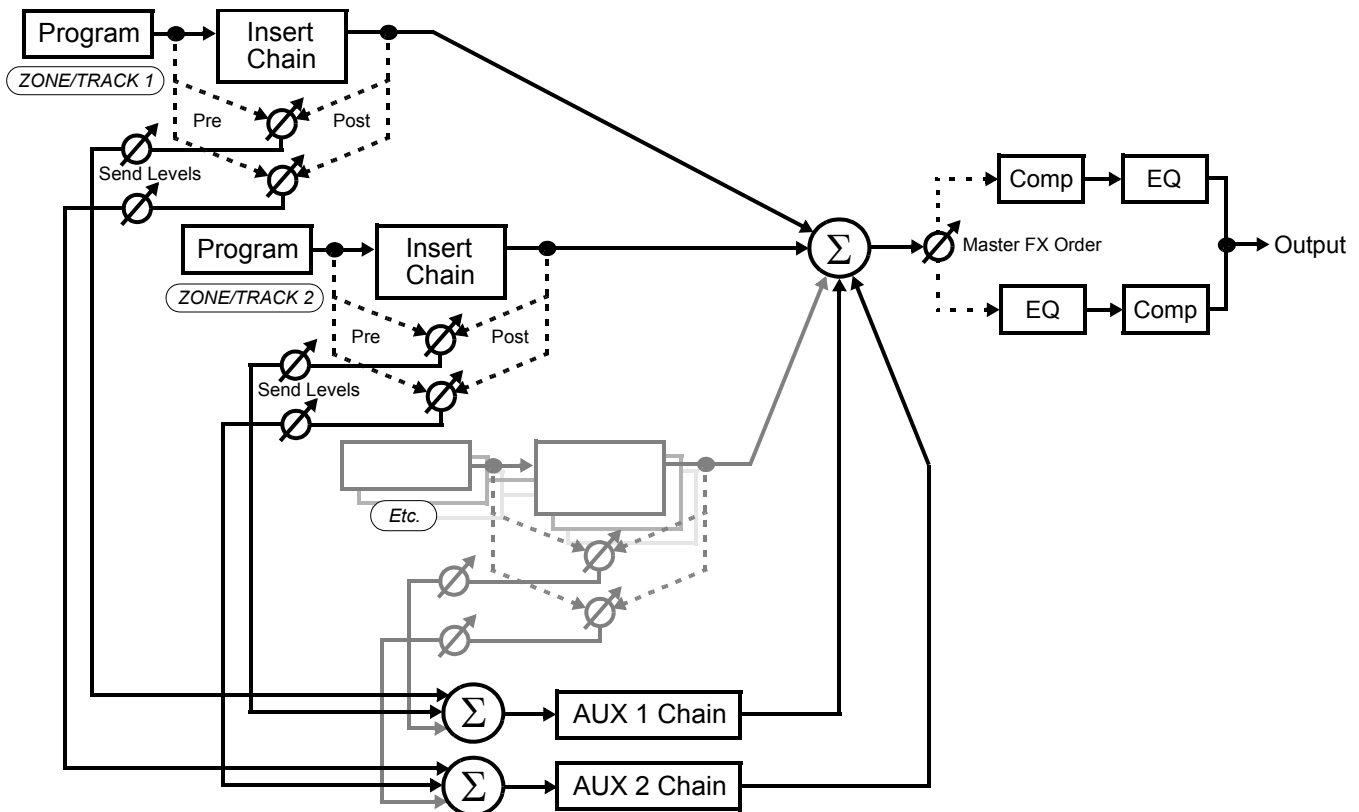

DSP Units - Manage and Distribute Processor Power for Effects

Each Effect Chain is composed of an effect-box or a series of effect-boxes. Each effect-box uses a certain amount of the PC3K's effects processing power, represented as a number of "DSP units." The number of DSP units used by an effect-box or Chain reflects how complex the effect's algorithm is—more complex effects require more processing power. You can use up to 16 DSP units at a time shared between all effects (except Master effects, which don't use any DSP units.) See *The EffectsEnable Page* on page 9-4 for details on how the PC3K automatically manages the usage of DSP units (the default behavior,) and how you can override this behavior and manually manage usage of DSP units.

Aux Override

Normally, in Program mode the Aux Effects Chains are specified by the program on the current channel—or, in Setup mode and Song mode, by the program on the specified Aux Effects channel. Aux override allows you to audition and select a new Aux chain without editing a program. In Effects mode, the Setup Editor, or Song mode, press the AUXFX1 or AUXFX2 soft buttons to set overrides for Aux Chain selection and other Aux Effects parameters. The Chain specified for the Aux override is used instead of the chain of the current channel (or instead of the specified Aux Effects channel in Setup and Song mode.) Also, send levels and other parameters normally specified within individual programs can be set to fixed values on the Aux Override pages. See *The Aux 1 Override and Aux 2 Override Pages* on page 9-5 for details.

Effect Mode and the Effects Pages

In Program mode (or with a program selected in Quick Access mode) press the **Effect** mode button to enter Effect mode. Effect mode allows you to quickly change program effect settings without entering the Program Editor, and set Master effects. You can set DSP unit usage for programs on each MIDI channel. You can override the current Aux Chains (set by the program on the currently selected MIDI channel) by selecting new Aux effect Chains. You can also override other Aux settings that are usually set by the program on the currently selected MIDI channel, such as physical audio output settings, controller assignments for Aux send levels, and Aux send levels and pre/post insert settings for programs on each MIDI channel.

Most of the settings in Effect mode apply only to Program mode and programs selected from Quick Access mode (see *The Master Effects Page* section below for an exception.) Setup mode and Song mode have their own Effects pages which are very similar to the pages in Effects mode. The following sections can be used as a reference for those pages, any differences will be noted.



Note: The settings made in Effect mode can be saved by saving the master table. By default, the master table is saved when exiting Master Mode (see *Save* on page 11-18 and *Master Table Lock (Master Lock)* on page 11-3 for details.) If you don't save the master table, the Effect mode settings will return to their defaults the next time the PC3K is turned on. **Be careful, do not accidentally save the Effect mode settings if you do not wish to.** The settings on the effects pages for Setup mode and Song mode are saved with each Setup and Song.

The EffectsEnable Page

NOTE: In Setup mode and Song mode, this page corresponds in appearance and function to the FX page, though the FX page works on a per setup/song basis.

```

EffectsEnable 3 Units
Allocate FX Per channel:
 1  2  3  4  5  6  7  8  9 10 11 12 13 14 15 16
  Y  N  Y  Y  Y  Y  Y  Y  (Y) Y  Y  Y  Y  (Y)(Y) Y
Prog. Insert : 455 PadFX1
Aux 1       : 906 Medium Hall2
Aux 2       : 0 None
CHANFX  AUXFX1  AUXFX2  MASTER

```

Pressing the CHANFX soft button calls up the EffectsEnable page. This page is used to manage and distribute effects processing power (DSP units) among the programs on each MIDI channel. By default the PC3K automatically manages the usage of DSP units, see *Default DSP Unit Usage* below for details. You can also override the default DSP unit usage by using the EffectsEnable page, see *Manual Management of DSP Unit Usage* below for details.

About DSP Units

Each Effect Chain is composed of an effect-box or a series of effect-boxes. Each effect-box uses a certain amount of the PC3K's effects processing power, represented as a number of "DSP units." The number of DSP units used by an effect-box or Chain reflects how complex the effect's algorithm is—more complex effects require more processing power. You can use up to 16 DSP units at a time shared between all effects (except Master effects, which don't use any DSP units.)

Default DSP Unit Usage

In Program Mode, the program on the currently selected MIDI channel will have priority for using DSP units, followed by programs on the lowest to highest MIDI channel. The PC3K loads

effects for programs on each of the 16 MIDI channels until all of the 16 DSP units are used up. In Setup and Song Mode, the MIDI channel of the lowest used zone/track will have priority for using DSP units. This zone/track will use as many DSP units as it need for its effects, then the MIDI channel of the next highest used zone/track will use DSP units to load its effects, and this continues until all of the DSP units are used up.

Manual Management of DSP Unit Usage

You can override the default DSP unit usage and manually control which channels can use DSP units and which can not. Use the EffectsEnable page to turn on or off DSP unit usage for the program on each MIDI channel.

On the EffectsEnable page, each channel can be set to **Y** to use DSP units for that channel, or to **N** to not use DSP units for that channel. Some channels set to **Y** may be displayed as **(Y)**. This means that there are not enough DSP units available for that channel, and that channel's effects are not loaded. Use the cursor buttons to select each channel, then use the Alpha Wheel or +/- buttons to set the selected channel to **Y** or **N**.

As the cursor is moved from left to right on these pages, the Insert and Aux Effects Chains for each channel are displayed on the bottom of the page. (*Aux Chains are only displayed if the channel is the current channel in Program Mode or the specified Aux Effects channel in Setup or Song mode.*) The number of DSP units required to load effects for the cursor-highlighted channel is shown at the top of the page.



Note: When a channel isn't allocating DSP units because it's set to **N** or **(Y)** (because resources are exhausted,) the channel still sends its signal to the Aux sends. If the channel set to **N** or **(Y)** has its Aux sends turned up, and the Aux effect is on a channel set to **Y**, the channel set to **N** or **(Y)** will still be processed by the Aux effects on the channel set to **Y**. (*On the EffectsEnable page, the channel with a box around its channel number contains the Aux Chains currently being used. This is the currently selected channel in Program mode, or the specified Aux Effect channel in Setup and Song mode.*)

The Aux 1 Override and Aux 2 Override Pages

NOTE: *In Setup mode and Song mode, these pages correspond in appearance and function to the AUX1 and AUX2 pages, though they work on a per setup/song basis.*

Pressing the **AUXFX1** soft button or the **AUXFX2** soft button calls up, respectively, the Aux 1 Override page or the Aux 2 Override page. Use these pages to change Aux effect settings without entering the Program Editor.

Each Program in the PC3K can be saved with two Aux effects chains. In Program Mode, the program on the current MIDI channel determines the Aux effect chains used for programs on all channels. (*In Setup and Song mode Aux chains are determined by the program on the specified Aux Effects channel.*) To change Aux effect settings without entering the Program Editor, enter Effects Mode and go to the Aux 1 or Aux 2 Override page. (*Go to the AUX1 and AUX2 pages in Song mode or the Setup Editor.*) You can select a different Aux effect chain, set Aux send levels for programs on each channel, and set other basic Aux effect parameters. In Program Mode, these parameters remain at their override values until the PC3K is restarted, or until you reset them in Effect mode to the default values listed in the table below. (*In Setup and Song mode these settings are saved with each Setup or Song.*)

```

Aux 1 Override loaded(ch6) 906 Medium Hall2
Override: No
Output: auto      Mod Override: None
Send Levels and Pre/Post Ins.:
 1  2  3  4  5  6  7  8  9 10 11 12 13 14 15 16
[P] [P] [P] [P] [P] [P] [P] [P] [P] [P] [P] [P] [P] [P] [P] [P]
[P] [P] [P] [P] [P] [P] [P] [P] [P] [P] [P] [P] [P] [P] [P] [P]
CHANFX AUXFX1 AUXFX2 MASTER
    
```

Parameter	Range of Values	Default
Override	No, Yes	No
Chain	Chain List	0 None
Output	auto, Pri., Sec.	auto
Mod Override	Control Source List	None
Send Level	[p], -96 to 24 dB	[p]
Pre-/Post- Insert	[p], pst, pre	[p]

Override

This parameter switches on or off the Aux override. Set Override to **Yes** to select an override Aux Chain on this page (the **Chain** parameter appears, see below.) Set Override to **No** to use the aux chains of the program on the current channel (or the program on the specified Aux Effects channel in Setup or Song mode.) If Override is set to **No**, the top line of the page displays the Aux Chain that is loaded for the current program, as well as the current channel. In the case of the page shown above, the Aux 1 Chain of the current program is **906 Medium Hall2**, and the current channel is 6.

Notice that in Program mode, if an Aux effect is overridden in Effect mode, the top line of the PROGFX (or LYR_FX) page (in the Program Editor) indicates that corresponding Chain does not use up any DSP units. Since the Chain specified for the program is not applied, the PC3K does not allocate resources for it.

```

Aux 1 Override
Override: Yes Chain: 8 Opera House
Output: auto      Mod Override: None
Send Levels and Pre/Post Ins.:
 1  2  3  4  5  6  7  8  9 10 11 12 13 14 15 16
[P] [P] [P] [P] [P] [P] [P] [P] [P] [P] [P] [P] [P] [P] [P] [P]
[P] [P] [P] [P] [P] [P] [P] [P] [P] [P] [P] [P] [P] [P] [P] [P]
CHANFX AUXFX1 AUXFX2 MASTER
    
```

Chain

When Override is set to **Yes**, you can select an override Aux Chain for the page’s corresponding Aux bus. This parameter is not visible when Override is set to **No**.

Output

This parameter specifies the physical audio output pair for the page's corresponding Aux Chain's output. The settings **Pri.** and **Sec.** refer, respectively, to the *primary* and *secondary* physical audio outputs of the PC3K (labeled "MAIN" and "AUX" on the back panel.) Setting Output to **auto** uses the output pair specified in the program on the current channel (*or the program on the specified Aux Effects channel in Setup or Song mode*).

Mod Override

This parameter can be used to override the Mod Control source of the program on the current channel (*or the program on the specified Aux Effects channel in Setup or Song mode*.) Set a physical controller or other Mod Control source to scale the Aux send level between -96dB and the value set for the aux send level. A setting of **None** yields no override in Mod Control source, and uses the Mod Control source specified in the program on the current channel (*or the program on the specified Aux Effects channel in Setup or Song mode*.)

Send Levels and Pre/Post Ins.

On the bottom half of the page, there are two parameters for each of the 16 MIDI channels: *Send Level* (top row) and *Pre-/Post-Insert* (bottom row).

The setting for each *Send Level* parameter determines if each channels Aux Send Level is overridden, and if so, by what value. A value of **[p]** means "no override" (i.e., use the values specified in the program). A value of **[p]** can be set by entering -99 with the alphanumeric pad and then pressing the Enter button, or by using the Alpha wheel or +/- buttons to scroll below -96db.



Note: In most factory ROM programs, the send level for Aux 1 is controlled by an Aux mod set to MIDI28 (slider I.) If a send level override is set, it will usually be scaled by the entry value for slider I each time a program is selected. To defeat this behavior, set the **Mod Override** parameter to **ON**, then set the Send Level override value.

The setting for each *Pre-/Post-Insert* parameter determines if the Aux routing for each channel is overridden, and if so, by what routing. **Pre** means that the Aux Send takes place before any Insert Effect is applied, whereas a setting of **Pst** means that the Aux Send takes place *post*-Insert Effect. (Of course, if the program on the channel has no Insert Effects loaded, then this parameter will make no difference.) A value of **[p]** means "no override" (i.e., use the values specified in the program).

The Master Effects Page

NOTE: In Setup mode and Song mode, this page corresponds in appearance and function to the MASTER EFFECTS page, which works on a per setup/song basis.

Pressing the **MASTER** soft button calls up the Master Effects page. The Master Effects page contains the settings for the master EQ and Compressor. When enabled, the master effects are applied to all programs in Program Mode. *(In Setup and Song mode, each setup and song can have its own master effects settings or use the master effects settings from Effect mode, see Mode below for details.)* The page appears as shown below:



Parameter	Range of Values	Default
Mode	Master, Setup	Master
Order	Compressor => EQ, EQ => Compressor	Compressor => EQ
Master FX	Master FX Enabled, Master FX Bypassed	Master FX Enabled

The two boxes in the chain on the Master Effects page are the master Compressor and EQ Effects. Press the **Edit** button while either of these boxes is selected to edit the parameters for the box's effect. See *Equalizers (EQ)* on page 9-15 and *Compressors, Expanders, and Gates* on page 9-16 for description on the EQ and Compressor parameters.

Mode

The setting for the Master Effects can be set directly on this page, or optionally in the control setup. In Program mode, to set up the Master Effects from Effect mode, set the Mode parameter to **Master**. To use the settings in the current control setup, select **Setup**. Controlling the Master Effects from the control setup allows for convenient switching between different configurations. See *Control Setup* on page 6-9 details. *(In Setup and Song modes, a setting of Master uses the master effect settings set in Effect Mode, while a setting of Setup uses the master effects settings for the current Setup or Song.)*

Order

Use the Order parameter to determine the order of the two effects. Setting Order to **Compressor => EQ** routes signal through the Compressor first, and then through the EQ. Setting Order to **EQ => Compressor** routes signal through the EQ first, and then through the Compressor.

Master FX

The Master FX parameter determines whether the Master Effects are enabled or bypassed. Setting Master FX to **Master FX Enabled** enables the Master Effects. Setting Master FX to **Master FX Bypassed** bypasses the Master Effects, and effectively removes them from the signal path.

The Chain Editor

Pressing the **Edit** button while a Chain (other than **0 None**) is highlighted—on any of the various effects pages—will call up the Chain editor. From the Program editor, the program's Insert and Aux Chains can be edited from the PROGFX and LYRFX pages. In Effect mode Chains selected for Aux overrides can be edited from the Aux 1 Override and Aux 2 Override pages. In Setup and Song mode Chains selected for Aux overrides can be edited from the AUX1 and AUX2 pages.

A Chain is made up of one or more effect-boxes, with each box containing a single effect. You can have up to 16 effect-boxes in a Chain. The settings for all of the parameters of each effect-box are also stored within the Chain. There are 15 Mod Controls that allow for real-time control over any parameter from any effect-box in the Chain. Per Chain Control sources are also provided to be used as inputs to the effect Mods (two *FXLFOs*, two *FXASRs*, and four *FXFUNs*.) These work similarly to the LFOs, ASRs and FUNs in Program mode, but are only available for use with the effect Mods.

The MAIN Page

In the Chain Editor, pressing the **MAIN** soft button calls up the MAIN page. The MAIN page is where you configure the length of a Chain and select the individual effects that make up the Chain. The Chain editor MAIN page of the Chain **269 PnoEnhancRvb3** appears as shown below:



At the top right of the display is the number of DSP units used by the currently selected effect-box, and by the Chain as a whole. **2/5 Units** indicates that the current effect-box is using two DSP units and the Chain is using a total of five DSP units for all of its effects boxes. There are a total of 16 units available for all of the Chains that are currently loaded by programs and any active Aux overrides from Setup/Song/Effects mode.

NOTE: In some configurations, not all 16 units are available for use with multi-unit effects because of the way the DSP is allocated internally.

Like all other representations of signal paths in the PC3K display, the program signal moves from left to right through the Chain. Use the cursor buttons to select an effect-box or empty spot in the Chain. The effect loaded into the selected effect-box can be changed by numeric entry, with the Alpha Wheel, or with the +/- buttons; and can be changed with either the effect-box or the Effect field at the bottom of the page highlighted. The +/- double button press will jump to the next effect “category.”

Pressing the **Insert** soft button adds a new effect-box to the Chain in the currently selected block-slot, and pushes the currently selected effect-box down the Chain to the right. (*If you have run out of DSP units, you will not be able to create additional effects boxes.*) Pressing the **Remove** soft button takes the currently selected effect out of the Chain.

Editing Effect-boxes

To edit the parameters of an effect, select its effect-box on the MAIN page and press the **Edit** button. For each effect, there are one or more pages of parameters that are specific to that effect. See *Effects Parameters* on page 9-12 for details on parameters for each type of effect. Any parameter controlled by an effect Mod will display a value of **FxMod** and cannot be edited. To return to the MAIN page of the chain editor, press the **Exit** button.

The MOD Pages

There are three pages for configuring effects mods: MOD1, MOD2, and MOD3. All three pages are essentially identical in appearance and function. See below for an example MOD page:

```

editchainfxmods1
Box# Param# Adjust# Source# Depth#
Box2 Wet/Dry 6%Wet MIDI28 26%Wet
Box2 Rvrb Time 3.40s MIDI27 -1.60s
None OFF
None OFF
None OFF
more MAIN Insert Remove MOD1 more

```

Box

The Box parameter specifies which effect-box in the Chain to which the Mod will be applied.

Param

The Param parameter selects which parameter of the specified box's effect will be modulated.

Adjust

The Adjust parameter sets a fixed value for the specified parameter (Param) that is applied before any modulation.

Source

The Source parameter determines the Control source that will modulate the parameter (Param) in real-time. This can be any of the normal channel Control sources (sliders, mod wheel, pedals, etc.) or one of the Chain-specific Control sources (FXLFOs, FXASRs, and FXFUNs).

Depth

The Depth parameter determines the range of modulation that the Controller will apply. When the Control source has a value of 0, the parameter's (Param's) value will be the Adjust value. When the control source is all the way up, the parameter's (Param's) value will be the Adjust value plus the Depth value.

FXLFO, FXASR, and FXFUN pages

The FXLFO, FXASR, and FXFUN pages are the pages from which you edit the Effects-only Control sources. These are Control sources that can be used by the effects Mods in the current Chain. The parameters on these pages work exactly like those of the corresponding Control sources in program mode (see *The LFO Page* on page 6-38, *The ASR Page* on page 6-40, and *The Function (FUN) Page* on page 6-41 in Chapter 6, *Program Mode*).

INFO

Press the INFO soft button to go to the INFO page where you can edit the controller assignment info for the current Chain. Info allows you to add a description for each FX Mod you have assigned. When a Program or Setup uses a Chain that has been stored with info, you can view the info by pressing the Info soft button on the Program mode or Setup mode main pages. This allows you to easily view which Chain parameters are controlled by which assigned physical controllers or MIDI CC numbers.

On the INFO page, use the **Chan/Layer** buttons to scroll through the current Chain's list of controller assignment info. Each assignment info entry has a MIDI controller number and a Text parameter to describe what the assignment controls. One info entry can be made for each MIDI CC number.

To edit the text of a controller assignment, press the **Text** soft button. To create a new controller assignment info entry, press the **New** soft button (you will be prompted for a MIDI controller number.) To create a new controller assignment info entry with the same text as the current info entry, press the **Dup** soft button (you will be prompted for a new MIDI controller number, only one info entry can be made for each MIDI CC number.) To delete the current controller assignment info entry, press the **Delete** soft button (you will be prompted to confirm or cancel.) To return to the Chain editor press the **Done** soft button or the **Exit** button. See *Export* on page 13-15 for details on exporting Chain info.

Effects Parameters

This section contains descriptions of the PC3K's many effects parameters, and instructions on how to use them. Read through this section to get a good general understanding of the parameters.

The descriptions here do not include all of the parameters associated with every effect, and some effects may not have some of the parameters described here for their category. A more complete reference, with every effect and the meaning and range of every parameter, arranged in the order they appear on the screen, can be found in the *KSP8 Algorithm Reference Guide* on the Kurzweil website, www.kurzweil.com.

General Parameters

There are a number of parameters that are common to all or almost all effects, and we'll deal with those first.

Wet/Dry balances the levels of the processed and unprocessed signals output from the effect. Wet represents the processed signal, while dry represents the unprocessed signal. The range is 0% wet (the signal is unprocessed) through 100% wet (no dry signal is present). Values between 0% and 100% blend the two signals, for example, at 20% the output signal is 20% wet (processed) and 80% dry (unprocessed.) A setting of 50% wet means the dry and processed signals are roughly equal in level. In some effects, separate Wet/Dry parameters are provided for the Left and Right input channels. In some cases, this parameters can have negative values, which indicate that the Wet signal is polarity-inverted.

When an effect with the Wet/Dry parameter is used in Chain that has been selected as an Aux effect, Wet/Dry is automatically set to 100% wet and cannot be adjusted. This is because when using an Aux effect, the dry signal is already effectively at 100% on the main audio bus (not routed through the Aux effect.) In this case, turning up the Aux send level will blend the 100% wet signal (from the Aux bus) with the dry signal on the main audio bus.

Out Gain sets the gain at the output of an effect.

In/Out enables or disables the effect. You can think of it as a Wet/Dry parameter with only two positions: 100% (In) and 0% (Out).

HF Damping (high frequency damping) is the cutoff (-3 dB) frequency of a 6dB/octave lowpass filter that's inserted before the processor. High frequencies above the set cutoff frequency will be filtered out. In the case of processors where multiple iterations of the signal are heard, such as in a delay, each iteration of the signal will pass through the filter, and will therefore be duller.

XCouple (Cross Couple). In stereo effects, this controls how much of any signal being fed back is going to the channel *opposite* to the one where it first appeared. At 100%, all feedback from signals at the left input goes to the right channel and vice versa, causing a "spreading" or in the case of delay lines, a "ping-pong" effect. At 0%, fed-back signals stay with the channel they came in on.

A->B cfg (configuration). In combination effects that contain two (or more) components, the order in which the signal passes through the two components can be changed with this parameter. Combination effects are usually named with a "->", as in 484 "Flange->Shaper". For example, 484 "Flange->Shaper" can be configured so the signal passes through the flanger first and then the shaper, or through the shaper first and then the flanger. The **cfg** parameter determines the configuration, and its value is context-sensitive—in this example, the choices would be "Fl->Shp" and "Shp->Fl".

A/Dry->B is also found in many combination effects, and controls the amount of signal that will pass dry (unprocessed) through the first component into the second component. Different

combination effects use different variations on this parameter, depending on the context. The range is 0 to 100%.

Reverbs

Room Type changes the configuration of the effect to simulate a wide array of room types and sizes including booths, small rooms, chambers, halls and large spaces. Because this parameter changes the structure of the reverb effect, you need to be careful when assigning it a MOD—changing it in real time while signal is passing through it is likely to cause audible artifacts. Room types in different effects with similar names do not necessarily sound the same.

Rvrb Time is the RT_{60} —the time it takes for the reverb to decay to 60 dB below its initial level—in seconds. It is accurate assuming that several other parameters (HF Damping, Diff Scale, Size Scale, and Density) are at their nominal levels. It is adjustable up to “Inf”, which creates an infinitely-sustaining reverb.

LateRvbTim adjusts the basic decay time of the late portion of the reverb after diffusion.

L Pre Dly and **R Pre Dly** (Pre-Delay) is the time between the start of a sound and the output of the first reverb reflections from that sound. Longer pre-delays can help make larger spaces sound more realistic. Longer times can also help improve the clarity of a mix by separating the reverb signal from the dry signal, so the dry signal is not obscured. You can set a separate time for the left and right reverb signals using L Pre Dly and R Pre Dly.

EarRef Lvl adjusts the mix level of the early-reflection portion of effects which offer early reflections.

Late Lvl adjusts the mix level of the late-reverb portion of effects which offer early reflections.

Diff Scale scales the “diffusion” of the early reflections, that is, how spread out they are as a group over time. At very low settings, the early reflections start to sound quite discrete, and at higher settings the early reflections are seamless. It is adjustable from 0.00 to 2.00, with 1.00 being nominal for the given Room Type.

Density controls how tightly the early reflections are packed in time. Low Density settings group the early reflections close together, while higher values spread the reflections for a smoother reverb. It is adjustable from 0.00 to 4.00, with 1.00 being nominal (and usually optimal) for the given Room Type.

Expanse controls the amount of late reverb energy biased toward the edges of the stereo image. A setting of 0% will bias energy towards the center. Moving away from 0% will bias energy towards the sides. Positive and negative values will have a different character.

Build adjusts the envelope of certain portions of the reverb. Positive values speed up the envelope, and negative values slow it down.

Size Scale changes the size of the current room. Altering this parameter will change the reverb time and also cause some coloration of the reverb. It is adjustable from 0.00 to 4.00, with 1.00 being nominal (and usually optimal) for the given Room Type.

InfinDecay, when turned “On”, causes the reverb tail to decay infinitely. When it’s “Off”, the decay time is determined by the “Rvrb Time” or “LateRvbTim” parameters. This is a good parameter to control with a footswitch.

Wet Bal (Wet Balance). Some reverb effects are actually two stereo reverbs in one, with each one receiving a different mono signal. This balances the outputs of the two reverbs—0% means they are being mixed equally.

Delays

There are two types of taps in the Multitap delays: The “Loop” tap, which has a feedback loop back to its input, and the numbered taps. The numbered taps can be single iterations or they can repeat as part of a loop, but they do not have individual feedback paths.

Fdbk (Feedback) **Level** controls the repeating function of the Loop Tap. A setting of 0% means there will only be a single delay, while a setting of 100% means the signal keeps repeating without ever stopping.

Both types of taps are individually adjustable from 0 to 2.55 seconds. The **Loop Crs** and **Tap n Crs** (n being the number of the tap) parameters set the coarse value of the loop in 20-ms increments, while the **Loop Fine** and **Tap n Fine** parameters set the fine value in 0.2-ms increments.

In Delay effects that use tempo to determine tap lengths, there is a **Tempo** parameter which can be set from 1 to 255 BPM or to “System”. The **Loop Length** and **Tap n Delays** are then expressed in beats relative to that overall Tempo.

Hold is a switch that, when turned on, “locks” any signal currently in the delay and plays it until Hold is turned off. When Hold is on, no signal can enter the delay and Feedback is set to 100%. A good parameter to control with a footswitch.

Dry Bal (Balance) is the left/right balance of the dry signal. At -100%, only the left dry signal goes to the left output, while at 100% only the right dry signal passes to the right output, and at 0%, equal amounts of the left and right dry signals pass to their respective outputs.

Tap n Level is the level of each numbered tap, from 0% to 100%, relative to the overall output of the effect.

Tap n Bal is the left/right balance of each of the numbered taps. At -100%, only the left channel of tap n goes to the left output, while at 100% only the right channel of tap n goes to the right output. At 0%, equal amounts of the left and right channels of the tap pass to their respective outputs. In some delays, pairs of taps (1 and 5, 2 and 6, etc.) are controlled together as stereo pairs.

DelayScale lets you change the lengths of all the taps together. Its range is 0 to 10x.



Note: It is possible for the PC3K to run out of delay memory with over-generous settings of DelayScale or very slow Tempos. Some Delay effects will simply go to a maximum value and stay there, while in some, a calculation is made that automatically cuts the delay times in half, thereby maintaining a relationship with tempo.

Complex Echo

This effect has two feedback taps per channel as well as three independent taps, and also a feedback diffuser for “smearing” the delays. Feedback line 1 feeds the signal back to the delay input of the same channel, while feedback line 2 feeds the signal back to the opposite channel.

FB2/FB1>FB is a balance control between feedback lines 1 and 2. 0% (minimum) turns off feedback line 2, only allowing use of feedback line 1. 50% is an even mix of both lines, and 100% (maximum) turns off line 1.

L Diff Dly and **R Diff Dly** adjusts the delay lengths of the diffusers. Range is 0 to 100 ms.

Diff Amt adjusts the diffuser intensity. Range is 0 to 100%.

C Fdbk n Dly adjusts the delay length of the C channel’s n th feedback tap, fed back to the C channel’s delay input. Range is 0 to 2600 ms.

Spectral Multitap Delays

These 4- and 6-tap delays have their feedback and output taps modified with shapers and filters. In the feedback path of each tap are a diffuser, hipass filter, lopass filter, and imager. Each delay tap has a shaper, comb filter, and balance and level controls.

Fdbk Image sets the amount that the stereo image is shifted each time it passes through the feedback line. Range is -100 to 100%.

Tap *n* Shapr adjusts the intensity of the shaper at each output tap. Range is 0.10 to 6.00 x.

Tap *n* Pitch adjusts the frequency of the comb filter at each output tap. Range is C-1 to C8, in semitones.

Tap *n* PtAmt adjusts the intensity of the comb filter at each output tap. Range is 0 to 100%.

Gated Ducking Delay

This runs the last thing you played through a looping delay, but only outputs the delay signal when you aren't playing. Gated Ducking Delay is great for that announcer sound, sound, sound, so popular in Monster Truck radio spots.

DegenRegen

This one's a big looping delay with lots of gain, distortion and filtering, and with a compressor to keep it all under control.

Equalizers (EQ)

The PC3K has both Graphic and Parametric EQ effects. Parametric EQ sections are also found on a number of combination effects.

The **Graphic** equalizer is available as stereo (linked parameters for left and right) or dual mono (independent controls for left and right). It has 10 bandpass filters per channel, each of whose gain is adjustable from -12 dB to +24 dB.

Like all graphic equalizers, the filter response is not perfectly flat when all gains are set to the same level (except at 0 dB), but rather has ripple from band to band. To minimize this ripple, it is best to center the overall settings around 0 dB.

The **Parametric** equalizer ("5-Band EQ") has two bands of shelving filters and three bands of true parametric EQ.

Treb Freq and **Bass Freq** set the center frequencies for the shelving filters. Both of these are adjustable over the full range of 16 to 25088 Hz, in increments of a semitone.

Treb Gain and **Bass Gain** control the amount of cut or boost above (Treb) or below (Bass) the center frequency. The range is -79 to +24 dB.

Mid*n* Gain sets the cut or boost for the parametric band *n*, with a range of -79 to +24 dB.

Mid*n* Freq sets the center frequency for parametric band *n*, with a range of 16 to 25088 Hz, in increments of a semitone.

Mid*n* Width set the bandwidth of the filter on band *n*, with a range of 0.01 to 5 octaves.

Enhancers

Enhancers modify the spectral content of the input signal by boosting existing spectral content, or stimulating new ones. Two and three-band versions are provided.

Drive adjusts the input into each band. Increasing the drive will increase the effects. Range is -79.0 to 24.0 dB.

Xfer adjusts the intensity of the transfer curves. Range is -100 to 100%.

EQ Morpher

This effect uses two four-band bandpass filters, A and B, and moves between them. This can produce very convincing human vocal type sounds.

FreqScale offsets the filter frequencies for each set of filters. After setting the filter parameters (**Freq**, **Gain**, and **Width**), the FreqScale parameters will move each of the four filter frequencies together by the same relative pitch. Range is -8600 to 8600 cents.

Morph A>B. When set to 0% the “A” parameters are controlling the filters, and when set to 100%, the “B” parameters control the filters. Between 0 and 100%, the filters are at interpolated positions. When morphing from A to B settings, the A filter #1 will change to the B filter #1, A filter #2 moves to B filter #2, and so on. Range is 0 to 100%.

Compressors, Expanders, and Gates

A wide range of Compression and Expansion effects is available in the PC3K. The various effects include different combinations of:

- compressors with soft-knee characteristic—the compression action comes in gradually as the signal level approaches the threshold
- compressors with hard-knee characteristic—the compression action comes in abruptly when the signal reaches the threshold
- expanders
- multiband compressors that break the signal up into three frequency bands and compress them all separately
- sidechains or output EQs
- reverbs and compressors in combination
- gates
- gated reverbs

All of the Compression effects use these parameters:

FdbkComprs (Feedback Compression) selects whether to use feed-forward (set this to “Out”) or feed-back (set this to “In”) compression. The feed-forward configuration uses the input signal as a side-chain source, which is useful when the compressor has to act really quickly. The feed-back configuration uses the compressor *output* as the side-chain source, which lends itself to more subtle, but not as quick-reacting, compression.

Atk (Attack) **Time** for the compressor is adjustable from 0.0 to 228.0 ms.

Rel (Release) **Time** for the compressor is adjustable from 0 to 3000 ms.

SmoothTime smooths the output of the expander’s envelope detector by putting a lowpass filter in the control signal path. Smoothing will affect the Attack or Release times only when this parameter is longer than one of the other times. The range is 0.0 to 228.0 ms.

Signal Dly (Delay) puts a small delay in the signal relative to the sidechain processing, so that the compressor (or gate) “knows” what the input signal is going to be before it has to act on it.

This means the compression can kick in before an attack transient arrives. In the `SoftKneeCompress` and `HardKneeCompress` effects, delay is really only useful in feed-forward configuration (`FdbkComprs` is “Out”). For other compressors, the delay can be useful in feedback configuration (`FdbkComprs` is “In”). The range is 0 to 25 ms.

Ratio is the amount of gain reduction imposed on the compressed signal, adjustable from 1.0:1 (no reduction) to 100:1, and Inf:1.

Threshold is the level in dBFS (decibels relative to full scale) above which the signal begins to be compressed. Adjustable from -79.0 to 0 dB.

MakeUpGain allows additional output gain to compensate for gain reduction in the compressor. It is essentially the same parameter as `Out Gain`, with which it is summed. The minimum is -79.0, and the maximum summed gain (`MakeUpGain` + `Out Gain`) is +24.0 dB.

Expansion

Effects containing Expanders have these controls:

Atk or **Exp Atk** (Attack), how fast the expander turns off when the input signal rises above the threshold level, adjustable from 0.0 to 228.0 ms.

Rel or **Exp Rel** (Release), how fast the expander turns back on after the signal drops below the threshold level, adjustable from 0 to 3000 ms.

Ratio or **Exp Ratio**, how much the gain is reduced below the expansion threshold, adjustable from 1:1.0 (no expansion) to 1:17 (extreme downward expansion).

Threshold or **Exp Threshold**, the level below which the signal is expanded, adjustable from -79.0 to 0 dB.

In addition, the two-segment compressors with expander have separate **Ratio** and **Threshold** controls for each of the compression segments.

Multiband Compression

The Multiband Compression effect has **Attack**, **Release**, **Smooth**, **Signal Delay**, **Ratio**, **Threshold**, and **MakeUp Gain** parameters for each of the three bands (“Low”, “Mid”, and “High”). In addition, it has:

Crossover1 and **Crossover2**. These set the frequencies which divide the three compression frequency bands. The two parameters are interchangeable, so either may contain the higher frequency value. The range is 16 to 25088 Hz, in increments of a semitone.

Gates

SC Input lets you select which input channel(s) will control the sidechain, which is responsible for opening and closing the gate. It can be set to L, R, or the average of the two channels, (L+R)/2. You can use this, if you arrange the signal paths and pan controls appropriately, to gate one mono signal with a different mono signal.

Gate Time is the time that the gate will stay open after the sidechain signal reaches the Threshold. Its range is 0 to 3000ms.

Ducking reverses the action of the gate. Normally this is set to “Off”, and the gate opens when the input signal rises above the threshold. But when this is “On”, the gate *closes* when the input signal rises above the threshold.

Atk Time (attack time) is the time for the gate to ramp from closed to open (reverse if Ducking is on) after the signal rises above threshold, adjustable from 0.0 to 228.0 ms.

Rel Time (release time) is the time for the gate to ramp from open to closed (reverse if Ducking is on) after the gate timer has elapsed, adjustable from 0 to 3000 ms.

Super Gate

Super Gate is a more sophisticated gate that includes these two functions:

Env Time is the amount of time it takes for the sidechain signal envelope to drop below the threshold. If this time is too short, the gate can close and open too quickly from amplitude modulation in the sidechain signal. If it is too long, the gate may stay closed until the envelope has a chance to fall, and some signals would not get through. This parameter is only in effect when **Retrigger** is Off.

Retrigger determines whether the gate timer will reset itself each time the sidechain signal goes above the threshold. If it is "On", the timer resets itself, and therefore the gate stays open as long as the signal is above the threshold, or keeps going above the threshold, within the interval specified by **Gate Time**. If it is "Off", the gate closes down after **Env Time** has elapsed, regardless of the sidechain level, and the sidechain level must fall below the threshold and come back up again before the gate will open again.

Chorus

Chorus is an effect which gives the illusion of multiple voices playing in unison. The effect is achieved by detuning copies of the original signal and summing the detuned copies back with the original. Low frequency oscillators (LFOs) are used to modulate the positions of output taps from a delay line. The movement of the taps causes the pitch of the signal to shift up and down, producing the required detuning.

The choruses are available as stereo or dual mono. The stereo choruses have the parameters for the left and right channels ganged, while the dual mono choruses have separate left and right controls.

Fdbk Level is the level of the feedback signal from the LFO1 delay tap into the delay line. Negative values polarity-invert the feedback signal.

Tap Lvl sets the levels of the LFO-modulated delay taps. Negative values polarity-invert the signal. Setting any tap level to 0% turns it off.

Tap Pan sets the stereo position for a given tap's output. The range is -100% for fully left, to 100% for fully right.

LFO Rate sets the speed of modulation of the delay lines with a range of 0.01 to 10 Hz.

LFO Dpth sets the maximum detuning depth of the LFO-modulated delay lines, with a range from 0 to 50 cents (= 1/2 semitone).

Tap Dly adds extra delay in front of the LFO modulated delay taps from 0 to 230 ms.

L/R Phase or **LFO n LRPhs** adjusts the relative phases of the LFOs for the left and right channels in the stereo Choruses.

Flanger

Flanging is the process of adding or subtracting a signal with a time-displaced replica of itself, which results in a series of notches in the frequency spectrum, generally referred to as a comb filter. In the PC3K, the flanger is a multi-tap delay line, all (but one) of whose taps can have their lengths modulated up and down by a low frequency oscillator (LFO). The rate of the LFO is expressed in Tempo.

StatDlyLvl (Static Delay Level) is the level of the first, non-moving tap. Negative values invert the polarity of the tap. The range is -100 to 100%; 0% turns the tap off.

DlyCrs and **DlyFin** are the coarse and fine length controls for the Static delay (**StatDly...**) and for the minimum value of the moving delays (**Dlyn...**). The coarse range is 0 to 228 ms, and the fine range adjusts the coarse range in samples ($= 1/48,000 \text{ sec} = 20.8\mu\text{sec}$) from -127 to 127.

Xcurs Crs and **Xcurs Fin** determine how far the LFO-modulated delay taps can move from the center of their ranges. The total range of the LFO sweep is twice the excursion. If the excursion is set to 0, the LFO does not move and the tap behaves like a simple delay line set to the minimum delay. The coarse range is 0 to 228 ms; the range 0 to 5 ms is most effective for flanging. The fine range adjusts the coarse range in samples from -127 to 127.

Quantize

This effect produces digital distortion known as quantization noise, by limiting the number of bits available to the signal. See effect 329 "Aliaser".

DynamRange (dynamic range) controls how many bits to remove from the signal data words. The lower the level, the greater the distortion. At 0 dB the hottest of signals will toggle between only two quantization levels, thereby producing a square wave. Every 6 dB added doubles the number of quantization levels, reducing the noise and getting closer to the original signal. If the signal has a lot of headroom (available signal level before digital clipping), then not all quantization levels will be reached. Range is 0 to 144 dB.

Headroom sets the available signal level before digital clipping. Setting this properly prevents the signal from getting too loud at low levels of **DynamRange**. You want to have it match the amount of level still available above the input signal: this is done by finding the **DynamRange** level at which the signal starts getting louder, and setting **Headroom** to match the **DynamRange** value. Range is 0 to 144 dB.

DC Offset adds a positive DC Offset to the input signal, which allows you to alter the position where digital zero is with respect to your signal. At low **DynamRange** settings, this can cause the output to "sputter". Range is Off/-79.0 to 0.0 dB.

LaserVerb

LaserVerb is a type of reverb which produces a delayed train of closely spaced reflections, or impulses. As time passes, the spacing between the impulses gets wider, which creates a discernible buzzy pitch that gets lower as the spacing increases. The signal can be fed back into itself to extend the effect.

Dly Coarse is the overall delay length, which controls the duration or decay time. 0.5 sec is a good starting point. Range is 0 to 1.3 seconds in the 2 DSP unit version of the effect, and 0 to 2 seconds in the 3 DSP unit version.

Dly Fine adjusts the delay with a resolution down to 0.2 ms. Range is -20.0 to 20.0 ms.

Spacing determines the starting pitch of the descending buzz and how fast it descends, by setting the initial separation of impulses and the subsequent rate of increasing impulse

separation. The spacing between impulses is given in samples (20.8 μ s). At low values, the buzz starts at high frequencies and drops slowly, while at high values the buzz starts at a lower pitch and drops rapidly. Range is 0.0 to 40.0 samples, with a resolution of 0.2 sample.

Contour controls the overall shape of the reverb. When set to a high value, sounds passed through the reverb start at a high level, and it slowly decays. As the control value is reduced, it takes more time for the effect to build up before decaying. At a value of around 34%, the reverb behaves like a reverse reverb, building up to a hit. When it is set to zero, the effect acts like a simple delay. Range is 0 to 100%.

Filters

There are four types of Resonant Filter effects in the PC3K. All of them have these parameters in common:

Filter Type (or **FiltType**) can be Lowpass, Highpass, Bandpass, or Notch (band-cut).

Resonance is the resonance of the filter, adjustable from 0 to 50 dB.

Resonant Filter

Frequency (or **Freq**) is the fixed resonant frequency of the filter. Its range is 16 to 8372 Hz.

Envelope Filter

Envelope Filter is a resonant filter whose center frequency can be made to vary according to the level of the incoming signal.

Filter Type can be Lowpass, Highpass, Bandpass, or Notch (band-cut).

Min Freq is the minimum resonant frequency of the filter, that is, the filter frequency when the input gain is below the triggering threshold. Its range is 16 to 8372 Hz.

Sweep determines how far the resonant frequency moves when the input level increases. At positive levels it moves up in pitch, and at negative levels it moves down. The highest possible resonant frequency is 8372 Hz, the lowest is 0 Hz. This parameter's range is -100% to +100%.

Resonance is the resonance of the filter, adjustable from 0 to 50 dB.

Atk Rate adjusts the upward slew of the attack portion of the envelope detector. Range is 0 to 300.0 dB/sec.

Rel Rate adjusts the downward slew of the release portion. Range is 0 to 300.0 dB/sec.

Smooth Rate slows down the envelope follower. If it is set to a lower rate than **Atk Rate** or **Rel Rate**, it can dominate those parameters. Range is 0 to 300.0 dB/sec.

Triggered Filter

The Triggered Filter is a sweeping resonant filter that triggers when a certain input threshold is reached, and then follows its *own* envelope, consisting of an instantaneous attack and an exponential release, rather than the envelope of the input signal.

Max Freq is the resonant frequency of the filter at the peak of the internal envelope. It can be set lower than **Min Freq** (above), in which case the filter will sweep downwards, then back up. Range is 16 to 8372 Hz.

Trigger is the input-signal threshold at which the envelope detector triggers. Range is -79 to 0 dB.

Retrigger is the input-signal threshold at which the envelope detector resets, so that it can trigger again. This parameter is only useful when it is set below the value of Trigger. Range is from -79 to 0 dB.

Env Rate is the envelope detector decay rate. This can be used to prevent false triggering. When the signal envelope falls below the retrigger level, the filter can be triggered again when the signal rises above the trigger level. Since the input signal can fluctuate rapidly, it is necessary to adjust the rate at which the signal envelope can fall to the retrigger level. The range is 0 to 300.0 dB/sec.

Rel Rate is the downward slew (release) rate of the triggered envelope generator. The range is 0 to 300.0 dB/sec.

Smth Rate slows down the envelope follower. If set lower than the release rate, it will dominate it. You can also use the smoothing rate to lengthen the attack of the internal envelope. The range is 0 to 300.0 dB/sec.

LFO Filter

The LFO filter is continuously swept between two resonant frequencies over a period of time. The LFO frequency, expressed in BPM and beats, can be fixed or set to follow **System** tempo.

Min Freq and **Max Freq** are the low and high limits of the resonant frequency as the filter is swept. You can set the Min Freq higher than the Max Freq, in which case the filter will sweep “upside down” relative to the controlling clock. The range for both is 16 to 8372 Hz.

LFO Shape is the waveform type for the LFO. Choices are Sine, Saw+, Saw-, Pulse, and Tri.

LFO PlsWid (Pulse Width). When the LFO Shape is set to Pulse, this sets the pulse width as a percentage of the waveform period. When the width is set to 50%, the result is a square wave. This parameter has no effect if other waveform types are chosen. Range is 0 to 100%.

LFO Smooth smooths (removes the higher harmonics from) the Saw+, Saw-, and Pulse waveforms. A Sawtooth wave becomes more like a triangle wave, and a Pulse wave becomes more like a sine wave. Range is 0 to 100%.

Distortion

Distortion effects on the PC3K may also include a parametric equalizer or a cabinet simulator.

Dist Drive applies a boost to the input signal to overdrive the distortion effect into soft clipping. This will tend to make the signal very loud, so you may have to reduce the Out Gain as this parameter is increased. Range is 0 to 96 dB.

Warmth is a lowpass filter in the distortion control path. This filter may be used to reduce some of the harshness of some distortion settings without reducing the bandwidth of the signal. Range is 16 to 25088 Hz.

Highpass allows you to reduce the bass content of the distortion content in the smaller distortion effects that don't have true parametric EQ. Range is 16 to 25088 Hz.

Cab Preset selects from eight cabinet simulations which have been created based on measurements of real guitar amplifier cabinets. The presets are: Basic, Lead 12, 2x12, Open 12, Open 10, 4x12, Hot 2x12, and Hot 12.

Cab Bypass switches on and off the cabinet-simulation part of the effect. When this is set to “In”, the cabinet simulation is active; when it is “Out”, there is no cabinet action.

Cabinet HP and **Cabinet LP** are highpass and lowpass filters to set the frequency response limits of the cabinets. Range of both filters is 16 to 25088 Hz.

Polydistort

This is a more complex distortion effect that provides two, four, or six stages of distortion.

Curve *n* controls the curvature of the individual distortion stages. 0% is no curvature (no distortion at all). At 100%, the curve bends over smoothly and becomes perfectly flat right before it goes into clipping. Maximum value is 127%.

LP *n* Freq are shelving frequencies for one-pole lowpass filters on each of the distortion stages. LP0 Freq handles the initial low pass prior to the first distortion stage. The other low pass controls follow their respective distortion stages. Range is 16 to 25088 Hz.

Rotating Speakers

An effect that includes Rotating Speakers breaks the signal into two frequency bands, “rotates” each band separately through a virtual speaker, and then combines the outputs with a pair of virtual “microphones” whose angle relative to the speakers is adjustable. A number of very sophisticated parameters have been included in the Rotating Speakers effect, to give the effect a great degree of realism. Because of the complexity of the effects, you might want to approach any parameters that seem a little obscure to you with caution.

Roto InOut engages or bypasses the rotary speaker effect.

There are four virtual microphones, with two each on the woofer (**LoMic A** and **LoMic B**) and on the tweeter (**HiMic A** and **HiMic B**). Each microphone has:

Pos (position), the angle of the microphone from the front of the virtual speaker, from -180 to 180 degrees;

Lvl (level) from 0 to 100%; and

Pan, the left/right panning of the microphone’s output, from -100% (full left) to 100% (full right).

Other parameters:

Lo Beam W and **Hi Beam W** set the acoustic radiation patterns (“beam width”) of the two drivers in the rotating speaker. If you imagine looking down on the rotating speaker, this is the angle between the -6 dB levels of the beam. The range is from 45° to 360°. At 360°, the driver is omnidirectional.

Xover (Crossover) is the frequency at which high and low frequency bands are split and sent to separate rotating drivers. The range is 16 to 25088 Hz.

Lo Gain and **Hi Gain** are the gains of the signal passing through the rotating woofer or tweeter, respectively. The range is Off/-79.0 to 24.0 dB.

Lo Size and **Hi Size** are the effective sizes (radius of rotation) of the rotating speakers in millimeters. This affects the amount of Doppler shift or vibrato of the low frequency signal. The range is 0 to 250 mm.

Lo Trem and **Hi Trem** control the depth of tremolo (amplitude modulation) of the signals. It is expressed as a percentage of full scale tremolo. The range is 0 to 100%.

LoResonate and **HiResonate** are simulations of cabinet resonant modes expressed as a percentage. For realism, you should use very low settings. The range is 0 to 100%.

Lo Res Dly and **Hi Res Dly** are the number of samples of delay in each resonator circuit in addition to the rotation excursion delay. The range is 10 to 2550 samples.

LoResXcurs and **HiResXcurs** are the number of samples of delay to sweep through the resonator at the rotation rate of each rotating speaker. The range is 0 to 510 samples.

ResH/LPhs sets the relative phases of the high and low resonators. The angle value in degrees is somewhat arbitrary and you can expect the effect of this parameter to be rather subtle. The range is 0 to 360.0 degrees.

Mic Angle is the angle of the virtual microphones in degrees from the "front" of the rotating speaker. For the left microphone the angle increases clockwise (when viewed from the top), while for the right microphone the angle increases counter-clockwise. Assigning a MOD to this parameter should be done with caution: real-time adjustments to it will result in large sample skips, which will cause clicks in the signal passing through. The range is 0 to 360.0 degrees. (In **Distort + Rotary** only.)

The following parameters relate to rotation speed:

Speed sets the rotating speakers to run at either the slow rate or the fast rate.

Brake, when set to "On", slows the rotating speakers to a halt.

Lo Mode, in the "Normal" setting, will give you full control of the low frequency speaker with the Speed parameter. The "NoAccel" setting will hold the low frequency speaker at the slow speed, and the Speed parameter will have no effect on its speed, though Brake will still work. In the "Stopped" position, the low frequency speaker will not spin at all.

Lo Slow and **Hi Slow** are the rotation rates in hertz (Hz) of the speakers when Speed is set to "Slow".

Lo Fast and **Hi Fast** are the rotation rate in hertz (Hz) of the speakers when Speed is set to "Fast".

LoSlow>Fst and **HiSlow>Fst** are the times for the speakers to accelerate from the slow speed to the fast speed.

LoFst>Slow and **HiFst>Slow** are the times for the speaker to decelerate from the fast speed to the slow speed.

LoAccelCrv and **HiAccelCrv** are the shapes of the acceleration curves for the speakers. 0% is a constant acceleration. Positive values cause the speaker to speed up slowly at first then quickly reach the fast rate. Negative values cause a quick initial speed-up then slowly settle in to the fast speed. If set to a low negative value, it will overshoot.

LoSpinDir and **HiSpinDir** are the directions of rotation of the speakers. The choice is clockwise (CW) or counter-clockwise (CCW).

Vibrato/Chorus

The Vibrato/Chorus effect simulates the vibrato and chorus effects on a tone wheel organ, and is used in conjunction with the Rotary Speaker. It has several unique parameters:

VibChInOut is an in/out switch for the Vibrato/Chorus effect.

Vib/Chor is the type of Vibrato/Chorus effect to be used. The choices are from three vibratos, "V1", "V2", "V3", or three choruses, "C1", "C2", "C3".

Tremolo and AutoPan

Tremolo is amplitude modulation using an LFO. AutoPan moves the signal between the left and right channels, using an LFO. They have several parameters in common and several unique ones.

LFO Rate is the rate of the LFO. The range is 0 to 10.00 Hz, or 0 to 12.00 x the tempo.

Rate Scale multiplies the speed of the LFO rate into the audio range. The range is 1 to 25088 x. When above 16x, the values increment in semitone steps. When the LFO Rate is set to 1.00 Hz, the value of this parameter is equal to the LFO frequency in Hertz.

LFO Shape is the waveform type for the LFO. Choices are Sine, Saw+, Saw-, Pulse, and Tri.

LFO PlsWid or **Pulse Width**. When the LFO Shape is set to Pulse, this sets the pulse width as a percentage of the waveform period. When the width is set to 50%, the result is a square wave. This parameter has no effect if other waveform types are chosen. Range is 0 to 100%.

AutoPan

Origin determines the axis for the panning motion. At 0%, the panning is centered between the speakers. Positive values shift the axis to the right, while negative values shift it to the left. At -100% or +100% (the range limits), there is no panning action.

ImageWidth is the width of the original input program material before it is auto-panned. At 0% (minimum), the input image is shrunk to a single point source, allowing maximum panning excursion. At 100% (maximum), the original width is maintained so no panning can occur.

Pan Width controls the amount of pan excursion. It is the percentage of total panning motion available after Origin and ImageWidth are set. Range is 0 to 100%.

CentrAtten (Attenuation) is the amount the signal level drops as it is panned through the center of the stereo image. For the smoothest tracking, a widely accepted subjective reference is -3dB. Values above -3dB will cause somewhat of a bump in level as an image passes through the center, while values below -3dB will cause a dip. Range is -12 to 0 dB.

Tremolo

Depth controls the amount of attenuation applied when the LFO is at its deepest excursion point. Range is 0 to 100%.

LFO Phase shifts the phase of the tremolo LFO relative to the beat reference. Range is 0.0 to 360.0 degrees.

50% Weight is the relative amount of attenuation added when the LFO is at the -6dB point. This causes the LFO shape to bow up (positive values) or down (negative values). Range is -16 to 3 dB.

L/R Phase sets the phase relationship of the channels. "In" flips the left channel's LFO out of phase, with the result that the effect turns into an auto-balancer. "Out" leaves the left LFO alone.

Pitcher

Pitcher applies a filter to the input signal which has a series of peaks in the frequency response. These peaks are normally adjusted so that their frequencies are all multiples of a specific, selectable frequency, which imposes a strong sense of pitch at the selected fundamental frequency.

Pitch. The fundamental pitch imposed upon the input, in MIDI note numbers from C-1 to G9.

Ptch Offst is an offset from the pitch frequency in semitones, from -12.0 to 12.0. It can be useful to assign pitch bend, a ribbon, or another continuous controller to this parameter through a MOD.

Odd Wts, Pair Wts, Quartr Wts, Half Wts are parameters that control the shape of the frequency response of Pitcher. An exact description of what each one does is, unfortunately, impossible, since there is a great deal of interaction between them. For more information and examples, see the *KSP8 Algorithm Reference Guide* available as a free download at www.kurzweil.com.

Ring Modulation

Ring modulation multiplies two signals (the “carrier” and the “modulator”) together to produce unusual, often non-harmonic, overtones. The Ring Modulator effect in the PC3K has two modes: “**L*R**” in which two mono signals are modulated together; and “**Osc**”, in which the input is stereo, and it is modulated with the sum of five waveforms that are generated from oscillators within the effect itself. Four of these oscillators are sine waves, while one (Oscillator 1) offers a selection of waveforms.

Wet/Dry. When the effect is in “L*R” mode, this controls how much of the left signal only is passed dry (the right signal isn’t passed dry at all).

Mod Mode selects between the two modes.

Osc1 Lvl is the level of Oscillator 1, from 0 to 100%.

Osc1 Freq is the frequency of Oscillator 1, from 16 to 25088 Hz.

Osc1 Shape is the waveshape of Oscillator 1, selectable from Sine, Saw+, Saw-, Pulse, and Tri.

Osc1PlsWid (Pulse Width). When **Osc1 Shape** is set to Pulse, this sets the pulse width as a percentage of the waveform period. When the width is set to 50%, the result is a square wave. This parameter has no effect if other waveform types are chosen. Range is 0 to 100%.

Osc1Smooth smooths (removes the higher harmonics from) the Saw+, Saw-, and Pulse waveforms. A Sawtooth wave becomes more like a triangle wave, and a Pulse wave becomes more like a sine wave. Range is 0 to 100%.

The other four oscillators, **Sine2** through **Sine5**, each have **Lvl** and **Freq** controls.

Stereo Simulation

The Mono to Stereo effect converts a monaural input to simulated stereo output.

In Select selects the input signal to be “stereo-ized”. It can be Left, Right, or both: (L+R)/2.

CenterGain is the level of the summed left and right channels. Range is Off/-79.0 to 24.0 dB.

Diff Gain is the level of the difference signal produced, which is the spatial component of the stereo signal. Range is Off/-79.0 to 24.0 dB.

DiffBassG controls the gain of a bass-shelf filter on the difference signal. By boosting the low frequency components of the difference signal, you can increase the sense of acoustic envelopment. Range is -79.0 to 24.0 dB.

DiffBassF is the transition frequency for the bass-shelf frequency. Range is 16 to 25088 Hz.

The processed signal is split into three frequency bands—Lo, Mid, and High—each of which can be delayed and panned separately.

Crossover1 and **2** are the two Crossover frequencies at which the band-split filters split the signal into three bands. The two parameters are interchangeable: either may have a higher frequency than the other. Range is 16 to 25088 Hz.

Pan [High/Mid/Low] sets the pan position for each band. Range is -100% (fully left) to 100% (fully right.)

Delay [High/Mid/Low] sets the delay for each band. Range is 0 to 1000 ms.

Stereo Image

This effect provides enhancement for a stereo signal. It also features a stereo correlation meter. It uses some parameters from **Mono to Stereo** and some from **Stereo Analyze** (following).

Chapter 10

MIDI Mode

The PC3K sends and receives MIDI on traditional 5-pin DIN connectors and through USB. MIDI can be sent and received on all ports at once.

Press the MIDI mode button to enter MIDI mode. There are three pages in MIDI mode:

- TRANSMIT (**XMIT** soft button)
- RECEIVE (**RECV** soft button)
- CHANNELS (**CHANLS** soft button)

You'll use these pages to determine what MIDI messages the PC3K transmits, and how it responds to the MIDI messages it receives—as well as how each MIDI channel behaves.

When you enter MIDI mode, you'll see one of the three available MIDI mode pages.

The TRANSMIT Page

Press the **XMIT** soft button, and the TRANSMIT page appears. Use the parameters on this page to control how the PC3K sends MIDI information to its USB or MIDI Out port. These settings to some extent affect the PC3K's response to its own keyboard and controllers, but they primarily affect the responses of other MIDI devices that are receiving MIDI from the PC3K on the channel specified with the Channel parameter on this page.

When a *program* is selected, either in Program mode or in Quick Access mode, all of the settings of the TRANSMIT page are in effect, except for **ChgSetups**, which only applies when loading a setup.

If a *setup* is selected, in Setup mode or in Quick Access mode, all of the settings of the TRANSMIT page are in effect except for **ControlSetup**, **Channel**, and **ProgChang** (see below for details.)

When sending MIDI to the USB or MIDI out port from Song mode, Song mode ignores all of the settings on the Transmit page except **ControlSetup** (see below for details.)

```

MIDI Mode: Transmit
ControlSetup: 126 Internal Voices
Destination: USB_MIDI+MIDI+LOCAL
Channel      : 1                ProgChang: On
Transpose: 0ST                ChgSetups: Immediate
VelocityMap: 1 Linear
PressureMap: 1 Linear
XMIT  RECV  CHANLS  ProgChg  RstCha  Panic

```

Parameter	Range of Values	Default
Control Setup	Setup List	126 Internal Voices
Destination	USB_MIDI, MIDI, Local	USB_MIDI+MIDI+Local
Channel	1 to 16	1
Transposition	± 60 semitones	0
Velocity Map	Velocity Map List	1 Linear
Pressure Map	Pressure Map List	1 Linear
Program Change	Off, On	On
Change Setups	Immediate, KeyUp	Immediate

Control Setup

This is where you select the current control setup, Zone 1 of which sets the physical controller assignments for all programs while you're in Program mode. This parameter does not apply to Setup mode. Refer to *Control Setup* on page 6-9 for more information on the control setup.

Destination

The Destination parameter tells the PC3K which ports will carry MIDI information, and determines if the PC3K's sound engine will receive MIDI data. Select the desired destination or any combination of destinations depending on your needs. For example, a value of **Local** disables the USB and MIDI Out ports. Use this setting when you want to play the PC3K, but not to send any MIDI information to other MIDI instruments (local control only.) Alternatively, you would set this parameter to **MIDI** or **USB_MIDI** if you only wanted to send MIDI data to other MIDI instruments from the MIDI port or USB port, and no MIDI data would be sent locally to the PC3K's sound engine. A value of **MIDI+Local** would send MIDI data only to the MIDI out port and the PC3K's sound engine.

For Setup mode, this parameter acts as a final filter for which ports will send MIDI information. For example, if this parameter is set to **MIDI_USB+MIDI**, and a setup zone has its Destination parameter set to **MIDI+Local** on the SetupMode:CH/PRG page, MIDI data will be sent only through the traditional MIDI port. Both parameters, MIDI Xmit Destination and the setup Destination parameter in the SetupMode:CH/PRG page act as filters and both are active in Setup mode.



Note: This parameter has no effect on Song mode. In Song mode each track's destination ignores this parameter.

Channel

This defines which MIDI channel the PC3K uses to transmit MIDI messages when not using a setup or Song mode (each zone determines this in a setup, each track determines this in a song.) The value for this parameter matches the current MIDI channel displayed on the top line of the Program mode page. If you change the current MIDI channel while in Program mode, the setting of this parameter changes accordingly, and vice versa.

Transpose

This parameter affects the transposition that's applied to the MIDI data stream. Adjusting this parameter transposes the PC3K's notes, as well as notes on slaves receiving from the PC3K. This transposition setting mirrors transposition settings from the Program and Setup main pages. It's value is added to transposition settings made elsewhere. This parameter has no effect on MIDI data sent from Song mode.

Velocity Map (Transmit)

Change the MIDI Transmit Velocity Map setting if you are triggering external MIDI gear which is producing notes that are too loud or too quiet based on your playing style (how light or heavy that you play the keys.) The default map provides the widest range of velocity expression, but you may want to choose a different map if the default does not suit your playing style.

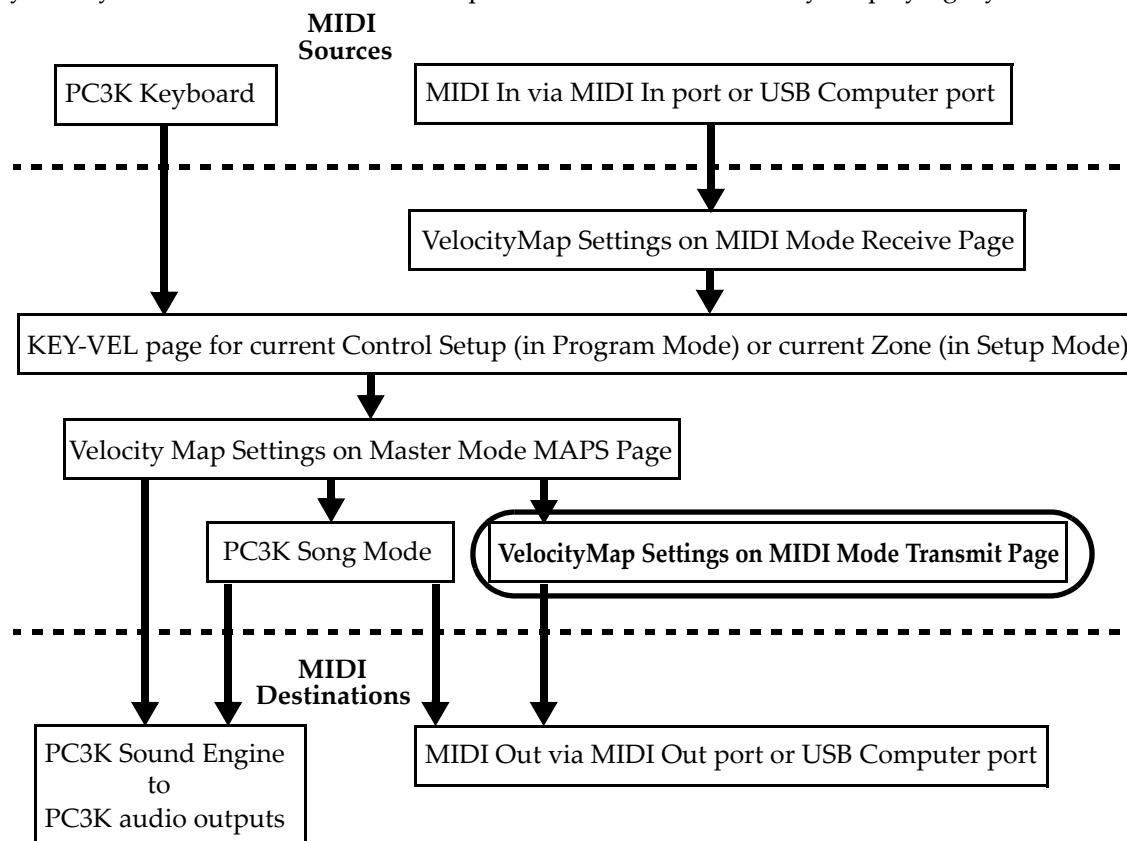

The transmit Velocity Map affects the way the PC3K sends MIDI velocity values to its USB or MIDI Out port (see the circled box above for its location in the MIDI signal flow.) Different maps output different MIDI velocity values for the same received MIDI attack velocity. Each map applies a different curve to received MIDI attack velocities and remaps them to new velocities before transmitting them to the USB or MIDI Out port (this parameter has no effect on MIDI data sent from Song mode or to the PC3K's sound engine.) The default map provides the widest range of velocity expression, but you may want to choose a different map if the default does not suit your playing style. See the diagram above for the other pages that affect the MIDI attack velocity before reaching the transmit Velmap.

The default map, **Linear**, allows MIDI velocities to pass unchanged. Maps **Light 1-3** make it increasingly easier to produce high MIDI velocity values for the same key strike velocity (with Light 3 being the easiest,) so these maps may work better for users who play with a lighter touch. **Hard 1-3** make it increasingly harder to produce high MIDI velocity values for the same key strike velocity (with Hard 3 being the hardest,) so these maps may work better for users who play with a harder touch. **Piano Touch** simulates the general velocity response of an acoustic piano, and is best suited for playing acoustic piano sounds. **Easy Touch** is similar to the Light settings, making high velocities easier to play, but it allows more sensitive control over playing high velocities by not boosting the MIDI velocity for fast strike velocities as much as it does for medium strike velocities. **GM Receive** mimics the velocity map commonly used by keyboards that use the General MIDI (GM) sound set. The GM Receive map makes medium strike velocities produce higher MIDI velocities compared to the Linear map.

Pressure Map (Transmit)

Change the Transmit Pressure Map setting if you are triggering external MIDI gear which is producing MIDI pressure (aftertouch) values that are too high or too low based on your playing style (how soft or hard that you press the keys.) The default map provides the widest range of pressure expression, but you may want to choose a different map if the default does not suit your playing style.

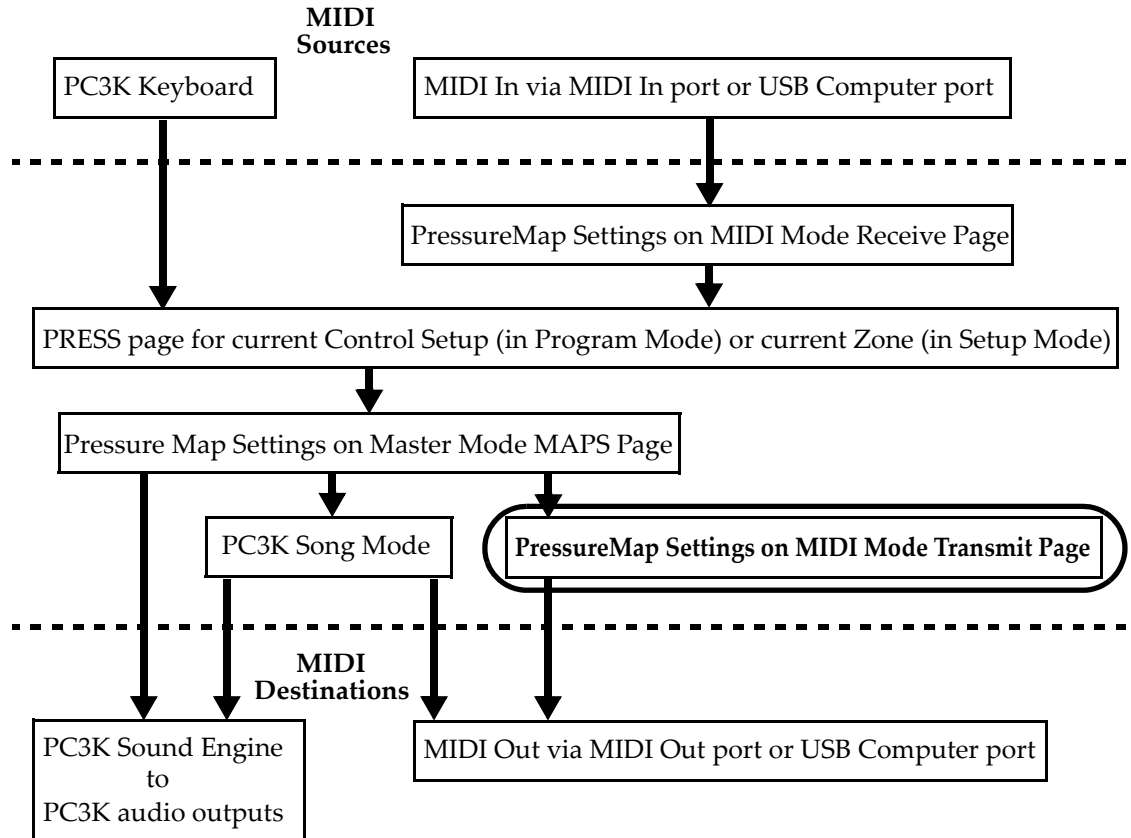

The transmit Pressure Map affects the way the PC3K sends MIDI pressure (aftertouch) values to its USB or MIDI Out port (see the circled box above for its location in the MIDI signal flow.) Different maps output different MIDI pressure (aftertouch) values for the same received MIDI pressure (aftertouch) value. Each map applies a different curve to received MIDI pressure (aftertouch) values and remaps them to new values before transmitting them to the USB or MIDI Out port (this parameter has no effect on MIDI data sent from Song mode or to the PC3K's sound engine.) The default map provides the widest range of pressure (aftertouch) expression, but you may want to choose a different map if the default does not suit your playing style. See the diagram above for the other pages that affect MIDI pressure (aftertouch) values before reaching the transmit Pressure Map.

The default map, **Linear**, allows MIDI pressure (aftertouch) values to pass unchanged. Maps 2-4 make it increasingly easier to produce MIDI pressure values for the same physical pressure applied to a key (with 4 "Easiest" being the easiest.) Maps 4-7 make it increasingly harder to produce MIDI pressure values for the same physical pressure applied to a key (with 7 "Hardest" being the hardest.)

Program Change (ProgChang)

When **ProgChang** is set to **On**, the PC3K sends program change commands to its USB or MIDI Out port when you select programs or setups from the front panel or from your MIDI controller. Select a value of **Off** when you want to change programs on the PC3K but don't want to send program change commands to the USB or MIDI Out port. This parameter doesn't affect the *type* of program change command that's sent; it just determines whether any command is sent at all. (The type of program change command is determined by the BankMode parameter on the CH/PROG page in the Setup Editor of your control setup. See *Control Setup* on page 6-9 for more details.)



Note: The ProgChang parameter applies to all modes except Song mode and Setup mode (or when a setup is loaded from Quick Access mode.) Setups disregard the ProgChang setting and instead use the EntryProgChg parameter on the SetupMode:CH/PROG page (See The Channel/Program (CH/PROG) Page on page 7-4.) Songs disregard this ProgChang setting and instead use the ProgChang parameter on the Song:Event Filter Playback page, accessed from the PLYFLT soft button in Song mode.

Change Setups (ChgSetups)

This parameter determines the exact timing of setup changes when you select a different setup—either by a normal data entry method or via MIDI program change commands. Choose **KeyUp** to indicate that you want setup changes to take place only when you've released all currently held notes. Choose **Immediate** to indicate that you want such changes to happen immediately when you select the setup.

The RECEIVE Page

```

MIDI Mode: Receive
BasicChannel: 1          SysExId : 0
MIDI Mode   : Multi     BankSelect: Ctl 0/32
AllNotesOff : Normal    LocalKbd: None
PrgChgMode  : Extended
VelocityMap: 1 Linear
PressureMap: 1 Linear
XMIT REC V CHANLS PrgChg RstCha Panic
  
```

Press **RECV** to select the RECEIVE page, where you define the PC3K's response to incoming MIDI signals (with one exception pertaining to Quick Access mode, which we'll explain later).

Parameter	Range of Values	Default
Basic Channel	1 to 16	1
MIDI Mode	Omni, Poly, Multi	Multi
All Notes Off	Normal, Ignore	Normal
Program Change Mode	Program Change Type List	Extended
Velocity Map	Velocity Map List	1 Linear
Pressure Map	Pressure Map List	1 Linear
System Exclusive ID	0 to 127	0
Bank Select	Ctl 0, Ctl 32, Ctl 0/32	Ctl 0/32
Local Keyboard Channel	None, 1 to 16	None

Basic Channel

The basic channel determines which channel will always be available to receive MIDI information. Depending on the MIDI receive mode (below), the Basic channel may be the only receiving channel, or one of several.

MIDI Receive Mode (MIDI Mode)

The MIDI Mode parameter determines the MIDI receiving capabilities of the PC3K. When set to **Omni**, the PC3K responds to incoming MIDI events on all MIDI channels, and plays them on the current channel. This is normally used for diagnostic purposes only.

At a setting of **Poly**, the PC3K responds only to events that are sent on the same channel as the PC3K's current MIDI channel (the one displayed on the top line of the Program mode page). In Poly mode, the currently selected channel is always the basic channel, so if you change channels, the basic channel changes accordingly.

With a value of **Multi** (the default), the PC3K responds to events on all active channels. This is the mode you'll use when you're driving the PC3K with a sequencer, since you can play a different program on each channel. At this setting, you can turn individual channels on and off (on the CHANNELS page, described later in this chapter).

All Notes Off

If this parameter's value is set to **Normal**, the PC3K responds to All Notes Off messages received over MIDI. **Ignore** causes these messages to be ignored. If you're using a Roland product as a MIDI controller for your PC3K, you'll want to set the value of this parameter to **Ignore**. This is because some older Roland products occasionally send an All Notes Off message when no keys are held down—even if you're sustaining notes with a pedal. You might find all your sustains missing from your sequence, for example, if you're driving your PC3K from one of Roland's hardware sequencers. Setting this parameter to **Ignore** takes care of this problem.

Regardless of the setting for this parameter, the PC3K always responds to its own **Panic** button by shutting off all active notes and controllers.

Program Change Mode (PrgChgMode)

This determines how the PC3K responds to program change commands received via MIDI. See *Program Change Formats* on page 10-15 for an explanation of the various values available for this parameter.

Velocity Map (Receive)

Change the receive Velocity Map setting if you are triggering the PC3K with external MIDI gear which is producing notes that are too loud or too quiet. The default map provides the widest range of velocity expression, but you may want to choose a different map if the default does not suit your playing style.

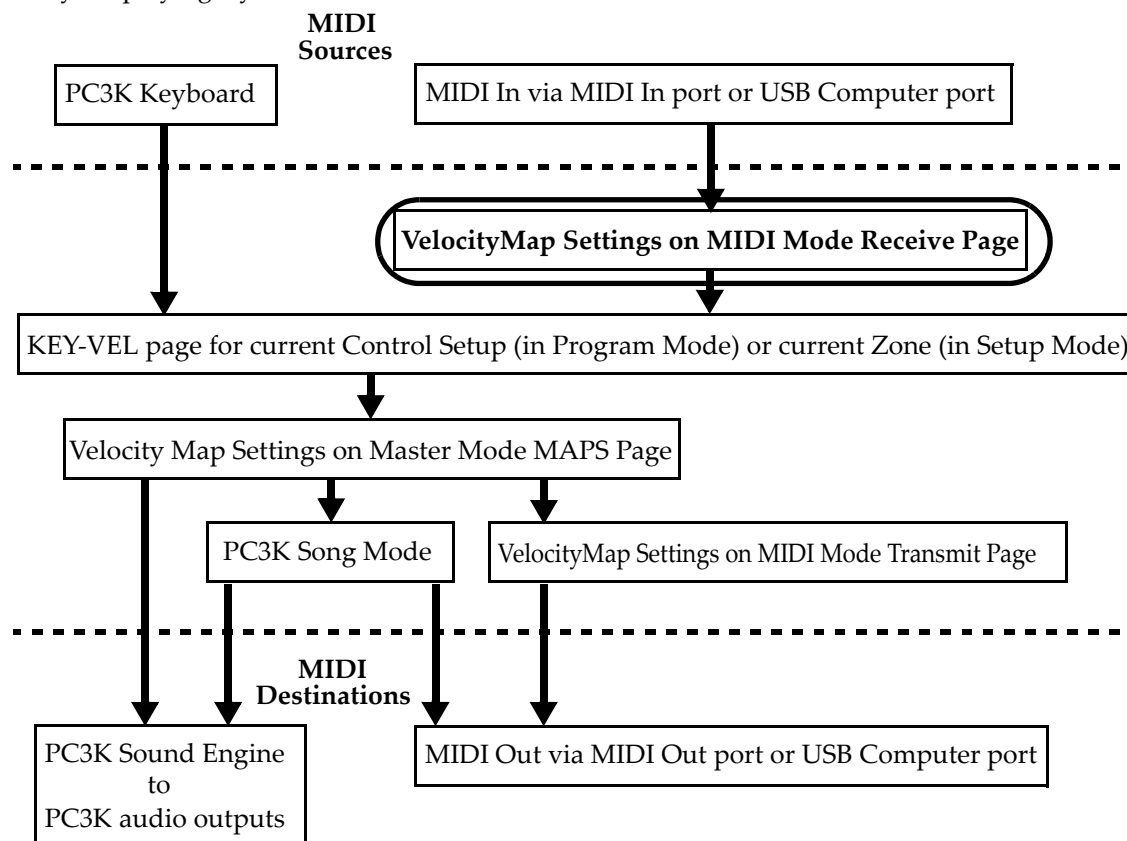

The receive Velocity Map affects the way the PC3K receives MIDI velocity values from its USB or MIDI In port (see the circled box above for its location in the MIDI signal flow.) Different maps output different MIDI velocity values for the same received MIDI attack velocity. Each map applies a different curve to received MIDI attack velocities and remaps them to new velocities before letting them pass (this parameter has no effect on MIDI data sent from the PC3K's keyboard.) The default map provides the widest range of velocity expression, but you may want to choose a different map if the default does not suit your playing style. See the diagram above for the other pages that affect the MIDI attack velocity before reaching the receive Velocity Map.

The default map, **Linear**, allows MIDI velocities to pass unchanged. Maps **Light 1-3** make it increasingly easier to produce high MIDI velocity values for the same key strike velocity (with Light 3 being the easiest,) so these maps may work better for users who play with a lighter touch. **Hard 1-3** make it increasingly harder to produce high MIDI velocity values for the same key strike velocity (with Hard 3 being the hardest,) so these maps may work better for users who play with a harder touch. **Piano Touch** simulates the general velocity response of an acoustic piano, and is best suited for playing acoustic piano sounds. **Easy Touch** is similar to the Light settings, making high velocities easier to play, but it allows more sensitive control over playing high velocities by not boosting the MIDI velocity for fast strike velocities as much as it does for medium strike velocities. **GM Receive** mimics the velocity map commonly used by keyboards that use the General MIDI (GM) sound set. The GM Receive map makes medium strike velocities produce higher MIDI velocities compared to the Linear map.

Pressure Map (Receive)

Change the receive Pressure Map setting if you are triggering the PC3K with external MIDI gear which is producing MIDI pressure (aftertouch) values that are too high or too low based on your playing style (how soft or hard that you press the keys.) The default map provides the widest range of pressure (aftertouch) expression, but you may want to choose a different map if the default does not suit your playing style.

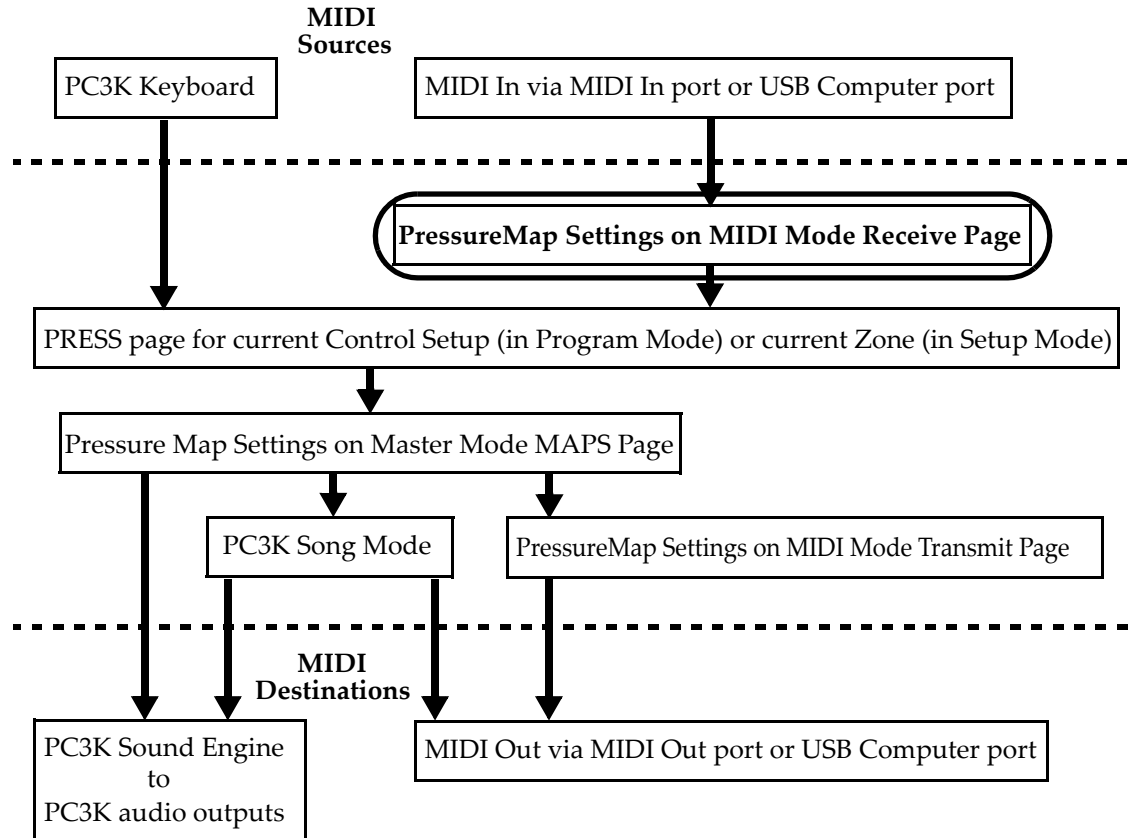

The receive Pressure Map affects the way the PC3K receives MIDI pressure (aftertouch) values from its USB or MIDI In port (see the circled box above for its location in the MIDI signal flow.) Different maps output different MIDI pressure (aftertouch) values for the same received MIDI pressure (aftertouch) value. Each map applies a different curve to received MIDI pressure (aftertouch) values and remaps them to new values before letting them pass (this parameter has no effect on MIDI data sent from the PC3K’s keyboard.) The default map provides the widest range of pressure (aftertouch) expression, but you may want to choose a different map if the default does not suit your playing style. See the diagram above for the other pages that affect MIDI pressure (aftertouch) values before reaching the receive Pressure Map.

The default map, Linear, allows MIDI pressure (aftertouch) values to pass unchanged. Maps 2-4 make it increasingly easier to produce MIDI pressure values for the same physical pressure applied to a key (with 4 “Easiest” being the easiest.) Maps 4-7 make it increasingly harder to produce MIDI pressure values for the same physical pressure applied to a key (with 7 “Hardest” being the hardest.)

System Exclusive ID (SysExID)

The SysExID parameter differentiates between more than one MIDI device of the same model. You won't need to change the default setting of 0 unless you have multiple PC3Ks (or K2600s, K2500s, or K2000s) receiving SysEx messages from a single source. In that case, make sure each instrument has a different SysExID. Then you can direct SysEx messages to the appropriate PC3K with the SysExID byte that's included with every SysEx message. A value of **127** specifies "Omni Receive." That is, at this value, a PC3K responds to a SysEx message regardless of the SysEx ID of the message.

Bank Select

BankSelect allows you to choose between having the PC3K respond to Controller 0 or Controller 32 or both. The reason for this is that various manufacturers have chosen one method or the other. The three possible values for this parameter are:

- Ctl 0** Responds to controller 0 only.
- Ctl 32** Responds to controller 32 only.
- Ctl 0/32** Responds to 0 or 32.

Local Keyboard Channel (LocalKbdCh)

The Local Keyboard Channel enables an external MIDI device to function as if it is the PC3K's keyboard and physical controllers. This allows one MIDI channel of an external MIDI device to control multiple MIDI channels of the PC3K, even if the external MIDI device only transmits on one channel.

In **Setup Mode**, when the **LocalKbdCh** parameter is set to match the channel on which the external MIDI device is transmitting, the setup will play on the external MIDI device as it does on the PC3K's keyboard. See the *Continuous Controller Messages From External MIDI Devices* on page 10-11 section below for details on receiving continuous controller messages from an external MIDI device when a Local Keyboard Channel is set. Also, in Setup Mode, when the **LocalKbdCh** parameter is set to match the channel on which the external MIDI device is transmitting, external MIDI received by a Zone is sent to the destination set with each Zones' CH/PROG page **Destination** parameter (see *Destination* on page 7-5 for details.) In this case, if a Zone is sending the external MIDI to the USB or MIDI Out ports, the MIDI messages will be remapped to the channel of the Zone, and any note transposition set for the Zone will be applied.

In **Setup Mode**, when the **LocalKbdCh** parameter is set to **None**, an external MIDI device will play a single Program. The played program will be on a Zone of the current Setup that has a **Channel** parameter (on the Setup Editor CH/PROG page) which matches the channel on which the external MIDI device is transmitting. (If no Zone's Channel parameter matches, the external device will play the program that was last used by that channel in Program or Setup Mode.) When the Program of a Setup Zone is played from an external MIDI controller with the **LocalKbdCh** parameter set to **None**, Setup MIDI parameters (most noticeably key range and transposition) will not be applied. (See *Input Channel* on page 7-6 for details on applying these parameters when playing a single zone from an external MIDI device.) Also, in Setup Mode, when Local Keyboard Channel is set to None, external MIDI sent to any channel is output from the MIDI Thru port, but not from the MIDI Out port or USB port.

The Local Keyboard Channel parameter also affects how external MIDI devices interact with **Program Mode**. In Program Mode, when the **LocalKbdCh** parameter is set to match the channel on which the external MIDI device is transmitting, the external MIDI device will play the Program on the channel currently selected on the Program Mode main page. (*The Program Mode main page shows the current channel on the right of the top line.*) Also, in this case, external MIDI received by a Program is sent to the destination set by the **Destination** parameter on the MIDI Mode Transmit page (see *Destination* on page 10-2 for details.)

In **Program Mode**, when the **LocalKbdCh** parameter is set to **None**, an external MIDI device will trigger the program on the channel that it is transmitting, no matter which channel is currently selected on the Program Mode main page. In this case, external MIDI sent to any channel is output from the MIDI Thru port, but not from the MIDI Out port or USB port.

Continuous Controller Messages From External MIDI Devices

When using an external MIDI device with the PC3K, you can control many of the PC3K's program parameters by sending MIDI Continuous Controller messages (CCs) from the external MIDI device. Each parameter that you wish to control must have a CC number assigned in the Program Editor (see the section below: *Assigning An External CC Number As A Control Source For A Program Parameter*.) See the sections below for details on using external CCs with the available settings in Program and Setup Mode.

For details on controllable parameters of VAST programs, see the following sections: *The DSP Modulation (DSPMOD) Page* on page 6-30, *The LFO Page* on page 6-38, *The ASR Page* on page 6-40, *The Function (FUN) Page* on page 6-41, *The Envelope Control (ENVCTL) Page* on page 6-45, *The MOD Pages* on page 9-10, and *FXLFO, FXASR, and FXFUN pages* on page 9-11. For KB3 programs, see the following sections: *KB3 Editor: The PITCH Page* on page 6-62, *KB3 Editor: The AMP Page* on page 6-62, *KB3 Editor: The LFO, ASR, and FUN Pages* on page 6-70, *The MOD Pages* on page 9-10, and *FXLFO, FXASR, and FXFUN pages* on page 9-11.

Assigning An External CC Number As A Control Source For A Program Parameter

For each program, the Program Editor can be used to assign an external MIDI controller CC number for each controllable parameter in that parameter's source field. Source fields are named differently depending on their page: Src1, Src2, RateCt, Trigger, Input a, Input b, and Source. To assign a CC number to a source field, enter the number with the alphanumeric pad, then press **Enter**. With the source field selected, you can also assign a CC number by holding the **Enter** button and sending a CC value from the external MIDI controller. When assigning a CC number to a source field, the number may be displayed in the source field as the name of that CC's default use.

Using External CCs In Program Mode, Local Keyboard Channel=None

To control a program parameter via external MIDI CC in Program Mode, the parameter must first have a source assigned within the Program Editor, as described in the *Assigning An External CC Number As A Control Source For A Program Parameter* section above. To control an assigned program parameter with **Local Keyboard Channel** set to **None**, send the assigned CC number to the channel which contains the program.

Using External CCs In Program Mode, Local Keyboard Channel Enabled

To control a program parameter via external MIDI CC in Program Mode, the parameter must first have a source assigned within the Program Editor, as described in the *Assigning An External CC Number As A Control Source For A Program Parameter* section above. When using **Local Keyboard Channel** in Program Mode, it is best to assign parameters to be controlled by the default CCs for physical controllers, because these match the default destinations (see the *External MIDI CC Remapping For Local Keyboard Channel and Input Channel* table below for default CCs).

The **Local Keyboard Channel** makes an external MIDI controller's continuous controllers behave as if they were the PC3K's physical controllers. In Program Mode, when an external MIDI controller is sending a CC on the channel set for **Local Keyboard Channel**, external CCs can control the destinations set for each of the PC3K's physical controllers. Send the default CC for a physical controller to control its destination (see the *External MIDI CC Remapping For Local Keyboard Channel and Input Channel* table below for defaults.) In Program Mode, these destinations are set in the Control Setup (see *Control Setup* on page 6-9 for details.) By default, the destinations for the PC3K's physical controllers are the same as their default CC numbers. To control an assigned parameter, send the assigned default physical controller CC to the channel set for **Local Keyboard Channel**.

If a **Local Keyboard Channel** is set but you are sending CCs to a different channel, these CCs will be received normally by the Program in that channel.

Using External CCs In Setup Mode, Local Keyboard Channel=None, Input Channel=None

To control a program parameter via external MIDI CC in Setup Mode, the parameter must first have a source assigned within the Program Editor, as described in the *Assigning An External CC Number As A Control Source For A Program Parameter* section above. To control an assigned parameter, send the assigned CC number to the channel for the Setup Zone which contains the program.

Using External CCs In Setup Mode, Local Keyboard Channel Enabled, Input Channel=None

To control a program parameter via external MIDI CC in Setup Mode, the parameter must first have a source assigned within the Program Editor, as described in the *Assigning An External CC Number As A Control Source For A Program Parameter* section above.

The Local Keyboard Channel makes an external MIDI controller's continuous controllers behave as if they were the PC3K's physical controllers. In Setup Mode, when an external MIDI controller is sending a CC on the channel set for **Local Keyboard Channel**, external CCs can control the destinations set for each of the PC3K's physical controllers. Send the default CC for a physical controller to control its destination (see the *External MIDI CC Remapping For Local Keyboard Channel and Input Channel* table below for defaults.) The CC is received in Setup Mode and sent to a Program based on the destination set in Setup Mode. In the Setup Editor, use the alphanumeric pad to set each PC3K physical controller **Dest**, **OnControl** or **OffControl** field to the CCs you assigned in Program Mode. When setting a CC destination, the number may turn into the name of the PC3K physical controller which uses that CC by default. If you create a Setup using Setup **126 Internal Voices** as a template, the default CC numbers will already be set for each physical controller destination. (*Don't save a Setup at ID 126, setup 126 Internal Voices is the PC3K's default Control Setup, see Control Setup on page 6-9 for details.*)



Note: In Setup Mode, when an external MIDI controller is sending a CC on the channel set for **Local Keyboard Channel**, any CC sent that is not in the *External MIDI CC Remapping For Local Keyboard Channel and Input Channel* table (see below) gets sent to Programs on all Zones of the Setup.

If a **Local Keyboard Channel** is set but you are sending CCs to a different channel, these CCs will be received normally by the Program in the Setup Zone for that channel.

Using External CCs In Setup Mode, Local Keyboard Channel=None, Input Channel Enabled

To control a program parameter via external MIDI CC in Setup Mode, the parameter must first have a source assigned within the Program Editor, as described in the *Assigning An External CC Number As A Control Source For A Program Parameter* section above.

To use an **InputChannel** (see page 7-6,) **Local Keyboard Channel** must be set to **None**. The **InputChannel** makes an external MIDI controller's continuous controllers behave as if they were the PC3K's physical controllers. When an external MIDI controller is sending a CC on the channel set for **InputChannel**, external CCs can control the destinations set for each of the PC3K's physical controllers. Send the default CC for a physical controller to control its destination (see the *External MIDI CC Remapping For Local Keyboard Channel and Input Channel* table below for defaults.) The CC is received in Setup Mode and sent to a Program based on the destination set in Setup Mode. In the Setup Editor, use the alphanumeric pad to set each PC3K physical controller **Dest**, **OnControl** or **OffControl** field to the CCs you assigned in Program Mode. When setting a CC destination, the number may turn into the name of the PC3K physical controller which uses that CC by default. If you create a Setup using Setup **126 Internal Voices** as a template, the default CC numbers will already be set for each physical controller destination. (*Don't save a Setup at ID 126, setup 126 Internal Voices is the PC3K's default Control Setup, see Control Setup on page 6-9 for details.*)



Note: In Setup Mode, when an external MIDI controller is sending a CC on the channel set for **Input Channel**, any CC sent that is not in the *External MIDI CC Remapping For Local Keyboard Channel and Input Channel* table (see below) also gets sent to the Program on that channel.

If an **InputChannel** is set but you are sending CCs to a different channel, these CCs will be received normally by the program in the Setup Zone for that channel.

External MIDI CC Remapping For Local Keyboard Channel and Input Channel

PC3K Physical Controller	Default MIDI CC# Which Controls The Destination Assigned To Each PC3K Physical Controller In The Setup Editor
Pitch Wheel	NA, responds to MIDI pitch bend messages
Mod Wheel	1
Arp Button	69
SW Button	29, 70
Continuous Pedal 1	11
Continuous Pedal 2	4
Breath	2
Pressure (key pressure)	Not controllable by MIDI CC
Foot Switch 1	64
Foot Switch 2	66
Foot Switch 3	67
Ribbon Section 1	18, 21
Ribbon Section 2	19
Ribbon Section 3	20
Slider A (Data)	6
Slider B	13
Sliders C-I	22-28
Programmable Switches 1-8	Not controllable by MIDI CC
Bank Buttons (KB3 control buttons, Setup Zone Mute buttons)	Not controllable by MIDI CC

The Channels Page

```

MIDI Mode: Channels #Channel: 1
Enable : On
Program: 1010 Downes Lead      PrgLock : Off
Pan    : 64                    PanLock  : Off
Volume : 127                   VolLock  : Off

XMIT  RECV  CHANLS  PrgChg  RstCha  Panic

```

Press the **CHANLS** soft button to select the CHANNELS page, where you can define numerous parameters for each MIDI channel independently. Use the **Chan/Layer** buttons to select the MIDI channel you wish to work on.

The CHANNELS page is very useful when you're doing multi-timbral sequencing, with programs assigned to numerous MIDI channels. The CHANNELS page lets you set several control characteristics for each MIDI channel. This makes it easy to adjust the playback of the sequence without editing the sequence itself. For example, you might turn off the Enable parameter for one or more channels to mute the tracks on those channels. You could also set the VolLock parameter to **On**, to ignore any MIDI volume messages the PC3K receives on a given MIDI channel.

Parameter	Range of Values	Default
Enable	Off, On	On
Program	Program list	Program ID 1
Pan	0 to 127	64 (centered)
Volume	0 to 127	127 (maximum)
Program Lock	Off, On	Off
Pan Lock	Off, On	Off
Volume Lock	Off, On	Off

Enable

Use this parameter to turn the currently selected channel on or off. When on, the channel will receive MIDI information, and the settings of the parameters on the MIDI CHANNELS page will be in effect. When off, the channel will ignore all MIDI information.

Program

Use this parameter to assign a program to the currently selected channel. The channel will still respond to program change commands received via MIDI, unless the PrgLock parameter (described below) is set to **On**.

Pan

This offsets the pan position of the current program as set on the OUTPUT page in the Program Editor. A value of **0** is maximum offset to the left, **64** is no offset, and **127** is maximum offset to the right. Changing the value of this parameter is like inserting a MIDI pan message. MIDI Pan (MIDI 10) messages will change the value of this parameter, unless the PanLock parameter (described below) is set to **On**.

If the Mode parameter on the OUTPUT page in the Program Editor is set to Fixed, changing the value of Pan on the CHANNELS page in MIDI mode has no effect.

Volume

This sets the volume for any program assigned to the currently selected channel. A value of **0** is silence, and a value of **127** is full volume. The value of this parameter will change in response to MIDI Volume (MIDI 07) messages, unless the VolLock parameter (described below) is set to **On**.

Program Lock, Pan Lock, Volume Lock

When the parameter locks are set to **On**, the three parameters they control do not respond to their respective MIDI controller messages. In that case, you could change the Program, Pan, and Volume settings from the front panel, but not via MIDI.

Program Change Formats

The PC3K can store more programs than the MIDI program change specification can handle (MIDI lets you send program change numbers from 0 to 127 or 1 to 128 only). So we've designed a system that makes program selection more flexible. This is true whether you're selecting programs from the PC3K's front panel, or via MIDI.

Program Change Type	For Use With:
Extended	Bank changes and Program changes. A bank has 128 ids. Note that our system will recognize 16 banks, from 0 to 15. (2048 ids). This is for connecting a PC2 or a generic MIDI device as a controller device.
K2600	Bank changes and Program changes. A bank has 100 ids. Our system will recognize in this case 21 banks, from 0 to 20. For example, with MIDI out from a K2600 into the MIDI in of a PC3K, if you scroll or enter a number in the K2600 you will see the same numbers in the K2600 and in the PC3K if the programs exist.
QAccess	Other PC3Ks (or K2600s, K2500s or K2000s) similarly set, when in Quick Access mode

The PC3K gives you thousands of program change numbers to work with. These are organized into 16 banks of 128 each (the memory banks). A program's object ID is its program change number, as discussed in Chapter 5. This makes it easy to keep track of your programs. The PC3K can use several different formats for interpreting program change commands. The value for the ProgChgMode parameter on the RECEIVE page determines which format is used, and the one you should select depends on your MIDI system.

If you expect you'll always change programs from your PC3K's front panel, selecting programs is as simple as entering the program change number (the program's object ID) on the alphanumeric pad, and pressing **Enter**. Even program numbers above the usual MIDI limit of 127 can be selected this way.

Extended Program Changes

If you're controlling your PC3K from a MIDI device that can handle the MIDI Controller 0 or 32 program-change format, you'll have the greatest flexibility if you set the ProgChgType parameter to a value of **Extended**.

When you're using the extended program change format, then depending on the value of the BankSelect parameter on the RECEIVE page in MIDI mode, the PC3K will respond to either MIDI Controller 0 or 32 program change commands for bank selection, and standard program change commands for program changes within the current bank. Different values have different results, as shown in the following table:

Program Change Command Type	Value of Message	Result
MIDI controller 0 or 32 (MC 0 or MC 32)	0 to 16	Selects memory bank zeros–900s
Standard (PCH)	0 to 127	Selects correspondingly numbered program in current memory bank

If your PC3K is already in the memory bank you want to use, you can send it single PCHs from 0 to 127, to select programs within that memory bank. The PC3K's response depends on the setting for the Bank/Select parameter on the MIDI Mode RECV page. If you want to change the memory bank, the PC3K must receive either an MC 0 or 32 message with value 0–127. The next PCH in the range 0–127 will select the correspondingly numbered program in the newly selected bank. The following table of examples should help make it clear.

Bank Change Command Received	Program Change Command Received	Result
MC 0 or 32: value 0	PCH: value 99	Program 99 (Base1 bank, 99th program)
MC 0 or 32: value 1	PCH: value 41	Program 169 (Base2 bank, 41st program)
MC 0 or 32: value 1	PCH: value 129	Program 258 (Classic Keys bank, 2nd program)
MC 0 or 32: value 7	None	KB3 bank selected, no change in current program (bank selection is pending for next PCH)

QAccess

Using this setting is similar to using the Extended program change format, but it goes one step further. Incoming program change commands are interpreted just as they are in the normal Extended format. But the resulting program change number, instead of selecting a program, selects a Quick Access bank entry (you must be in Quick Access mode for this to work). There are two advantages to using this format. First, it allows you to select both programs and setups using program change commands, without having to switch between Program and Setup modes. Second, you can remap incoming program change commands to select programs or setups with different IDs. This is handy if the sending unit can't send program change commands higher than 127.

First, a brief review of Quick Access bank structure. Each Quick Access bank can store ten entries, each of which can be a program or a setup. Each of the PC3K's 10 memory banks can store 20 Quick Access banks (except the Zeros bank, which can store 75). Therefore when you're in Quick Access mode, you have access to 200 (or 750 in the Zeros bank) programs or setups without leaving the currently selected memory bank. The QA Ext program change format lets you select any one of those programs or setups via MIDI. If you select another memory bank,

you have a different set of 200 programs and setups at your disposal. When you're using this format, the PC3K will respond to MC 0 or 32 messages for selecting QA banks, and to PCHs for selecting entries within the current bank. PCHs select entries according to their "chronological" listing within the QA bank (not according to their IDs).

Command Type	Value Range	Result
MIDI controller 0 or 32 (MC 0 or MC 32)	0 to 127	Selects QA bank 0n, 1n, 2n, 3n, 4n, 5n, 6n, 7n in current memory bank
Standard (PCH)	0-127	Selects last digit (n above) of QA bank, and entry within that bank

Depending on the QA bank entry you want to select, you'll send the PC3K either a PCH (value 0 to 127), or a MIDI Controller 0 or 32 message (value 0 to 127) followed by a PCH. Sending a single command will let you select from a range of 10 QA banks and select an entry within that bank (see the table below). To select a different range of QA banks, send an MC 0 or 32 message followed by a PCH.

The MC 0 or 32 messages selects the range of QA banks (0s through 70s), while the PCH selects the bank within that range, as well as the entry within that bank. Neither the MC 0 or 32 nor the PCH selects a different *memory* bank. In fact, you can't change the memory bank via MIDI when using this format. All program and setup selections are made within the currently selected memory bank. You'll know which memory bank is selected by looking at the ID of the currently selected Quick Access bank in the top line of the Quick Access mode page.

QAccess and MIDI Transmission

If you're in Quick Access mode and you're using the QAccess format for the program change type, selecting QA banks or bank entries from the PC3K (with the alphanumeric buttonpad, the cursor buttons, the Alpha Wheel, the **Plus/Minus** buttons, or the **Chan/Layer** buttons) also sends corresponding program change commands to the PC3K's USB and MIDI Out port. The PC3K sends either an MC 0 or 32 message followed by a PCH. The following tables give specific examples.

Current QA Bank	Entry From Alphanumeric Pad	Commands Sent	
		MC 0 or 32	PCH
1	0	0	10
1	9	0	19
2	0	0	20
2	9	0	29
9	9	0	99
12	8	1	0
19	9	1	99
20	0	2	0
29	9	2	99
75	9	7	59
100	0	0	0
105	9	0	59
110	9	1	99
117	7	1	77
119	9	1	99

Table 10-1 QAccess Program Change Examples

The Soft Buttons in MIDI Mode

The first three soft buttons select the three MIDI mode pages. The **PrgChg** soft button lets you send a program change command on any MIDI channel. The **RsetCh** soft button lets you return all channel parameters to their default values. The **Panic** soft button sends an All Notes Off and an All Controllers Off messages to the PC3K and on all 16 MIDI channels.

Program Change (PrgChg)

When you press this soft button, a dialog appears that lets you send program changes out the USB or MIDI Out port, but does not change internal programs. The **Chan/Layer** buttons, the **Up/Down** cursor buttons, and the **Chan-** and **Chan+** soft buttons can all be used to change the channel on which the program change command will be sent. The **Left/Right** cursor buttons, the **Plus/Minus** buttons, the Alpha Wheel and the **Prog-** and **Prog+** soft buttons can all be used to change the program change number that will be sent. When you've set the channel and the program change number, press the **Send** soft button to send the program change command. Or press the **Cancel** soft button if you don't want to send it. You can change the channel and the program number as many times as you want before you press **Send**. You also can use the alphanumeric pad to select a program number directly.

Reset Channels (RsetCh)

When you press this soft button, the PC3K asks if you want to reset all channels. If you press **Yes**, all settings on the CHANNELS page will return to their default values. When the project's over, you can reset the Channels to restore the audio routing to each individual program (a value of **Prog**), rather than selecting each channel's page and setting the Pair parameter back to a value of **Prog**. Press **No** if you decide not to reset the channels.

Panic

Panic sends All Notes Off and All Controllers Off messages to the PC3K and all MIDI channels.

Chapter 11

Master Mode

Press the **Master** mode button to enter Master mode, which contains parameters affecting the PC3K's overall performance and system setup. You can set the system Clock so that the PC3K will time-stamp your files correctly. You can use the Object tool to rename or delete selections of objects. You can also enter the Boot Loader to access a number of system and file utilities, or use Reset to delete all user objects and restore the PC3K's memory to its original factory settings.

When you exit Master Mode (or MIDI Mode) the PC3K saves a Master Table (unless MasterTableLock is **On** — more on this below.) The Master Table remembers the settings of the Master pages, as well as the state of the PC3K, such as which programs are assigned to each channel, settings for MIDI Mode Transmit and Receive pages, and Master FX settings. Explicit saving of the Master Table is also possible.

MAIN

On the Master Mode MAIN page you'll find parameters for setting the overall tuning and transposition of the PC3K, overall FX settings, drum program remapping, clock source options, ID entry options, demo song options, as well as options for saving master mode settings and remote triggering of PC3K functions.

```

MasterMode:MAIN          Memory available:69%
Tune      : 0ct
Transpose: 0S1
FX Mode   : Performance
DrumRemap: None
Id Entry  : Global
SetupCtls: Instant
more MAIN  MAPS  OUTPUT TEMPO  more

```

Parameter	Range of Values	Default
Tune	± 100 cents	0
Transpose	-128 to 127 semitones	0
FX Mode	Performance, Multitrack	Performance
Drum Remap	None, GM	None
ID Entry	Global, Bank	Global
Setup Controllers (SetupCtls)	Instant, Pass Entry	Instant
Master Lock	On, Off	Off
Demo Button	On, Off	On
Buttons Mode	Off, On	Off
Display	Lyr/Zone, Ctls	Lyr/Zone

Tune

Adjusting the value of this parameter tunes every program in the PC3K by the amount you specify. Tuning can be adjusted up or down 100 cents (one semitone) in one-cent increments. This parameter is useful for getting in tune with recordings and acoustic instruments. Adjusting the tuning in Master mode does not change the settings on the PITCH page of individual programs, but will be added to any adjustments you make there. Master mode tuning adjustments affect only the audio output of PC3K program notes, and *not notes sent via MIDI*.

Transpose

Like the Tune parameter above, Transpose affects every PC3K program, but not those notes sent to the MIDI Out port. You can adjust the MIDI transposition sent to the MIDI Out port on the TRANSMIT page in MIDI mode.

FX Mode

With FX Mode set to **Performance**, the PC3K minimizes disruption of existing effects when changing programs, and entry values will not disrupt sustained notes when changing programs in Program or Quick Access modes. When controlling the PC3K from an external sequencer in Program Mode, you will want to set FX Mode to **Multitrack** to minimize effect disruption. FX Mode is set to Performance as a default, with some exceptions. In Song mode, Multitrack mode is always used, despite how this parameter is set in Master Mode. Also, the FX Mode parameter does not affect Setup Mode because it uses its own FX mode.

Drum Remap

This parameter will remap all Drum programs to conform to the General MIDI (GM) drum map, a standard drum map used in many keyboards and synthesizers. The GM drum map isn't optimally intuitive in terms of playability, so by default the PC3K uses a unique keypad that is more intuitive and lends better to performance. However, the GM drum map is so commonplace that many players feel more comfortable playing drum programs with the GM drum map. Because of this, the PC3K is designed such that you can remap drum programs to the GM drum map.

When the Master Page Drum Remap is set to **None**, no remapping takes place in Program mode. When the Master Page Drum Remap is set to **GM**, the PC3K remaps Drum programs to the GM drum map.

ID Entry

Global means that any entry you make from the alphanumeric keypad will select the object indicated, regardless of the bank it is in. For example, in program mode type "36" of the alphanumeric keypad to select program 36.

If Numeric Entry is set to **Bank**, your selection will be limited to the currently selected bank. For instance, in Program mode, if you are in **Orchestra** bank and you enter "65", then the current program becomes program 65 of the Orchestra bank, viz. **449 HornSect Layer**.

Setup Controllers (SetupCntls)

The Setup Controllers parameter affects how the PC3K's physical controllers relate to Entry Values in Setup Mode (see *Entry (Ent) and Exit Values* on page 7-30.) With the Setup Controllers parameter set to **Instant**, moving a physical controller assigned within a Setup will instantly send a new MIDI value to that assignment. With the Setup Controllers parameter set to **PassEntry**, moving a physical controller assigned within a Setup will not send a new MIDI value to that assignment until the physical controller passes the value set for its Entry Value. **Instant** is set by default, but **PassEntry** can be useful so that Setup controller assignments don't jump far from their entry values when first moving a physical controller.

Master Table Lock (Master Lock)

With Master Lock set to **Off**, the PC3K will save the current Master mode configuration when you exit Master mode (or MIDI mode). This information is stored in a Master Table object (see *Save* on page 11-18 below for more details on what is saved with a Master Table.)

If you have a particular Master configuration that you would like to safeguard against the auto-saving feature, set Master Lock to **On**. With the Master Lock on, the PC3K does not save any changes unless you press the **Save** soft button. Note that if you would like Master Lock to stay on next time you turn on the PC3K, you must press the Save soft button to store the state of Master Lock to the Master Table.

Demo Button

The Demo Button parameter determines what pressing the **Play/Pause** button does in program mode. With the Demo button parameter set to **On**, the **Play/Pause** button plays a demo song for the current program. (To play a demo song, the *Demo Song* parameter must be set in the program editor for the current program, see page 6-37 for details.) With the Demo button parameter set to **Off**, the **Play/Pause** button plays the last song that was selected in Song Mode. If a demo song is set for the current program, it can always be played from program mode by simultaneously pressing the up and down cursor buttons.

Buttons Mode (Buttons)

If you set the Buttons parameter to **On**, pressing any buttons on the PC3K will generate System Exclusive (SysEx) messages that are sent to the MIDI Out port. This enables you to do two things: control a remote PC3K, and/or record sequences of programming button presses to a sequencer or SysEx software package.

If you have the MIDI In port of another PC3K connected to the first one's MIDI Out port, the second instrument will respond to every button press on the first instrument, just as if you were pressing the buttons of the second one. Keep in mind that both devices must be in exactly the same state (the same page in the same mode, with identical lists of RAM objects) when you start. Otherwise the button presses you make on the first instrument may execute other functions on the second instrument.

Again, it's important to keep in mind that the state of your PC3K must be identical to its state when you recorded the sequence of button presses. If you've added or deleted any objects stored in RAM, for example, the sequence of button presses will select different objects when you play back the button press sequence.

*NOTE: Make sure this parameter is set to **Off** before you initiate a SysEx dump of any kind. If this parameter is on when you start a dump, the buttons you press to begin the dump will also generate SysEx messages.*

Display

The **Display** parameter determines what will be displayed in the info box on the left side of the Program Mode and Setup Mode main pages. When **Display** is set to **Lyr/ZONE**, the info box will display an overview of the keymap names and ranges for each layer in the current Program (while in Program Mode,) or an overview of the Program names and ranges for each zone in the current Setup (while in Setup Mode.) The line beneath the name of the keymap/program indicates the keyboard range of that layer/zone. For example, a line extending all the way across the info box represents a layer/zone that extends from C -1 to G 9—the full 128 note range of the PC3K. The representation of these layer/zone ranges is approximate; they're intended to let you know if you have a layered keyboard (lines overlapping) or a split keyboard (lines not overlapping). In Program Mode, stereo keymap layers are indicated in the info box with a double circle symbol. In Setup Mode, zones that have the **Riff** parameter set to **On** (On the

Setup Editor RIFF1 page) are indicated in the info box with a riFF symbol. The info box can display up to four layers/zones at a time. If the current Program/Setup has more than four layers/zones, you can view their keymaps/programs by pressing and holding down the **Enter** button and scrolling with the **Chan/Layer** buttons.

When **Display** is set to **Ctls**, Program Mode and Setup Mode use the info box to display the controller assignment info and MIDI CC value for the last moved controller. The info box clears a few moments after displaying the controller info.

MAPS

On the MAPS page you'll find parameters for setting keyboard behavior for velocity, pressure, intonation, and key action maps. You can also set the default sequence for Song mode.

```

MasterMode:MAPS      Memory available:94%
Velocity Map  : Linear
Pressure Map   : Linear
Intonation Map: 1 Equal      Int.Key: C
Key Action Map: 0 Internal TP/40L-88
Default Song  : 1 New Song
  
```

```

more MAIN MAPS OUTPUT TEMPO more
  
```

Velocity Map (Master)

Change the Master Velocity Map setting if you find that the PC3K is not producing the desired velocities (too loud or too quiet) based on your playing style (how light or heavy that you play the keys.) The default map provides the widest range of velocity expression, but you may want to choose a different map if the default does not suit your playing style.

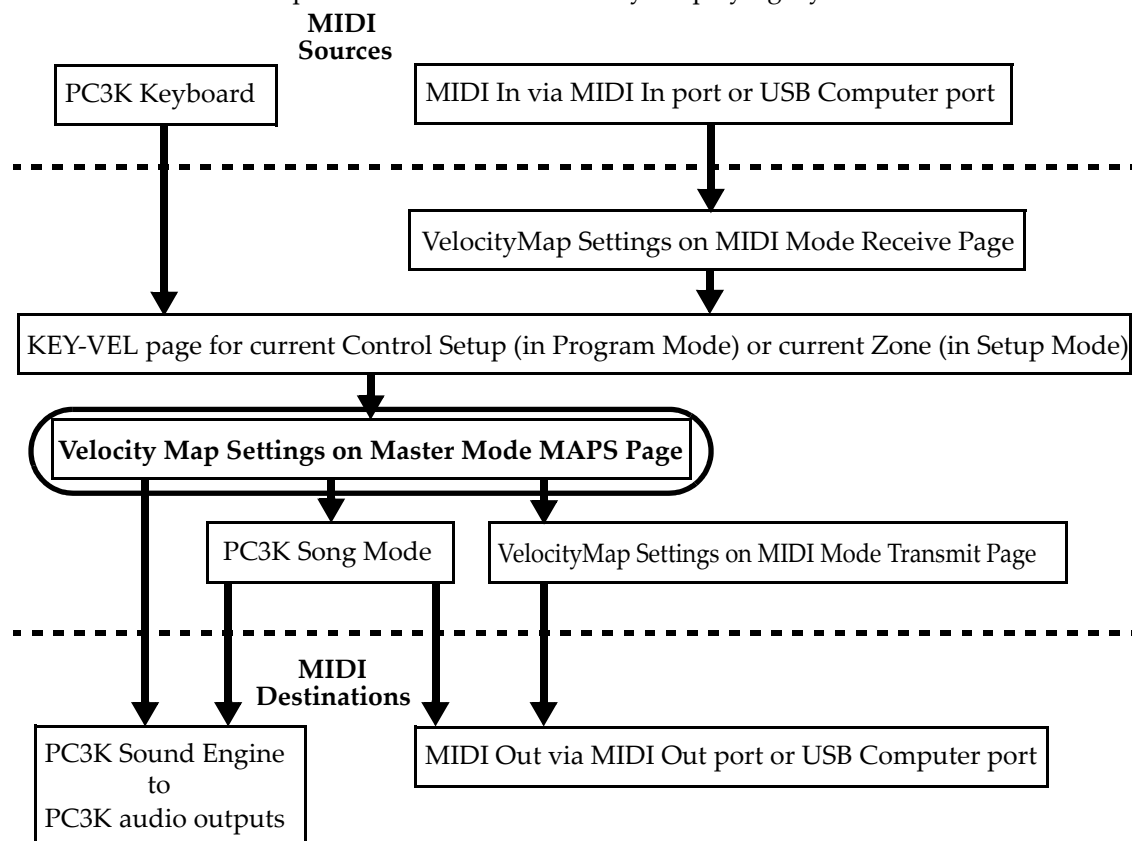

The Master Velocity Map is an overall control for MIDI velocities used in the PC3K. MIDI velocities are values created for each note depending on how hard you strike a key. The Master Velocity Map affects MIDI velocity values for all MIDI sources and destinations used in the PC3K (see the circled box above for its location in the MIDI signal flow.) Different maps used for the Master Velocity Map generate different MIDI velocity values for the same physical key strike

velocity. Each map applies a different curve to received MIDI attack velocities and remaps them to new velocities before letting them pass. The default map provides the widest range of velocity expression, but you may want to choose a different map if the default does not suit your playing style. See the diagram above for the other pages that affect the MIDI attack velocity before and after reaching the Master Velocity Map.

The default map, **Linear**, allows MIDI velocities to pass unchanged. **Light 1-3** make it increasingly easier to produce high MIDI velocity values for the same key strike velocity (with Light 3 being the easiest,) so these maps may work better for users who play with a lighter touch. **Hard 1-3** make it increasingly harder to produce high MIDI velocity values for the same key strike velocity (with Hard 3 being the hardest,) so these maps may work better for users who play with a harder touch. **Piano Touch** simulates the general velocity response of an acoustic piano, and is best suited for playing acoustic piano programs. **Easy Touch** is similar to the Light settings, making high velocities easier to play, but it allows more sensitive control over playing high velocities by not boosting the MIDI velocity for fast strike velocities as much as it does for medium strike velocities. **GM Receive** mimics the velocity map commonly used by keyboards that use the General MIDI (GM) sound set. The GM Receive map makes medium strike velocities produce higher MIDI velocities compared to the Linear map. GM Receive effects notes from the PC3K's keyboard as well as the MIDI in port. This map is automatically used when the PC3K is in GM mode (see *General MIDI Mode (GM On, GM Off)* below,) though users may want to use the GM Receive map when generating MIDI outside of GM mode which will later be played back by a GM system.

Pressure Map (Master)

Change the Master Press Map setting if you find that the PC3K is not producing the desired MIDI pressure (aftertouch) values (too high or too low) based on your playing style (how soft or hard that you press the keys.) The default map provides the widest range of pressure expression, but you may want to choose a different map if the default does not suit your playing style.

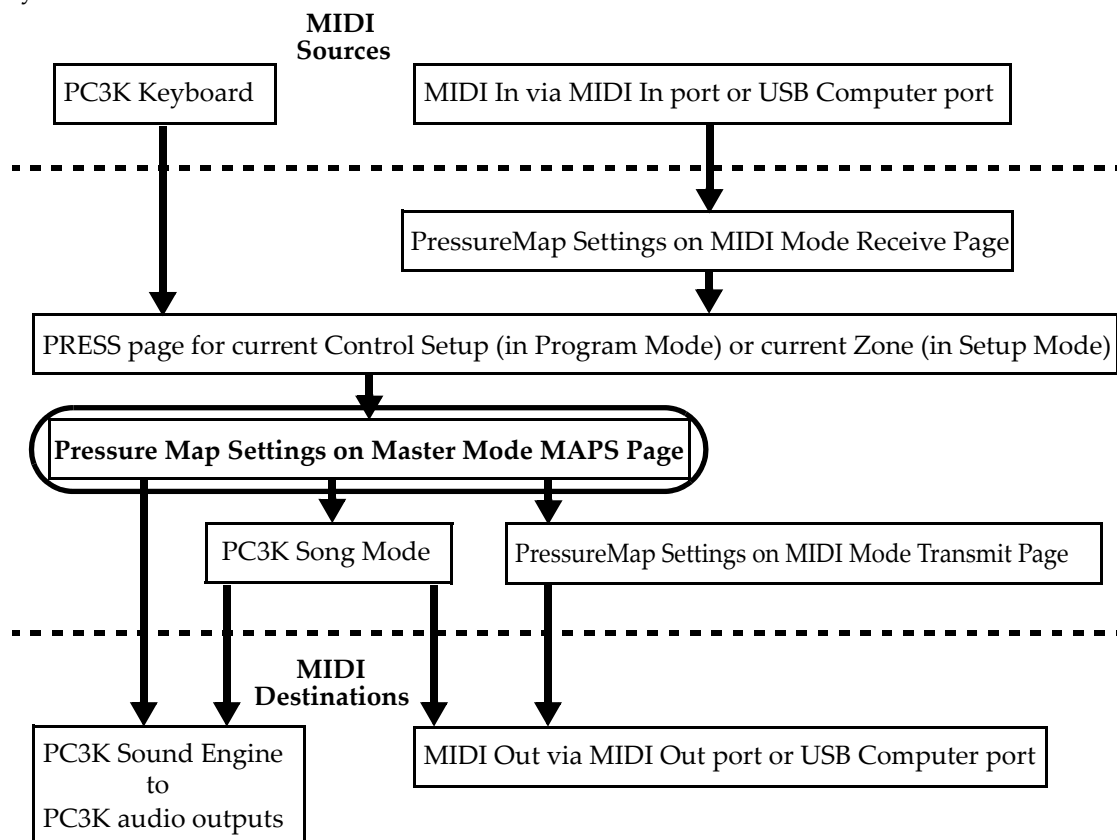

The Master Press Map is an overall control for MIDI pressure (aftertouch) values used in the PC3K. MIDI pressure (aftertouch) values are created for each note depending on how hard you press on a key that is being held down. The Master Press Map affects MIDI pressure (aftertouch) values for all MIDI sources and destinations used in the PC3K (see the circled box above for its location in the MIDI signal flow.) Different maps used for the Master Press Map generate different MIDI pressure (aftertouch) values for the same physical key press value. Each map applies a different curve to received MIDI pressure (aftertouch) values and remaps them to new values before letting them pass. The default map provides the widest range of pressure (aftertouch) expression, but you may want to choose a different map if the default does not suit your playing style. See the diagram above for the other pages that affect MIDI pressure (aftertouch) values before and after reaching the Master Press Map.

The default map, Linear, allows MIDI pressure (aftertouch) values to pass unchanged. Maps 2-4 make it increasingly easier to produce MIDI pressure values for the same physical pressure applied to a key (with 4 "Easiest" being the easiest.) Maps 4-7 make it increasingly harder to produce MIDI pressure values for the same physical pressure applied to a key (with 7 "Hardest" being the hardest.)

Intonation

Most modern western music uses what is known as equal temperament. This means that the interval between each semitone of the 12-tone octave is precisely the same as every other semitone. However, many different intonation intervals have evolved over the centuries and across cultures and instruments, so equal temperament will not sound appropriate for certain styles of music. The PC3K supplies you with 17 different factory intonation maps which are useful for a range of different styles. By changing the value for this parameter, you select from among the intonation maps stored in the PC3K's memory. You can further customize each map or create your own by editing a map (see *Editing Intonation Maps* below.) Each of these maps defines different intervals between each of the semitones in a single octave (used for all octaves) by setting pitch offsets for each note in cents.

Scroll through the list of Intonation maps, and listen for the differences between semitones. Some of the intervals between semitones may be quite different from equal temperament, but you'll notice that all notes are precisely tuned with notes that are an octave apart. This is because the intonation maps set the intervals within a single octave, and apply those intervals to each octave.

Like many instruments before the adaptation of equal temperament, most of these intonation maps were designed to sound best in one specific key. Though some may have historically been in a different key, all of the PC3Ks factory intonation maps are set to root note C by default. You can change the root key of the current intonation map by using the *Int.Key* parameter (see the *Intonation Key (Int.Key)* section below.)

List and Description of Intonation Maps

0	None	No intonation map is used, intonation is equal but cannot be edited.
1	Equal	No detuning of any intervals. The standard for modern western music.
2	Classic Just	Tunings are defined based on the ratios of the frequencies between intervals. The original tuning of Classical European music.
3	Just Flat 7th	Similar to classic Just, but with the Dominant 7th flatted an additional 15 cents.
4	Harmonic	The perfect 4th, Tritone, and Dominant 7th are heavily flatted.
5	Just Harmonic	Approximation of a historical intonation.
6	Werkmeister	Named for its inventor, Andreas Werkmeister. It's fairly close to equal temperament, and was developed to enable transposition with less dissonance.
7	1/5th Comma	Approximation of a historical intonation based on the comma system.
8	1/4th Comma	Approximation of a historical intonation based on the comma system.
9	Indian Raga	Based on the tunings for traditional Indian music.
10	Arabic	Oriented toward the tunings of Mid-Eastern music.
11	BaliJava1	Based on the pentatonic scale of Balinese and Javanese music.
12	BaliJava2	A variation on 1Bali/Java, slightly more subtle overall.
13	BaliJava3	A more extreme variation.
14	Tibetan	Based on the Chinese pentatonic scale.
15	CarlosAlpha	Developed by Wendy Carlos, an innovator in microtonal tunings, this intonation map flats each interval increasingly, resulting in an octave with quarter-tone intervals.
16	Pyth/aug4	This is a Pythagorean tuning, based on the Greek pentatonic scale. The tritone is 12 cents sharp.
17	Pyth/dim5	This is a Pythagorean tuning, based on the Greek pentatonic scale. The tritone is 12 cents flat.

In general, you should select a nonstandard intonation map when you're playing simple melodies (as opposed to chords) in a particular musical style. When you use intonation maps based on pentatonic scales, you'll normally play pentatonic scales to most accurately reproduce those styles.

Editing Intonation Maps

To edit an intonation map or create a new map, select an existing map and press the Edit button to bring up the EditIntonationMap screen (*see below*.) Intonation maps are based around a root key, shown on the right of the top line of the screen. Use the **chan up/down** buttons to change the root key (this is the same as changing the Int.Key parameter (*see Intonation Key (Int.Key)*) below.) Intonation Key is not saved with the intonation map.) Use the cursor to move between note steps, each of which is labeled by its difference in keyboard steps from the root. Each step can be shifted by ± 200 cents (100 cents=1 half-step.) Use the alpha wheel, alphanumeric pad, or plus/minus buttons to enter the desired cent shift amount for each step.

```

EditIntonationMap                                     #KeyHL
Root: Oct                                           +6 : Oct
+1 : Oct                                           +7 : Oct
+2 : Oct                                           +8 : Oct
+3 : Oct                                           +9 : Oct
+4 : Oct                                           +10 : Oct
+5 : Oct                                           +11 : Oct
Delete Rename Save Exit

```

Press **Delete** to delete the map from memory. Press **Rename** to rename the map and save. Pressing **Save** gives you the option to save the map or rename and save. To create a new map, edit an existing map and choose Rename when saving. Press **Exit** to return to Master page 2. When exiting the editor, it will automatically give you the option to save the map if changes have been made. For more detailed instructions on these functions, see *Saving and Naming* on page 5-3.

Key Action Map

The Key Action Map determines the default way the PC3K responds to key action for specific keyboard component models. Generally speaking, you will not want to alter the Key Action Map. This parameter is included for the rare occasion when a PC3K has been setup at the factory for a different keyboard component model than the one installed. A user may discover that they need to change the Key Action Map when they have tried all of the Velocity Map settings and still do not feel comfortable with the key response of their PC3K. Different maps result in different responses from the PC3K for the same physical key action, and each map corresponds to a different keyboard component model. If you have changed this parameter and want to change it back to the default map for your PC3K, simply enter a value of 0 in the Key Action Map parameter field.

Intonation Key (Int.Key)

This sets the tonic, or base note from which the currently selected intonation map calculates its intervals. If you select **G** as the intonation key, for example, and the intonation map you select tunes the minor 2nd down by 50 cents, then G^\sharp will be a quartertone flat relative to equal intonation. If you change the intonation key to **D**, then D^\sharp will be a quartertone flat. If you use nonstandard intonations, you'll want to set Int.Key to the key you're playing in. If the Intonation parameter is set to **Equal**, changing Int.Key has no effect.

Default Sequence

The Default Sequence parameter specifies the song that is used as a template for new and clear songs in Song mode.

OUTPUT

The OUTPUT page has options for digital audio output volume and sample rate. You can also set the analog Aux outputs to mirror the primary analog outputs. You can also control the MIDI clock source and MIDI clock output.

```

Master Mode: OUTPUT Memory available: 94%
Output Clock      : Off
Dig. Out Volume   : Variable
Dig. Out          : 48 KHz
Aux Out Pair Mode: Normal
Clock Source      : Internal

more MAIN MAPS OUTPUT TEMPO more
    
```

Parameter	Range of Values	Default
Output Clock	Off, On	Off
Digital Output Volume (Dig. out volume)	Variable, Fixed	Variable
Digital Output (Dig.Out)	Digital Output List	48 KHz
Aux Out Pair Mode	Normal, Mirror Primary Outputs	Normal
Clock Source	Internal, External	Internal

Output Clock

To send a MIDI clock pulse to the MIDI Out port, set this parameter to **On**. Otherwise, set it to **Off**.

Digital Output Volume (Dig. out volume)

The Digital Output Volume parameter specifies the behavior of the PC3K's Digital Output. Setting this parameter to **Variable** makes the Digital Output respond to changes made on the volume slider. Setting this parameter to **Fixed** makes the Digital Output output a signal with a fixed volume.

Digital Output (Dig. Out)

This Digital Output parameter specifies the PC3K's digital output sample rate. Internally clocked sample rates go from 44.1K up to 192K.

Externally synced sample rates cover 20-220KHz in 3 ranges. Be sure the external clock frequency is within the range you select.

Aux Out Pair Mode

The Aux Out Pair Mode parameter specifies the behavior of the Secondary Audio Outputs (located on the back panel underneath the "Balanced Analog Outputs - AUX" label). Setting this parameter to **Normal** makes the Aux Outputs behave as such. Setting this parameter to **Mirror Primary Outputs** makes the Aux Outputs output the same audio signal as the Primary output.

Clock Source

With the Clock Source parameter, you can set the PC3K to generate its own tempo by setting Clock Source to **Internal**, or you can set the PC3K to sync up with the tempo from another device—assuming the device is sending MIDI clock data to the PC3K via MIDI or USB—by setting Clock Source to **External**. See *Important Note About External Sequencers*: on page 12-8 for related information.

TEMPO

Press the TEMPO soft button to go to the TEMPO page (see below.) When the Clock Source parameter is set to **Internal** (see *Clock Source* on page 11-11,) the Tempo parameter on the TEMPO page sets the PC3K's system tempo. The system tempo sets the tempo for all modes except Setup Mode, which has its own tempo settings. Also, in Song mode, changing to a new song will override the system tempo. The Tempo parameter values are in units of BPM (beats per minute).

MasterMode:TEMPO

Tempo : 120.00

Temporary TAP controller : Off

Tap

Done



You can also call up the TEMPO page from any other page by pressing the left and right cursor buttons simultaneously.

Set the Tempo parameter with the +/- buttons, the Alpha Wheel, or the alphanumeric pad. You can also set the system tempo by tapping the **Tap** soft button at the desired speed. You need to tap at least twice for a tempo to be calculated, though tapping several times (like on each beat of one or more measures) works best. The newly tapped tempo is displayed in the tempo field, and along the bottom four Program select buttons a lit LED moves from left to right at this tempo.

Alternatively, a temporary controller can be set for use in the Temporary TAP controller field, instead of using the **Tap** soft button. The Temporary TAP controller field lists groups of PC3K controllers in order of their usefulness for tapping. Listed first are the foot switches and switch buttons (though it would be easier to use the Tap soft button than set a temporary switch button.) After these is Note On, which lets you tap the tempo with any keyboard key. Last are the MIDI controller numbers, which includes all of the continuous controllers, though continuous controllers (such as a slider) are not easy or recommended for tapping the tempo. The Temporary TAP controller works only while on the TEMPO page and will remain selected when accessing the TEMPO page from other modes, but the selection will return to OFF the next time the PC3K is turned on.

You can also assign a controller to controller destination 168, Tap Tempo, to be used as a tap tempo button when not viewing the TEMPO page. For those who frequently use tap tempo, this is a time saving addition to any setup or control setup (see Chapter 7, *Setup Mode* for more on controllers and destinations.) Any MIDI values received by destination 168 send a tap signal to the tap tempo function. This would be best used with a programmable switch (or footswitch.) Configure the selected switch so that it is Toggled, has it's On and Off Controls set to destination 168 (Tap Tempo,) and set the On and Off Values to any value other than None. Entry and Exit State should be set to None.

General MIDI Mode (GM On, GM Off)

This soft button enables or disables General MIDI (GM) mode. When GM mode is off (the default,) the buttons is labeled GM On. Press the GM On soft button to enter GM mode. The PC3K will prompt you to confirm or cancel. When GM mode is on the buttons is labeled GM Off. Press the GM Off soft button to exit GM mode. The PC3K will prompt you to confirm or cancel. You can not access Setup Mode or Quick Access Mode while in GM mode. Aside from what is noted in this section, all other PC3K functions operate normally while in GM mode. In GM mode, the PC3K complies specifically with the General MIDI (GM1) specification.

An Overview of General MIDI

General MIDI is a specification created by the MIDI Manufacturers Association which defines specific features that a MIDI instrument must have (see the MMA website at www.midi.org for more information.) Among other things, the GM specification sets a standard bank of program names and numbers, as well as a standard drum mapping layout, so that sequences created on any GM instrument will playback with the correct instrumentation on any other GM instrument, no matter the manufacturer. GM has many uses, for example it makes it easy for musicians who use MIDI files to share ideas and collaborate while using different sets of equipment. Also many instrumental versions of public domain songs can be found for free on the internet as GM compatible MIDI files. These, like all MIDI files, offer certain advantages over audio such as small file size, the ability to edit, orchestrate, or change tempo to easily learn from the sequences, or even convert note information to standard notation with a third party application.

Overview of General MIDI Mode

Once enabled, Program mode will display the set of 128 standard GM program names on the right side of the screen (*see below.*) Aside from the different layout and program choice, Program mode operates normally (*see below for info on the left side of the screen.*) A default GM sequence will be loaded which sets FX sends for reverb and chorus, which are part of the GM specification. Drum programs will also be remapped to the GM drum map. The standard PC3K programs will not be visible until GM mode is turned off.

```
ProgramMode XPI0st  GM1 #Ch:1
                    127 Applause
Program assigned:   128 Gunshot
4096 GM Piano 1   + 1 Ac Grand Piano
                   2 Bright Ac Piano
                   3 El Grand Piano
Octav- Octav+ Panic Reset XPose- XPose+
```

Replacing Default General MIDI Programs

The PC3K's GM sounds consist of PC3K programs tailored to work well in all GM sequences, but you can also edit or exchange these programs to suit your taste. The PC3K provides you with a GM sound set editor which allows you to replace the PC3K's default GM programs with any other PC3K factory or user created program. For example, you could choose a different factory or user created piano program to replace the default GM program 1, Ac Grand Piano. This way, any GM sequence that uses GM program 1 would now use the new piano program that you selected. Alternatively, you could even choose a different instrument to replace the default GM program 1, such as PC3K program 47 Harpsichord. This way, any GM sequence that uses GM program 1 would now use the new harpsichord program that you selected. Using a PC3K program that does not resemble the instrument named in the current GM program would technically make the PC3K incompatible with GM, but some users may want to do this as a way to "remix" GM sequences.

It is easy to replace default GM programs in order to make a custom GM sound set. Once in GM mode, the right side of Program Mode screen displays a list of the GM programs with their standard GM names. The left side of the screen shows you what PC3K program is being used for the selected GM program. Pressing left on the cursor moves you to this field. Use the cursor's up/down buttons, the alphanumeric pad, the plus/minus buttons, or the alpha wheel if you wish to select a different PC3K program for the current GM program. Don't use the program or category buttons because these will change the currently selected GM program. The newly selected PC3K program will be used by the current GM program, though the name of the GM program will not change. To save these settings you must save the master table (see **Save** below.) Saved settings can be recalled after powering off or leaving GM mode. To restore GM mode's factory selected programs, press the **Reset** soft button (see below.)

OBJECT

Pressing the **OBJECT** soft button calls up the OBJECTS page (*see below.*) From here you can choose one of two utility functions for renaming or deleting selections of user created (or edited) objects. Press the **Rename** or **Delete** soft button to access each function (see below for details.)

The OBJECTS page also displays the number of user objects saved to internal memory (in the **UserObjects** field,) the maximum number of user objects that can be saved to internal memory (in the **MaxUserObjects** field,) and the amount of free internal memory (in the **IntMemoryFree** field, this does not include user sample RAM.) (*The **MaxUserObjects** field shows the maximum amount of user objects that can be loaded/saved to internal memory for all object types combined. Keep in mind each object type only has 2560 ID#s available to save/load objects to, many of which are used by factory ROM objects.*)



Note: *The number given for the **MaxUserObjects** field is based on loading/saving the smallest user objects to internal memory. When loading/saving larger user objects (such as Programs with many layers and Setups with many zones), the PC3K may run out of internal memory before the maximum number of user objects has been loaded/saved.*

The information on the OBJECTS page is helpful when organizing user objects. For example, when loading many user objects from an external source, you should first determine if there is enough internal memory available for the objects being loaded. If there is not enough internal memory available, use the **Delete** soft button to delete user objects. (*To save user objects before deletion, see The STORE Page on page 13-6.*)

The OBJECTS page also displays the current installed objects version (factory objects,) and the current installed OS version. This information is useful when installing updates.

```

MasterMode:OBJECT: $
UserObjects      : 738
MaxUserObjects  : 2400
IntMemoryFree   : 17 Mbytes
Object Ver      : 2.00.5
O/S Version     : 2.00.16134M

Rename Delete Done
    
```

Rename

The Rename utility allows you to rename an object without entering the object’s editor. The Rename page shows a list of all user created objects, grouped by object type (*see below.*) Use the alpha wheel or plus/minus buttons to select an object from the list. Press **Rename** to bring up the object Rename screen and enter a new name by following the standard renaming procedure. For more information, see *Saving and Naming* on page 5-3.

```

Master:Rename
Program      1029 Default Program
Program      1030 Big LA Strings
Program      1031 Horowitz Grand
Program      1032 P-Bass
Program      1033 SynOrkWhaleCall

Rename Cancel
    
```

As in all naming dialogs on the PC3K, you can do a double-press of the **Left/Right** cursor buttons to put the naming cursor on the last character of the string. This is helpful when putting unique characters at the ends of names.

Left/Right cursor button double-press -> Move cursor to the end of the name in any naming dialogue.



Delete

The object Delete utility is useful for deleting unwanted user created objects in order to increase free RAM space in your PC3K. On the main Delete page, for each object type you can select a bank of objects to delete, a range of objects to delete, or delete all objects. On the Delete advanced page, you can select a single object or multiple objects to delete.

To delete a group or range of objects, use the main Delete page (*see below.*) Use the cursor to select the left column, then use the cursor, alpha wheel or plus/minus buttons to select one or more object types from the list. Use the **Select** soft button to make your selection(s), which will be marked with a star. Select “All Types” if you want to delete all user objects (this will select all object types and numbers automatically.) Next, use the cursor to select the right column, then use the cursor, alpha wheel or plus/minus buttons to select one or more ranges of object numbers from the list. You can select object numbers by bank grouping (groups of 128), by number range (select “1...100 Range” use the **SetRng** soft button and choose any range of 2048 objects) or select “Everything” to delete all objects of the selected type. Again, use the **Select** soft

button to make your selection(s), which will be marked with a star. The **Clear** soft button will clear your selection(s) from the currently selected list. Press the **Delete** soft button to delete your selection, you will be given the choice to **Delete** or **Cancel**. The **Cancel** soft button on the main delete page will return you to the OBJECTS page.

```

MasterMode>Delete
Object type          Range/Bank
All types            1...128
Program              129...256
Algs                  257...384
Select Clear SetRng Advance Delete Cancel

```

To delete single or multiple objects, go to the Delete advanced page by pressing the **Advance** soft button on the main Delete page (*see below*.) The right column shows you a list of all user created objects. The left column tells you what type each object is, and objects are grouped by type. Use the alpha wheel or plus/minus buttons to select one or more objects from the list. Use the **Select** soft button to make your selection(s), which will be marked with a star. Use the **Type** soft button to jump to the lowest numbered object of the next group of object types. You can use the alphanumeric pad to jump to an object of the selected type by number, or enter 0 to jump to the lowest saved object number of the currently selected type. To review which objects you have selected, press the **Next** soft button to move to the next selected object in the list. Press the **Delete** soft button to delete your selection, you will be given the choice to **Delete** or **Cancel**. The **Cancel** soft button on the Delete advanced page will return you to the main Delete page.

```

MasterMode>Delete advance
Program 1029 Default Program
Program 1030 Big LA Strings
Program 1031 Horowitz Grand
Program 1032 P-Bass
Program 1033 SynOrcWhaleCall
Select Next Type Delete Cancel

```

For Delete and Delete advance, if any of the selected objects have dependents that were not selected, you will see the question: Delete dependent objects?

If you answer **Yes** to this question, all dependent objects of the selected objects are deleted, unless they are being used as dependents of other objects that are to remain in memory. Answering **No** will delete only those objects that were selected and not their dependents.

UTILS (UTILITIES)

Pressing the **UTILS** soft button calls up the UTILITIES page, which gives you access to two analytic and diagnostic tool. Additionally, pressing the two right-most soft buttons will call up the UTILITIES page from any mode or editor. The UTILITIES page appears as shown below:



Pressing the **MIDI** soft button launches MIDIScope™, a useful subprogram that lets you monitor the MIDI messages from the PC3K and those received via MIDI. This is a good way to make sure you're receiving MIDI from MIDI masters. It's also good for making sure your controls are assigned as you want them, checking your attack velocities, checking your controller values, etc.

Pressing the **Voices** soft button calls up the Voice Status page, which shows the PC3K's active voice channels as you play. The Voice Status pages displays each active voice as a solid rectangular block—for mono voices—or displays stereo pairs of voices as a > for the left channel voice and a < for the right channel voice. Whatever symbol the page displays, when the key of a voice is released, that voice's symbol on the Voices Status page turns into a dot during the release portion of that voice's envelope. When the voice decays to silence, it is no longer active, and the dot disappears. The Voice Status symbols appears as shown below:

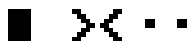

The Voice Status page gives you an indication of the envelope level of each voice, though not necessarily the volume level. Nonetheless, this can give you a valuable indication of how your voices are being used. For example, if all or most of the voices are active, then there's a good chance that when voice stealing takes place an audible voice will be reallocated.

The Voices utility works a bit differently for KB3 programs. The PC3K uses one voice of polyphony for every two tone wheels in a KB3 program. In the Voices utility, the voices used by the tone wheels appear as solid rectangular block, meaning that the voices are used for the KB3 program. They don't get reallocated at any time, since they're always on, even if you're not playing any notes. Any voices not dedicated to a KB3 program behave normally. So if you have a setup that contains a KB3 program in one zone, and VAST programs in one or more other zones, you can monitor the voice allocation of the non-KB3 voices in the section of the display that isn't constantly filled with solid rectangular blocks.

CPU usage is displayed in percent on the bottom of the page, which reflects how much of the PC3K's total available CPU power is being used from moment to moment. Generally, having more voices, complex Programs and effects in use at once will result in higher CPU usage.

CLOCK

Pressing the **CLOCK** soft button allows you to view the PC3K's System Clock (see below.) When objects are saved, they are time stamped with the date and time of this clock. This time stamp can be seen in the file properties when viewing the files with a computer.

MasterMode:system Clock

Time and date of the system:

17:42:03

hhmmss

Jan 22, 2009

monthddyyyy

Format

Chrono Set

Cancel

The **Format** soft button changes the view format of the date on this page. The **Set** soft button brings you to the Set clock page where you can set the system clock and date. Use the cursor to move between fields, use the alpha wheel or plus/minus buttons to change each field. On the Set page, press the **Set** soft button to save changes and return to the System Clock page, or the **Cancel** soft button to return to the System Clock page without saving changes.

The **Chrono** soft button brings up the PC3K's Chronometer (stop-watch) page (see below.) This can be useful for timing the length of songs or performances. Press the **Start** soft button to begin timing. The Chronometer will continue running even if you exit to other screens or modes. Press the **Stop** soft button to stop timing, the **Reset** soft button to reset the Chronometer, or the **Cancel** soft button to return to the System Clock page.

MasterMode:Chronometer

00:00:00

Reset

Stop

Start

Exit

Reset

Press the **Reset** soft button if you want to return your PC3K's memory to the state it was in when you bought it.

CAUTION: *Resetting the PC3K system causes ALL parameters to be restored to default values and ALL user objects to be erased. The PC3K will ask you if you want to delete everything (meaning all RAM objects), and a pair of Yes/No soft buttons will appear. Press No if you want to keep any objects you have saved. Press Yes, and everything stored in RAM will be erased. After a few seconds, the PC3K will return to the Program mode page.*

Loader

Pressing the **Loader** soft button calls up the Boot Loader. See Appendix B.

About

Pressing the **About** soft button calls up the general info page for the PC3K. On this page is the version of the installed OS and factory object. Press any key to leave this page.

Save

Pressing the **Save** soft button saves the Master Table object, which saves many important PC3K settings as defaults. Since the Master Table is always saved when exiting Master Mode (or MIDI mode,) the Save soft button is only needed in order to save when Master Table Lock is on (see *Master Table Lock (Master Lock)* on page 11-3, above.)

The Master Table saves the current configuration of the pages in Master mode. The Master Table also saves default settings for which program is selected on each of the 16 channels in Program mode (note that these channel settings are often altered by loading a song in Song mode.) The current channel and program selected in Program mode when the Master Table is saved will be loaded by default the next time the PC3K is powered on. The Master Table saves settings from MIDI mode for the Transmit, Receive, and Channels pages. The Master Table also saves settings for "favorite" programs (see the User Interface Basics chapter, page 3-4.) Lastly, the Master Table saves settings for the Master Effects page in Effect mode.

Only one Master Table object can be saved in the PC3K's internal memory, and this should be sufficient for most users. For users who wish to save alternate Master tables for quicker access to different system configurations, the object must be saved to an external device (see the Storage Mode chapter.)

SAMPLE MEMORY (MEMORY)

Press the MEMORY soft button to go to the SAMPLE MEMORY page. The SAMPLE MEMORY page shows information about the PC3Ks flash memory, which is used to store user loaded samples.

The Total Memory field shows the total user sample memory installed in the PC3K, 128 megabytes. The Used field shows how much of the available sample memory is currently being used by user samples. The Free field shows how much sample memory is available for use. The Fragmentation field shows the percent of the total memory available that can be reclaimed for use by running the Defrag function.

MAP

Press the MAP soft button to view the SAMPLE MEM MAP page. The SAMPLE MEM MAP page shows a map representing the total available sample memory its usage. This is a visual representation of the information on the SAMPLE MEMORY page. White spaces represent used memory, while blue spaces represent available memory. Blue spaces within white spaces represent fragmented blocks of memory.

Defragment (Defrag)

Press the Defrag soft button to defragment the PC3K's sample memory. Because this may take a long time, the PC3K will ask you to confirm or cancel defragmentation. Defragmentation can increase the available sample memory by reclaiming and grouping blocks of sample memory that have become "fragmented" and too small for use otherwise.

Preview Sample (PRVIEW)

Press the **PRVIEW** button to go to the PREVIEW page. The PREVIEW page can be used to automatically make a new keymap and program using any sample or group of sample roots. Programs created with the preview function are saved in Program Mode. This allows you to quickly hear what a sample or group of sample roots will sound like in a program. The preview function is also a quick way to begin making a new program which can be edited further if desired.

The preview function works with both user and factory ROM samples. If a single sample is selected a single keyrange keymap will be created. If a group of sample roots is selected, the preview function will try to create a keymap with multiple keyranges based on each sample's root key. If the sample or group of sample roots are stereo, the created program will be stereo.

To use the preview function, go to the PREVIEW page, select a sample or group of sample roots in the **Sample** field using the Alpha Wheel, +/- buttons, or the alphanumeric pad, then press the **OK** soft button. Next you will be shown a list of banks by ID# range (bank 1 = 1...128, bank 2 = 129...256, etc.) Use the Alpha Wheel or +/- buttons to choose a bank from this list. The preview function will save the created program and keymap using the lowest unused ID numbers available in that bank or higher. The preview function will never overwrite existing programs or keymaps. Saving to the User bank (**1025...1152** and above) will make it easiest to find the new program or keymaps in the Programs list or Keymaps list. Press the **Ok** soft button to choose the selected bank and create the new program and keymap. The new program will be selected in the currently selected channel in Program Mode.

Master Mode

Preview Sample (PRVIEW)

Chapter 12

Song Mode and the Song Editor

Getting Started with the Sequencer

The PC3K's sequencer is a powerful and versatile tool for songwriters, composers, and anyone else who wants to record and play back songs. As with any tool, however, it's best to start with the basics. If you are familiar with other sequencers, you will have no problem using Song mode in the PC3K. Read through this section, to learn about the features that make the PC3K's sequencer unique. See Chapter 15, *Tutorial: Song Mode* for a guide on basic recording in Song Mode.

What is a Sequencer?

A sequencer is similar in some ways to a multi-track tape recorder: you can record and play back all sorts of music and sounds, layer sounds on top of other sounds, and change or manipulate things that you've previously recorded. Unlike a tape recorder, however, you do not actually record sounds with a sequencer. Rather, you are recording commands that cause sounds to be played. Nonetheless, we will sometimes explain sequencer features by drawing analogies to familiar tape recording techniques such as splicing and overdubbing.

There are several advantages to recording a song by sequencing. For one thing, sequencer commands take up much less disk space than digitally recorded music would, so you can get a lot of information (that is, music) per megabyte. Furthermore, you can easily make changes to your sequences. For example, you can change individual notes, transpose parts, or change instrumentation. Lastly, you can share the sequences you create with other musicians.

Song Mode: The MAIN Page

The Song mode MAIN Page allows real time recording and playback, song and track selection. From this page you can view and edit the tracks' channel, program, volume and pan settings, as well as other useful items.

```

Song Mode MAIN Page
CurSng: 0*New Song* Tempo: 120
RecTrk: 1 Vol: 127 Pan: 64 Mode: Merge
Prog: 897 All Out Locat: 1:1

Track : R - - - - -
Channel: 1 2 3 4 5 6 7 8 9 10 11 12 13 14 15 16
more [Rec] [Play] [Stop] [MAIN] more
    
```

Parameter	Range of Values	Default
Current Song	Song List	0*New Song*
Recording Track	1 to 16, None, Mult	1
Program	Program List	Current Program

Song Mode and the Song Editor

Song Mode: The MAIN Page

Parameter	Range of Values	Default
Track Status	-, R, M, P	-
Channel	1 to 16	1 to 16 left to right
Volume	0 to 127	127
Pan	0 to 127	64
Tempo	20.0 to 400.0 BPM, EXT	120.0 BPM
Mode	Merge, Erase	Merge
Location	-9999:9 to 9999:9	1:1

The Events field on the top line displays the free RAM available for events in the selected song.

The Song Status, also on the top line of the display, is always one of the following:

- STOPPED** The default sequencer status; also appears when you press the **Stop** or **Pause** button.
- PLAYING** Appears when the **Play** button is pressed, but only if the following conditions are true: the **Record** was not pressed prior to pressing Play.
- REC. READY** Appears when the **Record** button is pressed while Song Status is STOPPED. REC. READY flashes, indicating that the sequencer is waiting to start recording.

Current Song (CurSong)

This shows the ID and 16-character name of the song currently selected for recording, playback, or editing. When a song is selected, Program Change, Volume, and Pan information is sent to all MIDI channels assigned to tracks that have data on them, and the internal clock is set to match the setting of the Tempo parameter. When looking for a previously saved song, you can scroll through songs while the sequencer is playing to quickly hear the beginning of each.

Tempo

The Tempo parameter determines the initial tempo for the selected song. The song will always start playback at the initial tempo. Whatever the tempo is set to when you record your first track will be the song's initial tempo. During playback, the current tempo is shown in this field. During recording, tempos dialed in here get recorded in the Tempo Track. The initial tempo and other tempo changes can also be edited in the event list for the Tempo Track. The Tempo track also allows you to program more precise fractional tempos with two decimal places.

To quickly change a song's initial tempo, press **Record** (the Song Status will change to REC READY), set the tempo desired, then press **Stop**. The initial tempo can also be changed with the Tempo parameter on the COMMON page in the Song Editor, or at the top of the event list for the Tempo track on the EVENT page in the Song Editor.



Note: You can also set the tempo using the tap tempo function. Press the left and right cursor buttons simultaneously to access the TEMPO page (see *TEMPO* on page 11-11.)

You can also set the tempo to be controlled by an external sequencer. Use the Alphanumeric Pad to enter "0" in the tempo field, and press enter. "EXT" will appear in the tempo field. Any MIDI Time Clock (MTC) signal received at the PC3K's USB or MIDI in port will now set the Song playback tempo.

Recording Track (RecTrk)

The RecTrk parameter determines which track is record enabled. Set the record enabled track to **Mult** to record more than one channel simultaneously.

When RecTrk is set to a single track (1–16), Record (R) is displayed for that track in the Track Status Indicator region (above the Track and Channels region). Conversely, with one exception, when any track's Status Indicator is changed to Record (R), that track is shown as the value for the RecTrk parameter.

The exception is when RecTrk is already set to **Mult**, you can select the record enabled tracks by toggling the Track Status Indicator to Record (R), and the RecTrk will remain set to **Mult**.

When **Mult** is initially selected, all of the empty tracks will be record enabled. Tracks containing data will remain set to play (P), but you can manually set them to record (R).

The parameter(s) below RecTrk change according to the value of RecTrk. If RecTrk is set to a single track (1–16), Prog is displayed and you can select the program to be assigned to that track. If you switch through the channels, the program also changes, showing the program currently assigned to that channel.

If you change RecTrk to **None** or **Multi**, the display changes to show Trk:#. This field indicates which track is currently being triggered by the keyboard, and you can use this Trk:# field to select a track.

Program (Prog)

Use this field to scroll through the programs in memory and select a program before initially recording each track of your song. A program selected on the current **RecTrk** becomes the track's initial program the first time that the track is recorded. An initial program is the program that will be used for a track when it is played from the start of bar 1 (or any other point if there are no program changes and Control Chase is turned on, see *Control Chase* on page 12-17.) Programs selected in Program or Quick Access Mode are selected as the program on the current **RecTrk** when you return to Song mode.

Follow these steps to change the current **RecTrk**'s initial program after recording has taken place on that track. While the sequencer is stopped, press **Record**, select the program, press **Stop**, and save the song. This preserves all changes you have made to any other track parameters: volume, pan, tempo, etc. You can also change the initial program at the top of a track's EVENT list (see *Song Editor: The EVENT Page* on page 12-31.)

Any MIDI program changes on the current RecTrk or Chan cause the ID and name of the track's program to change during playback. Program changes can be written to the event list of the current **RecTrk** by changing the **Prog** parameter while recording. If a program change takes place, the program will only return to the initial program if triggered by another program change, or if the sequencer is stopped and restarted from the beginning of the sequence. One exception to this is when using the Control Chase feature, you would only need to restart the sequence before the first program change in order to return to the initial program (see *Control Chase* on page 12-17.)

Prog changes to **Trk:#** if RecTrk is set to **None** or **Multi**. This field indicates which track is currently being triggered by the keyboard, and you can use this Trk:# field to select a track.

Track Number (Trk:#)

This parameter is available only when RecTrk is set to **None** or **Multi** (replacing the Prog parameter.) It indicates which track is currently being triggered by the keyboard, and you can use this field to select a track.

Volume (Vol)

You can set a volume level for each track as a value between **0** and **127**. If the channel of the RecTrk (or the control channel, if RecTrk is set to **Multi** or **None**) contains any recorded volume change (controller 7), the change will be reflected as the **Vol** parameter's value in real time, as well as on the MIXER page. Also, changing the **Vol** value while recording will write volume automation (controller 7 messages) to the current RecTrk's event list.

Initial Volume Settings



Each song file does not automatically save your volume setting for each track. To make a song save your volume settings for each track, you must write an initial volume for each track. Initial volume is the volume setting that will be used when your song is played back from the start of bar 1. An initial volume setting is essentially a volume automation message that is written before the first tick of a track. Initial volume settings are not automatically written during recording because they make it harder to try out different volume settings for a track. For example, an initial volume will reset any volume adjustments that you make during playback each time the song is stopped and played from the start of bar 1, or if the song is stopped and played from any point if the **Control Chase** parameter set to **On** on the Song:MISC page (see *Song Mode: The MISC Page on page 12-17.*) If you plan to try out different volume settings, it is easier if you write an initial volume after you have found the desired setting.

Setting Initial Volume Per Track

Follow these steps to change the current **RecTrk's** initial volume. While the sequencer is stopped, press **Record**, change the value of **Vol**, press **Stop**, and save the song (follow the same method to quickly set initial program or pan settings.) Initial program, volume, and pan can also be set at the top of each track's event list (see *Song Editor: The EVENT Page on page 12-31.*)

Setting Initial Values For All Tracks

An important last step before saving a finished song is to store initial values of Program, Volume and Pan for all tracks. This can be done at any time, but is best done as a last step if you plan to make a lot of adjustments to these settings. To write initial settings for all tracks, press the **Keep** soft button on the Song:MIXER page (see *Song Mode: The MIXER Page on page 12-12.*) After pressing the **Keep** soft button you must save your song to save these settings (you are automatically prompted to save upon exiting the Song:MIXER page.) Pressing the **Keep** soft button stores the *current* value of each track's Program, Volume and Pan settings as initial settings. Be sure that these values on each track are set to the value that you wish to store, as the settings may have changed if you have written any automation.



*Note: Don't use the **Keep** soft button if you would like certain tracks to not be stored with initial values. In this case, only set initial values for each desired parameter as described above (see *Setting Initial Volume Per Track.*)*

Volume Sources When An Initial Volume Is Not Set

If an initial volume is not stored with each track, the volume for each track of your song will be set depending on what mode you were in previous to loading the song. If you are in Song mode and have played a song, and then you load a song without initial volumes, the volume of each track of the newly loaded song will be set by the previously played song. Volume settings are tied to MIDI channels, so the volume of each track will be dependent on which MIDI channel is assigned to each track in each song. If you are in Song mode and you load a song that does not have initial volumes without playing another song first, the volume of the MIDI channel for each track is set depending on which mode you enter Song mode from. If you enter Song mode from MIDI mode, Program mode, or Quick Access mode, the volume of each MIDI channel is set in MIDI mode on the Channels page. If you enter Song mode from Setup mode, the volume of each MIDI channel is set if a zone uses the same MIDI channel on the SetupMode CH/PROG page (set with the **Channel** parameter.) If a zone does use a MIDI channel that one of the tracks in your song uses, the volume of that track will be set by the **ExitVolume** parameter of that zone (on the SetupMode: PAN-VOL page.) If multiple zones use the same MIDI channel, the

ExitVolume of the highest numbered zone that uses that channel will set the volume for tracks that use that channel. If **ExitVolume** is set to **NONE**, the value for **EntryVolume** is used. If **EntryVolume** and **ExitVolume** are set to **NONE**, then the track for that channel uses the volume set for that channel in MIDI mode on the Channels page. If there is no zone that uses certain channels used by your song, then those channels in your song will use the volume setting of those channels in MIDI mode on the Channels page.

Pan

You can set an initial pan position (the balance between the Left and Right audio channels) for the playback and recording of each track as a value between **0** and **127**. A value of **64** is center. If the channel of the RecTrk or the control channel contains any panning data (controller 10), the change will be reflected as the **Pan** parameter's value in real time, as well as on the MIXER page. Also, changing the **Pan** value while recording will write Pan automation (controller 10 messages) to the current RecTrk's event list.

Initial Pan Settings



Each song file does not automatically save your Pan setting for each track. To make a song save your Pan settings for each track, you must write an initial Pan value for each track. Initial Pan is the Pan setting that will be used when your song is played back from the start of bar 1. An initial Pan setting is essentially a Pan automation message that is written before the first tick of a track. Initial Pan settings are not automatically written during recording because they make it harder to try out different Pan settings for a track. For example, an initial Pan setting will reset any Pan adjustments that you make during playback each time the song is stopped and played from the start of bar 1, or if the song is stopped and played from any point if the **Control Chase** parameter set to **On** on the Song:MISC page (see *Song Mode: The MISC Page* on page 12-17.) If you plan to try out different pan positions, it is easier if you write an initial Pan after you have found the desired setting.

Setting Initial Pan Per Track

Follow these steps to change the current **RecTrk's** initial Pan. While the sequencer is stopped, press **Record**, change the value of **Pan**, press **Stop**, and save the song (follow the same method to quickly set initial program or volume settings.) Initial program, pan, and volume can also be set at the top of each track's event list (see *Song Editor: The EVENT Page* on page 12-31.)

Setting Initial Values For All Tracks

An important last step before saving a finished song is to store initial values of Program, Volume and Pan for all tracks. This can be done at any time, but is best done as a last step if you plan to make a lot of adjustments to these settings. To write initial settings for all tracks, press the **Keep** soft button on the Song:MIXER page (see *Song Mode: The MIXER Page* on page 12-12.) After pressing the **Keep** soft button you must save your song to save these settings (you are automatically prompted to save upon exiting the Song:MIXER page.) Pressing the **Keep** soft button stores the *current* value of each track's Program, Volume and Pan settings as initial settings. Be sure that these values on each track are set to the value that you wish to store, as the settings may have changed if you have written any automation.



Note: Don't use the **Keep** soft button if you would like certain tracks to not be stored with initial values. In this case, only set initial values for each desired parameter as described above (see *Setting Initial Pan Per Track*.)

Pan Sources When An Initial Pan Is Not Set

If an initial Pan is not stored with each track, the Pan for each track of your song will be set depending on what mode you were in previous to loading the song. If you are in Song mode and have played a song, and then you load a song without initial Pan settings, the Pan of each track of the newly loaded song will be set by the previously played song. Pan settings are tied to MIDI channels, so the Pan of each track will be dependent on which MIDI channel is assigned to each track in each song. If you are in Song mode and you load a song that does not have initial

Pan settings without playing another song first, the Pan of the MIDI channel for each track is set depending on which mode you enter Song mode from. If you enter Song mode from MIDI mode, Program mode, or Quick Access mode, the Pan of each MIDI channel is set in MIDI mode on the Channels page. If you enter Song mode from Setup mode, the Pan of each MIDI channel is set if a zone uses the same MIDI channel on the SetupMode CH/PROG page (set with the **Channel** parameter.) If a zone does use a MIDI channel that one of the tracks in your song uses, the Pan of that track will be set by the **ExitPan** parameter of that zone (on the SetupMode: PAN-VOL page.) If multiple zones use the same MIDI channel, the **ExitPan** of the highest numbered zone that uses that channel will set the Pan for tracks that use that channel. If **ExitPan** is set to **NONE**, the value for **EntryPan** is used. If **EntryPan** and **ExitPan** are set to **NONE**, then the track for that channel uses the Pan setting of that channel in MIDI mode on the Channels page. If there is no zone that uses certain channels used by your song, then those channels in your song will use the Pan setting of those channels in MIDI mode on the Channels page.

Mode

If Mode is set to **Merge** you will be able to overdub when recording on a track containing previously recorded data. You'll usually want to set Mode to **Merge** when RecMode (on the BIG page) is set to **Loop**. Otherwise, each time through the loop, the previously recorded information will be erased.

If you set Mode to **Erase**, the previously recorded data on the record enabled track will be replaced with the new data only during the Bars and Beats you are actually recording, and the previously recorded data before and after the newly recorded Bars and Beats will be preserved.

Location (Locat)

The Bar and Beat displayed as the Locate value changes relative to current location of the song during playback and recording. You can set this to a negative Bar and Beat location to start playback a set length of time before the beginning of the song.

Whenever you set the Locate point, that location will be used as the return point when **Stop** is pressed. Simply press **Stop** again to reset the song to the top (1 : 1).

Mode Indicators (+ and x):

Mode Indicators appear only for tracks that already contain data.

A plus sign (+) appears above the Track Status Indicator of a track set to record (R) when the Mode parameter is set to **Merge**.

An (x) appears above the Track Status Indicator of a track set to Record (R) when the Mode parameter is set to **Erase**.

Activity Indicators

A small square above the Track Status Indicator of a track set to **Play** (P) or **Mute** (M) means the track contains data.

During playback and recording, the indicators above tracks containing any MIDI data will flash a small, filled-in square when any MIDI activity is detected.

Track Status Indicators

Using the **Up**, **Down**, **Left**, and **Right** cursor buttons to position the cursor onto a Track Status Indicator, you can toggle an empty track (-) into Record (R) with the Alpha Wheel or **Plus/Minus** buttons.

Once a track contains data, it will have a (P) as a Track Status Indicator, and it will be played during playback. You now will be able to toggle between Play (P), Mute (M), and Record (R).

The track selected as the RecTrk will display an (R), designating it as the recording track. If the RecTrk is set to **Mult**, initially all empty tracks will have Record (R) as a Track Status Indicator, any of which can be switched back to empty (–) if at any time recording on specific tracks is not desired.

If there isn't a track with an (R), the RecTrk parameter's value will be **None**. (The exception is when the RecTrk is set to **Mult** and you have switched all of the tracks out of record enable.)

Track Channels

Each track has a MIDI Channel that it uses to receive and transmit data. By default, tracks 1–16 of a new song are assigned to Channels 1–16 respectively, although a track can play or record on any channel and the same channel can be used for more than one track. Keep in mind, however, that only one program can be assigned to a channel at a time, so if you have more than one track assigned to the same channel, they'll play the same program—the one on the higher-numbered track, since that's the most recent Program Change command received on that channel.

Soft Buttons on the MAIN Page

This section contains descriptions of the functions of the function soft buttons, that is, the buttons with labels not in all-caps. As with all other modes, the soft buttons in Song Mode that have labels in all-caps call up different pages. See the following sections for descriptions on how these pages work.

The **Rec**, **Play**, and **Stop** Soft Buttons

NOTE: These buttons are similar to the transport controls on a tape deck. Some of those decks require you to press Play and Record simultaneously to begin recording. The PC3K's transport buttons aren't like that, however. It's important that you press only one of these soft buttons at a time to insure proper recording start points, and to always be sure of the current sequencer status.

The **Rec** soft button changes the Song Status to REC. READY if the current Song Status is STOPPED. If the current Song Status is PLAYING, it will be switched to RECORDING when you press **Rec**.

The **Play** soft button plays back any recorded data when pressed while the song status is STOPPED. Playback will begin from the bar and beat specified in the Locate parameter. *When the Song Status is REC READY, pressing the **Play** soft button will begin recording.*

The **Play** soft button functions as a Pause button, but only when the Song Status is PLAYING or RECORDING. Pressing **Play** while the song is playing will stop the playback, and the location remains at the current bar and beat, allowing you to continue from that location by pressing **Play** again.

Pressing **Pause** while recording will stop the recording process as if you had pressed **Stop**.

The **Stop** soft button halts the playback or recording, and resets the song's location to either the default Bar 1, Beat 1 value, or to whatever location you defined with the Locate parameter. If the location is defined as something other than Bar 1, Beat 1, press **Stop** twice to reset to 1:1.

Pressing **Stop** when the Song Status is RECORDING will always prompt the "Save changes to this song?" dialog (described below), and provides you with the opportunity to listen to the **new** song and compare it with the **old**, previously saved, song before answering **Yes** or **No**.

The PC3K also has dedicated front panel buttons for **Record**, **Play/Pause**, and **Stop**. You'll find them just below the eight mode buttons. Additionally you can control these functions from any external sequencer that sends MIDI Machine Control (MMC) messages. The PC3K will automatically listen to any MMC messages received at the USB or MIDI in port. The PC3K will also automatically send its own MMC messages from the USB and MIDI out port, enabling the

PC3K's transport to control an external sequencer. This works from any mode, though in Program mode you will want to make sure that the Demo Button function is set to off. You can do this from the Master Mode Main page. When Demo Button is set to off, you can still hear Program demos by pressing the cursor up and down buttons simultaneously.



Important Note About External Sequencers:

If using the PC3K transport controls to record to an external sequencer, you must be in Song mode with the RecTrk set to None. If this is not done, you will simultaneously record to the external sequencer and the selected RecTrk if in Song Mode, or activate the Quick Song Recording function from other modes. This will cause unwanted sequences to be recorded in the PC3K's sequencer.

If you are also triggering PC3K sounds from the external sequencer, you will run into the same issue when using the transport on the external sequencer (if it is sending MMC.) In this case, either turn off outgoing MMC on the external sequencer, or use the same precautions as above.

The Load and Save Buttons

The **Load** soft button calls up a scrolling list from which you can quickly locate and load a sequence. You can select a sequence using either the Alpha Wheel or **-/+** buttons, or you can enter a sequence's ID number.

The **Save** button calls up the "Save As" dialog.

The NewSng and ClrSng and Delete Soft Buttons

The **NewSng** soft button creates a new song using the Default Sequence (specified on Page 2 of Master Mode) as a parameter template. Pressing this button is the same as selecting **0*New Song***.

The **ClrSng** soft button creates a new song whose parameters are set to the default values listed in the table beneath this section's header (*Song Mode: The MAIN Page*). Keep in mind that the selected program for the new song will be the currently selected program.

Press the **Delete** soft button to delete the current song. The PC3K will present a prompt, at which point you may cancel, or confirm to delete the song.

The Save Changes Dialog

The following dialog appears after you have recorded a track and pressed **Stop**, or if you have entered the Song Editor and made changes, then pressed **Exit**, or if you press **Save** in the Song Editor.

```
Song: save Changes
```

```
Save changes to this song?
```

```
Playing   : NEW  
Locate    : 1 : 1 : 0  
PlyOld   PlyNew Stop Retry Yes No
```

The **PlyNew** soft button allows you to play the song with your last recorded performance. You will likely want to hear this first.

Pressing **PlyOld** will play the current song, minus the performance that you just recorded. You can toggle between Play Old and Play New without restarting the song by pressing either button while the song is playing. This is useful to check if your last performance was better or worse than what was previously saved (if anything was previously saved.)

The **Locate** field allows you choose a start time for the old or new playback. This is useful when you just want to hear a certain part of the song without listening to the whole thing. The **Playing** field displays whether to **NEW** or **OLD** data is playing.

Stop halts the playback of either the Old or the New version of the song you are currently auditioning. This also resets the song's start location to either the default Bar 1, Beat 1 value, or to whatever location you defined in the Locate field.

Pressing **Retry** restarts recording from the same point you last started recording at.

Yes saves the song with the performance you just recorded. Whatever was played back when you pressed **PlayNew** will be the version of the song saved when you press Yes. The "save as" dialog will be displayed:

SongMode:save as

Save New Song
(Replace New Song)

as: ID#1

Rename Save Cancel

Use the Alpha Wheel, +/- buttons, or Alphanumeric Pad to choose a free ID# location to save the song, or choose a used ID# location to overwrite a previously saved song with your new version. When overwriting a song file, the "save as" dialog displays "Replace" followed by the name of the file being replaced. Press **Rename** if you would like to change the song's name. Press **Save** to save the song, or **Cancel** to return to the previous screen.

If you decide not to save or rename, **No** returns you to the Song-mode page in which you were last recording. Changes to the current song are not saved, though the sequencer will remember changes to certain settings from the MAIN and BIG pages. These settings are Tempo, Merge/Erase Mode, Locate, track mute status, Time In, Time Out, Song End, Loop, Punch, and Metron. To permanently save these changes with the song, make sure to choose **Save** from the soft button menu before powering off or loading a new song. Alternatively, you will be prompted to save these changes upon loading a new song if the MAIN page settings were changed while recording or with recording armed, or if any of the BIG page settings were changed.

For more detailed instructions, see *Saving and Naming* on page 5-3.

Song Mode: The BIG Page

On the BIG page, the PC3K displays—in a large font, the page’s name—the current time/location of the “playhead” of the sequencer in a *Bar : Beat : Tick* format (like the Riff time/location display). Also displayed is the current status of the sequencer, and the BIG page’s six parameters.

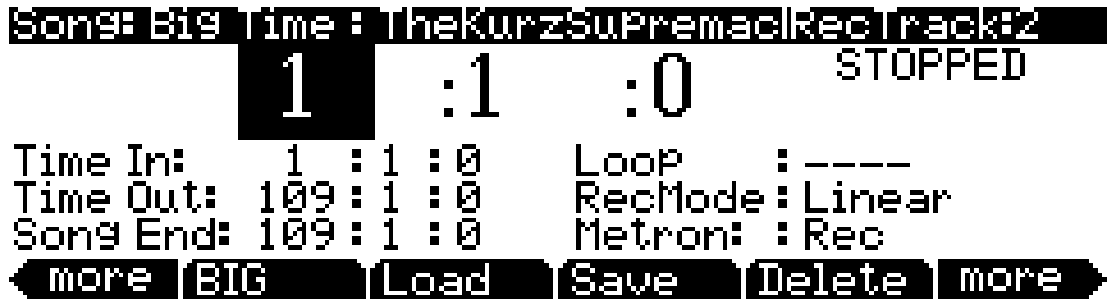

Parameter		Range of Values	Default
(Current Position)	(Bar)		
	(Beat)	Depends on Time Signature	
	(Tick)	0 to 959	0
Time In	(Bar)		
	(Beat)	1 to 4	
	(Tick)	0 to 959	0
Time Out	(Bar)		
	(Beat)	1 to 4	
	(Tick)	0 to 959	0
Song End	(Bar)		
	(Beat)	1 to 4	
	(Tick)	0 to 959	0
Loop		(----), Loop	(----)
RecMode		Linear, PunchIn, UnLoop	Linear
Metron		Off, Rec, Always, CountOff	Rec

Time In

The Time In parameter determines the start time for Loop or Punch In recording (more on this below).

Time Out

The Time Out parameter determines the stop time for Loop or Punch In recording.

Song End

The Song End parameter determines the end point for the song. Note that when Time Out and Song End are set to the same location, changes made to Song End are reflected in Time Out. When recording beyond your initially specified Song End point, you'll notice that the Song End location automatically moves and rounds to the next bar, so as to always be ahead of the playhead. It is possible to move the Song End point to a location before other MIDI events (i.e., in the middle of the current song)—the sequencer will ignore (but *not* delete) events after this point.

Loop

With the Loop parameter set to **Loop**, the sequencer will loop the segment of the song between Time In and Time Out.

RecMode

With the RecMode parameter set to **Linear**, the sequencer will record normally, from where ever you start, to where ever you stop, or until the Song End point is reached. With the RecMode parameter set to **PunchIn**, the sequencer will record events only between the points set for Time In and Time Out parameters on the BIG page.

To use the **UnLoop** setting, the **Loop** parameter must be set to **Loop**, and a loop length must be set with the Time In and Time Out parameters on the BIG page. With the RecMode parameter set to **Unloop**, any existing tracks will be played back as if they were looping from the Time In to the Time Out point, but they are actually being re-recorded linearly over absolute Bars and Beats until you press Stop. UnLoop allows you to record a linear track over a short looping section without first having to copy the section over and over again to achieve a new desired Song length. The End point of the Song is extended to the downbeat of the (empty) Bar immediately following the last Bar you were recording when Stop was pressed.

For example, let's say you have a recorded a four bar drum loop and now want to record an eight bar bass line. This would be a situation where UnLoop would come in handy. While the drum track keeps looping, the bass track will record in linear fashion, and the end point will be moved to the point at which you press Stop. Actually, the drum track will also change. It will play through its loop twice, but while the information is repeating in the loop, it will be recorded to the track. So now if you look at the drum track, you will see information in bars 5-8 (a duplicate of the information in bars 1-4).

Metron

The Metron parameter determines the recording modes in which the metronome will play. With Metron set to **Off**, the metronome doesn't play at all. With Metron set to **Rec**, the metronome only plays while recording is in progress. With Metron set to **Always**, the metronome plays during playback and recording. With Metron set to **CountOff**, the metronome plays only during count off (if the CountOff parameter on the Metronome page is set to something other than **Off**.)

Song Mode: The FX Pages

The four Song mode FX pages—FX, AUX1, AUX2, and Master Effects—work the same way as the Effects mode pages—EffectsEnable, Aux 1 Override, Aux 2 Override, and Master Effects. See the *Effect Mode and the Effects Pages* on page 9-4 for information on editing these pages.

Song Mode: The MIXER Page

The MIXER page shows the current settings for the program number, panning, and volume of each track (in groups of 8). The selected track number, as well as the range of tracks displayed on the page, are displayed in the upper right-hand corner of the screen. Use the **Chan/Layer** buttons or the cursor buttons to change the currently selected track. To get to other pages of tracks, continue scrolling past the first or last track on the page. The bottom part of the screen displays current settings for the selected track including program number and name, panning, and volume.

Changing the settings for a track’s program, volume, or panning while the sequencer is recording will record these changes, viewable in the corresponding track’s EVENT page. Upon playback, these automated mixer parameters will display their changing values in real-time on the MIXER page. Below is an example MIXER page:

```

Song: MIXER | 18:00:00 | Track 1 <1-8>
  1      2      3      4      5      6      7      8
Pan: 64  64  64  64  64  64  64  64
Vol: 127 92  108 113 92  90  127 85
Prg: 243 318 107 232 55  501 355 1014
Out: Auto Auto Auto Auto Auto Auto Auto Auto
Cur: 243 BeastieRetroDrum Vol: 127 Pan: 64
Rec  Play  Stop  Keep  Done
    
```

Parameter	Range of Values	Default
Current Pan (Pan)	0 to 127	None
Current Volume (Vol)	0 to 127	None
Current Program (Prg)	Program List	None
Output (Out)	Auto, Pri., Sec.	Auto
Bottom Line (For Selected Track)	Current Program (Cur) **	Program List (Current Program)
	Current Volume (Vol) **	0 to 127 127
	Current Pan (Pan) **	0 to 127 64

**Uneditable, these values are an expanded view of the mixer values for the currently selected track, which can be edited in the first three rows of the MIXER page.

Out

Use the **Out** parameter to set the rear panel audio outputs used for each track of the current song. This parameter determines the output settings for the main program signal and insert effects of each track (for Aux effects output settings, use the Output parameter on the Song Mode AUX1 or AUX2 pages.)

A setting of **Auto** will make that track output audio based on the settings for the program used by that track. Program output settings are set in the Program Editor using the **Output** parameter on the top line of PROG FX page (see *Output on page 6-48* for details) or the **Output** parameter on the LAYER FX page (see page 6-49 for details.) A setting of **Pri.** (primary) will output track audio to the **MAIN** Balanced Analog Outputs. A setting of **Sec.** (secondary) will output track audio to the **AUX** Balanced Analog Outputs.

The Rec, Play, and Stop Soft Buttons

These soft buttons function as described in *The Rec, Play, and Stop Soft Buttons* on page 12-7.

The Keep Soft Button

Pressing the **Keep** soft button captures the current settings for *each track's* program, panning, and volume as the initial settings. Remember to save if you want these change to be permanent!

The Done Soft Button

If no changes were made in the MIXER page, pressing the **Done** soft button calls up the MAIN page. If changes were made, pressing the **Done** soft button calls up the "Save Changes" dialog.

Song Mode: The METRONOME Page

All of the parameters affecting the sequencer metronome are on the METRONOME page. Like the other pages in the Song Editor, you can save changes made in this page.



Parameter	Range of Values	Default
Metronome	Off, Rec, Always	Rec
Count Off	Off, 1, 2, 3, 4 (StartOnly, Always)	1 (StartOnly)
Program	Program List	998 Click Track
Channel	1 to 16	16
Strong Note	0 to 127	102
Strong Velocity	0 to 127	127
Soft Note	0 to 127	104
Soft Velocity	0 to 127	100

Metronome

This parameter determines the recording modes in which the metronome plays. With Metronome set to **Off**, the metronome never plays. With Metronome set to **Rec**, the metronome only plays during recording. With Metronome set to **Always**, the metronome plays during playback and recording. With Metronome set to **CountOff**, the metronome plays only during count off (if the CountOff parameter is set to something other than **Off**.)

CountOff

This parameter determines the number of measures the PC3K will count off before recording. With **StartOnly** selected, the PC3K will only count off at the beginning of a sequence. With **Always** selected, the PC3K will count off from any point in a sequence.

Program

This parameter determines the program with which the metronome is played. If you wanted a piano for a metronome, for instance, you could set Program to a piano program. The default program is **998 Click Track**.

Channel

This parameter determines the MIDI channel to which the metronome program and events are sent.

Strong Note

This parameter determines the MIDI number of the note played by the metronome for the downbeats (the "1" of each measure).

Strong Vel

This parameter determines the velocity of the note played by the metronome for the downbeats (the "1" of each measure).

Soft Note

This parameter determines the MIDI number of the note played by the metronome for the upbeats (the "2," "3," and "4" of each measure).

Soft Vel

This parameter determines the velocity of the note played by the metronome for the upbeats (the "2," "3," and "4" of each measure).

The *Rec*, *Play*, and *Stop* Soft Buttons

These soft buttons function as described in *The Rec, Play, and Stop Soft Buttons* on page 12-7.

The *Done* Soft Button

If no changes were made in the METRONOME page, pressing the **Done** soft button calls up the MAIN page. If changes were made, pressing the **Done** soft button calls up the "Save Changes" dialog.

Song Mode: The Filter Pages (RECFLT and PLYFLT)

On the RECFLT and PLYFLT pages you can specify what event are ignored during, respectively, recording and playback. Both pages have the same parameters with the same ranges of values, but you would use the RECFLT page to configure recording event-filtering, and the PLYFLT page to configure playback event-filtering.

Below is the RECFLT page.

```

SongEvent Filter Recording
Notes      : On      LoKey: C -1  Hi: G 9
           :         LoVel: 0    Hi: 127
Controllers: On      Controller: ALL
           :         LoVal: 0    Hi: 127
PitchBend  : On      MonoPress : On
ProgChange: On      PolyPress  : On
Rec       Play      Stop      Done
    
```

Parameter	Range of Values	Default
<i>Note Filter</i>	Notes	On, Off
	Low Key	C -1 to G 9
	Hi Key	C -1 to G 9
	Low Velocity	0 to 127
	Hi Velocity	0 to 127
<i>Controller Filter</i>	Controllers	On, Off
	Controller	ALL, MIDI Control Source List
	Low Value	0 to 127
	Hi Value	0 to 127
Pitch Bend	On, Off	
Program Change	On, Off	
Mono Pressure	On, Off	
Poly Pressure	On, Off	

Notes

With Notes set to **Off**, all notes are ignored during recording/playback. With Notes set to **On**, only the notes within the specified note range with velocities within specified velocity range are recorded/played.

LoKey

LoKey determines the lowest key that is recorded/played back when Notes is set to **On**.

Hi

The Hi to the right of LoKey determines the highest key that is recorded/played back when Notes is set to **On**.

LoVel

LoVel determines the lowest note on/off velocity that is recorded/played back when Notes is set to **On**.

Hi

The Hi to the right of LoVel determines the highest note on/off velocity that is recorded/played back when Notes is set to **On**.

Controllers

With Controllers set to **Off**, all controllers are ignored during recording/playback. With Controllers set to **On**, controller data only of the specified controller and only within the specified value range are recorded/played.

Controller

The Controller parameter determines which controller(s) is/are recorded/played back when Controllers is set to **On**.

LoVal

LoVal determines the lowest value for the specified controller that is recorded/played back when Controllers is set to **On**.

Hi

The Hi to the right of LoVal determines the highest value for that specified controller that is recorded/played back when Controllers is set to **On**.

PitchBend

This parameter enables/disables pitch bend events to be recorded/played back.

ProgChange

This parameter enables/disables program changes to be recorded/played back—this includes Controllers 0 and 32 (bank change).

MonoPress

This parameter enables/disables monophonic key pressure events to be recorded/played back.

PolyPress

This parameter enables/disables polyphonic key pressure events to be recorded/played back.

The *Rec*, *Play*, and *Stop* Soft Buttons

These soft buttons function as described in *The Rec, Play, and Stop Soft Buttons* on page 12-7.

The *Done* Soft Button

If no changes were made in the RECFLT/PLYFLT page, pressing the **Done** soft button calls up the MAIN page. If changes were made, pressing the **Done** soft button calls up the “Save Changes” dialog.

Song Mode: The MISC Page

The MISC page contains five miscellaneous (but very important and useful) sequencer parameters. The MISC page appears below:

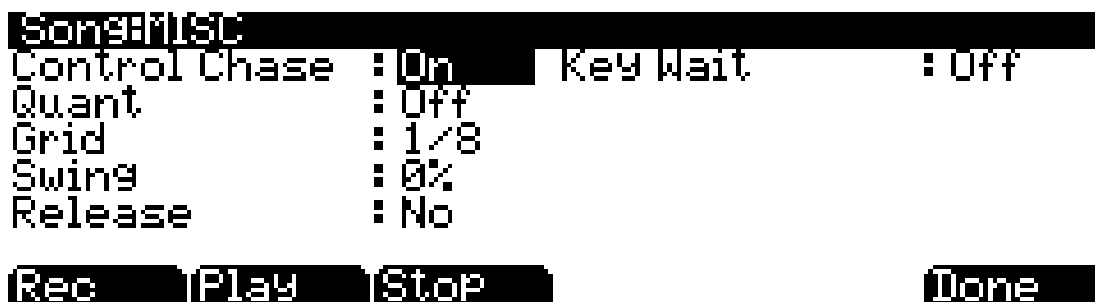

Parameter	Range of Values	Default
Control Chase	On, Off	On
Quantize	Off, 1 to 100%	Off
Grid Resolution	1/1 to 1/480	1/8
Swing	-100% to 125%	0
Release Quantization	Yes, No	No
Key Wait	Off, On	Off

Control Chase

A common shortcoming of many older sequencers is that when you start a sequence at some point in the middle of sequence, the controllers remain at their current levels until the sequencer comes across a controller event. Control Chase remedies this (generally) undesired behavior.

When Control Chase is **On**, all non-note MIDI events from the beginning of the song up to the current time are computed, and the most recent non-note MIDI event is sent out before starting playback. This ensures that the volume, panning, program changes, and other controllers for the song are correct, regardless of where you start the song. With Control Chase set to **Off**, the sequencer behaves as previously described.

Quant

The Quantize parameter determines the amount of real-time quantization (if any) applied to the sequence during recording. The percentage specified for this parameter is the amount of quantization the sequencer applies to the grid (see below) for each *Note event* recorded.

Note that using real-time quantization has the same effect as recording normally, and then using the Quantize Track Editing operation.

Grid

The grid parameter determines the resolution of quantization and the position of the grid points.

Swing

The Swing parameter determines the amount (in units of percent) of “swing” applied during quantization.

Release

The Release parameter determines whether or not note-off events are quantized.

Key Wait

With Key Wait set to **on**, a key strike will trigger playback of a sequence (if the play/pause button is armed,) or trigger recording of a sequence (if the record button is armed.)

Song Mode: The STATS Page

The STATS page is a display-only page that shows the status of the PC3K event pool. The event pool is used by all the sequences loaded at a given time in the system. These include: the current song, the compare song buffer, and up to 16 riffs.

The STATS page shown below is the state of the PC3K event pool with **0*New Song*** selected, and no other user objects loaded in any other modes:

```

SongStats
Max      : 110000      Used      : 56
Free     : 109944     Part.     : 110
Song     : 0          Temp      : 0
Riffs 1 : 0           2 : 0           3 : 0           4 : 0
        5 : 0           6 : 0           7 : 0           8 : 0
        9 : 0          10 : 0          11 : 0          12 : 0
       13 : 0         14 : 0          15 : 0          16 : 0
more RecFit PLYFit MISC STATS more

```

The events in the PC3K are similar to events of other sequencers with a single major difference: the Note events are stored as a single big event, i.e., one PC3K Note event is comprised of the note-on and note-off events. All other events are stored as single events on the PC3K.

The fields on the STATS page are:

- **Max** – the maximum number of notes/events in memory.
- **Used** – the total number of notes/events being used.
- **Free** – the number of notes/events that are free.
- **Part.** – the number of partitioned events, which are events for which space in memory is allocated. This is technical information of importance only to engineers (and maybe a few power users).
- **Song** – the total number of events (including notes) in the current song.
- **Temp** – the total number of events in the temp buffer (the temp buffer is used when grabbing events from a different song).
- **Riffs 1–16** – the total number of events in each riff.

The Song Editor

In general, you'll get to the Song editor pages by pressing the **Edit** button any time you're in Song mode. There's one exception: if the Program parameter is currently highlighted on the display, you'll enter the Program editor when you press **Edit**.

There are a few conventions shared by all of the Song editor pages. Displayed at the top of each Song editor page is the name of the page and the currently selected track (1–16, or all tracks). All of the values for the parameters found in any of the Song-editor pages are saved in the song object.

Song Editor: The COMMON Page

Press the **Edit** button on the front panel of the PC3K to display the COMMON page and begin editing a song. This is where you will find parameters common to all tracks, such as tempo and time signature, control parameters for effects, and soft buttons for switching to other Song editor pages.

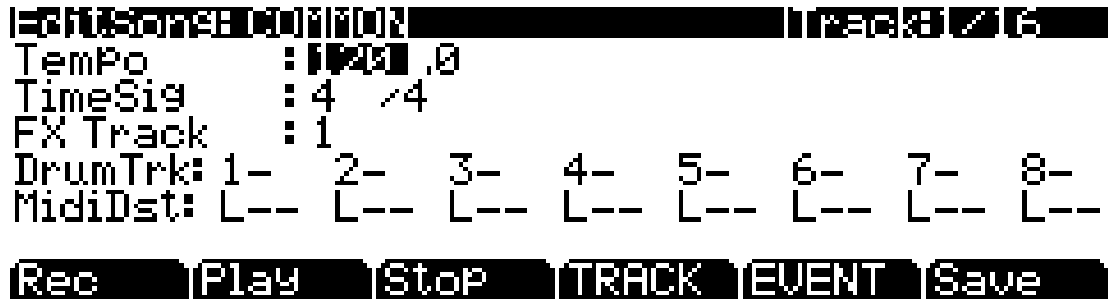

Parameter	Range of Values	Default
Tempo	0 (external), 20.00 to 400.00 BPM	120
Time Signature	(Numerator)	1 to 99
	(Denominator)	1, 2, 4, 8, 16, 32, and 64
FX Track	1 to 16	1
Drum Track	-, D	-
MIDI Destination	-, L, M, U	L

The currently selected track is displayed on the top line, though on the COMMON page this only applies to the DrumTrk and MidiDst parameters (see below.) The rest of the parameters on the COMMON page are global settings for the song and do not directly affect individual tracks.

Tempo

This is another place where the song's initial tempo can be set or modified.

TimeSig

Affects the click, playback looping, and locate function as well as some editing operations. Does not change the recorded data, though it does change the way data is displayed on the screen.

FX Track

The PC3K uses the channel of the track specified for FX Track as the Aux FX channel.

DrumTrack

Any of the song's tracks can be defined as Drum Tracks so that their Note events do not get transposed when a transposition is applied when using the track as a riff in a setup (see *Riffs* on page 7-55 and *Transpose/Root Note* on page 7-57.) With tracks designated as drum tracks, you can transpose a whole song that is being used as a riff, but the drum tracks will continue to play the correct sounds that they played in the original key. Otherwise, the drum sounds would change with each transposition.

Use the cursor buttons to select a track number. You can access 8 tracks at once, either tracks 1-8 or 9-16. Use the **Chan/Layer** buttons to the left of the display to select one of the tracks 1-8 (viewed in the top right corner of the page) in order to access tracks 1-8, or select one of the tracks 9-16 to access tracks 9-16. With the desired track number selected in the DrumTrk field, use the Alpha Wheel or -/+ buttons to toggle between **D**, to designate the track as a drum track, or **-** to designate the track as a non-drum track.

```
DrumTrk: 1D  2-  3-  4D  5D  6-  7-  8-
```

The Drum Tracks' settings do not have any effect on edits made on the TRACK page in the Song Editor. Any tracks defined as Drum Tracks are transposed when a transposition is applied to these tracks from the TRACK page.

MidiDst

```
MidiDst: --- L-- -M- --U LM- -MU L-U LMU
```

The MIDI data on each track has a destination assignment selectable with the TrackDest parameter. There are four possible indicators:

L = Local. The track's MIDI data will be transmitted locally only, to the PC3K's internal sound generator. None of the track's MIDI data will be sent to the USB or MIDI Out port.

M = MIDI. The track's MIDI data will be transmitted only to the MIDI Out.

U = USB MIDI. The track's MIDI data will be transmitted only to the USB port.

--- = None.

Pairs and groups of the above letters indicate that MIDI is being sent to each letter's corresponding destination.

Soft Buttons on the COMMON Page

TRACK – calls up the TRACK page. This page accesses useful track based edit functions. There is a selectable edit function that can be applied to the selected track or all tracks in your song. The TRACK page is described on page 12-21.

EVENT – calls up the EVENT page, an event-list style editor. On the EVENT page in the Song Editor, you can scroll through, modify, add, or delete any or all of the tracks' MIDI events. The EVENT page is described on page 12-31.

Rec, Play, and Stop – function as described in *The Rec, Play, and Stop Soft Buttons* on page 12-7.

Save – calls up the "Save as" dialog.

Song Editor: The TRACK Page

This page allows you access to useful track-based edit functions. These functions are:

Erase	Shift
Copy	Transpose
Bounce	Grab
Insert	Change
Delete	Remap
Quantize	

For each function, there is a set of parameters to control how the function operates, and on what region of the selected track(s). As usual, the top line of this page displays the selected track or tracks. Select the available current track(s) for editing by using the **Chan/Layer** buttons. Press both of the **Chan/Layer** buttons together to select All tracks.

Below is an example of the TRACK page for the Bounce function.



You will notice that the page is divided into two halves, with the right half being a separate box. This is called the Region/Criteria box. The parameters in this box are used to select the range of events (from a start Bar and Beat to and end Bar and Beat) for modification, as well as which types of events function will affect.

The parameters in this box will generally be the same for most functions. For some functions, however, some parameters may not apply. For example, Quantize and Transpose apply only to notes, while Remap applies only to Controllers. In addition to the Region/Criteria box parameters, the Locate parameter is also found on each function.

Since these parameters are common to most Track functions, we will define them first. Then we'll describe the individual functions along with the parameters specific to each, which are normally found on the left side of the page. The function Quantize has unique parameter in its Region/Criteria boxes. We'll describe those parameters along with the functions.

Once you've chosen a function and set the parameters to your liking, press **Go**. This executes the editing function. You can then play the sequence to hear the results of your edit. If you don't like your edit, simply exit the editor and press **No** when you are asked if you want to save. If you do like your edit, you can press **Done** and then **Save**, or just exit the editor and save the changes. Or, you can go to another edit function. Keep in mind though, that if you choose to perform more than one edit without saving, and you are not satisfied with one of the changes you make, you will have to exit the editor without saving and then redo each of the changes you made. That's why it's usually best to save after each successful edit.

Common Parameters for Edit Song: Track Functions

Locate

This parameter is available for every function on the TRACK page. It appears at the lower left hand corner of the page.

The Locate bar, beat, and tick will change in real time during playback and recording to reflect the song's current position. It can be set to any bar, beat, and tick, including negative values. Playback begins at, and Stop resets the song to the Locate bar, beat, and tick.

Region/Criteria Box Parameters

From and To

From and To are available in most TRACK edit functions to define a range of time on the selected track(s).

The From value defines the first bar, beat, and tick in a range of time selected for editing. The To value defines the final bar, beat, and tick in a range of time selected for editing.

Events

Any and all types of MIDI events are available for editing, selectable in this parameter. Some events will provide you with settings for a range of values, or other MIDI event specific criteria. Available Values are: All, Notes, Controllers, MonoPress, PitchBend, ProgChange, PolyPress.

When Events is set to **ALL**, all MIDI events on the track(s) you are editing, that occur in the region of time between the From and To settings, will be affected by the edit function.

When Events is set to **Notes**, note number and velocity ranges can be set for Note events.

LoKey

Determines the lowest note in a range of notes to be affected. This can be set to any MIDI note value; the default is C-1.

High Key (Hi)

Determines the highest note in a range of notes to be affected. This can be set to any MIDI note value; the default is G9.

LoVel

An attack velocity range can be specified as criteria for selecting Note events for editing. The LoVel parameter sets the lowest velocity a Note needs to have in order to be edited. Notes on the selected track(s) with attack velocities lower than the LoVel will not be affected by the edit. The available values are 1–127; the default is 1.

High Velocity (Hi)

The Hi parameter sets the highest attack velocity a Note needs to have in order to be edited. Notes on the selected track(s) with attack velocities higher than the value of Hi are not affected by the edit. The available values are 1–127; the default is 127.

When Events is set to **Controller**, the Controller(s) and a Controller value range can be set for Controller events.

Controller

The Controller parameter selects the Controller (if any) or all Controllers to be affected.

LoVal

You may further specify a particular range of values to edit by setting a high and low value. LoVal will define the lowest modifiable value in the selected controller's recorded data. Value ranges are not definable when Ctl is set to All. Available Values are 0–127.

High Value (Hi)

Hi defines the highest modifiable value in the selected controller's recorded data. Value ranges are not definable when Ctl is set to All. Available Values are 0–127.

Soft Buttons on the TRACK Page

FromTo is a quick way to define the region of time you intend to edit. There are a couple of ways to use this feature when the sequence is playing back in real time, and both ways will set the temporal boundaries of the region.

One way is to first position the cursor over the From parameter in the Region/Criteria box and then press the **Play** soft button. During playback, every time you press **FromTo**, the PC3K updates the value of From to match the current playback location. Position the cursor over the To parameter to change the value of To in a similar fashion.

If you haven't selected either the From or To parameter, pressing **FromTo** during playback updates From or To—or both—depending on the current playback location (the value of the Locate parameter) at the time you press **FromTo**. If you press it while the Locate value is earlier in the song than the current To value, the PC3K updates the From value. If you press FromTo again (without stopping playback) while the Locate value is later than the current From value, the PC3K updates the To value.

Play will start the playback of the song from the Bar and Beat set in the Locate parameter. When the song is playing, this soft button functions as a Pause button.

Stop stops the playback of the song and return to the Bar and Beat set as the Locate value.

Go performs any of the Track-based edit functions described above.

Done will return you to the EditSong : COMMON page.

Song Editor: Track Functions

Erase

This function erases specified events from a region of time, but it doesn't delete the region of time. The result is like erasing a section of recording tape. If you want to completely remove a segment and shorten the length of the track, you can do it with the Delete function.



Copy

Use the Copy function to duplicate the selected events from the current track and place them in the same track or on another track, either merging with or overwriting existing data.



If you do not want to copy all of the MIDI events in the defined range of time on the current track, use the Events parameter in the Region/Criteria box to select a specific MIDI event type you would like the edit function to affect. Some event types provide you more criteria selection parameters. It is often a good idea to set Events to **Notes** when copying, and then add any necessary controller or other data to the track at a later time.

DstTrack: 1 to 16 / All

Select a destination track for the copied events with the DstTrack parameter. All selected events described in the Region/Criteria box will be placed in the destination track(s) at any Bar and Beat you specify.

If the currently selected track is All tracks then the destination track will be All tracks as well.

No matter what channel the current track (source track) is set to when you use the copy function, the events will be played on the destination track's channel.

Location: Bars : Beats : Ticks

Specify a bar, beat, and tick location in the destination track where the copied data will be placed with the Location parameter. If the length of the copied region extends from the Location point beyond the song's existing End point, a new End point is defined.

Mode: Merge/Erase/Slide

The Mode setting determines whether the copied events merge with, or erase existing events on the destination track from the location point to the end of the copied region. With Mode set to **Slide**, the sequencer creates space for the new events, and slides the existing events to uniformly later times in the song.

Times: 1 to 127

The value selected for the Times parameter determines how many copies of the selected region are placed, one after another, in the destination track.

Bounce

Use the Bounce function to move the selected events from the current track to another track, either merging with or overwriting existing data on the destination track. The Bounce function differs from the Copy function in that the original data is not preserved in the original track. As on a multi-track tape recorder, Bounce will always put the data in the same timeline on the new track that it was on the old track.

```

|-----| TRACK |-----|
Function: Bounce
DstTrack: 1
Mode : Merge
From: 1 : 1 : 0
To : 1 : 1 : 0
Events: All

Locate : 1 : 1 : 0
FromTo Play Stop Go Done

```

DstTrack: 1 to 16

Select a destination track for the events to be moved to with the DstTrack parameter. All selected events described in the Region/Criteria box will be placed in the destination track at the data's original location.

No matter what channel the current track (source track) is set to when you use the bounce function, the events will be played on the destination track's channel.

Mode: Merge/Erase

The Mode setting determines whether the bounced events merge with, or erase existing events on the destination track from the location point to the end of the copied region.

Quantize

Use the Quantize function to adjust the timing of Note events. Keep in mind that only Note events are quantized; other types of events, such as controllers, are not quantized.

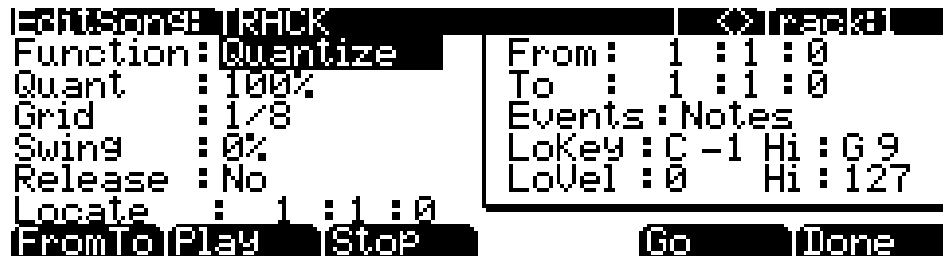

Quant: Off/1 to 100%

The Quantize parameter determines how much the selected Note events are moved towards grid locations. If set to **Off**, no aligning of previously recorded notes to grid locations will occur. If set to **100%**, every recorded Note event will be aligned to the closest grid location, defined by the Grid setting. Notes will be moved to a position half way between the grid location and the original Note-event location if Quant is set to **50%**.

Grid: 1/1 to 1/480

This setting determines the size of the Quantize grid, expressed as a fraction of a Bar with a 4/4 meter. Set Grid to **1/1** for whole note grid, **1/16** for sixteenth notes. All of the standard note durations and every fractional Bar divisions in between are available as the size of the Input Quantize grid.

Swing: -100 to 125%

The Swing percentage is applied to the quantize grid. **0%** swing is straight time, **100%** produces a swing feel (triplet feel). A positive Swing value determines how close every other grid location is moved to a point 1/3 of the way towards the next grid point. Negative Swing moves every other grid location closer to a point 1/3 of the way towards the previous grid point.

Release: Yes/No

Set the Release parameter to **Yes** if you would like each quantized Note event's Note Off message to be aligned to the grid location nearest to the time the key was originally released.

Shift

The Shift function allows you to offset the existing MIDI events forward or backward in time any number of ticks (1/480th of a Beat) and beats. This function only affects the End point if any of the shifted events are after the End point of the song.

Events can not be shifted beyond the End point or before Bar 1 : Beat 1 : Tick 0. The events can be shifted only as far as these temporal boundaries. All events that can't be shifted the full Ticks amount will be placed at the boundary location.



Amount: Bars : Beats : Ticks

The Ticks parameter specifies the number of bars, beats, and ticks that the MIDI events, from within the selected region, are moved forward (for positive values) or backward (for negative values) in time relative to their original locations.

Mode: Merge/Erase

The Mode setting determines whether the shifted events merge with, or erase existing events on the destination track from the location point to the end of the shifted region.

Transpose

Use the Transpose function to change the MIDI Note numbers of the selected Note events.



Semitone: -128 to 127 semitones

An increment of one semitone represents a change of one MIDI Note number. You can transpose Note events only within the range of MIDI Note numbers 0 to 127.

Grab

Grab is similar to the Copy function, except that the Grab function allows you to copy selected data from tracks that exist in other songs in memory.

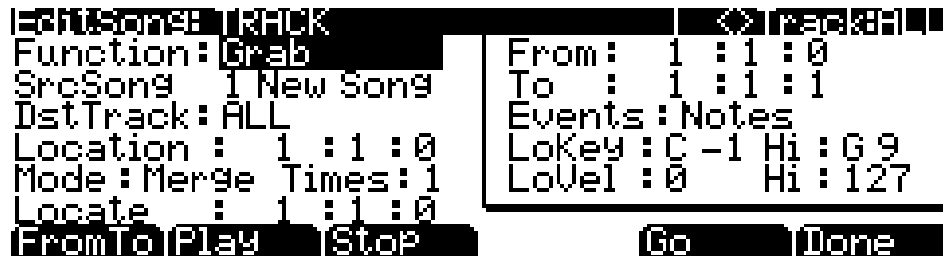

SrcSong: Song List

The Source Song parameter is set to the ID and name of the song in memory that contains the desired track data you wish to grab in order to use it in the current song. The source track is determined by the Track parameter displayed on upper right hand side of the page, selectable with the **Chan/Layer** buttons.

DstTrack: 1 to 16/All

Select a destination track for the grabbed events with the DstTrack parameter. All selected events from the source song and track described in the Region/Criteria box will be placed in the destination track(s) at any bar, beat, and tick you specify.

If the currently selected track is All tracks then the destination track will be All tracks as well.

No matter what channel the current track (source track in the source song) is set to when you use the grab function, the events will be played on the destination track's channel.

Location: Bars : Beats : Ticks

Specify a bar, beat, and tick location in the destination track where the grabbed data will be placed with the Location parameter. If the length of the grabbed region extends from the Location point beyond the song's existing End point, a new End point is defined.

Mode: Merge/Erase/Slide

The Mode setting determines whether the grabbed events merge with, or erase existing events on the destination track from the location point to the end of the grabbed region. With Mode set to **Slide**, the sequencer creates space for the new events, and slides the existing events to uniformly later times in the song.

Times: 1 to 127

The value selected for the Times parameter determines how many copies of the selected region are placed, one after another, in the destination track.

Change

The Change function is used to modify attack velocities, release velocities, or the values of any existing controller data on the current track. A static change of values can be made as well as having the change take place over a region of time.

Change can not modify or add data that doesn't exist on the current track. If you hear Note events played back on a track, then you know there is an attack and release velocity value for each one, and the effect of the Change function can usually be easily detected. Controller values are sometimes more difficult to change since there can be inconsistent gaps of time between each controller event.

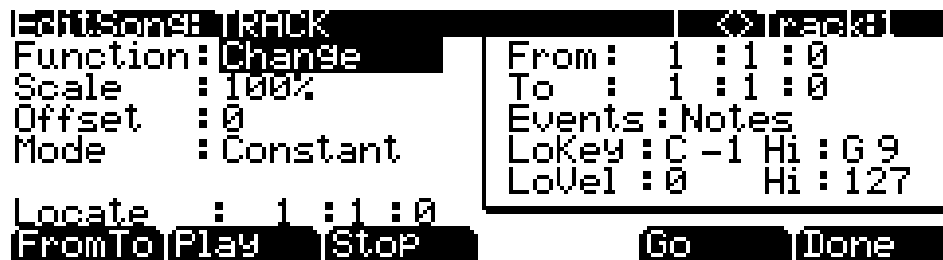

Scale: 0% to 20000%

The selected velocity or controller events' values can be changed to a percentage of the original values determined by the Scale parameter. A setting of **100%** has no affect. Values are scaled lower with a Scale percentage set from **0%** to **99%**. Low values can be set higher using a Scale percentage above **100%** on up to **20,000%**, although the maximum value of 127 can not be exceeded for any velocity or controller type.

Offset: -128 to 127

Offset can be used alone or in conjunction with Scale to add or subtract a set amount to or from the original (or scaled) values. Values for velocities can not be less than 1 or greater than 127. Values for controllers can not be less than 0 or greater than 127.

As an example, to set all Velocities to a value of 55, you would set Scale to **0%** (multiplies all original values by zero) and set Offset to **55** (adds 55 to the product of the Scale parameter).

Mode: Constant/PosRamp/NegRamp

Set Mode to **Constant** to have values modified in a uniform fashion, as determined by the Scale and Offset settings, for the entire selected region of time and range of values.

When the Change function is applied with Mode set to **PosRamp**, the selected velocity or controller values will gradually change over the region of time, defined by the locations set for the From and To parameters, from the original value to the new value determined by the Scale and Offset settings. The first events being modified within the region will have little or no change from their original values. The amount of Scale and Offset applied will increase as the song approaches the Bar and Beat defined in the To parameter, where the full amount of described change will occur.

You can set Mode to **NegRamp** to achieve the opposite dynamic effect of **PosRamp**. **NegRamp** works in the same way, but the amount of Scale and Offset applied will decrease from the full amount of change described by Scale and Offset to little or no change as the song approaches the bar, beat, and tick defined in the To parameter.

Remap

Use the Remap function to apply the values of any one type of controller data, already recorded on a track, to another controller type. The effect the real time changes of the "Old" controller had will be replaced by the effect the "New" controller has by using the exact same controller values.

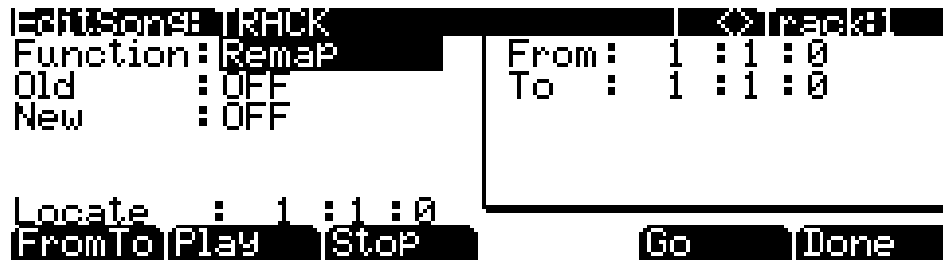

Old: Control Source List (0 to 120)

The "Old" Controller is set to the Controller type that you wish to remap. This Controller data must already exist on the current track in order to apply it to the "New" Controller type.

New: Control Source List (0 to 120)

The "New" parameter is set to the Controller code you wish to have use the existing values, once used by the "Old" Controller, to produce a different effect.

Song Editor: The EVENT Page

Every type of recorded MIDI event is visible from this page. You can view and change these events if necessary. Each track displays its initial program, volume, and pan at the top of its event list. You can also access the tempo track (*instructions below*.)

Initial Program, Volume, Pan	Location	Bar:Beat:Tick	Event Type and Value
	START	Prog: 318 HiPassMw	Vol: 92 Pan: NON
	1:1	1: 1: 0000	CTRL MIDI 28 127
	1:1	1: 1: 0001	>D#3 v100 ^59 0: 0: 231
	1:1	1: 1: 0481	>D#3 v81 ^57 0: 0: 229
	1:1	1: 1: 0959	>C#4 v103 ^59 0: 0: 239
	1:2	1: 2: 0479	>D#3 v61 ^59 0: 0: 017
	Buttons		Cut Copy Paste New Filter Done

The top line of the page displays the current song position in the center, and the currently selected track and corresponding channel on the right. Use the **Chan/Layer** buttons to select an active track to view and edit the MIDI events recorded on it.

To scroll through the events, make sure the location (Bar and Beat, in the first column) is highlighted. Use the Alpha Wheel, the **Up** and **Down** cursor buttons, or the **Plus/Minus** buttons. As you scroll through the events, each event is executed by the sequencer. In the case of Note events, you will hear the note played, although the duration will be short. If you have scrolled through a Sustain (MIDI Controller 64) message with an On value then you will hear the note sustain as if the sustain pedal was depressed. The note will continue to sustain until you scroll through a Sustain message with a value of Off.

You can also jump directly to a specific bar and beat by typing the bar number and beat number, then pressing **Enter**. Keep in mind if you have controller or program data previous to the point that you jump to, those events may not have been executed and you may hear unexpected results. For example, if you have program changes at bar 1 and bar 8, and you jump from bar 1 to bar 9, any notes you scroll through will be played with the program change from bar 1.

Initial Program, Volume, Pan

At the top of the event list for each track, you can view and change the initial program, volume and pan settings for the current track. See *Song Mode: The MAIN Page* on page 12-1 for details on initial settings for program, volume, and pan. Each of these parameters can be set to **NONE** by entering 0 on the alphanumeric pad and then pressing the **minus** button to find **NONE**.

Location

The first column represents the Bar and Beat Locations of the different events in a song. Scroll through the events on the selected track(s) with the Alpha Wheel or enter in a specific Bar and Beat on the alphanumeric button pad to jump to events occurring on that Beat. A quick way to jump to the End point in a track is to press **9999** and then **Enter** on the alphanumeric button pad.

Bar, Beat, and Tick

Bar, Beat, and Tick are editable parameters for each event. They determine when an event happens relative to the other events within the song.

Event Type and Value

The Event Type and Value region displays the MIDI event type (and related information) at each Event-list location in the song. Different event types display different kinds of information, and have different editable values.

The event type is the left-most field. You can highlight this field and change the event type. MIDI note events are denoted by a ">" followed by the note name. The ">" is effectively the event type for notes, and to change the event type, highlight the ">." To change the note, highlight the note name.

Table 12-1 lists the ranges of the editable event values:

Event Type	Values	
Program Change (PCHG)	0 to 127	
Pitch Bend (BEND)	-8192 to 8191	
Mono Pressure (MPRS)	0 to 127	
Poly Pressure (PPRS)	0 to 127	C -1 to G 9
MIDI Note Events (>)	Note events have four editable values: Note Name, Attack Velocity (indicated by a "v"), Release Velocity (indicated by a "^"), and Note Duration.	
	Note Number	C -1 to G 9
	Attack Velocity	v1 to v127
	Release Velocity	^1 to ^127
MIDI Controller Events (CTRL)	Controller events have two editable values: Controller Type and Controller Value. Defined controllers are referred to by their names.	
	Controller Type	Control Source List (0 to 127)
	Controller Value	0 to 127
Tempo Change	20.00 BPM to 400.00 BPM	

Table 12-1 MIDI-event Value Ranges

Soft Buttons on the EVENT Page

Cut: Removes the currently selected event from the Event list and temporarily stores it in a memory buffer so that you can immediately paste it into a new location.

Copy: Makes a duplicate of the currently selected event and temporarily stores it in a memory buffer so that you can immediately paste it into a new location.

Paste: Inserts the most recent cut or copied event into the Event list at the currently selected *Bar : Beat : Tick* location. The pasted event will share the same location with the event that already existed at that location in the Event list, but it will appear before the pre-existing event.

New: Inserts a new event by duplicating the current event.

Done: On the View page, returns to the EVENT page. On the EVENT page, returns to the COMMON page.

Tempo Track

To access the tempo track, use the channel **up/down** buttons to navigate to track 1, then press channel down. The tempo track functions the same as the other tracks, except the only event type available is tempo change.

Song Mode and the Song Editor

Song Editor: The EVENT Page

Chapter 13

Storage Mode

Use Storage mode to load, save, back up, and copy files between the PC3K and the outside world. Storage Mode can load and save with a USB device (such as a thumb drive) or with a computer by using the USB Computer port. Storage Mode features include:

- Save a group of PC3K objects (*Programs, Setups, Songs, etc.*) or a single PC3K object to a .P3K file (*see The STORE Page on page 13-6.*)
- Load a group of objects or a single object from a .P3K or compatible file (*see The LOAD Page on page 13-9 for details.*) (*See Appendix E for file compatibility details.*)
- Load an audio sample file (.WAV, or .AIF format) for use in a Keymap (*see page 13-16 for a tutorial on loading and using audio files, or The LOAD Page on page 13-9 for more details on loading audio files.*)
- Load a standard MIDI sequence file (.MID file) which can be played in Song Mode or used as a riff in Setup Mode (*see The LOAD Page on page 13-9 for details.*)
- Export a song from Song mode as a standard MIDI sequence file (*see Export on page 13-15.*)
- Export a list of controller assignments or a list of objects (*see Export on page 13-15.*)
- Organize files and folders on a USB device (*see The Utilities (UTILS) Page on page 13-14.*)

Storage Mode Page

To enter Storage mode, press the **Storage** mode button, and the Storage mode page will appear:

```

StorageMode      USB device
USB device: ready
USB PC connection: not connected

more STORE LOAD UTILS USBDrv more

```

Use this page to select the storage device you wish to use. The currently selected device will be read from or written to when you load, save, rename, or delete files in Storage mode. You can load and save with a USB device (such as a thumb drive) by using the USB Storage port or with a computer by using the USB Computer port on the rear of the PC3K (*see Using USB Devices below for details.*)

In the center of the page the currently selected storage device is highlighted. Use the cursor buttons, +/- buttons or the alpha wheel to select one of the two storage devices. (*You can also select the temporary USB drive (USB PC connection) by pressing the **USBDrv** soft button.*) When the temporary USB drive is selected, there will be a prompt telling you that the USB-MIDI connection will be disconnected. You must acknowledge this prompt to continue.

The status of the selected device will be displayed as either **ready** or you will see a “No connection” message. The top right-hand corner of the page displays the currently selected storage device. If you are having trouble selecting a device that you have plugged in, try exiting Storage mode and then entering Storage mode again.

After selecting a storage device, use the soft buttons on the Storage Mode page to start one of the available operations:

- STORE** Save objects or banks of objects as a .P3K file on the current device.
- LOAD** Load selected file(s) or object(s) from the current device into PC3K memory.
- UTILS** Organize files and folders on a USB device.
- USBDrv** Select the virtual USB drive when the USB computer port is connected to a computer.
- EXPORT** Export MIDI files created in Song mode or a list of Program info (controller assignments.)
- Format** Format the USB device currently connected to the USB Storage port.

Using USB Devices

There is a **USB Storage port** on the back panel of the PC3K, but it is easily accessible from the front of the instrument (see below.) You can plug a USB mass storage device such as a “thumb drive” into the PC3K for backing up, archiving, sharing your work, and updating your software. Any size USB mass storage device will work, though thumb drives are recommended for their portability, durability, and low price.

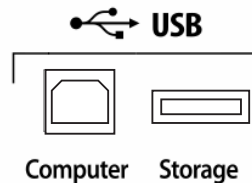

Note: Most USB thumb drives are compatible with the PC3K, but some older USB thumb drives and larger USB bus powered drives will not work with the PC3K if they require more than 100 mA of current (high power USB devices.) When attempting to use an incompatible USB device, the PC3K will display the message “USB device requires too much power”. The PC3K is designed to work with low power USB devices and can provide a maximum of 100 mA to a USB device. Power requirement specifications for thumb drives are not always made clearly available by the manufacturer, but a newly purchased thumb drive will most likely be compatible. If possible, check the power requirement specifications of your USB device before purchase.



Caution: A USB connector will only fit into the port if oriented properly, so don't force it into the port, as this may damage your PC3K or USB device. If you are having trouble inserting your USB connector into the port, try flipping the connector over.



Caution: Do not remove a USB device while the display says **Loading...** or **Saving...** Removing a USB device during a file transfer can cause data corruption.

Formatting a USB Device

See *Format* on page 13-15.

USB Computer Port

You can also transfer files directly to a computer that is equipped with a USB port by using the **USB Computer port** on the back panel of the PC3K (see above.) Connect a USB cable from the PC3K's USB Computer port to a USB port on your computer. When you enter Storage mode and select **USB PC Connection**, a virtual drive named **PC3K** will appear on your computer's desktop. Load files from your computer to your PC3K by putting files on the **PC3K** virtual drive, then selecting **USB PC Connection** in Storage mode to load the files. Save files from the PC3K to your computer by using this configuration with the Storage modes **Store** function. Saved files will temporarily appear on the **PC3K** virtual drive on your computers desktop, and you then must copy your saved files to another location on your computer. **You must copy data from the PC3K virtual drive to your computer's drive or else the data will be lost.**



Note: When transferring files to and from the PC3K via the USB Computer Port, the maximum size of files that can be transferred is approximately 1.6MB. This is suitable for most objects. For transferring audio sample files, use the USB Storage Port with a USB mass storage device such as a "thumb drive." When using the USB Storage Port to transfer files, the file size that can be transferred is limited only by the size of the USB mass storage device, and the PC3K's available object and sample memory.

When you leave Storage Mode or select the USB device, there will be a prompt telling you that the PC3K is turning back into a USB MIDI device. You must acknowledge this prompt to continue. The PC3K virtual drive will unmount from your computer.

Depending on your computer's operating system, you may see a device removal warning on your desktop after using the **PC3K** virtual drive. You may disregard such a message without worries of damage to your PC3K or computer.



Caution: Do not remove a USB device while the display says **Loading...** or **Saving...** Removing a USB device during a file transfer can cause data corruption.

Storage Mode Common Features

The following features are used in storage mode when saving or loading files.

Directories

A directory lets you group files together as you might separate documents using folders in a file cabinet. By default all storage devices have at least one “root” directory. To organize files in a USB device you can create additional directories, as well as subdirectories within directories. Directories appear in the file list with the indicator **<dir>** to the right of the directory name. See *The Utilities (UTILS) Page* on page 13-14 for details on creating, deleting, and renaming directories.

Path

The Path field shows the current directory on the current device. This field is displayed when loading, saving, or exporting files in Storage mode. The PC3K always displays the root (top-level) directory when you view a storage device.

The root directory is displayed as a backslash:

Path: \

If you press the **LOAD** button and load a file from a subdirectory called SOUNDS, the Path field will appear as

Path: \SOUNDS\

The backslash character is a directory separator, as in the following Path:

Path: \NEWTUNE\SAMPLES\DOGS\

This represents the directory DOGS, which is a subdirectory of the SAMPLES directory, which is a subdirectory of the NEWTUNE directory in the root directory. If the path is too long to fit on the top line of the display, it gets abbreviated. The maximum length of a path in the PC3K is 64 characters (including the backslash characters).

Common Dialogues

These are dialogues that the PC3K calls up when about to perform certain storage functions.

The Select Directory Dialogue

When storing an object—or group of objects—the PC3K prompts you to select a directory in which to save that object or group.

There are three navigating soft buttons on the left side of the bottom of the page:

NewDir Create new directory. Calls up the New Directory dialogue (see the following section)

Open Opens the highlighted directory.

Parent Moves you up one level in the directory hierarchy. If the display is already at the root directory, this button has no effect.

When you have chosen your directory, press the **OK** soft button to call up the File Name dialogue (see the following section) and complete the storing process.

The File Name/New Directory/Rename Dialogue

When you create a new file in Storage mode, create a new directory, or rename a file or directory, the PC3K prompts you to enter the object's name. This File Name dialogue appears as shown below, although both the New Directory and Rename appear and function similarly to the File Name dialogue:

```
Storage: File name
Path:\
Path:\
File Name : FILENAME
Delete Insert << >> OK Cancel
```

New file names will default to either **FILENAME** (after a powerup), or the name of the most recent file saved or loaded. New directory names will default to either **DIRNAME** (after a powerup), or the name of the most recent file saved or loaded. You can edit the name using the alphanumeric pad, alpha wheel, +/- buttons, **Left** and **Right** cursor buttons, the **Delete** and **Insert** soft buttons, and the << and >> soft buttons. See *Saving and Naming* on page 5-3 for more details on naming options.

Press the **OK** soft button to finish the operation.

The STORE Page

Pressing the **STORE** soft button calls up the Store page, where you can select groups of objects from the PC3K to store as a .P3K file in the current storage device. Only user created or user edited objects can be stored.



Note: To store an individual object or select objects individually instead of by range, press the **Advnce** soft button on this page to go to *The Store Advanced Page*. See *The Store Advanced Page* below for details.

```

Storage: Store  Memory available: 63904 Kb
Object type           Range/Bank
-----
All types             1...128
Program              129...256
Algs                  257...384
Select Clear SetRng Advnce Store Cancel
  
```

At the top right of the page, the display shows how much memory is available in the current storage device. Along the bottom of the page are the Store page's six soft buttons. Below is a description of the function of each soft button:

- Select** Select or deselect the highlighted Object/Type or Range/Bank. An asterisk (*) appears to the left of selected entries.
- Clear** Clear all selections in the current field. Note that if you press the **Clear** soft button while in the Range/Bank field, only selected Range/Bank entries are cleared; however, if press the **Clear** soft button while in the Object Type field, *all* selected entries in *both* fields are cleared.
- SetRng** Set a custom range of object ID numbers to store. Note in the Range/Bank field that the last entry is **1...100 Range**. You can set this range in the Set Range dialogue by pressing the **SetRng** soft button. If you try to set an invalid range—such as **102-23**—then the PC3K will inform you that the range is invalid.
- Advnce** Press the Advnce soft button to go to *The Store Advanced Page* where you can store an individual object or select objects individually instead of by range. See *The Store Advanced Page* below for details.
- Store** Store the selected objects to the current storage device. Pressing this soft button calls up the Select Directory dialogue.
- Cancel** Exits the Store page and returns you to the Storage mode page.

Storing Overview

To store user created or edited objects from the PC3K, you must pick the type(s) of object(s) to save and select the object ID range(s) to save (*see the sections below for details.*) After selecting object type and range, press the *Store* soft button. If any objects within the selected range(s) have dependent RAM objects that have not been selected, you will be asked if you want to save dependent objects. Dependent objects should usually be saved.

After pressing the *Store* soft button you will be prompted to choose a directory to save to (*see The Select Directory Dialogue* on page 13-4 for details.) Next, the File Name dialogue will appear (*see The File Name/New Directory/Rename Dialogue* on page 13-5 for details.) Name the file, and press

OK (*file names can be up to eight characters long.*) When the file is saved, the PC3K adds an extension (**.P3K**) to the filename. Note that although **.P3K** files are “collections” of objects, you can load individual objects for a **.P3K** file if you want to. See *Loading Individual Objects From a .P3K Or Compatible File Type* on page 13-10.

Saving Master Files

Among your choices in the Bank dialog are Master files. Master files consist primarily of the items on the Master mode and MIDI mode pages. Saving Master files is a good way to configure your PC3K (or another PC3K) to your performance or sequencing needs. For example, you might save different Master files with every sequence you create using an external sequencer. Then, when you load the Master file, you would have all the correct programs assigned to the appropriate MIDI channels.

Select Object Type To Store

Use the *Object Type* list on the left side of the page to select the type(s) of object(s) to save. Scroll through the list using the alpha wheel, cursor buttons, or **-/+** buttons. Use the *Select* soft button to select or deselect each object type. An asterisk (*) appears to the left of selected entries. Select “All types” to select all object types.

Select Object Range To Store

Use the *Range/Bank* list on the right side of the page to select the range or ranges of ID numbers to save for the selected object type(s). Object ID numbers to save can be selected in groups of 128 objects (also known as banks, for example, objects 1...128, 129...256, etc.) All object ID numbers can be selected by selecting “Everything.” A custom range of object ID numbers can also be created using the *SetRng* soft button. The custom range is the last entry in the *Range/Bank* list, by default it is called “1...100 Range”, but the name of the entry changes to the range set with the *SetRng* soft button.

Scroll through the *Range/Bank* list using the alpha wheel, cursor buttons, or **-/+** buttons. Use the *Select* soft button to select each bank range to save. An asterisk (*) appears to the left of selected bank ranges.

Ranges in the *Range/Bank* list must have a **(u)** symbol in order for object to be saved from that range. A *Range/Bank* list entry with a **(u)** symbol indicates that the range contains user created or edited objects which can be saved.

The Store Advanced Page

Pressing the **Advnce** soft button calls up the Store Advanced page. On this page, you can select and store objects individually, rather than by range. The Store Advanced page lists every user edited object in the PC3K. The objects are organized by numerical ID and object type.

There are five soft buttons on the Store Advanced page:

Select	Select or deselect the highlighted object. An asterisk (*) appears between the ID and object type of selected objects.
Next	Scroll to next entry. Same function as pressing the Down or + buttons, or turning the Alpha Wheel one click clockwise.
Type	Jump to next object type in the list.
Store	Store the selected objects to the current storage device. Pressing this soft button calls up the Select Directory dialogue.
Cancel	Exits the Store Advanced page.

Shortcuts when Storing Individual Objects

Selecting or deselecting all of the objects at once can be done with the following double-presses (two front-panel buttons simultaneously pressed):

- **Left/Right** cursor double-press: Select All Objects
- **Up/Down** cursor double-press: Clear All Selections

If you want to store most but not all of the items in a file (for example, if there are some songs in RAM that you don't want to be stored in the file), it may be fastest to first select all objects using the **Left/Right** double-press, and then manually deselect any unwanted items.

The LOAD Page

Pressing the **LOAD** soft button calls up the LOAD page (see below,) where you can load groups of objects from **.P3K**, **.PC3**, **.K26**, **.K25**, or **.KRZ** files, individual objects from within those files, a MIDI sequence file or files (**.MID**), as well as **.WAV** and **.AIF** audio samples from the current storage device (see below for details.)

Use the cursor buttons, +/- buttons or the alpha wheel to browse the files in the currently selected storage device. See below for descriptions of the soft buttons on this page, which help you browse and select the files in the currently selected storage device.

After selecting the file or files to load, press the **OK** soft button, and you will be prompted to choose a bank to load the selected object(s) or MIDI file(s) into. See *Loading Methods on page 13-11* for instructions on choosing a bank to load to after pressing **OK**.



Note: When selecting a file to load, file names on the Load page that are longer than eight characters will be shortened to eight characters and spaces will be removed. (*This has no effect on the names of objects stored within a .P3K or other compatible file type.*) When loading a MIDI file (**.MID**) to Song mode, the PC3K will attempt to use the MIDI file's internal sequence name as the Song name. If the internal sequence name can not be loaded, the first eight characters of the file name will be used as the Song name. Shortened song names can be renamed in Song mode.

Storage: Load

There are no files in this directory.

Path:\

Select SelAll Parent Open Ok Cancel

- | | |
|---------------|--|
| Select | Select or deselect the highlighted file. An asterisk (*) appears to the left of selected files. Multiple files can only be selected if they are in the same directory. Entering a new directory will deselect all files. |
| SelAll | Press the SelAll soft button to select or deselect all files in the current directory (directories within the current directory will not be selected.) Entering a new directory will deselect all files. |
| Parent | Moves you up one level in the directory hierarchy. If the display is already at the root directory, this button has no effect. Entering a new directory will deselect all files. |
| Open | Open selected directory or view objects within a .P3K file or other compatible Kurzweil file type for loading individual objects. See <i>Loading Individual Objects From a .P3K Or Compatible File Type</i> below for instructions on opening .P3K and other Kurzweil file types to view and load individual objects (<i>see Appendix E for compatibility details.</i>) Entering a new directory will deselect all files. Viewing objects within a .P3K file or other Kurzweil file will deselect any other files that had been selected. |
| OK | Load the selected .P3K file or other compatible Kurzweil file type, or the selected .WAV or .AIF file or files. See <i>Loading Methods on page 13-11</i> for instructions on using the Load dialogue presented after pressing OK . See below for details on loading .WAV and .AIF files. |
| Cancel | Exits the Load page and returns you to the Storage mode page. |

Loading .WAV and .AIF Audio Files

From the LOAD page, **.WAV** and **.AIF** audio files can be loaded and used with user created keymaps (see *Building a Keymap* on page 14-7 and *Editing Samples* on page 14-9.) Mono and stereo files can be loaded, 8 or 16 bit, with sample rates up to a maximum of 96000 Hz. Once samples are loaded to the PC3K's user sample flash memory, samples remain in the PC3K even when the power is off, until they are manually deleted. Also, once samples are loaded to the PC3K's user sample flash memory, there is no load time for those user samples when turning on the PC3K.

To load a user audio file or files, select one or more **.WAV** or **.AIF** files from the LOAD page file list and press the **OK** soft button. You will be prompted to choose a bank (group of 128 ID numbers) to load the sample in to. Use the Alpha Wheel or **-/+** buttons choose from the list of banks. It is recommended to load into the first user bank (1025...1152), this makes it easier to find your sample later on in the Sample list. Next, choose one of the loading method soft buttons (see *Loading Methods on page 13-11* for details.) Generally you will want to use the **Fill** soft button to load the sample into the selected bank. This uses the Fill loading method, which loads the sample into the lowest available ID#, starting in the chosen bank. Any existing samples will not be overwritten. Press the desired soft button to begin loading. *Samples load slowly, please be patient.* You can cancel loading a sample by pressing the **Cancel** soft button. On the EditKeymap page (see *The Keymap Editor* on page 14-1) loaded audio samples can be selected in the **Sample** field. On the EditKeymap page you can find an audio file with the highest ID# by selecting the **Sample** field, entering **0** on the alphanumeric keypad and pressing **Enter**, then press the **minus (-)** button once (below the Alpha Wheel.)

Loading Individual Objects From a .P3K Or Compatible File Type

Since a **.P3K** file can contain over 3000 objects, it is often useful to load only a subset of the information contained in a file. You can select individual objects or groups of objects (programs, effects, songs) for loading from within a single **.P3K**, **.PC3**, **.K26**, **.K25** or **.KRZ** file (see *Appendix E for compatibility details*.) The Load Object feature is accessible from the LOAD page. To activate it, scroll the file list until you have highlighted the file that you wish to load objects from.

Press **Open** to begin the Load Object dialog. The PC3K then scans the file contents in order to present a list of all of the objects in the file. Sometimes this procedure can take a few moments, depending on how many objects are in the file.

The objects in the list are grouped by type (program, setup, etc.). Scroll through the list using the alpha wheel, cursor buttons, or **-/+** buttons. Each line in the list represents one object, and displays the object's number in the list, as well as the object's type, ID number, and name. The ID number of each object is the number that was used to reference the object when the file was last saved by the PC3K. These numbers will usually be different after the objects are loaded, depending upon the bank (for example, 128...255) and mode that is specified for loading (see *Loading Methods on page 13-11* for details.)

Entering in a number from the alphanumeric buttonpad will jump to the indexed entry, and typing in a large number like 9999 will go to the end of the list.

The following soft buttons are used for selecting objects to load:

- Select** Select or deselect an object.
- Next** Jump to the next selected object in the list.
- Type** Jump to the next object of a different type.
- OK** Load the selected objects.
- Cancel** Exit back to the File List Dialog.

Press the **Select** button to select or deselect the highlighted object for loading. An asterisk (*) is placed to the left of the object index for any items that are selected.

The **Next** button will cause the index into the list to jump to the next selected object, forward in the list. When the end of the list is reached, the search will wrap around from the beginning. If there are no items selected, then this button doesn't do anything.

The **Type** button jumps to the next object of a different type from the one that is currently highlighted. This is a convenient way to find a particular type of object in the list.

When you are finished selecting objects to load, press **OK** and you will be prompted to choose a bank to load the selected object(s) into. See *Loading Methods on page 13-11* for instructions on choosing a bank to load to after pressing **OK**.

Cancel returns to the file list dialog, highlighting the file you just opened.

Select All/deselect All

Selecting or deselecting all of the objects at once can be done with the following double button presses:

- **Left/Right** cursor double-press: Select All Objects
- **Up/Down** cursor double-press: Clear All Selections

If you want to load most but not all of the items from a file (for example, if there happens to be a Master table in the file that you don't want to load), it may be fastest to first select all objects using the **Left/Right** double-press, and then manually deselect any unwanted items.

Loading Methods

Once you have pressed **OK** to load the selected file(s) or object(s), you must select the bank to load to and a loading method. This determines the object numbers that your loaded objects will have, and whether or not existing objects in the PC3K will be deleted when the new objects are loaded. You will see this dialog:

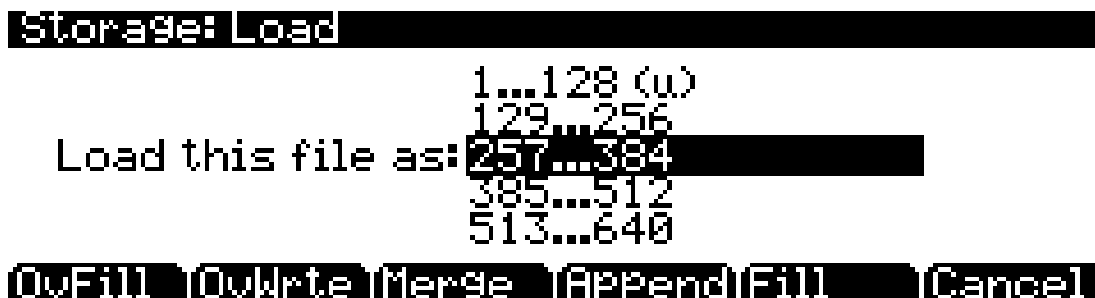

First select a bank range to load to, then select a loading method by choosing one of the soft buttons. The soft buttons control the mode for loading and renumbering of objects from the file.



Caution: Carefully read the description of each loading method before pressing one of the soft buttons. Some of the loading methods will delete existing objects in the PC3K.

Here's how the loading methods work:

- OvFill** First deletes all RAM objects in the selected bank, and then loads objects using consecutive numbering.
- Overwrt** First deletes all RAM objects in the selected bank, and then loads objects using the object ID numbers stored in the file.
- Merge** Preserve the object ID numbers stored in the file for the objects to be loaded, overwrite objects already in memory if necessary. For files that don't have ID numbers (.MID, .WAV and .AIF files,) Merge behaves the same as Fill.
- Append** Try to use the object ID numbers stored in the file for the objects to be loaded. If an ID number is already in use, increment the ID number until a free slot is found. For files that don't have ID numbers (.MID, .WAV and .AIF files,) Append behaves the same as Fill.
- Fill** Ignore the object ID numbers stored in the file. Try to use consecutive numbering from the beginning of the selected bank. If an ID number is already in use, increment the ID number until a free slot is found.
- Cancel** Cancel the object loading and return to the main Load page.

Typically, you will just want to use the **Fill** method. **Append**, **Merge**, and **Overwrt** try to preserve the numbers stored with the objects in the file, but this should only really be necessary if you depend on program numbers or effect numbers to be at a certain MIDI program change number. **OvFill** is like **Fill** except the selected bank (or Everything) is cleared out before loading.

Overwrt and **OvFill** operate in different ways after a selected bank has been filled up for a given object type (for example, after you have loaded more than 128 programs into a bank). **Overwrt** will continue to preserve the objectIDs stored in the file, and will individually overwrite objects in the bank following the just filled bank. **OvFill** does not overwrite past the end of the selected bank; it instead skips over object IDs that are in use, loading only into unused IDs. Because of this difference, it can sometimes be faster to load a file using **OvFill** rather than **Overwrt**. However, this applies only if the objects to be loaded would extend past the end of a selected bank.

Note that when loading into a specific bank (as opposed to loading as "Everything"), the object IDs in the file are used as follows: The "bank" digit is ignored, and the remainder of the number is used when the PC3K rebanks the object ID into the bank that you specify. For example, if you save Program 453 into a file, and load it back into the **129...256** bank, the PC3K will use the number **69** (its bank-specific ID in the **385...512** bank) when deciding upon a new object ID. If the 129...256 bank was previously empty, and the load mode is Append, then the program will end up with ID **197** (128 + 69).

For loading as "Everything," the ID number for an object stored in a file is taken literally, and not rebanked (except if **Fill** or **OvFill** mode is chosen).

The following example shows how each different loading methods affect how four programs load into a bank that already contains programs.

Example: Starting with the following objects already stored in the PC3K internal RAM:

Program ID	Program Name
129	Piano Stack
133	Ole Upright 1
134	WestCoastPno&Pad
139	The Ancient
140	DancePnoEchplex

Suppose you were to load a file containing the following objects into the **Base2 (129...256)** bank:

Program ID	Program Name
260	Brighter CP
261	TouchRezSynthCP
264	Inside Out CP
265	Pianet Classic

The following table shows the IDs that each program end up with when you load the programs from the **Classic Keys** bank (255...384) into the **Base2** bank:

Original Program ID	Program Name	Program IDs After Loading				
		OvFill	Overwrt	Merge	Append	Fill
129	Piano Stack	Deleted	Deleted	129	129	129
133	Ole Upright 1	Deleted	Deleted	Deleted	133	133
134	WestCoastPno&Pad	Deleted	Deleted	Deleted	134	134
139	The Ancient	Deleted	Deleted	139	139	139
140	DancePnoEchplex	Deleted	Deleted	140	140	140
260	Brighter CP	129	260	133	135	130
261	TouchRezSynthCP	130	261	134	136	131
264	Inside Out CP	131	264	137	137	132
265	Pianet Classic	132	265	138	138	135

The Utilities (UTILS) Page

Pressing the **UTILS** soft button calls up the Utilities page. Use the Utilities page to create directories (folders) on the current USB device, or use the Utilities page to delete, rename or copy files on the current USB device. See the soft buttons below for the each available function:

Soft Buttons on the Utilities Page

- | | |
|---------------|--|
| NewDir | Create a new directory (folder) in the current directory. Directories created by the PC3K can have names up to eight characters long. |
| Delete | Delete the highlighted file from the current device. |
| Rename | Change the name of a file. |
| Copy | Copy a file to a different directory. After pressing <i>Copy</i> , you must select a directory to copy to, press the <i>Open</i> soft button to open the directory to copy to, then press the <i>Ok</i> soft button to copy the file. You can also press the <i>NewDir</i> soft button to create a new directory to copy to. |
| Open | Opens the highlighted directory. |
| Parent | Moves you up one level in the directory hierarchy. If the display is already at the root directory, this button has no effect. |

Export

Press the EXPORT soft button to go to the Export page. The Export page allows you to export MIDI files created in Song mode, lists of controller assignment info that are automatically created for each Program and each Chain, or a list of all objects in text format. Developers can also export an object in XML format, or export a KPN.

To export a MIDI file created in Song mode, the song must be currently loaded in Song mode. Go to Song mode and load the desired song, then return to the Storage mode EXPORT page and press the **Song** soft button. You will be prompted first to choose a directory to save the file into, and then you will be prompted to name the MIDI file. When you name the file, you can use the **Type** field to choose to export either a Standard MIDI File type 1 (saves with multiple channels,) or Standard MIDI File type 0 (saves all channels as 1 channel.)

To export a list of controller assignment info for all Programs or for all Chains, press the **PrInfo** soft button or the **FXInfo** soft button. You will be prompted to choose a directory to save into, and then you will be prompted to name the info file. A comma separated value file will be exported.

To export a list of all objects in text format, press the **ObjLst** soft button. You will be prompted to choose a directory to save into, and then you will be prompted to name the file. A comma separated value text file will be exported, listing each object type with ID number, object name, and whether the object is internal or user.

To export an object in XML format, press the **ObjFmt** soft button. Choose an object from the list using the Alpha Wheel, +/- buttons, or the alphanumeric pad, then press the Ok soft button. You will be prompted to choose a directory to save into, and then you will be prompted to name the file.

To export a KPN, press the **KPN** soft button. Choose a Domain and Channel, then press the Ok soft button. You will be prompted to choose a directory to save into, and then you will be prompted to name the file.

Format

USB devices come formatted and ready to use with the PC3K. If you ever need to format a device, however, you can use any computer with USB device formatting capability, or format it using the PC3K.

To format a USB device with the PC3K, plug the USB device into the PC3K's USB Storage port, then press the **Storage** button to enter Storage mode. Press the soft button labeled **Format**. The PC3K will ask you if you want to format. Press the **OK** soft button to format the device, or the **Cancel** soft button to return to the Storage mode main page.



Caution: Formatting will erase all files on the USB device, make sure anything that you wish to save is backed up on another device.

Tutorial: Load An Audio File, Create A New Keymap And Program

This tutorial explains how to load .WAV or .AIF audio files into the PC3K, and how to quickly create a keymap and program with a single audio file by using the sample Preview function. The keymap and program that you create will be very basic, containing one audio file, playable at different pitches across the keyboard. The end of this tutorial explains how to edit the keymap and program to create more complex sounding programs with your audio files.

1. Use a computer to load audio files on to a USB device (such as a thumb drive). Audio files must be in .WAV or .AIF format, mono and stereo files can be loaded, 8 or 16 bit, with sample rates up to a maximum of 96000 Hz. *Once samples are loaded to the PC3K's user sample flash memory, samples remain in the PC3K even when the power is off, until they are manually deleted. Also, once samples are loaded to the PC3K's user sample flash memory, there is no load time for those user samples when turning on the PC3K.*
2. Turn on the PC3K. If you have navigated away from the Program mode main page, press the Exit button until you return to the Program mode main page (see below.)

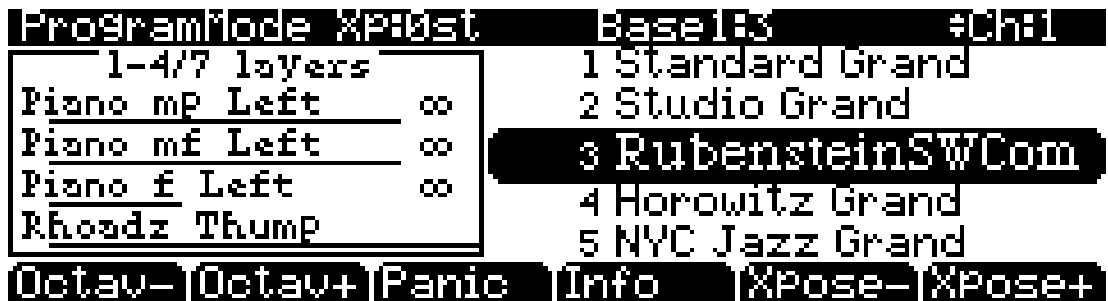

3. Insert the USB device into the PC3K's USB Storage port on the rear panel.
4. Press the Storage mode button to the left of the display to enter Storage mode (see below.) On the Storage mode main page, the display should read "USB device: ready". (If the display reads "USB device: not connected", press the Exit button to return to the Program mode main page. Unplug the USB device and re-insert it into the PC3K, then press the Storage mode button to the left of display.)



Step 5

5. Press the **LOAD** soft button on the Storage mode page (see above) to go to the Storage:Load page (see below).

6. On the Storage:Load page, use the cursor buttons to navigate through the list of files on the USB device (file names are shortened to 8 characters). Folders (a.k.a. directories) will be labeled in the list with <DIR>. Use the **Open** soft button to open a folder, use the **Parent** soft button to exit a folder.

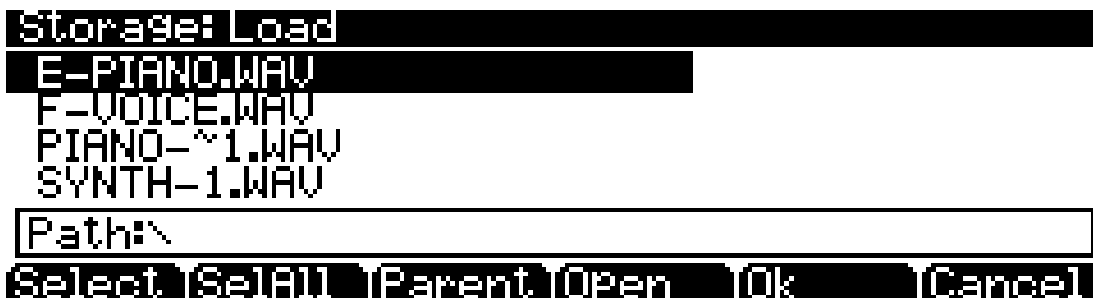

7. You can load a single audio file or multiple files at once as long as they are in the same folder. On the Storage:Load page, choose audio files to load by selecting them in the list with the **Select** soft button (see below). For each selected file an asterisk will appear to the left of its name. (Press the **SelAll** soft button to select all files in the current folder. Entering a new folder will deselect any other files that had been selected.)

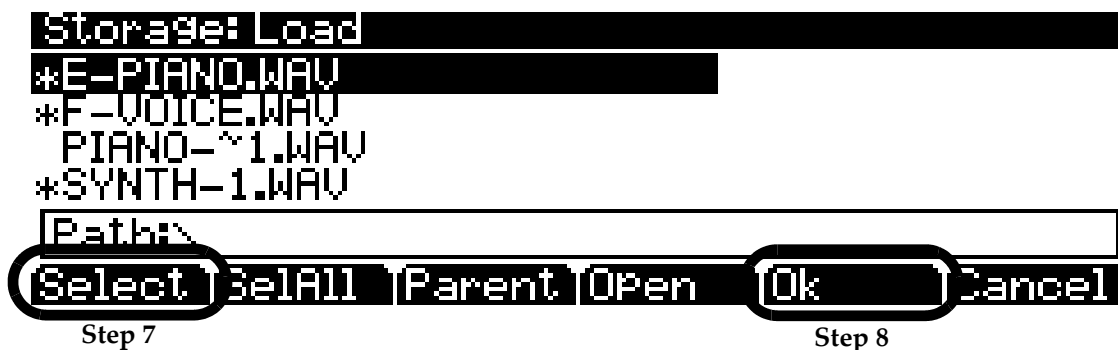

8. When you have selected the files you wish to load on the Storage:Load page, press the **Ok** soft button (see above.)
9. You will be prompted to choose a bank (group of 128 ID numbers) to load the sample(s) in to (see below.) Use the Alpha Wheel or +/- buttons choose from the list of banks. Choose the first user bank (1025...1152).

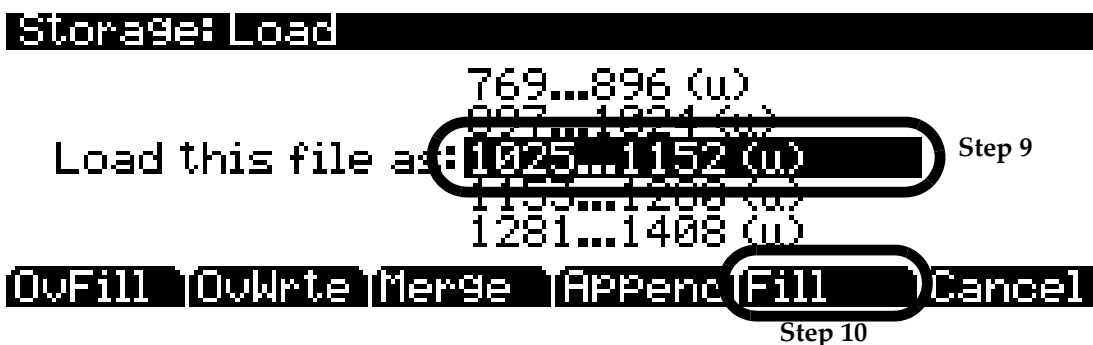

Storage Mode

Tutorial: Load An Audio File, Create A New Keymap And Program

- Next, you must select one of the loading method soft buttons. Generally you will want to use the **Fill** soft button to load the sample into the selected bank. This uses the Fill loading method, which loads the sample(s) starting at the lowest unused ID#, starting in the selected bank. When using the Fill method, any existing samples in the PC3K will not be overwritten. Press the **Fill** soft button to begin loading (see above.)
- Audio files load slowly, please be patient. You can cancel loading an audio file by pressing the **Cancel** soft button.
- When the audio files have been loaded, you will be returned to the StorageMode page. Press the **Exit** button until you reach the Program mode main page. To create a new keymap and program with one of the audio files you have loaded, press the Master mode button, then use the **more** soft buttons to find the **PREVIEW** soft button (see below.) Press the **PREVIEW** soft button to go to the MasterMode:PREVIEW page.

```
MasterMode:MAIN Memory available:61%
Tune      : Oct      MasterLock : Off
Transpose: 0ST      DemoButton: On
FX Mode   : Performance Buttons    : Off
DrumRemap: None     Display     : Ctls
Id Entry  : Global
SetupCtls: Instant
more MEMORY PREVIEW more
```

- On the MasterMode:PREVIEW page, select one of the audio files you have loaded from the **Sample** list. To find the audio file(s) you have loaded, use the Alphanumeric Pad to enter **1025**, then press the **Enter** button. This will bring you to the bank that your file was loaded into. If the audio file you wish to use is not at ID 1025, use the Alpha Wheel or +/- buttons to scroll to higher ID numbers until you find the file in the **Sample** list. When the desired audio file is selected in the **Sample** list, press the **Ok** soft button.

```
MasterMode:PREVIEW
Sample      : 1045 E-PIANO
Ok Cancel
```

14. Next, on the MasterMode:PREVIEW page you must choose a bank (group of 128 ID numbers) where the new program will be saved (see below.) Choose the first user bank (1025...1152) and press the **Ok** soft button. A new program will be created and saved in that bank at the lowest unused ID. The new program will contain a new keymap with the sample you selected. The new program is automatically selected in Program mode and playable from within Master mode. Press the **Exit** button until you reach the Program mode main page, and the new program will be selected.

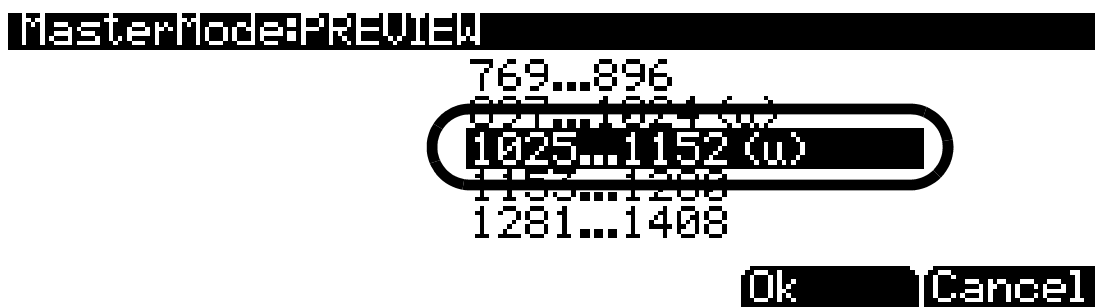

In Program mode, you can edit the new program and view the ID number of the new keymap that was created (see *Editing VAST Programs* on page 6-12 and *The KEYMAP Page* on page 6-14 for details). You can edit the new keymap, as well as use it in combination with other keymaps in the program you just made or in other programs.

The program and keymap that you created with this tutorial will most likely sound very simple. Most of the factory ROM keymaps in the PC3K use many samples, and most of the factory ROM programs in the PC3K use many layers, each with a different keymap and keyrange. Each layer of a program can also have its own DSP or audio effects, which can greatly change the sound of the samples being used. Read the following sections to learn more about the possibilities of editing your own keymaps and programs: *Editing VAST Programs* on page 6-12, and Chapter 14, *Keymap and Sample Editing*.

A keymap generally contains a group of similar samples (for example, different pitches of a piano,) so you may wish to add additional audio files that you have loaded to the keymap that you have created in this tutorial. This can be done in the Keymap Editor on the EditKeymap page (see *The Keymap Editor* on page 14-1.) On the EditKeymap page, loaded audio files can be selected in the **Sample** field. For most users, the loaded sample(s) will have the highest ID number(s) in the sample list. On the EditKeymap page you can find an audio file with the highest ID# by selecting the **Sample** field, entering **0** on the alphanumeric keypad and pressing **Enter**, then press the **minus (-)** button once (below the Alpha Wheel.)

If the keymap that you created does not play in tune with other keymaps or programs, you should adjust the sample's tuning within the Sample Editor using the RootKey parameter. The Sample Editor is nested within the Keymap Editor (see *Editing Samples* on page 14-9 for details). See Chapter 14, *Keymap and Sample Editing* to learn about additional keymap and sample parameters that you may wish to adjust.

Storage Mode

Tutorial: Load An Audio File, Create A New Keymap And Program

Chapter 14

Keymap and Sample Editing

The Keymap Editor

The Keymap Editor lets you customize the PC3K's factory preset keymaps and save them to RAM. You can also build your own keymaps from scratch (see *Building a Keymap* on page 14-7.)

Keymaps are an integral part of every layer of a program. Each keymap contains a set of parameters determining which sample(s) the PC3K will play when you trigger a note. Each layer has at least one keymap, but it can have two keymaps when you're working with stereo samples. Each of these stereo keymaps uses two of the 128 available voices.

Each keymap consists of a set of key (note) ranges—C 4 to G 4, for example. The entire span of each keymap is from C 0 to G 10. Each range has a sample root assigned within the range. Each sample root is a distinct ROM or RAM sample. Within each key range, the sample root is transposed up and down to play on each of the range's notes. You can view each range by changing the value of the Key Range parameter on the Keymap-editor page. You can mix samples of different timbres within a single keymap, and even tune individual keys to any pitch by defining key ranges to single notes and assigning samples to each of those notes.

When you trigger a note, the PC3K identifies the key range where the Note On event occurred. It also checks the attack velocity value of the note. It then addresses its memory, and retrieves the sample root that's assigned to that key range and attack velocity value. If the note that's triggered is not the note where the sample root is assigned, the sample is transposed to play at the correct pitch. The PC3K then generates the digital signal that represents the sound of the note. At this point the keymap's job is done, and the signal proceeds through the layer's algorithm and on to the audio outputs.

You can assign as many key ranges to a keymap as you like, even creating a separate range for each note. This would allow you to tune each key independently, to create microtonal tunings. For keymaps that use a single timbre, like the Grand Piano, there's a key range for each sample root stored in memory. For acoustic instrumental sounds, the more key ranges you have for a keymap, the more realistic the sound will be, since there will be less pitch shifting of the sample root within the key range.

Of course, you can assign sample roots with different timbres within the same keymap. Many of the drum kit keymaps in ROM, for example, have about 20 key ranges, with several different timbres assigned as the sample roots. You can also create a keymap with a single key range that spans from C 0 to G 10, if you want to stretch a single sample root from C 0 to G 10. Keep in mind, however, that samples can only be transposed upward by an octave from the sample's original pitch. Samples can be transposed downward without limit.

Think of a keymap as if it were a single piece of string, divided into different sections that adjoin one another. Sections cannot overlap. If you have one range that goes from C4 to F4 and another that goes from F#4 to C5, then if you change the first range to be C4 to G4, the second one will change to be G#4 to C5.

Also, you can't have "nothing" assigned to a key range. Even if it is Silence (#999), there will always be a sample assigned to every range in the keymap. This is something to watch out for when creating drum programs. For example, let's say you are creating a program with 20 layers. Each layer has its own keymap, which has just one sample assigned to part of the keyboard with the rest of the key range assigned to Silence. Make sure that you limit the note range of each

Keymap and Sample Editing

The Keymap Editor

layer using the LoKey and HiKey parameters on the LAYER page in the Program Editor. If each layer covers the entire range, then each note you played would trigger 20 voices (one for each layer). You would only hear one drum per note because all the other layers are triggering "Silence." Because of the voice-stealing algorithms in the PC3K, the voices would almost immediately become available again, since they have no amplitude. But for one brief instant, the voice would be triggered, which could cause other voices to be cut off.

You can also create multi-velocity keymaps—that is, keymaps that will play different timbres depending on the attack velocities of your Note On events. Program 6 **Pop Power Piano**, for example, uses a keymap with three velocity ranges. Each key range in a multi-velocity keymap contains two or more distinct sample roots that the PC3K chooses between, according to the attack velocity of the note. See *Velocity Ranges (VelRng)* on page 14-5 for details.

The Keymap Editor is nested within the Program Editor. The first step in using the Keymap Editor is to select the keymap you want to edit. This is done on the KEYMAP page in the Program Editor, using the Keymap parameter. Once you've done this, just press the **Edit** button, and you'll enter the Keymap Editor. If you want to edit a different keymap, press the **Exit** button to return to the KEYMAP page in the Program Editor and select the desired keymap. If you want to build a keymap from scratch, start with the keymap **999 Silence** (see *Building a Keymap* on page 14-7). This keymap template contains one key range from C 0 to G 10, and is a convenient starting point for adding key ranges and assigning sample roots. The Keymap-editor page looks like this:

```
editKeymap #KeyRange:C 0 A#0
Sample      : 51 Right Piano f-B 0
KeyRange    : C 0 A#0      Lo: C 0      Hi : A#0
VelRange    : ppp-fff     Lo: ppp     Hi : fff
CoarseTune  : 0ST         FineTune  : -3ct
MasterXpose: 0ST
VolumeAdjus: 0.0dB
more Toggle VelRng NewRng Assign more
```

Parameter	Range of Values
Sample	Sample Root list
Key Range	Variable from C0-G10
Low Key	C 0 to G 10
High Key	C 0 to G 10
Velocity Range (VelRange)	Variable from ppp-fff
Low Velocity (Lo)	ppp-fff
High Velocity (Hi)	ppp-fff
Coarse Tune	-128 to 127 semitones
Fine Tune	-49 to 50 cents
Master Transpose	-126 ST to 127 semitones
Volume Adjust	± 24 dB

Keymap Editor Parameters

Sample

This is where you assign a sample root to the current key range. Depending on the nature of the sample root—an individual sample or a block of sample roots—the sample’s name looks a bit different in the display. Each sample’s name consists of three parts: a numeral, a name, and a note number—for example, **999 Silence-C4**. Additionally, the name of stereo samples will end with an **S**. (To use a stereo sample, the *Stereo* parameter must be set to **On** in the Program Editor, and two keymaps must be selected, see *The KEYMAP Page* on page 6-14 for details.)

The numeral is the sample block ID. If the sample object is an individual sample, the sample block ID is the same as the sample’s object ID. If the sample object is a group of sample roots, the object ID of the first root in the group determines the sample block ID. The remaining roots in the block have the same ID, and differ only in their note numbers.

Next comes the name of the sample, which typically describes the sample’s timbre. The final part of the sample’s name refers to the pitch at which it was originally sampled. For many timbres, multiple samples are made at various pitches. As you scroll through the Sample list, you’ll see only the pitch of the sample change until you reach the next sample block. The sample’s original pitch is set in the Sample Editor (see *Root Key* on page 14-10.) This determines which key will play the sample at its original pitch when a sample is used in a key range (see *Key Range* below.)

Key Range

A keyrange is a range of keyboard keys that plays one sample (per velocity range, see *Velocity Range (VelRange)* below for details.) Each sample in a key range (per velocity range) is transposed based on each sample’s *RootKey* parameter so that it plays at the correct pitch on the keyboard relative to its root key (see *Editing Samples* on page 14-9 for details on the *RootKey* parameter.) Other keys within the key range transpose the sample chromatically relative to the root key. Sample pitch relative to the root key can also be offset using the *Coarse Tune* and *Fine Tune* parameters, see below.)

The **KeyRange** parameter shows you which key range you’re currently viewing or editing (key ranges are named by their lowest and highest notes.) Changing the value of the **KeyRange** parameter selects from the available key ranges, and allows you to view or edit the sample assignment and other parameters of the selected key range. When the Key Range parameter is selected, you can also scroll through available key ranges using the Alpha Wheel or the *-/+* buttons. Multiple key ranges are only shown if the current Keymap uses more than one key range. If the top line of the EditKeymap page displays KeyRange, you can scroll through the available key ranges with any parameter on the page selected using the **Chan/Layer** buttons. (Press the **Toggle** soft button to toggle the top line between displaying KeyRange and VelRange.)

With the Keyrange parameter selected, keyranges can also be selected by holding the **Enter** button and playing a key. The keyrange assigned to that key will be selected.

Low Key (Lo), High Key (Hi)

With these parameters you can use any of the data entry methods to change the low and high notes of the current key range. You can extend a key range to the full capacity of the PC3K (C 0 to G 10). If you extend the current key range into another, the boundaries of the other key range will become shortened to accommodate the key range you are extending. If the keyrange you are extending covers another keyrange, the other key range will be deleted.

The setting for the low key cannot be higher than the setting for the high key. Similarly, the setting for the high key cannot be lower than the setting for the low key.

Velocity Range (VelRange)

This parameter shows the keyboard velocity range (in dynamic levels) that will trigger a sample for the current KeyRange. In a key range with more than one velocity range, each velocity range can use a different sample, as well as different CoarseTune, FineTune, and VolumeAdjust settings. Velocity ranges are intended for use with instrument samples recorded at different velocities. This helps to make playing sampled instruments sound more realistic. Sample volumes are also scaled based on keyboard velocity within each velocity range. Velocity ranges for the current Keymap are set using the **VelRng** soft button (see *Velocity Ranges (VelRng)* on page 14-5) or the *Low Velocity (Lo)*, *High Velocity (Hi)* parameters (see below.) All keyranges in a Keymap share the same set of velocity ranges. Up to eight velocity ranges can be used.

When the VelRange parameter is selected, you can scroll through available velocity ranges using the Alpha Wheel or the +/- buttons. Multiple velocity ranges are only shown if the current Keymap uses more than one velocity range. If the top line of the EditKeymap page displays VelRange, you can scroll through the available velocity ranges with any parameter on the page selected using the **Chan/Layer** buttons. (Press the **Toggle** soft button to toggle the top line between displaying VelRange and KeyRange.)

Low Velocity (Lo), High Velocity (Hi)

Use these parameters to set the velocity range of the current key range. If you extend the current velocity range into another, the boundaries of the other velocity range will become shortened to accommodate the velocity range you are extending. If the velocity range you are extending covers another velocity range, the other velocity range will be deleted.

Coarse Tune

Coarse Tune allows you to transpose a sample for a given range. This is extremely useful when you have set the Root key of the sample for one note but want to assign the sample to a different part of the keyboard and still be able to play it without transposition (see *Root Key* on page 14-10 for details.) For example, if you originally set the Root key at C4 but want the sample assigned to C3, you would set Coarse Tune to 12ST, transposing it up one octave. Now the original pitch will play at C3, one octave down. If you examine the drum and percussion kit keymaps in ROM, you will see that we have done this. Most of our ROM drum samples have the Root key set at C4.

There's a short cut for adjusting the Coarse Tune automatically so that the sample plays with minimal transposition in the assigned key range. See *Special Double Button Presses in the Keymap Editor* on page 14-6.

Fine Tune

This gives you further pitch control. Once the sample's pitch is close to the desired note, use the Fine tune to sharpen or flatten it as much as a half-semitone.

Master Transpose (MasterXpose)

This parameter does not really pertain to the keymap itself. Instead it is identical to the Transpose parameter found on the MIDI-mode TRANSMIT page. If you change the value here, the same value will be reflected on the MIDI-mode TRANSMIT page, and vice versa. It transposes the entire instrument globally. The reason it is placed on this page is that it will allow you to assign samples across the entire keyboard easily, when you are using a keyboard that has fewer than 88 notes.

Volume Adjust

Here you can adjust the volume of the notes in the current key range. This enables you to make each key range play at the same volume even if the samples in the various ranges were recorded at different volumes.

The Soft Buttons in the Keymap Editor

Toggle

Pressing the **Toggle** soft button switches the function that the **Chan/Layer** buttons perform while on the EditKeymap page. Press the **Toggle** soft button to toggle the top line between displaying **KeyRange** or **VelRange**. If the top line of the page displays **KeyRange**, then the **Chan/Layer** buttons will scroll between the available key ranges in the key map (if the current key map has more than one key range.) The note range for each key range will also be displayed on the top line. If the top line of the page displays **VelRange**, then the **Chan/Layer** buttons will scroll between the available velocity ranges in the key map (if the current key map has more than one velocity range.) The dynamic range for each velocity range will also be displayed on the top line.

Velocity Ranges (VelRng)

Press the **VelRng** soft button to view the VEL RANGES page (see below.) Use the VEL RANGES page to add, edit or delete velocity ranges for the current keymap. The VEL RANGES page shows a chart of a keymap's entire available dynamic range, from most quiet (ppp) to most loud (fff.) Velocity ranges can also be adjusted from the EditKeymap page, but the VEL RANGES page provides a chart as a visual aid. Each keymap can be split into a maximum of eight velocity ranges. Each key range in a keymap can use its own sample for each velocity range. All key ranges in a keymap share the same velocity ranges.



Press the **Split** soft button to split the currently selected velocity range into two ranges (until the maximum of eight velocity ranges have been created.) Press the **Delete** soft button to delete the currently selected velocity range. Press the **Exit** soft button to return to the EditKeymap page.

On the VEL RANGES page, the currently selected velocity range is highlighted in the chart, and its name is displayed in the VelRange field. With the VelRange field selected, you can use the Alpha Wheel or +/- buttons to move between the available velocity ranges (if there is more than one velocity range available.) You can also use the **Chan/Layer** buttons at any time to move between the available velocity ranges. If there is more than one velocity range available, you can adjust the dynamic range of each using Lo and Hi parameters. These Hi and Lo parameters are the same as the Low Velocity (Lo) and High Velocity (Hi) parameters on the EditKeymap page (see *Low Velocity (Lo)*, *High Velocity (Hi)* on page 14-4 for details.) Changes made with either set of parameters are shown on both pages.

New Range (NewRng)

The **NewRng** button lets you define a new keyrange to edit, whether it's to assign a different sample, or to adjust the pitch or volume. Just press **NewRng**, then play the note you want as the low note, then the high note. The PC3K will prompt you for each note. When you trigger the high note, you'll return to the Keymap-editor page, and the new keyrange you defined will be selected. The next change you make will affect only that edit range.

If you set a new keyrange that's completely within an existing key range, the existing key range will be split into two keyranges, with the new keyrange between the two. At this point, you must change at least one parameter of the new keyrange before editing a different keyrange, otherwise the new keyrange will be merged with the adjacent keyranges. If you set a new keyrange that overlaps part or all of another key range, the sample assigned to the lower key range will be applied to the new keyrange. Again, at this point you must change at least one parameter of the new keyrange before editing a different keyrange, otherwise the new keyrange will be merged with the lower keyrange that it overlapped.

Assign

The **Assign** soft button lets you select a sample, then specify the key range to which it's assigned. This enables you to insert a new key range within the current keymap. When you press the **Assign** soft button, a dialog appears that prompts you to select a sample from the Samples list. Scroll through the list, then press the **OK** soft button. You'll then be prompted to define the new key range by playing the notes you want to be the lowest and highest notes of the range. (Press the **Cancel** soft button if you change your mind.) When you trigger the low and high notes, the new key range is inserted. If the new key range partially overlaps an adjacent key range, the existing key range will be adjusted to accommodate the new range. If the new key range completely overlaps an existing key range, the original key range will be replaced.

Rename

Call up the page that enables you to change the name of the current keymap.

Save

Start the process of saving the current keymap.

Delete

Delete the current keymap from memory. Factory ROM keymaps cannot be deleted.

Special Double Button Presses in the Keymap Editor

Suppose you have a sample whose root key is C 4, and you want to assign it to A 0, because you don't expect to play it often. If you want it to play back without transposition, you'll have to adjust the Coarse Tune parameter. Calculating the right value for Coarse Tune can get tedious if you're assigning a large number of samples. Fortunately, there's a short cut.

1. Assign a sample root to a key range, either using the Lo, Hi, and Sample parameters or using the **Assign** soft button.
2. Highlight the value of the Coarse Tune parameter.
3. Press the **Plus/Minus** buttons at the same time. The value of Coarse Tune changes automatically. If the sample is assigned to one note, the PC3K sets Coarse Tune so that the note plays the sample without transposition. If the sample is assigned to a range of notes, the PC3K sets Coarse Tune so that the middle note of the range plays the sample without transposition.

Building a Keymap

Read below for detailed directions on manually creating and editing a keymap. (See the preview function on page 11-19 for a way to automatically create a program and keymap.) To build a keymap, first go to the Program mode main page (this can be done by repeatedly pressing the **Exit** button.) From the Program mode main page, use the alphanumeric pad to select program **999 Default Program**. Next press the **Edit** button to enter the Program Editor. Press the **KEYMAP** soft button, and the KEYMAP page will appear. The Keymap parameter will be automatically selected. Press **999** and **Enter** on the alphanumeric pad to assign the keymap **999 Silence**. This isn't absolutely necessary, but it makes it easier to recognize the key ranges that have samples assigned to them when you start assigning samples. You can actually choose any program or keymap you want to start with, but by choosing these, you are starting with a "blank slate."

With the Keymap parameter still selected, press the **Edit** button, and you'll enter the Keymap Editor. The Key Range parameter will be automatically selected, and you see its values: C 0 to G 10 (the entire MIDI keyboard range). The Sample parameter will have a value of **999 Silence-C 4**.

Now you're ready to start assigning samples to key ranges within the keymap. We'll assume that you've loaded samples with roots at C 1, C 2, C 3, etc. and that you plan to assign a root to each octave. To begin, press the **Assign** soft button. The display will prompt you to select a sample. Use the Alpha Wheel to scroll to one of your samples, or type its ID on the alphanumeric pad and press **Enter**. When you've found the sample you want to use, press the **OK** soft button. The display will say "Strike low key..." Trigger A 0 (MIDI note number 21, the lowest A on a standard 88-note keyboard). The display will change to say "Strike High Key..." Now trigger F 1 (MIDI note number 29). The display will return to the Keymap-editor page. The Key Range parameter will show A 0-F 1, and the Sample parameter will show the sample you selected when you started the range assignment.

Each sample in a key range is automatically transposed based on each sample's RootKey parameter so that it plays at the correct pitch on the keyboard relative to its root key (see *Editing Samples* on page 14-9 for details on the RootKey parameter.) Other keys within the key range transpose the sample chromatically relative to the root key. Automatic transposition based on each sample's RootKey is important if you want your sample to play in tune with other PC3K programs or other instruments. The PC3K makes this easy if your samples have the correct RootKey settings (as the PC3K's factory samples do.) Generally you should set a keyrange so that the sample's RootKey (displayed at the end of the sample name) is in the middle of the range. If you set a key range that does not cover the sample's RootKey, the sample will have to automatically transpose by many semitones, and will likely not sound correct. Samples are also limited to an octave of upward transposition from the sample's original pitch. If you set a keyrange too high based on the Root Key, some samples may not be able to transpose upward far enough to play in tune, and many keys may play the same note (the highest note that the sample can be transposed to.) Automatic transposition relative to the root key can be offset using the Coarse Tune and Fine Tune parameters on the EditKeymap page, (see *Coarse Tune* and *Fine Tune* on page 14-4.)

Continuing with the example, press the **Assign** soft button again. Select another sample root at the prompt, and press the **OK** soft button. Now trigger F# 1 for the Low Key prompt, and F 2 for the High Key prompt. At this point you've defined two key ranges, the first from A 0 to F 1, and the second from F# 1 to F 2. You can repeat the process as many times as you want, creating a new key range each time.

Once you have your samples assigned, you may need to transpose them so that they play back at the correct pitch within the range you have chosen. To do this, highlight the Key Range parameter, scroll to the range you need, then highlight the Coarse Tune parameter. Adjust Coarse Tune to bring the sample to the proper pitch within that key range. Then scroll back up to the Key Range parameter, select the next range, and continue as needed.

Here's a fairly important point that may or may not affect your keymap construction. Suppose you want to build a keymap that uses the same sample in several adjacent key ranges, and you plan to add a bit of detuning to the samples in each range. You might think that you could build the keymap first, then go into the Sample Editor and tweak the sample settings of each keyrange when the keymap is finished. Yes, but...

Suppose you used the technique we described above to assign a vocal sample whose root was C 4 to a key range from A 3 to E 4. Then you assigned the same sample to a key range from F 4 to B 4. You might be surprised to find that when you finished the F 4–B 4 key range and the Keymap-editor page reappeared, the current key range would not be F 4 to B 4, but A 3 to B 4! This is because the PC3K automatically merges adjacent key ranges that are identical (this is done to save memory). Therefore, some parameter must be different in each adjacent key range you create if you want to build keymaps using the technique we just described. So if you want to use the same samples in adjacent key ranges with, for example, minor pitch or volume modification, you should make those changes to the current sample on the Keymap-editor page *before* assigning the next range.

Editing Samples

To enter the Sample Editor, first select the program you wish to edit in Program mode. With the program selected, press the **Edit** button to enter the Program Editor. In the program editor the KEYMAP page will be selected (if not press the **KEYMAP** soft button.) With the KeyMap parameter selected on the KEYMAP page, press the **Edit** button again to enter the Keymap Editor. On the EditKeymap page, select the KeyRange parameter and use the Alpha Wheel or -/+ buttons to choose one of the available key ranges (if there is more than one keyrange.) You can edit the existing sample of a keyrange, or choose a new sample for the keyrange and edit that. When the Keymap parameter is selected you can hold the **Enter** button and trigger notes to select different key ranges.

If you want to select a different sample, use the cursor buttons to select the Sample parameter. Use the Alpha Wheel to select a sample. Press the **Edit** button once more, and you'll enter the Sample Editor. The sample will play through the effects of the current program. The name of stereo samples end with an **S**. To use a stereo sample, the *Stereo* parameter must be set to **On** in the Program Editor, and two keymaps must be selected, see *The KEYMAP Page* on page 6-14 for details.

There are two sample editing pages—MISC (Miscellaneous) and TRIM. The soft buttons for these pages are visible when you enter the Sample Editor. You can trigger notes at any time while you're editing, to hear your changes as you make them. When you have finished editing your sample or samples, see the preview function on page 11-19 for a way to automatically create a program and keymap using a sample or group of sample roots.

The Miscellaneous (MISC) Page

On the MISC page, you'll set several parameters that affect the behavior of the current sample. These parameters affect the entire sample. The center of the top line displays the type of sample, either ROM BASE for factory samples or FLASH for user loaded samples. The right side of the top line displays the root number and RootKey of the sample. For stereo samples, **L** or **R** is displayed after the Root# parameter to indicate that you are viewing parameters for the left or right channel of the sample. Use the **Chan/Layer** buttons to move between channels of stereo samples. Although you can edit parameters for the left and right channels of a sample, both channels can only be heard if the *Stereo* parameter is set to **On** in the Program Editor, and the same keymap is selected for the Keymap1 and Keymap2 parameters in the Program Editor. If the *Stereo* parameter is set to **Off** in the Program Editor, only the left channel of stereo samples will be heard in mono. If the sample is part of a group of sample roots, you can also use the **Chan/Layer** buttons to scroll through each sample in the group. A representative MISC page is shown below:

```

EditSampleMISC ROM BASE= Root#1 (F#1)
RootKey      : F#1      LoopSwitch   : On
PitchAdjust  : 7ct      Playback     : Normal
VolAdjust    : 0.0dB    AltSense     : Normal
AltVolAdjust : -1.5dB   Ignore Rel   : Off
DecayRate    : 6dB/s    SampleRate   : 35997Hz
ReleaseRate  : 539dB/s  NumSamples   : 46Ks
more MISC TRIM more

```

Keymap and Sample Editing

Editing Samples

Parameter	Range of Values
Root Key Number	C -1 to G 9
Pitch Adjust	Variable (depends on sample rate)
Volume Adjust	-64.0 to 63.5 dB
Alternative Volume Adjust	-64.0 to 63.5 dB
Decay Rate	0 to 5000 dB per second
Release Rate	0 to 5000 dB per second
Loop Switch	Off, On
Playback Mode	Normal, Reverse, Bidirectional
Alternative Sample Sense	Normal, Reverse
Ignore Release	Off, On

Root Key

The root key represents the keyboard key at which the sample will play back without transposition (that is, at the same pitch as the pitch of the original sample). Use the +/- buttons or Alpha Wheel to select a RootKey note, or use the alphanumeric pad followed by the **Enter** button to enter a RootKey by MIDI note number.

Pitch Adjust

Use this parameter to change the pitch of the sample relative to the key from which it's played. Setting a value of **100cts**, for example, will cause the sample to play back one semitone higher than normal. This parameter is handy for fine tuning samples to each other if they're slightly out of tune.

Volume Adjust

Uniformly boost or cut the amplitude of the entire sample.

Alternative Start Volume Adjust (AltVolAdjust)

This parameter sets the amplitude of the sample when the alternative start is used. See page 6-16 for a discussion of AltSwitch.

Decay Rate

This parameter defines how long the sample takes to decay (fade) to zero amplitude (silence). Decay Rate affects each sample individually, and is in effect only when the amplitude envelope for the program (the Mode parameter on the AMPENV page in the Program Editor) is set to **Natural**. If Mode is **User**, the settings on the AMPENV page override the setting for DecayRate.

DecayRate operates in two different ways, depending on the nature of the sample. If it's a ROM sample or a Kurzweil-format RAM sample, DecayRate takes effect in the loop portion of the sample, after all the attack stages of the amplitude envelope are complete. For non-Kurzweil RAM samples, DecayRate takes effect as soon as the sample starts, regardless of the length of the attack stages.

Release Rate

The release rate determines how long the sample will take to decay to zero amplitude when the note trigger is released. The higher the value, the faster the release rate. This release affects each sample individually, and is in effect only when the amplitude envelope for the program (the Mode parameter on the AMPENV page in the Program Editor) is set to **Natural**. In this case, the release begins as soon as the note is released. If Mode is **User**, the settings on the AMPENV page override the setting for ReleaseRate.

To create an extended sample loop that will play data after the sample's loop on key-up, set the Alternative Start sample pointer after the sample end pointer, then set a relatively low value for the release rate.

Loop Switch

This parameter activates or deactivates the looping of the currently selected sample. When set to **On**, the sample will loop according to the settings on the TRIM page. When set to **Off**, the sample will play through to its End point and stop.

Playback Mode (Playback)

This parameter lets you modify the direction in which the sample is played. Set it to a value of **Reverse** if you want the sample to play from its End (E) point to its Start (S) point. Choose a value of **Bidirectional** to cause the sample to play from Start to End, then reverse direction and play again from End to Loop and back, repeating until the note trigger is released (this works only when the Loop Switch parameter is set to **On**).

Alternative Sample Sense (AltSense)

This provides a convenient way to activate the alternative start of a sample. When set to **Normal**, the alternative start will be used when the Alt Switch control is **On** (this is set on the KEYMAP page), or when the control source assigned to it is above its midpoint. When set to **Reverse**, the alternative start will be used when the Alt Switch control is **Off**, or when the control source assigned to it is below its midpoint.

Ignore Release (IgnRelease)

When set to a value of **Off**, the sample will release normally when the note trigger is released. When set to **On**, the note will not release, even when the note trigger is released. This setting should be used only with samples that normally decay to silence; nondecaying samples will play forever at this setting. This parameter is equivalent to the IgnRelease parameter on the LAYER page, but affects only the currently selected sample.

SampleRate and NumSamples

These parameters cannot be edited, but show the sample's sample rate and the sample's length in samples. Samples that are longer than 1 million samples are displayed a 1Ms.

The Soft Buttons on the MISC Page**Rename**

Call up the page that enables you to change the name of the current sample.

Save

Start the process of saving the current sample.

Delete

Delete the current sample from memory. Factory ROM samples cannot be deleted.

The TRIM Page

The TRIM page lets you set the Start, Alternative Start, Loop, and End points of the current sample. The top line indicates the Zoom and Gain settings. This Gain setting doesn't affect the amplitude of the sample, just the view in the display. The right side of the top line displays the root number of the sample. If the sample is part of a group of sample roots, you can use the Chan/Layer buttons to scroll through each sample in the group.

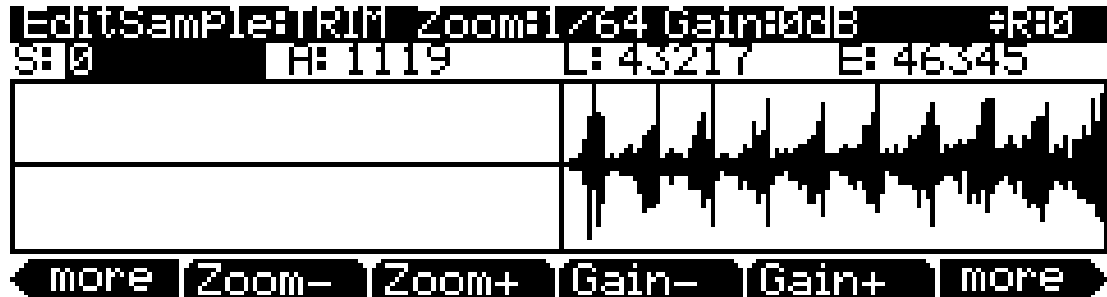

The four parameters on this page are Start (S), Alternative Start (A), Loop (L), and End (E). Selecting these parameters and adjusting their values enables you to modify how the sample plays back when notes are triggered. Each of these parameter points are expressed in individual samples. For example, a one second sample at a sample rate of 44,100Hz would have 44,100 values available to adjust for each of these parameters.

There is a vertical line in the center of the display indicating the placement of the current parameter in the sample waveform. The sample waveform will move relative to the line when each parameter is selected or adjusted. The line remains in the center of the display, and the waveform shifts to indicate the new position of the point. Each parameter can be adjusted with the +/- buttons, the Alpha Wheel, or the alphanumeric button pad followed by the **Enter** button.

The **Start (S)** point determines the beginning of the current sample. You can truncate the beginning of the sample by increasing the value of the Start (S) parameter. You might do this to remove silence at the beginning of a sample, or to remove some or all of the attack. You can't decrease the Start point of samples below zero.

The **Alternative Start (A)** parameter lets you set a second, optional start or end point for the current sample. The Alternative Start will be used when the Alt Switch parameter on the KEYMAP page is set to **On**, or when it's set to a specific control source and that control source is generating a value of more than +.5. (For example, if you assign **MWheel** as the control source for the Alt Switch parameter, the Alternative Start will be used when the Mod Wheel—is or whatever control source you have set to send MWheel—is above its halfway point.) The Alternative Start can be set before, after, or at the same point as the Start or End.

If you set the Alternative Start after the End, you can extend the play of looped samples. Normally, looped samples will play through to the End, then will loop back to the Loop point, and continue looping like this until the note is released, when they go into their normal release. If the Alternative Start is set after the End, looped samples will loop in the same way while notes are sustained. As soon as you release the notes, however, the samples will play through to the Alternative Start point before going into release.

The **Loop (L)** parameter sets the beginning of the looped portion of the current sample. The Loop can be set at any point before the End, including before the Start and Alternative Start. If you try to move it after the End, the End will move with it. When you're setting a loop segment for a sample, you should adjust both the Loop and End parameters so that the two ends of the waveform would meet (or come as close as possible) when the loop occurs. You can do this visually by zooming in close to the waveform (until it becomes a single line,) then adjusting the Loop and End parameters of the waveform until both ends are the same distance above or below

the zero point of the display (the horizontal line in the middle of the waveform display.) Though adjusting these points visually is helpful, always listen to the sample and make the final settings based on what sounds best. You'll notice an audible click in your sample loop if the ends of the waveform do not meet where the loop occurs. The closer you can get the two ends of the waveform, the better the sound quality of your loop will be. Using zero-crossings for the Loop and End parameters may also help reduce clicks at the loop point, see *Zero- and Zero+* below for details.

The **End (E)** parameter sets the point at which the current sample will stop playback. Typically you'll use this parameter to trim unwanted silence off the end of a sample, although you can use it to shorten a sample as much as you want.



Note On Saving Samples: *Trimmed portions of a sample are not saved. Trimmed portions before the Start (S), or Alternative Start (A) points (whichever has a lower value) will be lost upon saving, and whichever parameter had a lower value will have a value of zero the next time it is loaded (values for all other sample point parameters will be adjusted relatively.) Trimmed portions after the Alternative Start (A) or End (E) points (whichever has a higher value) will be lost upon saving. If you wish to save a copy of the original untrimmed sample, save the trimmed version under a different ID# (this will not use additional sample memory.) If you save a trimmed factory ROM sample at its original ID#, you can always restore the original version by deleting the modified version that you saved. To delete a sample, see OBJECT on page 11-13, the Delete function.*

Zoom- and Zoom+

These buttons increase or decrease the resolution of the waveform display, enabling you to see a larger or smaller segment of the waveform of the currently selected sample. The top line of the display indicates the zoom position in terms of a fraction—for example, 1/256—which indicates the number of individual sample elements represented by each display pixel. A value of 1/256 means that each pixel represents 256 individual sample elements. The maximum zoom setting of 1 shows you a very small segment of the sample. The minimum setting of 1/16384 shows you the largest possible segment of the sample. Each press of a **Zoom** soft button increases or decreases the zoom by a factor of 4.

Gain- and Gain+

These buttons increase or decrease the magnification of the currently displayed sample waveform, enabling you to see the waveform in greater or lesser detail. At the left of the display, you'll see the magnification setting, which is expressed in dB units. You can adjust the magnification from 48 dB (maximum magnification) to 0 dB. This doesn't affect the actual amplitude of the sample, only the magnification of its display.

The simplest way to think of the **Zoom** and **Gain** buttons is to remember that the **Zoom** buttons control the left/right magnification of the waveform, while the **Gain** buttons control the up/down magnification. Neither button has any affect on the sound of the sample. You'll often use the **Zoom** and **Gain** soft buttons together to focus in on a particular sample segment, then magnify it to see it in close detail.

For example, you might want to zoom out to view an entire sample waveform, to decide which segment you want to edit. You could then zoom in to focus on a particular segment. Once you've zoomed in, you may want to boost the Gain to enable you to set a new Start (S) point with greater precision, or ensure that you get a smooth loop transition.

Zero- and Zero+

Pressing the **Zero-** or **Zero+** buttons will search left or right respectively for the sample's next zero-crossing. A zero-crossing is a point where the sample waveform is neither positive or negative (crossing the horizontal line in the middle of the waveform display.) The currently selected parameter (Start (S), Alternative Start (A), Loop (L), or End (E)) will be set to this point in the sample. Setting these parameters to zero-crossings can help minimize clicks at the start, end, or loop point of a sample. It's best to have each of these points set first by adjusting each parameter and listening to the sample, then if needed search for a nearby zero-crossing.

Chapter 15

Tutorial: Song Mode

In Song mode, you can use the PC3K's sequencer to record songs using multiple instrument sounds. You can easily change your song's tempo, fix mistakes, and adjust the volume of each instrument.

The following guide includes instructions to choose specific instrument sounds and track numbers, simply as examples. When you are ready to make your own song, follow the same methods and choose any instrument and track selection that you want.

The steps below explain the simplest way to record, in a linear, track-by-track fashion. There are many methods for recording songs, and there are recording options that you may wish to change once you become familiar with the process. See the Song mode chapter for more options.

Recording Overview

In this guide you will be instructed to record into tracks in a song. A track is like a layer in a song containing the recorded part for one instrument program. You can record up to 16 tracks, and each can be separately edited or adjusted in volume level (with many other options available as well).

About MIDI

In Song mode the PC3K functions as a MIDI sequencer. MIDI (Musical Instrument Digital Interface) is a standardized system that allows different electronic instruments to work together, among other musical uses. A MIDI sequencer doesn't record the sound of your performance, just messages that cause the instrument to play notes. When you play back a song (*a.k.a. a MIDI sequence*) in Song mode, the PC3K triggers each of the notes that you have recorded, sort of like a player piano. MIDI is very useful for recording songs with electronic instruments such as the PC3K, because you can easily make changes to recorded sequences. For example, you can change individual notes, transpose parts, or change the instrumentation of tracks that have already been recorded. Since MIDI sequences only play back messages that trigger notes, if you start recording or playing back from the middle of your song, you will not hear the result of notes before that point (such as notes sustaining from the previous bar.) In these cases, make sure to start playback or recording before the notes that you want to hear.

About The Time Position Format

In this guide you will be instructed to select specific time positions in a song. In the PC3K's sequencer, time positions are measured from the beginning of the song in Bars, Beats, and Ticks. Dependent on the time signature, these units of measurements can have different values. In these examples we will be using a 4/4 time signature in which a Bar contains 4 beats, and a beat contains 960 ticks (from 0 to 959, see below for more about ticks.) The Song mode MAIN page displays song time in the **Locat** field as Bars and Beats, for example a **Locat** position of **1 : 3** would correspond to Bar 1, Beat 3. The Song mode Big Time page displays song time in large numbers on the top half of the screen as Bars, Beats, and Ticks. For example a Big Time position of **1 :3 :480** would correspond to Bar 1, Beat 3, Tick 480 (in 4/4 Tick 480 would be the second eighth-note of the beat.)

Bars and beats should be familiar terms for musicians, but ticks are a term specific to MIDI sequencers. Ticks provide fine resolution when recording and editing sequences. For example, if you were to play along with the sequencer's metronome to record one note on each beat of a bar, upon reviewing the sequence you would most likely find that each note was not recorded exactly on each beat, but that each was recorded a different small number of ticks away from the beats. (See Part 7, The Event List, below for a way to view note time position.) Ticks allow for the sequencer to record these tiny differences in timing, thus retaining the original timing nuances of the performance. When locating note values smaller than 1 beat, divide the number of ticks in a beat by the appropriate number (a quarter-note is always worth 960 ticks, no matter the time signature.) For example, in a 4/4 time signature there are 960 ticks in a beat (since a beat is worth a quarter-note in 4/4.) To find the value of an 8th note, divide 960 by 2, since there are two 8th notes in a quarter-note. Divide 960 by 4 for 16th notes, by 6 for 16th note triplets, by 8 for 32nd notes, and so on. You can also use record quantization which automatically moves recorded notes to the nearest set time division, such as 8th or 16th notes. (See Part 7, *Quantizing*, below for details.)

Part 1: Assign Instruments To Tracks

1. Press the **Exit** button until you reach the ProgramMode page. Next, press the **Song** mode button, located with the mode buttons to the left of the display. This will bring you to the Song mode MAIN page (see below.)

Step 1 (above) →

← Step 2 (below)

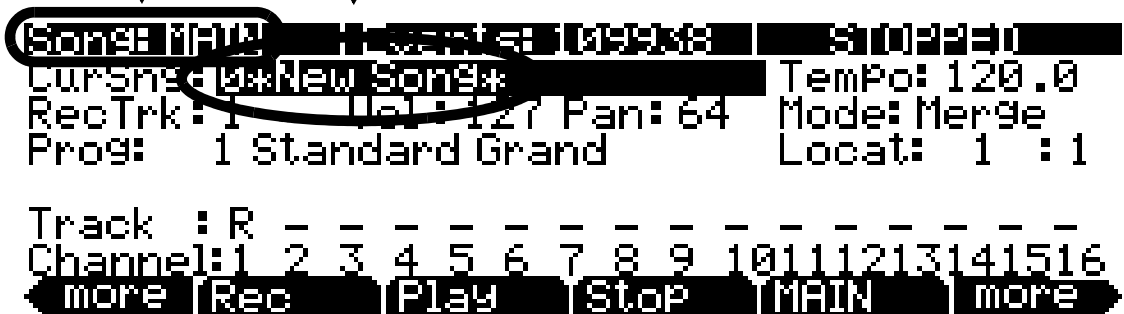

2. On the Song mode MAIN page choose **0*New Song*** in the **CurSng** field (if not already selected). This loads an empty song file (see above.)
3. Use the **Chan/Zone** buttons (to the left of the display) to Set the **RecTrk** parameter to **1**. This sets the track that you will be recording to (see below.)

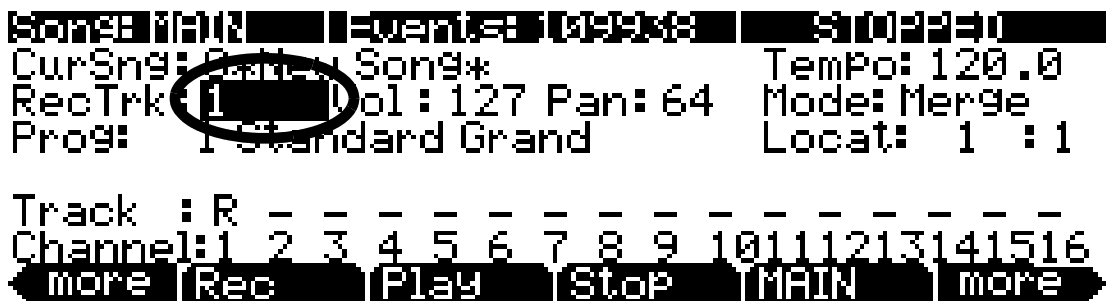

4. Use the **cursor buttons** to navigate to the **Prog** field and choose a program with the plus/minus buttons, alpha wheel, or by entering the desired program number with the alphanumeric pad. This sets the instrument sound for the current track. For example, choose program **1 Standard Grand** to

- To hear the metronome play your tempo, use the right **more** button to find and then press the **BIG** soft button. This brings you to the Song:Big Time page. On the Song:Big Time page, set the **Metron** parameter to **Always** (see below.) Make sure the PC3K's main volume is set at a moderate level, then press the **Play/Pause** button to hear the metronome play the selected tempo.

```

Song: Big Time : New Song          | RecTrk: 1
                1 : 1 : 0          | STOPPED

Time In:      1 : 1 : 0          | Loop : ----
Time Out:     1 : 1 : 0          | RecMode: Linear
Song End:     1 : 1 : 0          | Metron: Always
more BIG Load Save more
    
```

- Press the **BIG** soft button again to return to the Song mode MAIN page (*the MAIN soft button also works for this, but using the BIG soft button is quicker.*) Now you can adjust the **Tempo** parameter and press the **Play/Pause** button to hear the metronome play the tempo. For this example we will leave our previous **Tempo** setting of **100.0**.
- Once you are happy with the tempo, press the **BIG** soft button to return to the Song:Big Time page. Set the **Metron** parameter back to **Rec** so that you will only hear the metronome during recording (see below.) When finished, press the **BIG** soft button again to return to the Song mode MAIN page.

```

Song: Big Time : New Song          | RecTrk: 1
                1 : 1 : 0          | STOPPED

Time In:      1 : 1 : 0          | Loop : ----
Time Out:     1 : 1 : 0          | RecMode: Linear
Song End:     1 : 1 : 0          | Metron: Rec
more BIG Load Save more
    
```

Part 3: Record Your First Track, Save The Song

- On the Song mode MAIN page, use the **Chan/Zone** buttons (to the left of the display) to choose the track you wish to record to. The track number is displayed in the **RecTrk** field (see below.) Let's begin by recording to track 1, to which we have assigned a piano program.

```

Song: MAIN : New Song : New Song | 100.000
CurSng: 0-Hey Song*           | Tempo: 100.0
RecTrk: 1                      | Mode: Merge
Prog: 1-Standard Grand         | Locat: 1 : 1

Track : R - - - - -
Channel: 1 2 3 4 5 6 7 8 9 10 11 12 13 14 15 16
more BIG Load Save more
    
```

2. Press the **Record** button located on the front panel. This prepares the PC3K for recording on the current **RecTrk**. The **Record** button lights, and on the Song mode MAIN page the right of the top line will display REC. READY, which means that the sequencer will record when the **Play/Pause** button is pressed (see below.)

```

Song# 1111  |  Ver# 1  |  Ver# 1  |  REC READY
CurSng: 0*New Song*
RecTrk: 1  |  Vol: 127  |  Pan: 64  |  Tempo: 100.0
Prog: 1 Standard Grand  |  Mode: Merge
                               |  Locat: 1 : 1

Track : R  -  -  -  -  -  -  -  -  -  -  -  -  -  -  -  -  -  -
Channel: 1 2 3 4 5 6 7 8 9 10 11 12 13 14 15 16
more  BIG  Load  Save  more

```

3. Press the **Play/Pause** button located on the front panel. The metronome will play for 1 bar and then recording will begin (see Chapter 12, Song Mode and the Song Editor for details on setting metronome count off options.)
4. Play your part for the current track, when finished, press the **Stop** button on the front panel to stop recording. The Save Changes screen will be displayed where you can retry the last performance of recording, save the song with the last recorded performance, or compare your new performance with the last saved version of the song. For this example we will name the song **My Song** under ID# 1025. See below for an explanation of this page:

```

Song# Save Changes

Save changes to this song?

Playing : NEW
Locate  : 1 : 1 : 0
PlyOld  PlyNew  Stop  Retry  Yes  No

```

Soft Button Functions On the Save Changes Page:

The **PlyNew** soft button allows you to play the song with your latest recorded performance. You will likely want to hear this first.

Pressing **PlyOld** will play the current song, minus the performance that you just recorded. You can toggle between Play Old and Play New without restarting the song by pressing either button while the song is playing. This is useful to check if your last performance was better or worse than what was previously saved (if anything was previously saved.)

The **Locate** field allows you choose a start time for the old or new playback. This is useful when you just want to hear a certain part of the song without listening to the whole thing. The **Playing** field displays whether to **NEW** or **OLD** data is playing.

Stop halts the playback of either the Old or the New version of the song you are currently auditioning. This also resets the song's start location to either the default Bar 1, Beat 1 value, or to whatever location you defined in the Locate field.

Pressing **Retry** restarts recording from the same point you last started recording from.

Yes saves the song with the performance you just recorded. Whatever was played back when you pressed **PlayNew** will be the version of the song saved when you press **Yes**. The “save as” dialog will be displayed:

SongMode:save as

Save New Song as: ID#1025

Rename Save Cancel

Use the Alpha Wheel, +/- buttons, or Alphanumeric Pad to choose a free ID# location to save the song, or choose a used ID# location to overwrite a previously saved song with your new version. For this example we will save the song under **ID# 1025** (see above.) When overwriting a song file, the “save as” dialog displays “Replace” followed by the name of the file being replaced. Press **Save** to save the song with the current name, or **Cancel** to return to the previous screen.

Press **Rename** if you would like to change the song’s name. This brings you to the SongMode:name page. For this example we will rename the song **My Song** (see below.) For more detailed instructions, see the Editing Conventions chapter, “Saving and Naming” section.

SongMode:name #KbdNaming:Off

Song Name : My Song

Delete Insert << >> OK Cancel

If you decide not to save or rename on the Song: Save Changes page, pressing the **No** soft button returns you to the Song mode page in which you were last recording. Changes to the current song are not saved, though the sequencer will remember changes to certain settings from the MAIN and BIG pages. These settings are Tempo, Merge/Erase Mode, Locate, track mute status, Time In, Time Out, Song End, Loop, Recmode, and Metron. To permanently save these changes with the song, make sure to choose **Save** from the soft button menu before powering off or loading a new song. Alternatively, you will be prompted to save these changes upon loading a new song if the MAIN page settings were changed while recording or with recording armed, or if any of the BIG page settings were changed.

About ID#s



When saving, you must choose an ID#. An ID# gives you a way to locate a song aside from its name (you can store up to 2,560 unique ID#s for each object type: songs, setups, programs, etc., though many ID#s are already used for factory ROM objects.) ID#s also allow you to save songs with the same name under different ID#s, and rename them at a later time if desired. Choose an unused ID# to save a new song. The next available unused ID# is automatically selected when

editing a factory ROM song. When editing a song that has been stored in user memory (any originally unused ID#,) the edited song's ID# is automatically selected. This assumes that you wish to replace the existing song, but you can choose another ID# if desired to save a new copy. Choose a used ID# to replace an existing saved song. If you replace a factory ROM song, you can revert to the original song by deleting the song using the Song Mode **Delete** soft button.

Part 4: Record Additional Tracks

When you are happy with your first track and you have saved your song so far, move on to adding other instrument parts on other tracks. You can record up to 16 tracks.

1. On the Song mode MAIN page, use the **Chan/Zone** buttons (to the left of the display) to Set the **RecTrk** parameter to an unused track number (for example, track 2.)

```

Song# 1025  *My Song  Tempo: 100.0
CurSng: 1025 *My Song  Tempo: 100.0
RecTrk: 2  Vol: 127 Pan: 64  Mode: Merge
Prog: 125 Piano Stack  Locat: 1 : 1
  +
Track : P R - - - - -
Channel: 1 2 3 4 5 6 7 8 9 10 11 12 13 14 15 16
more BIG Load Save more

```

2. Set the instrument sound for the current track. Use the cursor buttons to navigate to the **Prog** field and choose a program with the plus/minus buttons, alpha wheel, or by entering the desired program number with the alphanumeric pad. This sets the instrument sound for the current track. For example, choose program **105 P-Bass** to make the next track contain the bass part for this song (see below.) This would be useful to play a bass part that matches the root notes of your left hand piano part from track 1.

```

Song# 1025  *My Song  Tempo: 100.0
CurSng: 1025 *My Song  Tempo: 100.0
RecTrk: 2  Vol: 127 Pan: 64  Mode: Merge
Prog: 105 P-Bass  Locat: 1 : 1
  +
Track : P R - - - - -
Channel: 1 2 3 4 5 6 7 8 9 10 11 12 13 14 15 16
more BIG Load Save more

```

3. Follow the same steps in **Part 3** above (starting on step 2) to start and stop recording, and review, save or discard your performance. When saving the song with your new tracks recorded, press the **Save** soft button on the SongMode:save as page in order to replace the currently saved song with your new version.
4. Repeat the steps above with different track and program numbers to add additional instrument parts to your song.

Part 5: Fixing Mistakes

For each track in Song mode, you can fix mistakes in your performance without re-recording the entire performance. Here we will describe the method that is easiest for fixing specific passages in a track. (For a way to fix single notes, see *Song Editor: The EVENT Page* on page 12-31 in *Chapter 12, Song Mode and the Song Editor*.)

1. On the Song mode MAIN page, use the **Chan/Zone** buttons (to the left of the display) to set the **RecTrk** parameter to the track that you want to fix. For example, let's fix track 1 (see below.)

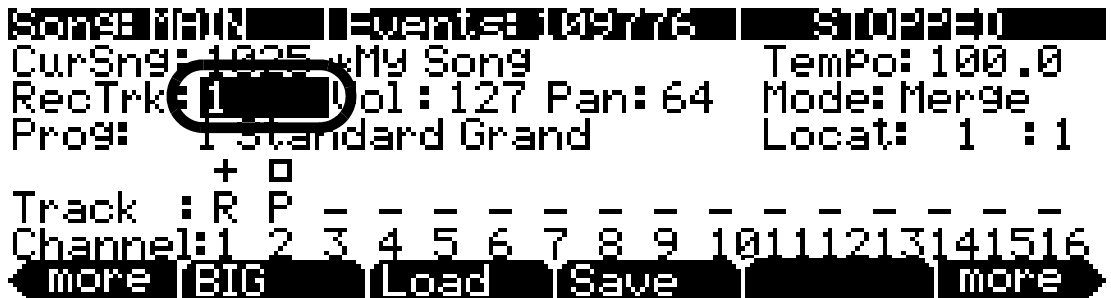

2. Set the **Mode** parameter to **Erase** (see below.) This causes previously recorded notes to be erased when a track is being recorded into.

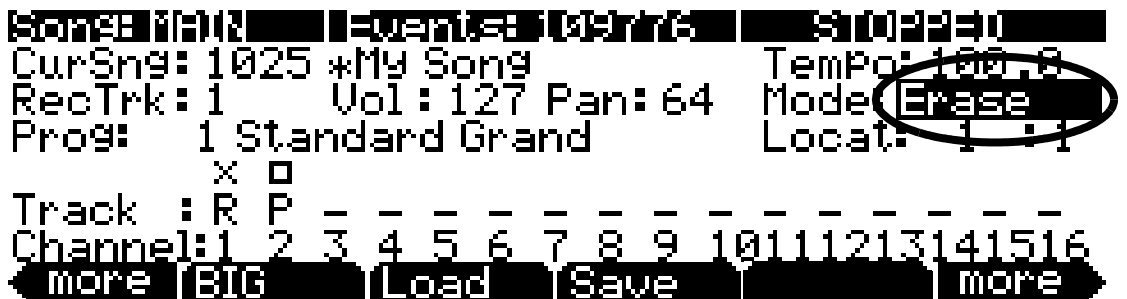

3. Press the **BIG** soft button to go to the Big Time page.
4. On the Big Time page, set the **RecMode** parameter to **PunchIn**. This causes recording to only take place between the times set in the **Time In** and **Time Out** fields.



- Set times for the **Time In** and **Time Out** fields to select the time to fix. For this example we will fix bar 3 (see below.)

```

Song: Big Time : My Song | Rec Track: 1
                        1 : 1 : 0 STOPPED
Time In: 3 : 1 : 0      Loop : ----
Time Out: 4 : 1 : 0    RecMode: PunchIn
Song End: 11 : 1 : 0   Metron: : Rec
more BIG Load Save more

```



Note: If you need to fix a section which isn't exactly within one bar or an even division of beats, use the following method to find your **Time In** and **Time Out** points: Use the big time location numbers on the top of the page to find a time where the first notes played (when you press **play/pause**) are the notes that you wish to replace. Enter this location in the **Time In** field. Next, use the big time location numbers on the top of the page to find a time where the first notes played (when you press **play/pause**) are the first notes that you wish to keep after the notes that you wish to replace. Enter this location in the **Time Out** field.

- Use the big time location numbers on the top of the page and set a time before the area you want to replace. This will be where you start playback of the song in order to re-record the desired section. Leave enough time (usually a bar or two) so that you will have time to prepare before the section you are replacing plays. For this example we will set our start time to **1 : 1 : 0**, because it is two bars before bar 3 (see below.)

```

Song: Big Time : My Song | Rec Track: 1
                        1 : 1 : 0 STOPPED
Time In: 3 : 1 : 0      Loop : ----
Time Out: 4 : 1 : 0    RecMode: PunchIn
Song End: 11 : 1 : 0   Metron: : Rec
more BIG Load Save more

```

- Press the **Record** button, then the **Play/Pause** button located on the front panel. Play your new part when the song reaches the part you want to replace. This technique is called "punching in." You will often get more natural sounding results if you play along with the song before the part that you are fixing. Doing this allows you to match your performance style (loudness, timing, phrasing) with what has already been recorded. Because of your settings in steps 4, 5 and 6, no extra notes will be recorded outside of the time that you want to replace.
- Press the **Stop** button when you are done. You will be able to review and save your changes just as in Step 4 of Part 3 (see above.)
- Remember to set the **RecMode** parameter back to Linear when you are done if you wish to record in the standard way again (as in Part 3, above.) This is done on the Big Time page (see below.)



Part 6: Adjusting The Volume Of Each Instrument

Adjust the volume of an instrument by adjusting the volume of the track containing that instrument program. While your song is playing, you can use the **Vol** parameter on the Song mode MAIN page to adjust the volume for the track currently set in the **RecTrk** parameter. To permanently store your volume settings with the song, you must store an initial volume for each track. Let's use the song we created in the parts above as an example. Let's adjust the volume of track 1 and store the value as an initial volume setting:

1. On the Song mode MAIN page, use the **Chan/Zone** buttons (to the left of the display) to Set the **RecTrk** parameter to track 1.

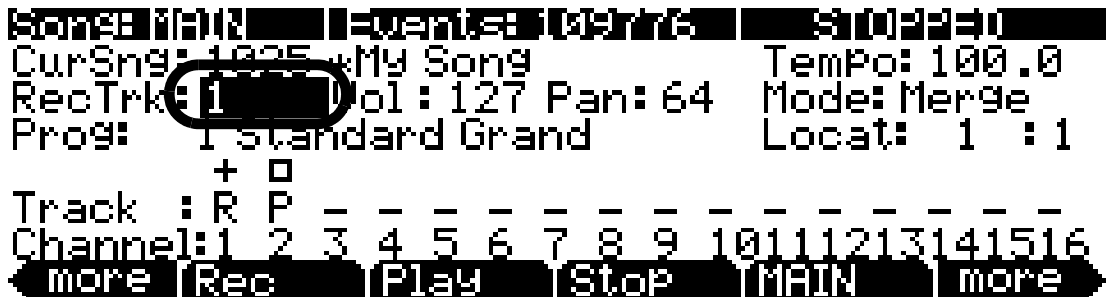

2. Find the desired volume level by adjusting the **Vol** parameter during playback, then press stop. For this example, let's set the **Vol** parameter to 80.



3. Use the left and right **more** soft buttons at the bottom corners of the display to find the **MIXER** soft button and press it (see below.) This brings you to the Song:MIXER page.

```

Song: MAIN | -Wanted | Mark | 5102250
CurSng: 1025 *My Song          Tempo: 100.0
RecTrk: 1      Vol: 80      Pan: 64      Mode: Merge
Prog: 1 Standard Grand          Locat: 1 : 1
+ □
Track : R P - - - - -
Channel: 1 2 3 4 5 6 7 8 9 10 11 12 13 14 15 16
more [MIXER] METRO NewSng ClrSng more

```

4. On the Song:MIXER page, press the **Keep** soft button to store initial values for all tracks (see below.)

```

Song: MIXER | 1: 1: 0000 | Track 1 <1 - 8>
1 2 3 4 5 6 7 8
Pan: 64 64 64 64 64 64 64 64
Vol: 80 127 127 127 127 127 127 127
Prog: 1 105 107 232 55 501 355 1014
Out: Auto Auto Auto Auto Auto Auto Auto Auto
Cur: 1 Standard Grand          Vol: 80 Pan: 64
Rec | Play | Stop | [Keep] Done

```

5. On the Song:MIXER page, press the **Done** soft button or the front panel **Exit** button. You will be asked to save changes to your song, just as in Part 3, step 4 of this guide (see above.) Saving your song completes the process of storing initial volume settings with your song.

Pressing the **Keep** soft button on the Song:MIXER page stores initial values of volume, pan, and program number for each track. Initial values are the settings that will be used when your song is played back from the beginning. Volume, pan, and program settings can change automatically over the course of the song if you change them while recording, but pressing the **Keep** button stores the current value for each setting to be recalled at the song's beginning.

6. Follow the above procedure in steps 4 and 5 to store current values as initial values after changing any volume, pan, or program parameters.



Note: Most users will want to store initial values as described above. Advanced users may not want to store initial values for every track. For details on saving an initial value for a single track only, see the *Program, Volume, and Pan* sections in the *Song Mode: The MAIN Page* section on page 12-1.

Part 6 b: Recording Volume Automation

You can also record volume automation. Volume automation is the method of recording a series of volume event messages that change a track's **Vol** parameter over the course of the song. This is useful for fading instruments in or out of a song, or adjusting instrument volumes for only specific sections of a song.

1. On the Song mode MAIN page, make sure the **Mode** parameter is set to **Merge** (see below.) (Also make sure the **RecMode** parameter has been set to **Linear**, as in Part 5, step 9, above.)

```

|EditSong:BE 00000000| track8 / 16
Tempo      : 120 .0
TimeSig    : 4 /4
FX Track   : 1
DrumTrk: 1- 2- 3- 4- 5- 6- 7- 8-
MidiDst:  L-- L-- L-- L-- L-- L-- L-- L--

|Rec| |Play| |Stop| |TRACK| |EVENT| |Save|

```

3. On the EditSong:TRACK page, set the **Function** parameter to Erase (see below.)

```

|EditSong:TRACK| track8
Function: Erase
From: 1 : 1 : 0
To : 1 : 1 : 1
Events : All

Locate : 1 : 1 : 0
|FromTo| |Play| |Stop| |Go| |Done|

```

4. Use the **Chan/Zone** buttons (to the left of the display) to choose the track to erase volume automation from. You can view the selected track number in the upper right corner of the screen.
5. Set the **Events** parameter to **Controllers** (see below.)

```

|EditSong:TRACK| track8
Function: Erase
From: 1 : 1 : 0
To : 1 : 1 : 1
Events: Controllers
Controller: ALL
LoVal : 0 Hi : 127

Locate : 1 : 1 : 0
|FromTo| |Play| |Stop| |Go| |Done|

```

6. Set the **Controller** parameter to **Volume**. You can do this quickly by selecting the **Controller** field, entering 7 on the alphanumeric pad, and pressing **Enter**. Make sure the **LoVal** parameter is set to 0 and the **Hi** parameter is set to 127 (see below.)

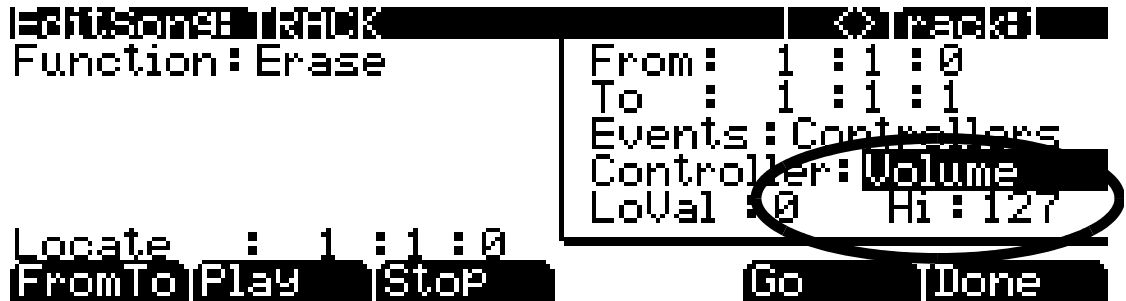

- Use the **From** and **To** parameters to set the range of time from which you want to remove your volume automation. You can play the song and watch the **Locate** field to determine these times. For this example, let's say that we want to erase volume automation from bar 3 (see below.)



- Press the **Go** soft button to delete the selected volume automation. A screen will appear reading "Erase Operation Completed!" Press the **OK** soft button to return to the EditSong:TRACK page (see below.)



- Once back on the EditSong:TRACK page, press the **Play/Pause** button to hear the result. Next, press the **Exit** button twice to return to the Song mode MAIN page. You will be presented with the Song: Save Changes page, where you can decide whether or not to save the changes you have made.
- To re-record volume automation, follow the steps in **Part 6 b**, above.

Part 7: Learning More About Song Mode

Factory ROM Songs

The PC3K includes a number of pre-recorded songs stored in the factory ROM. Investigate these songs to see the possibilities of Song mode. Feel free to edit or add to any of these songs in order to learn more about song mode. You can save the demo songs you've experimented with under new ID numbers so that you can compare between your version and the original. Also, if you replace a factory ROM song, you can revert to the original song by deleting the song using the Song Mode **Delete** soft button.

Quantizing

Quantizing is a method of adjusting the timing of notes recorded into a sequence. It can be used to adjust note timing in order to fix mistakes in a performance, or to make notes adhere to a strict timing grid as a stylistic choice (as in much modern electronic music.) Quantized notes have technically perfect timing but tend to sound less like a human performance. Quantization can be applied automatically to each track as it is recorded, or it can be applied after recording to only specific selections. For details see the *Quant* parameter on page 12-17 in the *Song Mode: The MISC Page* section, and the *Quantize* function on page 12-27 in the *Song Editor: Track Functions* section.

Creating Loops With The Big Time Page

On the Big Time page you can set the sequencer to loop a selection of bars. Set the **Loop** parameter to **Loop**, and set a time for the **Time In** and **Time Out** parameters. Now, pressing **Play/Pause** on the front panel will cause your selection to play repeatedly and seamlessly. You will most commonly want to set your Time In and Time Out points to equal an even number of bars such as 2, 4, 8, etc. Recording into a looped section of bars is a common technique for recording sequence based music. For example, with a drum program selected for a track, you could record a drum part by playing one drum sound each time through a 2 bar loop, until the entire 2 bar drum "beat" sounds complete.

Next, you could set the **RecMode** parameter to **Unloop**. (*To use the **UnLoop** setting, the **Loop** parameter must be set to **Loop**, and a loop length must be set with the **Time In** and **Time Out** parameters on the **BIG** page.*) With the **RecMode** parameter set to **Unloop**, any existing tracks will be played back as if they were looping from the **Time In** to the **Time Out** point, but they are actually being re-recorded linearly over absolute Bars and Beats until you press **Stop**. **UnLoop** allows you to record a linear track over a short looping section without first having to copy the section over and over again to achieve a new desired Song length. The End point of the Song is extended to the downbeat of the (empty) Bar immediately following the last Bar you were recording when **Stop** was pressed. See *RecMode* on page 12-11 for details.

You can also copy, paste, duplicate, or delete sections of the song if you want to reuse sections or make sections shorter or longer (see *Song Editing And Structure With Track Functions* below for details.) Keep in mind that you can loop any length of a song, and record into a loop with multiple layers of instruments on different tracks. This is also a common method for recording sequence based music, in which you create each section of your song from looped sequences, and then arrange the loops into the desired order for your song's structure. Afterwards you can make variations to each section if you want the song to have less of a "looped" sound.

Song Editing And Structure With Track Functions

In song mode you can easily copy part of a sequence to another time in the song, or from one track to another. You can also copy a section of all tracks at once in order to duplicate or structure entire sections of your song, such as verse and chorus sections. You can also choose groups of notes to erase, or entire bars of time to delete. There are many basic and advanced editing functions available. For details see *Song Editor: Track Functions* on page 12-24 in *Chapter 12, Song Mode and the Song Editor*.

Program Changes

If your song requires more than 16 instrument parts, one method of achieving this is with program changes. For example, let's say you've used all 16 tracks but desire a new instrument for the next section of the song. If there is a track whose instrument is not needed in the new section, this track's program could change to a new instrument sound for the section, and then change back to the original instrument sound after the section. To do this, simply press **Record** and **Play/Pause** and then change the **Prog** parameter on the Song mode MAIN page to the new program at the desired time. This can be done most precisely if you know the ID# of the program you wish to change to. Enter the number with the alphanumeric pad and then press **Enter** when you want to make the change. You won't be able to see the numbers you've entered until you press **Enter**, but you can press **Cancel** to start over if you've made a mistake or if you are unsure what you've entered. Use the same method if you would like to change the program back to the original after the new section.

The Event List

Song mode is a powerful composition tool because just about anything that you do on the PC3K is recorded into a track as event messages. Once recorded, these events can be altered, copied or removed. Each track has an event list, containing all of the events recorded into a track, from which they can be viewed and edited. For details see *Song Editor: The EVENT Page* on page 12-31 in *Chapter 12, Song Mode and the Song Editor*.

Appendix A

Specifications

MIDI Implementation Chart

Model: PC3K

Manufacturer:
Young Chang

Date: 12/01/07
Version 1.0

Digital Synthesizers

Function	Transmitted	Recognized	Remarks
Basic Channel	Default	1	Memorized
	Changed	1 - 16	
Mode	Default	Mode 3	Use Multi mode for multi-timbral applications
	Messages		
	Altered		
Note Number			0 - 127
	True Voice	0 - 127	0 - 127
Velocity	Note ON	O	O
	Note OFF	O	O
After Touch	Keys	X	O
	Channels	O	O
Pitch Bender	O	O	
Control Change	O 0 - 31 32 - 63 (LSB) 64 - 127	O 0 - 31 32 - 63 (LSB) 64 - 127	Controller assignments are programmable
Program Change		O 1 - 999	Standard and custom formats
	True #	O 0 - 127	
System Exclusive	O	O*	
System Common	Song Pos.	O	O
	Song Sel.	O	O
	Tune	X	X
System Real Time	Clock	O	O
	Messages	O	O
Aux Messages	Local Control	O	O
	All Notes Off	O	O
	Active Sense	X	X
	Reset	X	X
Notes	*Manufacturer's ID = 07 Device ID: default = 0; programmable 0-127		

Mode 1: Omni On, Poly
Mode 3: Omni Off, Poly

Mode 2: Omni On, Mono
Mode 4: Omni Off, Mono

O = yes
X = no

Specifications

Specifications

Specifications

PC3K8

Height: (4.33") (11.00 cm)

Depth: (13.98") (35.50 cm)

Length: (54.33") (138 cm)

Weight: (54 lb.) (24.50 kg)

PC3K7

Height: (4.33") (11.00 cm)

Depth: (13.98") (35.50 cm)

Length: (47.75") (121.29 cm)

Weight: (37.35 lb.) (16.94 kg)

PC3K6

Height: (4.84") (12.30 cm)

Depth: (13.98") (35.50 cm)

Length: (39.37") (100 cm)

Weight: (30.86 lb.) (14.00 kg)

Power

Internal AC power supply.

User selectable 120/240V AC operation.

120V current 0.5A maximum

240V current 0.25A maximum

Typical Power Consumption is 25 watts power-on, 0 watts power-off.

Audio Outputs

Main and Aux: Balanced 1/4 TRS jack

+21DBu maximum output

400 ohms balanced source impedance

24-bit A-to-D converters

>120dB dynamic range, balanced

Headphones: 8Vrms maximum output,

47 ohms source impedance

Appendix B

PC3K Bootloader

The Bootloader is the program that runs when the PC3K is first turned on. Its job is to check that hardware is functional, initialize the digital systems, and load the main synthesizer program. Under normal circumstances you might not even notice that the Bootloader is there at all, since the PC3K will start up on its own without any problem. However, if you want to update your unit, or perform maintenance on it, you may need to interact with the Bootloader program itself. This appendix describes what the Bootloader can do and how you can use its functions.

The first thing to understand is that PC3K executable programs and all object data reside on a file system contained inside the instrument. This file system is based on flash memory technology and will persist across power cycles. When the PC3K starts up, the Bootloader copies the synthesizer program into memory and executes it - just like a PC “boots up” when you turn it on. The PC3K also stores its factory-defined objects, and all of your own customized user objects on the file system. The Bootloader program itself is not found on the file system. Instead, it resides in a ROM chip that cannot be erased, and therefore is permanently installed in your PC3K.

Using the Bootloader Menu

Normally the Bootloader program will do its tasks and hand over control to the synthesizer program automatically. If you want to interact with the Bootloader itself, hold down the **Exit** button (to the right of the display) while turning the power on (while the message “Initializing Scanner” is displayed on the front panel). Instead of completing the boot process, the Bootloader will display its main menu page on the screen:

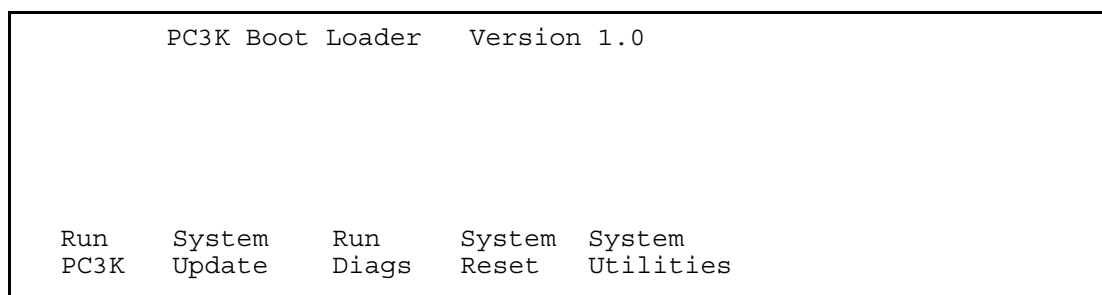

Use the soft buttons underneath the display to choose an action.

- | | |
|---------------|---|
| Run PC3K | Press this soft button to run the PC3K from the Boot Loader without restarting the PC3K. |
| System Update | Press this soft button to update the entire system (OS, objects, etc.) from a .KUF file (Kurzweil update file.) You will be prompted to choose a USB device and locate a .KUF file. |
| Run Diags | Press this soft button to enter the PC3K diagnostics utility, which can help determine if there’s a hardware error on your unit. |
| System Reset | This will clear out all user-defined objects and return the PC3K to its default “Factory” state. |

System Utilities This offers a menu of file system functions that can be useful in maintaining your system or diagnosing software problems.

You can also enter the Bootloader menu from the Master Mode menu during normal operation.

System Update (PC3K Software, Objects, Etc.)

The most common use of the Bootloader menu is to update your PC3K using new versions of software and objects supplied by Kurzweil. Updates for the PC3K come in .KUF files (Kurzweil update files,) which can include updates to the PC3K operating system, factory objects, and firmware. New versions will be made periodically as we add new features or improve performance; download these free upgrades from our website at www.kurzweil.com.

Press the **System Update** soft button to update the entire system (OS, objects, etc.) from a .KUF file. You will be prompted to choose a USB device and locate a .KUF file.

Press the **USB Device** soft button to update from a USB device (such as a thumb drive) plugged into the USB storage port. Press the **PC USB** soft button to update from a USB cable connected to a computer to the PC3K's USB Computer port.

To use a USB device you'll need a valid USB device and a computer with a USB type A port. Most modern Windows and MacOS computers support USB devices in a very straightforward way. You should be able to drag and drop the PC3K files right onto the USB device directory. After the files are copied, remove the device from the computer and place it in the USB storage port on the rear panel of the PC3K. A USB connector will only fit into the port if oriented properly, so don't force it into the port, as this may damage your PC3K or USB device. If you are having trouble inserting your USB connector into the port, try flipping the connector over.

To use the USB computer port, you should plug the USB cable into the PC3K's USB computer port and to the computer. After you enter the bootloader menu, the computer should recognize that a new device is available having the name "KurzweilPC3K". Files can be dragged and dropped directly to this device icon and will be immediately available on the PC3K.

Once you have selected the desired USB type, use the PC3K's file directory browser to find the .KUF file that you wish to use for the system update. With the file selected, press the **OK** soft button to install the update. When installation is complete, press the **OK** soft button to return to the Boot Loader main menu, then press the **Run PC3K** soft button to run the PC3K with the updated software.

Run Diags - PC3K Diagnostics Utility

The PC3K Diagnostics Utility can run specific hardware checks on PC3K systems. Most of the time you won't need to run the diagnostics, but if you're having problems with the instrument it may be helpful to perform these interactive tests when contacting Kurzweil support.

To exit the PC3K Diagnostics Utility, press the **EXIT** button. You will return to the main Boot Loader menu.

System Reset

If you've made many, complex updates to your objects, and have saved a number of files off to external storage, you might want to restore the instrument to its default state. This is especially helpful if you're having problems getting sound programs or setups to work properly, or think there may be some kind of underlying hardware problem. **(Remember to save your work in the Storage menu. Once deleted, the files are completely removed from the PC3K and there is no way to retrieve them.)** To clear all user objects and restore the factory default state, press the soft button labeled **System Reset** on the Bootloader menu. The PC3K will ask you to confirm this action. Press **OK** to complete the clear function, and **CANCEL** to stop without altering anything.

System Utilities

Format Flash

Press the soft button labeled **Format Flash** to reinitialize the internal file system. This deletes all objects and the current OS. **(If possible, remember to first save your work in the Storage menu. Once deleted, the files are completely removed from the PC3K and there is no way to retrieve them.)** This will delete everything that was stored internally on the PC3K, and leave a clean, empty file system ready for use.

It is possible (though not likely) that the PC3K file system can become corrupted due to hardware failure or power outage during certain operations. This will result in the Boot Loader being unable to bring up the PC3K system correctly. In such a circumstance, the Boot Loader will take over control and present its usual menu. If the file system is completely corrupted, it will not be possible to reconfigure without first formatting the internal flash memory.

Install Module

This soft button brings up the Update Image page, where you can install individual PC3K modules. Most of the time you won't need this page, but Kurzweil support may advise you to install individual modules if you're having problems with your PC3K.

Restore Older

If you have updated the PC3K software but wish to return to the earlier version, press the **Restore Older** soft button. You will be brought to the Restore Older page and asked to choose the image to restore. Note that only one version of the previous image is available to be restored. If you've restored once, another restore will bring back the most recently updated version.

Appendix C

Changing PC3K Voltage

In most cases, you will not need to change the voltage on your PC3K. However, since different countries use different standard voltage settings, there may be times when you need to make the change.

The PC3K's fuse holder (where the power cable plugs in) is where you change the voltage. The marks on the fuse holder are 115 and 230. 115 should be used for voltages from 100 to 125. 230 should be used for 200 to 240. Generally, North America uses 115, and Europe and Asia/Australia use 230, but there are exceptions to this general rule.

The PC3K uses two 250 mA fast blow fuses for 230V or two 500 mA fast blow fuses for 115V. These can be either 1.25" X 0.25" size or 5 mm X 20 mm size fuses. Extra fuses are not provided, so you will need to acquire the correct fuse before you change the voltage.

Removing the fuse holder

Remove the power cord.

Pry open the fuse holder cover. Use a thin tool inserted into the hole where the red voltage indicator shows through.

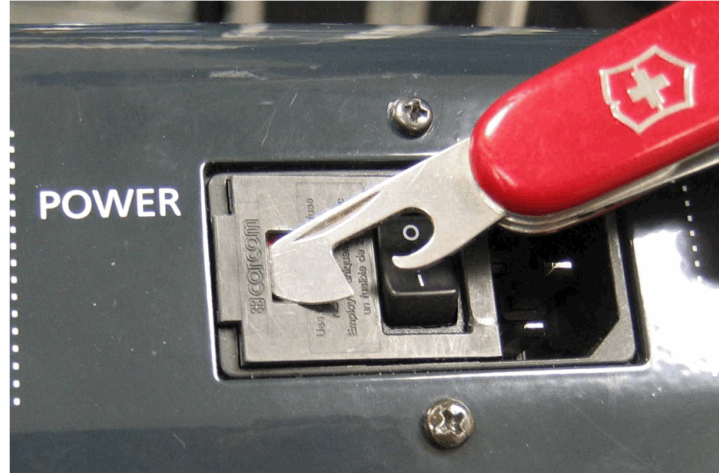

Pull up gently to open the fuse holder cover. The cover is hinged next to the power cord connection.

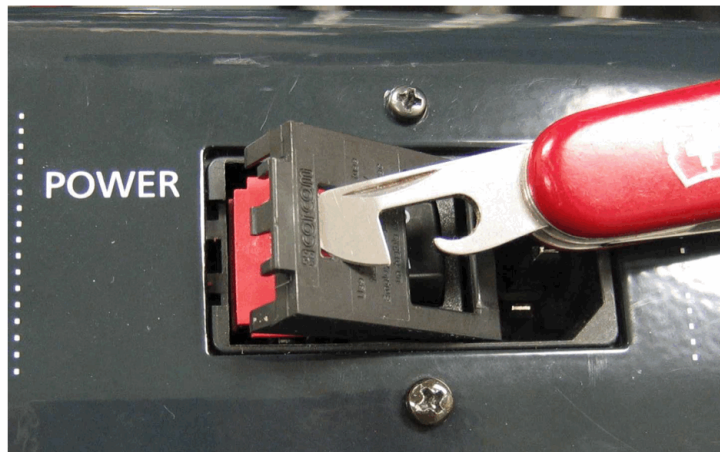

Pry out the fuse holder.



If there is only one fuse in the fuse holder, you must remove the metal clip on the empty side.

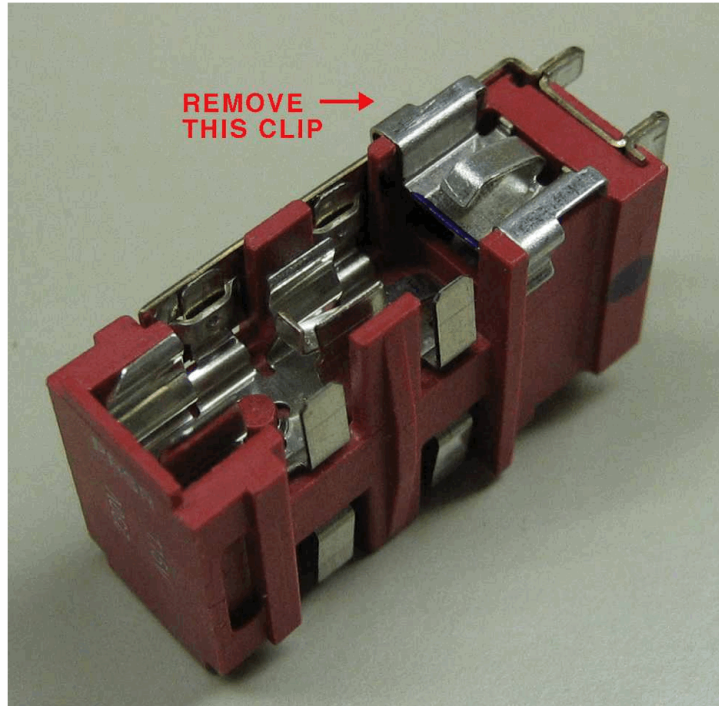

The clip just pulls off:



The clip removed from the fuse holder:

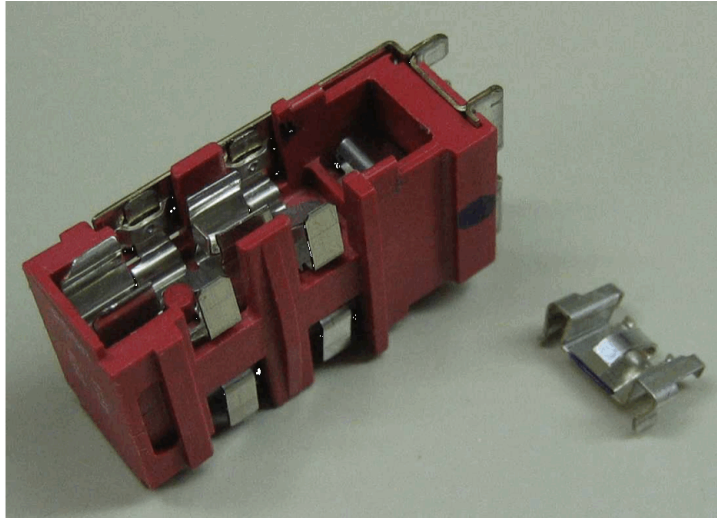

Remove the fuse. Install two 250 mA fast blow fuses for 230V or two 500 mA fast blow fuses for 115V, one on each side of the fuse holder.

The fuse holder will accept either 1.25" X 0.25" size or 5 mm X 20 mm size fuses. If using 5 mm X 20 mm size fuses, install them towards the inside end of the fuse holder near the metal pins, as shown here:

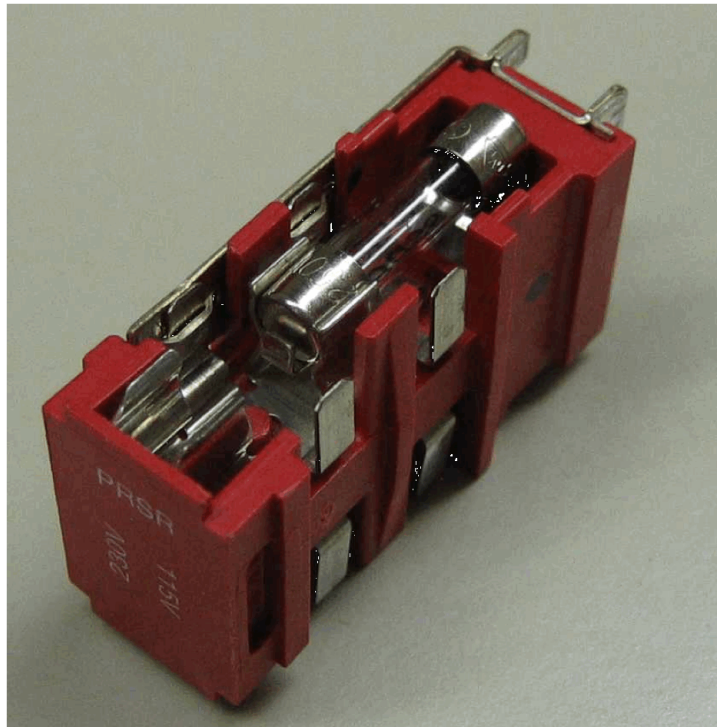

Replace the fuse holder in the power entry module with the indicator for the desired voltage towards the edge of the module, away from the power switch. Close the fuse holder cover, and check that the desired voltage indication shows through the hole. Replace the power cord.

Appendix D

PC3K Objects (V 2)

Programs

Press the **Info** soft button for controller information.

ID	Program	ID	Program	ID	Program
1	Standard Grand	25	WoodstockClunker	49	Gregg's B
2	Studio Grand	26	Stage Mix Wurly	50	Real AllOut B
3	RubensteinSWComp	27	Supertramp Wurly	51	Clean Perc
4	Horowitz Grand	28	FlydDarkside/Wah	52	The Ninth Bar
5	NYC Jazz Grand	29	What'd I SayWrly	53	Lord's B3 MW
6	Pop Power Piano	30	DeepFuzz Wurly	54	OleTime Gospel
7	ColdPiano	31	No Quarter Pnt	55	FooledAgnVox
8	Grand "Evans"	32	MistyMountain EP	56	BostonScreamer
9	Blues Piano 1974	33	UK Pop CP70	57	Power Pop Horns
10	Rock Piano 1974	34	AcidJazzVelFlute	58	Sax/Trumpet Sctn
11	Lola Piano	35	TimbaSynth	59	BigBand/AMradio
12	TakeMeToThePilot	36	Blue PVC Tubes	60	MeanSalsaSection
13	Deb's Ghost Pno	37	SimpleHipHopLead	61	R&B/Funk Section
14	Ken Brns Uprigt	38	Stereo TouchKoto	62	Bassie Orchestra
15	SMiLE/RkyRaccoon	39	Modwheel DJ	63	P*Funk Horns
16	Piano & String	40	Retro Sparkle	64	70s Stones Horns
17	Beaten in Rhds	41	RealSupasticious	65	Big LA Strings
18	Stevie's Rhds	42	Joe's Clav	66	DarkNYCStudio
19	Gilpin'sSuitcase	43	Rufus/Marley WAH	67	Pop Tripper Str
20	Duke's Dyno Rhds	44	Black Cow Clav	68	LoFi Studio Str
21	MotorBootyMutron	45	Hiya Ground sw	69	Vienna Octaves
22	Sweet Loretta EP	46	TrampledUnder D6	70	London Spiccato
23	Rhds/WahSW	47	Harpsichord	71	Pizzicato
24	Hotrod Dyno Rhds	48	BriteHarpsichord	72	Tremolando

PC3K Objects (V 2)

Programs

ID	Program	ID	Program	ID	Program
73	Choir Complete	104	Rockin' Lead MW	135	Perfect PnoPad
74	Haah Singers	105	P-Bass	136	Dreamy Piano
75	Manhattan Voices	106	E-Bass	137	Piano w DvStrgs
76	Aaahlicious	107	Beasties Bass	138	PnoAgtStrngs
77	NYC in LA	108	Flea/Bootsy	139	The Ancient
78	Crystal Voices	109	Big Dummy	140	DancePnoEchplex
79	Airy Pad	110	Jaco Fretless	141	Ivory Harp
80	Cathedral Vox	111	Upright Growler	142	Piano Lushness
81	Classic Comp	112	Levin/GabrlFrtls	143	Piano & Wash
82	Fitty-Fitty Lead	113	NYC Kits	144	Piano & Vox Pad
83	Big Old Jupiter	114	LA Kits	145	XfadBelltoneRhds
84	9Yards Bass	115	Rock Kits	146	Extreme Hardstrk
85	BowhSaw Bass	116	Roots/Indie Kit	147	Fagen Phaser
86	ARPesque Bass	117	Kikz/Snarz MW	148	RoyalScam Rhds
87	DaywalkerBassMW	118	EarthKikz n Snrz	149	AustrnCtyLmtsWrly
88	Harpolicious	119	Anazlog Machine	150	BrightDynamicWly
89	Slo QuadraPad	120	Produced Kit '08	151	'70sWahLeslieEP
90	Phase Shimmer	121	Natural Perc	152	3 Dog Pianet
91	Le Pesque	122	Rhythm 4 Reel	153	Classic DX Rhds
92	Wispy One	123	New Marimba	154	Rich EP+Pad
93	Bladerunner ARP	124	2-HandSteelDrums	155	90's FM Shimmer
94	Fairlight Pad	125	Real Vibes	156	Bright HardstrEP
95	Tronesque	126	SteamPunkMallets	157	Crisp and Soft
96	So Lush Pad	127	Magic Celeste	158	Soft Warm Ballad
97	Boutique Six Str	128	Drums 'n Bells	159	TX Stack 1
98	Boutique 12 Str	129	Piano Stack	160	Tight Bright FM
99	Emo Verser	130	Dark Grand	161	PolyTechnobreath
100	Voxxed Elec 12	131	Grand Piano 440	162	PianoSynth Stack
101	Real Nylon	132	Piano Recital	163	Elec Grand Stack
102	Dual Strat	133	Ole Upright 1	164	BigSyn/HornStack
103	BurningTubes MW	134	WestCoastPno&Pad	165	'70s Arena Synth

PC3K Objects (V 2)

Programs

ID	Program	ID	Program	ID	Program
166	'80s Arena Synth	197	Owen's Strings	228	Comp'd Phaser
167	'90s Funk Stack	198	Studio C Strings	229	TremBucker
168	Nexx Prog Stack	199	Tender Strings	230	Cascade Sitar
169	Crisp Clav	200	Toxic Strings	231	Heavy Buckers
170	Stevie Fuzz	201	Mixed Choir	232	Nasty'70s Guitar
171	HeartbreakerWAH	202	Concert Choir	233	Finger Bass
172	ChocloteSaltyClv	203	Aaah Vocals	234	KneeDeepMinimoog
173	SailinShoes Clav	204	Jazzy Ballad Vox	235	AC Buzzer Bass
174	StopMakingSense	205	AntiqueAhhChorus	236	Motown Bass
175	Harpsi Rotovibe	206	Bright Syn Vox	237	Squire'sHeavyPik
176	PhsyclGrafitiClv	207	Vox Orgel	238	Lowdown Bass
177	ParisCmboAccordn	208	Vox & Strings	239	Eberhardt Frtls
178	WhiterShadeB3	209	Press Lead	240	Sly Bass
179	Doors Vox	210	ClassSquare	241	Maroon Drums
180	Indagardenoveden	211	ARP2500 Brass	242	BourneRemixDrum
181	Animals Vox	212	SynBell Morph	243	BeastieRetroDrum
182	Magic Wolf	213	Perc>Morph>Bass	244	DryPumpin'Drums
183	Farfisa 1	214	EvilOctaveWheel	245	'60s Rock&Soul
184	VASTBars1-3,8&9	215	TranceRiff	246	Headhunters Kit
185	1-Note PowerRiff	216	SickoSynco	247	FranticHouseDrms
186	Miami Pop Horns	217	Buzzy Strings	248	Dance/Marilyn
187	80sPopOctaveSax	218	VA1Saw/Sqr/Pulse	249	Mellow Marimba
188	BuenaVista Brass	219	Airy Impact	250	Skullophonic
189	Tenor Express	220	Spider's Web	251	Percussionist
190	Sgt.Pepper Brass	221	ARP Big Synth	252	Shiny Sparkles
191	Goldfinger Brass	222	Class Pad	253	HybridTuned Perc
192	Bari/TenorSect	223	HarmonicEnvelops	254	Dynamic Perc
193	Studio A Strings	224	Heaven & Earth	255	Cage's Ensemble
194	Studio B Octaves	225	Bling 6 String	256	Magic Mbira
195	NashvilleStrings	226	MediumCrunchLead	257	CP80 Enhanced
196	Processed Strgs	227	DoubleCleanChrs	258	Gabriel's Melt

PC3K Objects (V 2)

Programs

ID	Program	ID	Program	ID	Program
259	VideoKilledRadio	290	Stereo Pickups	321	Yesesis Tron Str
260	Brighter CP	291	70sBubblegumClav	322	Moby TurntblTron
261	TouchRezSynthCP	292	TreblClavWhlmute	323	Space Oditty
262	Power CP	293	Mutron+Synth sw	324	RocknRollSuicide
263	Dark Chorus CP	294	Bi*Phaz Clav	325	Octave Tron Str
264	Inside Out CP	295	'80s Flange Clav	326	Siberian Khatru
265	Pianet Classic	296	VAST Env SynClav	327	Modwhl Remix Str
266	She's Not There	297	Charlemagne Clav	328	Pdl PitchbendStr
267	Walrus Pianet	298	Switch Pickups	329	Silent Sorrow
268	Flaming Hohner	299	EvilWomanDeepFuz	330	Bandpass Choir
269	PowerChordPianet	300	Headhunters WAH	331	Swept Tron Voice
270	Sly Ballad	301	MorleyWAH Clav	332	Mellotron Flutes
271	Black Friday	302	Dbl WAH Insanity	333	SldrEQ Mltrn Vox
272	These Eyes	303	Psychedeliclav	334	StrawberryFlutes
273	VA1 Saw Lead	304	Preston SpaceWah	335	White Satin Splt
274	VA1 Sqr Lead	305	Analog/DigHybrid	336	3Way Split Mltrn
275	MaroonSynBass	306	Jump! Obx	337	RMI Harpsi
276	VA1DistBassSolo!	307	'80s End Credits	338	Lamb Lies Down
277	DownwardSpiralMW	308	VA1Distlead CC	339	RMI Piano&Harpsi
278	VA1DstPulseWheel	309	Divider	340	BrightRMI Pn/Hrp
279	NewOrderPulses	310	Mono Trekkies	341	Dual Mode Harpsi
280	VA1 DetunedPulse	311	Disco Divebomb	342	RoyalKingWakeman
281	VA1 Detuned Saws	312	MutronTweetyPerc	343	OrganMode Pn/Hrp
282	VA1 Detuned Sqrs	313	Disgusting Bass	344	Dr.John's RMI
283	VA1 Emerson Lead	314	VA1ShaperSweeper	345	Phase sw Organ
284	MwhlClubsweeper	315	ElectroPercSynth	346	Spaced Out Bach
285	Innervate	316	MWhlMayhemBass	347	Tobacco Road RMI
286	ChemBrosBassLead	317	ElectronicaSplit	348	Traffic EP
287	UFO Pad	318	HiPassMWhlBlips	349	Tekno Tempo Echo
288	VA1SliderMorphSQ	319	Plasma Cannon	350	Trick of th'Tail
289	Shoobie Model C	320	32 Layer Bass!	351	RMI Clav WAH

PC3K Objects (V 2)

Programs

ID	Program	ID	Program	ID	Program
352	Dream On Session	383	MeanStereoSweep	414	Winds & Esp Str
353	LightYearStrings	384	PulseVowel	415	Horns,Winds&Str
354	Funkensteinz ARP	385	Winds & Strings	416	TripleStrikeOrch
355	Murky Rez Pad	386	Winds, Horn & Str	417	Tutti Orchestra
356	St PanPhase ARP	387	More Brass & Str	418	StBaroque Harpsi
357	ARP Str+Oberheim	388	LH Timp Roll Orch	419	String Continuo
358	FX Sweep ARP	389	Gothic Climax	420	VivaldiOrchestra
359	HotFilter ARP	390	Denouement	421	Trumpet Voluntary
360	St.P PWM BASS	391	Poltergeist Trem	422	Fifes & Drums
361	SquareChirpLead	392	Many Characters	423	Solo Flute
362	My Old PPG*2.3	393	Pizz w/PercUpTop	424	Tremolo Flute
363	Kashmir Str+Brs	394	Fast Str & Perc	425	Fast Orch Flute
364	Genesis Broadway	395	Fast Winds &Pizz	426	Piccolo
365	GarthsLastWaltz	396	Imperial Army	427	Solo Oboe
366	Synbrass Pillow	397	BattleSceneOrch	428	Slow Oboe
367	Warszawa Layers	398	Final Victory	429	Fast Orch Oboe
368	ELOStringSection	399	SloLineInterlude	430	Lead Oboe
369	Outkast Drums	400	Winds&EspressStr	431	Solo Eng Hrn prs
370	PopRock'08 Kit	401	Fast Winds & Str	432	Fast Orch EngHrn
371	Hello Brooklyn	402	SugarPlumFairies	433	Slow EngHorn prs
372	Snoop Kit	403	AdagioPizz Split	434	Lead English Horn
373	EpicRemixDrums	404	Pastoral Orch	435	Solo Clarinet
374	ZooYorkRemixDrms	405	Pastoral Clr Flt	436	Slo OrchClarinet
375	Roc-A-Fella Kit	406	Pastoral DblRds	437	Fast Orch Clar
376	Breakestra Kit	407	Pastoral w/ Pizz	438	Lead Clarinet
377	Cosmic Sus Pedal	408	Strings & Silver	439	Solo Bassoon
378	DigitalMoonscape	409	Reeds & Bells	440	Solo Bassoon vib
379	Falgor'sLament	410	Perc Atk Strings	441	Solo Dbl Reeds
380	BPM BionicStrngs	411	William Tell A	442	Woodwind Section
381	Swell & Hold	412	William Tell B	443	Ensemble WWinds
382	Bowie/Heroes Pad	413	Orch w/ Bells On	444	BassClar/Clar/Fl

PC3K Objects (V 2)

Programs

ID	Program	ID	Program	ID	Program
445	Solo Fr Horn	476	Solo Cello fast	507	Glockenspiel
446	Ensemble Fr Horn	477	Solo Cello slow	508	Chimes/Glock
447	Lead French Horn	478	Solo Basso 1	509	Bells Across
448	Dyn Orch Fr Horns	479	Solo Basso 2 slo	510	CelesteGlockHarp
449	HornSect Layer	480	String Quartet	511	Chime Bell
450	Solo BrtTrumpet	481	Solo Harp	512	Carillon
451	Hard Trumpet	482	Orch Harp 1	513	Adagio Strings
452	Lead Trumpet	483	Delicate Harp	514	Adagio Divisi St
453	Soft Trumpet	484	HarpArps & Gliss	515	Lead Strings
454	Slow Soft Trp	485	Slo Orch Chorus	516	Lead Divisi Str
455	Two Lead Trumpets	486	Pipe Stops	517	Fast Strings
456	Lead MuteTrumpet	487	Soft Stops	518	Fast Divisi Str
457	Solo Tenor Sax	488	All Stops	519	Aggresso Strings
458	Sax,Horns,MuteTrp	489	Chapel Organ	520	AggressDivisiStr
459	Solo Trombone	490	AllStops AllVox	521	Adagio Tutti Mix
460	Ens Trombone	491	Pipes & Voices	522	AdagioDivisi Mix
461	Trombone Section	492	Orch Timpani	523	Lead Divisi Mix
462	Dyn Orch Bones	493	Solo Timpani	524	Lead Tutti Mix
463	Bari Horn Section	494	Tam/Cym/BD/Timp	525	Fast Tutti Mix
464	Dyn Bari Horns	495	Basic Orch Perc	526	Fast Divisi Mix
465	Solo Tuba	496	Timp & Aux Perc	527	AggressTutti Mix
466	Dyn Orch Tuba	497	Temple Blocks	528	AggressDivisiMix
467	Low Orch Brass	498	Modern Blockery	529	Agrs lo/Trem hi
468	Low Brass Chorale	499	Perc & Blocks	530	AgresTrem 8ves
469	Fast Orch Brass	500	Stereo Tam-tam	531	AgressoHalfTrem
470	Brass Fanfare	501	Cymbal Roll Tr	532	Fast Tremolandi
471	Dyn Orch Trumpets	502	Xylophone	533	SloStr Prs Trem
472	Solo Violin fast	503	Solo Marimba	534	Marcato PrsTrem
473	Folk Violin slow	504	Orch Marimba	535	Sfz Prs Trem
474	Solo Viola fast	505	Vibraphone	536	Poltergeist Pad
475	Solo Viola slow	506	Celeste	537	AdagioTremSplit

PC3K Objects (V 2)

Programs

ID	Program	ID	Program	ID	Program
538	Full Pizzicato	569	Largo conSordino	600	Fast Violin II
539	Touch Full Pizz	570	Largo 8ves	601	Fast Violin div
540	Variable Pizz	571	Espressivo Lead	602	Fast Viola
541	PizzBass/ArcoLead	572	EspressivoViolas	603	Fast Viola div
542	Lead & Adagio	573	Slow Thick Mix	604	Fast Cello
543	Adagio Split	574	VerySloVeryThick	605	Fast Cello div
544	Adagio Bs/Vln I	575	Touch Thick Mix	606	Fast Bassi
545	TripleStrike Str	576	More Viola	607	Fast Bassi div
546	AdagioTutti 8ves	577	SloStr Prs Swell	608	Fast Tremolo
547	AdagioDiv 8ves	578	Rite of Strings	609	Legato Violins I
548	Adagio Octaves	579	Adagio Violins I	610	Legato Violins II
549	Lead & 8vaAdagio	580	Adagio ViolinsII	611	Legato Violin div
550	Dual Slow Split	581	AdagioViolin div	612	Legato Violas
551	LeadTuttiMix B	582	Adagio Violas	613	Legato Viola div
552	Lead Strings Split	583	AdagioViolas div	614	Legato Celli
553	Lead MixOctvs	584	Adagio Celli	615	Legato Celli div
554	Divisi Mix +solo	585	Adagio Celli div	616	Legato Bassi
555	Lead Upper Range	586	Adagio Bassi	617	Legato Bassi div
556	Lead Div 8ves	587	Adagio Bassi div	618	Legato Tremolo
557	Dual UpperDivisi	588	Adagio Tremolo	619	Aggresso Violin
558	Dual Upper tutti	589	Lead Violins I	620	Aggresso Vln II
559	Dual Half Trem	590	Lead Violins II	621	Aggresso Violin d
560	Fast Mix Octaves	591	Lead Violins div	622	Aggresso Viola
561	Fast Divisi 8ves	592	Lead Violas	623	Aggresso Viola d
562	Marcato divisi	593	Lead Violas div	624	Aggresso Cello
563	Marcato Mix 1	594	Lead Celli	625	Aggresso Cello d
564	Marcato Mix 2	595	Lead Celli div	626	Agresso Bassi
565	Marcato Mix 3	596	Lead Bassi	627	Agresso Bassi d
566	Slo Muted Strings	597	Lead Bassi div	628	Agresso Tremolo
567	Largo Mix	598	Lead Tremolo	629	Rigby's Strings
568	Largo Mix 2	599	Fast Violin I	630	Keyboard Strings

PC3K Objects (V 2)

Programs

ID	Program	ID	Program	ID	Program
631	StringMachine	662	L'tric Nat Kit	693	Bug Zapper Kit
632	Lush Pad	663	TrashPanTom Kit	694	Elektro Sand Kit
633	Add A Pad 1	664	Tin Man Kit	695	Sandy Bott'm Kit
634	Add a Pad 2	665	Cheapo Dist Kit	696	Box o' Sand Kit
635	Hi Res StringPad	666	AngryBastard Kit	697	Fine Grit Kit
636	LoFi Strings	667	Vibra Lunch Kit	698	Matchmaker Kit
637	Blue Resonance	668	Ricochet Kit	699	Zucchini Kit
638	AutoRes StrPad	669	Frida's Gate Kit	700	Pump da Well Kit
639	Ethereal Joe	670	Metallic Cut Kit	701	L'trk Reflux Kit
640	Adagio Magic	671	Cannibal Kit	702	Squash Clap Kit
641	Brt Natural Kit	672	Tunnel Feel Kit	703	Scoopit Up Kit
642	SmoothRocker Kit	673	Tuna Slap Kit	704	Tone Keeper Kit
643	Low Rocker Kit	674	Plywood Kit	705	Phase "E" Kit
644	SuperNatural Kit	675	Door Knocker Kit	706	Straw Blow Kit
645	Big Woosh Kit	676	Slapstick Kit	707	Falling Star Kit
646	Fat Nat Kit	677	Scratchbox Kit	708	Super Ball Kit
647	Abe Junior Kit	678	Anvil Head Kit	709	Pixie Dust Kit
648	Charlemagne Kit	679	Cat Scratch Kit	710	Air Waves Kit
649	H-Fact Kit	680	Scream Kit MW	711	Tub Floater Kit
650	SoftCookie Kit	681	Mangled Kit	712	Why Not Kit
651	Brushes Kit	682	Rawhide Kit	713	Turntablism Kit
652	HipgigJunior Kit	683	Shrugie Kit	714	Studio3and4
653	Cocktail Kit	684	Big Dog Kit	715	RadioKings
654	BeatBoxBrush Kit	685	Sweeper Kit	716	ResonntTraps
655	Jinglehop Kit	686	Gravel Dump Kit	717	AmbientRock
656	Tiny Bopper Kit	687	Mudflap Kit	718	Coliseum Kit
657	Move'n Air Kit	688	Mud Slinger Kit	719	RipperKit
658	Ali's Punch Kit	689	Shrug's Bros'Kit	720	TripTrash
659	Rock Trance Kit	690	Wet Sponge Kit	721	Beatbox
660	Ringling Pop Kit	691	Succotash Kit	722	SumpKitMWSus
661	Marley Kit	692	Backsweep Kit	723	ElectroKitMW

PC3K Objects (V 2)

Programs

ID	Program	ID	Program	ID	Program
724	Paper Tom	778	Poly Sweep 2	809	8' Diapason
725	Boinker	779	Scat Vocals	810	8' Ped Bourdon
726	GlubFlangeKit	780	Scat Choir	811	8' Reed
727	DryFattyKit	781	FM SqareBell	812	8' Gamba
728	Drums w Bass 1	782	Toot Lead	813	8' DiaCeleste
729	RMI ElecKit	783	WetToot	814	8' Ballpark Stop
730	GateClapDrmLE	784	LegatoBrassyLead	815	8' Viol
731	Dub Kit	785	Treble FM Lead	816	51/3' Ped Bourd.
732	Rock Room Drums	786	Delicate FM Lead	817	4' Open Flute
733	ResNoise Kit	787	Micromoog Plus	818	4' Stop Flute
734	144ms Gated Kit	788	Deep Vox Bed	819	4' Diapason
735	FatNoise Kit	789	SloSynOrch Wet	820	4' Ped Bourdon
736	Hypd Natural Kit	790	Vox Bed 2	821	4' Reed
737	Rango Kit	791	Hi Vox Cloud	822	4' Gamba
738	NoiseSlapToms	792	LFO Pitcher Pad	823	4' DiaCeleste
739	16LayerCake Kit	793	MagicChinaFlower	824	4' Ballpark Stop
740	HopRoom Kit	794	Climax Perc	825	4' Viol
741	Natural Ringer	795	16' Open Flute	826	2 2/3' OpenFlute
742	BeachGroover	796	16' Stop Flute	827	2 2/3' StopFl 12
743	Rock Snarer	797	16' Diapason	828	2 2/3' Diapason
744	Drum Pad Kit 1	798	16' Ped Bourdon	829	2 2/3' Reed
745	Filter Kit	799	16' Ped Diapason	830	22/3' Gamba
769	FM E Piano 1	800	16' Ped Reed	831	2 2/3' DiaCelest
770	FM E Piano 2	801	16' Reed A	832	22/3' Ballpark S
771	Hybrid DX & Pad	802	16' Reed B	833	2 2/3' Viol
772	FluidStradaGtr	803	16' Gamba	834	2' Open Flute
773	Fluid E Gtr	804	16' DiaCeleste	835	2' Stop Flute
774	OrganWaveComper	805	16' Ballpark Sto	836	2' Diapason
775	Poly Brassy	806	16' Viol	837	2' Reed
776	SynBrass Comper	807	8' Open Flute	838	2' Gamba
777	PolyPitch Brass	808	8' Stop Flute	839	2' DiaCeleste

PC3K Objects (V 2)

Programs

ID	Program	ID	Program	ID	Program
840	2' Ballpark Stop	924	Wah B3+EchoplX	955	GM Synth Kit
841	2' Viol	925	Sweet n Nice	956	GM Jazz Kit
842	Pro Piano	926	Soft Chords	957	GM Brush Kit
843	Big Pop Piano	927	SputtringingB3	958	GM Orch Kit
897	Ezra's Burner	928	Melvin C.	959	VAST1-3Ch/Perc
898	HotTubeGospel	929	All Out	960	VAST1-3 Ch/Perc2
899	B3 Midrange	930	J's Comper	961	Fisher's VAST B3
900	Blues&Gospel	931	Brother Jack	962	Ripply Six
901	Prog B3 Perc2	932	Model One	963	Ripple Siner
902	Prog B3 Perc3	933	Thick Gospel	964	Ripple Thump
903	Tube B3 Perc	934	Growler B	965	Ripple RevDrum
904	Prog B3 Perc4	935	Ready 2 Rock	966	Dark RevDrum
905	BrgtTubeScream	936	Thimmer	967	SpacerLead
906	Zepelin Solo	937	The Real ABC	968	Ripple Sine2
907	Argent B3	938	GospelSpecial	969	Ripple Thump2
908	MusselShoalsB3	939	In The Corner	970	Blues Harmonica
909	XtremTubeB3Prc	940	NightBaby	971	WheelBowCello
910	Classic Traffic	941	Gimme Some	972	WheelBowViola
911	Warm B3	942	The Grinder	973	WheelBowFiddle
912	Warmer B3	943	Mean Bean	974	Electric Cello
913	ChrsEchoOrgan	944	Dew Dropper	978	Classic MiniBass
914	SlowPhaseOrgan	945	Two Out	979	TalkWahPoly+Syn
915	Room B	946	J's All Out	980	MeanWahMono
916	Lord'sDirtBomb	947	My Sunday	981	Bass Pedal
917	Mellow Mitch	948	Good Starter	982	SyncSqr Template
918	Sly's Revenge	949	Sacrificer	983	CarpenterSndtrck
919	LateNighter	950	LeeMichaelsB3	984	ElectroMechLead
920	FirebreatheC3	951	GM Standard Kit	985	PannerTemplate
921	Mr Smith	952	GM Room Kit	986	Hi Arp Delay
922	Errol G.	953	GM Power Kit	987	Perc Arp Synth
923	Testify	954	GM Elec Kit	988	Candy*O SyncLead

PC3K Objects (V 2)

Programs

ID	Program	ID	Program	ID	Program
989	WheelSyncBlips	1020	VA1NakedPWMMono	4122	Jazz Guitar
990	12SAWMWheelLead	1021	VA1NakedSawPoly	4123	Clean E Gtr
991	HotMalletMWheel	1022	VA1NakedSqrPoly	4124	Muted Guitar
992	ScreaminWhlBass	1023	VA1NakedSqrMono	4125	Overdrive Gtr
993	SyncWheelLead	1024	VA1NakedSawMono	4126	Distorted Gtr
994	ModwheelKotoSyn	4096	GM Piano 1	4127	Gtr Harmonics
995	VASprSaw	4097	Bright Grand	4128	Acoustic Bass
996	VASprSaw+Allpass	4098	Electric Grand	4129	Finger Bass
997	Silent Program	4099	Honky-Tonk Pno	4130	Picked Bass
998	Click Track	4100	Elec Piano 1	4131	Fretless Bass
999	Default Program	4101	Elec Piano 2	4132	Slap Bass 1
1000	Diagnostic Sine	4102	Harpsichord	4133	Slap Bass 2
1001	Propht V Sync Ld	4103	Clavinet	4134	Synth Bass 1
1002	Tempo SyncPulse	4104	GM Celesta	4135	Synth Bass 2
1003	Slo Syn Orch	4105	Glockenspiel	4136	Violin
1004	Anabrass	4106	Music Box	4137	Viola
1005	Fat Syn Orch	4107	Vibraphone	4138	Cello
1006	WheelGrowlMoogue	4108	Marimba	4139	Contrabass
1007	The Way It Is	4109	Xylophone	4140	Tremolo Strings
1008	AlphaCentauri	4110	Tubular Bells	4141	Pizz Strings
1009	SynOrcWhaleCall	4111	Dulcimer	4142	Harp
1010	Downes Lead	4112	Drawbar Organ	4143	Timpani
1011	Minipulse 4Pole	4113	Perc Organ	4144	Ensemble Strings
1012	BPM Lead	4114	Rock Organ	4145	GM Slow Strs
1013	GatedSqrSweepBPM	4115	Church Organ	4146	Synth Strings 1
1014	BPMEchplexPad	4116	Reed Organ	4147	Synth Strings 2
1015	GatedNoisweepBPM	4117	GM Accordion	4148	Choir Aahs
1016	Cars Square Lead	4118	Harmonica	4149	Voice Oohs
1017	Data Shape Saw	4119	Bandoneon	4150	Synth Vox
1018	Saw+Moogue 4Pole	4120	Nylon Guitar	4151	Orchestra Hit
1019	VA1NakedPWMPoly	4121	Steel Str Gtr	4152	Trumpet

PC3K Objects (V 2)

Programs

ID	Program	ID	Program	ID	Program
4153	Trombone	4184	Fantasia	4215	Reverse Cymbal
4154	Tuba	4185	Warm Pad	4216	Gtr Fret Noise
4155	Muted Trumpet	4186	Polysynth	4217	Breath Noise
4156	French Horn	4187	Space Voice	4218	Seashore
4157	Brass Section	4188	Bowed Glass	4219	Bird
4158	Synth Brass 1	4189	Metal Pad	4220	Telephone
4159	Synth Brass 2	4190	Halo Pad	4221	Helicopter
4160	Soprano Sax	4191	Sweep Pad	4222	Applause
4161	Alto Sax	4192	Ice Rain	4223	Gun Shot
4162	Tenor Sax	4193	Soundtrack		
4163	Baritone Sax	4194	Crystal		
4164	Oboe	4195	Atmosphere		
4165	English Horn	4196	Brightness		
4166	Bassoon	4197	Goblins		
4167	Clarinet	4198	Echo Drops		
4168	Piccolo	4199	Star Theme		
4169	Flute	4200	Sitar		
4170	Recorder	4201	Banjo		
4171	Pan Flute	4202	Shamisen		
4172	Bottle Blow	4203	Koto		
4173	Shakuhachi	4204	Kalimba		
4174	Whistle	4205	Bagpipe		
4175	Ocarina	4206	Fiddle		
4176	Square Wave	4207	Shanai		
4177	Sawtooth Wave	4208	Tinkle Bell		
4178	Synth Calliope	4209	Agogo		
4179	Chiffer Lead	4210	Steel Drums		
4180	Charang	4211	Wood Block		
4181	Solo Vox	4212	Taiko		
4182	5th Saw Wave	4213	Melodic Tom		
4183	Bass & Lead	4214	Synth Drum		

Setups

Press the Info soft button for controller information.

ID	Setup	ID	Setup	ID	Setup
1	TeknoRiff Sw 1-8	29	Slow Rock	57	Plucked Hammers
2	BluesJam in G	30	Oldies	58	Forbidden Planet
3	Techno Substance	31	Funk	59	Childhood Magic
4	Acoustic Split	32	Latin Danzhall	60	Autobeller
5	Slap/EP Split	33	Metal	61	Square Arp'er
6	Black Cow Split	34	Growth Pad	62	PizzicatoBenefit
7	Some Loving Splt	35	Morricone's Fall	63	GrandPad & Magic
8	Piano & Pad	36	Strings Old&New	64	TinklySweepySpcy
9	PedalsModeW/Beat	37	MonoBass & ArpSt	65	Pulsing Anthem
10	AnaBanana	38	Jazz Bass/Piano	66	PedHold PnoSolo
11	Sanctuary	39	Bass + KB3 Split	67	Rhythm Pad SW
12	World Beneath	40	Zep KB3/Pianet	68	The Wonders
13	DeepBurn	41	ElectricBass/EP	69	Drops of Jupiter
14	Sync Scene	42	ARP & Bass	70	No Complaints
15	MeanClav/Rhds	43	Fretless Split	71	Brighton Lush
16	Bigband P Btt1	44	Big Lead	72	Nylon and Ivory
17	MeanPianet/Piano	45	SynBass/Lead	73	Drawbr/Slidr SW
18	Oldtimey Blues	46	Play	74	Mini/E3/Clav
19	OldR&B	47	MovieBuildup	75	LA Split
20	Old School Jam	48	GuitarEnsemble	76	Bluman Live
21	Brooklyn Smoov	49	Big n Warm Pn/Gt	77	Shwales
22	Country	50	Joni Split	78	Eden's Sky
23	Rockroll in A	51	StrangeLands	79	Marimbatronic
24	Hip Hop	52	Perc Attack Orch	80	Tronotronic
25	Jazz	53	Disco Fanfare	81	Orch Fantasy
26	Reggae	54	Pad w/Benefits	82	Stringotronic
27	World	55	AnaSoup	83	Harp Ensemble
28	Dance	56	Blue Lights On	84	MarimbasGoneWild

PC3K Objects (V 2)

Setups

ID	Setup
85	Ivory Ensemble
86	Spaces
87	Bubble Pad
88	Fat Ana
89	Frets o' Lush
90	Dual Manual B3
91	Dual Manual B3 2
92	Dual Manual B3 3
93	Dual Manual B3 4
94	Mwhl Blips ARP
95	Mwheel DJ Arp
96	Margarita Split
97	ConstantGardener
98	Run Rago Run
99	Bionic Rock
100	Pea Soup
101	Walking Arps
102	Eminence in C
103	VampireNightclub
104	Kurz Jacinto
105	Music Bed
106	Octavia
107	Rosin Rhythm
108	Insanity
109	Bells
110	LowChunkerGroove
111	Hold Sum Notes
112	Reich Piano
113	AnaBouncer
114	The Factory
115	FattyFatFat

ID	Setup
116	Brass Bouncer
117	Electric Dancer
118	Treso-Pulser
119	Mellow Tripper
120	SpacePulser
121	Mood Arp C2
122	Strum Thurmond
123	Drum n Bassr
124	funk setup
125	Hazel Jam
126	Internal Voices
127	Clear Setup
128	Default Setup
129	GetBerni Sld E-I
130	Pipe Organ 1
131	Pipe Organ 2
132	Pipe Organ 3
133	Pipe Organ 4
134	Pipe Organ 5
135	Pipe Organ 6
136	BuildAnOrchestra
137	Sugar Plum Army
138	FanfareOrchestra
139	ElecFanfareOrch
140	ElecBalladOrch
141	Magic Pizz Orch
142	ElecBalladSplit
143	Jaco n Joe
144	PianoComp/Split
145	Fusion Comper
146	Pno&Choir-or-Str

ID	Setup
147	RichBalladComper
148	NewAgeComper
149	Voyager One
150	OrchestraOfBells

Effect Chains

#	Chain
1	Little Booth
2	Soundboard
3	Small Dark Room
4	Sax Chamber
5	Small Hall
6	Medium Hall
7	Green Room
8	Opera House
9	Real Nice Verb
10	Empty Stage
11	Med Drum Room
12	AbbeyPianoHall
13	Predelay Hall
14	Sweeter Hall
15	Concert Hall
16	Symphony Hall
17	Cathedral Chorus
18	DeepChorsDlyHall
19	Omni Stage
20	Classic Plate
21	MediumWarm Plate
22	Real Plate
23	Smooth Plate
24	Gated Plate
25	Basic Delay 1/8
26	4-Tap Delay BPM
27	Echo Plecks BPM
28	Timbered Taps
29	Dub Delay
30	Sm Stereo Chorus
31	Chorusier
214	Live Room

#	Chain
32	Stereo Chorus
33	Dense Chorus
34	Soft Flange
35	Wetlip Flange
36	Flanged Taps
37	Slow Deep Phaser
38	Fast&Slow Phaser
39	Phaser EGT
40	Thin Phase Sweep
41	Tremolo BPM
42	Simple Panner
43	Thin Phase Sweep
44	Leslie start
45	SubtleDistortion
46	EPiano Distortzn
47	Distortion + EQ
48	Ray's EP
49	Scooped Distort
50	Burning Tubes!
51	3BandDrumComp
52	Snare Compressor
53	Snare Cmp w/Rvb
54	Kick Compressor
55	Hard Knee Compr
56	Bass Comp Mutrn
57	PnoEnhancement
58	LA2A for Strings
59	Resonant Filter
60	Aux Echoplex
61	Bandsweep Filter
62	Hi FrequencyStim
275	gshot vrb

#	Chain
63	Ring Modulation
64	Frequency Offset
65	Lazer Tag Flange
66	Fallout PitchLFO
67	Reverse Reverb
68	Reverse Reverb 2
69	Oil Tank Reverb
70	Laser Reverb
71	Gated Laserverb
72	ReverseLaserverb
73	Envelope Followr
74	Envelope Filter2
75	Trip Filter
76	Stereoizer
77	Barberpole Phzr
78	Laser Dly Reverb
79	Degenerator
80	Basic Delay 1/8
81	Arp Delay Loop
129	Basic Delay 1/8
147	snarcmp1
176	Lead EGT6
193	LitePad2
203	PhaseDly1
204	ThinphaseSweep
206	hhpitchr1
209	Snarcmp1
210	SymphonyHall 1
211	SymphonyHall 2
212	SymphonyHall 3
213	Jazz Stage
337	Hot Leslie 122e

PC3K Objects (V 2)

Effect Chains

#	Chain
215	String Chamber
216	Fife Stage
217	Live RecitalHall
218	AbbeyBrasHall2
219	Smooth Long Hall
220	kickcmp3
223	kickcmp4
224	snarcmp4
226	kickcmp5
229	Bright Hat Room
230	BrightFlange
233	snarshaper6
240	Reverb2
255	Flange+Delay
257	Empty Stage II
258	AbbeyPianoHall 2
259	Opera House II
260	Vintage Strings2
261	Classic Plate II
262	Recital Hall II
263	Small Hall II
264	Real Niceverb II
265	Medium Hall II
266	Small Dark Room2
267	PnoRvb II
268	ShortPnoRvb III
269	PnoEnhancRvb3
270	RevComp5
271	Clunker II
272	St CHDly II
273	OmniStage
274	OmniStage
395	Cathedral Vx

#	Chain
276	deep part1
277	DbISloFlangeCmp
278	alphacentauri1
279	Timbered Taps 2
300	GospelDistLeslie
301	GimmeSomeLeslie
302	DF OrganRoom
303	GimmeSomeLesl
304	GimmeSomeLesl2
310	AcceleratorLes 2
312	ExpressLeslie
313	Leslie 122 a
314	Mitch's Leslie
315	Melvin's Leslie
316	Greg's Leslie
317	RoomyLeslie 122
318	Soft Leslie 122
319	CrunchLeslie 147
320	Thimmer Leslie
321	Jimmy's Leslie 2
323	Organ Taps
324	Leslie CleanAS
325	Leslie 122 cr
326	Jimmy'sBrakeLes
327	Greg's Latcher
328	Nice Leslie
329	Clean Leslie
330	Warm Leslie
331	NewLord 1
333	CrunchLeslie122
334	Hot Leslie 122b
335	BostonLeslie1
450	SynthLead

#	Chain
338	Hot Leslie 122f
339	Soul Leslie122 4
340	Leslie B 122
341	Joey Leslie 122
342	Hot Leslie 122g
343	Hot Leslie 122h
344	TapChorus Leslie
345	SlowPhasedLeslie
363	Nonkb3 A
364	Warm Leslie12
365	WarmDistlLes1dw
366	BrighDistlLes1
367	DistleratorLes 6
368	BrightDistlLes
369	DistlLes dw41
370	Prog Leslie1
371	LightDistlLes2
372	DW Leslie13
373	LeeMichaels 1
375	DW Leslie12
376	DistlLes 5
377	Sly Leslie
378	LightDistlLes
379	FisherLeslie
380	Soul Leslie122 7
385	NewLord 1
386	SystemTemp Tap
387	WaterDistSynth
388	FlangeVoiceHall
389	BrightFlangeHall
391	FlngRecitalHall
392	Med Drum Room
489	HeavyBuckers

#	Chain
396	BurningTubes5
397	PunchBassAmp
399	RevverLeslie
400	Bradley's Barn 1
401	Bradley's Barn 2
403	LA2A for Strings
411	ChrsDly
412	RealDrmComp
414	RealDrmComp2
415	TiteDrmComp
416	Marimba Hall
420	AGT Reverb
422	WarmCruncher
424	Fierce Lead
425	CompTrem
426	12StWarmCrunch
427	Phaser EGT
428	SnareComp1
430	KickComp1
431	60's BigDrumRoom
434	AGT EnhCD
435	CDRecitalHall
436	Nylon EnhCD
439	ChrsDblRoom
440	EnhcBassAmp
441	FlangVoiceHall2
442	Vocals w FXnMic
445	Harpolicious
446	ChrsDly
447	EGT Hall
448	Burning Tubes
449	Chorus AGT
666	Small Dark Room

#	Chain
451	SynthBassAmp
452	MosqueySwirl
454	PadFX2
455	PadFX1
456	Chr & Echo
457	Vocals w FX
458	DrySynthCDR
459	WetSynthCDR
461	VibesRoom
462	PercussionRoom
463	CagesRoom
464	CmpRecitalHall
465	StrRecitalHall1
466	StrRecitalHall2
467	RecitalHall
468	MyJaco
469	UprightBassRoom
470	Levin Chorus
472	Bright Room
473	Med Dark Room
474	BasicReverb
477	Medium Hall 4U
478	KickComp2
479	ColdPliano 2
480	FDR PercRoom
482	NylonAgtVerb
483	3BandDrumComp
484	KikComp 4:1
485	ToxicStrings
486	3BandDrumComp2
487	Scoopd Dist EGT2
488	NotScoopd Dist
717	Deep FuzzBass 1

#	Chain
491	ProBassComp
492	NYCTripStrings
493	ProBassComp2
496	DirtLordAmp
500	Setup Aux Verb
501	Setup Aux DDL
517	Early Reflection
518	Pad Depth Pt1
519	Gunshot Verb
520	AlphaCentauri 1
521	BasicCDR
522	Synthorc BPM
523	BPM Flange Dly
524	DbISloFlangeCmp
644	StevieTrem EP 1
645	Beater EP1
646	Jamerson1
648	SlyBASSComp1
651	Trampler 1
652	HipHop Drms1
654	HipHop Drms2
655	TOP Drum Reverb1
656	HOP Drum Reverb1
657	HopKickcmp1
658	NoQuarter
659	TechnoHHDly 1/8
660	HOP Drum Reverb3
661	HopKickcmp7
662	Roomverb1
663	Kickcmp6
664	Snarcmp11
665	Reverb3
764	ShortPnoRvb31

PC3K Objects (V 2)

Effect Chains

#	Chain
667	Snarcmp12
668	Kickcmp13
670	BeastieDrums
671	Clunker13
675	Funksnare9
676	Funksnare8
680	EPDistPhase1
681	RayEP 1
682	Deep Fuzz 1
685	Deep Fuzz 31
687	ReverseVerb1
690	Acidflute
691	Blueman1
692	CompDelay12
694	SmallDarkRoom3
695	PlainComp15
696	RevComp4
697	EP RotoAmp12
700	HiMutron 1
701	Sax Chamber 21
702	BigDarkRoomDW
703	New Gtr 31
704	PnoRvb 14
705	Small Hall11
706	PnoRvb21
707	Empty Stage 11
708	Mutron 2
711	PlainComp12
713	CDR Synth
714	SynthFlangenDely
715	QuantzEnhanceSyn
716	BladerunnrRvb
810	BassFleaCompMu

#	Chain
718	Eber Bass
719	SynFatener& Ech2
720	CP80Enhanc1
721	Fisher'sHarm Mic
722	AbbeyPianoHall2
723	Medium Hall 2
724	Fagen Phaser
726	SmallWurly
727	Basic WurlyEP
729	Cheese Horns
730	BasicChorusDly 2
732	Wallflower Ch
733	ChPanDlyComp
734	CheeseChorus
736	CompDelay
737	SynFatener& Ech3
738	BIGCompDelay
739	UprightPiano
740	SitarCmpRvb
741	AC Bass 3
742	VoxKB3
743	Blackfriday
744	Blackestfriday
745	Flange 4
750	Good Leslie1
754	Good Leslie4
756	GoodLeslie 6
757	WhitrShadeLeslie
758	Inagadadavita
759	GoodLordLeslie
760	Small HallComp1
762	GoodLeslie 5
845	Elton1

#	Chain
765	St CHDly
766	Synphase1
768	St CHDly
771	Walrus EP
772	EPChr16
773	Siberia
775	Deep Fuzz 5
780	Flange Echo 2
781	ARPMosque Room
782	Chr & Echo
784	Mutron Clav 2
785	Siberia II
786	EnhanceComp1
787	Shaper->Reverb2
788	Clav Phase1
790	SynlaserFlange 1
792	RockyRaccoon
793	Squire
794	Flange 4
795	Deep Fuzz Clav
797	Clav Comp1
798	SmallClav
799	Synth Shimmer
801	PhaseDly1
802	Shredlead1
803	ThinphaseSweep
804	EnvComp41
805	MoogBASSComp11
806	SynFatener& Ech4
807	Shredlead15
808	PlainComp21
809	Garth
882	EPChr6

#	Chain
811	Chr & Echo 2
812	BasicCDR2
813	ShaperFuzzLead 2
814	AM Big Band
815	Clunker20
816	PadFX3
817	SynFatener& Ech5
818	MarleyClav1
819	Flange Echo 4
820	Deep Fuzz Clav 3
821	GetBack1
822	Deep Fuzz Clav 5
823	ChrsDly4
824	Leslie Basic
825	MoogBASSComp5
827	EPChr1 Dyno
828	Synphase17
829	Leslie Comp 1
830	PhaseDly104
831	GoodLeslie 52
832	CPChrRvb1
833	DistLeslie Basic
834	CompKit111
835	CarlosSyn
836	MaroonSynbass
838	FloydEP1
839	PnoCmpSndBoard 1
840	SuperTrmpPhase
841	Wurly 1
842	ShortPlate4EPs
843	ShortPlate4EPs2
844	Aux Dark Room 2
917	Aux Echplex

#	Chain
846	Aux Chamber
847	BowiePno1
848	BluesPnoCmpRvb 1
849	New Gtr 31
850	Soundboard 3
851	OmniStage
853	MedPlateJazFlute
854	MistyMntn EP 2
855	PnoEnhanc22
856	ClavPhase1
857	MedRoom10
858	EPChr11
859	HardRhds1
860	PnoEnhancement
862	SmallHornChamber
864	Clunker50
865	PnoEQCmp3
866	Comp4
867	3DogEP 1
868	CompDelay
869	PnoEnhanc22
871	EPChr11
872	Old Chamber
873	ChefAid 1
874	Zep Fuzz 1
875	Bernie Clav
876	ClavRotoAmp
877	Dark Niceverb
878	Basic RayEP 3
879	LatinHornCmp
880	Basic RayEP 2
881	Raffas DX7
950	Snarcmp112

#	Chain
883	PnoEnhanc3
884	SynEnhancement
885	CompKik11
886	VintChamber
887	SmallWurly2
888	Deep FuzzPnt 1
889	Comp70
890	FooldAgainVox
891	CompKik111
892	Vintage Horns 3
893	Leslie Gospl
894	EPChr60
896	Deep Fuzz 51
898	Shredlead3
899	Synphase1
900	Synphase2
901	SynthTrem2
902	DWAuxRvb1
903	Small Dark Room2
904	Sax Chamber2
905	Small Hall2
906	Medium Hall2
907	Real Niceverb
908	Opera House2
909	Mosque Room2
910	Bright Hall
911	Echplex 1
912	AbbeyPianoHall
913	Recital Hall 2
914	Echplex 2
915	Medm Warm Plate2
916	EQVelMorph
983	RayEP 1

PC3K Objects (V 2)

Effect Chains

#	Chain
918	Farfisa1
919	Good Leslie33
920	Zep Leslie
921	Snarcmp801
922	kickcmp401
923	Deep Fuzz 6
924	SynEnv4
925	SmallComp9
926	KickComp201
927	GoodLeslie 9
928	Falgor Gtr
929	KickComp701
930	Good Leslie34
931	Synclip
932	CompDelay3
933	Cheese Horns2
934	SynthCDR20
935	Vintage Horns 2
936	Chorus Pan Delay
937	Snarcmp101
938	Filter1
939	Syncpulsedw
940	Kickcmp501
941	Snarshaper601
942	ProBassComp3
943	SynEnv5
944	SnareComp101
945	BostonLeslie2
946	Kickcmp104
947	Leslie MShoals
948	Snarcmp121
949	WhitrShadeLesli3

#	Chain
951	Snarcmp113
952	EnvKickcmp1
953	Kickcmp602
954	Snarcmp112
955	HipHop Drms101
956	PnoCmpSndBoard10
957	Epicsnare1
958	JumpSynth
959	Funksnare88
960	Kickcmp441
961	Upright3
962	HopKickcmp701
963	Leslie Comp 2
964	Kickcmp301
965	PnoRvb 1
966	PnoRvb2
967	HipHop Drms201
968	Breakdrums1
969	Blackfriday2
970	CompDelay101
971	Sax Chamber 2
972	Clunker501
973	Horn Plate 1
974	Vintage Horns
975	BrightFlange2
976	ThinphaseSweep2
977	Small Comp102
978	EPPhase1
979	NonKB3LesliePdl2
980	FlangeComp3
981	Mutron Clav 201
982	SynChorusDly202

#	Chain
984	EnhanceComp121
985	Clunker IIa
986	Pad Depth Pt1
987	AuxChorusHall
988	TechnoSyn1
989	Synphase102
990	CompDelay
991	CompMeltrn
992	ARP
993	Triplet delay
994	Bigverb
995	Syncpulse
996	compbass 2
997	CompDelay3
998	Comp501
999	RMIPhase1
1000	Joey Leslie 122
2000	GM Reverb
2001	GM Chorus

Effect Presets with Algorithms

How to Use These Tables

Each effect preset in the PC3K (for effects boxes within the Chain editor) is based on an effect algorithm from the Kurzweil KSP8 effects processor. To make the fullest use of the PC3K's effects, you will need to download a copy of the *KSP8 Algorithm Reference* from the Kurzweil Music Systems website. This book provides extensive detail on all effects parameters. For ease of use, the algorithms are indexed and linked by name and number.

For example, to find information on the available parameters for PC3K effects preset "1 Small Wood Booth," first refer to the chart below for the name and number of the preset's underlying algorithm. In this case, the KSP8 algorithm is "4 Classic Place." The description of the Classic Place algorithm begins on page 19 of the *KSP8 Algorithm Reference*, and its 3 pages of parameters are described starting on page 21 of the *KSP8 Algorithm Reference*.

Reverbs

Booth/	1	Small Wood Booth	alg 4 Classic Place	2U
Ambience	2	Natural Room	alg 5 Classic Verb	2U
	3	PrettySmallPlace	alg 4 Classic Place	2U
	4	NiceLittleBooth	alg 1 MiniVerb	1U
	5	Sun Room	alg 5 Classic Verb	2U
	6	Soundboard	alg 7 TQ Verb	3U
	7	Add More Air	alg 10 OmniPlace	3U
	8	Standard Booth	alg 8 Diffuse Place	3U
	9	A Distance Away	alg 6 TQ Place	3U
	10	Live Place	alg 8 Diffuse Place	3U
	11	Viewing Booth	alg 1 MiniVerb	1U
	12	Small Closet	alg 10 OmniPlace	3U
	13	Add Ambience	alg 1 MiniVerb	1U
	14	With A Mic	alg 4 Classic Place	2U
Room	15	BrightSmallRoom	alg 1 MiniVerb	1U
	16	Bassy Room	alg 1 MiniVerb	1U
	17	Percussive Room	alg 1 MiniVerb	1U
	18	SmallStudioRoom	alg 4 Classic Place	2U
	19	ClassRoom	alg 5 Classic Verb	2U
	20	Utility Room	alg 5 Classic Verb	2U
	21	Thick Room	alg 5 Classic Verb	2U
	22	The Real Room	alg 5 Classic Verb	2U
	23	Small Drum Room	alg 1 MiniVerb	1U

PC3K Objects (V 2)

Effect Presets with Algorithms

	24	Real Big Room	alg 5 Classic Verb	2U
	25	The Comfy Club	alg 9 Diffuse Verb	3U
	26	Spitty Drum Room	alg 7 TQ Verb	3U
	27	Stall One	alg 7 TQ Verb	3U
	28	Green Room	alg 7 TQ Verb	3U
	29	Tabla Room	alg 12 Panaural Room	3U
	30	Large Room	alg 7 TQ Verb	3U
	31	Platey Room	alg 14 Grand Plate	3U
	32	Bathroom	alg 5 Classic Verb	2U
	33	Drum Room	alg 12 Panaural Room	3U
	34	Small Dark Room	alg 12 Panaural Room	3U
	35	Real Room	alg 5 Classic Verb	2U
	36	Brt Empty Room	alg 7 TQ Verb	3U
	37	Med Large Room	alg 12 Panaural Room	3U
	38	Bigger Perc Room	alg 7 TQ Verb	3U
	39	Sizzly Drum Room	alg 5 Classic Verb	2U
Chamber	40	Live Chamber	alg 11 OmniVerb	3U
	41	Brass Chamber	alg 1 MiniVerb	1U
	42	Sax Chamber	alg 1 MiniVerb	1U
	43	Plebe Chamber	alg 1 MiniVerb	1U
	44	JudgeJudyChamber	alg 7 TQ Verb	3U
	45	Bloom Chamber	alg 7 TQ Verb	3U
	46	ClassicalChamber	alg 7 TQ Verb	3U
	47	In The Studio	alg 4 Classic Place	2U
	48	My Garage	alg 4 Classic Place	2U
	49	Cool Dark Place	alg 11 OmniVerb	3U
Hall	50	Small Hall	alg 5 Classic Verb	2U
	51	Medium Hall	alg 1 MiniVerb	1U
	52	Real Niceverb	alg 5 Classic Verb	2U
	53	Opera House	alg 5 Classic Verb	2U
	54	Mosque Room	alg 7 TQ Verb	3U
	55	Grandiose Hall	alg 1 MiniVerb	1U
	56	Elegant Hall	alg 1 MiniVerb	1U
	57	Bright Hall	alg 1 MiniVerb	1U
	58	Ballroom	alg 1 MiniVerb	1U
	59	Spacious Hall	alg 5 Classic Verb	2U
	60	Classic Chapel	alg 5 Classic Verb	2U

	61	Semisweet Hall	alg 5 Classic Verb	2U
	62	Pipes Hall	alg 404 Chorus<>Reverb	2U
	63	Reflective Hall	alg 5 Classic Verb	2U
	64	Smooth Hall	alg 5 Classic Verb	2U
	65	Empty Stage	alg 7 TQ Verb	3U
	66	Pad Space	alg 11 OmniVerb	3U
	67	Bob'sDiffuseHall	alg 9 Diffuse Verb	3U
	68	Abbey Piano Hall	alg 7 TQ Verb	3U
	69	Short Hall	alg 13 Stereo Hall	3U
	70	The Long Haul	alg 7 TQ Verb	3U
	71	Predelay Hall	alg 9 Diffuse Verb	3U
	72	Sweeter Hall	alg 7 TQ Verb	3U
	73	The Piano Hall	alg 7 TQ Verb	3U
	74	Bloom Hall	alg 9 Diffuse Verb	3U
	75	Recital Hall	alg 12 Panaural Room	3U
	76	Generic Hall	alg 12 Panaural Room	3U
	77	Burst Space	alg 9 Diffuse Verb	3U
	78	Real Dense Hall	alg 7 TQ Verb	3U
	79	Concert Hall	alg 9 Diffuse Verb	3U
	80	Standing Ovation	alg 11 OmniVerb	3U
	81	Flinty Hall	alg 7 TQ Verb	3U
	82	HighSchool Gym	alg 7 TQ Verb	3U
	83	My Dreamy 481!!	alg 9 Diffuse Verb	3U
	84	Deep Hall	alg 9 Diffuse Verb	3U
	85	Sweet Hall	alg 5 Classic Verb	2U
	86	Soundbrd/rvb	alg 11 OmniVerb	3U
	87	Long & Narrow	alg 7 TQ Verb	3U
	88	Long PreDly Hall	alg 11 OmniVerb	3U
	89	School Stairwell	alg 4 Classic Place	2U
Plate	90	Real Plate	alg 14 Grand Plate	3U
	91	Bright Plate	alg 14 Grand Plate	3U
	92	Medm Warm Plate	alg 7 TQ Verb	3U
	93	Bloom Plate	alg 9 Diffuse Verb	3U
	94	Clean Plate	alg 9 Diffuse Verb	3U
	95	Plate Mail	alg 11 OmniVerb	3U
	96	RealSmoothPlate	alg 9 Diffuse Verb	3U
	97	Classic Plate	alg 5 Classic Verb	2U

PC3K Objects (V 2)

Effect Presets with Algorithms

	98	Weighty Platey	alg 5 Classic Verb	2U
	99	Huge Tight Plate	alg 9 Diffuse Verb	3U
XL	100	Immense Mosque	alg 7 TQ Verb	3U
	101	Dreamverb	alg 10 OmniPlace	3U
	102	Splendid Palace	alg 5 Classic Verb	2U
	103	Big Gym	alg 11 OmniVerb	3U
	104	Huge Batcave	alg 12 Panaural Room	3U
Reverse	105	Reverse Reverb 1	alg 15 Finite Verb	3U
	106	Reverse Reverb 2	alg 15 Finite Verb	3U
	107	Reverse Reverb 3	alg 15 Finite Verb	3U
Gated	108	Gated Reverb	alg 3 Gated MiniVerb	2U
	109	Gate Plate	alg 3 Gated MiniVerb	2U
w/Comprs	110	Vocal Room	alg 53 Gate+Cmp[EQ]+Rvb	4U
	111	Vocal Stage	alg 53 Gate+Cmp[EQ]+Rvb	4U
	112	Reverb>Compress	alg 51 Reverb<>Compress	3U
	113	Reverb>Compress2	alg 51 Reverb<>Compress	3U
	114	Drum Comprs>Rvb	alg 51 Reverb<>Compress	3U
	115	Rvrb Compression	alg 50 Reverb+Compress	2U
	116	Snappy Drum Room	alg 50 Reverb+Compress	2U
	117	Roomitizer	alg 50 Reverb+Compress	2U
	118	Live To Tape	alg 50 Reverb+Compress	2U
	119	L:SmlRm R:Hall	alg 2 Dual MiniVerb	2U
Unusual	120	Non-Linear 1	alg 10 OmniPlace	3U
	121	Non-Linear 2	alg 15 Finite Verb	3U
	122	Non-Linear 3	alg 6 TQ Place	3U
	123	Exponent Booth	alg 10 OmniPlace	3U
	124	Drum Latch 1	alg 10 OmniPlace	3U
	125	Drum Latch 2	alg 10 OmniPlace	3U
	126	Diffuse Gate	alg 9 Diffuse Verb	3U
	127	Acid Trip Room	alg 10 OmniPlace	3U
	128	Ringy Drum Plate	alg 104 Gated LaserVerb	3U
	129	Oil Tank	alg 104 Gated LaserVerb	3U
	130	Wobbly Plate	alg 104 Gated LaserVerb	3U
	131	Pitcher Hall	alg 383 Pitcher+Miniverb	2U
	132	DistantTVRoom	alg 383 Pitcher+Miniverb	2U
	133	Drum Neurezonate	alg 102 Mono LaserVerb	1U
	134	Growler	alg 104 Gated LaserVerb	3U

Laserverb	135	LaserVerb	alg 100 LaserVerb	3U
	136	Laserwaves	alg 100 LaserVerb	3U
	137	Cheap LaserVerb	alg 101 LaserVerb Lite	2U
	138	Gated LaserVerb	alg 104 Gated LaserVerb	3U
	139	Rvrs LaserVerb	alg 103 Revrse LaserVerb	4U
	140	LazerfazerEchoes	alg 102 Mono LaserVerb	1U
	141	Simple LaserVerb	alg 102 Mono LaserVerb	1U
	142	Crystallizer	alg 100 LaserVerb	3U
	143	Spry Young Boy	alg 101 LaserVerb Lite	2U
Rvb w/Dly	144	Gunshot Verb	alg 105 LasrDly<>Reverb	2U
	145	Slapverb	alg 11 OmniVerb	3U
	146	Far Bloom	alg 9 Diffuse Verb	3U
	147	Room + Delay	alg 105 LasrDly<>Reverb	2U
	148	New Hall w/Delay	alg 403 Chor+Dly+Reverb	2U
	149	Delay Big Hall	alg 403 Chor+Dly+Reverb	2U

Delays

DELAY	150	Basic Delay 1/8	alg 150 4-Tap Delay BPM	1U
	151	Basic Dly 250ms	alg 190 Moving Delay	1U
	152	Simple Slap 60ms	alg 190 Moving Delay	1U
	153	TightSlapbk 30ms	alg 190 Moving Delay	1U
	154	MedSlapback 76ms	alg 190 Moving Delay	1U
	155	LongishSlap 95ms	alg 151 4-Tap Delay	1U
	156	Wide Slapbk 76ms	alg 191 Dual MovDelay	1U
	157	TiteSlapAmb 50ms	alg 191 Dual MovDelay	1U
	158	33ms Ambience	alg 191 Dual MovDelay	1U
	159	17ms Ambience	alg 191 Dual MovDelay	1U
	160	Stereo Delay ms	alg 151 4-Tap Delay	1U
	161	StereoFlamDelay	alg 191 Dual MovDelay	1U
	162	Cheap Tape Echo	alg 154 Spectral 4-Tap	2U
	163	Better Tape Echo	alg 171 Degen Regen	4U
	164	Stereo Tape Slap	alg 171 Degen Regen	4U
	165	Dub Delay ms	alg 190 Moving Delay	1U
	166	4-Tap Delay BPM	alg 150 4-Tap Delay BPM	1U
	167	4-Tap Dly Pan ms	alg 151 4-Tap Delay	1U

PC3K Objects (V 2)

Effect Presets with Algorithms

	168	SemiCircle 4-Tap	alg 151 4-Tap Delay	1U
	169	8-Tap Delay BPM	alg 152 8-Tap Delay BPM	2U
	170	Multitaps ms	alg 156 Complex Echo	1U
	171	Diffuse Slaps	alg 156 Complex Echo	1U
	172	OffbeatFlamDelay	alg 150 4-Tap Delay BPM	1U
	173	Sloppy Echoes	alg 156 Complex Echo	1U
	174	Pad Psychosis	alg 191 Dual MovDelay	1U
	175	500ms BehindSrce	alg 156 Complex Echo	1U
	176	Dub Skanque Dly	alg 154 Spectral 4-Tap	2U
	177	Electronica Slap	alg 156 Complex Echo	1U
	178	Spectral 4-Tap	alg 154 Spectral 4-Tap	2U
	179	Astral Taps	alg 154 Spectral 4-Tap	2U
	180	SpectraShapeTaps	alg 155 Spectral 6-Tap	3U
	181	Fanfare In Gmaj	alg 155 Spectral 6-Tap	3U
	182	Ecko Plecks BPM	alg 170 Degen Regen BPM	4U
	183	Ecko Plecks ms	alg 171 Degen Regen	4U
	184	Degenerator	alg 170 Degen Regen BPM	4U
	185	Nanobot Feedback	alg 170 Degen Regen BPM	4U
	186	Takes a while...	alg 170 Degen Regen BPM	4U
	187	Wait for UFO	alg 170 Degen Regen BPM	4U
	188	News Update	alg 172 Switch Loops	2U
	189	Timbre Taps	alg 105 LasrDly<>Reverb	2U
	190	LaserDelay->Rvb	alg 105 LasrDly<>Reverb	2U
	191	Furbelows	alg 9 Diffuse Verb	3U
	192	Festoons	alg 9 Diffuse Verb	3U
	193	Ducked Delay	alg 174 Gated Delay	2U
	194	Drum+Bass Zapper	alg 174 Gated Delay	2U
	195	3BandDly Drums=!	alg 173 3 Band Delay	2U
	196	Warped Echoes	alg 191 Dual MovDelay	1U
	197	Ween-vox	alg 190 Moving Delay	1U
	198	L:Flange R:Delay	alg 191 Dual MovDelay	1U
	199	2Dlys 1Chr 1Flng	alg 192 Dual MvDly+MvDly	2U

Chorus

CHORUS	200	Basic Chorus	alg 202 Dual Chorus 1	1U
	201	Smooth Chorus	alg 202 Dual Chorus 1	1U
	202	Chorusier	alg 202 Dual Chorus 1	1U
	203	Ordinary Chorus	alg 202 Dual Chorus 1	1U
	204	SlowSpinChorus	alg 202 Dual Chorus 1	1U
	205	Chorus Morris	alg 202 Dual Chorus 1	1U
	206	Everyday Chorus	alg 202 Dual Chorus 1	1U
	207	Thick Chorus	alg 202 Dual Chorus 2	2U
	208	Soft Chorus	alg 202 Dual Chorus 2	2U
	209	Rock Chorus	alg 202 Dual Chorus 2	2U
	210	Sm Stereo Chorus	alg 200 Chorus 1	1U
	211	Lg Stereo Chorus	alg 201 Chorus 2	2U
	212	Full Chorus	alg 402 Chorus\leftrightarrow4Tap	2U
	213	Dense Gtr Chorus	alg 201 Chorus 2	2U
	214	Standrd Gtr Chor	alg 406 St Chorus+Delay	1U
	215	Bass Chorus	alg 202 Dual Chorus 1	1U
	216	Stereo Chorus	alg 202 Dual Chorus 2	2U
	217	Chorus Fastback	alg 400 Chorus+Delay	1U
	218	Wide Chorus	alg 202 Dual Chorus 2	2U
	219	Nickel Chorus	alg 387 WackedPitchLFO	3U
	220	Rich Noodle	alg 190 Moving Delay	1U
	221	PinchChorusDelay	alg 406 St Chorus+Delay	1U
	222	StChorus+Delay	alg 406 St Chorus+Delay	1U
	223	StChor+3vs2Delay	alg 406 St Chorus+Delay	1U
	224	CDR for Lead Gtr	alg 403 Chor+Dly+Reverb	2U

Flange

FLANGE	225	Big Slow Flange	alg 225 Flanger 1	1U
	226	Squeeze Flange	alg 225 Flanger 1	1U
	227	Sweet Flange	alg 225 Flanger 1	1U
	228	Throaty Flange	alg 225 Flanger 1	1U
	229	PseudoAnaGtrFlng	alg 225 Flanger 1	1U
	230	Flanger Double	alg 225 Flanger 1	1U

PC3K Objects (V 2)

Effect Presets with Algorithms

	231	Wetlip Flange	alg 225 Flanger 1	1U
	232	Simply Flange	alg 225 Flanger 2	2U
	233	Analog Flanger	alg 225 Flanger 2	2U
	234	Soft Edge Flange	alg 225 Flanger 2	2U
	235	Ned Flangers	alg 225 Flanger 1	1U
	236	Wispy Flange	alg 225 Flanger 1	1U
	237	Crystal Flange	alg 456 St Flange+Delay	1U
	238	NarrowResFlange	alg 452 Flange<>4Tap	2U
	239	TightSlapFlange	alg 450 Flange+Delay	1U
	240	Flanged Taps	alg 455 Flange<>LasrDly	2U
	241	StFlange+Delay	alg 456 St Flange+Delay	1U
	242	StFlng+3vs2Delay	alg 456 St Flange+Delay	1U
	243	Singing Flanger	alg 456 St Flange+Delay	1U
	244	DampedEchoFlange	alg 456 St Flange+Delay	1U
	245	Stereo Flanger	alg 225 Flanger 2	2U
	246	Gulp Flange	alg 225 Flanger 1	1U
	247	Splat Flange	alg 225 Flanger 1	1U
	248	Spread Flange	alg 225 Flanger 1	1U
	249	CacophonousFlng	alg 225 Flanger 1	1U

Phaser

PHASER	250	Slow Deep Phaser	alg 251 LFO Phaser Twin	1U
	251	Circles	alg 250 LFO Phaser	1U
	252	Saucepan Phaser	alg 253 SingleLFO Phaser	1U
	253	ThunderPhaser	alg 254 VibratoPhaser	1U
	254	Fast Phaser	alg 251 LFO Phaser Twin	1U
	255	Vibrato Phaser	alg 254 VibratoPhaser	1U
	256	Fast&Slow Phaser	alg 250 LFO Phaser	1U
	257	Wawawawawawawa	alg 253 SingleLFO Phaser	1U
	258	Slow Swish Phase	alg 253 SingleLFO Phaser	1U
	259	Slippery Slope	alg 385 Frequency Offset	2U
	260	Static Phaser 1	alg 255 Manual Phaser	1U
	261	Static Phaser 2	alg 255 Manual Phaser	1U
	262	Static Phaser 3	alg 255 Manual Phaser	1U
	263	Static Phaser 4	alg 255 Manual Phaser	1U
	264	Static Phaser 5	alg 257 Allpass Phaser 4	4U

	265	Slow Riser	alg 258 Barberpole Comb	4U
	266	BarberPole Notch	alg 258 Barberpole Comb	4U
	267	BarberPole Peak	alg 258 Barberpole Comb	4U
	268	All The Way Down	alg 258 Barberpole Comb	4U
	269	Westward Waves	alg 385 Frequency Offset	2U

Trem / Panner / Spatial

TREM/	270	Tremolo BPM	alg 270 Tremolo BPM	1U
PANNER/	271	Fast Tremolo BPM	alg 270 Tremolo BPM	1U
SPATIAL	272	Tremolo in Hz	alg 271 Tremolo	1U
	273	FastPulseTremolo	alg 270 Tremolo BPM	1U
	274	Simple Panner	alg 275 AutoPanner	1U
	275	Dual Panner	alg 276 Dual AutoPanner	2U
	276	Widespread	alg 280 Stereo Image	1U
	277	Widener Mn->St	alg 281 Mono -> Stereo	1U
	278	Dynam Stereoizer	alg 282 DynamicStereoize	2U

Rotary

ROTARY	280	CleanRotors fast	alg 290 VibChor+Rotor 2	2U
	281	CleanRotors slow	alg 290 VibChor+Rotor 2	2U
	282	CleanRotors f C1	alg 290 VibChor+Rotor 2	2U
	283	CleanRotors f V1	alg 290 VibChor+Rotor 2	2U
	284	CleanRotors f Hi	alg 290 VibChor+Rotor 2	2U
	285	CleanRotors s Hi	alg 290 VibChor+Rotor 2	2U
	286	SlightDstRotor f	alg 291 Distort + Rotary	2U
	287	SlightDstRotor s	alg 291 Distort + Rotary	2U
	288	DirtyRotors fast	alg 292 VC+Dist+HiLoRotr	2U
	289	DirtyRotors slow	alg 292 VC+Dist+HiLoRotr	2U
	290	MoreDistRotor f	alg 293 VC+Dist+1Rotor 2	2U
	291	MoreDistRotor s	alg 293 VC+Dist+1Rotor 2	2U
	292	HeavyDistRotor f	alg 294 VC+Dist+HiLoRot2	2U
	293	HeavyDistRotor s	alg 294 VC+Dist+HiLoRot2	2U
	294	Res Rotor1 fast	alg 295 Rotor 1	1U
	295	Res Rotor1 slow	alg 295 Rotor 1	1U
	296	FullRotors4 fast	alg 296 VC+Dist+Rotor 4	4U

	297	FullRotors4 slow	alg 296 VC+Dist+Rotor 4	4U
	298	VibChorStortCab	alg 298 Big KB3 Effect	4U
	299	Hi Lo Roto KB3	alg 298 Big KB3 Effect	3U

Distortion

DIST	300	Classic Gtr Dist	alg 310 Gate+TubeAmp	3U
	301	Crunch Guitar	alg 310 Gate+TubeAmp	3U
	302	SaturatedGtrDist	alg 310 Gate+TubeAmp	3U
	303	Mean 70'sFunkGtr	alg 310 Gate+TubeAmp	3U
	304	Blown Speaker	alg 390 Chaos!	2U
	305	Synth Distortion	alg 303 PolyDistort + EQ	2U
	306	Superphasulate	alg 170 Degen Regen BPM	4U
	307	Dist Cab EPiano	alg 301 MonoDistort+Cab	2U
	308	Distortion+EQ	alg 302 MonoDistort + EQ	2U
	309	Burnt Transistor	alg 304 StereoDistort+EQ	3U
	310	SubtleDistortion	alg 300 Mono Distortion	1U
	311	A little dirty	alg 305 Subtle Distort	1U
	312	Slight Overload	alg 305 Subtle Distort	1U
	313	ODriveGtrLd DICh	alg 317 TubeAmp<>MD>Chor	3U
	314	Krazy Gtr Comper	alg 317 TubeAmp<>MD>Chor	3U
	315	MildGtrOD+Dly+Fl	alg 320 PolyAmp<>MD>Flan	3U
	316	LeadGtr Dly Flng	alg 318 TubeAmp<>MD>Flan	3U
	317	Drum Shaper	alg 306 Super Shaper	1U
	318	SubtleDrumShape	alg 307 3 Band Shaper	2U
	319	SuperShaper	alg 306 Super Shaper	1U
	320	3 Band Shaper	alg 307 3 Band Shaper	2U
	321	New3BandShaper	alg 307 3 Band Shaper	2U
	322	Shaper->Flange	alg 321 Flange<>Shaper	2U
	323	Shaper->Reverb	alg 322 Shaper<>Reverb	2U
	329	Aliaser	alg 308 Quantize+Alias	1U

Dynamics

DYNAMICS	330	HKCompressor 3:1	alg 330 HardKneeCompress	1U
	331	HKCompressor 5:1	alg 330 HardKneeCompress	1U
	332	SK FB Compr 6:1	alg 331 SoftKneeCompress	1U
	333	SKCompressor 9:1	alg 331 SoftKneeCompress	1U
	334	SKCompressor 12:1	alg 331 SoftKneeCompress	1U
	336	Compress w/SC EQ	alg 332 Compress w/SC EQ	2U
	337	Compress/Expand	alg 341 Compress/Expand	2U
	338	Compr/Expnd +EQ	alg 342 Comp/Exp + EQ	3U
	339	Expander	alg 340 Expander	1U
	340	Simple Gate	alg 343 Gate	1U
	341	Gate w/ SC EQ	alg 344 Gate w/SC EQ	2U
	342	3Band Compressor	alg 336 3 Band Compress	4U
	343	3Band Compress2	alg 336 3 Band Compress	4U
	344	Mid Compressor	alg 335 Band Compress	3U
	345	OddHarmSuppress	alg 374 HarmonicSuppress	2U
	346	60Hz Buzz Kill	alg 374 HarmonicSuppress	2U
	347	Dual SK Compress	alg 347 Dual SKCompress	2U
	348	Dual Compr SCEQ	alg 348 Dual Compr SCEQ	3U
	349	Dual 3BandCompr	alg 349 Dual 3 Band Comp	8U

EQ / Filters

EQ/	350	AM Radio	alg 350 3 Band EQ	1U
FILTERS	351	U-Shaped EQ	alg 350 3 Band EQ	1U
	352	5 Band EQ Flat	alg 351 5 Band EQ	3U
	353	Graphic EQ Flat	alg 352 Graphic EQ	3U
	354	Dual Graphic EQ	alg 353 Dual Graphic EQ	3U
	355	Dual 5 Band EQ	alg 354 Dual 5 Band EQ	3U
	356	Basic Env Filter	alg 360 Env Follow Filt	2U
	357	Phunk Env Filter	alg 360 Env Follow Filt	2U
	358	Synth Env Filter	alg 360 Env Follow Filt	2U
	359	Bass Env Filter	alg 360 Env Follow Filt	2U
	360	EPno Env Filter	alg 360 Env Follow Filt	2U
	362	LFO Sweep Filter	alg 362 LFO Sweep Filter	2U

PC3K Objects (V 2)

Effect Presets with Algorithms

	363	DoubleRiseFilter	alg 362 LFO Sweep Filter	2U
	364	Circle Bandsweep	alg 362 LFO Sweep Filter	2U
	365	TripFilter	alg 362 LFO Sweep Filter	2U
	366	Resonant Filter	alg 363 Resonant Filter	1U
	367	Dual Res Filter	alg 364 Dual Res Filter	1U
	368	2 Band Enhancer	alg 370 2 Band Enhancer	1U
	369	3 Band Enhancer	alg 371 3 Band Enhancer	2U
	370	Extreem Enhancer	alg 371 3 Band Enhancer	2U
	371	HF Stimulator	alg 372 HF Stimulate 1	1U
	372	Ring Modulator	alg 380 Ring Modulator	1U
	373	PitcherA	alg 381 Pitcher	1U
	374	Pitcher B	alg 381 Pitcher	1U
	375	PolyPtVoxChanger	alg 382 Poly Pitcher	2U
	376	HollowPolyPitchr	alg 382 Poly Pitcher	2U
	377	Pitcher+Chorus	alg 411 MonoPitcher+Chor	2U
	378	Pitcher+Flange	alg 461 MonoPitcher+Flan	2U
	379	Pitcher+Chor+Dly	alg 409 Pitcher+Chor+Dly	2U
	380	Pitcher+Flng+Dly	alg 459 Pitcher+Flan+Dly	2U
	381	Ring Linger	alg 390 Chaos!	2U
	382	Waterford	alg 103 Revrse LaserVerb	4U
	383	Hip Hop Aura	alg 256 Allpass Phaser 3	3U
	384	Woodenize	alg 256 Allpass Phaser 3	3U
	385	Marimbafication	alg 256 Allpass Phaser 3	3U
	386	Frequency Offset	alg 385 Frequency Offset	2U
	387	Drum Loosener	alg 385 Frequency Offset	2U
	388	Drum Tightener	alg 385 Frequency Offset	2U
	389	Vox Honker	alg 386 MutualFreqOffset	2U
	390	EQ Morpher ah-oo	alg 365 EQ Morpher	4U
	391	EQ Morpher ee-aa	alg 365 EQ Morpher	4U
	392	EQ Morpher aw-er	alg 365 EQ Morpher	4U
	395	Contact	alg 387 WackedPitchLFO	3U
	396	Drum Frightener	alg 387 WackedPitchLFO	3U
	397	Mad Hatter	alg 387 WackedPitchLFO	3U
	398	Fallout	alg 387 WackedPitchLFO	3U
	399	Ascension	alg 387 WackedPitchLFO	3U

Chorus / Combi

CHORUS	400	BasicChorusDelay	alg 400 Chorus+Delay	1U
COMBI	401	Chorus PanDelay	alg 400 Chorus+Delay	1U
	402	Chorus & Echo	alg 400 Chorus+Delay	1U
	403	CDR Lead	alg 403 Chor+Dly+Reverb	2U
	404	CDR Lead 2	alg 403 Chor+Dly+Reverb	2U
	405	Chorus Delay 2	alg 400 Chorus+Delay	1U
	406	Doubler & Echo	alg 400 Chorus+Delay	1U
	407	Chorus Booth	alg 403 Chor+Dly+Reverb	2U
	408	ChorusSmallRoom	alg 403 Chor+Dly+Reverb	2U
	409	ChorusMedChamber	alg 404 Chorus<>Reverb	2U
	410	Chorus MiniHall	alg 404 Chorus<>Reverb	2U
	411	Chorus HiCeiling	alg 404 Chorus<>Reverb	2U
	412	ChorBigBrtPlate	alg 404 Chorus<>Reverb	2U
	413	CathedralChorus	alg 404 Chorus<>Reverb	2U
	414	Flam Dly Bckgrnd	alg 403 Chor+Dly+Reverb	2U
	415	CDHall Halo	alg 403 Chor+Dly+Reverb	2U
	416	CrackedPorcelain	alg 401 Chorus+4Tap	1U
	417	Rich Delay	alg 403 Chor+Dly+Reverb	2U
	418	FastChorusDouble	alg 400 Chorus+Delay	1U
	419	MultiTap Chorus	alg 401 Chorus+4Tap	1U
	420	Chorused Taps	alg 402 Chorus<>4Tap	2U
	421	MultiEchoChorus	alg 405 Chorus<>LasrDly	2U
	422	DeepChorDlyHall	alg 403 Chor+Dly+Reverb	2U
	423	ClassicEP ChorRm	alg 403 Chor+Dly+Reverb	2U
	424	Chorus Slow Hall	alg 404 Chorus<>Reverb	2U
	425	SoftChorus Hall	alg 404 Chorus<>Reverb	2U
	426	Chorus Air	alg 404 Chorus<>Reverb	2U
	427	PsiloChorusHall	alg 404 Chorus<>Reverb	2U
	428	SpeeChorusDeep	alg 400 Chorus+Delay	1U
	429	Chorus Room	alg 404 Chorus<>Reverb	2U
	430	Chorus Smallhall	alg 404 Chorus<>Reverb	2U
	431	Chorus Med Hall	alg 404 Chorus<>Reverb	2U
	432	Chorus Big Hall	alg 404 Chorus<>Reverb	2U
	433	Chorus Echoverb	alg 402 Chorus<>4Tap	2U

PC3K Objects (V 2)

Effect Presets with Algorithms

	434	Chorus Bass Room	alg 404 Chorus<>Reverb	2U
	435	New Chorus Hall	alg 404 Chorus<>Reverb	2U
	436	Floyd Hall	alg 404 Chorus<>Reverb	2U
	437	Into The Abyss	alg 403 Chor+Dly+Reverb	2U
	438	BroadRevSlapback	alg 403 Chor+Dly+Reverb	2U
	439	Carlsbad Cavern	alg 403 Chor+Dly+Reverb	2U
	440	Chr->GtrDst->Chr	alg 317 TubeAmp<>MD>Chor	3U
	441	That's No Moon!!	alg 403 Chor+Dly+Reverb	2U
	442	Laser Amalgam	alg 405 Chorus<>LasrDly	2U
	443	Cut it out!! CDR	alg 403 Chor+Dly+Reverb	2U
	444	Chor-Delay Booth	alg 403 Chor+Dly+Reverb	2U
	445	Chor Tin Room	alg 403 Chor+Dly+Reverb	2U
	446	Boiler Plate	alg 403 Chor+Dly+Reverb	2U
	447	O.T.T. Pad	alg 403 Chor+Dly+Reverb	2U
	448	TheChorusCloset	alg 403 Chor+Dly+Reverb	2U
	449	C-D	alg 402 Chorus<>4Tap	2U

Flange / Combi

FLANGE	450	Flange + Delay	alg 450 Flange+Delay	1U
COMBI	451	ThroatyFlangeDly	alg 450 Flange+Delay	1U
	452	Slapback Flange	alg 450 Flange+Delay	1U
	453	Flange Booth	alg 454	2U
	454	FlangeVerb Clav	alg 454	2U
	455	Flange Amb Smack	alg 454	2U
	456	Flange Dly 3-D	alg 453 Flan+Dly+Reverb	2U
	457	Fl DI Large Hall	alg 453 Flan+Dly+Reverb	2U
	458	Flanged Edge	alg 321 Flange<>Shaper	2U
	459	Flange + 4Tap	alg 451 Flange+4Tap	1U
	460	FlangeDelayHall	alg 453 Flan+Dly+Reverb	2U
	461	SloFlangeDlyRoom	alg 453 Flan+Dly+Reverb	2U
	462	Flange Hall	alg 454	2U
	463	FlangeDlyBigHall	alg 453 Flan+Dly+Reverb	2U
	464	Flange Theatre	alg 454	2U
	465	FlangeTap Synth	alg 452 Flange<>4Tap	2U
	466	Flange Room	alg 453 Flan+Dly+Reverb	2U
	467	Flange Echo	alg 452 Flange<>4Tap	2U

	468	Flange 4 Tap	alg 452 Flange<>4Tap	2U
	469	Flange Hall 2	alg 454	2U
	470	Flange-Dly Hall	alg 453 Flan+Dly+Reverb	2U
	471	Flange Delay	alg 450 Flange+Delay	1U
	472	Mecha-Godzilla	alg 451 Flange+4Tap	1U
	473	Industro-Flange	alg 453 Flan+Dly+Reverb	2U
	474	Panning FDRoom	alg 453 Flan+Dly+Reverb	2U
	475	Drum&Bass FlgDly	alg 451 Flange+4Tap	1U
	476	Laserflange	alg 455 Flange<>LasrDly	2U
	477	Pewter FlangeVrb	alg 454	2U
	478	WeirdFlangePlate	alg 454	2U
	479	F-D Hall	alg 453 Flan+Dly+Reverb	2U
	480	SyntheticRmFlg	alg 453 Flan+Dly+Reverb	2U
	481	Space Flanger	alg 452 Flange<>4Tap	2U
	482	Lazertag Flange	alg 455 Flange<>LasrDly	2U
	483	Flange->Pitcher	alg 384 Flange<>Pitcher	2U
	484	Flange->Shaper	alg 321 Flange<>Shaper	2U
	485	Pitch Spinner	alg 384 Flange<>Pitcher	2U
	486	FD Lead Madness	alg 450 Flange+Delay	1U
	487	Brite Rippleverb	alg 453 Flan+Dly+Reverb	2U
	488	Rotary Club	alg 453 Flan+Dly+Reverb	2U
	489	Flangey Hall	alg 453 Flan+Dly+Reverb	2U
	490	Flg->GtrDst->Chr	alg 319 PolyAmp<>MD>Chor	3U
	491	MyGtrAteYo'Momma	alg 318 TubeAmp<>MD>Flan	3U
	492	Glacial Canyon	alg 456 St Flange+Delay	1U
	494	Ultima Thule Pad	alg 403 Chor+Dly+Reverb	2U
	495	Dr. Who	alg 225 Flanger 1	1U
	799	Pass-Through		

Keymaps

ID	Keymap	ID	Keymap	ID	Keymap
1	Piano f Left	29	Piano 440 3Vel M	67	Clav Key Release
2	Piano f Right	30	Piano 440 3VEZ M	68	Harpsichord
3	Piano mf Left	31	Piano 3Vel L alt	69	Harpsichord Rel
4	Piano mf Right	32	Piano 3Vel R alt	70	Accordion
5	Piano mp Left	33	Piano 3Vel rag L	71	Celesta
6	Piano mp Right	34	Piano 3Vel rag R	72	kHarpsichord
7	Piano 3Vel L	35	Piano f rag L	73	kClav
8	Piano 3Vel R	36	Piano f rag R	74	kClav Rel
9	Piano 3V Easy L	37	Piano alttimb1 L	75	kAccordion
10	Piano 3V Easy R	38	Piano alttimb1 R	80	B3 Bars 1-3
11	Piano f Mono	39	Piano alttimb2 M	81	B3 Full
12	Piano mf Mono	40	Piano alttimb3 M	82	B3 Key Click
13	Piano mp Mono	41	kGrand Piano	83	B3 Dist Wave
14	Piano 3Vel Mono	42	kSyn Piano	84	B3 Full Wave
15	Piano 3V Easy M	50	Rhoadz Hard	85	B3 Bars 1-3 Wave
16	Piano 440 f L	51	Rhoadz Soft	86	B3 Bars 1-4 Wave
17	Piano 440 f R	52	Rhoadz 2Vel	87	B3 SW Wave
18	Piano 440 mf L	53	Rhoadz Thump	88	Tone Wheel Wave
19	Piano 440 mf R	57	Wurly Hard	89	kTone Wheel Orga
20	Piano 440 mp L	58	Wurly Med	90	Trumpets
21	Piano 440 mp R	59	Wurly Soft	91	Trombets
22	Piano 440 3Vel L	60	Wurly 3Vel	92	Trombets alt
23	Piano 440 3Vel R	61	Wurly Thump	93	Trombones
24	Piano 440 3VEZ L	62	Wurly Key Releas	94	Trombones alt
25	Piano 440 3VEZ R	63	FM Elec Piano	95	Low Bones
26	Piano 440 f Mono	64	Clav	96	Tenor Sax
27	Piano 440 mf M	65	Clav alt	97	Tenor Sax alt
28	Piano 440 mp M	66	Clav alt2	98	Tenor Sax Fast

PC3K Objects (V 2)

Keymaps

ID	Keymap	ID	Keymap	ID	Keymap
99	Tenor Sax med	140	kTake6 Ooh Loop	179	Square Wave
100	Bari/Tenor Sax	141	kSyn Vox	180	Square Wave Dull
101	Baritone Sax	150	Sine Wave	181	Pulse Wave 1/3
102	LegatoTenorSax	151	Partials 1 2	182	Buzz Wave
110	Stereo Strings	152	Partials 1 3	183	Bell Wave
111	Strings Left	153	Partials 1 4	184	Clav Wave
112	Strings Right	154	Partials 1 6	185	Sine Wave alttun
113	Meteor Strings	155	Partials 1 8	186	Synth Vox
114	kEnsemble String	156	Partials 1 12	187	Koreana
115	kSynstrings 1	157	Partials 1 2 3	188	Hybrid Pan
116	kSynstrings 2	158	Partials 1 2 4	189	ReedPipeBassoon
117	kEns Strings 2	159	Partials 1 2 4 6	190	FlutePipeChiff
120	Take6 Aah Attack	160	Partials 1 3 5	197	kM Dist Guitar
121	Take6 Aah Loop	161	Partials 2 3 4	198	kGM Clean Strat
122	Take6 Aah Loop a	162	Partials 2-4 Gli	199	kShift Guitar
123	Take6 Ooh Attack	163	Partials 2-10Evn	200	Steel String Gtr
124	Take6 Ooh Loop	164	Partials 2-12Evn	201	StlStrGtrHiDecay
125	Take6 Ooh Loop a	165	Partials 3 4	202	Clean Elec Gtr
126	Take6 Ooh Loopa2	166	Partials 3 4 5	203	Distorted Guitar
127	Take6 Ooh Glide	167	Partials 4 5 6 7	204	kElec Jazz Gtr
129	Take6 Bop	168	Partials 5 6 7	205	kAcoustic Guitar
130	Take6 B(op)	169	Partials 5-11Odd	206	k5 String Guitar
131	Take6 Dot	170	Partials 11-15	207	kShift Guitar 2
132	Take6 Dot alt	171	Partials 13-20	208	kSingle Mute
133	Take6 D(ot)	172	Partials 16-21	209	ksynElecJazzGtr
134	Take6 Doop	173	Partials prime	210	EBass1 Finger
135	Take6 Doop alt	174	Sawtooth Wave	212	EBass1 Fing alt
136	Take6 D(oop)	175	Saw Wave Dull	213	EBass1 Fng alt2
137	Take6 Accents 2V	176	Saw Wave Duller	214	EBass2 Finger
138	Take6 Accents 3V	177	Saw Wave Dullest	215	EBass Slap
139	kTake6 Aah Loop	178	Triangle Wave	216	Synth Fretless

PC3K Objects (V 2)

Keymaps

ID	Keymap	ID	Keymap	ID	Keymap
217	Upright Bass	267	Perc Layers 3	317	Trombet
218	Upright Bass 2	268	Perc Layers 4	318	Trumpbone
219	kEBass Slap	269	Perc Layers 5	319	Soft Trumpet
220	kAcoustic Bass	270	Perc Layers 6	320	Harmon Mute Trp
230	Dry Kit 1	271	Perc Layers 7	321	Tuba
231	Dry Kit 2	272	Conga Moose Lyr	322	Tuba/Horn
232	Dry Kit 3	273	VeryMutedTriang1	323	Tuba/Hrn Section
233	Ambient Kit 1	274	Marimba	324	Tuba/Sft Trp
234	Ambient Kit 2	275	Vibes	325	kBone/Trp 2
235	Electric Kit 1	276	Vibes/Bells	326	kHarmon Mute Trp
236	Electric Kit 2	277	Agogo/Bells	327	Plucked Harp
237	Light Kit	278	Agogo Bells Keys	328	Harp Arpeggios
238	Hybrid Kit 1/L	279	Triangle Keys	329	Harp Gliss
239	Hybrid Kit 2/R	280	Layer Vibes	333	Nylon String Gtr
240	Hybrid Kit 3/L	300	Flute	337	Choir
241	Hybrid Kit 4/R	301	Flute 2	341	Cathedral Organ
242	Kicks and Snares	302	Oboe	342	Church Organ
243	Jazz Toms/Kicks	303	English Horn	343	Timpani/Perc88ky
244	Sine Toms/Kicks	304	Bassoon	344	BassDrum & Snare
245	Ride Cymbal	305	Bsn/Ehrn/Oboe	346	Percussion 5b
246	Drum Lyrs1 C4-B4	306	Bassoon/Oboe	347	Timpani/Perc76ky
247	Drum Lyrs2 C4-B4	307	Clarinet	350	Tam/Crsh/BD/Timp
248	SFX Layers C4-B4	308	Eng Horn/Oboe	351	Temple & WdBlock
249	Reverse Drums	309	kSynflute Brt	352	Percussion 1b
260	Percussion 1	310	kSynflute mello	354	Percussion 2b2
261	Percussion 2	311	French Horn	355	kTambourine x 3
262	Percussion 3	312	French Hrn Sec	356	kCastanets x 3
263	Percussion 4	313	Baritone Horn	357	Double Bass alt1
264	Percussion 5	314	Trumpet	358	Castanets x 3
265	Perc Layers 1	315	Trombone	359	Tambourine x 3
266	Perc Layers 2	316	Trombone/Trumpet	360	Glockenspiel

PC3K Objects (V 2)

Keymaps

ID	Keymap	ID	Keymap	ID	Keymap
361	Chimes	400	Solo Violin	451	Cuica Hi
362	Xylophone	401	Solo Viola	452	Filtersnap - HiQ
363	Timpani	402	Solo Cello	453	Guiro
364	Orch Bass Drum	404	Solo Double Bass	454	GM Scratch
365	Orch Crash	405	Bass/Cello	455	Whistle
366	Stereo Tam Tam	406	Bass/Cello/Vln	456	Chinese Cymbal
367	Tam Tam Left	408	Cello/Vla/Vln	457	Brush Snare Hit1
368	Tam Tam Right	409	Solo Section 1	458	Brush Snare Hit2
369	Triangle	410	Solo Section 2	459	Brush Stir Short
370	Tambourine Roll	411	Solo Section 3	460	Brush Stir Long
371	Tambhit	412	Solo Section 4	461	808 Cowbell
372	Snare Roll	413	Bagpipe Drone	462	808 Kick
373	Snare Hit	414	Bottle	463	808 Snare
374	Woodblock	415	Chiff	464	909 Clap
375	Sleigh Bells	416	Harm Pick	465	909 Closed Hat
376	Castanet Hit	417	Harm Wave	466	909 Open Hat
377	Castanet Up	418	GM Jazz Gtr	469	Jazz Kit
378	Vibraslap	419	GM Clean Strat	470	GM Standard Kit
379	Temple Block 1	420	Strat Mutes	471	GM Room Kit
380	Temple Block 2	423	Koto	472	GM Power Kit
381	Temple Block 3	424	Mbira	473	GM Elec Kit
382	Temple Block 4	425	Orchestra Hit	474	GMWhistle/metbell
383	BassDrum/Timpani	428	GM Applause	475	GM Room Tom Lyr
384	Church Bell	429	Fret Noise	476	GM Synth Kit
385	Pizz Strngs Left	430	GM Bird	477	GM Elec Tom Sine
386	Pizz Strngs Right	431	Gunshot	478	GM SynthTom/Cnga
387	Stereo Pizz Strg	432	Ice Rain	479	GM Jazz Kit
394	Trem Strngs Left	433	Syn Drum	480	GM Brush Kit
395	Trem Strngs Right	434	Telephone	481	GM Brush Stir
396	Stereo Trem Strg	435	Sine PC3	482	GM Orch Kit
397	Stereo Trem Str2	450	Belltree	483	GM Applause

PC3K Objects (V 2)

Keymaps

ID	Keymap	ID	Keymap	ID	Keymap
485	808 Hats	522	Clave Transposed	553	kSyn Drum
486	808 Congas	523	Perc Layers 7b2	554	k808 Kick
488	Timp stretch	524	Percussion 2c	555	k808 Snare
490	Mel Tom KM	525	PercLayers2 cage	556	k909 Closed Hat
494	808 cym	526	PercLayers7 cage	557	k909 Open Hat
496	Rev Cym	527	PercLayers1 cage	558	k808 Cowbell
497	Dry Kit nw5 4v	528	TempleBlock1 ign	559	k909 Clap
498	Dry Set 1 4v	529	Tuned TBlocks 1	560	kXylo rel alt
499	Dry Set 2 4v	530	Tuned TBlocks 2	561	kSleigh Loop
500	Amb Set 1 4v	531	Solo Cello alt1	562	kAgogo Hi
501	Kurz Hats	532	Solo Cello alt2	563	kAgogo Lo
502	Elec Set 1 4v	533	Double Bass alt2	564	kCowbell
503	PercLayers4kits	534	Double Bass alt3	565	kTriangle Mute
504	Tamb4DrmLyr	535	Organ Reeds	566	kBongo Hi
505	Floor Tom	536	Crash only	567	kBongo Lo
506	Mid Tom	537	Kit Layers 1	568	kBongo Slap
507	Hi Tom	538	kGuiro	569	kConga Open
508	Dub Kit1	539	kBelltree	570	kConga Closed
509	Glub Kit	540	kFingersnap	571	kConga Slap
510	Standard Kit2	541	kOrchestra Hit	572	kTumba Open
511	Drums w Bass1	542	kWhistle	573	kTumba Flathand
512	AS Elec Kit1	543	kBirds	574	kCajon Hit
513	AS Elec Kit3	544	kIce Rain	575	kCajon Mute
514	PhunkDrums 1	545	kFret Noise	576	kTambourine Up
515	Standard Kit1	546	kTelephone	577	kTambourine Hit
516	ElecKit 3	547	kGunshot	578	kMaracas
517	Rango Kit	548	kChinese Cymbal	579	kShaker Up
518	Boinker Kit	549	kBrush Snare Hit	580	kShaker Down
519	ElecTuneKik1	550	kBrush Snare Hit	581	kTemple Block
520	Glock Alt As5	551	kBrush Stir Shor	582	kVibraslap
521	DrumPad Map1	552	kBrush Stir Long	583	kCuica

PC3K Objects (V 2)

Keymaps

ID	Keymap	ID	Keymap	ID	Keymap
584	Glock rel alt	748	Db/VnII Full L	820	Mellotron Flute
592	k2-vel [1____2__	749	Db/VnII Full R	825	ARP String Ens
593	k3-vel [1_2__3_	750	Db/VnII Full2 L	830	Clav II
594	k4-vel [12_3_4__	751	Db/VnII Full2 R	833	Clav alt3
595	k4-vel [1_2_3_4_	752	Db/Vc/Va/VnII FL	834	Clav Key Release
596	k5-vel [1_2_3_45	753	Db/Vc/Va/VnII FR	835	Pianet
597	k6-vel [1_2_3456	754	Vc/VnI Full L	836	Fast Pianet
598	k7-vel [1_234567	755	Vc/VnI Full R	840	RMI Electra Pno
599	k8-vel [12345678	756	Vc/Va/VnII Ful L	841	RMI Electra Pno2
700	Vlns I Full L	757	Vc/Va/VnII Ful R	845	RMI Harpsichord
701	Vlns I Full R	758	Va/VnII Full L	846	RMI Harpsichord2
705	Vlns II Full L	759	Va/VnII Full R	847	RMI Harpsichord3
706	Vlns II Full R	764	Db/Va Div L	848	RMI Piano3
710	Violas Full L	765	Db/Va Div R	850	RMI Accenter
711	Violas Full R	766	Db/Vn Div L	851	RMI_accenter lo
715	Celli Full L	767	Db/Vn Div R	852	RMI_accenter hi
716	Celli Full R	768	Db div/VnI ful L	899	Sine Wave
720	Basses Full L	769	Db div/VnI ful R	909	Diagnostic Sine
721	Basses Full R	770	Db/Vc/Va/Vn DivL	999	Silence
725	Vlns Div2 L	771	Db/Vc/Va/Vn DivR		
726	Vlns Div2 R	772	Vc/Vn Div L		
730	Violas Div2 L	773	Vc/Vn Div R		
731	Violas Div2 R	774	Vc/Va/Vn Div L		
735	Celli Div2 L	775	Vc/Va/Vn Div R		
736	Celli Div2 R	776	Va/Vn Div L		
740	Basses Div2 L	777	Va/Vn Div R		
741	Basses Div2 R	800	CP80 Hard		
744	Db/Va Full L	801	CP80 Soft		
745	Db/Va Full R	802	CP80 Dual Strike		
746	Db/VnI Full L	810	Mellotron String		
747	Db/VnI Full R	815	Mellotron Choir		

Samples

ID	Sample	ID	Sample	ID	Sample
2	Stereo Pizz F#1	30	Stereo Trem D#3	90	FM E Piano
3	Stereo Pizz B1	31	Stereo Trem F3	95	Clav
4	Stereo Pizz D2	32	Stereo Trem G3	96	Clav Release
5	Stereo Pizz F2	33	Stereo Trem A#3	99	kHarpichord v
6	Stereo Pizz G#2	34	Stereo Trem C4	100	Harpichord v
7	Stereo Pizz A#2	35	Stereo Trem D#4	101	Harpichord Rel v
8	Stereo Pizz D3	36	Stereo Trem F#4	105	Celesta
9	Stereo Pizz F3	37	Stereo Trem A#4	107	Accordion
10	Stereo Pizz G#3	38	Stereo Trem C#5	110	Hammond 1st 3
11	Stereo Pizz B3	39	Stereo Trem E5	111	Hammond B3 Full
12	Stereo Pizz C#4	40	Stereo Trem G#5	112	Hammond KeyClick
13	Stereo Pizz E4	41	Stereo Trem C#6	113	Hammond 1st 3b
14	Stereo Pizz G4	42	Stereo Trem E6	114	kTone Wheel Orga
15	Stereo Pizz A#4	43	Stereo Trem A6	115	Trumpets
16	Stereo Pizz C#5	44	Stereo Trem C7	116	Trombets 2
17	Stereo Pizz E5	50	Left Piano f	118	Trombones
18	Stereo Pizz G#5	51	Right Piano f	119	alt Trombones
19	Stereo Pizz C6	52	Left Piano mf	121	Tenor Saxes
20	Stereo Pizz E6	53	Right Piano mf	122	Tenor Saxes fast
21	Stereo Pizz G#6	54	Left Piano mp	124	Bari Sax
22	Stereo Pizz C7	55	Right Piano mp	125	Bari Sax 2
23	Stereo Trem F1	56	Left Piano f jk	126	Trombones
24	Stereo Trem A1	57	Right Piano f jk	127	Trombones jk alt
25	Stereo Trem C#2	70	Rhodes	128	Tenor Saxes med
26	Stereo Trem D#2	72	Rhodes Thump	130	St Strings g1
27	Stereo Trem F#2	80	Wurlitzer	131	St Strings c2
28	Stereo Trem A#2	83	Wurlitzer Thump	132	St Strings gs2
29	Stereo Trem C#3	84	Wurli Key Rel	133	St Strings e3

PC3K Objects (V 2)

Samples

ID	Sample	ID	Sample	ID	Sample
134	St Strings gs3	186	Distorted Guitar	264	on246
135	St Strings e4	187	kDistorted Guita	265	one23
136	St Strings gs4	190	E Bass Fing New	266	one24
137	St Strings cs5	193	E BassFng e2 alt	267	one2
138	St Strings f5	194	E BassFng e2 al2	268	one35
139	St Strings d6	196	E Bass Blk B	269	one3
140	St Strings c7	199	E Bass Slap BlkB	270	onep4
141	Left Strings	200	syn Fretless	271	onep6
142	Right Strings	201	Tenor Saxes RVRs	272	onep8
149	Take 6 Bopa	202	Acoustic Bass mr	273	onp12
150	Take6 Aah Attk	203	AcoustBassAltDcy	274	prime
151	Take6 Aah Loop	204	Maracas Down	275	saw
152	Take 6 Bop	205	Take 6 Bopa	276	sawd
153	Take 6 Doop	206	kE Bass Slap Blk	277	sawsd
154	Take 6 Dot	210	Marimba	278	sawvd
155	Take6 Ooh Attk	211	Vibes	279	sine
156	Take6 Ooh Loop	218	celeste hi root	280	sq
157	Take 6 B(op)	250	b3ds	281	sqsd
158	Take 6 D(oop)	251	b3ful	282	sxt21
159	Take 6 (D)ot	252	b3st3	283	third
160	Take6 Aah LoopHI	253	b3st4	284	thn20
161	Take6 Aah Loop a	254	b3sw	285	thre4
162	Take6 Ooh Loop a	255	buzz	286	thre5
163	Take 6 Doop a	256	dw15	287	tri
165	Take 6 Dot a	257	dw6	288	two4
173	Syn Vox	258	e10	298	kEDrum1 Kick
175	Koreana	259	e12	299	kEDrum1 Snare
177	Hybrid Pan	260	eln15	300	LUD223
179	StlStrGtrHiDecay	261	five7	301	Mykik2
180	Steel String Gtr	262	for7	302	Sonkik
183	Clean Elec Gtr	263	fv11o	303	Sonkik alt

PC3K Objects (V 2)

Samples

ID	Sample	ID	Sample	ID	Sample
304	YAMkik2	335	Yam124 alt	366	Bongo Lo env3
305	BD2	336	Yam182 alt	367	Bongo Lo env4
306	BD123	337	Closed Hat Alt	368	Bongo Slap
307	BD51	338	Closed Hat	369	Bongo Slap env1
308	E2kik2	339	Slightly Opn Alt	370	Bongo Slap env2
309	LUDdryM	340	Slightly Opn Hat	371	Bongo Slap env3
310	LUDdryH	341	Open Hat	372	Cajon Hit
311	Eamesm	342	Open/Cls Hat	373	Cajon Mute
312	Eamesh	343	Foot Hat	374	Clap
313	PrldryM	344	Crash Cymbal 2	375	Clap env1
314	PrlambH	345	Crash Cymbal alt	376	Clap env2
315	EAMwoodH	346	Ride Rim3	377	Clap env3
316	kEDrum2 Kick2	347	RideBell	378	Clave
317	LUDambM	348	Agogo Hi	379	Clave env1
318	LUDambM alt	349	Agogo Hi env1	380	Clave env2
319	LUDambH	350	Agogo Hi env2	381	Clave env3
320	LUDambH alt	351	Agogo Hi env3	382	Conga Open Tone
321	YAMamb	352	Agogo Hi env4	383	Conga Open env1
322	YAMamb alt	353	Agogo Lo	384	Conga Open env2
323	Snare55	354	Agogo Lo env1	385	Conga Open env3
324	Snare58	355	Agogo Lo env2	386	Tumba Open Tone
325	Snare87	356	Agogo Lo env3	387	Tumba Open env1
326	Snare89	357	Agogo Lo env4	388	Tumba Open env2
327	e2snr	358	Bongo Hi Tone	389	Tumba Open env3
328	e2snr3	359	Bongo Hi env1	390	Conga Slap
329	Cross Stick	360	Bongo Hi env2	391	Conga Slap env1
330	Cross Stick alt	361	Bongo Hi env3	392	Conga Slap env2
331	Yam102	362	Bongo Hi env4	393	Conga ClosedSlap
332	Yam124	363	Bongo Lo Tone	394	Conga ClSlp env1
333	Yam182	364	Bongo Lo env1	395	Conga ClSlp env2
334	Yam102 alt	365	Bongo Lo env2	396	Tumba Flat Hand

PC3K Objects (V 2)

Samples

ID	Sample	ID	Sample	ID	Sample
397	Tumba Flat env1	428	Timbale Shell	459	PrldryM rev
398	Tumba Flat env2	429	TimbaleShellEnv1	460	PrlambH rev
399	Tumba Flat env3	430	Triangle Open	461	LUDambH rev
400	Cow Bell	431	TriangleOpenEnv1	462	YAMamb rev
401	Cow Bell env1	432	TriangleOpenEnv2	463	Yam102 rev
402	Cow Bell env2	433	TriangleOpenEnv3	464	Yam124 rev
403	Finger Snap	434	Triangle Mute	465	Yam182 rev
404	Finger Snap env1	435	TriangleMuteEnv1	466	Closed Hat rev
405	Finger Snap env2	436	Splash Cymbal	467	Open Hat rev
406	Finger Snap env3	437	Shakers Down nl	468	Crash rev
407	Maracas Down	438	Shakers Up nl	469	Snare55 rev
408	Maracas Dwn env1	439	Maracas Up ja	470	e2snr rev
409	Maracas Up	440	Maracas Up e1 ja	471	e2snr3 rev
410	Maracas Up env1	441	Maracas Down ja	472	slap snare
411	Shakers Down	442	Maracas Dwn e1ja	473	tonal snare
412	Shakers Up	443	Clap no flam	474	new sidestick
413	Tamb Down	444	Maracas Down sa1	475	CoughKick
414	Tamb Down env1	445	Maracas Up sa1	476	pan
415	Tamb Up	446	Shakers Down sa1	477	Open/ClsHtIGNREL
416	Tamb Up env1	447	Shakers Up sa1	478	globlah2
417	Tamb Hit	448	Tamb Up env1 sa1	479	mutated kick
418	Tamb Hit env1	449	Tamb Dwn en1 sa1	480	mutated kick 2
419	Tamb Hit env2	450	Tamb Hit sa1	481	warp drop
420	Timbale Hi mf	451	Cross Stck altAR	482	OpnHat scrape
421	Timbale Lo mf	452	Crash Cymbal AR	483	sine2
422	Timbale Hi ff	453	Sonkik rev	484	kTumba Open env1
423	Timbale Lo ff	454	YAMkik2 rev	485	mini sweep 2
424	TimbaleH mf env1	455	BD123 rev	486	kConga ClosedSla
425	TimbaleH ff env1	456	E2kik2 rev	487	kConga Slap
426	TimbaleL mf env1	457	Eamesm rev	488	kick bottom 2
427	TimbaleL ff env1	458	Eamesh rev	489	Gong

PC3K Objects (V 2)

Samples

ID	Sample	ID	Sample	ID	Sample
490	stoneloop	521	Clave env2b jk	552	kSleigh Bells
491	pulsegrunge	522	Clave e1alt cstn	553	kTriangle (rel)
492	zipyipe	523	Maracas Dwn env1	554	kChimes
493	bentblade	524	Cross Stick gt1	555	kCelesta
494	vaculunt	525	Maracas Down gt1	556	kXylophone
495	auto maraca	526	Tumba Open igf a	557	kHarp
496	errietamb	527	LegatoTenorSax	558	kAcoustic Bass
497	distachime	528	kConga Open Tone	559	kChurch Bell
498	popshayknroll	529	kBongo Slap	560	kTemple Block
499	Lazercork2	530	Open/Cls Hat R	561	kGuero
500	Conga Open ToneA	531	TriangleOpnRls	562	kBelltree
501	Agogo Hi env2A	532	MelTom alt	563	kOrchestra Hit
502	TimbaleHmfenv1 j	533	GM CrashCym 2	564	kFret Noise
503	Tumba Open j	534	GMkik1	565	kTelephone
504	Clave env1 a1	535	GM Crash rev	566	kGlock rel alt
505	Conga ClsdSlp J1	536	GM ELEC KiK	567	kXylo rel alt
506	TimbaleL mf jk1	537	kBongo Lo Tone	568	kTamb Hit
507	Tumba Open env4	538	kBongo Hi Tone	569	kMaracas
508	Conga Open env4	539	kTriangle Mute	577	Bari Sax 2
509	Shakers Dwn rvs	540	kAgogo Lo	578	TrombonesMod
510	Conga Open igoff	541	kAgogo Hi	600	Flute
511	Tumba Open igoff	542	kEDrum2 HH Close	601	Oboe
512	Shakers Downsa1j	543	kEDrum2 HH Open	602	English Horn
513	Shakers Up j	544	kSnare Hit	603	Bassoon
514	Agogo Hi gong	545	kSnare Roll	604	Dbl Reeds
515	Agogo Lo gong	546	kTimpani	605	Clarinet
516	Cow Bell gong	547	kTriangle	606	French Horn
517	Crash Cym rva jk	548	kTamb Hit	607	French Hrn Sec
518	Shakers Up jk2	549	kTamb Roll	608	Baritone Horn
519	Shakers Down j1	550	kCastanet Hit	609	Trumpet/Trombone
520	Shakers Up j3	551	kCastanet Up	610	Soft Trumpet

PC3K Objects (V 2)

Samples

ID	Sample	ID	Sample	ID	Sample
611	Harmon Mute Trp	650	Temple Block 2	687	Whistle
613	Tuba	651	Temple Block 3	688	Chinese Cymbal
614	Harp	652	Temple Block 4	689	Brush Snare Hit1
615	Harp Arpeggios	653	Church Bell	690	Brush Snare Hit2
618	Nylon String Gtr	654	kVibraslap	691	Brush Stir Short
620	Glockenspiel	655	Solo Violin	692	Brush Stir Long
621	K250 Choir	656	Solo Viola	693	808 Cowbell
623	K250 Pipe Organs	657	Solo Cello	694	808 Kick
624	Chimes	658	Fast Solo Cello	695	808 Snare
625	Xylophone	659	Solo Double Bass	696	909 Clap
626	Timpani	660	Pizz Strngs Left	697	909 Closed Hat
627	Orch Bass Drum	661	Pizz Strngs Right	698	909 Open Hat
628	kGlockenspiel	666	Trem Strngs Left	699	GM Applause
629	Orch Crash	667	Trem Strngs Right	700	Fret Noise
630	Orch Crash jk1	670	kChiff	701	GM Bird
631	Stereo Tam Tam	671	Bagpipe	702	Gunshot
632	Tam Tam Left	672	Bottle	703	Ice Rain
633	Tam Tam Right	673	Chiff	704	Syn Drum
635	Triangle	674	Harm Pick	705	Telephone
636	Dark Triangle	675	Harm Wave	706	Sine PC2ROM1
638	Triangle (rel)	676	GM Jazz Gtr	707	Metrobell
639	Tambourine Roll	677	GM Clean Strat	708	kEDrum2 Clap
640	Tambhit	678	Strat Mutes	709	kWoodblock
641	Snare Roll	679	Koto	710	Woodblock short
642	Snare Hit	680	Mbira	711	GM 808 Kick
643	Woodblock	681	Orchestra Hit	712	Vibraslap GM
644	Sleigh Bells	682	Belltree	713	GM Hi Guiro
646	Castanet Hit	683	Cuica Hi	714	GM Guiro
647	Castanet Up	684	Filtersnap	715	Cuica Hi alt
648	Vibraslap	685	Guiro	716	Cuica Lo alt
649	Temple Block 1	686	Scratch	717	kEDrum2 Snare1

PC3K Objects (V 2)

Samples

ID	Sample	ID	Sample	ID	Sample
718	Belltree alt	761	Violas Full R	850	RMI Accenter
719	FS 808 Tom	765	Celli Full L	851	RMI_accenter lo
720	GM ChinCym	766	Celli Full R	852	RMI_accenter hi
721	GM Shrt Whistle	770	Basses Full L	899	Sine Wave
722	Orch Crash jk1	771	Basses Full R	900	Trombones jk alt
723	Orch Crash a2	775	Vlins Div2 L	901	Cross Stick gt1
724	Tambourine Roll	776	Vlins Div2 R	902	Maracas Down gt1
725	Orch Bass Drum a	780	Violas Div2 L	904	sine no demph
726	kOrch Crash jk1	781	Violas Div2 R	950	Tenor Saxes med
727	Snare Hit s1	785	Celli Div2 L	998	sine no demph
728	Snare Roll	786	Celli Div2 R	999	silence
729	Tambhit	790	Basses Div2 L		
730	Sleigh Bells	791	Basses Div2 R		
731	Temple Block1ign	795	Split Ext Full L		
732	SoftTrp Pipes	796	Split Ext Full R		
733	Glockenspiel	797	Split Ext Div L		
734	Timpani	798	Split Ext Div R		
735	kEDrum1 Cowbell	799	Sine Wave		
736	kEDrum1 Kick	800	Left Piano f jk		
737	kBrush Stir Long	801	Right Piano f jk		
738	kBrush Stir Shor	802	CP80 E Grand		
739	kBrush Snare Hit	810	Mellotron Strings		
740	kBrush Snare Hit	815	Mellotron Choir		
741	kIce Rain	820	Mellotron Flute		
742	kFinger Snap	825	ARP String Ensemble		
743	kCuica	830	Clav II		
750	Vlins I Full L	834	Clav Key Release		
751	Vlins I Full R	835	Pianet		
755	Vlins II Full L	836	Fast Pianet		
756	Vlins II Full R	840	RMI Electra Piano		
760	Violas Full L	845	RMI Harpsichorda		

Arpeggiator Shift Patterns

ID	Shift Pattern	ID	Shift Pattern	ID	Shift Pattern
1	major	29	BacknForth	57	1To3
2	minor	30	1InvMin3	58	1To3b
3	Oct +	31	Root 5/3/5	59	Blues
4	Oct -	32	Root 5/m3/5	60	Blade
5	Oct 2x	33	Root 6/4/6	61	Repeat w/ Rests1
6	1's n 12's	34	bluesy1	62	Repeat w/ Rests2
7	FullMajor	35	bluesy2	63	Repeat w/ Rests3
8	FullMinor	36	bluesy3	64	Bass 1
9	Major7	37	bluesy4	65	Imminence
10	Minor7	38	rashi1	66	Imminence2
11	MajorMaj7	39	rashi2	67	Minor1
12	Sus2	40	rashi3	68	Minor2
13	Sus4	41	rashi4	69	Minor3
14	FullSpanish	42	petals1	70	3 Note Drum Arp
15	Dim	43	petals2	71	one five
16	Dim7d	44	petals3	72	mysterious1
17	Dim7m	45	Urger1	73	mysterious2
18	PentaA	46	Urger2	74	mysterious3
19	PentaB	47	Urger3	75	percolator1
20	PentaC	48	Urger4	76	percolator2
21	Maj Arp Oct	49	Hala1	77	percolator3
22	Root 5 Oct 5	50	Satch	78	percolator4
23	Root 5/4/5	51	Satch2	79	sparser 1
24	1st Inv M	52	Cascade	80	sparser 2
25	1st Inv M2	53	TripletCascade	81	boomboomwack
26	1st Inv m	54	Buzzer	82	boomboomquick
27	2nd Inv M	55	Angus	83	here comes da
28	2nd Inv m	56	BouncingZero	84	here comes da2

PC3K Objects (V 2)Arpeggiator Shift Patterns

ID	Shift Pattern	ID	Shift Pattern
85	here comes da3	200	as 1
86	moving 1		
87	moving 2		
88	moving 3		
89	where's one?		
90	where's one? 2		
91	happy one		
92	happy one 2		
93	crafty 1		
94	crafty 3		
95	crafty 4		
96	crafty 5		
97	can do 1		
98	can do 3		
99	chromo up 1		
100	Rising Minor		
101	Minor 7 Pattern		
102	Oct 5th up down		
120	Major 1A		
121	Major 1B		
122	Major 1C		
123	Minor 1A		
124	Minor 1B		
125	Minor 1C		
126	48StepTemplate		
127	24StepTemplate		
128	16StepTemplate		
129	8StepTemplate		
130	OctaveRhythm1		
131	Minor Var 1		
132	Drum Beat 1		

Arpeggiator Velocity Patterns

ID	Velocity Pattern	ID	Velocity Pattern	ID	Velocity Pattern
1	PseudoSine	30	pat12C	86	echo 3
2	LoHi	31	pat12D	87	echo 4
3	HiLoLo	32	pat24A	88	echo 5
4	HiLoLoLo	33	pat24B	89	echo 6
5	HiLoLoHiLoHi	34	pat24C	90	echo 7
6	6-pattern	35	pat24D	91	echo 8
7	12-patternA	36	LoHi2	92	echo 9
8	12-patternB	37	trip1	93	echo 10
9	X0	50	1/4 note triplet	94	echo 11
10	0X	51	16ths Pattern 1	95	echo 12
11	X00	52	16 Note Pattern2	96	echo 13
12	XX0	53	Rhythm 1	97	echo 14
13	X000	54	Rhythm 2	98	echo 15
14	XX00	70	Bass 1	99	dub echo 1
15	XXX0	71	ARPKIK1	100	E. Bass Arp
16	X0000X	72	ARPSNR1	101	PercussionArp
17	X00X0X	73	ARPHAT1	120	8th HiHat 1
18	XX0X0X	74	Syn 1	121	8th Delay 1
19	XXXXX0	75	perco 1	122	8th Trip Delay 1
20	X000000X	76	perco 2	123	Syn 2
21	X0000X0X	77	rebound 1	124	48StepTemplate
22	XXXXXXXX0	78	rebound 2	125	24StepTemplate
23	0X00XX00	79	pulser 1	126	16StepTemplate
24	X000X0X0	80	pulser 2	127	8StepTemplate
25	XX00X0X0	81	pulser 3	128	Speed Up
26	XX00XXX0	82	pulser 4	200	Trancer1
27	XX0XXXX0	83	pulser 5	201	Trancer2
28	pat12A	84	echo 1	202	ElectroBass1
29	pat12B	85	echo 2	203	ElectroGtr1

PC3K Objects (V 2)

Arpeggiator Velocity Patterns

ID	Velocity Pattern
204	offbeats01
205	BalladBass1
206	One and Two
207	One and Two 2
208	One and Two 3
209	Offbeat 8ths
210	And one and

Appendix E

PC3K Legacy File Conversion

The PC3K can load objects from older Kurzweil K series products, as well as objects from the PC3. Loaded objects are converted to object types native to the PC3K (see below for object types that can be converted.) Some object parameters cannot be converted and must be adjusted by the user after conversion (see object types below for details.)



Note: Objects that use the K series ROM soundsset can be converted after installation of the optional K2661 ROM compatibility file (available as a free download from www.kurzweil.com by going to the Downloads section, then clicking on the PC3K link.) For loaded keymap objects, keyranges that use **edited** ROM samples will NOT produce sound.

Only legacy objects ending with the file extension .K26, .K25, .KRZ or .PC3 can be loaded and converted.

Object Types and Conversion Details

Soundblock (Sample Objects)

All K series RAM sample objects can be loaded (see note above for details on ROM sample compatibility). The PC3K is unable to convert the sample skipping parameter (SmpSkp,) so samples converted for use in the PC3K can only be transposed upward by one octave.

Keymap Objects

All K series Keymap objects can be loaded, all parameters will be used or converted to PC3K specific parameters.

Program Objects

Most K series Program objects can be loaded, but FX are not converted and must be set by the user. A reverb effect is set by default for converted Programs. Some DSP ALGS and DSP objects (some filters, oscillators, etc.) can not be converted, so the user may have to adjust some Program layers to new ALGs or DSP objects. Program objects that use the K series ROM soundsset can be converted after installation of the optional K2661 ROM compatibility file (available as a free download from www.kurzweil.com.) All PC3 Program objects can be loaded. KB3 programs created with a K2500 or K2600 cannot be loaded to the PC3K, however the PC3K contains a variety of KB3 programs which can easily be modified and edited. Also, Triple Mode programs created with the K26 series cannot be loaded to the PC3K, however PC3K programs can use Cascade Mode. Cascade Mode allows a program signal to be routed through up to 32 layers of DSP algorithms (see *Alt Input for Algorithms (Cascade Mode)* on page 6-27 for details.)

Setup Objects

All K series Setup objects can be loaded, but FX are not converted and the Program effects are used by default. Also, any controller settings for a fourth switch pedal will not be converted (because the PC3K only has three switch pedals.) All PC3 Setup objects can be loaded.

PC3K Legacy File Conversion

Object Types and Conversion Details

Index

Numerics

50% Weight 9-24

A

A/Dry->B parameter 9-12
A->B cfg parameter 9-12
About 11-18
Adding layers 6-52
additional sounds 1-5
Adjust parameter (EnvCtl) 6-46
Adjusting sample volumes 14-4
AIF
 Automatic Preview in a Program 11-19
 Loading Tutorial 13-16
Algorithms D-21
 Editing 6-28
Aliaser effect 9-19
All Controllers Off 10-6
All Notes Off 10-6
Alpha Wheel 3-9
Alphabetic entry 3-9, 5-3
Alphanumeric pad 3-9
Alt Input for Algorithms 6-27
Alternative Attack parameter (Keymap) Parameters 6-16
Alternative Start
 Sample Editor 14-12
AMPENV page (Program Editor) 6-42
Amplitude envelope
 Decay segment 6-43
 Natural 6-42
 User 6-42
Amplitude envelope parameters 6-43-6-44
Amplitude envelopes 6-42
Analog output settings
 In Setup Mode 7-6
 In Song Mode 12-12
Arp Active 7-43
Arp button 3-5
Arpeggiator
 Active 7-43
 Beats 7-43
 Duration 7-44
 Glissando 7-50
 Latch 7-49
 Limit 7-46
 Limit Option 7-46
 Low Key (LoKey) and High Key (HiKey) 7-50
 Order 7-43
 Shift 7-46
 shifting notes 7-46
 Velocity 7-44
ASCII characters 5-3
ASR page (Program Editor) 6-40
ASR parameters 6-40-6-41
Assign sample 14-6

Assigning samples to keymaps 14-3
Atk Rate 9-20
Atk Time 9-16
Attack 9-17
Attack parameter (ASR) 6-41
Attack Portamento parameter (Common) 6-36
Attack Time and Level parameters (AmpEnv) 6-43
Audio cables 2-2
Audio File Loading Tutorial 13-16
AutoPan 9-24

B

Bank Buttons 3-2
Bank Select
 MIDI Receive page 10-9
Banks 3-2
Basic editing 5-1
Basic MIDI channel 10-6
Bass Freq 9-15
Bass Gain 9-15
Battery 1-4
Boot Loader 1-4
Bootloader B-1
Bottom line of display 3-6
Bounce
 Song Mode TRACK Page 12-25
Brake 9-23
Breath 2-4
breath 1-5
Brightness 2-5
Build 9-13
Building a keymap 14-7
Buttons
 Panic 6-2
Bypass effects 5-7

C

Cab Bypass 9-21
Cab Preset 9-21
Cabinet HP 9-21
Cabinet LP 9-21
Cabinet simulations 9-21
Carrier
 ring modulation 9-25
Cascade Mode 1-3, 6-1, 6-27
Category buttons 3-4
CenterGain 9-25
CentrAtten 9-24
Chain Info
 Export 13-15
Chains
 effect D-15
Chan/Layer buttons 3-7, 5-7
Change
 Song Mode TRACK Page 12-30
Changing intonation key 11-9
Channel/Program (CH/PROG) Page 7-4
Channels on and off 10-14
Characters 5-3

- Chorus 9-18
- Clicking during portamento 6-36, 6-37
- Clock 11-17
 - setting 2-7
 - Source 11-11
- COMMON Page
 - Song Mode 12-19
- Common parameters 6-35–6-60
- Compare 5-7
- Compatibility
 - K Series Objects E-1
- Complex Echo 9-14
- Compressors 9-16
- Configuring control sources 6-9
- Connecting MIDI 2-3
- continuous pedals 1-5
- Contour 9-20
- Contrast 2-5
- Control Setup 6-9
- Control sources
 - Configuring 6-9
 - FUNs 6-41
 - Key tracking 6-25
 - Source 1 and Source 2 6-25
 - Velocity tracking 6-25
- Controllers
 - saving settings in Program Mode 6-3
- Controlling LFO rate 6-39
- conventions for editing objects 5-1
- Copy
 - Song Editor TRACK Page 12-24
- Copying layers 6-52
- Creating layers 6-52
- Cross Couple parameter 9-12
- Crossfade parameter (Output) 6-33
- Crossfade Sense parameter (Output) 6-33
- Crossover 9-22
- Crossover1 9-17, 9-26
- Crossover2 9-17
- Cursor buttons 3-7
- Curve 9-22

D

- Data entry 3-9
- DC Offset 9-19
- Decay segment 6-43
- Decay Time and Level parameters (AmpEnv) 6-43
- DegenRegen delay 9-15
- Delay 9-26
- Delay parameter (ASR) 6-40
- Delays 9-14
- DelayScale 9-14
- Delete
 - on Object Utilities page 11-14
- Delete Layer soft button 6-52
- Delete soft button 6-52
- Deleting layers 6-52
- Deleting objects 5-6
- Deleting programs 6-52
- Demo Songs 15-15

- Density 9-13
- Depth 9-24
- Destination
 - MIDI Transmit Page 10-2
- Dialogs
 - Save 5-3
- diamond icon 5-4
- Diff Amt 9-14
- Diff Gain 9-25
- Diff Scale 9-13
- DiffBassF 9-26
- DiffBassG 9-26
- Digital audio output 2-3
- Digital Output Mode 11-10
- Digital Output Volume 11-10
- Directories 13-4
- Disk Mode 5-6, 13-1
- Disk mode 4-3
- Display 3-6
- Dist Drive 9-21
- Distortion 9-21
- Dly Coarse 9-19
- Dly Fine 9-19
- DlyCrs 9-19
- DlyFi 9-19
- Double button presses 3-10
- DRAWBR page (Program Editor) 6-61
- Drive 9-16
- Drum Remap 6-33, 11-2
- Drum Tracks
 - Song mode 12-20
- Dry Bal 9-14
- Ducking 9-17
- Duplicate Layer soft button 6-52
- Duplicating layers 6-52
- Dynamic VAST 1-3, 6-1, 6-28
- DynamRange 9-19

E

- EarRef Lvl 9-13
- Easy Audition 2-7
- EDIT button 3-8
- Edit button 5-7
- Edit compare 5-7
- Edit Song
 - COMMON Page 12-19
 - EVENT Page 12-31
- Editing 5-1
- Editing Algorithms 6-28
- editing conventions 5-1
- Editing KB3 programs 6-59
- Editing Samples 14-9
- Editing VAST programs 6-12
- EditProg Exit page 5-3
- EditProg Save page 5-3
- Effect Algorithms D-21
- Effect Chains D-15
- Effect Presets D-21
- Effect-box
 - Parameters 9-12

- Effects
 - Parameters 9-12
- Effects button 5-7
- Effects bypass 5-7
- Effects mode 4-3
- Effects Parameters 9-12
- Electrical grounding 2-2
- Enable MIDI channels 10-14
- Enable parameter (Layer) 6-19
- Enable Sense parameter (Layer) 6-19
- Enhancers 9-16
- Env Rate 9-21
- Env Time 9-18
- ENV2 and ENV3 pages (Program Editor) 6-44
- ENVCTL page (Program Editor) 6-45
- Envelope control 6-45
- Envelope control parameters 6-46
- Envelope Filter 9-20
- Envelopes 6-42, 6-44
- EQ Morpher 9-16
- EQ page (Program Editor) 6-69
- EQs 9-15
- Equalizers 9-15
- Erase
 - Song Mode TRACK Page 12-24
- EVENT Page
 - Song Mode 12-31
- Everything
 - loading objects as 13-12
- EXIT button 3-8
- Exit values 7-30
- Exp Atk 9-17
- Exp Ratio 9-17
- Exp Rel 9-17
- Exp Threshold 9-17
- Expander 9-16
- Expanse 9-13
- Expansion 9-17
- Export
 - MIDI file, Program Info, Chain Info 13-15
- Extended sample loop 14-11
- External sequencer 12-2
- External Tempo Source 7-65

F

- favorite programs
 - Category buttons 3-4
- FB2/FB1>FB 9-14
- Fdbk Dly 9-14
- Fdbk Image 9-15
- Fdbk Level 9-14, 9-18
- FdbkComprs 9-16
- Files
 - Everything 13-7
 - Loading 5-6
 - Master 13-7
 - Saving 5-6
- Fill Mode 13-11
- Filter Type 9-20
- Filters 9-20

- Finding objects 3-12
- Fine adjust 6-25
- Flanger 9-19
- Formatting a USB Device 13-2, 13-15
- Freeze Pedal parameter (Layer) 6-20
- FreqScale 9-16
- Front panel navigation 3-6
- FUN page (Program Editor) 6-41
- Function soft buttons 6-51
- fuses C-1
- FX bypass 5-7
- FX Mode on Master Mode MAIN page 11-2

G

- Gate Time 9-17
- Gated Ducking Delay 9-15
- Gates 9-16
- General MIDI 11-12
 - Drum Remap 6-33, 11-2
- Globals parameter (Common Page) 6-37
- Globals parameter (Common) 6-60
- Grab
 - Song Mode TRACK Page 12-29
- Graphic equalizer 9-15
- Grounding 2-2

H

- Half Wts 9-25
- Hard reset 11-18
- Headroom 9-19
- HF Damping parameter 9-12
- Hi Beam W 9-22
- Hi Fast 9-23
- Hi Gain 9-22
- Hi Res Delay 9-22
- Hi Size 9-22
- Hi Slow 9-23
- Hi Trem 9-22
- HiAccelCrv 9-23
- HiFst>Slow 9-23
- High Key parameter (Layer) 6-18
- High Velocity parameter (Layer) 6-18
- Highpass 9-21
- HiMic A 9-22
- HiMic B 9-22
- HiResonate 9-22
- HiResXcurs 9-23
- HiSlow>Fst 9-23
- HiSpinDir 9-23
- Hold 9-14
- Hold Through Attack parameter (Layer) 6-21
- Hold Until Decay parameter (Layer) 6-21

I

- ID Entry
 - Master mode MAIN page 11-2
- ID#s 15-6
- Ignore release 6-20

- ImageWidth 9-24
- Impact parameter (EnvCtl) 6-47
- Import Layer soft button 6-52
- Importing layers 6-52
- In Select 9-25
- In/Out parameter 9-12
- InfinDecay 9-13
- Info
 - Export 13-15
- INFO Editor 6-51, 6-52
- INFO soft button
 - Program Editor 6-51, 6-52
- Info soft button 2-8, 6-2, 8-2
- Insert
 - Song Mode TRACK Page 12-26
- Intonation key 11-9
- Intonation tables 11-8
- Introduction to editing 5-1
- Intuitive data entry 3-11

K

- K series object conversion E-1
- K2600
 - bank mode 7-7
- KB3 1-3, 2-9, 6-4, 6-6, 6-59
 - Polyphony 6-60
- KB3 channel 6-6
- KB3 programs 2-9, 6-6
- Key range 14-3
- Key tracking 6-25
- Key tracking parameter (EnvCtl) 6-46
- Key Tracking parameter (Keymap) 6-14
- Key/Velocity (KEY/VEL) Page 7-9
- Keyboard naming 5-5
- KEYCLK page (Program Editor) 6-65
- Keymap 14-7
- Keymap Editor 14-1
 - Assign sample 14-6
 - New range 14-5
- Keymap Editor Parameters 14-3
- KEYMAP page (Program Editor) 6-14
- Keymap parameter (Keymap) 6-14
- Keymap parameters 6-14
- Keymaps 6-4
- Keymaps, stereo 6-15
- KSP8 effects D-21
- KVA Oscillators 6-53

L

- L Diff Dly 9-14
- L/R Phase 9-18, 9-24
- L/R Pre Dly 9-13
- LaserVerb 9-19
- Late Lvl 9-13
- LateRvbTim 9-13
- Layer delay control 6-18
- LAYER page (Program Editor) 6-17
- Layer parameters 6-18–6-21
- Layers

- Adding 6-52
- Deleting 6-52
- Duplicating 6-52
- Importing 6-52
 - moving between in multi-layer programs 3-11
- Muting 5-7
- LCD 3-6
- Legacy object conversion E-1
- Legato play parameter (Common) 6-36
- Leslie effect 9-22
- LFO Dpth 9-18
- LFO Filter 9-21
- LFO LRPhs 9-18
- LFO page (Program Editor) 6-38
- LFO parameters 6-39
- LFO Phase 9-24
- LFO PlsWid 9-21, 9-24
- LFO Rate 9-18, 9-24
- LFO Shape 9-21, 9-24
- LFO Smooth 9-21
- LFOs 6-38, 6-40
- Line cord 2-2
- Lo Beam W 9-22
- Lo Fast 9-23
- Lo Gain 9-22
- Lo Mode 9-23
- Lo Res Dly 9-22
- Lo Size 9-22
- Lo Slow 9-23
- Lo Trem 9-22
- LoAccelCrv 9-23
- Loading Audio Files Tutorial 13-16
- Loading files 5-6
- Loading Individual Objects 13-10
- Lock parameters 10-15
- LoFst>Slow 9-23
- LoMic A 9-22
- LoMic B 9-22
- Loop Switch
 - Sample Editor 14-11
- Loop Type parameter (AmpEnv) 6-44
- Looping samples 6-16
- Loops 15-15
- LoResonate 9-22
- LoResXcurs 9-23
- LoSlow>Fst 9-23
- LoSpinDir 9-23
- Low Key parameter (Layer) 6-18
- Low Velocity parameter (Layer) 6-18
- LP Freq 9-22
- Lvl 9-22

M

- Main Page
 - Master Mode 11-1
- MakeUp Gain 9-17
- MakeUpGain 9-17
- Master button 5-7
- Master files 13-7
- Master mode 4-3

- Master Table 11-18
- Master Transpose 11-2
- Max Freq 9-20, 9-21
- Maximum delay parameter (Layer) 6-19
- Maximum Rate parameter (LFO) 6-39
- Memory objects 5-4
- metronome 15-4
 - count off options 15-5
- Mic Angle 9-23
- Mid Freq 9-15
- Mid Gain 9-15
- Mid Width 9-15
- MIDI
 - About MIDI 15-1
 - All Notes Off 10-6
 - Basic channel 10-6
 - Channel enable 10-14
 - Pan 10-15
 - Parameter locks 10-15
 - Program change formats 10-15
 - Receive mode 10-6
 - Reset channels 10-18
 - Transmit parameters 10-1
 - Utilities 11-16
 - Volume 10-15
- MIDI channel 10-2
- MIDI channel parameters 10-14
- MIDI connections 2-3
- MIDI disconnected 13-1
- MIDI file
 - export 13-15
 - Load 13-1
- MIDI Implementation Chart A-1
- MIDI Machine Control 12-7
- MIDI mode 4-3
 - Soft buttons 10-18
- MIDI program changes 10-5
- MIDI Receive page 10-9
- MIDI Receive parameters 10-5
- MIDI sequence Load, Save, Export 12-8
- MIDI Thru/Out switch 2-3
- MIDI Time Clock 12-2
- Min Freq 9-20, 9-21
- Minimum delay parameter (Layer) 6-19
- Minimum Rate parameter (LFO) 6-39
- MISC page (Program Editor) 6-67
- Miscellaneous (MISC) 14-9
- MMC 12-7
- Mod Mode 9-25
- Mod Wheel 3-5
- Mode buttons 3-2
- Mode parameter (ASR) 6-40
- Mode selection 3-1, 4-1
- Modes 4-1
 - Program 6-1
- Modes, using 4-2
- Modulator
 - ring modulation 9-25
- Momentary
 - switch type 7-31
- Mono sound systems 2-2

- Monophonic parameter (Common) 6-35
- Monophonic programs 6-35
- Monster Truck radio spots 9-15
- Morph A>B 9-16
- MPressure 7-20
- MTC 12-2
- Multiband Compression 9-17
- Multitap delays 9-14
- Multi-velocity keymaps 14-4
- Mute Effects Box 5-7
- MuteZn 7-24
- Muting layers 5-7
- Muting Setup zones 5-7

N

- Name soft button 6-52
- Naming 15-6
- Naming objects using the keyboard 5-5
- Natural amplitude envelope 6-42
- Navigation 3-6
- New Layer soft button 6-52
- Noise generator 6-16
- Non-harmonic overtones
 - creating with ring modulator 9-25
- Note triggering 6-18
- Number of loops parameter (AmpEnv) 6-44
- Numeric Entry
 - Master mode MAIN page 11-2
- Numeric entry 3-9

O

- Object type and ID 5-2
- Objects 5-1
 - Deleting 5-6
 - loading individually 13-10
 - Master Mode Delete 11-14
 - Master Mode Rename 11-14
 - Naming 5-3
 - RAM 5-2, 5-4
 - Renaming 5-3
 - ROM 5-2, 5-4
- Octav 6-2, 8-2
- Odd Wts 9-25
- Opaque parameter (Layer) 6-20
- Origin 9-24
- OS Version 11-18
- Osc1 Freq 9-25
- Osc1 Lvl 9-25
- Osc1 Shape 9-25
- Osc1PlsWid 9-25
- Osc1Smooth 9-25
- Oscillators 6-53
- Out Gain parameter 9-12
- OUTPUT page (Program Editor: KB3) 6-70
- Output settings
 - In Setup Mode 7-6
 - In Song Mode 12-12
- Overview 1-3

P

Pages 3-6

- AMP (KB3) 6-62
- AMPENV (Amplitude envelope) 6-42
- ASR (Attack, Sustain, Release) 6-40
- DRAWBR 6-61
- ENV2 and ENV3 (Envelopes) 6-44
- ENVCTL (Envelope control) 6-45
- EQ 6-69
- FUN (Attack, Sustain, Release) 6-41
- KEYCLK 6-65
- KEYMAP 6-14
- LAYER 6-17
- LFO 6-38
- MIDI CHANLS 10-14
- MIDI RECV 10-5
- MIDI XMIT 10-1
- MISC 6-67
- OUTPUT (KB3) 6-70
- PERC 6-63
- PERC2 6-64
- PITCH (KB3) 6-62
- TONEWL 6-59

Pair Wts 9-25

Pan 9-22, 9-26

- MIDI 10-15

Pan lock 10-15

Pan Mode parameter (Output) 6-32

Pan parameter (Output) 6-32

Pan Width 9-24

Panic button 2-8, 6-2, 10-18

Parameter locks 10-15

Parameters

- AmpEnv 6-43-6-44
- ASR 6-40-6-41
- Common 6-35-6-60
- Envelope control 6-46
- Keymap 6-14
- Layer 6-18-6-21
- LFO 6-39

Parametric equalizer 9-15

Path 13-4

PC3 Features 1-2

PC3 Overview 1-3

PC3K6 1-1

PC3K8 1-1

PCH 10-16

Pedals 2-4

pedals 1-5

PERC page (Program Editor: KB3) 6-62

PERC page (Program Editor) 6-63

PERC2 page (Program Editor) 6-64

Phase parameter (LFO) 6-39

Pitch 9-25

Pitch Bend Mode parameter (Layer) 6-18

Pitch Bend Range parameter (Common) 6-35

PITCH page (Program Editor: KB3) 6-62

Pitch Wheel 3-5

Play/Pause button

- with Easy Audition 2-7

Playback loops 6-16

Playback Mode parameter (Keymap) 6-16

Plus/Minus buttons 3-9

Polydistort 9-22

Polyphony 6-4, 11-16

- KB3 6-60

Portamento click 6-36, 6-37

Portamento parameter (Common) 6-36

Portamento Rate parameter (Common) 6-36

Pos 9-22

Power cable 2-2

Pre Dly 9-13

Pre-Delay 9-13

Pressure (Press) Page

- Setup Mode 7-35

Pressure Map

- Master 11-7
- MIDI Receive 10-8
- MIDI Transmit 10-4

Preview Sample (PRVIEW) 11-19

PrgChgMode 10-6

Program buttons 3-4, 5-7

Program change formats 10-15

Program change mode 10-6

Program changes

- Extended 10-16
- MIDI 10-5
- Quick Access mode 8-1

Program Editor

- AMP page (KB3) 6-62
- AMPENV page 6-42
- ASR page 6-40
- DRAWBR page 6-61
- ENV2 and ENV3 pages 6-44
- ENVCTL page 6-45
- EQ page 6-69
- FUN page 6-41
- KEYCLK page 6-65
- KEYMAP page 6-14
- LAYER page 6-17
- LFO page 6-38
- MISC page 6-67
- OUTPUT page (KB3) 6-70
- PERC page 6-63
- PERC2 page 6-64
- PITCH page (KB3) 6-62
- Soft buttons 6-12
- TONEWL page 6-59

Program Info

- Export 13-15

Program lock 10-15

Program mode 4-2, 6-1

- Soft buttons 6-2

Program mode page 6-1

Program output settings

- In Setup Mode 7-6

Programs D-1

- Adding layers 6-52
- Deleting 6-52
- Deleting layers 6-52
- Duplicating layers 6-52

- Editing (KB3) 6-59
- Editing (VAST) 6-12
- Importing layers 6-52
- KB3 2-9, 6-6
- Renaming 6-52
- Saving 6-52
- selecting 2-7
- VAST 2-8, 6-4

Ptch Offst 9-25
Pulse Width 9-21, 9-24
punching in 15-9
Punctuation 5-3

Q

Quantize

- Song Mode TRACK Page 12-27

Quantize + Flange 9-19
Quantizing 15-15
Quartr Wts 9-25
Quick Access bank program changes 10-16
Quick Access button 5-7
Quick Access Editor 8-1
Quick Access mode 2-9, 4-3

R

R Diff D1 9-14
RAM objects 5-2, 5-4
Rate Control parameter (LFO) 6-39
Rate Scale 9-24
Ratio 9-17
Real-time Control of Arpeggiator Parameters 7-53
Rear panel output settings

- In Setup Mode 7-6
- In Song Mode 12-12

Recording Overview 15-1
Recording songs 3-12
Region/Criteria window

- Song mode 12-21

Rel Rate 9-20, 9-21
Rel Time 9-16
Release 9-17
Release parameter (ASR) 6-41
Release Time and Level parameters (AmpEnv) 6-43
Releasing ASRs 6-40
Remap

- Song Mode TRACK Page 12-31

Rename 15-6
Renaming objects 5-3

- with Rename utility 11-14

Renaming programs 6-52
Repeating ASRs 6-40
Reset

- hard 11-18

Reset MIDI channels 10-18
ResH/LPhs 9-23
Resonance 9-20
Resonant Filter 9-20
Retrigger 9-18, 9-21
Reverb types 9-13

Reversing samples 6-16
Ribbon 2-5

- Playing note patterns 7-26

ribbon 1-5
Ribbon Configuration (RIBCFG) Page 7-40
RIBBON Page 7-40
Riffs 7-55
Ring Modulation 9-25
ROM objects 5-4
ROM objects, saving 5-2
Room Type 9-13
Root Key

- Sample Editor 14-10

Rotating Speakers 9-22
Roto InOut 9-22
Rvrb Time 9-13

S

Sample

- Automatic Preview in a Program 11-19

Sample Editor 14-7, 14-9
Samples

- Adjusting volume 14-4
- Assigning to keymaps 14-3
- Playback mode 6-16
- Tuning 14-4

Save dialog 5-3
Save soft button 6-52
Saving

- Naming 15-6
- Rename 15-6
- Song Mode 15-5

Saving and naming Objects

- Saving 5-3

Saving files 5-6
Saving Master and Everything Files 13-7
Saving objects

- RAM 5-4
- ROM 5-4

Saving programs 6-52
Saving RAM objects 5-2
Saving ROM objects 5-2
SC Input 9-17
Search function 3-12
Select soft button 13-14
Selecting modes 3-1, 4-1
Selecting parameters 3-6
Selecting programs and setups 2-7
Sequencer

- tutorial 12-1

sequencer 15-1
Set drawbars 6-62
Setup

- Compare Editor 7-3

Setup button 5-7
Setup Editor 7-3

- Delete Soft Button 7-68
- Delete Zone (DelZn) Soft Button 7-68
- Duplicate Zone (DupZn) Soft Button 7-68
- Import Zone (ImpZn) Soft Button 7-68

- Local Program (LocalPrg) 7-4
- Name Soft Button 7-68
- New Zone (NewZn) Soft Button 7-68
- Soft buttons 7-68
- Setup Mode
 - Pressure (Press) Page 7-35
 - Ribbon Configuration (RIBCFG) Page 7-40
 - RIBBON Page 7-40
 - WHEEL Page 7-32
- Setup mode 4-2, 7-1
- Setup Mode analog output settings 7-6
- Setups 2-9
 - Aux Bend 1 7-19
 - Aux Bend 2 7-19
 - BEND Page 7-18
 - Bend Range 7-18
 - COMMON Page 7-65
 - Continuous Control Pedal (CPEDAL) Page 7-34
 - Continuous Controller Parameters 7-29
 - Controllers 7-19
 - Curve (Curv) 7-29
 - Destination 7-5
 - Destination (Dest) 7-29
 - Entry (Ent) and Exit States 7-31
 - Entry Pan, Exit Pan 7-17
 - Entry values 7-30
 - Entry Volume, Exit Volume 7-17
 - Footswitch (FOOTSW) Page 7-36
 - Low and high key 7-10
 - Low Velocity (LoVel), HighVelocity (HiVel) 7-16
 - MIDI Bank 7-4, 7-5
 - MIDI Bank Mode 7-7
 - MIDI channel 7-5
 - MIDI Controller Destination List 7-21
 - Muting zones 5-7
 - Note Maps 7-10
 - Off Value 7-31
 - Offset (Add) 7-29
 - On Value 7-31
 - Pan/Volume (PAN/VOL) Page 7-17
 - physical controllers 7-20
 - RIBBON Page 7-39
 - Save Soft Button 7-68
 - Scale 7-29
 - selecting 2-7
 - SLIDER and SLID/2 Pages 7-33
 - Status 7-6
 - Switch controllers 7-30
 - SWITCH Page 7-37, 7-38
 - Switch Type (SwType) 7-31
 - Transpose 7-10
 - Transposing 7-1
 - Velocity Curve 7-14
 - Velocity Offset 7-12
 - Velocity Scale (VelScale) 7-11
 - Zone Arpeggiation 7-8
- Setups Object List D-13
- Shape parameter parameter (LFO) 6-39
- Shift
 - Song Mode TRACK Page 12-28
- Shift Key Number, Shift Key (ShKeyNum, ShiftKey) 7-26
- Shift Pattern (ShiftPatt) 7-47
- Shifting notes
 - in the Arpeggiator 7-46
- Signal Delay 9-17
- Signal Dly 9-16
- Signal-to-noise ratio 2-5
- Size Scale 9-13
- Sliders 3-3, 7-20
- Smooth 9-17
- Smooth Rate 9-20
- SmoothTime 9-16
- Smth Rate 9-21
- Soft buttons 3-7
 - Keymap Editor 14-5
 - MIDI mode 10-18
 - in Program Editor 6-12
 - in Program Mode 6-2
 - Sample Editor 14-11
 - Setup Editor 7-68
 - Special functions 6-51
- Software Upgrades 2-10
- Soloing a zone 7-3
- Song
 - Export 13-15
- Song button 5-7
- Song Editor 12-19
 - TRACK Page 12-21
- Song Mode 12-1, 15-1
 - Demo Songs 15-15
 - Loops 15-15
 - Program Changes 15-16
 - Song Structure 15-16
 - The Event List 15-16
- Song mode 4-3
- Songs
 - Recording 3-12
- Sostenuto Pedal parameter (Layer) 6-20
- sound ROM expansion option 1-5
- Source 1 6-25
- Source and Depth parameters (EnvCtl) 6-46
- Spacing 9-19
- Special button functions 5-7
- Special-function soft buttons 6-51
- Specifications A-2
- Spectral Multitap Delays 9-15
- Speed 9-23
- Start Point
 - Sample Editor 14-12
- Startup 2-1
- StatDlyLvl 9-19
- Stereo parameter (Keymap) 6-15
- Stereo simulation 9-25
- Sustain not working 10-6
- Sustain Pedal parameter (Layer) 6-20
- Sustaining ASRs 6-40
- SW button 3-5
- Sweep 9-20
- switch pedals 1-5
- Sync In 2-3
- System Exclusive ID 10-9

T

- Tap Dly 9-18
- Tap Lvl 9-18
- Tap Pan 9-18
- Tap Pitch 9-15
- Tap PtAmt 9-15
- Tap Shapr 9-15
- Tap Tempo 11-11, 15-3
- Tap types in Multitap delays 9-14
- Tapn Bal 9-14
- Tapn Level 9-14
- Tempo 15-3
 - Master 11-11
 - Song mode - Tempo Track 12-33
 - Tap Tempo 11-11
 - Tap Tempo function 15-3
- Threshold 9-17
- Thru/Out switch 2-3
- Timbre Shift parameter (Keymap) 6-16
- time signature 15-3
- Time Stamp 11-17
- Toggle
 - switch type 7-31
- TONEWL page (Program Editor) 6-59
- Top line of display 3-6
- Track output settings (Song Mode) 12-12
- TRACK Page
 - Song Editor 12-21
- Transpose
 - Master 11-2
 - MIDI 10-2
 - Song Mode TRACK Page 12-28
- Transpose parameter (Keymap) 6-14
- Transposing setups 7-1
- Treb Freq 9-15
- Treb Gain 9-15
- Tremolo 9-24
- Trig Filt 9-20
- Trig parameter (Layer) 6-18
- Trigger 9-20
- Trigger parameter (ASR) 6-40
- Triggered Filter 9-20
- Triggering notes on startup 6-18
- TRIM 14-12
- Tuning samples 14-4
- Tuning to other instruments 11-2

U

- USB Device
 - formatting 13-2, 13-15
- USB MIDI disconnected 13-1
- USB Port 2-6
- User amplitude envelope 6-42
- Using the modes 4-2

V

- VA-1 Programs 1-3
- Variable Architecture Synthesis 1-3

- VAST 1-3
- VAST program structure 6-4
- VAST programs 2-8, 6-4
- Velocity Map
 - MIDI Receive 10-7
 - MIDI Transmit 10-3
- Velocity Range 14-4
- Velocity tracking 6-25
- Velocity tracking parameter (EnvCtl) 6-46
- Velocity tracking parameter (Keymap) 6-15
- Vib/Chor 9-23
- VibChInOut 9-23
- Vibrato/Chorus 9-23
- virtual drive
 - USB Storage Mode 2-6
- Voice allocation 11-16
- Voice channels 6-4
- Voltage
 - changing C-1
- Voltage levels 2-2
- Volume
 - MIDI 10-15
- Volume lock 10-15

W

- Warmth 9-21
- WAV
 - Automatic Preview in a Program 11-19
 - Loading Tutorial 13-16
- Waveform display 14-12
- Wet Bal 9-13
- Wet/Dry 9-25
- Wet/Dry parameter 9-12
- WHEEL Page
 - Setup Mode 7-32

X

- XCouple parameter 9-12
- Xcrs Fin 9-19
- Xcurs Crs 9-19
- Xfer 9-16
- XMIT page 10-1
- Xover 9-22
- Xpose 2-8, 6-2, 8-2

Z

- Zero-crossings 14-13
- Zone output settings (Setup Mode) 7-6
- Zone status LEDs 7-2
- Zones
 - Soloing 7-3