

Mounting Instructions for SoundSphere Model 110B and Q-6 Loudspeakers

HK Hanging Kit

Hang Mounting from Above

The hanging kit is attached when ordered with the speaker from the factory. If ordered separately, attach as shown in figure 1:

- Hold the main hook above so the wires and 3 hooks will be straight as they are clipped on the speaker.
- Insert the spring clips into the bracket holes as shown. Attach the top clip to the mounting point making sure that the clips and cable are not twisted.

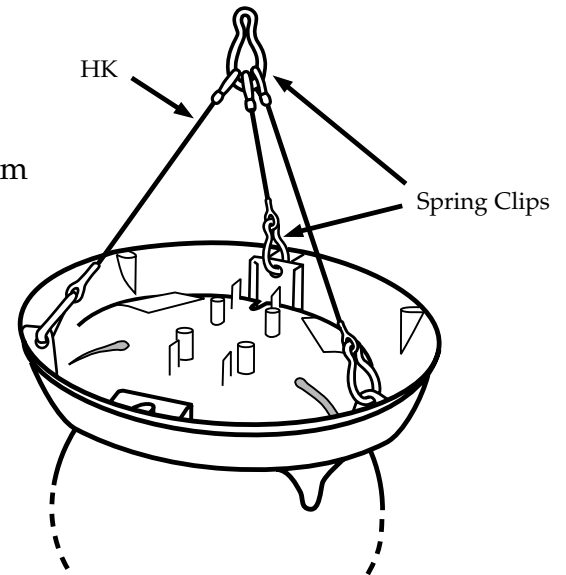

Figure 1

MBS Mounting Bracket

Preparing the Speaker

The speaker is prepared for use with the MBS mounting bracket when both are ordered together from the factory. If ordered separately, prepare the speaker as shown in figures 2 or 3, and 4.

- Begin by removing the plastic flashing from the hole in the reflector rim so that the screw can be inserted from the outside. Flashing can be removed with a $\frac{1}{4}$ " drill bit (figure 2), or it can easily be punched through using a hammer (figure 3). If using a $\frac{1}{4}$ " drill bit, be careful not to remove any material other than the flashing, or the speaker will not install correctly.

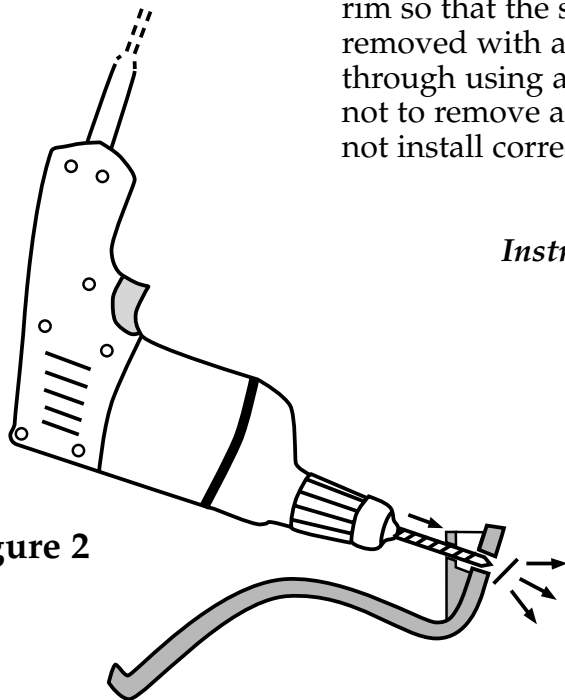

Figure 2

Instructions Continued – See Reverse Side

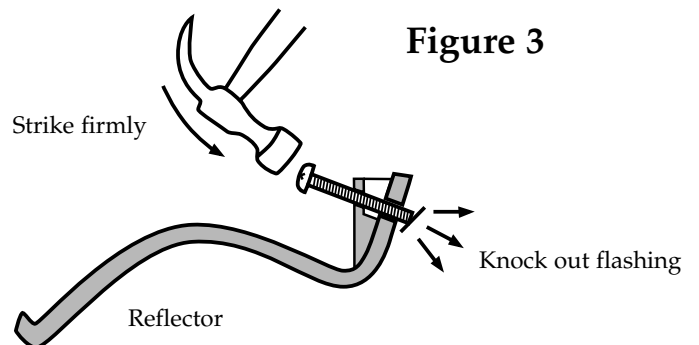

Figure 3

MBS Mounting Bracket (Continued from Front)

Preparing the Speaker

- b. Place the stop nut in the pocket as shown in figure 4. Start screw through outside hole, through stop nut contained in the pocket, and slightly beyond the interior hole (see figure 5).

Installing the Speaker (see Figures 6 & 7)

The steel bracket is pre-fastened to the ceiling or wall, then the speaker is placed on the bracket and secured in the following steps:

- a. Fasten the bracket in the desired location, making sure that it is properly and safely mounted.
- b. Slide the side of the reflector opposite the screw over one end of the installed bracket.
- c. While holding the screw side against the surface, tighten the screw until the speaker is resting firmly in position.

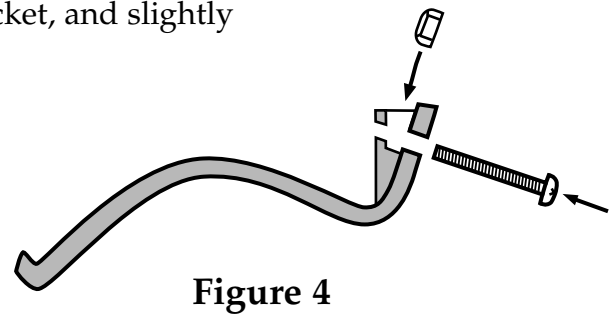

Figure 4

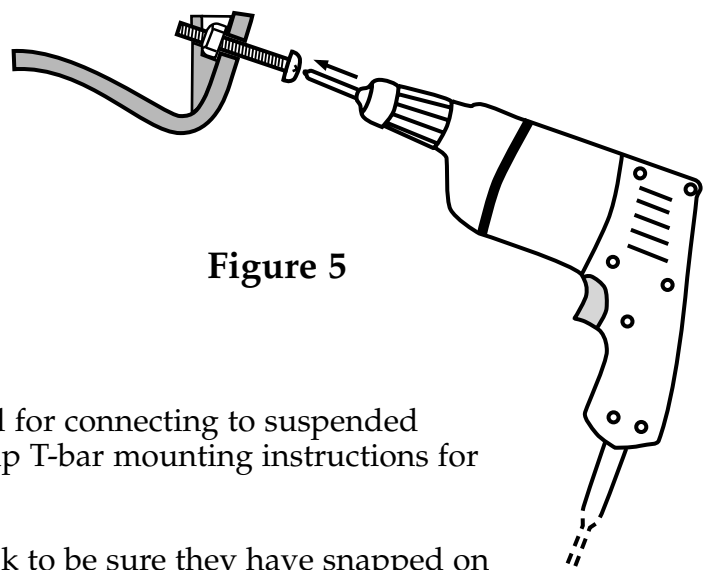

Figure 5

Suspended Ceiling T-bar Mounting (see Figure 6)

Two Caddy Twist Clips and Twist Nuts are provided for connecting to suspended ceiling T-bars. Please refer to the enclosed Caddy Clip T-bar mounting instructions for more details.

- a. Place the clips about $8\frac{3}{4}$ " apart on the T-bar. Check to be sure they have snapped on the bar correctly.
- b. Slide them into final position to fit through the holes in the mounting bracket. Tighten the thumb nuts securely.
- c. Secure the speaker per steps b and c (above), "Installing the Speaker".

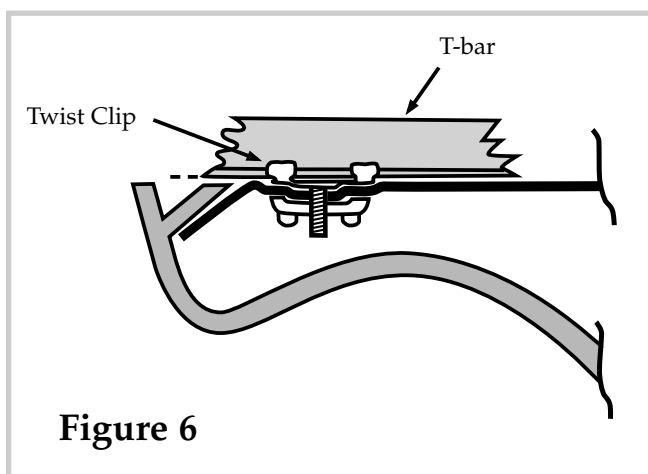

Figure 6

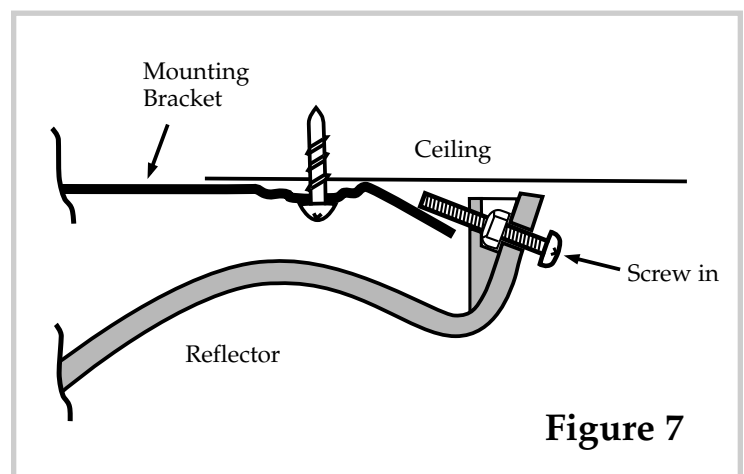

Figure 7