

RUSH BATTEN 1 HEX

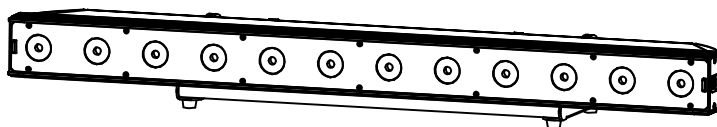

User Manual

Martin[®]
by HARMAN

© 2017 HARMAN® Professional Denmark ApS. Information subject to change without notice. HARMAN® Professional Denmark and all affiliated companies disclaim liability for any injury, damage, direct or indirect loss, consequential or economic loss or any other loss occasioned by the use of, inability to use or reliance on the information contained in this manual. Martin®, RUSH®, HARMAN® and all other trademarks in this document pertaining to services or products by Martin Professional™ or its affiliates and subsidiaries are registered as the property of HARMAN® Professional Denmark..

Martin Professional • Olof Palmes Allé 18 • 8200 Aarhus N • Denmark • www.martin.com

Manual: Revision B

Table of contents

Safety information	4
Introduction	8
Before using the product for the first time	8
Physical installation	9
Standing the fixture on the floor	9
Fastening the fixture to a flat surface	9
Mounting the fixture on a truss	9
AC power	11
Linking fixtures to power in a chain	11
Fixture overview	13
Control data link	14
Tips for reliable data transmission	14
Connecting the data link	15
Fixture setup	16
Using the control menus	16
Setting DMX address	16
Setting DMX mode and Master-Slave	17
Fixture settings	17
Fixture information	19
Setting options by RDM	19
Scanning for RDM devices on the data link	20
Getting status and setting options by RDM	20
RDM functions	20
Effects	23
Dimming	23
Strobe effects	23
Color	23
Maintenance	24
Cleaning	24
Replacing the primary fuse	25
Updating firmware	25
Service and repairs	25
DMX protocol	26
Control menus	32
Troubleshooting	33
Specifications	35

Safety information



WARNING!

Read the safety precautions in this manual before installing, operating or servicing this product.

The following symbols are used to identify important safety information on the product and in this manual:



Warning!

Safety hazard. Risk of severe injury or death.



Warning!

Powerful light emission. Risk of eye injury.



Warning!

See user manual for important safety information.



Warning!

Hazardous voltage. Risk of lethal or severe electric shock.



Warning!

Hot surfaces.



Warning!

Fire hazard.



Warning! Risk Group 1 product according to EN 62471. Do not stare at operating lamp and do not view the light output with optical instruments or any device that may concentrate the beam.

This lighting fixture is for professional use only and must be installed by a qualified technician. It is not for household use. It presents risks of severe injury or death due to fire hazards, electric shock and falls. It produces a powerful, concentrated beam of light that can create a fire hazard or a risk of eye injury if the safety precautions below are not followed.



Install, operate and service Martin™ products only as directed in their user manuals, or you may create a safety hazard or cause damage that is not covered by product warranties.

Follow the safety precautions listed below and observe all warnings in this manual and printed on the product. Keep this user manual for future use.

For the latest user documentation and other information for this and all Martin™ products, please visit the Martin website at <http://www.martin.com>

If you have any questions about how to install, operate or service the fixture safely, please contact your Martin™ distributor (see www.martin.com/where-to for details) or call the Martin™ 24-hour service hotline on +45 8740 0000, or in the USA on 1-888-tech-180.

Respect all locally applicable laws, codes and regulations when installing, operating or servicing the fixture.



Protection from electric shock

Do not expose the fixture to rain or moisture.

Disconnect the fixture from AC power before carrying out any installation or maintenance work and when the fixture is not in use.

Ensure that the fixture is electrically connected to ground (earth).

Use only Neutrik PowerCon cable connectors to connect to the fixture's power sockets.

Use only a source of AC power that complies with local building and electrical codes and has both overload and ground-fault (earth-fault) protection.

Socket outlets or external power switches used to supply the fixture with power must be located near the fixture and easily accessible so that the fixture can easily be disconnected from power.

Replace defective fuses with ones of the specified type and rating only.

Isolate the fixture from power immediately if the power plug or any seal, cover, cable, or other component is damaged, defective, deformed, wet or showing signs of overheating. Do not reapply power until repairs have been completed.

Before using the fixture, check that all power distribution equipment and cables are in perfect condition and rated for the electrical requirements of all connected devices.

Do not connect devices to power in a chain that will exceed the electrical ratings of any cable or connector used in the chain.

The mains power input cable supplied with the fixture is rated to supply only one fixture with mains power. Do not connect any device to the fixture's MAINS OUT socket when using this input cable. If you want to connect other fixtures to the MAINS OUT

socket, see 'Linking fixtures to power in a chain' on page 11.



Protection from burns and fire

Do not operate the fixture if the ambient temperature (T_a) exceeds 40° C (104° F).



The surface of the product casing can reach up to 65° C (149° F) during operation. Avoid contact by persons and materials. Allow the fixture to cool for at least 10 minutes before handling.

Keep flammable materials well away from the fixture. Keep all combustible materials (e.g. fabric, wood, paper) at least 100 mm (4 in.) away from the fixture.

Ensure that there is free and unobstructed airflow around the fixture. Provide a minimum clearance of 0.5 m (20 in.) around fans and air vents.

Do not illuminate surfaces within 0.5 m (20 in.) of the fixture.

Do not attempt to bypass thermostatic switches or fuses.

Do not stick filters, masks or other materials onto any optical component.

The fixture's lenses can focus the sun's rays inside the fixture, creating a risk of fire and damage. Do not expose the front of the fixture to sunlight or any other bright light source.



Protection from injury

Fasten the fixture securely to a fixed surface or structure when in use. The fixture is not portable when installed.

Ensure that any supporting structure and/or hardware used can hold at least 10 times the weight of all the devices they support.

If suspending from a rigging structure, fasten a suitable rigging clamps to the fixture. Do not use safety cables as the primary means of support.

If the fixture is installed in a location where it may cause injury or damage if it falls, install as directed in this manual a secondary attachment such as a safety cable that will hold the fixture if a primary attachment fails. The secondary attachment must be approved by an official body such as TÜV as a safety attachment for the weight that it secures, must comply with EN 60598-2-17 Section 17.6.6 and must be capable of bearing a static suspended load that is ten times the weight of the fixture and all installed accessories.

Check that all external covers and rigging hardware are securely fastened.

Block access below the work area and work from a stable platform whenever installing, servicing or moving the fixture.

Do not operate the fixture with missing or damaged covers, shields or any optical component.

In the event of an operating problem, stop using the fixture immediately and disconnect it from power. Do not attempt to use a fixture that is obviously damaged.

Do not modify the fixture in any way not described in this manual or install other than genuine Martin™ parts.

Refer any service operation not described in this manual to a qualified technician.



Protection from eye injury

The fixture falls into Risk Group 1 according to EN62471. To minimize the risk of eye irritation or injury, disconnect the fixture from power at all times when the fixture is not in use, and provide well-lit conditions to reduce the pupil diameter of anyone working on or near the fixture.

The light from the LED lamp is possibly hazardous and may be harmful to the eyes. Do not stare directly into the product's light output.

Do not look at the light output with magnifiers, telescopes, binoculars or similar optical instruments that may concentrate the light output.

Ensure that persons are not looking directly into the front of the fixture when the product lights up suddenly. This can happen when power is applied, when the product receives a DMX signal, or when certain control menu items are selected.

Introduction

The RUSH BATTEN 1 HEX is a bright 12-cell batten using 12 watt RGBAW+UV 6-in-1LEDs. It offers electronic dimming and strobe and features a bracket for floor or truss mounting. A removable diffuser/lens gives two possible beam angles. The LED source and rugged, lightweight construction make it ideal for live shows, TV events, stage, concerts, and nightclubs.

The RUSH BATTEN 1 HEX can be controlled using any DMX-compliant controller and may be remotely configured by RDM. It is supplied with this user manual, and a 1.5 m (4.9 ft.) power cable ready for a local power plug (not included).

This user manual is for software v1.2.

Before using the product for the first time

1. Read 'Safety information' on page 4 before installing, operating or servicing the fixture.
2. Unpack and ensure that there is no transportation damage before using the fixture. Do not attempt to operate a damaged fixture.
3. If the fixture is not going to be hard-wired to a mains supply, install a local power plug (not supplied) on the end of the supplied power cable.
4. Ensure that the voltage and frequency of the power supply match the power requirements of the fixture.
5. Check the support pages on the Martin Professional website at www.martin.com for the most recent user documentation and technical information about the fixture. Martin™ user manual revisions are identified by the revision letter at the bottom of the inside cover.

Physical installation



Warning! Read 'Safety information' on page 4 before installing the fixture.

The fixture is designed for indoor use only and must be used in a dry location with adequate ventilation. Ensure that none of the fixture's ventilation slots are blocked.

Fasten the fixture to a secure structure or surface. Do not stand it on a surface or leave it where it can be moved or fall over. If you install the fixture in a location where it may cause injury or damage if it falls, secure it as directed in this user manual using a securely anchored safety cable that will hold the fixture if the primary fastening method fails.

Do not use the fixture to illuminate surfaces within 0.5 m (20 in.) of the fixture.

Martin™ can supply safety cables and rigging clamps that are suitable for use with the fixture (see 'Accessories' on page 36).

Standing the fixture on the floor

The fixture may be used free standing on the floor by placing on the mounting bracket.

Fastening the fixture to a flat surface

The fixture can be fastened to a hard, fixed, flat surface. Ensure that the surface and all fasteners used can support at least 10 times the weight of all fixtures and equipment they will support.

Fasten the fixture securely. If you install the fixture in a location where it may cause injury or damage if it falls, secure it as directed below with a securely anchored safety cable that will hold the fixture if the primary fastening method fails.

Mounting the fixture on a truss

The fixture can be clamped to a truss or similar rigging structure in any orientation. When installing the fixture hanging vertically down, you can use an open-type clamp such as a G-clamp. When installing in any other orientation, you must use a closed-type rigging clamp such as half-coupler clamp (see illustration on right) that completely encircles the truss chord.



To clamp the fixture to a truss:

1. Check that the rigging structure can support at least 10 times the weight of all fixtures and equipment to be installed on it.
2. Block access under the work area.
3. Check that the rigging clamps are undamaged and approved for the fixture's weight. Bolt a rigging clamp securely to the bracket. The bolt used must be M12, grade 8.8 steel minimum, and fastened with a self-locking nut.
4. Working from a stable platform, hang the fixture on the truss and fasten the rigging clamp onto the truss.
5. Secure the fixture with a safety cable as directed below.

Securing with a safety cable

Secure the fixture with a safety cable (or other secondary attachment) that is approved for the weight of the fixture so that the safety cable will hold the fixture if a primary attachment fails.

Loop the safety cable through the eye bracket on the fixture (arrowed in illustration below) and around a secure anchoring point.

If a safety cable attachment point becomes damaged or deformed, do not use the fixture. Return it to a Martin Service Centre for repair.

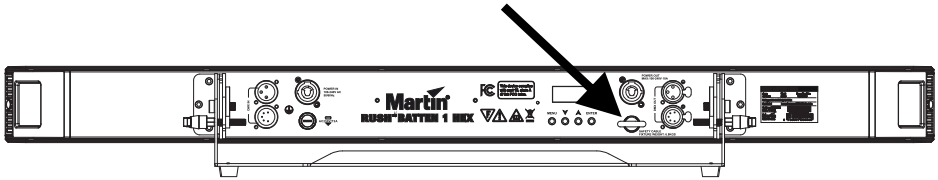

Using the diffuser

The fixture is provided with a diffuser which slides into slots on the front of the fixture and increases the beam angle from 25° to 32°. The diffuser is retained by tabs at the ends of the fixture, which you can release by pulling back the button on the end plate.

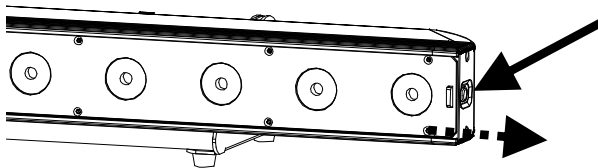

AC power



Read ‘Safety information’ on page 4 before connecting the fixture to AC mains power.



Warning! The mains power input cable supplied with the fixture can supply only one fixture with mains power. Do not connect any device to the fixture’s MAINS OUT socket when using this input cable. If you want to connect other fixtures to the MAINS OUT socket, see ‘Linking fixtures to power in a chain’ on page 11.

For protection from electric shock, the fixture must be grounded (earthed). The power distribution circuit must be equipped with a fuse or circuit breaker and ground-fault (earth-fault) protection.

Socket outlets or external power switches used to supply the fixture with power must be located near the fixture and easily accessible so that the fixtures can easily be disconnected from power.

Do not use an external dimming system to supply power to the fixture, as this may cause damage to the fixture that is not covered by the product warranty.

Do not disconnect the Neutrik PowerCon connectors while the fixture is powered, as this may cause arcing which will damage the connector.

The fixture can be hard-wired to a building electrical installation if you want to install it permanently, or a power plug (not supplied) that is suitable for the local power outlets can be installed on the power cable.

If you install a power plug on the power cable, install a grounding type (earthed) plug with integral cable grip that is rated minimum 8 A at a suitable voltage for your local power system. Follow the plug manufacturer’s instructions and connect the wires in the power cable as shown in this table:

	Live or L	Neutral or N	Earth, Ground or Ⓧ
US system	Black	White	Green
EU system	Brown	Blue	Yellow/green

The fixture has an auto-ranging power supply that accepts AC mains power at 100-240 V at 50/60 Hz. Do not apply AC mains power at any other voltage or frequency to the fixture.

Linking fixtures to power in a chain

The mains power input cable supplied with the fixture is 0.75mm² (18 AWG), rated at 6A, and can only supply enough power for one fixture. If you want to

use the MAINS OUT socket on the fixture to link power to the next fixture in a daisy-chain, you need to obtain the larger 2.5mm² (14 AWG) power input cables and power link cables available as an accessory from Martin, see 'Accessories' on page 36.

Using the 14 AWG or 2.5mm² cables from Martin™, you can link:

- Maximum eight (8) RUSH BATTEN 1 HEX fixtures in total at 100-120 V, or
- Maximum eighteen (18) RUSH BATTEN 1 HEX fixtures in total at 200-240 V.

However, if you link too many fixtures the inrush current may cause tripping of overcurrent devices on the supply circuit. If this is a problem, split the fixtures into smaller groups, or fit a type-D miniature circuit breaker (MCB) for the circuit.

If you install a power plug on the 14 AWG / 2.5 mm² power input cable, install a grounding type (earthed) plug with integral cable grip that is rated minimum 16 A at the correct voltage rating for your local power supply.

Fixture overview

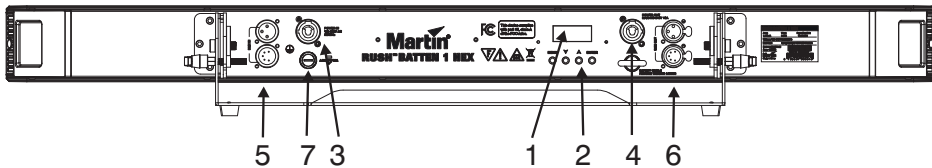

1 – Display

The display is used to configure the fixture and show status.

2 – Control buttons

- MENU: Press to activate the menu. Within the menu, press to escape and return to the previous level, or to exit the menu at the top level.
- DOWN: Press to scroll down through menu options.
- UP: Press to scroll up through menu options.
- ENTER: Press to confirm and save the menu selection.

3 – AC mains power input

A Neutrik PowerCon inlet connector is provided to connect the fixture to mains power.

4 – AC mains power link output

A Neutrik PowerCon outlet connector is provided to allow mains power to be linked to the next fixture. Please refer to the section above “Linking fixtures to power in a chain” for safe use of this connector.

5,6 –XLR DMX input/output connectors

For your convenience, 3 and 5-pin XLR sockets are provided for DMX input and output (through to next fixture). Do not connect output cables to both the 3-pin and 5-pin output sockets at the same time as this may cause data errors (in other words, you cannot use the two outputs on the fixture to split the DMX line).

7 –Power fuse

The fixture’s T 250V 2A fuse is located in a fuse holder next to the power input/output connectors.

See “Replacing the primary fuse” on page 25 if this fuse blows.

Control data link

A DMX 512 data link is required in order to control the fixture via DMX. The fixture has 5-pin XLR connectors for DMX data input and output.

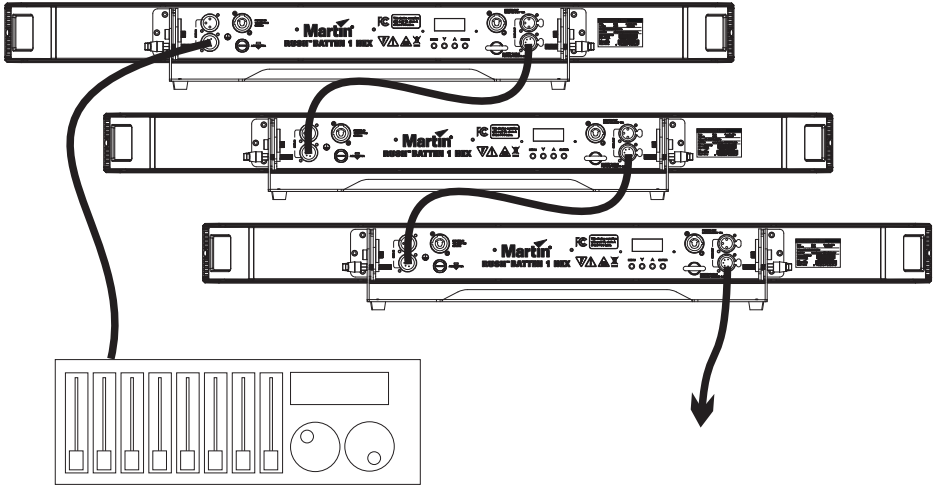

Up to 32 devices can be linked together on a single daisy chain. The total number of fixtures in one 512-channel DMX universe is limited by the number of DMX channels required by the fixtures. Note that if independent control of a fixture is required, it must have its own DMX channels. Fixtures that are required to behave identically can share the same DMX address and channels. To add more fixtures or groups of fixtures when the above limits are reached, add a DMX universe and/or split the daisy-chained link into branches using a powered DMX splitter.

Tips for reliable data transmission

Use shielded twisted-pair cable designed for RS-485 devices: standard microphone cable cannot transmit control data reliably over long runs. 24 AWG cable is suitable for runs up to 300 meters (1000 ft.). Heavier gauge cable and/or an amplifier is recommended for longer runs.

- pin 1 = shield
- pin 2 = cold (-)
- pin 3 = hot (+).

Pins 4 and 5 in the 5-pin XLR connectors are not used in the fixture but are available for possible additional data signals as required by the DMX512-A standard. Standard pin-out is pin 4 = data 2 cold (-) and pin 5 = data 2 hot (+).

To split the link into branches, use an opto-isolated splitter such as the Martin™ DMX 5.3 Splitter. Terminate the link by installing a termination plug in

the output socket of the last fixture. The termination plug, which is a male XLR plug with a 120-Ohm, 0.25-Watt resistor soldered between pins 2 and 3, “soaks up” the control signal so it does not reflect and cause interference. If a splitter is used, terminate each branch of the link.

Connecting the data link

To connect the fixture to data:

1. Connect the DMX data output from the controller to the closest fixture’s male XLR DMX input connector.
2. Connect the first fixture’s DMX output to the DMX input of the next fixture and continue connecting fixtures output to input.
3. Terminate the last fixture on the link with a DMX termination plug.

Fixture setup

This section explains the fixture characteristics you can set that determine how it can be controlled and will behave. You choose the settings using the menus available from the control panel, and they are retained even when the fixture is powered off.

Options can also be set over the DMX line using RDM from a suitable controller, see “Setting options by RDM” on page 19.

A complete map of the control menu structure and brief explanations of their purposes can be found on page 32. Only the most-used functions are described in this section.

When no DMX signal is present and the fixture is not in master-slave mode, the display will flash.

Using the control menus

To access the control menus, press the MENU button.

Navigate the menu structure using the ENTER, DOWN and UP buttons.

To select a menu option or to confirm a selection, press the ENTER button.

To return to a higher level in the menu structure without making a change, press the MENU button.

To exit the control menus completely, press and hold the MENU button.

Setting DMX address

Each fixture must be assigned a DMX address. The DMX address, also known as the start channel, is the first channel used to receive instructions from a DMX controller. The fixture is controlled using 13 or 80 DMX channels. If a fixture has a DMX address of 1 in 13CH mode, then it uses channels 1 to 13 inclusive. The following fixture in the DMX chain could then be set to a DMX address of 14.

For independent control, each fixture must be assigned its own control channels. Two fixtures of the same type may share the same address if identical behavior is desired. Address sharing can be useful for diagnostic purposes and symmetric control.

To set the fixture's DMX address:

1. Enter the control menu and select DMX FUNC. Press ENTER.
2. Select DMX ADDR and press ENTER.
3. Use the UP and DOWN buttons to select the desired address setting.
4. Press ENTER to confirm your selection.

Setting DMX mode and Master-Slave

The fixture can be set to operate in 13 channel or 80 channel DMX mode, or in Slave mode for Master-Slave operation.

13 channel mode is the normal control mode. 80 channel mode allows individual RGBAW+UV control of each pixel.

1. In the DMX FUNCTIONS menu select DMX MODE and press ENTER.
2. Select 13CH (default), 80CH or SLAVE.
3. Press ENTER to confirm or press MENU to exit.

Action on loss of DMX and setting master show mode

If the fixture loses the DMX signal, it can either hold the look it's currently displaying, black out, or generate a light show in master mode. The default is HOLD. To change the setting:

4. In the SHOW SET menu select OFFLINE and press ENTER.
5. Select SHOW (for Master mode), HOLD (default) or BLACKOUT.
6. Press ENTER to confirm or press MENU to exit.

In SHOW Master mode, the SHOWMODE option lets you choose 2 different shows. If there is no DMX, selecting SHOW or the SHOWMODE menu option will start the show, which will continue even if you exit the menu. To end the show, go to the DMX FUNCTIONS menu, select DMX MODE, change the mode and press ENTER. Disconnecting power will also disable the show mode.

Fixture settings

Dimmer mode (Tungsten simulation)

You can configure the fixture to dim instantly or with a fade time to simulate a tungsten lamp.

1. In the SHOW SET menu select DIM MODE and press ENTER.
2. Select INSTANT (default) or TUNGSTEN to disable or enable fade time.
3. Press ENTER to confirm or press MENU to exit.

Dimmer curve

You can set the dimmer curve which affects how the fixture brightness tracks the DMX control value for the dimmer.

1. In the SHOW SET menu select DIMCURVE and press ENTER.
2. Select LINEAR, SQUARE, INVSQUAR or S-CURVE.
3. Press ENTER to confirm or press MENU to exit.

LINEAR The increase in light intensity appears to be linear as DMX value is increased.

- SQUARE** Light intensity control is finer at low levels and coarser at high levels (square law).
- INVSQUAR** Light intensity control is coarser at low levels and finer at high levels (inverse square law).
- S-CURVE** Light intensity control is finer at low levels and high levels and coarser at medium levels.

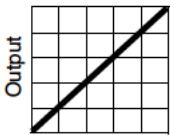

Optically linear

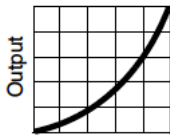

Square law

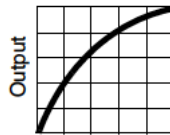

Inverse square law

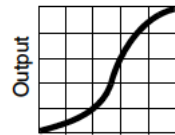

S-curve

Display off

You can configure the LCD display to turn off automatically if no buttons are pressed.

4. In the DISPLAY menu select AUTO OFF and press ENTER.
5. Select YES or NO (default) to enable or disable turn off.
6. Press ENTER to confirm or press MENU to exit.

You can also set the display brightness using the BRIGHT option.

Test mode

The fixture can be placed into a test mode:

1. In the TEST menu select AUTO and press ENTER.
2. Select RUN to enable test mode, or CANCEL to disable it (default).
3. Press ENTER to confirm or press MENU to exit.

Manual Test mode

You can manually set the DMX control values for each function. This can be useful if you want to leave the fixture showing a fixed output without a DMX controller.

1. In the FIXTURE TEST menu select MANUAL TEST and press ENTER.
2. Select STROBE, DIMMER, R, G, B, W, A, U, CTC, COLOR, FX, or FX SPEED and press ENTER. The fixture will enter manual test mode and any previous levels you have set will be recalled.
3. Use the UP/DOWN buttons to set the level for the selected function. Press ENTER to store the value and select a different function.
4. Press MENU to exit. The display will show MANUAL.

The fixture will remain in Manual Test mode even if you exit the menu. To cancel Manual Test mode, go to the DMX FUNCTIONS menu and select DMX MODE, change the mode then press MENU.

Restore to factory settings

To restore all settings to factory defaults:

1. In the SPECIAL menu select FACTORY and press ENTER
2. Select YES to restore factory settings.
3. Press ENTER to confirm or MENU to exit without restoring.

Fixture information

Total operating hours

To display the fixture's total operating hours:

1. In the INFO menu, select FIX HOUR and press ENTER.
2. The total operating time of the fixture is displayed in hours.
3. Press MENU to exit.

Fixture Temperature

To display the temperature inside the fixture:

1. In the INFO menu, select TEMP VAL and press ENTER.
2. The temperature is displayed. You can select Celsius or Fahrenheit in the / DISPLAY / TEMPUNIT option.
3. Press MENU to exit.

Displaying software version

To display the version of firmware installed in the fixture:

1. In the INFO menu, select FIRMWARE and press ENTER.
2. The firmware version is displayed.
3. Press MENU to exit.

Setting options by RDM

You can remotely configure the fixture over the DMX line using RDM. Martin® offers a range of suitable RDM-compatible controllers.

Martin® M-PC is a Windows-based application available from Martin® that lets you set up, manage and control a lighting installation from a PC that is connected to the installation via a DMX data link. To use Martin® M-PC, connect a PC running the application to the data link via a USB-to-DMX interface box such as the Martin® M-DMX. Note that RDM is only supported on Port A of the M-DMX.

A full list of the RDM functions that the fixture supports is given at the end of this chapter. These functions are generally referred to using the more specific term 'PIDs' or 'Parameter IDs'.

Scanning for RDM devices on the data link

Before you can communicate with fixtures using RDM, you must send a scan command (also called a device discovery command) to all the devices on the data link so that the RDM controller can identify them. It does this by retrieving each device's factory-set unique identifier (UID). This process can take some time depending on the number of devices on the link.

To identify the fixtures on the link:

1. Check that the fixtures are correctly connected to the RDM controller on the data link and that power is applied to all fixtures.
2. In Martin® M-PC, go to RDM CONTROLLER → DISCOVER DEVICES.
3. Give the controller time to identify the devices on the link and prepare for communication with the devices.

Getting status and setting options by RDM

The status and options listed in the table below can be read and set by RDM.

You can set an option on one fixture by sending a unicast RDM command to that one fixture only, or you can set the same option on all the fixtures on the data link by sending a broadcast RDM command to all the devices on the link.

For status reading, you can only use unicast RDM to read information from an individual fixture.

RDM functions

As a minimum, the fixture supports the following RDM functions:

Device discovery

DISC_UNIQUE_BRANCH
DISC_MUTE
DISC_UN_MUTE

Device management

	GET	SET
DEVICE_INFO	✓	
IDENTIFY_DEVICE	✓	✓
DMX_START_ADDRESS	✓	✓
SOFTWARE_VERSION_LABEL	✓	
SUPPORTED_PARAMETERS	✓	
PARAMETER_DESCRIPTION	✓	
COMMS_STATUS	✓	
QUEUED_MESSAGE	✓	
STATUS_MESSAGES	✓	
STATUS_ID_DESCRIPTION	✓	
CLEAR_STATUS_ID		✓
DEVICE_MODEL_DESCRIPTION	✓	
MANUFACTURER_LABEL	✓	
DEVICE_LABEL	✓	✓
FACTORY_DEFAULTS		✓
DMX_PERSONALITY	✓	✓
DMX_PERSONALITY_DESCRIPTION	✓	
SENSOR_DEFINITION	✓	
SENSOR_VALUE	✓	
DEVICE_HOURS	✓	
BOOT_SOFTWARE_VERSION_ID	✓	
BOOT_SOFTWARE_VERSION_LABEL	✓	
LAST_STATE		✓
DIMMER_CURVE		✓
DEVICE_POWER_CYCLES	✓	

SLOT_DESCRIPTION	✓	✓
RESET_DEVICE		✓

Effects

This section describes the effects provided by the RUSH BATTEN 1 HEX. See 'DMX protocol' on page 26 for a full list of the DMX channels and values required to control the different effects.

Dimming

Overall intensity can be precisely adjusted from 0 to 100%.

Strobe effects

An electronic shutter provides instant open and blackout, random and variable speed flash from 1 to 12 flashes per second, and pulse effects.

Color

In 13CH mode, color can be mixed for all pixels together using 6 control channels for Red, Green, Blue, White, Amber and UV.

In 80CH mode, color can be mixed independently for each pixel using twelve groups of 6 control channels for Red, Green, Blue, White, Amber and UV.

In both modes, a color wheel function allows preselection of fixed colors, and a color macro effect allows generation of color patterns. A CTC channel is also provided to adjust the warmth of the light.

Maintenance



Warning! Read ‘Safety information’ on page 4 before servicing the fixture.

Disconnect the fixture from mains power before cleaning or servicing.

Service fixtures in an area where there is no risk of injury from failing parts, tools or other materials.

The user may carry out the service operations described in this manual. All other service operations must be carried out by an authorized Martin™ service technician. Do not try to repair the fixture yourself, as you may create a safety risk or cause damage that is not covered by the product warranty.

Installation, on-site service and maintenance can be provided worldwide by the Martin Professional™ Global Service organization and its approved agents, giving owners access to Martin’s expertise and product knowledge in a partnership that will ensure the highest level of performance throughout the product’s lifetime. Please contact ‘Martin™’ for details.

Cleaning

Excessive dust, smoke fluid, and particle buildup degrades performance, causes overheating and will damage the fixture. Damage caused by inadequate cleaning or maintenance is not covered by the product warranty.

The cleaning of external optical lenses must be carried out periodically to optimize light output. Cleaning schedules for lighting fixtures vary greatly depending on the operating environment. It is therefore impossible to specify precise cleaning intervals for the fixture. Environmental factors that may result in a need for frequent cleaning include:

- Use of smoke or fog machines.
- High airflow rates (near air conditioning vents, for example).
- Presence of cigarette smoke.
- Airborne dust (from stage effects, building structures and fittings or the natural environment at outdoor events, for example).

If one or more of these factors is present, inspect fixtures within their first 100 hours of operation to see whether cleaning is necessary. Check again at frequent intervals. This procedure will allow you to assess cleaning requirements in your particular situation. If in doubt, consult your Martin dealer about a suitable maintenance schedule.

Use gentle pressure only when cleaning, and work in a clean, well-lit area. Do not use any product that contains solvents or abrasives, as these can cause surface damage.

To clean the fixture:

1. Disconnect the fixture from power and allow it to cool for at least 10 minutes.
2. Vacuum or gently blow away dust and loose particles from the outside of the fixture and the air vents at the back and sides of the unit with low-pressure compressed air.
3. Clean surfaces by wiping gently with a soft, clean lint-free cloth moistened with a weak detergent solution. Do not rub glass surfaces hard: lift particles off with a soft repeated press. Dry with a soft, clean, lint-free cloth or low-pressure compressed air. Remove stuck particles with an unscented tissue or cotton swab moistened with glass cleaner or distilled water.

Replacing the primary fuse

If the fixture is completely dead, the fixture's primary fuse may have blown and it may be necessary to install a new fuse. Replace with a fuse of the same size and specified rating only.

If you need to replace the fuse:

1. Disconnect the fixture from power and allow it to cool.
2. Unscrew the cap of the fuse holder (shown on page 13) and remove the fuse.
3. Replace with a fuse of the same size and rating only.
4. Screw the fuse holder cap back on before reapplying power.

Updating firmware

If Martin releases an updated version of firmware for this fixture, you can update it using the Martin Companion Software using M-DMX. See www.martin.com.

Service and repairs

Never try to repair the fixture by yourself as this may result in damage or malfunction and it may potentially void your product warranty. The equipment must only be serviced or repaired by an authorized Martin service technician.

DMX protocol

13CH mode

Channel	Value	Function	Fade type	Default value
1	0-7	Shutter Shutter closed	Snap	10
	8-15	Shutter open		
	16-131	Strobe effect slow to fast		
	132-139	On		
	140-181	Fast close & slow open		
	182-189	On		
	190-231	Fast open & slow close		
	232-239	On		
	240-247	Random strobe effect slow →fast		
248-255	Shutter open			
2	0-255	Master Dimmer Intensity 0 to 100%	Fade	0
3	0-255	Red Intensity 0 to 100%	Fade	255
4	0-255	Green Intensity 0 to 100%	Fade	255
5	0-255	Blue Intensity 0 to 100%	Fade	255
6	0-255	White Intensity 0 to 100%	Fade	0
7	0-255	Amber Intensity 0 to 100%	Fade	0
8	0-255	UV Intensity 0 to 100%	Fade	0
9	0-255	CTC Open → Warm	Fade	0
10	0-10	Color wheel effect (color presets) Open (white)	Snap	0
	11-15	Color 1 – LEE26 Bright Red		
	16-20	Color 2 – LEE158 Deep Orange		
	21-25	Color 3 – LEE105 Orange		
	26-30	Color 4 – LEE179 Chrome Orange		
	31-35	Color 5 – LEE015 Deep Straw		
	36-40	Color 6 – LEE010 Medium Yellow		

Channel	Value	Function	Fade type	Default value
	41-45	Color 7 – LEE101 Yellow		
	46-50	Color 8 – LEE100 Spring Yellow		
	51-55	Color 9 – LEE088 Lime Green		
	56-60	Color 10 – LEE121 Lee Green		
	61-65	Color 11 – LEE738 JAS Green		
	66-70	Color 12 – LEE139 Primary Green		
	71-75	Color 13 – LEE124 Dark Green		
	76-80	Color 14 – LEE323 Jade		
	81-85	Color 15 – LEE115 Peacock Blue		
	86-90	Color 16 – LEE140 Summer Blue		
	91-95	Color 17 – LEE144 No colour Blue		
	96-100	Color 18 – LEE172 Lagoon Blue		
	101-105	Color 19 – LEE183 Moonlight Blue		
	106-110	Color 20 – LEE161 Slate Blue		
	111-115	Color 21 – LEE165 Daylight Blue		
	116-120	Color 22 – LEE118 Light Blue		
	121-125	Color 23 – LEE068 Sky Blue		
	126-130	Color 24 – LEE142 Pale Violet		
	131-135	Color 25 – LEE194 Surprise Pink		
	136-140	Color 26 – LEE170 Deep Lavender		
	141-145	Color 27 – LEE002 Rose Pink		
	146-150	Color 28 – LEE192 Flesh Pink		
	151-155	Color 29 – LEE111 Dark Pink		
	156-160	Color 30 – LEE328 Follies Pink		
	161-165	Color 31 – LEE128 Bright Pink		
	166-170	Color 32 – LEE975 Magic Magenta		
	171-175	Color 33 – LEE793 Vanity Fair		
	176-180	Color 34 – LEE148 Bright Rose		
	181-185	Color 35 - Blackout		
	186-190	Color 36 – LEE130 Clear		
	191-192	Open (white)		
		Color Scroll		
	193-214	Ascending, fast → slow		
	215-221	Stop (at current position)		
	222-243	Descending, slow → fast		
		Random colors		
	244-247	Random color, fast		
	248-251	Random color, medium		
	252-255	Random color, slow		
11	0-11	Color Macro (color patterns) No function	Snap	0
	12	Pulse		
	13-49	No function		

Channel	Value	Function	Fade type	Default value
	50 51 52 53-75 76 77-161 162 163-255	Rainbow wave Rainbow Step Rainbow Pulse No function Water 1 No function Water 2 No function		
12	0-126 127-129 130-255	Color Macro Speed Effect forward Fast → Slow Effect stop Effect reverse Slow → Fast	Fade	128
13	0-59 60-64 65-69 70-74 75-79 80-134 135-139 140-144 145-149 150-154 155-159 160-164 165-255	Lamp on/off, reset, personality Reserved (no function) Dimmer linear curve Dimmer square law curve Dimmer inverse square law curve Dimmer S-curve No function Smoothing on Smoothing off Auto Blackout on Auto Blackout off Control panel display on Control panel display off Reserved (no function)	Snap	0

80CH mode

Channel	Value	Function	Fade type	Default value
1	0-7 8-15 16-131 132-139 140-181 182-189 190-231 232-239 240-247 248-255	Shutter Shutter closed Shutter open Strobe effect slow to fast On Fast close & slow open On Fast open & slow close On Random strobe effect slow →fast Shutter open	Snap	10

Channel	Value	Function	Fade type	Default value
2	0-255	Master Dimmer Coarse Intensity 0 to 100%	Fade	0
3	0-255	Master Dimmer Fine Fine dimmer adjustment	Fade	0
4	0-255	CTC Open → Warm	Fade	0
5	0-10 11-15 16-20 21-25 26-30 31-35 36-40 41-45 46-50 51-55 56-60 61-65 66-70 71-75 76-80 81-85 86-90 91-95 96-100 101-105 106-110 111-115 116-120 121-125 126-130 131-135 136-140 141-145 146-150 151-155 156-160 161-165 166-170 171-175 176-180	Color wheel effect (color presets) Open (white) Color 1 – LEE26 Bright Red Color 2 – LEE158 Deep Orange Color 3 – LEE105 Orange Color 4 – LEE179 Chrome Orange Color 5 – LEE015 Deep Straw Color 6 – LEE010 Medium Yellow Color 7 – LEE101 Yellow Color 8 – LEE100 Spring Yellow Color 9 – LEE088 Lime Green Color 10 – LEE121 Lee Green Color 11 – LEE738 JAS Green Color 12 – LEE139 Primary Green Color 13 – LEE124 Dark Green Color 14 – LEE323 Jade Color 15 – LEE115 Peacock Blue Color 16 – LEE140 Summer Blue Color 17 – LEE144 No colour Blue Color 18 – LEE172 Lagoon Blue Color 19 – LEE183 Moonlight Blue Color 20 – LEE161 Slate Blue Color 21 – LEE165 Daylight Blue Color 22 – LEE118 Light Blue Color 23 – LEE068 Sky Blue Color 24 – LEE142 Pale Violet Color 25 – LEE194 Surprise Pink Color 26 – LEE170 Deep Lavender Color 27 – LEE002 Rose Pink Color 28 – LEE192 Flesh Pink Color 29 – LEE111 Dark Pink Color 30 – LEE328 Follies Pink Color 31 – LEE128 Bright Pink Color 32 – LEE975 Magic Magenta Color 33 – LEE793 Vanity Fair Color 34 – LEE148 Bright Rose	Snap	0

Channel	Value	Function	Fade type	Default value
	181-185 186-190 191-192 193-214 215-221 222-243 244-247 248-251 252-255	Color 35 - Blackout Color 36 – LEE130 Clear Open (white) Color Scroll Ascending, fast → slow Stop (at current position) Descending, slow → fast Random colors Random color, fast Random color, medium Random color, slow		
6	0-11 12 13-49 50 51 52 53-75 76 77-161 162 163-255	Color Macro (color patterns) No function Pulse No function Rainbow wave Rainbow step Rainbow pulse No function Water 1 No function Water 2 No function	Snap	0
7	0-126 127-129 130-255	Color Macro Speed Effect forward Fast → Slow Effect stop Effect reverse Slow → Fast	Fade	128
8	0-59 60-64 65-69 70-74 75-79 80-134 135-139 140-144 145-149 150-154 155-159 160-164 165-255	Lamp on/off, reset, personality Reserved (no function) Dimmer linear curve Dimmer square law curve Dimmer inverse square law curve Dimmer S-curve No function Smoothing on Smoothing off Auto Blackout on Auto Blackout off Control panel display on Control panel display off Reserved (no function)	Snap	0

Channel	Value	Function	Fade type	Default value
9	0-255	Red 1 Intensity 0 to 100%	Fade	255
10	0-255	Green 1 Intensity 0 to 100%	Fade	255
11	0-255	Blue 1 Intensity 0 to 100%	Fade	255
12	0-255	White 1 Intensity 0 to 100%	Fade	0
13	0-255	Amber 1 Intensity 0 to 100%	Fade	0
14	0-255	UV 1 Intensity 0 to 100%	Fade	0
...		...		
75	0-255	Red 12 Intensity 0 to 100%	Fade	255
76	0-255	Green 12 Intensity 0 to 100%	Fade	255
77	0-255	Blue 12 Intensity 0 to 100%	Fade	255
78	0-255	White 12 Intensity 0 to 100%	Fade	0
79	0-255	Amber 12 Intensity 0 to 100%	Fade	0
80	0-255	UV 12 Intensity 0 to 100%	Fade	0

Control menus

To access the control menus, press the MENU button. Use the UP and DOWN buttons to navigate the menus. Select a menu option with the ENTER button. For more information, see 'When no DMX signal is present and the fixture is not in master-slave mode, the display will flash.

Using the control menus' on page 16.

Default fixture settings are shown in **bold**.

Menu		Setting/value	Explanation
DMX Func	DMX ADDR	001 –500*	Set fixture's DMX address
	DMX Mode	13CH	13 channel DMX mode
		80CH	80 channel DMX mode
		Slave	Slave mode
DMX Val	Dimmer xxx... (... other functions)	Show level of each incoming DMX channel	
Show Set	Offline	Show	When no DMX, be lightshow master**
		Hold	When no DMX, hold state
		Blackout	When no DMX, blackout
	ShowMode	Show1	Lightshow 1**
		Show2	Lightshow 2**
		Show3	Lightshow 3**
Dim Mode	Instant /Tungsten	Set fade response time	
DimCurve	Square /InsSquar/S-Curve/Linear	Set dimmer curve	
Display	Auto Off	Yes/ No	Automatically turn off display backlight when not in use
	Bright	1- 10	Set display brightness
	TempUnit	°C /°F	Set temperature unit
	Warning	Yes /No	Enable warning display
Test	Auto	Run/Cancel	Fixture auto test mode
	Manual	Dimmer... (... other functions)	Set fixed DMX value for each fixture control channel**
Info	Temp Val	xxx °C	Fixture temp
	Fix Hour	xxxh	Fixture power on time
	ShowHour	xxxh	LED illuminated time
	Firmware	1U:x.x.x 2U:x.x.x	Fixture firmware

Menu		Setting/value	Explanation
Special	Factory	Yes/No	Reset settings to factory defaults

*Maximum DMX address is determined by DMX mode:
13CH=max. 500, 80CH=max. 433

**To exit Show mode or Manual Test mode, enter the DMX Function menu, select the DMX Mode option, change the mode and press MENU.

Troubleshooting

This section describes a few common problems that may occur during operation and provides some suggestions for easy troubleshooting:

Symptom	Potential Causes	Remedies
No light from fixture, or fans not working.	Power supply issue such as blown fuse, faulty connector or damaged cable.	Ensure that the mains supply is connected and supplying power to the fixture. Check all power connections and cables. Check and if necessary replace the fixture fuse.
One of the control channels is unresponsive or only responds intermittently.	DMX setup or DMX link fault. Damaged internal cable connection.	See next section. Contact your Martin authorized distributor or service center for assistance.

Symptom	Potential Causes	Remedies
<p>Fixture does not respond to DMX control.</p>	<p>Incorrect DMX addressing</p> <p>Fault in the DMX network due to connector or cable damage, incorrect DMX addressing, or potential interference from proximity to a high voltage installation.</p>	<p>Ensure that fixture's DMX address matches address set on DMX control device.</p> <p>Ensure that DMX link is terminated.</p> <p>Check that all components on DMX link use standard DMX polarity.</p> <p>Attempt to control the fixture with another DMX control device.</p> <p>Move or shield link if it is close to an unshielded high-voltage installation.</p>

Specifications

Physical

Dimensions (LxWxH)..... 900 x 100 x 200 mm (35.4 x 3.9 x 7.9 in.)
Weight 6.8 kg (15 lbs.)

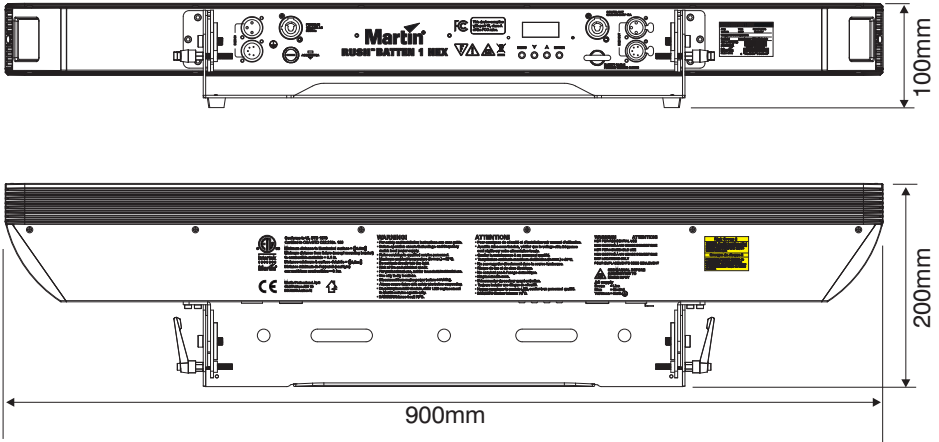

Dynamic Effects

Dimming 0 – 100%, coarse & fine control
Shutter Strobe & pulse effects, instant open and blackout
Color RGBAWUV (6-in-1) color mixing

Control and Programming

Control system USITT DMX512/1990 with RDM
DMX channels 13, 80
RDM compliance ANSI/ESTA E.120
Interface Control panel with backlit LCD display

Optics

Beam angle 25° (without diffuser), 33° (with diffuser)
Field angle 44° (without diffuser), 63° (with diffuser)

Construction

Color Black
Housing Extruded aluminium, thermoplastic end caps
IP rating IP 20

Installation

Mounting points Adjustable bracket, surface or truss mount
Location Indoor location only
Orientation Any
Minimum distance to illuminated surfaces 0.5 m (20 in.)
Minimum distance to combustible materials 0.1 m (4 in.)

Connections

AC power input/output..... Neutrik PowerCon
DMX & RDM data in/out..... 3-pin and 5-pin locking XLR

Electrical

AC power..... 100-240 V nominal, 50/60 Hz
Power supply unit..... Auto-ranging electronic switch mode
Fuse..... T 250 V 1.0 A
Maximum total power consumption..... 148 W
Typical half-cycle RMS inrush current..... 9.7 A
Recommended Miniature Circuit Breaker when power linking* Type D
*Per IEC 60898/UL489/CSA C22.2 No. 5

Typical power and current

100 V, 60 Hz..... 148 W, 1.6 A, PF 0.978
120 V, 60 Hz..... 148 W, 1.3 A, PF 0.972
230 V, 50 Hz..... 148 W, 0.78 A, PF 0.821

Measurements made at nominal voltage. Figures are typical, not maximum, allow for a deviation of +/- 10%.

Thermal

Cooling Convection
Maximum ambient temperature (T_a max.)..... 40° C (104° F)
Minimum ambient temperature (T_a min.)..... 0° C (32° F)

Approvals



EU safety EN 60598-2-17 (EN 60598-1), EN 62471, EN 62493
EU EMC..... EN 55015; EN 55032; EN 55103-1,-2;
..... EN 61000-3-2,-3; EN 61000-4-2, -4, -5; EN 61547
US safety UL 1573
US EMC..... 47 CFR 15 Class A
Canadian safety CSA C22.2 No. 166
Canadian EMC ICES-003 Class A
Australia/NZ..... RCM (Pending)

Included Items

Power cable, 1.5 m without mains plug

Accessories

Installation hardware

Half-coupler clamp P/N 91602005
G-clamp (vertical hanging suspension only) P/N 91602003
Quick-trigger clamp (vertical hanging suspension only) P/N 91602007

Safety cable, 60Kg, BGV C1P/N 91604006

Cables, 16 A, for connection to power in chains

Power relay cable 3 x 2.5 mm², H07RN-F
POWCON-POWCON 1.2 m (3.9 ft.) P/N 91611798

Power relay cable 3 x 14 AWG, SJOOW
POWCON-POWCON 1.2m (3.9 ft.) P/N 91610175

Power relay cable 3 x 2.5 mm², H07RN-F
POWCON-POWCON 2.5m (8.2 ft.) P/N 91611799

Power relay cable 3 x 14 AWG, SJOOW
POWCON-POWCON 2.5m (8.2 ft.) P/N 91610176

Cables, 16 A, for power input

Power input cable 3 x 2.5 mm², H07RN-F
OPEN-POWCON 1.5 m (4.9 ft.) P/N 91611800

Power input cable 3 x 14 AWG, SJOOW
OPEN-POWCON 1.5 m (4.9 ft.) P/N 91610177

Power input cable 3 x 2.5 mm², H07RN-F
OPEN-POWCON 5.0 m (16.4 ft.) P/N 91611801

Power input cable 3 x 14 AWG, SJOOW
OPEN-POWCON 5.0 m (16.4 ft.) P/N 91610178

(H07RN-F are European approved cables, SJOOW are US approved cables)

Power connectors

Power Connector PowerCON MaleP/N 91611795

Power Connector PowerCON FemaleP/N 91611794

Related Items

Martin M-DMX with Martin Companion Uploader Software (see www.martin.com)

Ordering Information

RUSH BATTEN 1 HEX in cardboard box.....P/N 90480160

Specifications subject to change without notice. For latest product specifications, see www.martin.com



Disposing of this product

Martin™ products are supplied in compliance with Directive 2012/19/EC of the European Parliament and of the Council of the European Union on WEEE (Waste Electrical and Electronic Equipment), where applicable. Help preserve the environment! Ensure that this product is recycled at the end of its life. Your supplier can give details of local arrangements for the disposal of Martin products

Martin[®]
by HARMAN