

KUMO® Compact SDI Routers

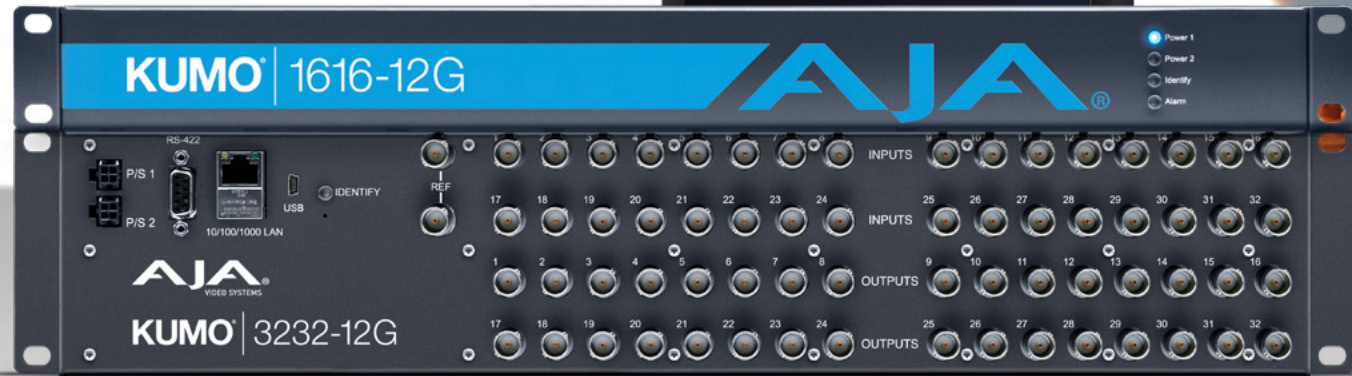



Compact Single Link 12G and 3G SDI Routers

Compact, robust and built for critical environments, KUMO 12G-SDI and KUMO 3G-SDI routers offer flexibility and quality that exceeds SMPTE specifications at an unprecedented price.

AJA's KUMO family of compact 12G and 3G-SDI routers provide high quality signal control that is ideal for facilities or space sensitive locations.

Cost effective, without compromising power or flexibility, KUMO compact SDI routers provide powerful signal control and support full broadcast specifications over either 12G-SDI or 3G-SDI with quality that exceeds SMPTE specifications. The super compact 1RU, 2RU and 4RU units are less than a few inches deep, making them a perfect fit for any broadcast, production, or post production environment.

Running embedded Linux®, KUMO routers are network ready and support full HTTP control and monitoring. KUMO's internal web server allows immediate installation, configuration, and operation with standard web browsers. KUMO CP networkable control panels operate in stand-alone or networked configurations enabling comprehensive control without the need of a computer, from anywhere on your LAN.

KUMO routers are easily integrated with existing infrastructure utilizing the REST API, the industry standard Grass Valley Native Protocol over RS-422 or even Ethernet. Ethernet network connectivity allows you to control KUMO routers from any web browser on a network connected device, ensuring you have the control you need.

As 8K emerges and 4K/UltraHD workflows continue to gain ground, KUMO routers can meet the rising challenge. KUMO 12G-SDI routers offer single link cable simplicity for 4K/UltraHD and with a simple

setting change, KUMO 12G-SDI routers can be configured for ganged dual-link or quad-link grouping allowing users to group together multiple inputs and outputs for 8K workflows and similarly, KUMO 3G-SDI routers for dual or quad-link 4K/UltraHD workflows. This allows routing of raw or 8K or 4K/UltraHD signals throughout a production, live event, OB truck or post facility.

Eight Salvos can be configured and stored in a KUMO router. Salvos allow the operator to quickly recall predefined sources to specific destinations configurations with a simple button press.

KUMO 12G-SDI routers are available in two configurations: 16x16 and 32x32. KUMO 3G-SDI routers are available in: 16x4, 16x16, 32x32 and 64x64.

KUMO compact SDI routers offer AJA reliability, flexibility and uncompromising signal quality, all at an unprecedented price. Built to the exacting standards of all AJA hardware, KUMO products are backed by our world class support network and five year international warranty.



Compact Routing

Just 1RU, 2RU or 4RU high and less than 2" deep, KUMO fits in the most space constrained locations, offering flexible routing with support for 12G-SDI or 3G-SDI I/O that exceeds SMPTE specifications.

The powerful crosspoint routing matrix allows the mapping of any input to any output. Signals can also be sent to multiple outputs without the need for additional patch panels or distribution amplifiers.

Designed for critical broadcast, production and post environments, KUMO hardware uses premium components coupled with dual redundant power supplies to ensure uptime in the unlikely event of a power supply failure.



Simple Configuration

KUMO 1616-12G and KUMO 3232-12G USB ports easily configure the router's IP address and simplifies network configurations. KUMO routers are network ready and support powerful HTTP control and monitoring via a web browser without the need for any additional software.

KUMO's auto-detect Bonjour®/Zeroconf protocols mean that network configuration is automatic, just connect KUMO to your network and the system will self configure, ready for use. Alternatively, standard network configuration allows access to each KUMO via its assigned IP address. Once connected to KUMO using a web browser, you can configure the full TCP/IP settings, select and name KUMO routers, name sources and destinations, and perform all operational functions.



KUMO Control Panels

KUMO CP control panels offer up to 32 source and 32 destination buttons for direct access to all KUMO inputs and outputs. Salvos support simplifies switching operations by recalling multiple sources to specific destinations. Salvos are stored in the KUMO router and can be recalled via the KUMO router's Web UI, Grass Valley Native Protocol over Ethernet, RS-232, and/or directly on the KUMO CP/CP2 Salvos buttons.

Connecting via Ethernet to the same network as KUMO routers, KUMO CPs enable full control from any location and up to four KUMO routers can be controlled from a single control panel. For stand-alone configurations, KUMO hardware can be connected directly via RJ-45 cables and KUMO software will automatically assigns routers to control panel delegations.



KUMO®



KUMO CP

KUMO CP is an optional 1RU control panel that can be used in stand-alone or networked configurations for 16x and 32x KUMO routers.

\$595 US MSRP*



KUMO CP2

KUMO CP2 is an optional 2RU control panel that can be used in stand-alone or networked configurations for all KUMO routers.

\$895 US MSRP*



KUMO 1616-12G

KUMO 1616-12G is a compact 1RU 12G-SDI router that allows multiple signal routing including full-bandwidth 8K/4K/UltraHD/HD/SD SDI video signals.

\$2,495 US MSRP*



KUMO 3232-12G

KUMO 3232-12G is a compact 2RU 12G-SDI router that allows multiple signal routing including full-bandwidth 8K/4K/UltraHD/HD/SD SDI video signals.

\$3,395 US MSRP*



KUMO 1604

KUMO 1604 is the right size for typical AV setups or corporate meetings where several different cameras, computers or other video devices need to be routed to a few monitors or projectors.

\$1,395 US MSRP*



KUMO 1616

For medium sized facilities and mobile trucks, KUMO 1616 is just the right size for combining multiple cameras, monitors, editing systems, tape decks and file-based recorders into a seamless workflow.

\$1,995 US MSRP*



KUMO 3232

As your routing needs grow, KUMO 3232 has the additional capacity you require, making it perfect for larger environments and high density applications.

\$3,495 US MSRP*



KUMO 6464

KUMO 6464 offers an incredible 64 inputs and 64 outputs of 3G-SDI video and embedded audio, while maintaining a slim and compact 4RU profile for any SDI based signal up to 3G-SDI, including HD and even 4K/UltraHD signals (quad mode).

\$7,995 US MSRP*

[Find a Reseller](#)

Control Panel Connections

KUMO Control Panel



[Click here](#)

For full product specifications visit www.aja.com/en/products/kumo-cp/#techspecs

Control Panel 2 Connections

KUMO Control Panel 2



[Click here](#)

For full product specifications visit www.aja.com/en/products/kumo-cp2/#techspecs

1616-12G Connections

KUMO 1616-12G

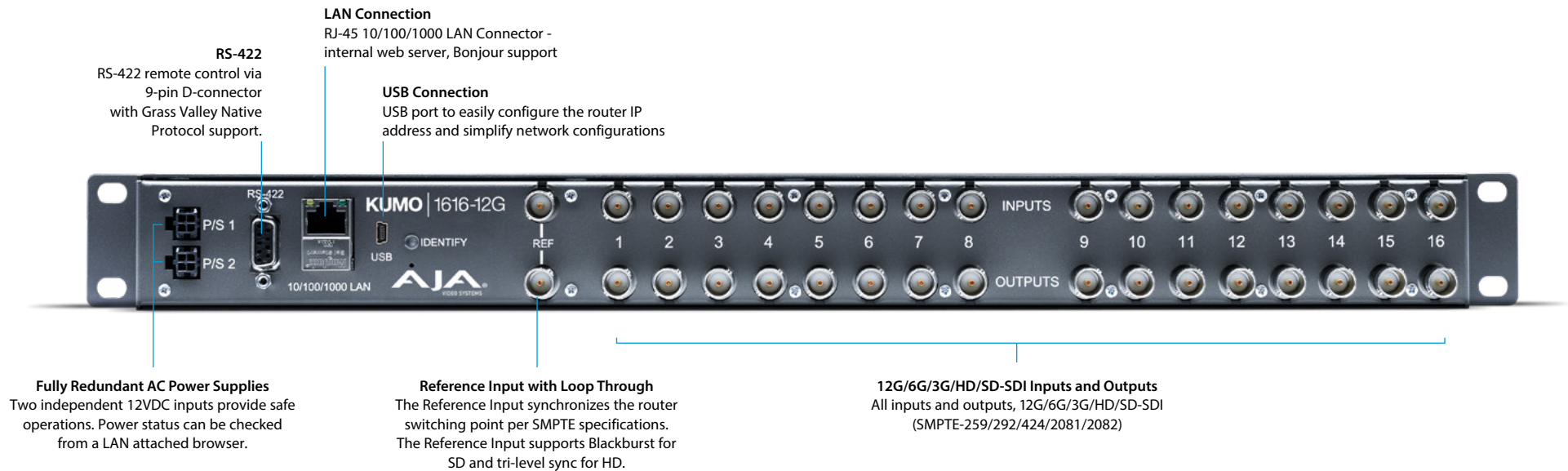

[Click here](#)

For full product specifications visit www.aja.com/en/products/kumo-1616-12G/#techspecs

3232-12G Connections

KUMO 3232-12G

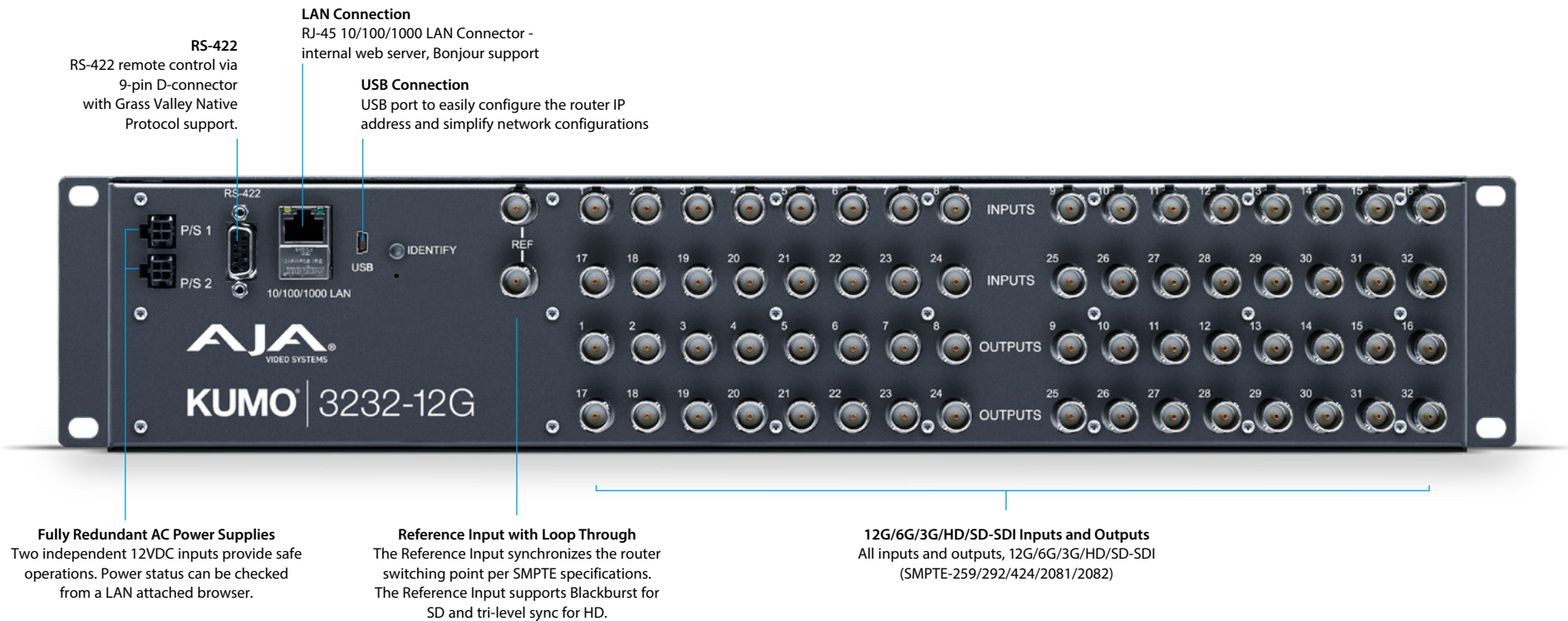

[Click here](#)

For full product specifications visit www.aja.com/en/products/kumo-3232-12G/#techspecs

1604 Connections

KUMO 1604

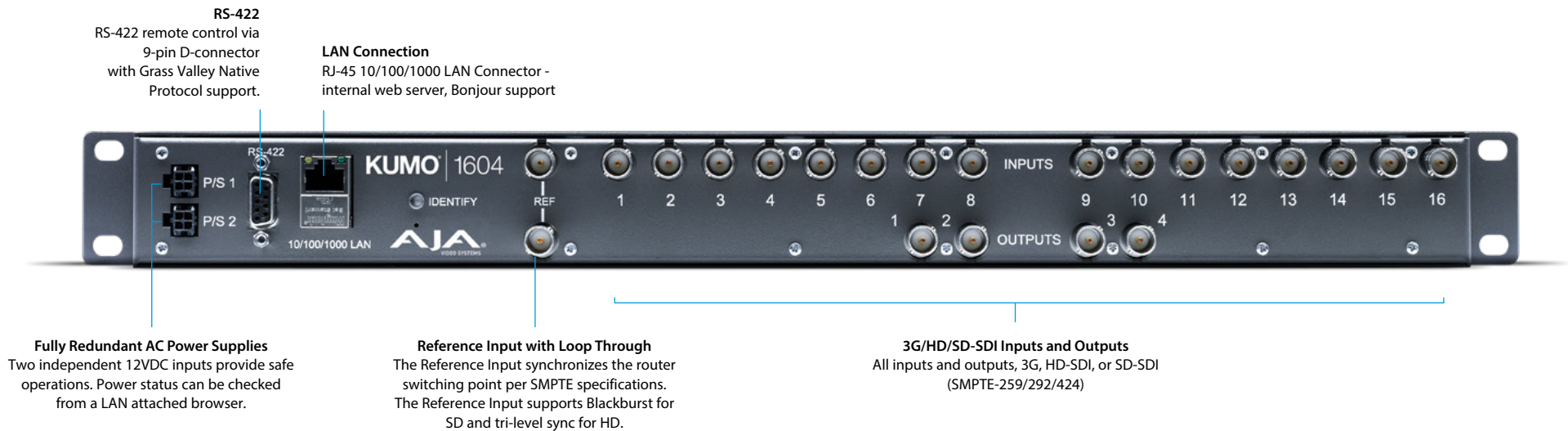

[Click here](#)

For full product specifications visit www.aja.com/en/products/kumo-1604/#techspecs

1616 Connections

KUMO 1616

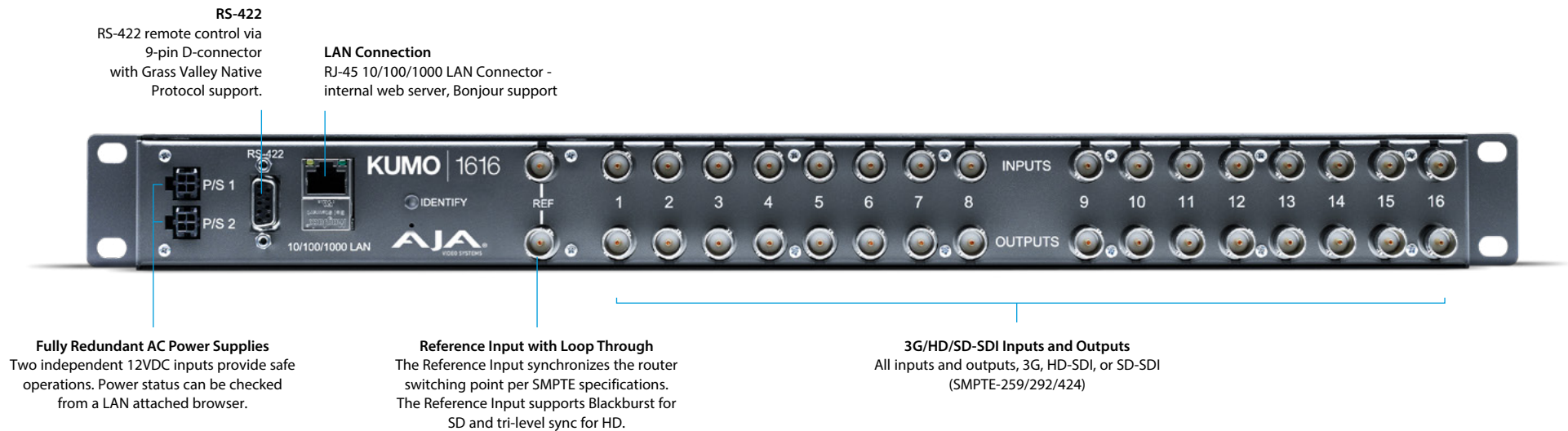

[Click here](#)

For full product specifications visit www.aja.com/en/products/kumo-1616/#techspecs

3232 Connections

KUMO 3232

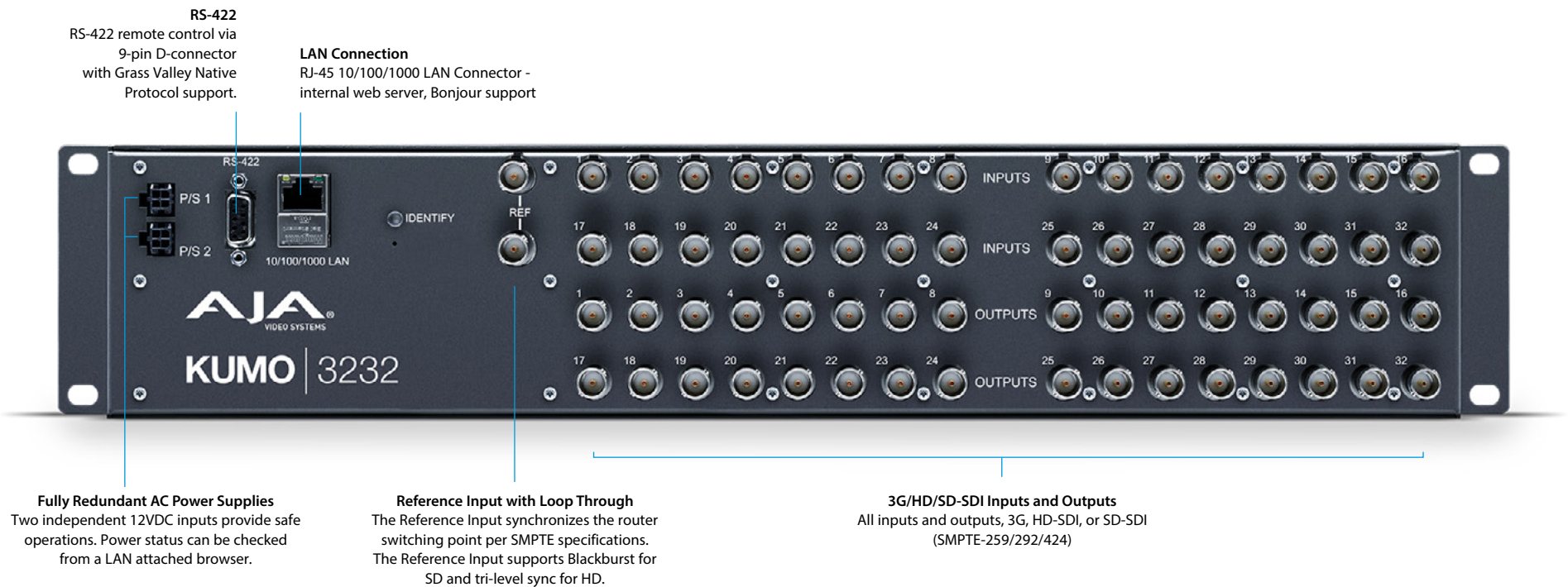

[Click here](#)

For full product specifications visit www.aja.com/en/products/kumo-3232/#techspecs

6464 Connections

KUMO 6464

RS-422
RS-422 remote control
with Grass Valley Native
Protocol support.

LAN Connection
RJ-45 10/100/1000 LAN Connector -
internal web server, Bonjour support

Reference Input with Loop Through
The Reference Input synchronizes the router switching point per
SMPTE specifications. The Reference Input supports Blackburst for
SD and tri-level sync for HD.



Fully Redundant AC Power Supplies
Two independent 12VDC inputs provide safe
operations. Power status can be checked
from a LAN attached browser.

3G-SDI Inputs and Outputs
All inputs and outputs, 3G, HD-SDI, or SD-SDI
(SMPTE-259/292/424)

[Click here](#)

For full product specifications visit www.aja.com/en/products/kumo-6464/#techspecs

Configurations

Stand-Alone Routing System - Zero Configuration, Just Plug, Power, and Play

KUMO Software assigns control to CPs based on KUMO router serial number order.

KUMO CPs

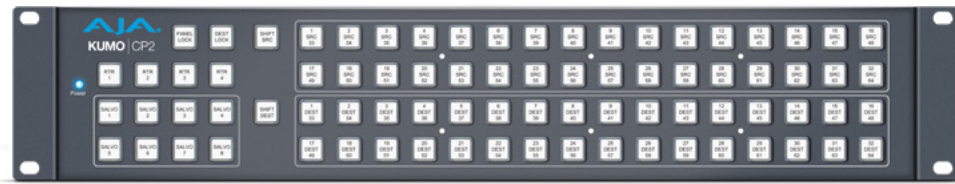

Each KUMO CP controls up to four KUMO Routers

KUMO Routers



Connect up to 16 Independent KUMO CP per individual KUMO Router

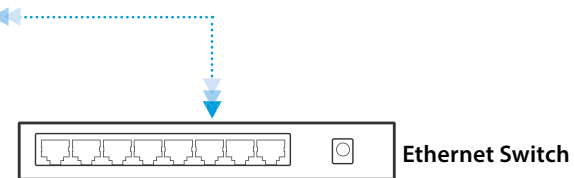

Configurations

LAN Only System - Use TCP/IP to Configure Routers and Devices



Control Unlimited KUMO Routers via TCP/IP

1. Use Bonjour to configure KUMO's TCP/IP settings
2. Control KUMOs from a web browser

Configurations

Hybrid System - KUMO's Controlled by KUMO CPs and Web Browsers

KUMO CPs

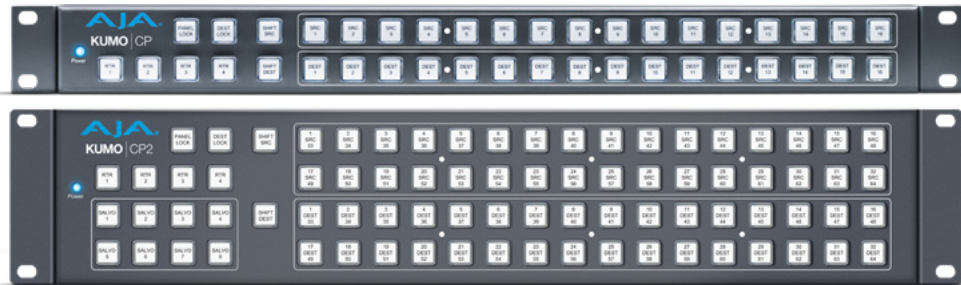

Each KUMO CP can control up to four KUMO routers at a time

KUMO Routers



Each KUMO router can be controlled by multiple CP panels

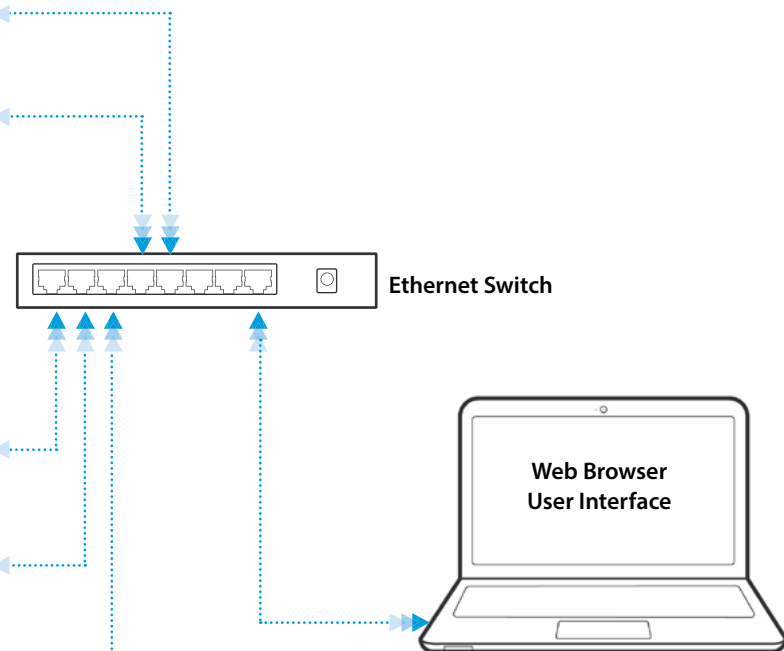

Control Unlimited KUMO Routers via TCP/IP

1. Use Bonjour to configure KUMO's TCP/IP settings
2. Control KUMOs from a web browser

Tech Specs

Video Formats

KUMO 12G Products

- 270 Mbps, 1.5 Gbps, 3 Gbps, 6 Gbps, 12 Gbps SDI
- 270 Mbps DVB-ASI
- Format agnostic, 125 Mbps - 12 Gbps

KUMO 3G Products

- 270 Mbps, 1.5 Gbps, 3 Gbps SDI
- 270 Mbps DVB-ASI
- Format agnostic, 125 Mbps - 3 Gbps

Video Input Digital

KUMO 12G Products

- 12G-SDI Inputs
- 12G-SDI BNC, SMPTE-259/292/424/2081/2082

KUMO 3G Products

- 3G-SDI Inputs
- BNC, SMPTE-259/292/424

Video Output Digital

KUMO 12G Products

- 12G-SDI Outputs
- Noninverting
- 12G-SDI BNC, SMPTE-259/292/424/2081/2082

KUMO 3G Products

- 3G-SDI Outputs
- Noninverting
- BNC, SMPTE-259/292/424

Salvo - All 12G and 3G KUMOs

- Up to 8 Salvos can be configured and saved in each KUMO router

Switching Modes - All 12G and 3G KUMOs

- Single, Dual, and Quad link modes
- Switches in vertical blanking per SMPTE RP-168

Reference Input - All 12G and 3G KUMOs

- External, 2x BNC
- Looping, nonterminating
- Blackburst or tri-level sync

Network Interface - All 12G and 3G KUMOs

- 1x RJ-45, 10/100/1000 Ethernet
- Supports AJA KUMO Ethernet control panels, direct connect or networked
- Grass Valley Native Protocol
- Embedded web server for remote control

Machine Control - All 12G and 3G KUMOs

- 1x DB-9 Female, RS-422
- RS-422, Grass Valley Native Protocol
- 9-pin D-connector pinout is as follows:

1	GND
2	TX-
3	RX+
4	GND
5	No Connection
6	GND
7	TX+
8	RX-
9	GND
Shell	GND

Size (w x d x h)

- KUMO CP2: 2RU - 17.4" x 1.3" x 3.5" (441.96 x 33.02 x 88.9 mm)
- KUMO CP: 1RU - 17.4" x 1.3" x 1.75" (441.96 x 33.02 x 44.45 mm)
- KUMO 3232-12G: 2RU - 17.4" x 1.54" x 3.50" (441.96 x 39.12 x 88.9 mm)
- KUMO 1616-12G: 1RU - 17.4" x 1.54" x 1.75" (441.96 x 39.12 x 44.45 mm)
- KUMO 6464: 4RU - 17.4" x 1.54" x 7.00" (441.96 x 39.12 x 177.8 mm)
- KUMO 3232: 2RU - 17.4" x 1.54" x 3.5" (441.96 x 39.12 x 88.9 mm)
- KUMO 1616: 1RU - 17.4" x 1.54" x 1.75" (441.96 x 39.12 x 44.45 mm)
- KUMO 1604: 1RU - 17.4" x 1.54" x 1.75" (441.96 x 39.12 x 44.45 mm)

Weight

- KUMO CP2: 2.1 lb (1.0 kg)
- KUMO CP: 1.2 lb (0.6 kg)
- KUMO 3232-12G: 4.6 lb (2.1 kg)
- KUMO 1616-12G: 1.4 lb (0.7 kg)
- KUMO 6464: 9.2 lb (4.2 kg)
- KUMO 3232: 4.6 lb (2.1 kg)
- KUMO 1616: 1.4 lb (0.7 kg)
- KUMO 1604: 1.2 lb (0.6 kg)

Power

- AC Adapter: 100-240VAC, 50/60 Hz, universal input
- 10-14VDC regulated, power supply required, included with purchase
 - KUMO CP2: 4W typ, 9.6W max
 - KUMO CP: 2.5W typ, 6W max
 - KUMO 3232-12G: 30W typ.
 - KUMO 1616-12G: 13W typ.
 - KUMO 6464: 32W typ, 36W max
 - KUMO 3232: 18W typ, 43.2W max
 - KUMO 1616: 13W typ, 21.6W max
 - KUMO 1604: 7W typ, 9.6W max

Environment

- Safe Operating Temperature: 0 to 40 C (32 to 104 F)
- Safe Storage Temperature (Power OFF): -40 to 60 C (-40 to 140 F)
- Operating Relative Humidity: 10-90% noncondensing
- Operating Altitude: <3,000 meters (<10,000 feet)

[Click here](#)

For full product specifications visit www.aja.com/en/products/kumo/#techspecs

Five Year Warranty

AJA Video warrants that KUMO routers will be free from defects in materials and workmanship for a period of five years from the date of purchase.

About AJA Video Systems, Inc.

Since 1993, AJA Video has been a leading manufacturer of video interface and conversion solutions, bringing high quality, cost effective digital video products to the professional, broadcast and postproduction markets.

AJA products are designed and manufactured at our facilities in Grass Valley, California, and sold through an extensive sales channel of resellers and systems integrators around the world. For further information, please see our website at www.aja.com