

CM-170

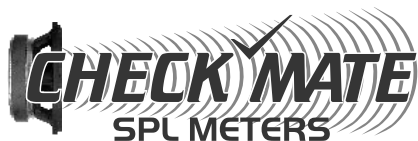

USER'S MANUAL



Data Logger SOUND LEVEL METER



www.galaxyaudio.com/products/CM-170



MAKERS OF THE ORIGINAL
HOT SPOT PERSONAL MONITOR

This page intentionally left blank



Contents

Introduction.....	1
Safety Information.....	2
Overview.....	3-4
Before Getting Started.....	5
Getting Started.....	6-7
Data Logger & Interval Setup.....	8-9
Setting The Date & Time.....	9
Calibration Procedure.....	10
Operating Precautions.....	10
Measurement.....	11
Using the PC Software.....	11-17
Frequently Asked Questions.....	18
Specifications.....	19

Introduction

Thank you for choosing the CM-170 Sound Pressure Level Meter. You have joined hundreds of thousands of other satisfied Galaxy customers. Since 1977 Galaxy Audio's professional experience in design and manufacturing ensure our products' quality, performance and reliability.

For the most up to date manual and information
visit www.galaxyaudio.com.

Safety Information:

Read the following safety information carefully before attempting to operate or service the meter.

Use the meter only as specified in this manual; otherwise, the protection provided by the meter may be impaired.

Environmental Operating Conditions

Altitude up to 2000 meters

Relative humidity 90% max.

Ambient Operating Temperature 0 ~ 40°C

Maintenance & Cleaning

Repairs or servicing not covered in this manual should only be performed by qualified personnel.

Periodically wipe the case with a dry cloth. Do not use abrasives or solvents on this instrument.

Safety Symbols



Complies with EMC

When servicing, use only specified replacement parts.

Overview

Described below, are the functions of the front panel control buttons and encoders for the CM-170.

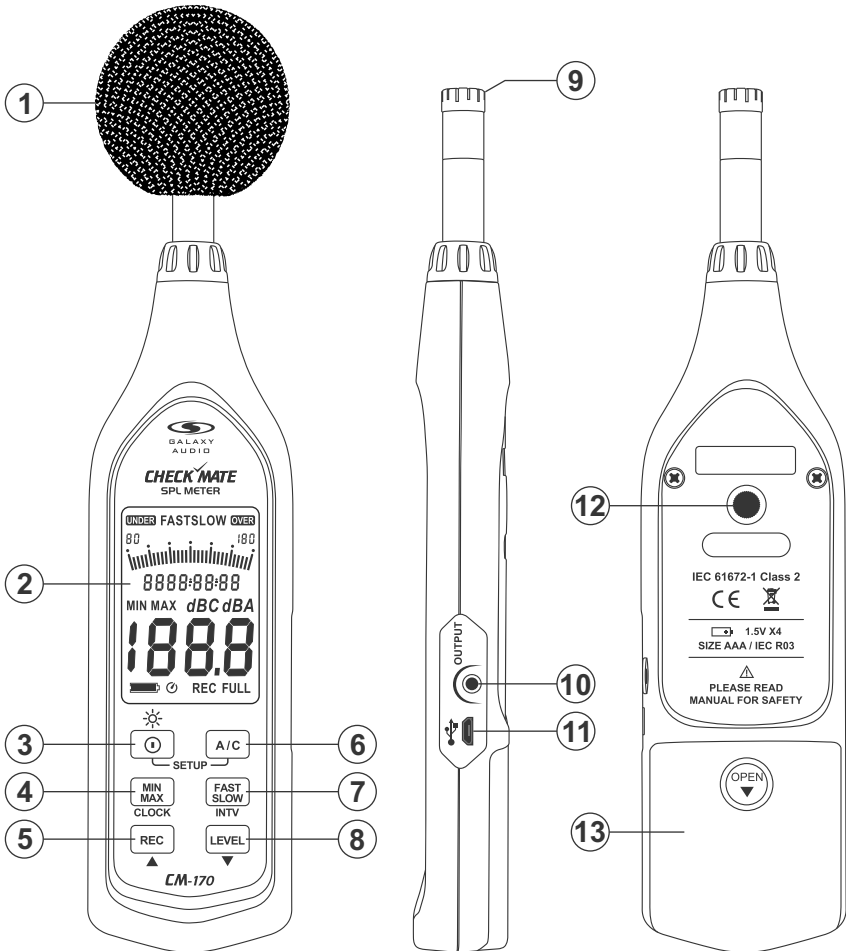

- ① Windscreen
- ② Display Screen
- ③ Power Button
- ④ MAX/MIN Button
- ⑤ REC Button
- ⑥ A/C Button
- ⑦ FAST/SLOW Button
- ⑧ Range Control Button
- ⑨ Microphone
- ⑩ AC/DC Signal Output Jack
- ⑪ USB Port
- ⑫ Tripod Mounting Thread
- ⑬ Battery Compartment

Display Screen:

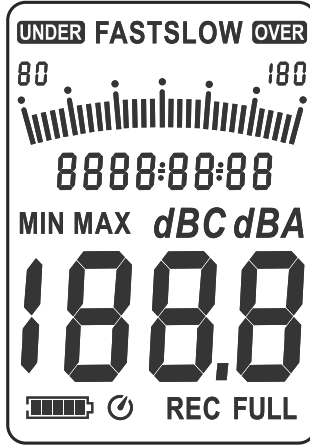

SYMBOL

FUNCTION



Battery Capacity Indicator



Auto Power Off Indicator

MIN MAX
FASTSLOW

Maximum/Minimum Indicator

80-180

Time Weighting Indicator



Level Range Indicator

8888:88:88

Bar Graph

dBC dBA

Time

188.8

Frequency Weighting Indicator

8888:88:88

Level Reading

OVER

Date

FULL

Over-Range Signal Indicator

REC

Memory Full

UNDER

Recording Data Logger Indicator

Under-Range Signal Indicator

Batteries:

1. Battery Loading:

Remove the battery cover on the back and insert four 1.5V AAA sized batteries. Pay attention to the polarity as indicated in the compartment.

Note:

It is possible to use size AAA rechargeable batteries, but a separate external charger must be provided for such batteries, since the unit is not designed to recharge batteries.

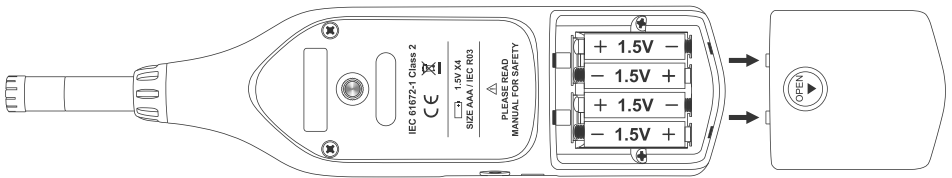

2. Battery Capacity Indicator:

When operating the unit on batteries, periodically check this indicator to determine the remaining battery capacity.



3. External Power Supply:

A USB Power Supply can be connected to the USB Port.

Note:



When the AC/DC adapter is connected, the unit will be powered from the adapter, as well as when batteries are inserted (The AC/DC adapter has priority).

1. Windscreen:



When making outdoor measurements, wind noise at the microphone can cause measurement errors. Such effects can be reduced by using the windscreen.

2. Display Screen.

3. Power Button:

Press the  button to turn the meter on. To turn the unit off, press and hold  button down until the screen shows “OFF 3, 2, 1,” then the LCD screen will turn off.

LCD Backlight On/Off:

Press  to turn on the LCD backlight. This makes it easier to read in dark environments. Press  again to turn off the backlight. The meter can also turn the backlight off automatically after 30 seconds to save battery power.



Auto Power Off:

To save battery life, by default, when the unit is powered on, it is in auto power mode. The unit will power itself off after 30 minutes if there is no key operation.

Auto power off will be disabled under the following circumstances:

- a. When connecting to a PC.
- b. When the recording function is in process.



Disable Auto Power Off:

Press and hold the  button and power on the meter. The  will not show up on the display, meaning “Auto Power Off” is now disabled.

Note: When the user powers on the unit, the LCD will show how much internal memory space is available to use.

4. MAX/MIN Button:

Press the  button to enter the maximum and minimum recording mode. Under this mode, the maximum value and minimum value will be stored and automatically updated in the memory.

Pressing the  button will display the “MAX” symbol and the maximum value on the display. Pressing the  button again will display the “MIN” symbol indicator and the Minimum value on the display. To exit the maximum and minimum mode, press and hold  button down until the “MAX MIN” symbol disappears.

5. **REC Button:**

When the button is pressed, recording will begin and the “REC” symbol will display. To stop the recording, press the **REC** button again.

6. **A/C Button:**

Sets the frequency weighting to A or C.

7. **FAST/SLOW Button:**

Sets the time weighting to Fast or Slow

8. **LEVEL Range Control Button:**

Each time you press the **LEVEL** button, the level range will rotate between “Lo” level, “Med” level, “Hi” level and “Auto” level.

9. **Microphone:**

1/2 inch electret condenser microphone.

10. **AC/DC Signal Output Jack:**

AC: 1 Vrms Corresponding to each range step. (with frequency weighting)
Output Impedance \approx 100 Ohms
Output Signal by standard 3.5mm coaxial socket signal on pin.

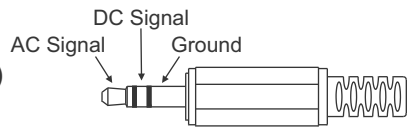

Note:

At “Auto” level range, output signal is Auto select on “Lo”, “Med”, or “Hi” level range.

DC: Output: 10mV/dB

11. **USB Port:**

Connection to a computer or external power supply input.

12. **Tripod Mounting Thread:**

For long-term measurements, the unit can be mounted on a camera tripod. Proceed carefully, to avoid dropping the unit.

13. **Battery Compartment.**

Data Logger & Interval Setup:

How to store data in memory.

Auto Store Interval Time Setup:

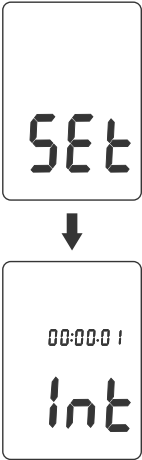

1. Press and hold “**A/C**” button and then power on the meter.
2. Press **INTV** (**FAST SLOW**) button, “**Int**” appears for interval, as well as a flashing second display.
3. Now set the desired recording interval in minutes and seconds. Press **▲** (**REC**) or **▼** (**LEVEL**) to increase or decrease the number. Maximum of 1 minute can be set, and the minimum value is limited to “00:01”(=1s). After setting has been performed, press the **INTV** (**FAST SLOW**) button once to get back to the display of the instantaneously measured values. If you want to abort during a setup process, press **⏻** button to cancel.

Auto Store:

Auto Store Interval Time Setup:

Pressing the **REC** button will start saving the measured values. The Values are stored in a memory location. Press **REC** button again to stop recording.

Note: During the recording period, most of the buttons such as the **A/C**, **FAST SLOW**, and **LEVEL** are inoperative. All other settings must be made before starting the recording operation.



The LCD will show “**FULL**” symbol when 64,000 recording intervals are stored in the memory.

Clearing Stored Data:



If you want to clear the memory, power off the unit, then press and hold the **REC** button and then press the **⏻** button and hold for at least 5 seconds. The LCD will then show “**CLR**” and “**SURE**” to clear the memory.









Note:

The battery indicator “” shows the remaining battery power. The number of black bars decreases as the battery runs out. When the power is almost empty, “” will disappear. Pressing the  button will cause the LCD display to show the “Lo bAt” warning indication. If the meter is under recording mode, it will stop.



Setting The Date & Time:

The unit incorporates a clock so that the data logger function can also record the date and time, along with the measurement value in the memory.

1. Turn the unit off.
2. Enter SETUP mode by pressing and holding the  button and then press the  power button to turn the unit on. “SEt” will then blink on the LCD display.
3. Press the **CLOCK** () button to set the clock.
4. Press the  () or  () buttons to adjust the year, then press the **CLOCK** () button to adjust the next values:
(Month > Date > Hour > Minute > Second)
5. When finished, press the **CLOCK** () button to exit the SETUP mode.

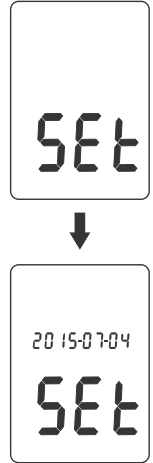

Note:

- a. To abort during the process, press the  power button to exit the SETUP mode.
- b. An internal rechargeable backup battery keeps the clock of the unit running. When the power is turned off, the backup battery is recharged by the main batteries. The clock will keep running for 30 minutes on the backup battery alone. If the unit is not to be used for an extended period of time, the main batteries should be taken out to prevent possible damage due to battery fluid leakage. After reinserting the batteries, be sure to set the date and time again.

Calibration Procedures:

1. Press and hold the **MIN MAX** button and then power on the meter. The LCD will display the “**⌈RL 94 dB**” symbol.
2. Insert the microphone housing carefully into the insertion cavity of the calibrator.
3. Press the **▲** (**REC**) or **▼** (**LEVEL**) button to increase or decrease the number.
4. Press the **MIN MAX** button to finish. If you want to abort during a setup process, press the **⏻** power button to cancel.

*Our products are all well calibrated before shipment. It's recommended to re-calibrate every 1 year.

Operating Precautions:

1. Wind blowing across the microphone can greatly affect the reading. When using the meter in the presence of wind, it is advised to use the included windscreen.
2. Calibrate the meter before operation if the meter has not been in use for a long period of time or if operated in a bad environment.
3. Do not store or operate the meter in a high temperature and high humidity environment.
4. Keep the microphone dry and avoid severe vibration.
5. Please take the batteries out and keep the meter in a low humidity location when not in use.



Measurement:

1. Turn the power on and select the desired response Time and Frequency Weighting. If the sound source consists of short bursts or only catching sound peak, set response to FAST. To measure average sound level, use the SLOW setting. For general noise sound level, select A-weighting. For measuring sound level of loud sounds with high bass content, select C-weighting.
2. Hold the meter comfortably in your hand, or fix to a tripod, and point the microphone at the suspected noise source. The sound pressure level will then be displayed.
3. When MAX/MIN (maximum, minimum hold) mode is chosen, the meter captures and holds the maximum and minimum noise level for a long period, using any of the time weightings. Press and hold the  button for 2 seconds to clear the maximum and minimum reading. The “MIN/MAX” symbol will disappear.

Using the PC Software

CM-170 Setup Using USB Interface Software:

The SE323 Software Package Contains:

1. Installation CD
2. Micro USB Cable

System Requirements:

Windows XP / VISTA / 7 / 8 / 10

System Requirements:

PC or NoteBook with CD-ROM, or download the software online.
At least 50 MB hard disk space available to install SE323 Software.

Installing the SE323 Software:

1. Insert the setup CD disk into CD disk drive. Windows will run the setup.exe automatically.
2. If Windows fails to run the setup.exe automatically, click the start button on the Taskbar and select Run. Type E:\SETUP and choose OK. If you can't find Run, open up “My Computer” from the start menu and double click the drive from there.

3. Follow the instructions to finish the installation.
4. It will copy the SE323.exe (executable file) and “help” file to your hard disk (default is :\\program files\\SE323).

For other detailed operation instructions, please refer to the online help while executing the SE323 Software.

Main Menu:

File:

Open - Retrieve files.

Save - Save the active window (when the caption bar is highlighted) data to file.

Print - Print the graph of the active window.

Printer Setup - Select the printer to print from.

Exit - Closes the SE232 Program.

Real-Time:

Run - Start collecting real-time data.

Stop - Stop collecting real-time data.

Data Logger:

Load Data - The user can load recorded data from the meter onto the PC.

Erase Memory - The user can erase the memory off their connected Sound Pressure Level Meter.

View:

Control Panel - By opening the Control Panel Window, the user can control the meter via the buttons shown in this window.

Real-Time Graph - Opening the Real-Time Graph will display the present data.

Graph:

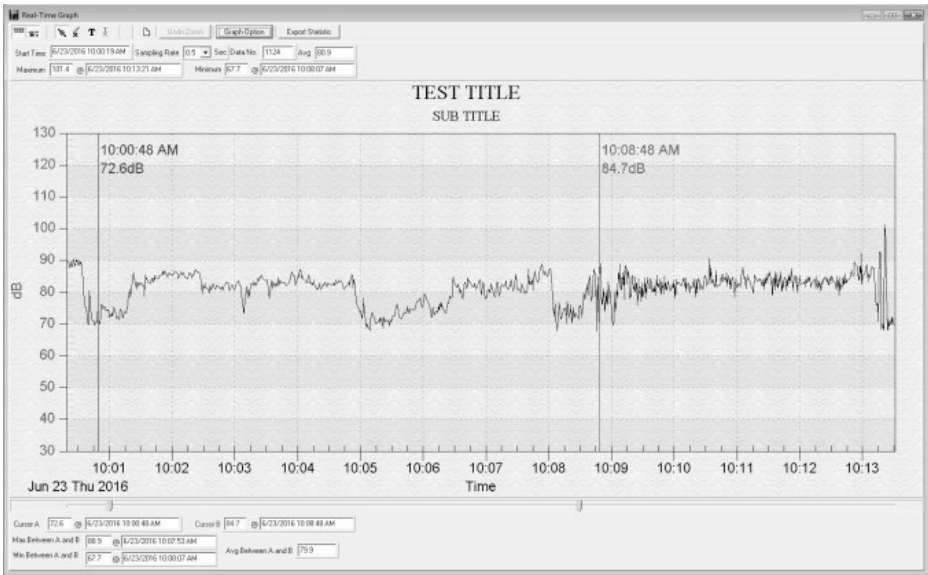

Tool Bar:



- Display or hide Graph Statistic.



- Display or hide Line Cursor Statistic.



- Normal Cursor.



- When selected, the mouse cursor will become an " X " sign when moving to the graph. Click on the graph to mark an " X " sign on the graph.



- When selected, the mouse cursor will become an " I " sign when moving to the graph. Click on the graph to annotate.



- When selected, a window will pop up with a list of annotations that can be removed all at once, or one at a time.



- Clicking this will clear the graph.

You can choose a rectangle area on the graph to zoom in for detail. There are two vertical lines, “Cursor A” (Blue) and “Cursor B” (Red) in the graph. There are time and value displays on the top and right side of each cursor. You can move the mouse cursor over Cursor A or B and click to drag the Cursor left or right. Below Cursor A and B is a slider that you can click and drag to move Cursor A or B.

Below the slider are the Statistics. It displays start time, sampling rate, data number, and the maximum and minimum of the graph. The statistics also display the maximum, minimum, and average between cursor A and B. These will update automatically when moving Cursor A or B.

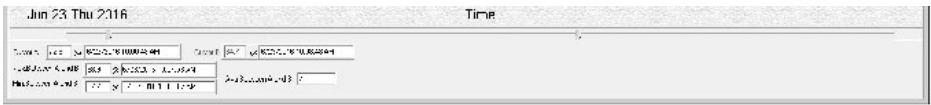

When on the Normal Cursor, you can double click on the graph to open the customization window. You can also click on the “Graph Option” **Graph Option** button at the top of the window. In the customization window, you can customize your graph style.

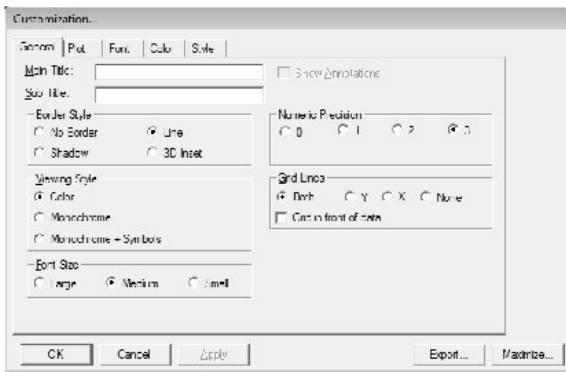

Zoom:

You can Zoom in on an area on the graph by using the mouse.

To Zoom:

1. Left click and hold.
2. Drag the cursor to select the area you want to zoom in on.
3. Release the mouse button for the zoom to take effect.

To Undo Zoom:

1. Click on the “Undo Zoom” button at the top of the window.



Data Logger:

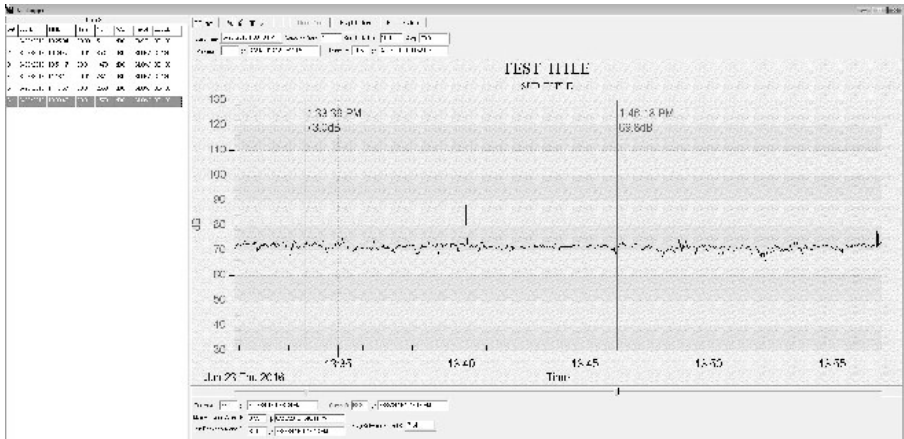

Example:

Connect the Sound Level Pressure meter to the PC. Select “Data Logger” from the main menu drop-down or click  from the tool bar to load recorded data from the meter. There will be a progress indicator to show the loading progress.

Data Logger						
Data Set						
Set	Date	Time	Rate	A/C	Fast/Slow	Level
1	6/20/2016	10:38:14	00:01	5	48	FAST 00:00
2	6/20/2016	10:38:47	00:01	650	49C	SLOW 00:00
3	6/20/2016	10:39:14	00:01	14:0	48L	SLOW 00:00
4	6/20/2016	11:48:10	00:01	767	48	SLOW 00:00
5	6/20/2016	11:47:57	00:01	2050	49C	SLOW 00:00
6	6/20/2016	11:53:06	00:01	160	48L	SLOW 00:00

If an error occurs, just click the “Data Logger” again. After the data has loaded, the left-hand side will show how many data sets were loaded and detailed information for each data set (Data set, Date, Time, Rate, Numbers, A/C, Fast/Slow, and Level).

The first data set will transfer to the graph and tabular on the right-hand side every time after loading recorded data from the Sound Level Meter. You can click on any data set to change the set for the graph.

On the right-hand side, set the waveform graph and statistical information of the data set you chose as you refer to the graph.

Tutorial - Quick Start to Using the CM-170:

1. Recording Real-Time Data in Waveform:

a. Power on the Sound Level Meter first, then connect it to a PC USB Port with the cable.

b. Start the SE323 Program.

c. If the connection is successful, the panel will display the same value as the Sound Level Meter. If it fails to connect the meter with the PC, it will display “No Connection” on the panel window in the software.



d. When the connection is successful, click  to start recording real-time data. There will be a waveform on the Real-Time Graph Window.

e. Click  to stop recording.

2. How to Save the Recorded Real-Time Data to a File:

a. Click the graph window you want to save, and the graph window will become active. Then click the File drop-down from the main menu bar and select Save or click  from the tool bar.

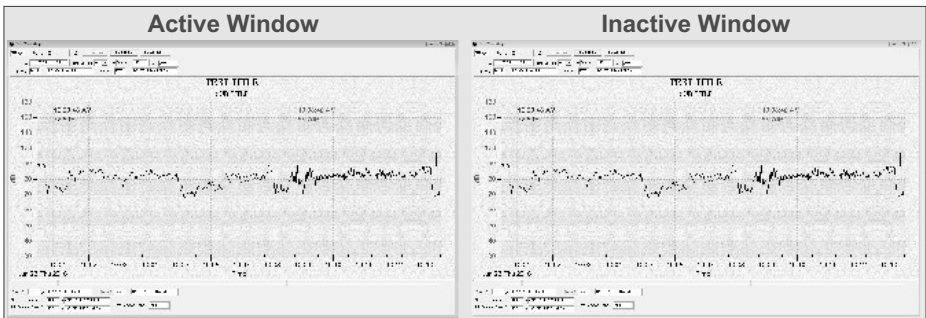

b. There will be a save dialog window for you to choose the file name and file type to save. There are three types of file formats you can choose: binary file (*.ghf), text file (*.txt) and EXCEL file (*.csv). The *.ghf file uses the least file space but can only be used in the SE323 software.

The text file can be opened by the SE323 software and other word processing programs like word, notepad, etc. The EXCEL formatted file can be opened by the SE323 software and the Microsoft EXCEL program.



3. How to Load the Recorded Data from the Memory of the Sound Level Meter and save it to a file:

(Only for the model with Data Logging)

- Power on the Sound Level Meter.
- Press the REC button of the meter to start recording data.
- After a while, press the REC button again to stop recording data.
- Connect the Sound Level Meter to the PC.
- Start the SE323 Program.
- Choose Data Logger from the main menu or click  from the tool bar.

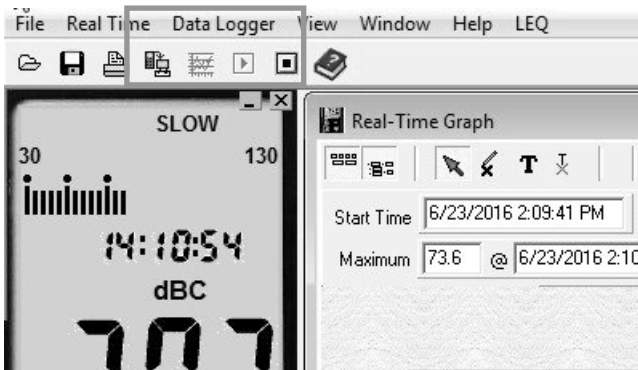

- In reference to the Data Logger, see Data Logger on page 8.

Frequently Asked Questions:

- 1. How can I save the graph to a file which can be used in EXCEL?**
Answer: When you save a graph to a file, the default file format is (*.ghf). You need to select the file format (*.csv) in order to save as a useable format for EXCEL.
- 2. How do I uninstall the SE323 Software?**
Answer: Uninstall the SE323 software by launching the “**Add/Remove Programs**” applet out of the Control Panel. For some systems you may need to go to:
Control Panel > Programs > Uninstall a program. Highlight SE323 and click on “Add/Remove”, or “Uninstall” depending on the PC system. It will then remove the SE323 folder and files from your computer.
- 3. How do I zoom in on the graph?**
Answer: Click the left mouse button, hold, and drag the cursor to select the area to be zoomed in on, then release the mouse button.
- 4. When I set up the real-time sampling with a fast rate, some of the sampling data might be lost.**
Answer: This might be caused by a slow response time of the PC.
- 5. I get erratic readings outside.**
Answer: Use the windscreen to prevent the wind from interfering with the measurement.
- 6. Is there an AC adapter for the CM170?**
Answer: The CM170 can be powered via the USB, this will not however, charge batteries.
- 7. My CM-170 keeps shutting off after a while.**
Answer: To save battery life, there is an auto shut off after 30 minutes of not touching any buttons this is bypassed when connecting to a PC, or while logging.

Specifications:

Standard: IEC 61672-1 Class 2, ANSI S1.4 Type 2

Microphone: 1/2" Electret Condenser Microphone

Accuracy: ± 1.4 dB (under reference conditions, 94 dB @ 1 kHz)

Display: Liquid Crystal Display

Digital Display: 4 Digits

Resolution: 0.1 dB

Display Update: 0.5 sec.

Analog Display: 30 Segment Bar Graph

Resolution 2 dB

Display Update: 50 mS

Measuring Level Range: 30 ~ 130 dB

Level Ranges: Lo: 30 - 90 dB

Med: 50 - 110 dB

Hi: 70 - 130 dB

Auto: 30 - 130 dB

Auxiliary Outputs: AC Signal Output, 1 Vrms at FS (Full Scale)

(FS: Means the upper limit of each level range.)

DC Output: 10mV / dB

Frequency Weighting: A / C

Time Weighting: FAST, SLOW

Dynamic Range: 60 dB

Frequency Range: 20 Hz ~ 8 kHz

Alarm Function: "OVER" is when input is more than upper limit of range.

"UNDER" is when input is less than lower limit of range.

Data Logging Capacity: 64,000 Records

Power Supply: 4 AAA, NEDA 24A, IEC LR03 Batteries

Battery Life: Approximately 24 hrs (alkaline battery)

Power Consumption: Approx. 0.2 W

External Power Supply: 5 VDC (micro USB plug)

Operation Temperature: 0C° to 40C° (32F° to 104F°)

Operation Humidity: 10 to 90% RH

Storage Temperature: 10C° to 60C° (14F° to 140F°)

Storage Humidity: 10 to 75% RH

Dimensions: 10.4" x 2.5" x 1.1" (264 x 63 x 29 mm)(LxWxH)

Weight: 0.54 lb (8.642 oz)

This page intentionally left blank



This page intentionally left blank





MAKERS OF THE ORIGINAL
HOT SPOT PERSONAL MONITOR



www.galaxyaudio.com

THREE YEAR LIMITED WARRANTY

WARRANTY Information can be viewed online at
<http://www.galaxyaudio.com/support/warranty>



www.galaxyaudio.com/support/warranty

CM-170 USER'S MANUAL

Specifications in this manual are subject to change without notice.
For the most up to date manual and information
visit www.galaxyaudio.com.

1-800-369-7768 www.galaxyaudio.com

© Copyright Galaxy Audio 2016

Printed in Taiwan

V20160824