

VP-796(A)(ASV) / VP-797A(ASV) / VP-798ASV

User's Manual





COPYRIGHT

This document and the software described within it are copyrighted with all rights reserved. Under copyright laws, neither the documentation nor the software may be copied, photocopied, reproduced, translated, or reduced to electronic medium or machine readable form, in whole or in part, without prior written consent of Kramer UK Ltd ("Kramer"). Failure to comply with this condition may result in prosecution.

Kramer does not warrant that this product package will function properly in every hardware/software environment.

Although Kramer has tested the hardware, firmware, software and reviewed the documentation, KRAMER MAKES NO WARRANTY OR REPRESENTATION, EITHER EXPRESS OR IMPLIED, WITH RESPECT TO THIS HARDWARE, FIRMWARE, SOFTWARE OR DOCUMENTATION, THEIR QUALITY, PERFORMANCE, MERCHANTABILITY, OR FITNESS FOR A PARTICULAR PURPOSE. THIS SOFTWARE AND DOCUMENTATION ARE LICENSED 'AS IS', AND YOU, THE LICENSEE, BY MAKING USE THEREOF, ARE ASSUMING THE ENTIRE RISK AS TO THEIR QUALITY AND PERFORMANCE.

IN NO EVENT WILL KRAMER BE LIABLE FOR DIRECT, INDIRECT, SPECIAL, INCIDENTAL, OR CONSEQUENTIAL DAMAGES ARISING OUT OF THE USE OR INABILITY TO USE THE SOFTWARE OR DOCUMENTATION, even if advised of the possibility of such damages. In particular, and without prejudice to the generality of the foregoing, Kramer has no liability for any programs or data stored or used with Kramer software, including costs of recovering such programs or data.

Copyright (c) 2017 All World-wide Rights Reserved

All trademarks acknowledged

Kramer operates a policy of continued product improvement, therefore specifications are subject to change without notice as products are updated or revised.

E&OE.



Table of Contents

TABLE OF CONTENTS	3
LIST OF FIGURES	5
LIST OF TABLES	5
SAFETY WARNINGS	6
1. INTRODUCTION	7
1.1 SYSTEM OVERVIEW	7
1.2 PACKING LIST	9
2. BASIC SWITCHER SET-UP	10
3. SYSTEM DESCRIPTION	13
3.1 FRONT PANEL LAYOUT	13
3.2 REAR PANEL LAYOUT	15
3.3 INPUT CONNECTOR OVERVIEW	16
3.4 OUTPUT CONNECTOR OVERVIEW	16
4. PRODUCT SPECIFICATION	17
4.1 POWER SUPPLY REQUIREMENT	17
4.2 INPUT SPECIFICATIONS	17
4.2.1 <i>Composite Inputs</i>	17
4.2.2 <i>Component Video Inputs</i>	17
4.2.3 <i>3G-SDI Input</i>	17
4.2.4 <i>Computer (SVGA) Inputs VESA formats</i>	17
4.2.5 <i>HDMI-3 & DVI Inputs</i>	18
4.2.6 <i>HDMI-1 & HDMI-2 Inputs</i>	18
4.2.7 <i>DP Input</i>	18
4.2.8 <i>HDBT Input</i>	18
4.3 OUTPUT SPECIFICATIONS	19
4.3.1 <i>3G-SDI Output</i>	19
4.3.2 <i>HDMI & DVI Outputs</i>	19
4.3.3 <i>HDBT Output</i>	19
4.3.4 <i>HDCP Output encryption</i>	19
4.3.5 <i>Audio Output</i>	20
4.4 ANALOG AUDIO	20
4.5 VIDEO FORMATS	21
4.6 COMMUNICATIONS SPECIFICATION	22
4.6.1 <i>TCP/IP Port</i>	22
4.6.2 <i>Serial Connector pinout and RS-232 Configuration Settings</i>	22
5. UNIT CONTROL	23
6. FRONT PANEL CONTROL	23



6.1	INPUT	24
6.1.1	Input Selection	24
6.1.2	Input Config.....	25
6.1.3	Colour Adjustments.....	30
6.1.4	Geometry	31
6.1.5	Enhancement	35
6.2	OUTPUT.....	36
6.2.1	Display Type.....	36
6.2.2	Gamma/Colour/Crush.....	38
6.2.3	Output Config.....	39
6.2.4	Video Wall.....	40
6.3	LED SCREEN SETUP.....	42
6.3.1	Few words about Aspect Ratio	43
6.3.2	Splicing Zoom.....	43
6.3.3	Splicing Width / Splicing Height.....	44
6.3.4	Splicing Horizontal Position (Splicing H-pos) / Splicing Vertical Position (Splicing V-pos).....	44
6.3.5	Splicing Setup.....	44
6.3.6	Standard Splicing	45
6.3.7	Advanced Splicing	47
6.4	SYSTEM.....	50
6.4.1	User.....	50
6.4.2	Names/Profiles.....	50
6.4.3	Menu Settings.....	50
6.4.4	Network Settings.....	52
6.4.5	Security Settings.....	52
6.4.6	Factory Defaults.....	52
6.5	AUDIO	53
6.5.1	Mic 1,2 Level, Mix, Mute.....	53
6.5.2	Balance, Treble, Bass	53
6.5.3	Audio Setup.....	53
6.6	STATUS.....	56
7.	WEB BROWSER CONTROL	57
7.1	CONNECTING TO THE UNIT	57
7.2	WEB PAGE MENU ORIENTATION.....	58
7.3	SOFTWARE UPDATE	61
7.4	BACKUP AND RESTORE.....	61
7.5	LOGO AND CUSTOM TEST PATTERN CAPTURE	62
8.	FIRMWARE UPDATE.....	63
8.1	USB UPDATE	63
8.2	WEB BROWSER UPDATE	63
8.3	SYSTEM RESTORE FROM AN IMAGE FILE	63
9.	ENVIRONMENTAL AND EMC	65
9.1	RECOMMENDED OPERATING CONDITIONS	65
9.2	STORAGE.....	65
9.3	CE AND FCC COMPLIANCE	65
9.4	PAT TESTING	65



APPENDIX A: FRONT PANEL MENU TREE STRUCTURE.....	66
INPUT.....	67
OUTPUT.....	72
LED SCREEN SIZING.....	74
PIP MENU.....	75
SYSTEM.....	77
APPENDIX B: FRONT PANEL AUDIO MENU TREE STRUCTURE.....	79
APPENDIX C : SINGLE LINK DVI-U PINOUT.....	84

List of Figures

Figure 1: Picture Format Examples.....	32
Figure 2: 2x2 Video Wall example.....	41
Figure 3: Simple LED Screen Sizing Example.....	42
Figure 4: Maintaining the Aspect Ratio Example.....	43
Figure 5: Standard Splicing - 2x1 example (pre-split source).....	45
Figure 6: Standard Splicing - 2x1 example (common source).....	46
Figure 7: 2x1 Advanced LED Screen Splicing example.....	47
Figure 8: Advanced Splicing - 3x1 example.....	48
Figure 9: Advanced Splicing - 1x2 example.....	49

List of Tables

Table 1: Table of Models.....	8
Table 2: Embedded HDMI & SDI Output Audio Formats.....	20
Table 3: Supported Video Formats.....	21
Table 4: Serial Connector Pinout.....	22
Table 5: RS-232 communication settings.....	22
Table 6: I/O Lock behaviour.....	37



SAFETY WARNINGS

- THERE ARE NO USER SERVICEABLE PARTS WITHIN THE UNIT. REMOVAL OF THE TOP COVER WILL EXPOSE THE USER TO DANGEROUS VOLTAGES. DO NOT OPERATE THE UNIT WITHOUT THE TOP COVER INSTALLED.
- ENSURE THAT ALL ELECTRICAL CONNECTIONS (INCLUDING THE MAINS PLUG AND ANY EXTENSION LEADS) COMPLY WITH ELECTRICAL SAFETY REGULATIONS.
- CONNECT ONLY LOW VOLTAGE ISOLATED CIRCUITS TO THE INPUT AND OUTPUT CONNECTORS. IF ANY QUESTIONS REGARDING THIS ISSUE, PLEASE CONSULT QUALIFIED SERVICE PERSONNEL.
- TO PREVENT SHOCK OR FIRE HAZARD DO NOT EXPOSE THIS EQUIPMENT TO RAIN OR MOISTURE. IF SUCH EXPOSURE OCCURS, REMOVE THE POWER CABLE FROM THE MAINS OUTLET AND HAVE THE EXPOSED UNIT CHECKED BY QUALIFIED SERVICE PERSONNEL.
- DO NOT OPERATE THE EQUIPMENT IF IT APPEARS THAT IS NOT OPERATING NORMALLY, OR IF IT IS DAMAGED IN ANY WAY. REMOVE THE POWER CABLE FROM THE MAINS OUTLET AND CONSULT QUALIFIED SERVICE PERSONNEL.
- DO NOT REMOVE ANY FIXED COVERS UNLESS YOU ARE A QUALIFIED SERVICE PERSONNEL. ALWAYS DISCONNECT THE POWER CABLE FROM THE MAINS OUTLET BEFORE ANY COVER IS REMOVED.
- THIS EQUIPMENT CONTAINS NO USER SERVICEABLE PARTS. REFER ALL SERVICING AND MAINTENANCE TO QUALIFIED SERVICE PERSONNEL.



1. Introduction

This manual explains how to operate your VP-796(A)(ASV) / VP-797A(ASV) / VP-798ASV Scaler-Switcher.

If you have any questions relating to this or any other product supplied by Kramer please visit our web site www.kramerav.com.

1.1 System Overview

The VP-796(A)(ASV) / VP-797A(ASV) / VP-798ASV series of products feature excellent image processing algorithms for the very best in scaling, motion-adaptive de-interlacing and automatic film 3:2 and 2:2 pull-down correction. The new generation of Kramer products significantly outperforms the capabilities of benchmark competitor products.

In addition to full 4K processing, new and unique technology allows for seamless switching between different inputs as fast as ¼ of a second.

VP-796(A)(ASV) / VP-797A(ASV) / VP-798ASV feature with a flexible, high performance video input front end that allows them to accept and process a wide variety of inputs. HDMI, DVI and Display Port video with HDCP encryption is supported, as are computer graphics inputs in SVGA analogue and HDMI/DVI digital formats. Analogue support also includes true component video in YPbPr and RGBS formats as well as composite (CVBS) inputs.

A high performance video decoder is utilized with 4x oversampling and 3D Y/C separation for outstanding video image clarity. The output frame rate can lock to the input frame rate dynamically without frame rate conversion in order to reduce system latency; or it can be set to a fixed output frame rate, e.g. for driving basic screens which are not 50Hz-compatible. The output format can also lock to an externally provided synchronization signal on various models (see model matrix). 3GSDI/HDSDI/SDI digital formats are supported on VP-797 and VP-798 (see model matrix below).

Outputs are available in HDMI/DVI digital formats as well as 3GSDI and HDBaseT (see model matrix below). All outputs are active simultaneously, except in the cases where the formats are not compatible. For example, for the PC graphic formats that are not supported by the SDI standards, the 3GSDI output will be disabled. Also note that if an HDCP encrypted signal is connected to the DP, HDMI or DVI input, the HDMI and DVI output signals will be similarly HDCP encrypted and the 3GSDI output will be disabled. HDCP capability can be switched off per input, so that a source can transmit non-protected content material.

The Pan, Tilt and Zoom (PTZ) feature allows users to select a 'region of interest', ROI, of the input image to fill the screen and pan and tilt within it.

The Video Wall feature allows multiple units to work synchronously and be part of a large matrix configuration, up-to 4x4. Each unit automatically crops a section of the input video image and displays it on the corresponding projector or screen.

All units can be operated via the front panel display and rotary knob, or through a built-in web page, or via an API interface. The API manual is published separately and is available on our website.



VP-796A, VP-796ASV, VP-797A, VP-797ASV and VP-798ASV models include 8 stereo audio inputs and two microphone inputs with Phantom Power. An embedded audio mixer allows mixing of the mic inputs to any analog or digital audio signal. Units fitted with Audio include a 30W stereo audio power amplifier allowing direct connection to loudspeakers. Separate line level outputs are also provided for connecting to external amplifier systems.

In addition to audio, VP-796ASV, VP-797ASV and VP-798ASV supports H.264 HD Streaming Video Input via the network port. A dedicated button on the front panel allows users to select the streaming video input.

The VP-789ASV model provides support for LED walls. This models includes a dedicated menu allowing users to easily and quickly define the area within the output raster where the scaled image will be placed. This area is defined to match exactly the size of the LED wall. The image can be reduced to an area as small as 128x96 pixels.

In system configurations where multiple units are driving large LED walls, a unique splicing menu allows users to select the portion of the input image that each unit will process. Although the input image will be processed by multiple units, the resulting image on the LED wall will be seamless and whole. No motion artefacts such as tears will appear between the different LED sections, because the outputs of all units are perfectly synchronised together. The software allows the wall to be split in equal or unequal parts.

Table 1: Table of Models

	Models	Basic Config.	HDBT 4K	3G-SDI Genlock PiP	Audio	Streaming Video	LED Sizing Custom Res. Color Crush
1	VP-796	✓	✓				
2	VP-796A	✓	✓		✓		
3	VP-796ASV	✓	✓		✓	✓	
4	VP-797A	✓	✓	✓	✓		
5	VP-797ASV	✓	✓	✓	✓	✓	
6	VP-798ASV	✓	✓	✓	✓	✓	✓

Basic Configuration:

Inputs:

- 2xHDMI 4K
- 1xHDMI HD
- 1xDisplayPort 4K
- 1xVGA
- 1xCVBS
- 1xDVI-U

Outputs:

- 1xHDMI 4K
- 1xDVI/HDMI



1.2 Packing List

- 1) 3 pin plug IEC mains cable
- 2) CD (w/ documentation)
- 3) Quick Start Guide (QSG)

2. Basic Switcher Set-Up

Inspect the shipping box and make sure that no damage was caused during transportation. If you see any damage, immediately contact the shipping carrier. Remove the unit, power cord, CD and QSG from the shipping carton. Inspect the unit and ensure that there is no damage caused during shipping.



You can install the unit on a clean flat surface or on an equipment rack using the rack-mount ears. The unit should always be installed in a well ventilated, static free environment and close to the AC power source. Max. operating temperature is 0°C to 40°C and 5% to 95% non-condensing humidity.



Connect the display device (Monitor, Projector, etc.) to one of the output connectors DVI/HDMI are available on all models, and SDI or HDBaseT are featured only on certain models. If applicable, connect the speakers or external audio amp to the audio output connectors.



Connect the Input sources (Blu-Ray Player, Set Top Box, PC, etc.). Use connectors from different groups to achieve the ¼ sec ultra-fast switching. Groups are identified by the button color on the front panel. If applicable, also connect any audio sources to the 3.5mm stereo jacks.



Inset the power cord to turn-on the unit. The boot-up process takes about one minute.

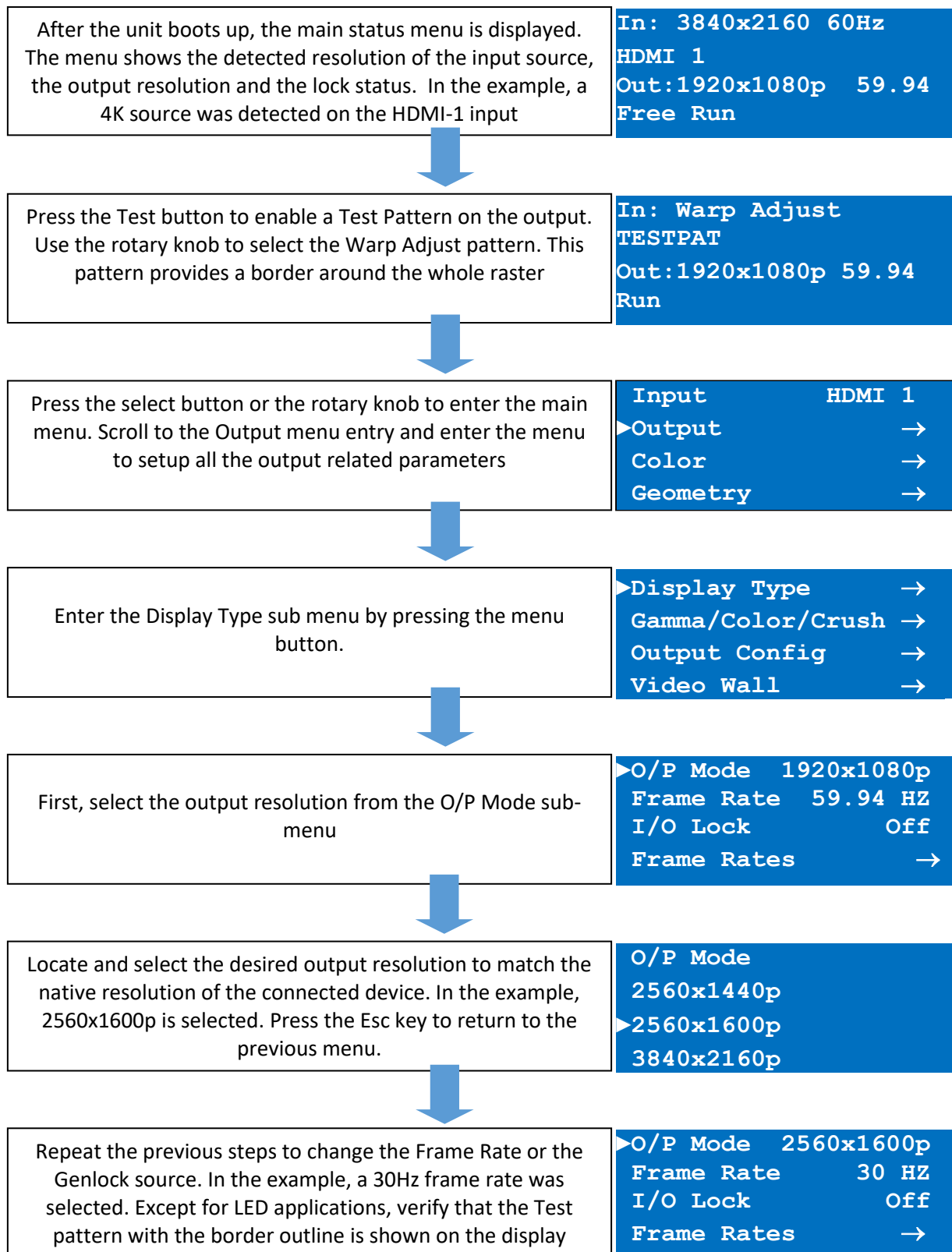

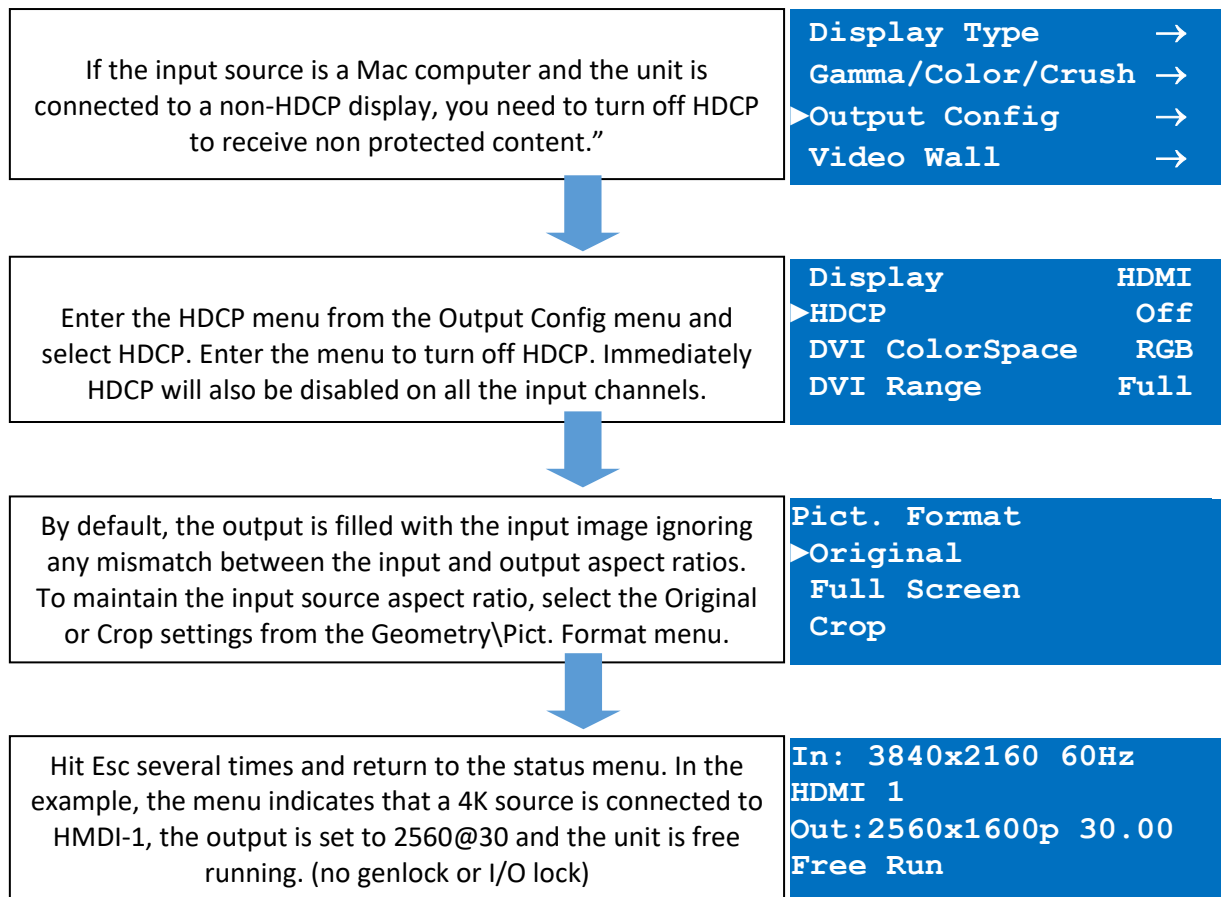

3. System Description

3.1 Front Panel Layout

The front panel includes several buttons allowing the user to select between the different inputs and to perform other functions, a jog wheel and an LCD screen. From the front panel you can navigate the menus, select the an input and direct access to key functions. The front panel layout is similar between the different models except for the SDI, HDBT selection keys. Only models featuring these inputs included these buttons.

VP-796, VP-796A



1 <----- 2 -----> 3 <- 4-> 5 6 7

VP-797A



1 <----- 2 -----> 3 <- 4-> 5 6 7

VP-796ASV



1 <----- 2 -----> 3 <- 4-> 5 6 7

VP-797ASV, VP-798ASV



1 <----- 2 -----> 3 <- 4-> 5 6 7

1 – Standby key: By pressing the Standby key, the unit is put into standby mode. This is indicated by a “STANDBY” message on the LCD with the back light turned off. When the unit starts up, the red Standby key flashes. Once the unit is operational, the Standby key is solid red.

2 – Input channel selection keys: All input channels can be directly selected. The active channel key is illuminated.

3 – Test Pattern key: Directly activates a Test Pattern. Use the jog wheel to scroll through the available test patterns.

4 – Direct function keys: Four functions can be directly accessed by pressing their assigned key: Freeze (stop/resume live video), PTZ (activate/deactivate Pan Tilt Zoom), Logo (show/skip a predefined logo), Blank (blank the output screen/resume live video).



5 – Menu navigational keys: When the Menu/Sel key acts as an Enter or Select key for menu changes. A jog wheel is used for menu navigation and changing values. To exit the menu or any submenu press the Esc key or navigate to the Exit item and press the Menu/Sel key or press the jog wheel.

6 – Front Panel LCD: Displays the Menus on a 4-line display

7 – Jog wheel: The wheel is used for navigating through the menu system and making value changes. The jog wheel has a push function that creates the same effect as pushing the Menu/Sel key.

Front Panel Shortcuts:

Keypad unlock:	Esc + Menu/Sel
Factory reset:	Esc + YPbPr (in live operation or at power up)
Set output mode to 720p:	Esc + VGA
Firmware version:	Standby + Esc (press the menu button to exit)

3.2 Rear Panel Layout

The rear panel features all input and output connectors, communication ports and the power supply connector.

VP-796



VP-796A, VP-796ASV



VP-797A, VP-797ASV, VP-798ASV



1 2 3 4 5 6/7 8 9/10 11 12 13/14 15 16 17

- 1 - 2x SD/HD-SDI/3G-SDI input
- 2 - HDBaseT (UHD/4k) input
- 3 - Display Port (UHD/4k) input
- 4 - 2x HDMI-1 & 2 (UHD/4k) input
- 5 - S/PDIF output
- 6 - VGA Input
- 7 - DVI-U (DVI-D and YPbPr through a cable adapter)
- 8 - 1x HDMI-3 (HD) input
- 9 - Composite Video (BNC)
- 10 - Genlock input (BNC)
- 11 - 3G-SDI output
- 12 - HDBT (UHD/4k) output
- 13 - RS232 port
- 14 - DVI/HDMI1 (HD) output and
- 15 - HDMI2 (UHD/4k) output
- 16 - TCP/IP and 2x USB
- 17 - Power supply connector



3.3 Input Connector Overview

Model	VP-796	VP-796A	VP-796ASV	VP-797A	VP-797ASV	VP-798ASV
Display Port (UHD,4K) via DP connector	✓	✓	✓	✓	✓	✓
2x HDMI (UHD,4K) via HDMI connector	✓	✓	✓	✓	✓	✓
HDBaseT(UHD,4K) via RJ45 connector	✓	✓	✓	✓	✓	✓
DVI & analogue (RGB/RGB/YPbPr) via DVI-U	✓	✓	✓	✓	✓	✓
VGA analogue via 15HDD	✓	✓	✓	✓	✓	✓
Composite Video via BNC	✓	✓	✓	✓	✓	✓
3G-SDI via BNC				✓	✓	✓
Dedicated Genlock via BNC				✓	✓	✓
Audio Inputs		✓	✓	✓	✓	✓

3.4 Output Connector Overview

Model	VP-796	VP-796A	VP-796ASV	VP-797A	VP-797ASV	VP-798ASV
1x HDMI (UHD,4K) via HDMI connector	✓	✓	✓	✓	✓	✓
HDBaseT via RJ45 connector	✓	✓	✓	✓	✓	✓
DVI-D/HDMI via DVI-U	✓	✓	✓	✓	✓	✓
DVI & analogue (RGB/RGB/YPbPr) via DVI-U	✓	✓	✓	✓	✓	✓
3G-SDI I/O Via BNC				✓	✓	✓
Speaker & Line Out 2x 4-pin terminal connector		✓	✓	✓	✓	✓



4. Product Specification

This section provides technical specification for all models. The following topics are discussed:

- Power Supply Requirements
- Input Specifications
- Output Specifications
- Supported Formats
- Communication Specifications

4.1 Power Supply Requirement

100V-264VAC 50/60Hz connected via a standard IEC connector located on the rear panel.

4.2 Input Specifications

4.2.1 Composite Inputs

- Composite via BNC connector
- Signal formats Composite (CVBS)
- Standards NTSC, PAL, SECAM
- Composite (CVBS) input level 1V p-p nominal incl. sync
- Input Impedance 75 Ohms

4.2.2 Component Video Inputs

- Via DVI-U connector and appropriate adapter cable
- YPbPr (YUV), YPbPrS and RGB component video, menu selectable.
- Signal formats 484i (480i) and 576i (SD), 480p, 576p (ED), 720p, 1080i at 50, 59.94 and 60Hz and 1080p at 23.98, 24, 25, 29.97 and 30Hz.
- Please note this input does not support Computer SVGA signals which should be connected via the Computer SVGA input, The SVGA input supports the separate H & V syncs.

4.2.3 3G-SDI Input

- Format:SD-SDI, HD-SDI and 3G-SDI YCbCr 4:2:2 serial digital component video.
- Level B support.
When input is 3G Level B (2 stream mapping), there is an option to select which of the two video streams (Stream 1 or 2) to use. Otherwise it works with whatever mapping is specified in the SMPTE 352 packet (or defaults to 10bit 4:2:2 if none).
- Input impedance: 75 ohms.
- SMPTE 292M, SMPTE 259M-C and SMPTE 424M compliant, accepts 484i, 576i, 720, 1080i and 1080p single link formats at 270Mb, 1.485Gb or 2.97Gb rates.

4.2.4 Computer (SVGA) Inputs VESA formats

- Signal formats: DOS, VGA – WUXGA up to 165MHz pixel clock
- RGB video level: 0.7V - 1.0V
- RGB input impedance: 75 Ohms
- Sync format : Separate H & V sync at TTL/5V levels.



4.2.5 HDMI-3 & DVI Inputs

- HDMI with or without HDCP, 36-bit video compatible.
- DVI-D input with or without HDCP
- Signal formats - video
 - SD: 625i (576i) and 525i (480i) in double-rate formats;
 - ED: 480p, 576p;
 - HD: 1280x720p, 1920x1080i, 1920x1080psf; 1920x1080p 23.97, 24, 25, 29.94, 30, 50, 59.94 & 60Hz; 2048x1080p 23.97, 24, 25, 29.94, 30, 50, 59.94 & 60Hz.
- Signal formats – computer
 - Common VESA graphics formats from VGA to 4k up to 297 MHz (HDMI 1 and HDMI 2) and 225 MHz (HDMI 3) pixel clock

4.2.6 HDMI-1 & HDMI-2 Inputs

- In addition to all signal formats supported by HDMI-3, these inputs also support 4K signals: 3840x2160p & 4096x2160p 23.97, 24, 25, 29.94, 30, 50, 59.94 & 60Hz (50, 59.94 & 60Hz supported in YUV 4:2:0 colour space format),

4.2.7 DP Input

- Display Port without HDCP, 36-bit video compatible.
- Signal formats as HDMI 1 and HDMI 2.

4.2.8 HDBT Input

- Uncompressed HD video over RJ45 connector and max.100m CAT5e cable (or better)
- CAT5e/CAT6 for 100m and signals with less than 225MHz Pixel Clock
- CAT6a/CAT7 for 100m and signals up to 297MHz Pixel Clock
- Signal formats as HDMI 1 and HDMI 2.

Graphics formats with odd numbered horizontal active pixels, e.g. 1365x768 are not supported.



4.3 Output Specifications

All output channels are active simultaneously, provided that the input signal is not HDCP encrypted. All units include an HDMI, and a DVI-U connectors for DVI/HDMI connectivity. Some models feature a BNC connector for 3G-SDI signals and an RJ-45 connector supporting HDBaseT capability. The DVI-D connector supports HDMI with 36-bit video and audio formats when connected to a suitable HDMI receiver. The colour depth of the HDMI signal is determined by a menu selection and the capabilities of the monitor.

Interlaced outputs are only supported on models with 3G-SDI output.

4.3.1 **3G-SDI Output**

- Format: SD-SDI, HD-SDI and 3G-SDI YCbCr 4:2:2 serial digital component video
- Input impedance: 75 ohms.
- SMPTE 292M, SMPTE 259M-C and SMPTE 424M compliant, accepts 484i, 576i, 720, 1080i and 1080p single link formats at 270Mb, 1.485Gb or 2.97Gb rates.

4.3.2 **HDMI & DVI Outputs**

- HDMI with or without HDCP, 36-bit video compatible.
- DVI-D input with or without HDCP
- Signal formats - video
 - SD: 625i (576i) and 525i (480i) in double-rate formats;
 - ED: 480p, 576p;
 - HD: 1280x720p, 1920x1080i, 1920x1080psf; 1920x1080p 23.97, 24, 25, 29.94, 30, 50, 59.94 & 60Hz; 2048x1080p 23.97, 24, 25, 29.94, 30, 50, 59.94 & 60Hz.
- Signal formats – computer
 - Common VESA graphics formats from VGA up-to 1080p and 1600x1200
- HDMI output also supports: 4K signals: 3840x2160p & 4096x2160p 23.97, 24, 25, 29.94, 30, 50, 59.94 & 60Hz (50, 59.94 & 60Hz supported in YUV 4:2:0 colour space format)

4.3.3 **HDBT Output**

- Uncompressed HD video over RJ45 connector and max.100m CAT5e cable (or better)
- CAT5e/CAT6 for 100m and signals with less than 225MHz Pixel Clock
- CAT6a/CAT7 for 100m and signals up to 297MHz Pixel Clock
- Signal formats as HDMI 1 and HDMI 2.

4.3.4 **HDCP Output encryption**

When the input signal is HDCP encrypted, the DVI-D, HDMI and HDBaseT outputs will also be encrypted and the 3G-SDI output will be disabled. If the display device does not support HDCP, the output will be black and a message indicating that the presence of an HDCP signal will be shown on the screen.



The user can turn off the unit's HDCP compliance to allow non-encrypted content to pass through the unit. This is an important feature specially when using a MAC computer as the source. The MAC will encrypt its output signal if a compliant device is seen attached to its output regardless of the copy protection requirements of the content. By turning off HDCP, the MAC will see a non-compliant device and therefore will not encrypt its output. When HDCP compliance is turned off, encrypted sources will not be displayed.

4.3.5 Audio Output

Audio embedded in HDMI and SDI video streams is passed through the system and re-embedded into the HDMI and SDI output signals.

Also, the unit features a S/PDIF coaxial digital audio output connector for monitoring audio of the HDMI and SDI channel.

When HDMI is selected as the input channel, the HDMI EDID is read by a video source such as a Blu-Ray Player. The unit allows the source to provide the formats shown under output formats for HDMI in the below table. All formats are re-embedded into the HDMI output data stream, those which are not allowed on the SDI or SPDIF output are muted on the individual channels.

Table 2: Embedded HDMI & SDI Output Audio Formats

Output Channel	Output Format
HDMI	PCM up to 8ch, up to 24Bit, up to 192kHz sampling rate (incl. 32kHz,44.1kHz,48kHz,96kHz,192kHz)
SDI	PCM up to 8ch, up to 24Bit, 48kHz sampling rate
SPDIF	PCM up to 2ch, up to 24Bit, up to 96kHz sampling rate (incl. 32kHz,44.1kHz,48kHz,96kHz)

The unit will not pass through any Dolby Digital, MPEG2 or DTS audio formats

4.4 Analog Audio

Units supporting audio include up-to 8 analog stereo Inputs, two microphone Inputs with phantom power and an audio mixer.

Analog stereo signals are connected to the unit via 3.5 mm jack sockets, except for the CV input that is associated with two RCA connectors. Using the audio menu, any video input can be link with any audio input and mixed with the mic inputs.

Audio models also include stereo audio power amplifier supporting 15W RMS loudspeaker per output and separate stereo balanced line level audio outputs for external amplifier systems. The analog stereo outputs are available on two phoenix connectors.



4.5 Video Formats

Table 3: Supported Video Formats

Horiz. Active Pixels	Vert. Active Lines	Vertical Refresh Rate (Hz)								Outputs		Specification
		60	59.94	50	30	29.97	25	24	23.98	DVI HDMI HDBT	3G-SDI	
640	480	✓	✓	✓						✓		VESA DMT
720	480i		✓							✓	✓	EIA/CEA-861-B Format 6 (NTSC)
720	480p		✓							✓		
720	576i			✓						✓	✓	EIA/CEA-861-B Format 17 (PAL)
720	576p			✓						✓		
800	600	✓	✓	✓						✓		VESA DMT
1024	768	✓	✓	✓						✓		VESA DMT
1280	720	✓	✓	✓	✓	✓		✓	✓	✓	✓	EIA/CEA-861-B Format 4
1280	768	✓	✓	✓						✓		VESA CVT 001M9/VESA DMT
1280	800	✓	✓	✓						✓		VESA CVT 001MA/VESA DMT
1280	1024	✓	✓	✓						✓		VESA DMT
1360	768	✓	✓	✓						✓		VESA AddDMT
1366	768	✓	✓	✓						✓		proprietary
1440	900	✓	✓	✓						✓		CVT 1.30MA/VESA DMT
1400	1050	✓	✓	✓						✓		VESA CVT 001M3/VESA DMT
1600	1200	✓	✓	✓						✓		VESA DMT
1680	1050	✓	✓	✓						✓		VESA CVT 002MA
1920	1080i	✓	✓	✓	✓	✓		✓	✓	✓		EIA/CEA-861-B Format 5
1920	1080p	✓	✓	✓	✓	✓	✓	✓	✓	✓	✓	EIA/CEA-861-B Format 5
1920	1200	✓	✓	✓						✓		VESA CVT 002MA- R/VESA DMT
2048	1080	✓	✓	✓		✓	✓	✓		✓	✓	proprietary
2048	1200		✓							✓		proprietary
2560	1080	✓	✓	✓	✓	✓	✓	✓	✓	✓		EIA/CEA-861-F VIC=86
2560	1440	✓	✓	✓	✓	✓				✓		VESA CVT 004M-R
2560	1600	✓	✓	✓	✓	✓				✓		VESA CVT 004M-R
3840	2160	✓	✓	✓	✓	✓	✓	✓	✓	✓		EIA/CEA-861-F VIC=93
4096	2160	✓	✓	✓	✓	✓	✓	✓	✓	✓		EIA/CEA-861-F VIC=98

4.6 Communications Specification

The unit supports both TCP/IP and RS-232 serial protocols.

Either port can be used to send API commands to the unit. Software updates can also be performed from the Ethernet port.

Restoring the unit to the factory default state, doesn't affect communication settings.

4.6.1 TCP/IP Port

The unit supports DHCP and static modes. If DHCP is active, the unit will be assigned an IP address by the network's DHCP master. If the unit is set in the static mode, the user needs to set the IP address manually. Restoring the unit to the factory default state, doesn't affect communication settings.

Port 30000 is used.

4.6.2 Serial Connector pinout and RS-232 Configuration Settings

Table 4: Serial Connector Pinout

DB-9 Pin	Signal name	Function
2	RXD	RS232 levels, Receive (from the HOST)
3	TXD	RS232 levels, Transmit (to the HOST)
5	DGND	Ground

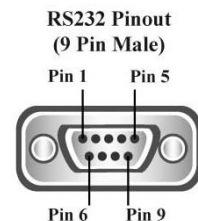

The serial communication configured as follows:

Table 5: RS-232 communication settings

Parameter	Value
Baud rate	115200 Bits/second
Stop Bits	1
Number of bits received/transmitted in the BYTE	8
Parity Bits	No Parity
Flow Control	Off



5. Unit Control

The unit can be controlled via the front panel, a web page built-in into the unit or an API protocol interface. The next two chapters describe the Front Panel and Web Browser control methods. The API interface can be found in a separate document available on our web site.

6. Front Panel Control

You can enter the main menu by pressing the Menu/Sel key from the status screen. You can use the jog wheel and Menu/Sel and Esc buttons to navigate through the different menus.

A complete diagram of the menu tree is shown in Appendix A. The audio menu tree for units fitted with the audio option is shown in Appendix B.

Next, is a brief description of the functions and settings available from the front panel menus.

Main Menu

Under the main menu are the main sub-menus that allow user to setup and operate the unit. These sub-menus are:

- Input
- Output
- LED Screen Size
- PIP
- System
- Audio
- Status

Each menu includes an Exit entry to return to the previous level. Some adjustments are not applicable to all signal types or operating modes, in which case those non-applicable functions will be greyed out and are not accessible.

The unit is designed to have separate memories for all the settings in each section. All Input parameters are specific to your chosen input channel and input signal type, and are not global to the unit. For example, if you change the settings for the composite video channel, you will not affect the settings you may have made in the DVI channel.



6.1 Input

This menu contains adjustments related with the outputs of the unit.

6.1.1 Input Selection

This menu provides an additional method of selecting the desired input.

Depending on the specific model, some of these input selections may not be available.

Test patterns can be selected even when there are no inputs connected to the unit. Different test patterns can be selected by scrolling the jog wheel.

Settings:

- SDI-1*
- SDI-2*
- Display Port
- HDMI-1
- HDMI-2
- HDBaseT*
- DVI
- HDMI-3
- VGA
- YPbPr/RGB
- Composite Video
- Test Pattern

Default : HDMI-1

* : These inputs are not present on all the models. Please refer to the Input Connector Overview to determine the appropriate models.



6.1.2 Input Config

6.1.2.1 Analog Inputs

6.1.2.1.1 VGA Setup

- Clock\Phase
Frequency (Clock) and phase can also be altered manually, as the vertical and horizontal position
Settings: 0 to 32
Default : 0
- Colour Space
Settings: RGB or YCbCr
Default : RGB
- Range
The greyscale range can be reduced by switching from full to limited (see range values discussed in the output config section)
Settings: Full / Limited
Default : Full
- Reset Mode
A reset button to factory defaults is provided, to return the phase, clock and positional settings to the original positions.
- EDID IN
The preferred video mode can be selected in the EDID Input Format menu. This setting can force the source to output a certain video mode provided the driver of the graphic card reads the preferred timing in the EDID. Most likely the PC needs to be rebooted for the driver to notice the EDID change.
- EDID F/R :
The preferred video frame rate can be selected from the provided menu. This setting can force the source to output the selected frame rate provided the driver of the graphic card takes notice of the preferred timing in the EDID. The PC most likely has to be rebooted for the driver to take notice.

Default : 1920x1080p

6.1.2.1.2 RGB/YPbPr Setup:

Same as VGA Setup, except there is no concept of EDID with component video and thus no EDID Input Format menu.

6.1.2.1.3 CVBS Setup:

- CCS is a filter to reduce luminance to chrominance cross talk of composite video signals (only) which appears as a coarse rainbow pattern or random colours in regions of fine details.

Default : On



6.1.2.2 Digital Inputs

6.1.2.2.1 DP, HDMI 1, HDMI 2, HDMI 2, DVI Config.:

- Colour space
The automatic Colour Space and Range settings can be overwritten in this menu.
Settings: RGB or YCbCr, if Auto setting does not give the desired result
Default: Auto
- Range
Settings: Limited. Full or Auto range.
Default: Auto
- Deep Color:
The EDID can be configured to enable deep colour capability. The unit can process colour depth of 24/30/36 per channel (DP input can only accept 24/30 bits). Deep Colour can be off, if the source outputs 24bits, or set to on when the source outputs 30 or 36bits. The detected source output colour depth is reported on the corresponding menu.
Settings: On/Off
Default: Off
- EDID In
The preferred video resolution can be selected from the provided menu. This setting can force the source to output the selected format provided the driver of the graphic card takes notice of the preferred timing in the EDID. The PC may have to be rebooted for the driver to take notice.
Default: 1920x1080p
- EDID F/R :
The preferred video frame rate can be selected from the provided menu.–This setting can force the source to output the selected frame rate provided the driver of the graphic card takes notice of the preferred timing in the EDID. The PC most likely has to be rebooted for the driver to take notice.
- HDCP
When setting HDCP Input to off, the unit pretends to be non HDCP compliant allowing the source to not encrypt data. Please note that the source will not encrypt the input data only if the source content is not copy protected. If for example, the source is a Blu-ray player and HDCP is turned off, then the player will not send any data to the unit. When HDCP is set to off, the output is unencrypted and this menu item is greyed out. This selection is not available for the Display port input

Settings: On/Off

Default: On

6.1.2.2.2 HDMI Audio Support

The audio capabilities of the HDMI port can be configured by means of overwriting the EDID. The unit described in this manual is part of an audio/video processing chain and devices behind the unit may not be able to cope with advanced audio. The unit can signal the source to match with the audio capabilities of the display (setting Match Display 1/2), or to be S/PDIF friendly or to be



SDI friendly (48kHz PCM only, 2ch or 8ch). If the unit is set to Full the capabilities of the unit are communicated by means of the EDID to an audio source.

Settings: On/Off

Default: On

6.1.2.2.3 SDI Setup

6.1.2.2.4 SDI to HDMI Audio

SDI audio input is routed to the HDMI and 3GSDI output connector. Two consecutive SDI audio channels can be output on the HDMI/3GSDI output interface. The group can be chosen, or all eight SDI audio channels can be transmitted

Settings: Stereo Ch. (1,2)/(3,4)/(5,6)/(7,8)/Multichannel

Default: Stereo Ch. (1,2)

6.1.2.2.5 Level B Priority

Since only one Level B signal can be processed by the unit, in this entry the user needs to prioritize the SDI input with the Level B signal.

Settings: SDI1 / SDI2

Default: SDI1

6.1.2.2.6 SDI1/SDI2 Level B Stream

Selects which of the two video streams (Stream 1 or 2) to use.

Settings: SDI1(2) Level B Stream: Stream 1(2)

Default: SDI1 Level B Stream: Stream 1

SDI2 Level B Stream: Stream 2

6.1.2.3 Test Pattern Setup

6.1.2.3.1 Test Pattern Selection

- When the Test button is pressed on the front panel, different patterns can be selected by turning the jog wheel. For unit control through a web browser or to set up a certain default test pattern please use the input configuration menu.
- Custom test patterns loaded into the unit through the web interface, and selected as the other test patterns.
- Depending on the Output resolutions, test pattern images are resized dynamically by the software resolution to completely fit the output raster space.
- Available Test Patterns:
 - Red Curtain
 - Green Curtain
 - Blue Curtain
 - Grey V Bars
 - Grey H Bars



- Aspect Test
- Multi Test
- Warp Adjust
- SMPTE
- PLUGE
- Moving Cross
- Custom 1
- Custom 2
- Custom 3
- Custom 4

Default: Pattern: SMPTE

6.1.2.3.2 Test Pattern Tone

A test tone can be set to accompany the test pattern

Settings: On / Off

Default: Off

6.1.2.3.3 Color (FG) of the Moving Cross

Settings: 0 to 7

- 0 = black
- 1 = white
- 2 = yellow
- 3 = cyan
- 4 = green
- 5 = magenta
- 6 = red
- 7 = blue

Default: 1 (White)

6.1.2.3.4 Moving Cross Background (BG) color

Settings: 0 to 8

- 0 = black;
- 1 = white;
- 2 = yellow;
- 3 = cyan;
- 4 = green;
- 5 = magenta;
- 6 = red;
- 7 = blue;
- 8 = Multicolor, sets the four quadrant colours as red, green, blue and black)

Default: 8: (Multicolor)

6.1.2.3.5 Moving Cross Speed

Number of pixels that the test pattern moves per frame

Settings: 1 to 10

Default: 1



6.1.2.3.6 Moving Cross Width

The width of the moving cross in pixels

Settings: 4 to 40

Default: 40

6.1.2.4 Input Enable

Each input can be disabled locking the associated front panel button.

Settings: 0 or 1 0: Disable / 1: Enable

Default: All Enabled

6.1.2.5 Switching Transition

The switching transition can be selected to be Freeze, Blank, Fast Fade and Slow Fade.

- Freeze : Halts the prior channel image until the new channel image is stable. Freeze is the default mode.
- Blank : Switches the output to a black screen instead of the last shown image.
- Fast and Slow Fade : Fades between the channels with different transition times

Settings: Freeze, Blank, Fast Fade and Slow Fade

Default: Freeze

6.1.2.6 Streaming Video

Units fitted with the streaming option can accept 1080p H.264 Streaming Video via the Gigabit Ethernet Port and route it to the output. API commands send to the unit via the Ethernet port can be processed simultaneously with the streaming video. The unit interfaces to the video server via the RSTP network control protocol.

The user needs to enter the IP address and port of the stream source and the file name. Additionally four more selections are provided for a simple operation: Start, Stop, Auto Start and Auto reconnect.

Settings: Source IP address & Port, File name, Start, Stop, Auto Start, Auto reconnect

Default: Auto Start=On, Auto reconnect=Off



6.1.2.7 Custom Modes

From this menu the user can create up-to four custom progressive or interlaced resolutions to interface with sources providing non-standard video format. These custom resolutions can also be selected in the EDID selection for each input. Custom resolutions are not available for the SDI inputs. This menu is available on selected models.

Settings: CMx Width: from 640 to 4096; CMx Height: from 480 to 2160; CMx Scan Type: Progressive/Interlaced

Default : CMx Width: 1920; CMx Height: 1080; CMx Scan Type: Progressive

6.1.3 Colour Adjustments

6.1.3.1 Black-Level Offset

Used to select 7.5 IRE black level set-up adjustment. Should always be set to 7.5 IRE for HDMI video and NTSC video inputs and should usually be off for PAL analog video inputs.

Settings: 0 IRE, 7.5 IRE

Default : 0 IRE

6.1.3.2 Brightness (Black-Level)

Brightness controls the offset applied to the video signal. (same as the brightness control on a TV)

Settings: -50 to 50 in steps of 1

Default : 0

6.1.3.3 Contrast

Contrast controls the gain applied to the video signal.

Settings: -50 to 50 in steps of 1

Default : 0

6.1.3.4 Saturation

Controls the video colour saturation, (applies individually to all video inputs but not computer input signals or formats).

Settings: -50 to 50 in steps of 1

Default : 0

6.1.3.5 Hue

Adjusts the colour hue of NTSC signals. This is not applicable for computer input signals or formats.

Settings: -50 to 50 in steps of 1

Default : 0



6.1.3.6 RGB Values

This is a user-defined colour temperature setting where R,G,B gain (white balance) and offset/bias (black balance) can be adjusted separately in order to match the display device.

This control is not available for output modes with colour space format YUV 4:2:0.

Settings : Red/Green/Blue Gain/Bias : -512 to 512

Default : 0

6.1.3.7 Colour Temp

A preset range of Colour Temperature allowing the user to select from pre-configured colour temperatures to match the colour temperature of the incoming signal. If this value Native Colour Temp value in the Output menu are the same, no conversion is performed.

Settings: 3200K, 3700K, 5500K, 6500K, 7500K, 9300K

Default : 6500K

6.1.3.8 Input Gamma

Set this value to match the gamma of the input signal. Input and output gamma both default to 1.0. If they are both set to the same value, there is no effect on the image.

Settings: 1.0 to 3.0 in steps of 0.1

Default : 1.0

6.1.4 Geometry

This menu contains adjustments associated with setting up position, aspect ratio and scale of the input signal.

6.1.4.1 Picture Format

This feature allows the user to format the output image when the input aspect ratio is different to the display panel's aspect ratio. Four formats are available: Original, Full Screen, Crop and Anamorphic.

Original: The input image is scaled to fit the display area either horizontally or vertically without any distortion. The input aspect ratio is preserved and unused areas on the top/bottom or left/right are set black.

Full Screen: The input image is scaled to completely fit the display area without preserving the aspect ratio of the source. This will cause distortion but no black areas will be visible.

Crop: The input image is scaled to completely fit the display area while preserving the aspect ratio of the source. Portions of the input image on the top/bottom or left/right will be cropped out of the output image.

Anamorphic: The image will be treated as in crop, but it is always scaled to a 16:9 aspect ratio.

The images below provide examples how an input image 1400x1050(4:3) is scaled to an 1920x1080(16:9) output with the four available formats.

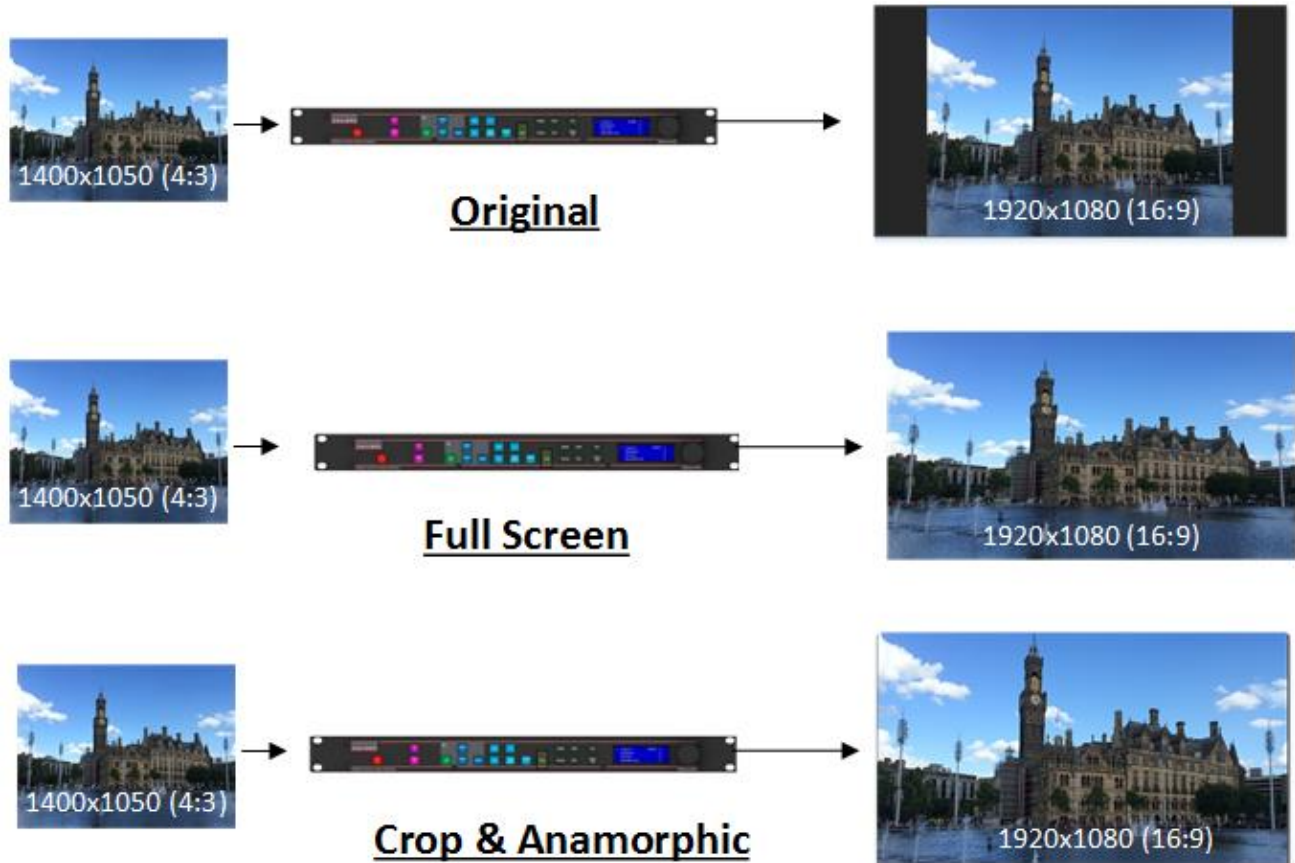

Figure 1: Picture Format Examples

6.1.4.2 Overscan

Overscan is used to slightly zoom into the image. Therefore, the border area of an image is no longer displayed on the screen. This cuts off unwanted features at the top or bottom from e.g. head switching in legacy video images.

Settings: 0 to 10 in steps of 1

Default: 0



6.1.4.3 Pan Tilt Zoom (PTZ)

This menu provides settings to zoom and shrink the image, pan horizontally and tilt vertically within the image. PTZ can be switched on or off and the settings can be saved per input channel or globally, i.e. if applied globally the same PTZ settings are applied when switching input channels or changing the input mode. The Zoom setting allows zooming into the image or shrink it.

When Aspect Lock is set to On, vertical zoom is disabled and the horizontal zoom or shrink factor is also used to vertically adjust the image. In this mode the aspect ratio is preserved.

When Aspect Lock is Off, horizontal and vertical scaling factors are set separately, regardless of the input image aspect ratio.

Off raster panning is also allowed, i.e, the image can be shifted outside the active area of the display.

The PTZ settings can be set to the default settings with the reset button.

Settings: On/Off

Default: Off

6.1.4.3.1 PTZ Enable

PTZ needs to be turned on before the other functions are enabled.

Settings: On/Off

Default: Off

6.1.4.3.2 PTZ Setting

This setting determines whether the PTZ values are applied on the selected input, or globally

Settings: Per Input / Globally / Per Input per Mode

Default: Per Input

6.1.4.3.3 PTZ Value

This setting determines whether the PTZ adjustments are done in pixel increments or in percentages of the input image size.

Settings: Pixels / Percent

Default: Pixels



6.1.4.3.4 Pan

This setting determines the amount of horizontal pan. In other words, it defines where the scaler selects the horizontal start of the image to be processed. Positive values move the output scaled image to the right and negative values to the left.

Settings: -50% to +50%

Default: 0

6.1.4.3.5 Tilt

This setting determines the amount of tilt (vertical pan). In other words, it defines where the scaler selects the first line of the image to be processed. Positive values move the output scaled image downwards and negative values upwards.

Settings: -50% to +50%

Default: 0

6.1.4.3.6 Zoom-H

This setting determines the amount of horizontal zooming in or out of the input image. Positive zoom will cause only a portion of the input image to fill the output raster.

Settings: -25% to +400%

Default: 0

6.1.4.3.7 Aspect Lock

In order to maintain the aspect ratio of the input source, by default Aspect Lock is set to on to allow the Zoom-V setting to change simultaneously with Zoom-H.

Settings: On / Off

Default: On

6.1.4.3.8 Zoom-V

The Aspect Lock needs to be off, for this setting to take effect. Zoom-V determines the amount of vertical zooming in or out of the input image. Positive zoom will cause only a portion of the input image to fill the output raster.

Settings: -25% to +400%

Default: 0

6.1.4.3.9 PTZ Reset

Resets all PTZ parameters to the default settings



6.1.5 Enhancement

The enhancement menu provides image enhancement functions. Note that the enhancement settings apply only to video input signal and not to computer graphics signals.

6.1.5.1 Sharpness

Control of the sharpening enhancement filters' levels. These are peaking filters to improve high-frequency response. Note that setting this control too high on a signal which already has good high frequency response will cause ringing or ghosting.

Settings: -4 to 4 in steps of 1

Default : 0

6.1.5.2 Detail

This filter provides powerful 2D image enhancement which can be used to greatly improve detail definition and clarity without causing image ringing or ghosting. It improves both horizontal and vertical detail. Correct setting of the detail enhance filter can make SD signals look virtually indistinguishable from true HD. At setting 0 the filter is switched off, with setting 3 providing the highest effect.

Settings: 0, 1, 2, 3

Default : 1



6.2 Output

This menu contains adjustments related with the outputs of the unit.

6.2.1 Display Type

6.2.1.1 Output Mode (Resolution)

The selected output resolution should match the native resolution of the imaging device to avoid double scaling. When you are connected to an LED display, choose a resolution that is equal or greater than the display resolution. Then use the LED screen size adjustment to accurately scale to the LED wall. Some low cost LED walls display artefacts when using lower resolution settings. To deal with these artefacts it is sometimes necessary to choose a much higher resolution, and then use the LED screen size adjustment as described above.

The 3GSDI output does not feature the PC resolutions; only 480i/p, 576i/p, 720p and 1080i/p output modes are supported.

Settings: See the Supported format table in the Product Specification chapter of this document

Default : 1920x1080p

6.2.1.2 Frame Rate

As with the output resolution, the output frame rate should match the native frame of the imaging device. Some frame rates may not be available depending on the selected resolution.

In auto mode the output frame rate follows the input frame rate if it supported by the output resolution. If the input frame rate is not supported by the output resolution, then the unit determines the output frame according to a procedure programmed in the software.

Settings: 60 Hz, 59.94 Hz, 50 Hz, 48 Hz, 25Hz, 24 Hz, 23.97, Auto

Default : 59.94Hz

6.2.1.3 I/O Lock

From this menu, the user can select the genlock mode of the unit. If I/O Lock is off, the output free-runs with a fixed refresh rate determined by the frame rate setting. In this mode, the output vertical refresh sync deviates slightly from the input vertical refresh sync, even if both are set at the same rate, occasionally causing frame dropping or repeat.

If I/O Lock is set to On, the output refresh rate follows the input video refresh rate if possible. If not, the output is operated with a fixed refresh rate determined by the frame rate setting.

If I/O Lock is set to Genlock, the output refresh rate will follow the vertical sync of the signal connected to the Genlock BNC connector. Genlock is achieved when the Genlock vertical sync rate matches the vertical sync rate set in the output menu. Valid combinations are 50Hz/50Hz, 59.94Hz/59.94H and 60Hz/60Hz. If genlock is not achieved, the output frame rate refresh rate is determined by the frame rate setting.



The LCD main status menu indicates the genlock status: (I/O Locked or Genlocked) or in free run mode (Free Run). In order to achieve clean switch between input selections, follow the locking settings described in the table below.

Table 6: I/O Lock behaviour

	I/O Lock = On (Lock to i/p video)	I/O Lock = Genlock	I/O Lock = Off (Free Run)
Auto Frame Rate	Never Clean	Always Clean	Depends on Inputs
Fixed Frame Rate (any)	Never Clean	Always Clean	Always Clean

If the output Frame rate is set to Auto, all types of genlock signals (e.g. NTSC & PAL, Tri-level sync) signals can be accepted. On the other hand, if a specific frame is selected, for example 59.94Hz, a Genlock reference signal of 59.94Hz can only be accepted and the unit will not lock to a 50Hz reference signal.

If the output Frame rate is set to Auto and I/O lock is off, input switching may-not be clean. Clean switching will depend how close the frame rates of the current and next input channel are.

Settings: Off, On, Genlock (for models supporting genlock)

Default : Off (Free Run)

6.2.1.4 Frame Rate (Enable)

From this menu the user can choose the output frame rates that the unit can output. By de-selecting certain frame rates, you can prevent the unit from outputting frame rates that cannot be accepted by the display.

Settings: 60 Yes/No, 50 Hz Yes/No, 48 Yes/No, 30/29.97Hz Yes/No, 25 Yes/No, 24/23.98 Yes/No

Default : 60Hz Yes, 50Hz Yes, 48Hz No, 30/29.97Hz Yes, 25Yes, 24/23.98Hz Yes

6.2.1.5 Custom Modes (Resolutions)

From this menu the user can create up-to four custom output progressive or interlaced resolutions. These resolutions are available for selection from the Display Type sub-menu under the Output menu. These custom resolutions can also be selected for each input from the Input Conf. sub-menu under the System menu. The custom resolutions are not available for the SDI output. This menu is only available for the LED driving models.

Settings: CMx Width: from 640 to 4096; CMx Height: from 480 to 2160; CMx Scan Type: Progressive/Interlaced

Default : CMx Width: 1920; CMx Height: 1080; CMx Scan Type: Progressive



6.2.2 Gamma/Colour/Crush

Native Colour Temp allows the user to select from pre-configured colour temperatures to match the display. If this value is the same as the Colour Temp value in the (Input) Colour menu, no conversion is performed.

Settings: 3200K, 3700K, 5500K, 6500K, 7500K, 9300K

Default : 6500K

6.2.2.1 Output Gamma

Output gamma allows to re-gamma video signals with pre-configured gamma values to match the display. Input gamma and output gamma both default to 1.0. If they are both set to the same value, there is no effect on the image. If you need to reduce the level of certain color in the image, select a higher value for the input colour Temp in the Colour menu, or a lower number for the Native Colour Temp in the Output menu.

Settings: 1.0 to 3.0 in steps of 0.1

Default : 1.0

6.2.2.2 Black Crush (LED models only)

This feature is available for models supporting LED walls. The input black level should be optimized prior to using Black Crush and any filter settings should also be optimized first. Black Crush is not a replacement for correct input settings, but it is available to clean up any remaining black level noise on the signal which may be visible on very bright LED screens without reducing the peak white brightness. This function is not the same as adjusting the overall black level.

It is recommended to use a setting between 0 and 16 and not more than 20. For most LED screens the optimum setting for Black Crush is between 8 and 20. For particularly noisy subject material, 24 can be used but detail loss may occur in dark areas. If too high a setting is chosen, image solarization may be observed where dark image areas turn completely black or even change colour.

Settings: 0 to 255 in steps of 1

Default : 0



6.2.3 Output Config

6.2.3.1 HDMI & DVI Outputs

Internally, the output interface processes data at a full ten bits per colour. The colour depth on the HDMI outputs is determined by the supported standard of the attached monitor or device when set to DVI/HDMI.

DVI 1.0 and HDMI 1.1/1.2 devices are set at 24 bit, for HDMI 1.3 or later compliant devices it is up to 36 bit. The DVI forced selection will output video with 24 bit colour depth irrespective of the supported standard of the attached monitor.

Settings: DVI forced, DVI/HDMI, HDMI 8-bit, 10-bit, 12-bit

Default : HDMI

6.2.3.2 HDCP

HDCP encryption support on the output can be switched off as is in the input. This means the unit pretends to be non-HDCP compliant on the DVI/HDMI output port and consequently does not encrypt data.

At the same time, HDCP is also turned off at the input ports. This allows the unit to accept non-HDCP encrypted data. If the source however, is HDCP encrypted, then the output will be black.

Settings: On, Off

Default : On

6.2.3.3 DVI Colour Space

This menu allows users to select between the RGB and YPbPr colour spaces

Settings: RGB, YPbPr

Default: RGB

6.2.3.4 DVI Range

When set to Default CEA, the output modes have limited range, and VESA modes have full range. Therefore, an incoming limited range mode is either passed through when the output is set to a CEA output mode or expanded when the output is set to a VESA mode. An incoming full range mode is either compressed when the output is set to a CEA output mode or passed through when the output is set to a VESA mode.

If the HDMI/DVI output does not operate properly, the range can be changed manually. A limited video range is only using the following greyscale for video information - 8 Bit System: 0x10 .. 0xEF, 10 Bit System: 0x040 .. 0x03BF, 12 Bit System: 0x100 .. 0xEFF.

Settings : Default, Limited, and Full

Default : Full



6.2.4 Video Wall

The Video Wall menu provides controls to set up multiple units in a multi-screen application. Multiple screens are stitched together to provide a bigger display with higher resolution than a single display. Each display is driven by a separate unit.

In a multi projection display the individual projections typically are chosen to overlap to give seamless transitions. Multiple LED walls or LCD/Plasma screens do not have overlapping regions. The Blend Width is set to zero. When using Video Wall to drive one single large screen, it is essential that all units are I/O locked or genlocked, otherwise motion tear will be observed at the boundaries of the image processed by each unit.

6.2.4.1 Auto Zoom

Switches on the auto zoom resizing the video image to display the assigned part of the total image.

When Auto zoom is turned on, the processor will cut and scale the portion of the picture selected by the matrix size and position selected as described next. Autozoom should be turned off when the unit is connected to a multi-head graphics card where the content has been split.

Settings: On/Off

Default: Off

6.2.4.2 Units Wide/Units High

The dimensions of the multi-screen display is defined with this menu. The maximum number of screen supported is 16. This function is used in conjunction with the next function.

Settings: Units Wide: 1, 2, 3, 4 / Units High: 1, 2, 3, 4

Default: Units Wide: 1 / Units High: 1

6.2.4.3 Horizontal Pos/Vertical Pos

These setting provides the coordinates of the segment of the total image that the unit will process (cut out and resize). This function is used in conjunction with the previous function to select the blend regions to be provided even when auto zoom is turned off.

Settings: 1 to 4 indicating co-ordinates 1,1 to 4,4 for the maximum matrix size of 16

Default : 1,1

In the example below a 4K image is split into four 1080p quadrants in a 2x2 configuration. Each unit is set for a 2x2 configuration and I/O lock. Hpos and Vpos setting are set as shown in the drawing.

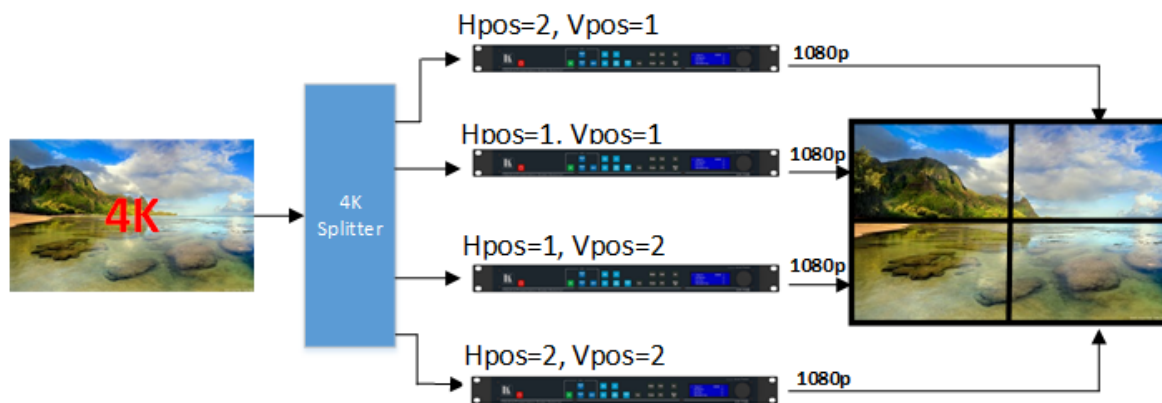

For all 4 units: Units Wide= 2 & Units High=2

Figure 2: 2x2 Video Wall example

6.2.4.4 Bezel Width

This menu allows users to define the bezel widths in large system configuration where multiple units are driving different portions of the display. There are separate adjustments for each.

Settings: Left Bezel Width, Right Bezel Width, Top Bezel Width, Bottom Bezel Width

Defaults: 0,0,0,0

6.2.4.5 Wall Setup

In a system configuration where multiple units are driving different portions of a large display, each unit is driving a different portion of the total display. If the size of the different portions of the display are equal, the settings discussed so far in this section are sufficient to define the area where the output image will be displayed.

If the size of the portions are unequal, then the Advanced wall setup needs to be enabled in order to define the area each portion occupies within the total display space. Standard mode works up to a wall size of 4x4. Advanced mode is limited to a maximum wall size of 2x2.

Settings: Standard / Advanced

Default : Standard

6.2.4.5.1 Advanced Wall Screen

In this menu, users define the total dimension of the display with the width and height settings. The portion of the output to be displayed is defined by the Horizontal and Vertical offset settings.

Wall Width : Total Wall width

Wall Height: Total Wall Height

Hor Offset : The horizontal position within the total display space where the image will be placed

Ver Offset : The vertical position within the total display space where the image will be placed

6.3 LED Screen Setup

This feature is available in VP-798ASV model. With this menu the user can define an area within the output raster where the output scaled image will be positioned. This area should match exactly the size of your LED wall. The image size is defined and positioned according to the right, left, top and bottom edge settings.

The output image can be reduced to as few as 128x96 pixels. The adjustments are performed horizontally in 4-pixel increments and vertically 1 line increment. If the source is 4K, the horizontal increment is 8-pixels and vertically is 2 lines. A reset function is also provided to reset all parameters to full output resolution.

In the example below, the unit is outputting a full resolution of 1920x1080, but the output image is only present in the corner occupying an area of 1760x880. The LED processor/Sender box that receives the signal, will only process this area (1760x880 pixels) and transmit it to the LED wall. The rest of the 1920x1080 area will be ignored, and that is why is left black.

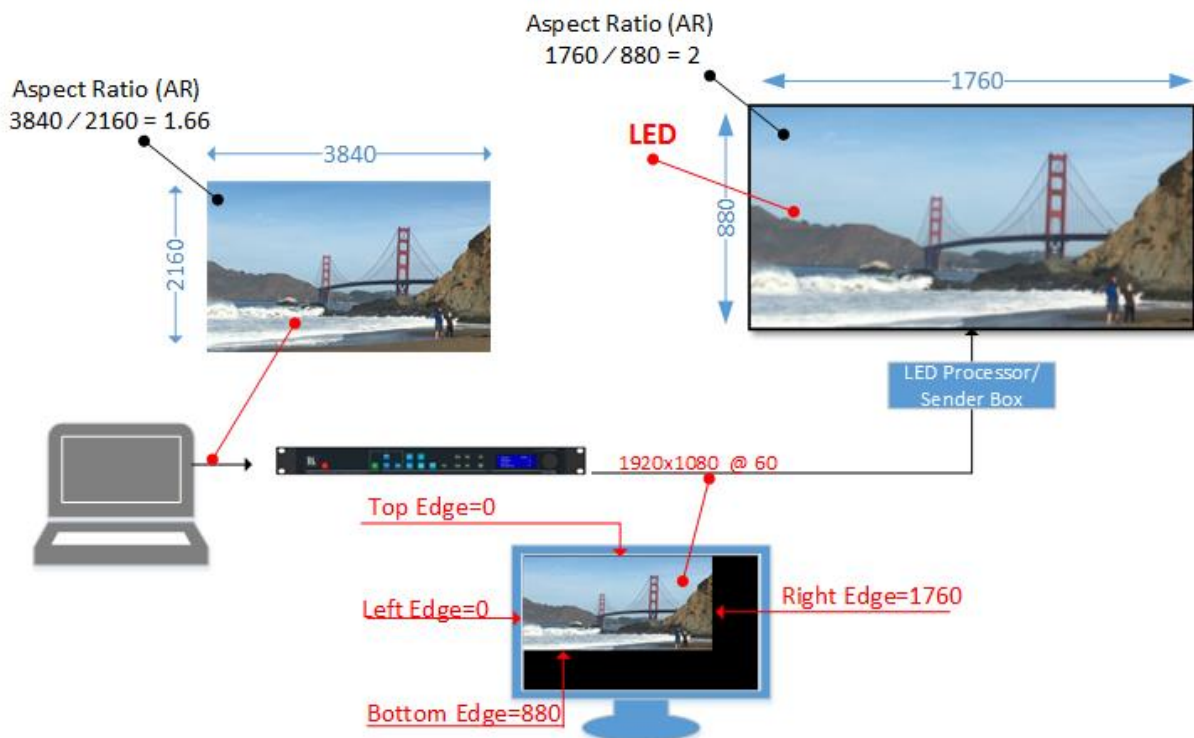

Figure 3: Simple LED Screen Sizing Example

Settings: Left Edge, Right Edge, Top Edge, Bottom Edge

Default: Left Edge=0, Right Edge=Max Horizontal Settings, Top Edge=0, Bottom Edge=Max. Vertical Setting

6.3.1 Few words about Aspect Ratio

In the example above, the aspect ratio of the input source is 1.66, but the LED wall aspect ratio is 2. When the source and the output aspect ratios do not match, the user has three options. These options are explained in the Picture Format section that is found under the Input/Geometry chapter of this document.

In the example, the “Original” option was chosen maintaining the source aspect ratio. With this option, all objects appear proportional and normal in the output image, but a portion of the source content was disregarded. As it can be seen in the picture, a small slice of the top and the bottom of the image has been disregarded.

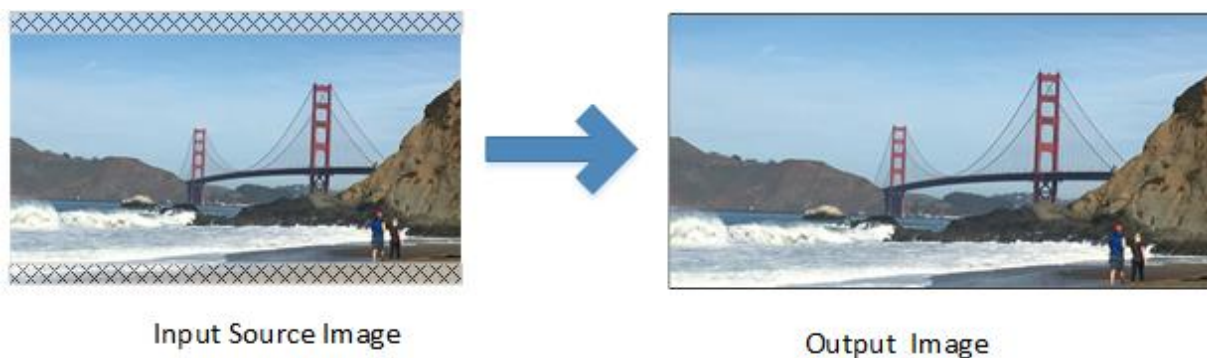

Figure 4: Maintaining the Aspect Ratio Example

6.3.2 Splicing Zoom

In configurations where multiple units are driving different portions of a large LED wall, each unit needs to be setup separately. The user needs to define the system configuration, the section of the LED that each unit will drive and the portion of the image that it will process.

This selection switches on the splicing zoom feature to enable the resizing of the section corresponding to the unit. When Splicing zoom is turned on, the processor will cut and scale the portion of the picture selected by the matrix size and position selected as described next. Splicing Zoom should be turned off when the unit is connected to a multi-head graphics card where the content has been split.

Settings: On/Off
Default: Off



6.3.3 Splicing Width / Splicing Height

This menu defines the dimensions of the LED wall is defined with this menu. The maximum number of LED screens supported is 16. This function is used in conjunction with the next function.

Settings:

Units Wide: 1, 2, 3, 4

Units High: 1, 2, 3, 4

Default:

Units Wide: 1

Units High: 1

6.3.4 Splicing Horizontal Position (Splicing H-pos) / Splicing Vertical Position (Splicing V-pos)

These settings provide the coordinates of the segment that the unit will process (cut out and resize). This function is used in conjunction with the previous function.

Settings: 1 to 4 indicating co-ordinates 1,1, to 4,4 for the maximum matrix size of 16

Default : 1, 1

6.3.5 Splicing Setup

In a large LED walls where multiple units are driving different sections of the LED, the sections can be equal or unequal in size. If the size of the different sections are equal, then the configuration is standard. For standard configurations the settings discussed so far are sufficient to defined the area where the output image will be displayed.

If the size of the sections are unequal, then the Advanced splicing setup needs to be enabled in order to define the size of the area each section.

Standard mode works up to a wall size of 4x4. Advanced mode is limited to a maximum wall size of 2x2.

Settings: Standard / Advanced

Default : Standard

6.3.6 Standard Splicing

The following figure illustrates how to setup two units in the standard configuration mode.

6.3.6.1 Standard Splicing - 2x1 Example (pre-split source)

The following figure illustrates how to setup two units in the standard configuration mode. In the first example, the input image is pre-split at the source, so the Splicing Zoom feature is turned Off

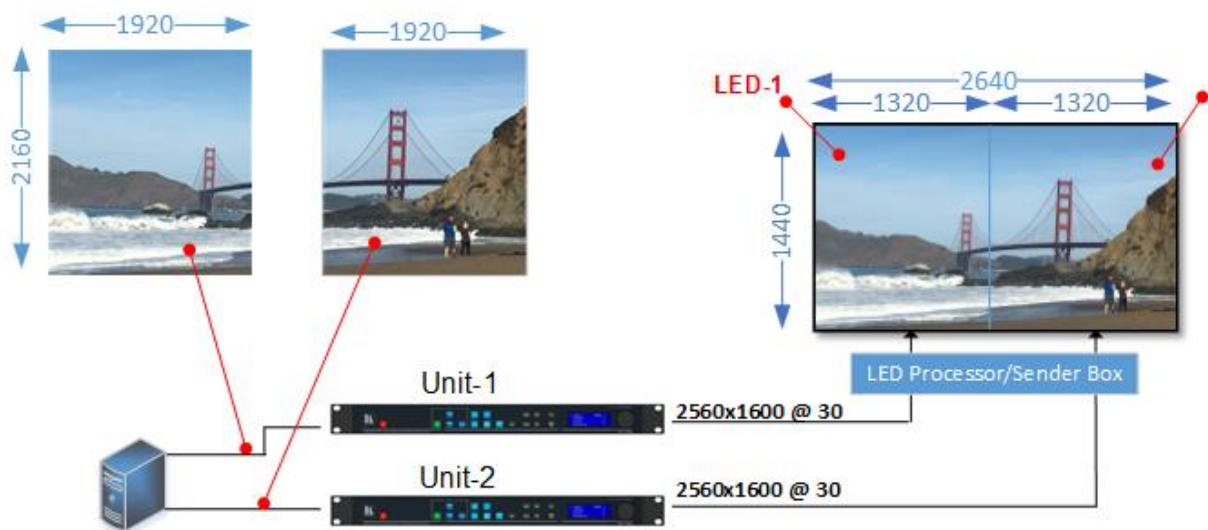

Figure 5: Standard Splicing - 2x1 example (pre-split source)

STEP	MENU ITEM TO MODIFY	Unit-1	Unit-2
1	Output>Display Type>I/O Lock	Source	Source
2	LED Screen Size> Splicing Zoom	Off*	Off*
3	LED Screen Size> Splicing Width	1*	1*
4	LED Screen Size> H-Pos	1*	1*
5	LED Screen Size> Right Edge	1320	1320
6	LED Screen Size> Bottom Edge	1440	1440

* Some steps are skipped, because the values are the same as the default settings after factory reset

6.3.6.2 Standard Splicing - 2x1 Example (Split source)

In this and the rest of the examples, it is assumed that the image arrives at each unit from a single source, so Splicing Zoom is set to On.

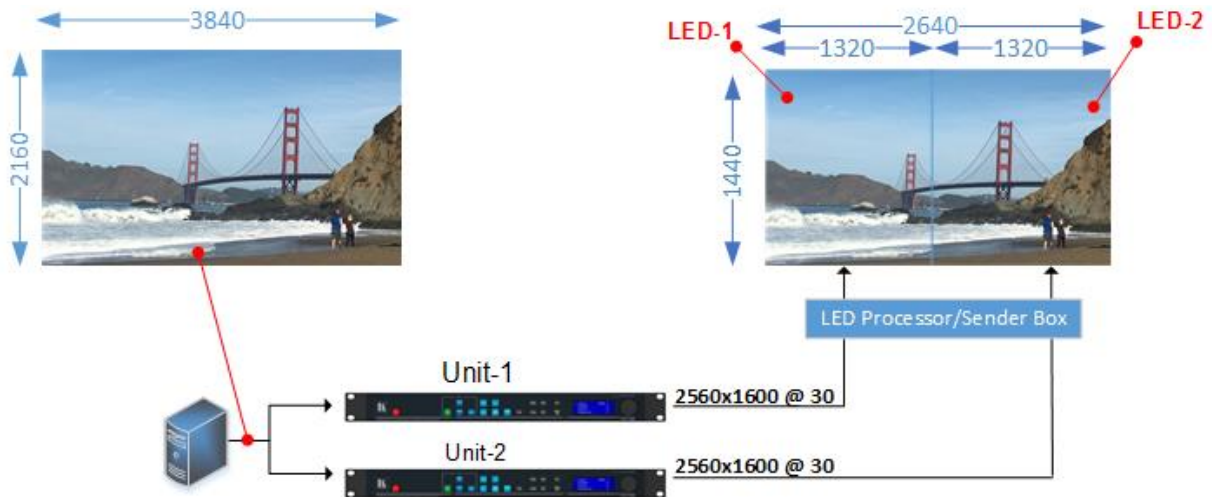

Figure 6: Standard Splicing - 2x1 example (common source)

STEP	MENU ITEM TO MODIFY	Unit-1	Unit-2
1	Output>Display Type>I/O Lock	Source	Source
2	LED Screen Size> Splicing Zoom	On	On
3	LED Screen Size> Splicing Width	2	2
4	LED Screen Size> H-Pos	1*	2
5	LED Screen Size> Right Edge	1320	1320
6	LED Screen Size> Bottom Edge	1440	1440

* Some steps are skipped, because the values are the same as the default settings after factory reset

6.3.7 Advanced Splicing

In this menu, you can define the total dimension of the LED wall with the wall width and height settings.

The portion of the output to be displayed is defined by the Horizontal and Vertical offset settings. .

Wall Width : Total Wall width

Wall Height: Total Wall Height

Hor Offset : The horizontal position within the total wall space where the image will be place

Ver Offset : The vertical position within the total wall space where the image will be place

6.3.7.1 Advanced Splicing – 2x1 Example

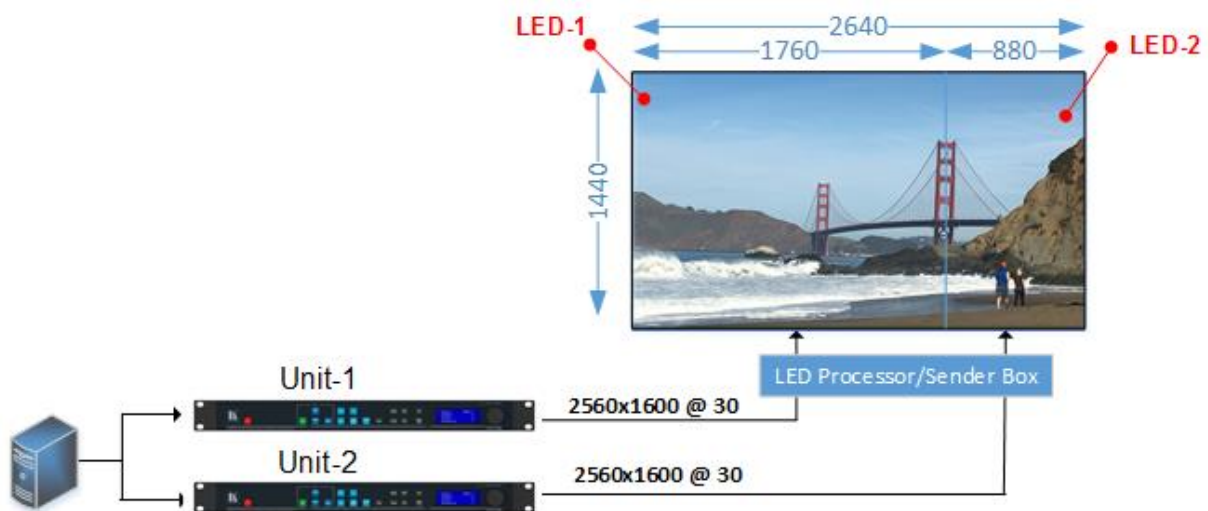

Figure 7: 2x1 Advanced LED Screen Splicing example

STEP	MENU ITEM TO MODIFY	Unit-1	Unit-2
1	Output>Display Type>Output Mode	2560x1600	2560x1600
2	Output>Display Type> Frame Rate	30Hz	30Hz
3	Output>Display Type>I/O Lock	Source	Source
4	LED Screen Size> Splicing Zoom	On	On
5	LED Screen Size> Splicing Width	2	2
6	LED Screen Size> H-Pos	1*	2
7	LED Screen Size> Right Edge	1760	880
8	LED Screen Size> Bottom Edge	1440	1440
10	LED Screen Size> Splicing	Advanced	Advanced
12	LED Screen Size> Advanced Splicing> Wall Width	2640	2640
13	LED Screen Size> Advanced Splicing> Hor. Offset	0*	1760

*** Some steps are skipped, because the values are the same as the default settings after factory reset**

6.3.7.2 Advanced Splicing – 3x1 Example

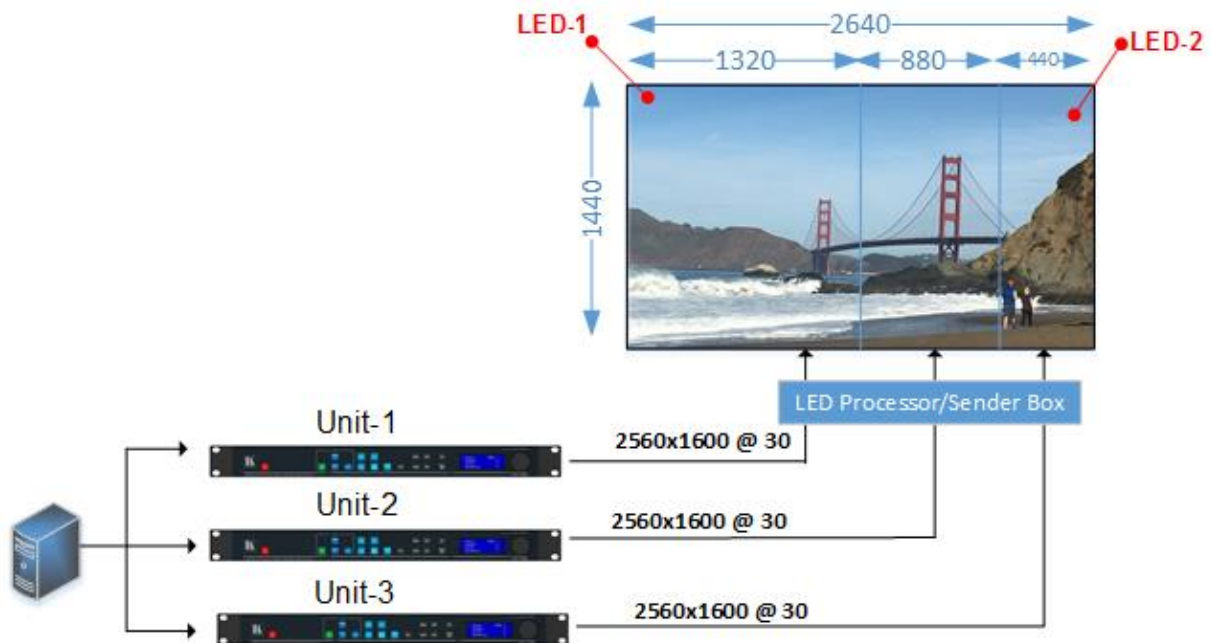

Figure 8: Advanced Splicing - 3x1 example

STEP	MENU ITEM TO MODIFY	Unit-1	Unit-2	Unit-3
1	Output>Display Type>Output Mode	2560x1600	2560x1600	2560x1600
2	Output>Display Type> Frame Rate	30Hz	30Hz	30Hz
3	Output>Display Type>I/O Lock	Source	Source	Source
4	LED Screen Size> Splicing Zoom	On	On	On
5	LED Screen Size> Splicing Width	3	3	3
6	LED Screen Size> H-Pos	1*	2	3
7	LED Screen Size> Right Edge	1320	880	440
8	LED Screen Size> Bottom Edge	1440	1440	1440
10	LED Screen Size> Splicing	Advanced	Advanced	Advanced
12	LED Screen Size> Advanced Splicing> Wall Width	2640	2640	2640
13	LED Screen Size> Advanced Splicing> Hor. Offset	0*	1320	2200

* Some steps are skipped, because the values are the same as the default settings after factory reset

6.3.7.3 Advanced Splicing – 1x2 Example

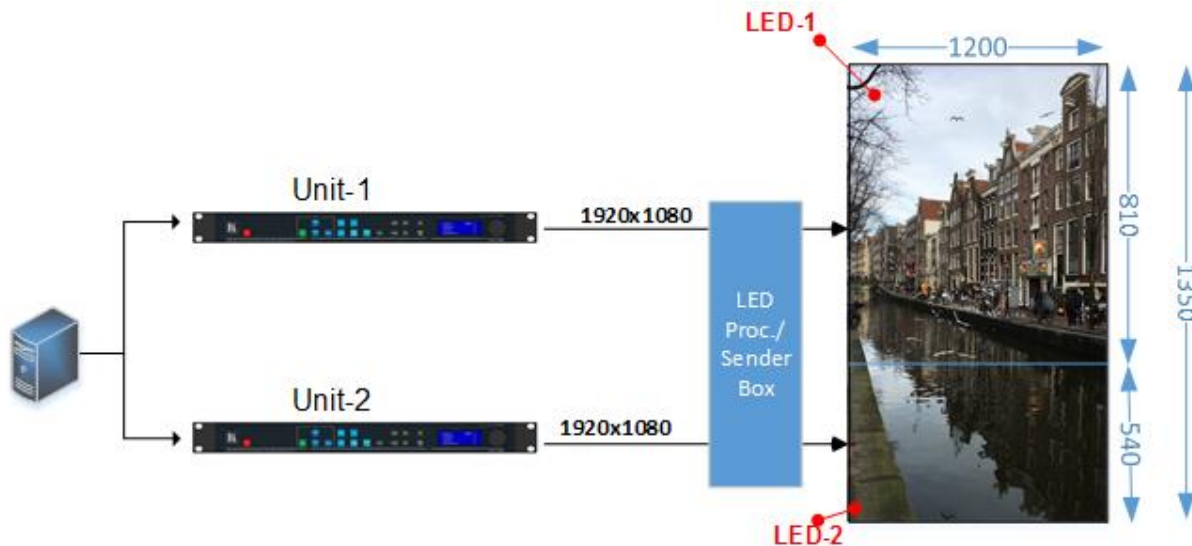

Figure 9: Advanced Splicing - 1x2 example

STEP	MENU ITEM TO MODIFY	Unit-1	Unit-2
1	Output>Display Type>Output Mode	1920x1080*	1920x1080*
2	Output>Display Type> Frame Rate	60Hz*	60Hz*
3	Output>Display Type>I/O Lock	Source	Source
4	LED Screen Size> Splicing Zoom	On	On
5	LED Screen Size> Splicing Width	1*	1*
6	LED Screen Size> Splicing Height	2	2
7	LED Screen Size> V-Pos	1*	2
8	LED Screen Size> Right Edge	1200	1200
9	LED Screen Size> Bottom Edge	810	540
10	LED Screen Size> Splicing	Advanced	Advanced
11	LED Screen Size> Advanced Splicing> Wall Width	1200	1200
12	LED Screen Size> Advanced Splicing> Wall Height	1350	1350
13	LED Screen Size> Advanced Splicing> Ver. Offset	0*	810

* Some steps are skipped, because the values are the same as the default settings after factory reset



6.4 System

This selection contains functions which are more applicable to system operation than to picture adjustment.

6.4.1 User

Several unit settings can be stored under a user name. Different users can store their preferred settings and recall them by selecting their user name.

User settings are stored automatically and no special action is required by the user. For example, if the setting is changed from USER1 to USER2, then all of unit's parameters at the time of the change will be stored under USER1. When the unit is changed back to USER1, the USER1 settings will be loaded back to the unit.

Using the Web interface any number of settings can also be stored/restored to/from the PC.

Settings: USER 1, 2, 3, 4, 5, 6, 7, 8, 8, 10

Default : USER 1

6.4.2 Names/Profiles

The Names/Profiles menu provides input masks to rename the generic input channels and user names. User names and input channel names can be changed to any word with a maximum of 12 alpha numeric characters with a value range of 0-9, A-Z and blank.

The unit itself can be given a name. The default name is VIDEOPROC. This name followed by the MAC address is used by the web server and being displayed in the unit line of the webpage.

6.4.3 Menu Settings

This menu allows users to change the menu display time, i.e. the time after which the LCD menu is switched back to the main status screen again with no user interaction.

From this menu you can change the language and also lock the keyboard. To unlock the keyboard a combination of keys has to be pressed at the same time. The locking of the keyboard is indicated by a message that the keypad is locked. The message also specifies the key press combination necessary to unlock the unit. When successfully unlocking the keypad the message shows up: Keypad unlocked.

The backlight level of the LCD can be set in this menu.

The background colour of the web pages can be changed from dark to light.

6.4.3.1 Language

Settings: English (AE), English (BE), Deutsch

Default: English (AE)

6.4.3.2 Keypad Lock

Settings: Off, Menu Only, All Keys

Default: Lock: Off



6.4.3.3 Menu Time

This is the time the menu remains at the current level when no activity is detected.

Settings: 5, 10, 15, 20, 25, 30, Infinite

Default: 30 secs

6.4.3.4 LCD Backlight

Settings: 0 ..10

Default: 10

6.4.3.5 Jog Push Enable

Settings: On, Off

Default: On

6.4.3.6 Web Colors

Settings: Dark, Light

Default: Dark



6.4.4 Network Settings

The Network Settings menu allows users to configure the unit's TCP/IP address. Under Address Type a static or DHCP leased address can be chosen. The static address, gateway address and netmask needs to be entered manually.

The Network Settings menu provides information on the DHCP Status and IP address assigned to the unit, as well as the fixed MAC Address programmed into the unit. The DHCP status can be Off when a static assignment is used. When DHCP is on, the menu displays the leased address. If the lease is unsuccessful, the menu displays "none"

When changing from DHCP to Static mode or vice versa it is strongly recommended that you cycle the power to the unit in order the change is properly recognized by other devices on the network.

If you select Static, ensure that the IP address of the computer is on the same network and it has the same subnet mask and is in the same range as the unit. If the unit is at 169.254.0.1 and the computer address is at 192.168.215.5, you need to change the unit's IP address to an address that is in close range with the computer, for example: 192.168.215.25. The unit's IP address can be changed with the rotary wheel. First push knob to enter the edit mode. Then turn the knob to increment or decrement each digit and press the knob to move the cursor to the next digit. When you finish changing the IP address, scroll down the menu and select "Apply" for the Network setting changes to become effective.

Settings: Static, DHCP

Default: DHCP

Make sure that no devices on the network that share the same IP address

6.4.5 Security Settings

The password for ftp and web access to the unit can be changed in this menu.

FTP password Default: user

WWW password : Off

6.4.6 Factory Defaults

This button allows users to restore all settings to the default values of the unit, allowing the unit to return to a known (good) system state. A confirmation is requested prior to actual system settings restore.

Factory default does not affect the Network Settings



6.5 Audio

This selection contains functions required to manage the audio inputs and outputs

6.5.1 **Mic 1,2 Level, Mix, Mute**

The Level setting defines the audio level for the Microphone inputs. Mix adjustment controls the mixing between Mic and the selected audio source.

Settings:

Level: -12 to +60
Mix : 0 to 100 (100 is full microphone sound)
Mute: Yes, No

Default :

Level: -6
Mix : 50
Mute: No

6.5.2 **Balance, Treble, Bass**

Balance highlights the sound from the left or right output channels. Treble adjusts high frequency sounds and bass the low frequency sounds.

Settings:

Balance: -100 to +100
Treble : -15 to +15
Bass: -15 to +15

Default :

Balance: 0
Treble : 0
Bass: 0

6.5.3 **Audio Setup**

6.5.3.1 Audio Delay

This settings allows the users to adjust the delay between the video and audio sources.

Settings: -100 to 500 ms

Default : 0 ms

6.5.3.2 Input Level

Input level adjusts the gain of the incoming audio signal

Settings: -12 to +6 db

Default : 0 db



6.5.3.3 Input Mode

Defines whether the incoming audio signal is stereo and mono

Settings: Stereo / Mono

Default : Stereo

6.5.3.4 Input Mute

Enables of the mute function for the selected audio source

Settings: Yes / No

Default : No

6.5.3.5 Amp Gain

Amp gain adjusts the gain for the D-power amp driving speakers.

Settings: 0 to +38 db

Default : 0 db

6.5.3.6 Audio Assign

This menu allows users to assign any analog audio source or mics to the selected input. If the selected input is digital, the user can also select the audio that is embedded to the video signal. These selections can be performed on per input basis or globally.

6.5.3.6.1 Config

Selects whether the Audio assignments are done per source or globally

Settings: Per Inp / Globally

Default : Per Inp

6.5.3.6.2 Audio In

This menu is enabled when the audio assignments are done globally. If an Analog source is selected, the user also choose the analog audio source from the next menu (Analog In). If a Digital source is selected, the embedded audio in the selected audio source will be used.

Settings: Stereo Analog / Analog with Mic / Digital

Default : Stereo Analog

6.5.3.6.3 Analog In

This menu is enabled when the audio assignments are done globally. From this menu the user selects the audio source to be assigned to the selected input

Settings: CVBS / HDBaseT / Display Port / HDMI 1 / HDMI 2 / VGA / DVI / HDMI 3

Default : CVBS



6.5.3.6.4 Analog Inputs

This menu is enabled when the audio assignments are done per Input.

For each of the analog video sources the user can select a Stereo Analog source or a Stereo analog source with the mics. The user can also selected which of the analog source will be assigned to the input.

Settings: Stereo Analog / Analog with mic

Default : Stereo Analog

For the analog audio source:

Settings: CVBS / HDBaseT / Display Port / HDMI 1 / HDMI 2 / VGA / DVI / HDMI 3

Default : The corresponding analog input associated with the video input

6.5.3.6.5 Digital Inputs

This menu is enabled when the audio assignments are done per Input.

For each of the digital video sources the user can select a Stereo Analog source, a Stereo analog source with the mics, or the corresponding embedded audio within the video signal. If an analog source is selected, the user can also selected which of the analog source will be assigned to the input.

Settings: Stereo Analog / Analog with Mic / Digital

Default : Digital

If an analog audio source is selected :

Settings: CVBS / HDBaseT / Display Port / HDMI 1 / HDMI 2 / VGA / DVI / HDMI 3

Default : The corresponding analog input associated with the video input

6.5.3.7 Mic Config

This menu allows users to enable phantom power for condenser mics. When phantom power is enabled, a voltage of +48V is sent to the condenser microphone via the XLR socket.

6.5.3.8 Audio Out Mute

This menu allows users to mute audio output source individually.



6.6 Status

This menu provides status information of the connections to the HDMI2, DVI/HDMI1 and HDBT outputs. The unit reads the EDID of the attached monitor and makes decision based on its capabilities and the configuration of the unit (Deep Colour and HDCP support). The type of attached monitor (DVI or HDMI), video bit depth (8, 10 or 12 bit per colour channel) and HDCP encryption (on/off) is displayed.



7. Web Browser Control

The unit can be remotely controlled from a PC or any mobile device. No additional software needs to be installed on the PC. The PC web browser is used as the graphical user interface for all control items. To connect to the unit the TCP/IP address of the unit has to be entered into the address list box of the web browser in the following format <http://xxx.xxx.xxx.xxx>. The TCP/IP address assigned to the unit can be found in the System/Network Settings menu.

7.1 Connecting to the unit

The Network Settings menu of the unit allows to configure the unit's TCP/IP address. Under Address Type a static or DHCP leased address mode can be selected. The factory default of the unit is DHCP. The static address and Netmask needs to be entered manually.

The Network Settings menu provides information on the DHCP Status and the IP address assigned to the unit as well as the fixed MAC Address of the unit. The DHCP status is Off when the static assignment is selected. If the unit has an assigned address, then the menu displays the address, or "None" if the lease was not successful.

When changing from DHCP to Static mode or vice versa, it is strongly recommended that you cycle the power to the unit in order the change is properly recognized by other devices on the network

After the correct IP address is entered into the address bar, the web browser starts to load the menus mirroring the status of the unit. All menu items are shown as their respective buttons, sliders and list boxes and can be accessed and altered with the PC mouse or corresponding navigational key presses.

From the web Browser, under security settings, the user name and Password can be turned on. The default settings are:

User Name: user
Password: user



7.2 Web page menu Orientation

The main page of the web browser is shown below. The Unit ID is displayed on the first line and is composed of the identifier PV7 followed by the MAC address. The firmware version number and information on the input mode are listed next.

Under the information pane the available input channels are shown and can be activated directly.

The screenshot displays the KRAMER web interface. At the top, the KRAMER logo is shown next to the unit name "VIDEOPROC (PV7-00-52-88)". Below this, the version "VP-796A 1.15.8 build 3260" and the current input resolution "No Signal" are displayed. A section titled "Inputs" contains buttons for DP, HDMI 2, DVI, RGB/YPbP, HDMI 3, LOGO, HDMI 1, HDBT, VGA, CVBS, and TESTPAT. Below the inputs is a "Main Menu" section with a volume slider set to -250 and a dropdown menu currently showing "HDMI 1". The main menu includes links for Output, Color, Geometry, Video Wall, Enhancement, System, Audio, Status, File Upload, Backup / Restore, and Firmware Update.



The menu system can be navigated with the PC mouse. Move the mouse pointer over the menu item and click the left mouse button to open a submenu. Submenus have three dots followed by the menu name. Move the mouse pointer over the Back item and click the left mouse button to go back to the prior menu.

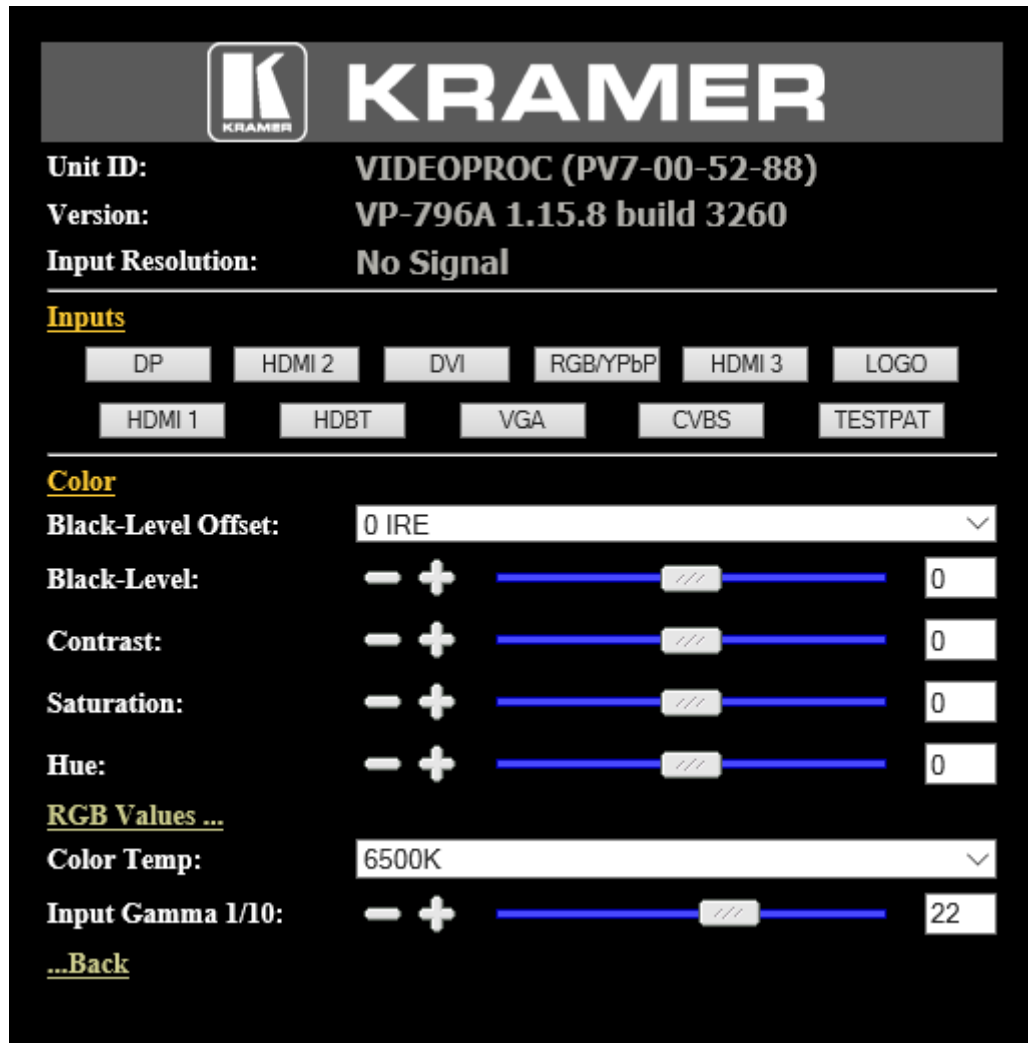

Menu items can be lists, sliders or alpha numeric fields.

A list item can be activated by moving the mouse pointer over the list item and clicking the left mouse button. The list comes up and an item can be selected by moving the mouse pointer to the desired value (here: 0 IRE) and clicking the left mouse button again.

A slider value can be changed by moving the mouse pointer over the slider, click and hold the left mouse button and move the mouse to the right or left to decrease or increase the value. Also, the slider can be controlled in single steps with the mouse wheel. Or by moving the mouse pointer over the – or + fields and clicking the left mouse button..

Values can be entered directly in the field beneath the slider. Click into the field, enter the new value through the PC keyboard and click with the left mouse button to any location outside the field to update to the new value.



Renaming the input channel is used as an example to explain the alpha numeric field changes. Move the mouse pointer into the alpha numeric field and click on the left mouse button. The cursor can be controlled with the right/left and back space keys of the PC keyboard. The new name for the input channel can be entered.

The new name is stored when clicking with the left mouse button to any location outside the field.

KRAMER

Unit ID: VIDEOPROC (PV7-00-52-88)
Version: VP-796A 1.15.8 build 3260
Input Resolution: No Signal

Inputs

DP HDMI 2 DVI RGB/YPbPr HDMI 3 LOGO
HDMI 1 HDBT VGA CVBS TESTPAT

Input names

DP :	DP
HDMI 1 :	HDMI 1
HDMI 2 :	HDMI 2
HDBT :	HDBT
DVI :	DVI
VGA :	VGA
RGB/YPbPr:	RGB/YPbPr
CVBS :	CVBS
HDMI 3 :	HDMI 3
TESTPAT :	TESTPAT
LOGO :	LOGO

[...Back](#)



7.3 Software Update

A page for file uploads is provided. Browse a firmware file (extension .bin) and select it. The path and name will be shown in the field left to the Browse button. Now click the update button.

Unit ID: VIDEOPROC (PV7-00-52-88)
Version: VP-796A 1.15.8 build 3260

Firmware Update

Firmware Update:

1. Select file

Browse...

2. Push Update Button

Update

[...Back](#)

7.4 Backup and restore

The unit set-ups can be backed up to a PC and restored later through the web browser. When pressing the Backup button a file download dialog box appears. The default name of a backup is nvram.bin. This name can be changed and stored on the PC in any location.

To restore the unit's settings, browse and select the file on your PC. The selected file will be shown in the field left to the Browse button. Now press the restore button.

Unit ID: VIDEOPROC (PV7-00-52-88)
Version: VP-796A 1.15.8 build 3260

Backup / Restore

Backup settings to file:
Push Backup button

Backup

Restore settings from file:

1. Select file

Browse...

2. Push Restore Button

Restore

[...Back](#)



7.5 LOGO and Custom Test Pattern Capture

Any image in PNG format can be selected from your PC and loaded to the unit to be used as a LOGO. This name can be changed and stored on the PC in any location. The image size limitation is 64MB.

From the same menu you can select up-to four images and download them as custom test patterns. These images will appear as Custom1,2,3 or 4 in the Test pattern menu

KRAMER

Unit ID: **VIDEOPROC (PV7-00-52-88)**
Version: **VP-796A 1.15.8 build 3260**

File Upload

Logo [PNG, max. 64MB]:
[Text Field] Browse...
Upload Delete

Custom test pattern #1 [PNG, max. 64MB]:
[Text Field] Browse...
Upload Delete

Custom test pattern #2 [PNG, max. 64MB]:
[Text Field] Browse...
Upload Delete

Custom test pattern #3 [PNG, max. 64MB]:
[Text Field] Browse...
Upload Delete

Custom test pattern #4 [PNG, max. 64MB]:
[Text Field] Browse...
Upload Delete

[...Back](#)



8. Firmware Update

The latest firmware is found on Kramer's download website at:

There are two methods of updating your unit's firmware. First, through a USB port with a USB memory drive and second, through TCP/IP connection with the web server.

8.1 USB update

- From the firmware dropdown menu, select the "PV7S PQV6xx_HQU7xx_LED7xx-2\xxxx.bin" file where XXXX is the latest firmware built number.
- Download the .bin file and rename it "PV7update.bin"
- Copy the file to the root directory of a USB memory stick
- Power Off the unit and plug the USB drive into one of the USB ports
- Power On the unit and wait few seconds for the message to remove the USB drive
- After the USB is removed, the unit will continue the boot-up process.
- Wait until the boot up processes is completed, and the status menu appears on the front panel screen. The Status menu indicates the detected source, Output resolution and I/O lock state.

```
In: 1920x1080p 59Hz
HDMI 1
Out:3840x2160p 60Hz
Free Run
```

8.2 Web Browser update

To update via the web server, please follow the steps outlined previously in the web browser control chapter.

8.3 System restore from an image file

If power is lost during the update procedure, the unit may fail to complete the process and even fail to bootup. In this case, the system software can be restored to a previous version using an image file found on the website.

- Download the pv7.restore.img file to your computer. Be aware that this is a large file, approximately 130MB, and depending on your internet connection the download time may be long.
- Copy the file to the root directory of a USB memory stick
- Power Off the unit and plug the USB drive into one of the USB ports
- Power On the unit while pressing the Standby button on the front panel
- Keep the Standby button pressed and wait a few seconds until a message appears asking you to remove the USB drive



- After the USB is removed, the unit will continue the restore and boot-up process.
- When the boot up process is completed, the status menu will appear on the front panel screen.
- Press the Esc button and while the button is pushed in, press the Standby button to view the software version loaded into the unit. Hit the Menu Sel button to exit to the Status menu

Next, follow either of the methods described earlier in this chapter to update the unit to the latest software release.



9. ENVIRONMENTAL AND EMC

9.1 Recommended Operating Conditions

Temperature 0°C to 40°C
Humidity (non-condensing) 5% to 95%

9.2 Storage

Temperature -25°C to +85°C
Humidity 0% to 95%

9.3 CE and FCC Compliance

CE: This product complies with the requirements of 2004/108/EC Electromagnetic Compatibility Directive, and 2006/95/EC Low Voltage Directive. Compliance is to EN55022 Class A.

FCC: **WARNING:** This equipment has been tested and found to comply with the limits for a Class A digital device pursuant to Part 15 of the FCC Rules. These limits are designed to provide reasonable protection against harmful interference when the equipment is operated in a commercial environment. This equipment generates uses and can radiate radio frequency energy and, if not installed and used in accordance with the instruction manual, may cause interference to radio communications. Operation of this equipment in a residential area is likely to cause interference in which case the user will be required to correct the interference at their own expense.

The user is cautioned that changes and modifications made to the equipment without approval of the manufacturer could void the user's authority to operate this equipment.

It is suggested that the user use only shielded and grounded signal cables to ensure compliance with FCC rules.

9.4 PAT Testing

Earth continuity testing under PAT regulations shall be done to the product with 8A or 10A only. A test with 25A may damage the product.

Since the unit is classified as an IT equipment, according to the IEE Code of Practice, the test can also be performed with 20-200mA. If this method is not available, and a high current test is to be used instead, a 8A or 10A test is also acceptable (a minimum of 1.5 times of the unit's internal 5A fuse).

Always connect the test lead (mains earth) to the metal chassis. **DO NOT CONNECT** to the connectors of the rear panel (signal earth), because you may damage the unit beyond repair. This type of damage **is not covered** by warranty.



APPENDIX A: FRONT PANEL MENU TREE STRUCTURE

After the unit boots up, the Status menu is presented on the front panel display. The user can enter the main menu by pressing the MenuSel button or the jog wheel.

The Main Menu tree is composed of the following sections :

- Input
- Output
- LED Screen Size (VP-798ASV model only)
- PIP* (not available in VP-796(A)(ASV) Models)
- System
- Status
- Audio (Audio Models: Extensive audio menu is presented in Appendix B)

* Future software release

Input

Input Menu

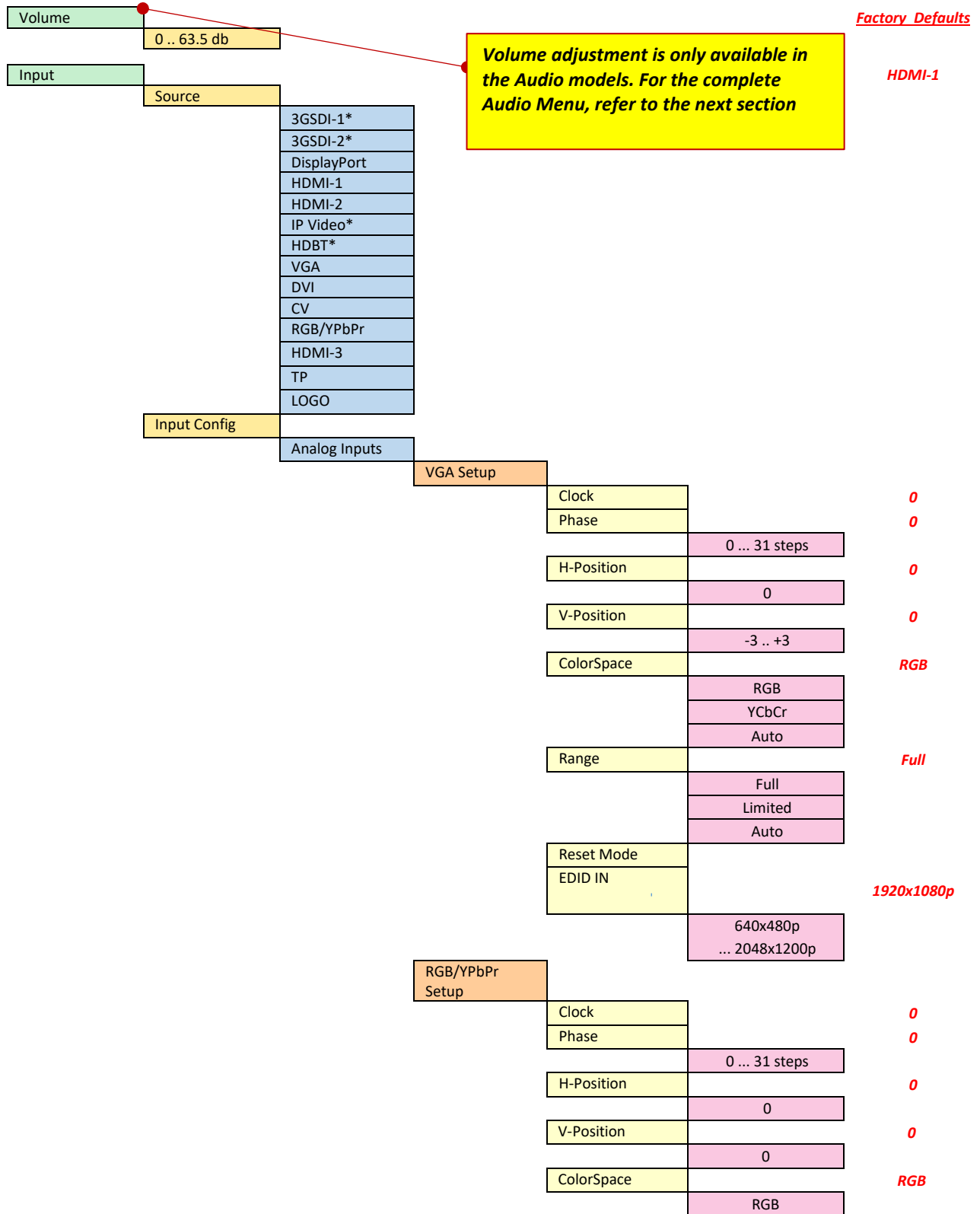



Input Menu

		YCbCr	
		Auto	
	Range		<i>Full</i>
		Full	
		Limited	
		Auto	
	Reset Mode		
CVBS Setup			
	CCS		<i>On</i>
		Off / On	
Digital Inputs			
	DP Config		
	HDMI-1 Config		
	HDMI-2 Config		
	HDBT Config*		
	DVI Config		
	HDMI-3 Config		
	Colorspace		<i>RGB</i>
		RGB	
		YCbCr	
	Range		<i>Auto</i>
		Auto	
		Full	
		Limited	
	Deep Color		<i>Auto</i>
		Auto	
		On	
		Off	
	EDID In (for DP, HDMI1&2&HDBT)		<i>3840 x 2160p</i>
		640x480p to 4096 x 2160 p	
	EDID In (for DVI & HDMI-3)		<i>1920x1080p</i>
		640x480p to 2560x1080p	
	HDCP		<i>On</i>
		On	
		Off	
HDMI Audio			<i>Full</i>
	Full		
	Match Display 1		
	Match Display 2		
	S/PDIF friendly		
	SDI friendly 2-ch		
	SDI friendly 8-ch		
SDI Setup*			<i>Stereo ch(1,2)</i>
	Audio Map		
		Stereo ch(1,2)	
		Stereo ch(3,4)	
		Stereo ch(5,6)	
		Stereo ch(7,8)	
		Multichannel	
	Level B priority		<i>SDI 1</i>
		SDI 1	
		SDI 2	



Input Menu

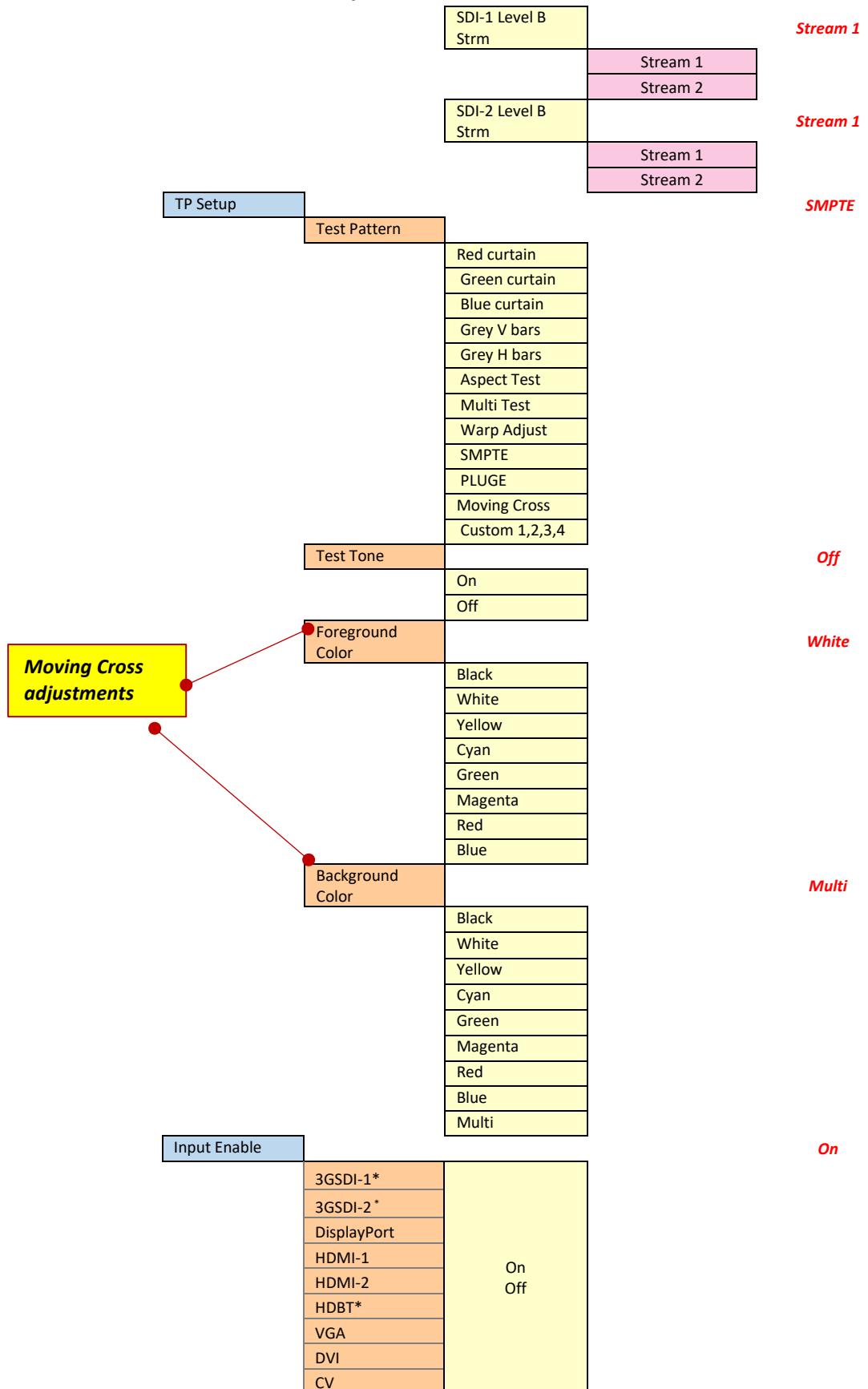



Input Menu

	RGB/YpPr		
	HDMI-3		
Switching Trans.			<i>Freeze</i>
	Freeze		
	Blank		
	Fast Fade		
	Slow Fade		
Video Streaming			<i>Freeze</i>
	IP Address		
	Port		
	Name		
	Start		
	Stop		
	Auto Start		
		Off	
		Button	
		Bootup	
	Auto Reconnect		
		Off	
		On	
Custom Modes			
	CM 1-4 Width		
		640 to 4096	<i>1920</i>
	CM 1-4 Height		
		480 to 2160	<i>1080</i>
	CM 1-4 Type		
		Progressive	<i>Progressive</i>
		Interlaced	
Color			
	BL-Offset		<i>0 IRE</i>
		0 IRE	
		7.5 IRE	
	Brightness		<i>0</i>
		-50 ... 50 steps	
	Contrast		<i>0</i>
		-50 ... 50 steps	
	Saturation		<i>0</i>
		-50 ... 50 steps	
	Hue		<i>0</i>
		-50 ... 50 steps	
	RGB Values		
	Red Bias		<i>0</i>
		-512 ... 512	
	Red Gain		<i>0</i>
		-512 ... 512	
	Green Bias		<i>0</i>
		-512 ... 512	
	Green Gain		<i>0</i>
		-512 ... 512	
	Blue Bias		<i>0</i>
		-512 ... 512	
	Blue Gain		<i>0</i>
		-512 ... 512	
	Color Temp		<i>6500K</i>

Input Menu

		3200K	
		3700K	
		5500K	
		6500K	
		7500K	
		9300K	
	Input Gamma	1.0 ... 3.0	1.0
Geometry	Pict. Format	Original Full Screen Crop Anamorphic	Full Screen
	Overscan	0%.. 10%	0
	Pan/Tilt/Zoom	PTZ Enable	Off
		PTZ Setting	Off, On
		PTZ Value	Per Input
		Pan	Pixels
		Tilt	Percent
		Zoom H	0
		Aspect Lock	0
		Zoom V	0
		PTZ Reset	0
Enhancement	Sharpness	-4 ... 4 steps	0
	Details	0 ... 3 steps	0



Output

Output Menu

		<i>Factory Defaults</i>
Output	Display Type	
	O/P Mode	<i>1920x1080p</i>
	640x480p.....	
	4096x2160p	
	Custom 1 -4*	
	CM 1-4 Width	
	640 to 4096	<i>1920</i>
	CM 1-4 Height	
	480 to 2160	<i>1080</i>
	CM 1-4 Type	
	Progressive	<i>Progressive</i>
	Interlaced	
	Frame Rate	<i>59.94Hz</i>
	23.98Hz ... 60Hz	
	I/O Lock	<i>Off</i>
	Off	
	Source	
	Genlock	
	Genlock Offsets	
	H Offset	
	V Offset	
	FR Enable	
	Yes / No	
	Gamma/ Color/ Crush	
	Native Color	<i>6500K</i>
	3200K	
	3700K	
	5500K	
	6500K	
	7500K	
	9300K	
	Output Gamma	<i>1.0</i>
	1.0 ... 3.0	
	Black Crush*	<i>0</i>
	0 .. 255 steps	
	Output Config	
	HDMI Output	<i>HDMI</i>
	DVI/HDMI	
	DVI Forced	
	HDMI 8-bit	
	HDMI-10bit	
	HDMI 12-bit	
	DVI Output	
	DVI/HDMI	
	DVI Forced	
	HDMI 8-bit	

Output Menu

	HDMI-10bit	
	HDMI 12-bit	
HDCP		<i>On</i>
	On	
	Off	
Color space		<i>RGB</i>
	RGB	
	YPbPr	
Range		<i>Auto</i>
	Full	
	Limited	
	Auto	
Video Wall		
Auto Zoom		<i>Off</i>
	Off, On	
Units Wide		<i>1</i>
	1,2,3,4	
Units High		<i>1</i>
	1,2,3,4	
H-Position		<i>0</i>
	1,2,3,4	
V-Position		<i>0</i>
	1,2,3,4	
Bezel Width		
	L(ef) Bezel	<i>0</i>
	0 pxls ... 50pxls	
	R(ight) Bezel	<i>0</i>
	0 pxls ... 50pxls	
	T(op) Bezel	<i>0</i>
	0 pxls ... 50pxls	
	Bot(tom) Bezel	<i>0</i>
	0 pxls ... 50pxls	
Wall Setup		<i>Standard</i>
	Standard	
	Advanced	
Adv. Wall Setup		
	Wall Width	
	0 pxls ...3840pxls	
	Wall Height	
	0 pxls ...2160pxls	
	Hor Offset	
	0 pxls ...3840pxls	
	Ver Offset	
	0 pxls ...2160pxls	



PiP Menu

PIP Menu

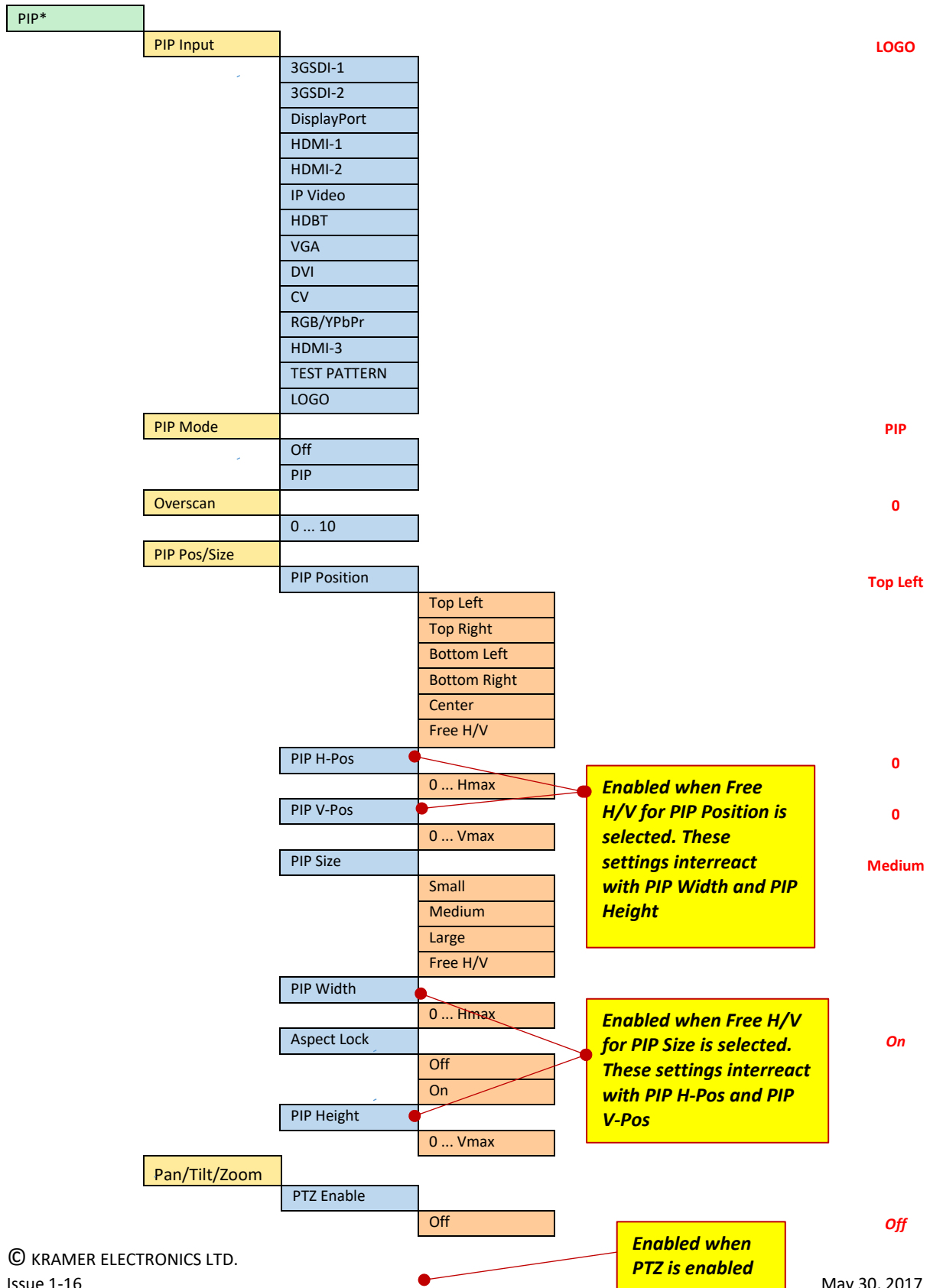



PIP Menu

	On	
PTZ Setting	Global	<i>Global</i>
	Per-input	
	Per-input per-mode	
Pan	-50% ... 50%	<i>0</i>
Tilt	-50% ... 50%	
Zoom H	0 .. Hmax	<i>0</i>
Aspect Lock	Off	
	On	<i>On</i>
Zoom V	0 .. Vmax	<i>0</i>
PTZ Reset		
Color	Black-Level Offset	
		<i>0 IRE</i>
		<i>7.5 IRE</i>
Brightness	-50 ... 50	<i>0</i>
Contrast	-50 ... 50	<i>0</i>
Saturation	-50 ... 50	<i>0</i>
Hue	-50 ... 50	<i>0</i>

Enabled when Aspect Lock is Off



System

System

System			
	Names/Profiles		
		Unit Name	
		Input Names	
			3GSDI-1
			3GSDI-2
			DisplayPort
			HDMI-1
			HDMI-2
			HDBT
			IP Video
			VGA
			DVI
			CV
			RGB/YPbPr
			HDMI-3
			TestPattern
			LOGO
		User Names	
			User 1 ...User 10
	Menu Settings		
		Language	
			English (AE)
			English (BE)
			Deutsch
		Keypad Lock	
			Off
			Menu Only
			All Keys
		Menu Time	
			5 sec
			10 sec
			15 sec
			20 sec
			25 sec
			30 sec
			Infinite
		LCD Backlight	
			0 ..10
		Jog Push Enable	
			On
			Off
		Web Colors	
			Dark
			Light
	Network Settings		
		Address Type	
			DHCP
			Static

System

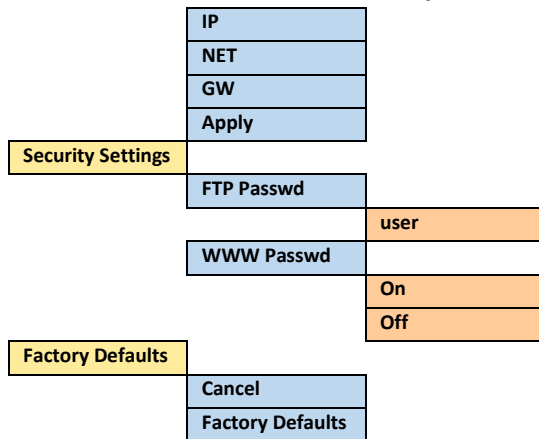

user

off

Status

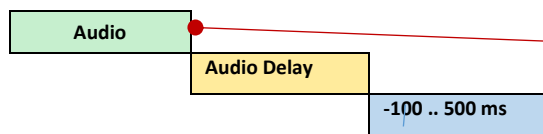
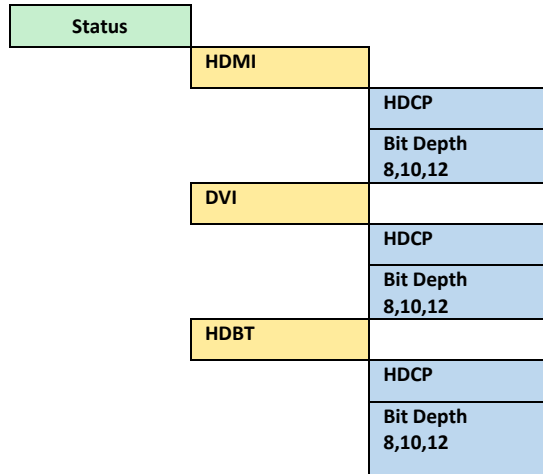

This menu is present in non-audio models. The Audio menu for the Audio models is presented in the next section

0

APPENDIX B: FRONT PANEL AUDIO MENU TREE STRUCTURE

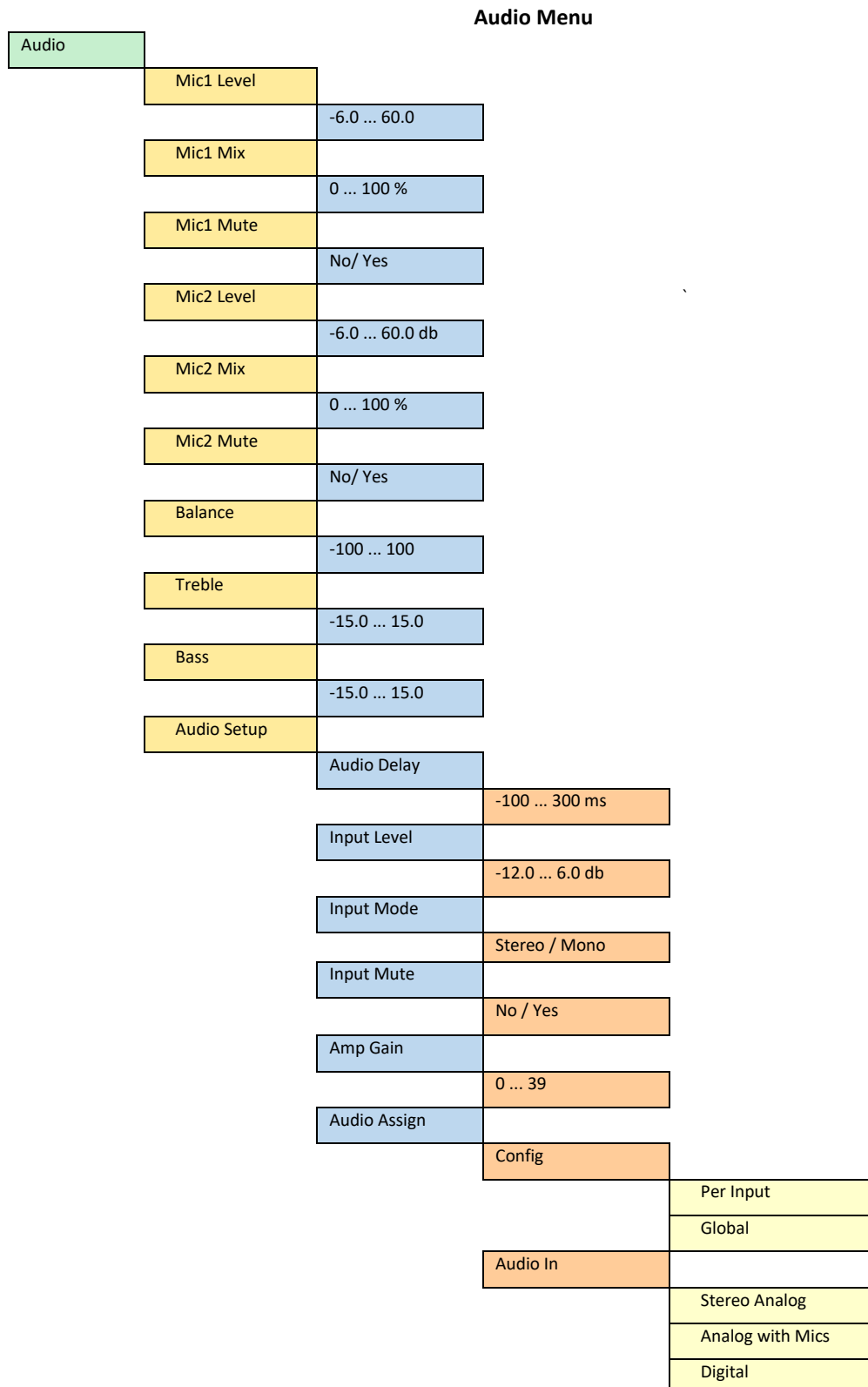



Audio Menu

Analog In	CVBS	
	Display Port	
	HDMI 1	
	HDMI 2	
	VGA	
	DVI	
	HDMI 3	
	HDBaseT	
Analog Inputs	VGA Audio	
		Stereo Analog
		Analog with Mics
	VGA Analog	
		CVBS
		Display Port
		HDMI 1
		HDMI 2
		VGA
		DVI
		HDMI 3
		HDBaseT
	RGB/YPbPr Audio	
		Stereo Analog
		Analog with Mics
	RGB/YPbPr Analog	
		CVBS
		Display Port
		HDMI 1
		HDMI 2
		VGA
		DVI
		HDMI 3
		HDBaseT
	CVBS Audio	
		Stereo Analog
		Analog with Mics
	CVBS Analog	
		CVBS
		Display Port
		HDMI 1



Audio Menu

		HDMI 2
		VGA
		DVI
		HDMI 3
		HDBaseT
	Exit	
Digital Inputs	SDI1 Audio	
		Stereo Analog
		Analog with Mics
		Digital
	SDI1 Analog	
		CVBS
		Display Port
		HDMI 1
		HDMI 2
		VGA
		DVI
		HDMI 3
		HDBaseT
	SDI2 Audio	
		Stereo Analog
		Analog with Mics
		Digital
	SDI2 Analog	
		CVBS
		Display Port
		HDMI 1
		HDMI 2
		VGA
		DVI
		HDMI 3
		HDBaseT
	DP Audio	
		Stereo Analog
		Analog with Mics
		Digital
	DP Analog	
		CVBS
		Display Port
		HDMI 1
		HDMI 2



Audio Menu

	VGA
	DVI
	HDMI 3
	HDBaseT
HDMI1 Audio	
	Stereo Analog
	Analog with Mics
	Digital
HDMI1 Analog	
	CVBS
	Display Port
	HDMI 1
	HDMI 2
	VGA
	DVI
	HDMI 3
	HDBaseT
HDMI-2 Audio	
	Stereo Analog
	Analog with Mics
	Digital
HDMI-2 Analog	
	CVBS
	Display Port
	HDMI 1
	HDMI 2
	VGA
	DVI
	HDMI 3
	HDBaseT
HDBT Audio	
	Stereo Analog
	Analog with Mics
	Digital
HDBT Analog	
	CVBS
	Display Port
	HDMI 1
	HDMI 2
	VGA
	DVI
	HDMI 3



Audio Menu

		HDBaseT
	HDMI-3 Audio	
		Stereo Analog
		Analog with Mics
		Digital
	HDMI-3 Analog	
		CVBS
		Display Port
		HDMI 1
		HDMI 2
		VGA
		DVI
		HDMI 3
		HDBaseT
	DVI Audio	
		Stereo Analog
		Analog with Mics
		Digital
	DVI Analog	
		CVBS
		Display Port
		HDMI 1
		HDMI 2
		VGA
		DVI
		HDMI 3
		HDBaseT
Mic Config	Mic1 Phantom	
		Off On
	Mic2 Phantom	
		Off On
	Exit	
Audio Out Mute	HDMI HDBaseT DVI/HDMI 3G-DVI Line Loudspeaker Exit	On Mute
Exit		

APPENDIX C : Single Link DVI-U Pinout

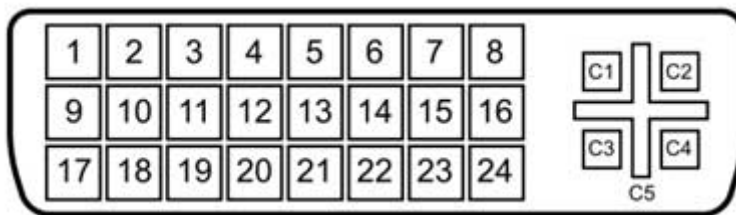

Pin 1	TMDS data 2-	Digital red-
Pin 2	TMDS data 2+	Digital red+
Pin 3	TMDS data 2/4 shield	
Pin 4	TMDS data 4-	
Pin 5	TMDS data 4+	
Pin 6	DDC clock	
Pin 7	DDC data	
Pin 8	Analog vertical sync	
Pin 9	TMDS data 1-	Digital green-
Pin 10	TMDS data 1+	Digital green+
Pin 11	TMDS data 1/3 shield	
Pin 12		
Pin 13		
Pin 14	+5 V	Power for monitor when in standby
Pin 15	Ground	Return for pin 14 and analog sync
Pin 16	Hot plug detect	
Pin 17	TMDS data 0-	Digital blue and digital sync
Pin 18	TMDS data 0+	Digital blue+ and digital sync
Pin 19	TMDS data 0/5 shield	
Pin 20		
Pin 21		
Pin 22	TMDS clock shield	
Pin 23	TMDS clock+	Digital clock+
Pin 24	TMDS clock-	Digital clock-
C1	Analog red	
C2	Analog green	
C3	Analog blue	
C4	Analog horizontal sync	
C5	Analog ground	Return for R, G, and B signals