

**Large Format Display**

# **User's Manual**

**MultiSync C431**

**MultiSync C501**

**MultiSync C551**

MODEL: C431, C501, C551

Please find your model name in the label on the backside of monitor.

# Index

---

DECLARATION OF CONFORMITY .....	English-1
Important Information .....	English-2
WARNING.....	English-2
CAUTION.....	English-2
Safety Precautions, Maintenance & Recommended Use.....	English-3
Safety Precautions and Maintenance .....	English-3
Recommended Use .....	English-3
Ergonomics.....	English-3
Cleaning the LCD Panel .....	English-4
Cleaning the Cabinet .....	English-4
Contents .....	English-5
Installation .....	English-5
Attaching Mounting Accessories .....	English-7
Parts Name and Functions .....	English-9
Control Panel .....	English-9
Terminal Panel .....	English-10
Wireless Remote Control.....	English-11
Operating Range for the Remote Control .....	English-12
Setup .....	English-13
Connections .....	English-15
Wiring Diagram .....	English-15
Connecting a Personal Computer.....	English-16
Connecting a Player or Computer with HDMI.....	English-16
Connecting a Computer with DisplayPort.....	English-16
Connecting a USB device with USB port.....	English-16
Basic Operation.....	English-17
Power ON and OFF Modes .....	English-17
Power Indicator .....	English-18
Using Power Management .....	English-18
Aspect.....	English-18
Media Player.....	English-19
Displayable/playable files .....	English-19
File display screen .....	English-21
Slideshow display .....	English-22
Media Player settings .....	English-22
NETWORK & OTHER SETTINGS.....	English-23
Using SHARED SD card SETTINGS.....	English-24
Using CONTENTS COPY.....	English-25
Using Emergency contents.....	English-25
Information OSD .....	English-25
Picture Mode.....	English-26
OSD (On-Screen-Display) Controls.....	English-27
INPUT .....	English-28
PICTURE .....	English-28
AUDIO .....	English-30
SCHEDULE .....	English-30
MULTI INPUT.....	English-31
OSD .....	English-32
MULTI DISPLAY .....	English-33
DISPLAY PROTECTION .....	English-33
CONTROL .....	English-34
SYSTEM .....	English-36
Remote Control Functions .....	English-38
Controlling the LCD monitor via RS-232C Remote Control.....	English-40
Controlling the LCD monitor via LAN Control .....	English-42
Connecting to a Network .....	English-42
Network Setting by Using an HTTP Browser.....	English-42
POINT ZOOM.....	English-50
Features .....	English-51
Troubleshooting.....	English-52
Specifications - C431 .....	English-54
Specifications - C501 .....	English-55
Specifications - C551 .....	English-56
Manufacturer's Recycling and Energy Information.....	English-57
[Notice] About the MPEG AVC, MPEG-4 Visual license included in this product .....	English-58

## DECLARATION OF CONFORMITY

This device complies with Part 15 of FCC Rules. Operation is subject to the following two conditions. (1) This device may not cause harmful interference, and (2) this device must accept any interference received, including interference that may cause undesired operation.

<b>U.S. Responsible Party:</b>	<b>NEC Display Solutions of America, Inc.</b>
<b>Address:</b>	<b>500 Park Boulevard, Suite 1100 Itasca, Illinois 60143</b>
<b>Tel. No.:</b>	<b>(630) 467-3000</b>

Type of Product:	Display Monitor
Equipment Classification:	Class B Peripheral
Model:	C431 C501 C551



*We hereby declare that the equipment specified above conforms to the technical standards as specified in the FCC Rules.*

### FCC Information

- Use the attached specified cables with this color monitor so as not to interfere with radio and television reception.
  - Please use the supplied power cord or equivalent to ensure FCC compliance.
  - Please use the supplied shielded video signal cable.
- This equipment has been tested and found to comply with the limits for a Class B digital device, pursuant to part 15 of the FCC Rules. These limits are designed to provide reasonable protection against harmful interference in a residential installation. This equipment generates, uses, and can radiate radio frequency energy, and, if not installed and used in accordance with the instructions, may cause harmful interference to radio communications. However, there is no guarantee that interference will not occur in a particular installation. If this equipment does cause harmful interference to radio or television reception, which can be determined by turning the equipment off and on, the user is encouraged to try to correct the interference by one or more of the following measures:
  - Reorient or relocate the receiving antenna.
  - Increase the separation between the equipment and receiver.
  - Connect the equipment into an outlet on a circuit different from that to which the receiver is connected.
  - Consult your dealer or an experienced radio/TV technician for help.

If necessary, the user should contact the dealer or an experienced radio/television technician for additional suggestions. The user may find the following booklet, prepared by the Federal Communications Commission, helpful: "How to Identify and Resolve Radio-TV Interference Problems." This booklet is available from the U.S. Government Printing Office, Washington, D.C., 20402, Stock No. 004-000-00345-4.

Windows is a registered trademark of Microsoft Corporation.

NEC is a registered trademark of NEC Corporation.

OmniColor is a registered trademark of NEC Display Solutions Europe GmbH in the countries of EU and Switzerland.

DisplayPort and DisplayPort Compliance Logo are trademarks owned by Video Electronics Standards Association in the United States and other countries.

All other brands and product names are trademarks or registered trademarks of their respective owners.

The terms HDMI and HDMI High-Definition Multimedia Interface, and the HDMI Logo are trademarks or registered trademarks of HDMI Licensing Administrator, Inc. in the United States and other countries.



Trademark PJLink is a trademark applied for trademark rights in Japan, the United States of America and other countries and areas.

microSD and microSD SDHC logos are trademarks of SD-3C, LLC.



CRESTRON and CRESTRON ROOMVIEW are trademarks or registered trademarks of Crestron Electronics, Inc. in the United States and other countries.

### GPL/LGPL Software Licenses



The product includes software licensed under GNU General Public License (GPL), GNU Lesser General Public License (LGPL), and others.





For more information on each software, see "readme.pdf" inside the "about GPL&LGPL" folder on the supplied CD-ROM.

Apple and Macintosh are trademarks of Apple Inc., registered in the U.S. and other countries.

Adobe and the Adobe logo are either registered trademarks or trademarks of Adobe Systems Incorporated in the United States and/or other countries.

# Important Information

	<b>WARNING</b>	
<p>TO PREVENT FIRE OR SHOCK HAZARDS, DO NOT EXPOSE THIS UNIT TO RAIN OR MOISTURE. ALSO, DO NOT USE THIS UNIT'S POLARIZED PLUG WITH AN EXTENSION CORD RECEPTACLE OR OTHER OUTLETS UNLESS THE PRONGS CAN BE FULLY INSERTED.</p> <p>REFRAIN FROM OPENING THE CABINET AS THERE ARE HIGH VOLTAGE COMPONENTS INSIDE. REFER SERVICING TO QUALIFIED SERVICE PERSONNEL.</p>		

	<b>CAUTION</b>	
<p><b>CAUTION:</b> TO REDUCE THE RISK OF ELECTRIC SHOCK, MAKE SURE POWER CORD IS UNPLUGGED FROM WALL SOCKET. TO FULLY DISENGAGE THE POWER TO THE UNIT, PLEASE DISCONNECT THE POWER CORD FROM THE AC OUTLET. DO NOT REMOVE COVER (OR BACK). NO USER SERVICEABLE PARTS INSIDE. REFER SERVICING TO QUALIFIED SERVICE PERSONNEL.</p>		
	<p>This symbol warns user that uninsulated voltage within the unit may have sufficient magnitude to cause electric shock. Therefore, it is dangerous to make any kind of contact with any part inside this unit.</p>	
	<p>This symbol alerts the user that important literature concerning the operation and maintenance of this unit has been included. Therefore, it should be read carefully in order to avoid any problems.</p>	

**CAUTION:** Please use the power cord provided with this monitor in accordance with the table below. If a power cord is not supplied with this equipment, please contact your supplier. For all other cases, please use a power cord that matches the AC voltage of the power outlet and has been approved by and complies with the safety standard of your particular country.

This equipment is designed to be used in the condition of the power cord connected to earth. If the power cord is not connected to the earth, it may cause electric shock. Please make sure the power cord is earthed properly.

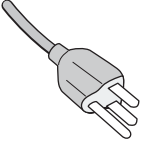
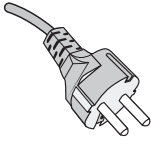
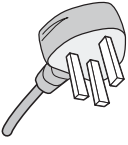
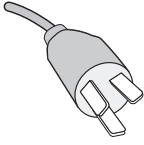
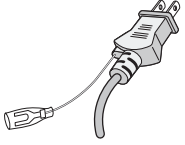
Plug Type	North America		European Continental	U.K.	Chinese	Japanese
<b>Plug Shape</b>						
<b>Region</b>	U.S.A./ Canada	Taiwan	EU (except U.K.)	U.K.	China	Japan
<b>Voltage</b>	120*	110	230	230	220	100

\* When operating this monitor with its AC 125-240V power supply, use a power supply cord that matches the power supply voltage of the AC power outlet being used.

**NOTE:** This product can only be serviced in the country where it was purchased.  
Use the power cord which has BSMI mark at both ends when you use this monitor in Taiwan.

- The intended primary use of this product is as an Information Technical Equipment in an office or domestic environment.
- The product is intended to be connected to a computer and is not intended for the display of television broadcast signals.



# Safety Precautions, Maintenance & Recommended Use

## Safety Precautions and Maintenance

FOR OPTIMUM PERFORMANCE, PLEASE NOTE THE FOLLOWING WHEN SETTING UP AND USING THE MULTI-FUNCTION MONITOR:

- **DO NOT OPEN THE MONITOR.** There are no user serviceable parts inside and opening or removing covers may expose you to dangerous shock hazards or other risks. Refer all servicing to qualified service personnel.
- Do not bend, crimp or otherwise damage the power cord.
- Do not place any heavy objects on the power cord. Damage to the cord may cause shock or fire.
- The power supply cord you use must have been approved by and comply with the safety standards of your country. (Type H05VV-F 3G 0.75 mm<sup>2</sup> should be used in Europe).
- In UK, use a BS-approved power cord with molded plug having a black (5 A) fuse installed for use with this monitor.
- The power cable connector is the primary means of detaching the system from the power supply. The monitor should be installed close to a power outlet, which is easily accessible.
- Do not spill any liquids into the cabinet or use your monitor near water.
- Do not insert objects of any kind into the cabinet slots, as they may touch dangerous voltage points, which can be harmful or fatal or may cause electric shock, fire or equipment failure.
- Do not place this product on a sloping or unstable cart, stand or table, as the monitor may fall, causing serious damage to the monitor.
- Do not mount this product upside down for an extended period of time as it may cause permanent damage to the screen.
- Do not place any objects onto the monitor and do not use the monitor outdoors.
- If glass is broken, handle with care.
- For reliable performance and long useful life of this product, it is mandatory to not cover any vents on the monitor.
- If monitor or glass is broken, do not come in contact with the liquid crystal and handle with care.
- Allow adequate ventilation around the monitor, so that heat can properly dissipate. Do not block ventilated openings or place the monitor near a radiator or other heat sources.
- Do not put anything on top of the monitor.
- Handle with care when transporting. Save packaging for transporting.
- It is recommended to wipe holes clean a minimum of once a month.
- To ensure the monitor's reliability, please clean the holes at the back side of the cabinet at least once a year to remove dirt and dust.
- When using a LAN cable, do not connect to a peripheral device with wiring that might have excessive voltage.
- Do not use the monitor in high temperature, humid, dusty, or oily areas.

- Do not use monitor under rapid temperature and humidity change condition and avoid cold air from air-conditioning outlet directly, as it may shorten the lifetime of the monitor or cause condensation. If condensation of water has happened, let the monitor stand unplugged until the condensation has disappeared.

Connecting to a TV\*

- Cable distribution system should be grounded (earthed) in accordance with ANSI/NFPA 70, the National Electrical Code (NEC), in particular Section 820.93, Grounding of Outer Conductive Shield of a Coaxial Cable.
- The screen of the coaxial cable is intended to be connected to earth in the building installation.

Under the following conditions immediately disconnect your monitor from the wall outlet and refer servicing to qualified service personnel:

- When the power supply cord or plug is damaged.
- If liquid has been spilled, or objects have fallen into the monitor.
- If the monitor has been exposed to rain or water.
- If the monitor has been dropped or the cabinet has been damaged.
- If you notice any structural damage such as cracks or unnatural wobbling.
- If the monitor does not operate normally by following operating instructions.

## Recommended Use

- For the monitor's optimum performance, allow 20 minutes for warming up.
- Rest your eyes periodically by focusing on an object at least 5 feet away. Blink often.
- Position the monitor at a 90° angle to windows and other light sources to minimize glare and reflections.
- Clean the LCD monitor surface with a lint-free, non-abrasive cloth. Avoid using any cleaning solution or glass cleaner!
- Adjust the monitor's brightness, contrast and sharpness controls to enhance readability.
- Avoid reproduction of still patterns on the monitor for long periods of time to avoid image persistence (after image effects).
- Get regular eye checkups.

## Ergonomics

To realize the maximum ergonomic benefits, we recommend the following:

- Use the preset Size and Position controls with standard signals.
- Use the preset Color Setting.
- Use non-interlaced signals.
- Do not use primary color blue on a dark background, as it is difficult to see and may produce eye fatigue due to insufficient contrast.
- Suitable for entertainment purposes at controlled luminous environments, to avoid disturbing reflections from the screen.

\* The product you purchased may not have this feature.

**Cleaning the LCD Panel**

- When the liquid crystal panel is dusty, please gently wipe with a soft cloth.
- Please do not rub the LCD panel with hard material.
- Please do not apply pressure to the LCD panel surface.
- Please do not use OA cleaner as it will cause deterioration or discoloration on the LCD panel surface.

**Cleaning the Cabinet**

- Unplug the power supply
- Gently wipe the cabinet with a soft cloth
- To clean the cabinet, dampen the cloth with a neutral detergent and water, wipe the cabinet and follow with a dry cloth.

**NOTE:** DO NOT clean with benzene thinner, alkaline detergent, alcoholic system detergent, glass cleaner, wax, polish cleaner, soap powder, or insecticide. Rubber or vinyl should not be in contact with the cabinet for an extended period of time. These types of fluids and materials can cause the paint to deteriorate, crack or peel.

# Contents

For contents, please refer to the contents sheet.

## Installation

*This device cannot be used or installed without the Tabletop Stand or other mounting accessory for support. For proper installation it is strongly recommended to use a trained, NEC authorized service person. Failure to follow NEC standard mounting procedures could result in damage to the equipment or injury to the user or installer. Product warranty does not cover damage caused by improper installation. Failure to follow these recommendations could result in voiding the warranty.*

### Mounting

DO NOT mount the monitor yourself. Please ask your supplier. For proper installation it is strongly recommended to use a trained, qualified technician. Please inspect the location where the unit is to be mounted. Mounting on wall or ceiling is the customer's responsibility. Not all walls or ceilings are capable of supporting the weight of the unit. Product warranty does not cover damage caused by improper installation, remodeling, or natural disasters. Failure to comply with these recommendations could result in voiding the warranty.

DO NOT block ventilated openings with mounting accessories or other accessories.

#### For NEC Qualified Personnel:

To ensure safe installation, use two or more brackets to mount the unit. Mount the unit to at least two points on the installation location.

### Please note the following when mounting on wall or ceiling

- When using mounting accessories other than those that are NEC approved, they must comply with the VESA-compatible (FDMLv1) mounting method.
- NEC recommends mounting interfaces that comply with UL1678 standard in North America.
- NEC strongly recommends using size M6 screws (10-12 mm + thickness of bracket and washers in length). If using screws longer than 10-12 mm, check the depth of the hole. (Recommended Fasten Force: 470 - 635N•cm). Bracket hole should be under  $\phi$  8.5 mm.
- Prior to mounting, inspect the installation location to ensure that it is strong enough to support the weight of the unit so that the unit will be safe from harm.
- For detailed information, refer to the instructions included with the mounting equipment.
- Make sure that there is no gap between the monitor and the bracket.

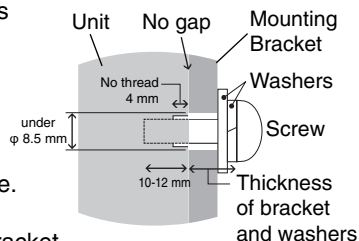

- When used in a video wall configuration for a longer time, slight expansion of the monitors may happen due to temperature changes. Due to this it is recommended that over one millimeter gap is kept between adjacent monitor edges.
- When installing, do not put your hands on the monitor or apply force. The monitor may be distorted.

To prevent the LCD monitor from falling off from the wall or ceiling, NEC strongly recommends using a safety wire.

Please install LCD monitor in a spot of the wall or ceiling strong enough to support the monitor.

Prepare the LCD monitor using mounting accessories such as hook, eyebolt or mounting parts and then secure the LCD monitor with a wire. The safety wire must not be tight.

**CAUTION:** Do not attempt to hang the monitor using an installation safety wire. The monitor must be properly installed on a VESA compatible mount.

Please make sure the mounting accessories are strong enough to support the LCD monitor before mounting it.

Landscape installation for safety wire

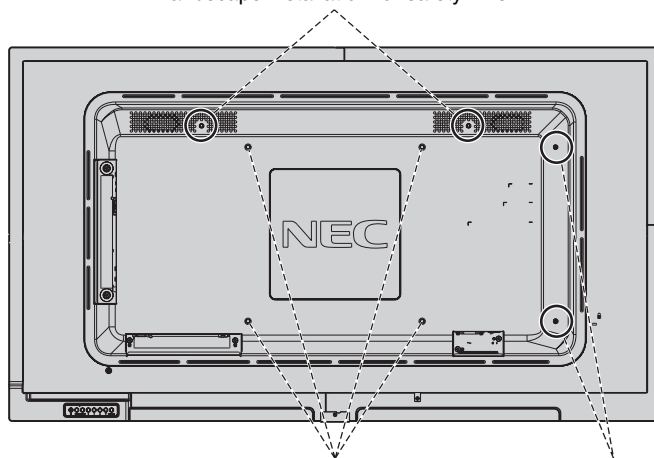

### Installing a wire to a monitor

Please use eyebolts to install a wire to the monitor.

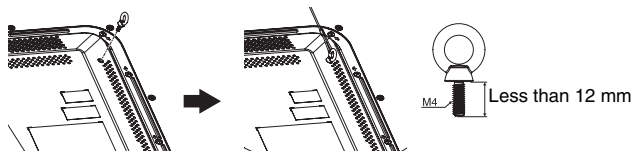

## Mounting location

- The ceiling and wall must be strong enough to support the monitor and mounting accessories.
- DO NOT install in locations where a door or gate can hit the unit.
- DO NOT install in areas where the unit will be subjected to strong vibrations and dust.
- DO NOT install the monitor next to a location where the main power supply is fed into the building.
- DO NOT install the monitor in a location where people can easily grab and hang onto the unit or the mounting equipment.
- Allow for adequate ventilation or provide air conditioning around the monitor, so that heat can properly dissipate away from the monitor and from the mounting equipment.

## Mounting on ceilings

- Ensure that the ceiling is sturdy enough to support the weight of the unit and the mounting equipment over time, against earthquakes, unexpected vibrations, and other external forces.
- Be sure the unit is mounted to a solid structure within the ceiling, such as a support beam. Secure the monitor using bolts, spring lock washers, washer and nut.
- DO NOT mount to areas that have no supporting internal structure. DO NOT use wood screws or anchor screws for mounting. DO NOT mount the unit to ceiling or to hanging fixtures.

## Maintenance

- Periodically check for loose screws, gaps, distortions, or other problems that may occur with the mounting equipment. If a problem is detected, please refer to qualified personnel for service.
- Regularly check the mounting location for signs of damage or weakness that may occur over time.

## Orientation

- When using the monitor in the portrait position, it should be rotated clockwise so that the left side is moved to the top, right side is moved to the bottom. This will allow for proper ventilation and will extend the lifetime of the monitor. Improper ventilation may shorten the lifetime of the monitor.

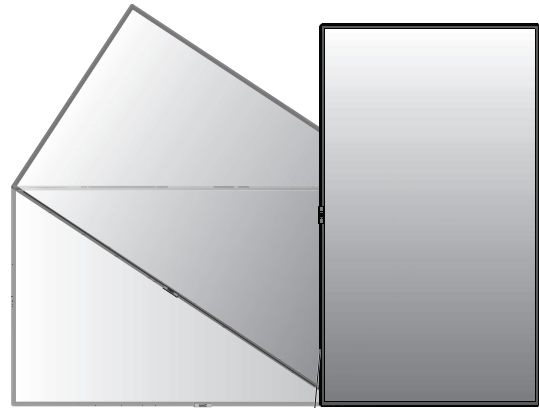

LED Indicator

- When using the monitor in the portrait position, the NEC logo ornament position can be changed.

## Changing NEC logo ornament position

Removing the logo ornament: unscrew the installed screw then take off the logo ornament.

Attaching the logo ornament: adjust the protrusions inside of the logo ornament into the protrusion hole on the bezel. Make sure the hole for the screw on the logo ornament and the hole for the screw on the bezel are aligned. Install the logo ornament with the screw, which is used for installing the logo ornament.

(Recommended Fasten Force: 30-40N•cm).

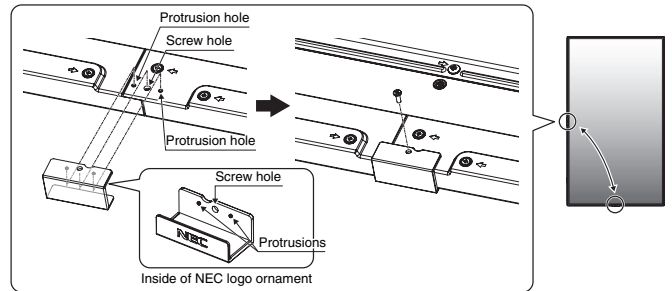

**CAUTION:** Do not use any other screw to install the logo ornament.



## Attaching Mounting Accessories

The monitor is designed for use with the VESA mounting system.

### 1. Attach Mounting Accessories

Be careful to avoid tipping the monitor when attaching accessories.

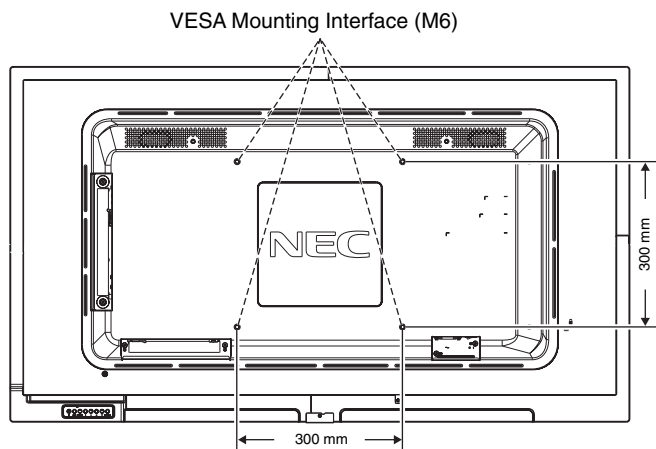

Mounting accessories can be attached with the monitor in the face down position. To avoid damaging the front face, place the protective sheet on the table underneath the LCD monitor. The protective sheet was wrapped around the LCD monitor in the original packaging. Make sure there is nothing on the table that can damage the monitor.

When using mounting accessories other than NEC compliant and approved, they must comply with the VESA Flat Display Mounting Interface Standard (FDMI).

**NOTE:** Prior to installation, be sure to place the monitor on a flat area with adequate space.

### 2. Using Wall Mount Adapter

If the mounting accessory interferes with ventilation hole, use the included wall mount adaptors (Dia. 14 mm) and screws. If the adaptor screws are too long, include a washer to reduce the depth. Washer not included.

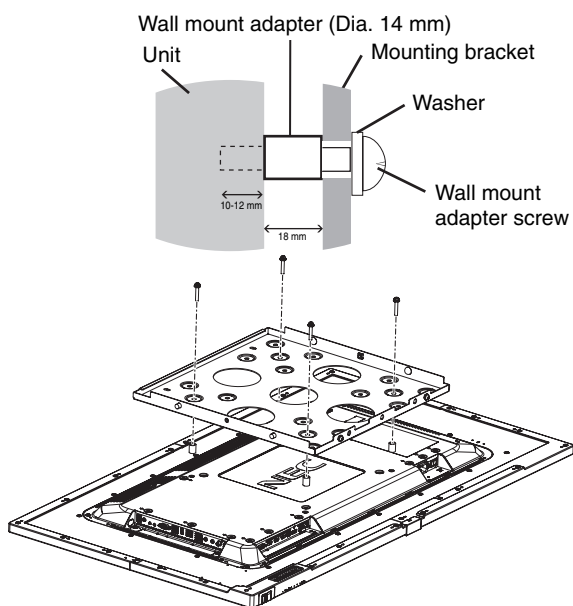

Pictured mounting solutions may not be available in some countries.

### 3. Installing and removing the optional table top stand

**CAUTION:** Installing and removing the stand must be done by two or more people.

For installation follow the instructions included with the stand or mounting equipment. Use only those devices recommended by the manufacturer.

**NOTE:** ONLY use screws which are supplied with the optional table top stand. When installing, do not put your hands on the monitor or apply force. The monitor may become distorted.

When installing the LCD monitor stand, handle the unit with care to avoid pinching your fingers.

**NOTE:** Use the ST-401. Please refer to the ST-401 user's manual for more detail.

#### Height adjustment

1. The lines on the stand pole are indicators of the height adjustment. Please adjust the pipe to the lines.

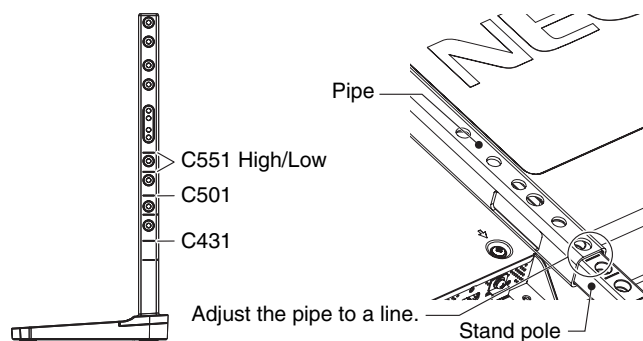

2. Please install the stand pole and the pipe with included screws. Please screw the two screw holes at the pipe.

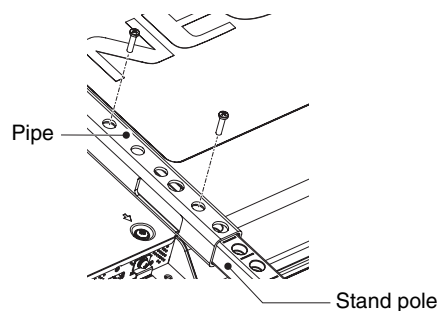

**NOTE:** Installing the monitor at the wrong height can cause tipping. Please install your monitor at proper height.

## 4. Ventilation Requirements

When mounting in an enclosed space or recessed area, leave adequate room between the monitor and the enclosure to allow heat to disperse, as shown below.

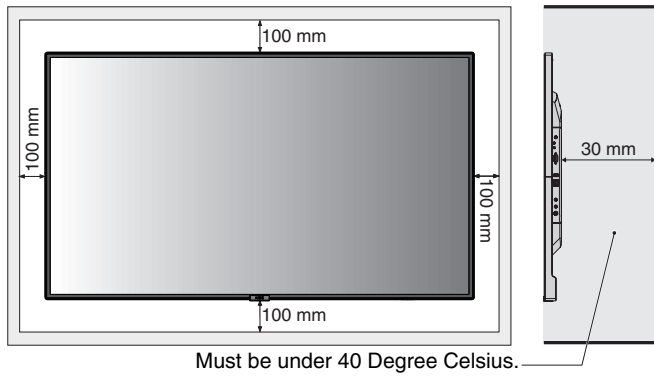

Allow adequate ventilation or provide air conditioning around the monitor, so that heat can properly dissipate away from the unit and the mounting equipment; especially when you use monitors in a multiple screen configuration.

**NOTE:** The sound quality of the internal speakers will be different depending on the acoustics of the room.

# Parts Name and Functions

## Control Panel

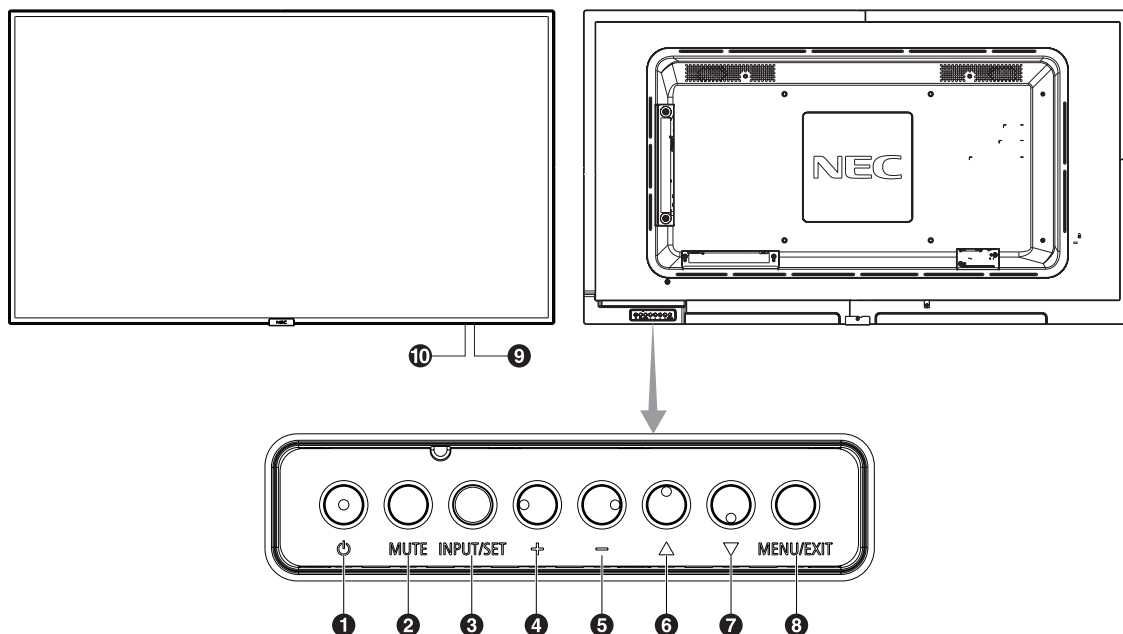

### 1 POWER button (⏻)

Switches the power on/standby. See also page 17.

### 2 MUTE button (MUTE)

Switches the audio mute on/off.

### 3 INPUT/SET button (INPUT/SET)

INPUT: Toggle switches between below inputs. [DisplayPort], [HDMI1], [HDMI2], [HDMI3], [VGA (YPbPr/RGB)], [VIDEO], [MP]. These are available inputs only, shown as their factory preset name.  
SET: When OSD (On Screen Display) is shown, this button acts as a “set button” when you make a selection.

### 4 PLUS button (+)

Increases the audio output level when the OSD menu is turned off.  
Acts as (+) button to increase the adjustment with OSD menu.

### 5 MINUS button (-)

Decreases the audio output level when the OSD menu is turned off.  
Acts as (-) button to decrease the adjustment with OSD menu.

### 6 UP button (▲)

Activates the OSD menu when the OSD menu is turned off.  
Acts as ▲ button to move the highlighted area up to select adjustment items within the OSD menu.

### 7 DOWN button (▼)

Activates the OSD menu when the OSD menu is turned off.  
Acts as ▼ button to move the highlighted area down to select adjustment items within the OSD menu.

### 8 MENU/EXIT button (MENU/EXIT)

Activates the OSD menu when the OSD menu is turned off.  
Acts as a back button within the OSD to move to the previous OSD menu.  
Acts as an EXIT button to close the OSD when on the main menu.

### 9 Remote control sensor and Power Indicator

Receives the signal from the remote control (when using the wireless remote control). See also page 12.  
Glow blue when the LCD monitor is in active mode\*.  
Green and Amber blink alternately when the “SCHEDULE SETTINGS” function is enabled\*1.  
When a component failure is detected within the monitor, the indicator will blink red or blink a combination of red and blue.  
\* If “OFF” is selected in the “POWER INDICATOR” (see page 36), the LED will not glow when the LCD monitor is in active mode.  
\*1 If “OFF” is selected in the “SCHEDULE INDICATOR” (see page 36), the LED will not blink.  
**NOTE:** Please refer to the POWER INDICATOR (see page 36).

### 10 Room light sensing sensor

Detects the level of ambient light, allowing the monitor to make automatic adjustments to the backlight setting, resulting in a more comfortable viewing experience. Do not cover this sensor. See page 35.

# Terminal Panel

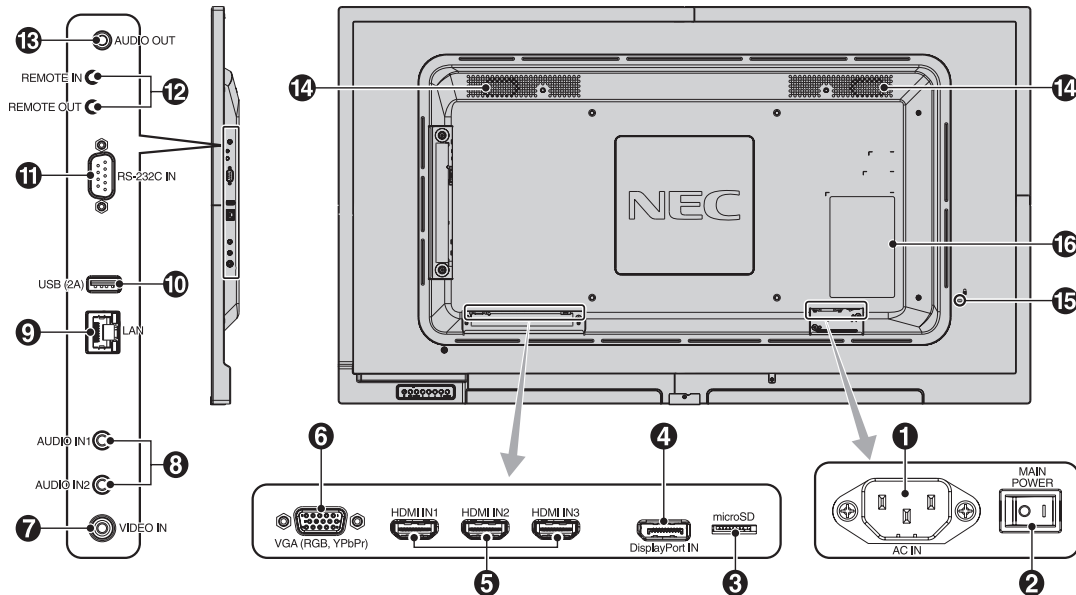

## 1 AC IN connector

Connects with the supplied power cord.

## 2 Main Power Switch

On/Off switch to turn main power ON/OFF.

## 3 microSD card slot

Insert a microSD memory card. To use the Media Player, please connect a microSD memory card to this port. To install the microSD card slot cover, please refer to "Installing microSD card slot cover" (See page 20).

## 4 DisplayPort IN

DisplayPort signals input.

## 5 HDMI IN1/IN2/IN3

Digital HDMI signals input.

## 6 VGA IN (mini D-Sub 15 pin)

Analog RGB signals input from a personal computer or from other RGB equipment. This input can be used with an RGB or YPbPr source. Please select signal type in **TERMINAL SETTINGS**. See page 32.

**NOTE:** When you use this connector for YPbPr, please use a suitable signal cable. If you have any questions, please ask your supplier.

## 7 VIDEO IN

Composite video signal input.

## 8 AUDIO IN1/IN2

Audio signal input from external equipment such as a computer or player.

## 9 LAN port IN (RJ-45)

LAN connection. See page 42.

## 10 USB port

USB (2A): USB storage device port.

To use the Media Player, please connect USB storage device to this port (See page 16).

## 11 RS-232C IN (D-Sub 9 pin)

Connect RS-232C input from external equipment such as a computer in order to control RS-232C functions.

## 12 REMOTE IN/OUT

Use to connect to other displays to create the "daisy-chain" function. Use the optional sensor unit by connecting it to your monitor.

**NOTE:** Do not use this connector for any other purpose.

## 13 AUDIO OUT

To output the audio signal from the AUDIO IN1/IN2, DisplayPort and HDMI to an external device (stereo receiver, amplifier, etc.).

**NOTE:** This connector is not a Headphone terminal.

## 14 Internal speaker

## 15 Kensington Lock

For security and theft prevention.

## 16 Rating label

## Wireless Remote Control

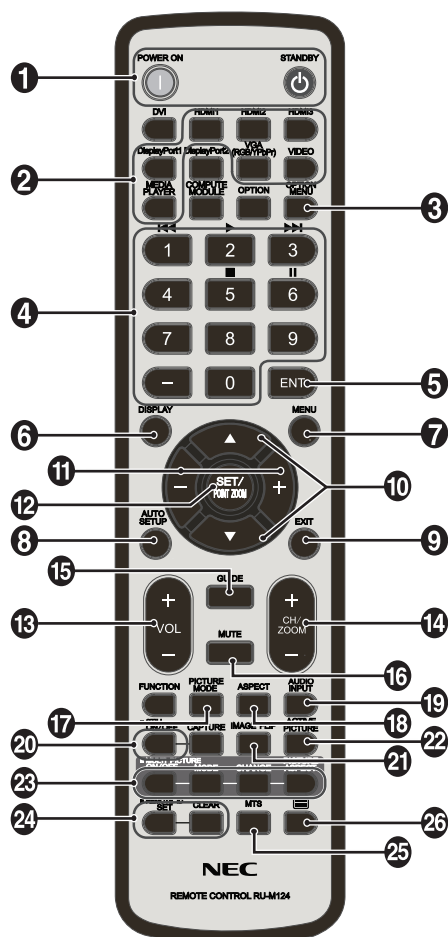

### 1 POWER ON/STANDBY button

Switches the power on/standby.

### 2 INPUT button

Selects the input signal.

Input signal for the Media Player is shown as MP.

### 3 OPTION MENU button (This button does not work)

### 4 KEYPAD

Press the buttons to set and change passwords, change channel and set REMOTE ID.

Below buttons are used for CEC (Consumer Electronics Control) (See page 36) and the Media Player function (See page 19): 1 ◀◀, 2 ▶▶, 3 ▶▶▶, 5 ■, 6 ||.

### 5 ENT button (This button does not work)

### 6 DISPLAY button

Turns on/off the information OSD. See page 25.

If you lock remote control buttons using the IR LOCK SETTINGS function, you can unlock the buttons by holding down this DISPLAY button for more than 5 seconds.

### 7 MENU button

Turns on/off the menu mode.

### 8 AUTO SET UP button

Enters auto setup menu. See page 28.

### 9 EXIT button

Returns to the previous menu within the OSD menu.

### 10 UP/DOWN button (▲/▼)

Acts as ▲ ▼ button to move the highlighted area up or down to select adjustment items within the OSD menu.

### 11 MINUS/PLUS (-/+ ) button

Increases or decreases the adjustment level within the OSD menu settings.

### 12 SET/POINT ZOOM button

SET: When OSD is shown, this button acts as “set button” when you make a selection.

POINT ZOOM: When OSD is not shown, this button acts as “point zoom button”.

### 13 VOLUME UP/DOWN button (VOL +/-)

Increases or decreases the audio output level.

### 14 CH/ZOOM UP/DOWN button (CH/ZOOM +/-)

Increases or decreases the POINT ZOOM level.

Please refer to POINT ZOOM (See page 50).

### 15 GUIDE button (This button does not work)

### 16 MUTE button

Turns on/off the mute function.

### 17 PICTURE MODE button

Selects the picture mode, [HIGHBRIGHT], [STANDARD], [sRGB], [CINEMA], [CUSTOM1], [CUSTOM2]. See page 26.

HIGHBRIGHT: For moving images such as DVD.

STANDARD: For images.

sRGB: For text based images.

CINEMA: For movies.

CUSTOM1 and CUSTOM2: Activates the auto dimming function. See page 35.

### 18 ASPECT button

Selects the picture aspect, [FULL], [WIDE]\*, [1:1], [ZOOM] and [NORMAL]. See page 18.

\* HDMI1, HDMI2, HDMI3, VGA (YPbPr) inputs only.

### 19 AUDIO INPUT button

Selects the audio input source [IN1], [IN2], [DisplayPort], [HDMI1], [HDMI2], [HDMI3], [MP].

### 20 STILL button

ON/OFF button: Activates/deactivates still picture mode.

NOTE: This function deactivates when selecting SCREEN SAVER, POINT ZOOM, TILE MATRIX.

CLOSED CAPTION is not available when STILL is active.

### 21 IMAGE FLIP button (This button does not work)

### 22 ACTIVE PICTURE button (This button does not work)

### 23 MULTI PICTURE button (This button does not work)

### 24 REMOTE ID button

Activates the REMOTE ID function. See page 38.

### 25 MTS button (This button does not work)

### 26 ☰ button (This button does not work)

NOTE: The buttons with no explanation do not function.

## Operating Range for the Remote Control

Point the top of the remote control toward the LCD monitor's remote control sensor during button operation.

Use the remote control within a distance of about 7 m (23 ft.) from the remote control sensor, or at a horizontal and vertical angle of within 30° and within a distance of about 3.5 m (10 ft.).



**Caution:** Important, the remote control system may not function when direct sunlight or strong illumination strikes the remote control sensor, or when there is an object in the path.

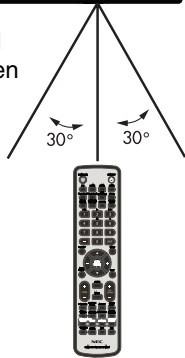

### Handling the remote control

- Do not expose to strong shock.
- Do not allow water or other liquid to splash on the remote control. If the remote control gets wet, wipe it dry immediately.
- Avoid exposure to heat and steam.
- Except to install the batteries, do not open the remote control.

## 1. Determine the installation location

**CAUTION:** Installing your LCD monitor must be done by a qualified technician. Contact your supplier for more information.

**CAUTION:** MOVING OR INSTALLING THE LCD MONITOR MUST BE DONE BY TWO OR MORE PEOPLE. Failure to follow this caution may result in injury if the LCD monitor falls.

**CAUTION:** Do not mount or operate the monitor upside down.

**CAUTION:** This LCD monitor has internal temperature sensors. If the LCD monitor becomes overheated, a “Caution” warning will appear. If the “Caution” warning appears, stop using the unit and allow it to cool. If the LCD monitor is used in an enclosed area or if the LCD panel is covered with a protective screen, please check the inside temperature of the monitor by using the “HEAT STATUS” control in the OSD (see page 33).

**IMPORTANT:** Lay the protective sheet beneath the monitor, so as not to scratch the LCD panel. The protective sheet was wrapped around the monitor when it was packaged.

## 2. Install the remote control batteries

The remote control is powered by two 1.5V AAA batteries. To install or replace batteries:

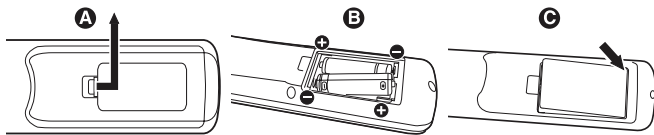

- Press and slide to open the cover.
- Align the batteries according to the (+) and (-) indications inside the case.
- Replace the cover.

**CAUTION:** Incorrect usage of batteries can result in leaks or bursting.

NEC recommends the following battery use:

- Place “AAA” size batteries matching the (+) and (-) signs on each battery to the (+) and (-) signs of the battery compartment.
- Do not mix battery brands.
- Do not combine new and old batteries. This can shorten battery life or cause liquid leakage of batteries.
- Remove dead batteries immediately to prevent battery acid from leaking into the battery compartment.
- Do not touch exposed battery acid, it may injure your skin.

**NOTE:** If you do not intend to use the Remote Control for a long period of time, remove the batteries.

## 3. Connect external equipment (See pages 15 and 16)

- To protect the external equipment, turn off the main power before making connections.
- Refer to the user’s manual of your equipment for further information.

**NOTE:** Do not connect/disconnect cables when turning on the monitor or other external equipment, as this may result in a loss of the monitor image.

## 4. Connect the supplied power cord

- The equipment should be installed close to an easily accessible power outlet.
- Please fasten the power cord to the LCD monitor by attaching the screw and clamp.
- Fully insert the prongs into the power outlet socket. A loose connection may cause image degradation.

**NOTE:** Please refer to the “Safety Precautions and Maintenance” section of this user’s manual for proper selection of an AC power cord. (Recommended Fasten Force: 139 - 189N•cm).

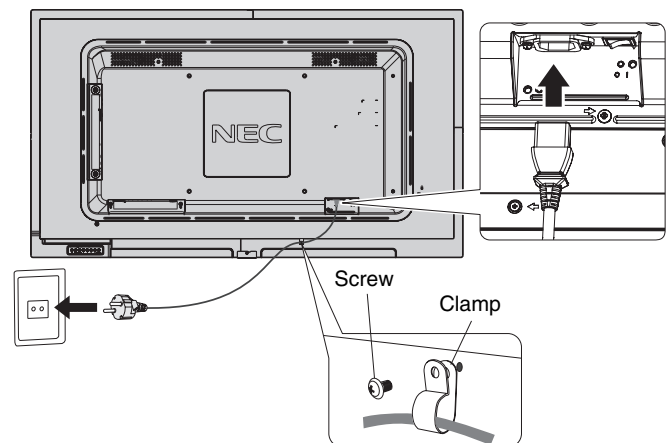

## 5. Switch on the power of all the attached external equipment

When connected with a computer, switch on the power of the computer first.

## 6. Operate the attached external equipment

Show the signal on the screen from the desired input source.

## 7. Adjust the sound

Make volume adjustments when required.

## 8. Adjust the screen (See pages 28 and 29)

Make adjustments to the image position, if necessary.

## 9. Adjust the image (See page 28)

Make adjustments such as backlight or contrast when required.

## **10. Recommended Adjustments**

To reduce the risk of the “Image Persistence”, please adjust the following items based on the application being used: “SCREEN SAVER”, “SIDE BORDER COLOR” (See page 33), “DATE & TIME” (See page 31), “SCHEDULE SETTINGS” (See page 30).



# Connections

**NOTE:** Do not connect or disconnect cables when turning on the monitor's main power or other external equipment's power, as this may result in a loss of the monitor image.

**NOTE:** Use an audio cable without a built-in resistor. Using an audio cable with a built-in resistor turns down the sound.

## Before making connections:

- \* First turn off the power of all the attached equipment and make connections.
- \* Refer to the user's manual included with each separate piece of equipment.
- \* We strongly recommend connecting or disconnecting a USB storage device or a microSD memory card to the monitor when the monitor's main power is off.

## Wiring Diagram

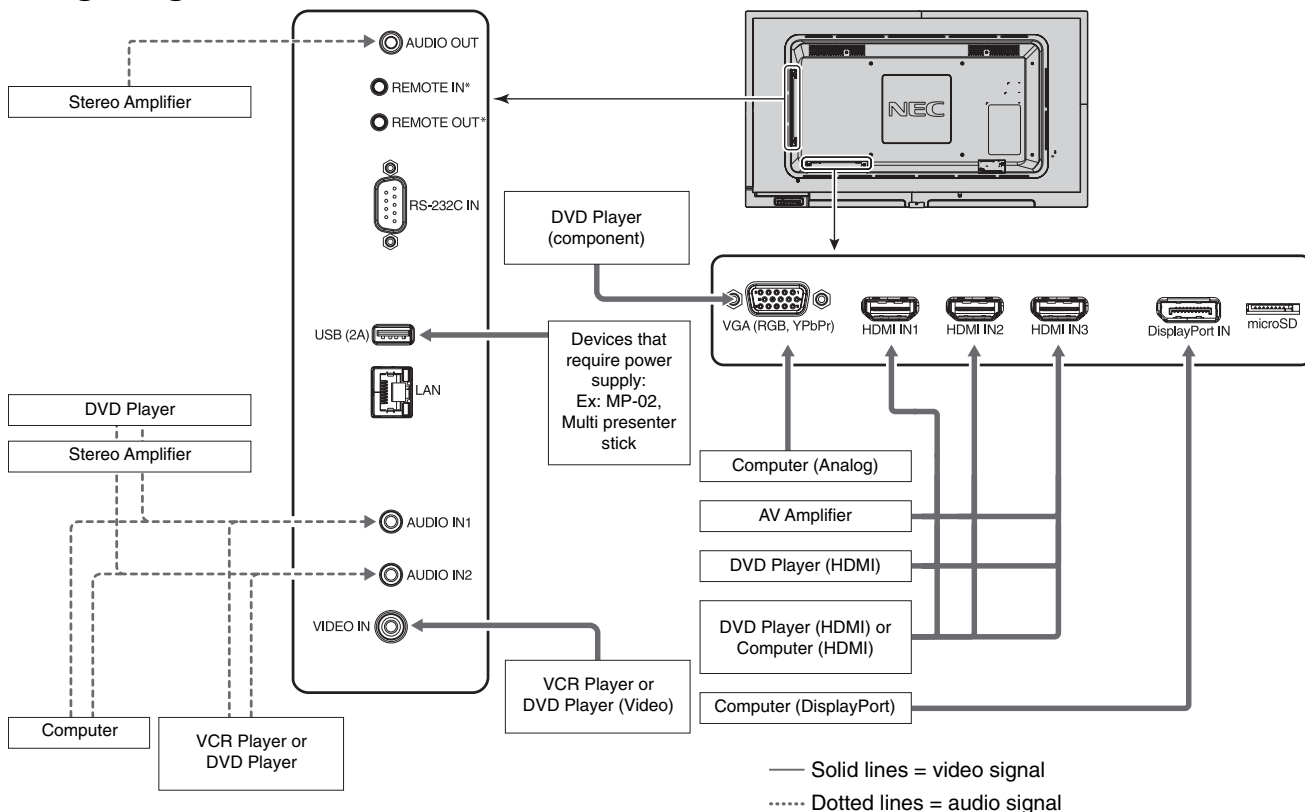

\*: Multiple monitors can have their REMOTE IN/OUT ports daisy chained together. This allows one optional remote sensor kit to be used for multiple monitors. There is a limit to the number of monitors that can be daisy-chained together (see page 38).

Connected equipment	Connecting terminal	Setting in TERMINAL SETTINGS	Input signal name	Connecting audio terminal	Input button in remote control
AV*2	DisplayPort IN	VIDEO LEVEL: RAW/EXPAND*1	DisplayPort	DisplayPort	DisplayPort
	HDMI IN1	VIDEO LEVEL: RAW/EXPAND*1	HDMI1	HDMI1	HDMI1
	HDMI IN2	VIDEO LEVEL: RAW/EXPAND*1	HDMI2	HDMI2	HDMI2
	HDMI IN3	VIDEO LEVEL: RAW/EXPAND*1	HDMI3	HDMI3	HDMI3
	VGA (RGB, YPbPr)	VGA MODE: RGB	VGA (RGB)	IN1/IN2	VGA (RGB/YPbPr)
	VGA (RGB, YPbPr)	VGA MODE: YPbPr	VGA (YPbPr)	IN1/IN2	VGA (RGB/YPbPr)
PC*3	VIDEO IN	—	VIDEO	IN1/IN2	VIDEO
	DisplayPort IN	VIDEO LEVEL: RAW/EXPAND*1	DisplayPort	DisplayPort	DisplayPort
	HDMI IN1	VIDEO LEVEL: RAW/EXPAND*1	HDMI1	HDMI1	HDMI1
	HDMI IN2	VIDEO LEVEL: RAW/EXPAND*1	HDMI2	HDMI2	HDMI2
	HDMI IN3	VIDEO LEVEL: RAW/EXPAND*1	HDMI3	HDMI3	HDMI3
	VGA (RGB, YPbPr)	VGA MODE: RGB	VGA (RGB)	IN1/IN2	VGA (RGB/YPbPr)
VGA (RGB, YPbPr)	VGA MODE: YPbPr	VGA (YPbPr)	IN1/IN2	VGA (RGB/YPbPr)	
VIDEO IN	—	VIDEO	IN1/IN2	VIDEO	

\*1: Please set appropriate setting for input signal.

\*2: It is recommended to set YUV in HDMI/DisplayPort MODE (See page 32).

\*3: It is recommended to set RGB in HDMI/DisplayPort MODE (See page 32).

## Connecting a Personal Computer

Connecting your computer to your LCD monitor will enable you to reproduce your computer's video signal output. Some display cards may not be able to support the required resolution for proper image reproduction. Your LCD monitor shows proper image by adjusting the factory preset timing signal automatically.

<Typical factory preset signal timing>

Resolution	Scanning frequency		VGA	HDMI	DisplayPort 1.1a	Remarks
	Horizontal	Vertical				
640 x 480	31.5 kHz	60 Hz	Yes	Yes	Yes	
800 x 600	37.9 kHz	60 Hz	Yes	Yes	Yes	
1024 x 768	48.4 kHz	60 Hz	Yes	Yes	Yes	
1280 x 720	45.0 kHz	60 Hz	Yes	Yes	Yes	
1280 x 768	47.8 kHz	60 Hz	Yes	Yes	Yes	
1280 x 800	49.7 kHz	60 Hz	Yes	Yes	Yes	
1280 x 960	60.0 kHz	60 Hz	Yes	Yes	Yes	
1280 x 1024	64 kHz	60 Hz	Yes	Yes	Yes	
1360 x 768	47.7 kHz	60 Hz	No	Yes	Yes	
1366 x 768	47.7 kHz	60 Hz	Yes	Yes	Yes	
1400 x 1050	65.3 kHz	60 Hz	Yes	Yes	Yes	
1440 x 900	55.9 kHz	60 Hz	Yes	Yes	Yes	
1600 x 1200	75.0 kHz	60 Hz	Yes	Yes	Yes	Compressed image
1680 x 1050	65.3 kHz	60 Hz	Yes	Yes	Yes	
1920 x 1080	67.5 kHz	60 Hz	Yes	Yes	Yes	Recommended resolution
1920 x 1200	74.6 kHz	60 Hz	Yes	Yes	Yes	Compressed image

- If you use with an Apple Macintosh® series computer, set "Mirroring" to "off" on your device. Refer to your Apple Macintosh® series computer user's manual for more information about your computer's video output requirements, and any special identification or configuration your monitor's image and monitor may require.

## Connecting a Player or Computer with HDMI

- Please use a HDMI cable with the HDMI logo.
- It may take a moment for the signal to appear.
- Some display cards or drivers may not display an image correctly.
- When you use a computer with HDMI, please set OVER SCAN to "AUTO" or "OFF" (see page 29).
- Please check display card when image is compressed with 1920 x 1080.
- To output HDMI audio, set [HDMI1], [HDMI2] or [HDMI3] at AUDIO INPUT in the OSD or choose [HDMI1], [HDMI2] or [HDMI3] by the remote control AUDIO INPUT button.
- If the monitor's main power is turned on after a connected computer is turned on, sometimes images are not displayed. In this case, please turn off the computer then turn it on again.

## Connecting a Computer with DisplayPort

- Please use a DisplayPort cable with the DisplayPort compliance logo.
- It may take a moment for the signal to appear.
- When connecting a DisplayPort cable to a component with a signal conversion adapter, an image may not appear.
- Select DisplayPort cables feature a locking function. When removing this cable, hold down the top button to release the lock.
- To output DisplayPort audio, set [DisplayPort] at AUDIO INPUT in the OSD or choose [DisplayPort] by the remote control AUDIO INPUT button.
- If the monitor's main power is turned on after a connected computer is turned on, sometimes images are not displayed. In this case, please turn off the computer then turn it on again.

## Connecting a USB device with USB port

USB (2A): USB downstream port (Type-A).

To use the Media Player function, please use this port.

- Please make sure the connector shape and orientation is correctly aligned when connecting the USB device or cable.
- Please refer to the specifications page for power supply information (see pages 54, 55 and 56).
- When you use the USB (2A) port for power supply, please use a USB cable that supports 2A.
- Do not bind the USB cable. It may cause heat or fire.

# Basic Operation

## Power ON and OFF Modes

The LCD monitor power indicator will turn blue while powered on.

**NOTE:** The Main Power switch must be in the ON position in order to power up the monitor using the remote control or the Power button.

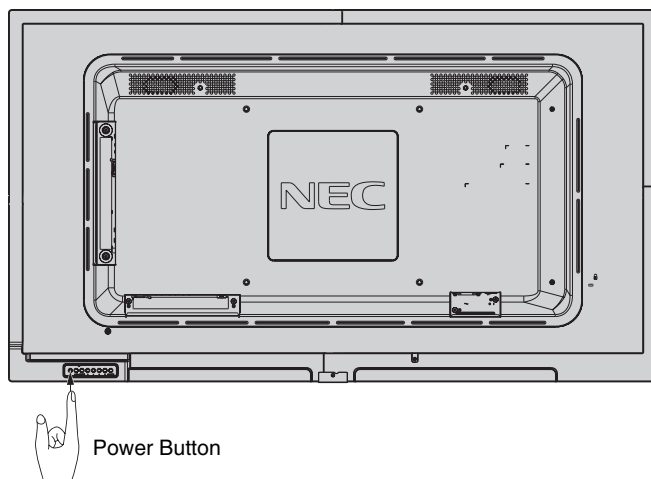
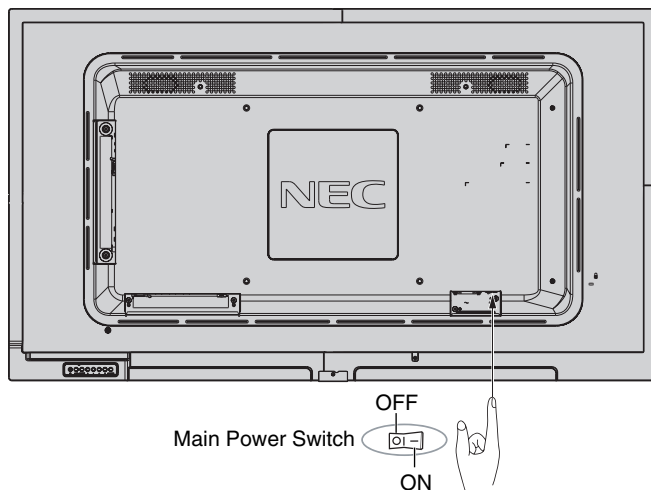

Using the remote control

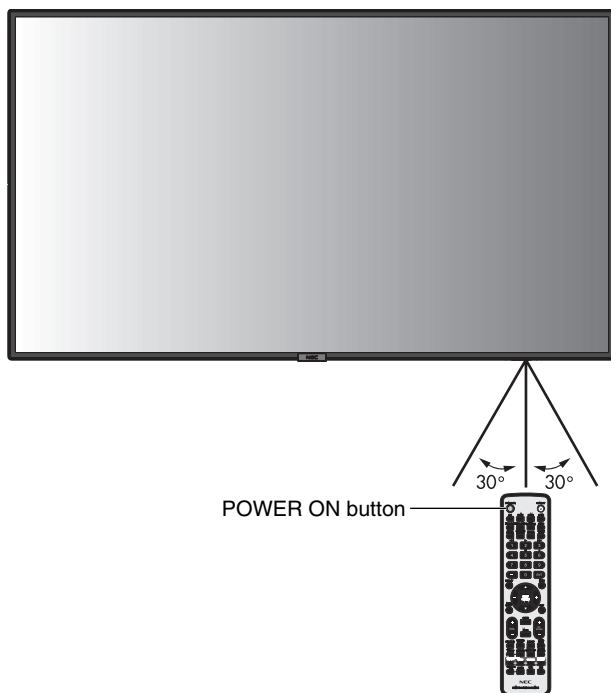

## Power Indicator

LED indicator status and lighting pattern	Condition	Recovery
Glowing blue	Normal	1. Turn on the monitor by the remote control or the monitor button. 2. Send an AV signal input to the monitor.
Blinking green*1	The monitor has detected no signal input after a certain amount of time has passed when INPUT DETECT is not NONE, STANDBY USB POWER is ENABLE, or QUICK TURN ON is ENABLE.	
Glowing amber	The monitor has detected no AV signal input [with network signal input] after a certain amount of time has passed when INPUT DETECT is NONE, STANDBY USB POWER and QUICK TURN ON are ENABLE.	
Blinking amber	The monitor has detected no AV signal input [no network signal input] after a certain amount of time has passed when INPUT DETECT is NONE, STANDBY USB POWER and QUICK TURN ON are ENABLE.	
Glowing red	Turn off the monitor by the remote control or the monitor button.	Turn on the monitor by the remote control or the monitor button.

\*1: Time setting for AUTO POWER SAVE is available at POWER SAVE (See page 33).

**NOTE:** If the indicator is blinking red in a combination of long and short, a certain failure might have occurred, please contact your supplier.

## Using Power Management

This LCD monitor follows the VESA approved DPM (Display Power Management) function.

The power management function is an energy saving function that automatically reduces the power consumption of the monitor when the keyboard or the mouse has not been used for a fixed period.

This allows your LCD monitor to enter a Power Management mode if the monitor's POWER SAVE function is set to ENABLE, and a certain amount of time has passed since the monitor recognized "no signal input". It will increase the life and decrease the power consumption of the monitor.

**NOTE:** Depending on the computer and display card used, this function may not operate. After the video signal was lost, the monitor automatically goes into OFF at a preset time period.

## Aspect

For VIDEO, VGA (RGB, YPbPr)

FULL → ZOOM → NORMAL



For DisplayPort

FULL → 1:1 → ZOOM → NORMAL



For HDMI1, HDMI2, HDMI3

FULL → WIDE → 1:1 → ZOOM → NORMAL



Aspect ratio of image	Unchanged view*3	Recommended selection for picture aspect*3
4:3		NORMAL
Squeeze		FULL
Letterbox		WIDE

\*3 Grey areas indicate unused portions of the screen.

**NORMAL:** Reproduces the aspect ratio that is sent from the source.

**FULL:** Fills the entire screen.

**WIDE:** Expands a 16:9 letter box signal to fill the entire screen.

**1:1:** Shows the image in a 1 by 1 pixel format.

### ZOOM

The image can be expanded beyond the active screen area. The image which is outside of the active screen area is not shown.

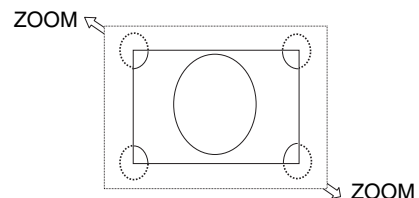

## Media Player

Plays saved data, such as still and motion images, BGM (Background Music), and media packages that have been programmed with our authoring software, on a USB storage device or microSD memory card connected to the monitor.

### Top screen of the viewer

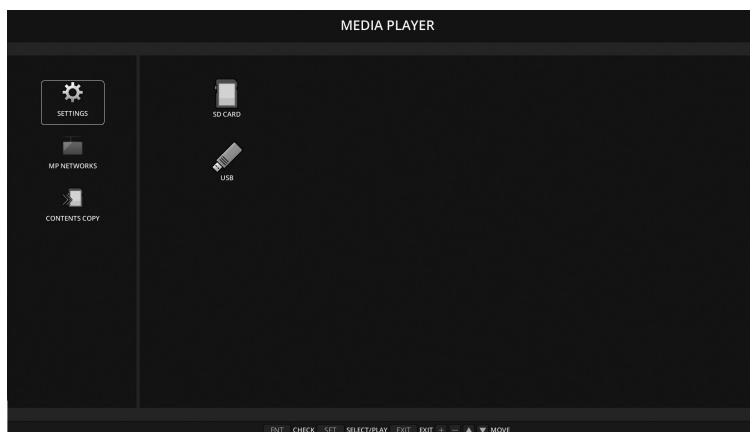

- Select [SETTINGS] to change the Media Player settings.
- While “AUTO PLAY” has been set to SLIDESHOW in SETTINGS, the monitor starts performing “AUTO PLAY” by the operation below:
  - When connecting an USB storage device to the USB (2A) port, with the monitor already powered ON and the Media Player top screen displayed.
  - When powering ON the monitor with an USB storage device already connected, and Media Player was the input source at the last power OFF.

For starting “AUTO PLAY”, the system will automatically search the folder which is set in the AUTO PLAY settings FOLDER field, in the USB storage device and then display found still images or movies. The images and movies will be displayed in the “Sorted” order.

**NOTE:** Only 1 USB storage device can be recognized by the viewer.

A window will appear when you press the control panel buttons while the Media Player is active. You can select to control either the OSD menu or the Media Player from the window that opens.

Media Player contents are not played while TILE MATRIX is active.

If you play a motion image with the monitor position as portrait, please use the motion image which is rotated anticlockwise by 90°.

## Displayable/playable files

### Still

#### Supported formats

File extension	Supported
.jpg, .jpeg, .jpe	Baseline, Progressive, RGB, CMYK
.png	Interlace, $\alpha$ channel

### Motion image

#### Supported formats

File extension	Video codec	Audio codec
.mpg, .mpeg	MPEG1, MPEG2	MPEG Audio Layer3 (Abbreviation: MP3) AAC-LC (Abbreviation: AAC), LPCM
.wmv	H.264, WMV	MP3, WMA Standard, WMA 9/10 Professional
.mp4	H.264	MP3, AAC
.mov	H.264	MP3, AAC
.flv, .f4v	H.264	MP3, AAC

## BGM

### Supported formats

File extension	Audio codec
.wav	LPCM
.mp3	MP3

### Information

Item	Conditions	
Resolution	JPEG	5000x5000
	PNG	4000x4000
	MPEG1	480@30fps
	MPEG2	MP@ML, MP@HL, 1080p@30fps / 1080i@60fps
	H.264	High profile Lv.4.2, 1080p@30fps / 1080i@60fps
	WMV	Advanced@L3, Simple&Main
Video bit date	-	Up to 15Mbps
Audio sampling rate	-	Up to 48KHz
Audio bit rate	MP2	Up to 384Kbps
	MP3	Up to 320Kbps
	AAC	Up to 1440Kbps

**NOTE:** Depending on the file, it may not play even when it satisfies all above mentioned conditions.  
Depending on network environments, the type of USB storage device, and file bitrate, it may not play still image files.  
You cannot play DRM (Digital Right Management) files.

### MEDIA PACKAGE

This function plays contents data which is programmed with our authoring software.  
Please save the contents data to a USB storage device or a microSD memory card.  
Please select a contents with “.sch” extension to play.

Please refer to the authoring software user’s manual for the format of Media package.  
Visit our web site for downloading authoring software and its user’s manual.

**NOTE:** Content schedule works based on the DATE & TIME setting of the monitor.  
If you change the DATE & TIME setting while content is playing, please let the contents finish playing.  
When the content starts playing again, the content schedule follows the changed DATE & TIME setting.  
The “Date” format is changed with setting a LANGUAGE. If you change the LANGUAGE while content is playing, please follow the same strategy as when changing the DATE & TIME setting.

### Compatible microSD memory card

Format a microSD memory card in the FAT32 format or FAT16 format.  
Refer to the computer’s instruction user’s manual or Help file on how to format a microSD memory card.

### Information

Up to 32GB microSDHC is supported.

**NOTE:** It is not guaranteed to work with all microSD memory card sold commercially.  
microSD with CPRM is not supported.  
microSD UHS-1 or UHS-2 are not supported.

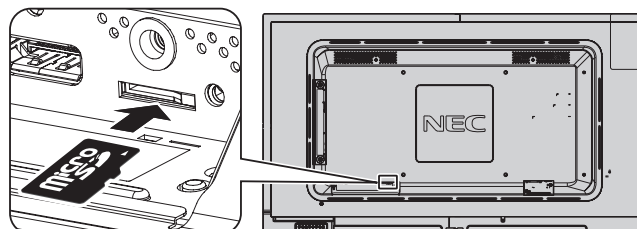

- When inserting a microSD memory card, please make sure of the microSD memory card direction then insert it correctly.
- When ejecting a microSD memory card from the microSD card slot, press the center of the microSD memory card then take it out.

### Installing microSD card slot cover

To secure your microSD memory card, we recommend you install the microSD card slot cover. Please insert the edge of the microSD card cover to the hole. (Recommended Fasten Force: 139 - 189N•cm).

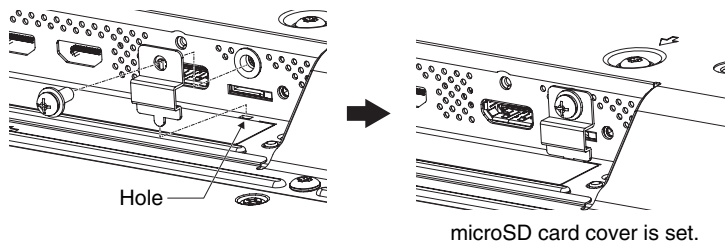

### Compatible USB memory

Format a USB memory in the FAT32 format or FAT16 format for using it in the Media Player. Refer to the computer's instruction user's manual or Help file on how to format a USB memory.

Please use a USB memory with this monitor in accordance with the drawing below. If the physical size of the USB device is larger than than the supported sizes listed below, please use a USB extension cable.

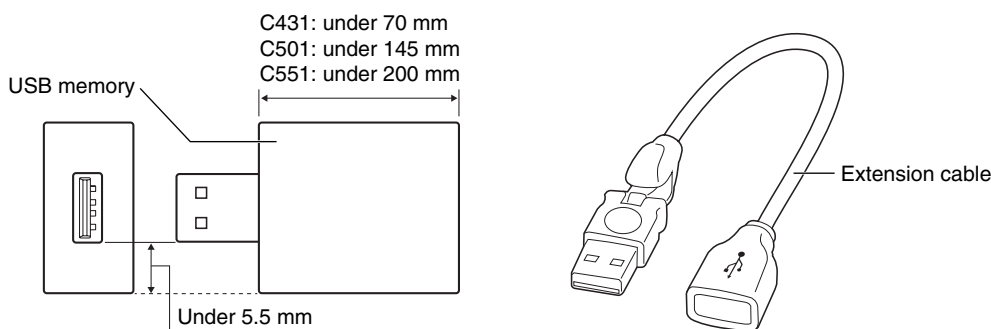

**NOTE:** Check the format if this device cannot recognize the connected USB memory. It is not guaranteed to work with all USB memories sold commercially. Please connect the USB memory to the USB (2A) port (See page 16).

### File display screen

The files can be displayed using either icons or thumbnails in the Media Player.

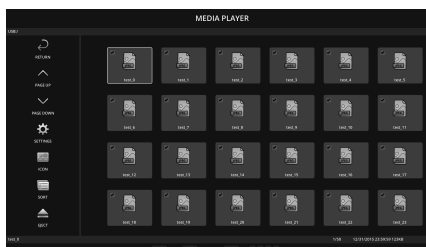

Icon display

	RETURN	Goes back one subsequent level higher.
	PAGE UP	Displays a list of the previous files.
	PAGE DOWN	Displays a list of the next files.
	SETTINGS	Displays the setting screen.
	THUMBNAILS/ICON	Switches between thumbnail display and icon display.
	SORT	Changes the order to display files by name (filename), type (file extension), date (date of creation), or size (file capacity). The default sorting order is by "Name".
	EJECT	Disconnects from the USB storage device or the microSD memory card inserted to the monitor. Please select EJECT when file list is displayed.

**NOTE:** The maximum number of files that can be displayed in a folder including folder icons is 300. A folder hierarchy is shown up to level 16. The icon of a file whose type cannot be determined is indicated by a "?". Depending on the file, thumbnail cannot be displayed.

## Slideshow display

- Select a folder that contains images or movies.
- A slideshow can be displayed using “MANUAL” in which the images are switched by operating a button on the remote control, or “AUTO” in which the images are switched automatically at a set interval (PLAY MODE is “AUTO”).
- The default factory setting is “MANUAL”. To perform “AUTO”, set the “PLAY MODE” to “AUTO”.
- The images will be displayed in the order selected under “Sort” on the file display screen.
- When still images in high resolutions are displayed as the Slideshow, it may go back to the file display screen.

## Media Player settings

Select the  icon in the file list screen or top screen of the Media Player to display the configuration screen of the Media Player.

The following settings can be configured on the configuration screen.

### SLIDESHOW

Menu	Function
SCREEN SIZE	Selects ACTUAL SIZE or BEST FIT.
PLAY MODE	Selects AUTO or MANUAL.
INTERVAL	Sets interval time.
REPEAT	Check the check box to repeat slideshow.
AUDIO FILE	Selects an audio file.
BGM	Check the check box to enable BGM.
PLAY END SCREEN	Selects a setting for when the slideshow finishes.
	BLACK SCREEN: When the slideshow finishes, a black screen is displayed.
	FILE LIST: When the slideshow finishes, it goes back to the file list screen.
	SAVE LAST SCREEN: When the slideshow finishes, the last slideshow image is kept on the screen.

### MEDIA PACKAGE

Menu	Function
SCREEN SIZE	Selects ACTUAL SIZE or BEST FIT.
INTERLOCK POWER	Check the check box to enable the monitor to be turned ON or STANDBY by the media package schedule. If the POWER SAVE is set to DISABLE, even if a content stops playing by a media package schedule, the monitor does not go into standby mode.
PLAY END SCREEN	Selects a setting for when the slideshow finishes.
	BLACK SCREEN: When the slideshow finishes, a black screen is displayed.
	FILE LIST: When the slideshow finishes, it goes back to the file list screen.

### AUTO PLAY

Automatically displays selected folder when the monitor is turned on with MP as the selected input.

Menu	Function
AUTO PLAY	OFF: Automatic play mode is off.
	SLIDESHOW: Automatically plays a selected file.
FOLDER	Select a file.

### PRESET CONTENTS

Plays selected folder when the monitor has no signal input.

Menu	Function
ENABLE	Check the check box to enable preset contents.
FOLDER	Select a file.

Please press OK to activate above settings.

If OK is not pressed, settings that you set are not activated.



## NETWORK & OTHER SETTINGS

Bellow are the options for the Network settings and Shared Folder settings for the Media Player.

To select the settings, press the remote control SET/POINT ZOOM button on the NETWORK & OTHER SETTINGS.

NETWORK SETTINGS for Media Player

Menu	Function
IP SETTING	Set these settings.
IP ADDRESS	
SUBNET MASK	
DEFAULT GATEWAY	
DNS	
DNS PRIMARY	
DNS SECONDARY	

NETWORK INFORMATION for the Media Player displays what you set in the NETWORK SETTINGS for the Media Player.

### SHARED FOLDER

There are two settings for configuring the SHARED FOLDER.

Press the remote control SET/ZOOM button to open the shared settings options.

- SHARED SD CARD SETTINGS

Folders saved in a computer on the network can be copied to the connected microSD memory card using a web browser on the connected computer.

Menu	Function
ENABLE	Check the checkbox to enable SHARED SD CARD SETTINGS.
USER NAME	USER NAME is displayed. It is the same name as the monitor name and it is not changeable.
PASSWORD	Set password.

Please press OK to activate settings in the SHARED SD CARD SETTINGS.

If OK is not pressed, settings that you set are not activated.

- SHARED FOLDER SETTINGS.

Folders saved in a computer on the network can be copied to the connected microSD memory card by controlling the monitor.

Menu	Function
ENABLE	Check the checkbox to enable SHARED FOLDER SETTINGS.
SHARED FOLDER	Set the IP address of the network shared folder location that contains the files for copying to the microSD card.
USER NAME	Set USER NAME which is used when connecting the monitor to the shared folder.
PASSWORD	Set password.

Please press OK to activate settings in the SHARED FOLDER SETTINGS.

If OK is not pressed, settings that you set are not activated.

1 to 4 shared folders can be set.

When the connection to the shared folder fails, an error message is displayed and an "x" is displayed in the folder icon.



Carry out the following checks in this case.

- Is the name of the destination folder correct?
- Is the destination folder set for sharing?
- Have access rights been set in the destination folder?
- Are there any displayable files saved in the destination folder?

### SHIFT NO SIGNAL

This setting is for a situation when the monitor detects no signal input. If ENEBLE is ticked, the monitor goes to no signal status.

The monitor detects no signal when the monitor is in the following conditions:

- After contents or images are played.
- While the monitor is displaying USB  window or SD CARD  window.

Menu	Function
ENABLE	Check the checkbox to enable SHIFT NO SIGNAL.
INTERVAL	Set the time when the monitor goes into no signal after playing detected items.

Please press OK to activate settings in the SHIFT NO SIGNAL.

If OK is not pressed, settings that you set are not activated.

# Using SHARED SD card SETTINGS

You can copy data to the microSD memory card, such as motion or still images, from a computer connected to the same network as the monitor.

Please set the NETWORK SETTINGS for the Media Player (See page 23) first to copy data.

**NOTE:** When the monitor is copying a folder, the LED indicator blinks in red. When the monitor is in this condition, do not eject a microSD memory card from the monitor and do not turn off the monitor's main power. Ejecting the microSD card or turning off the monitor while copying files may corrupt the data. If you press the STANDBY button on the remote control or the POWER button on the monitor while the LED indicator is blinking in red, the monitor goes into standby after completing the folder copy. Files which you can copy are still, motion image and BGM only. You cannot copy media package contents.

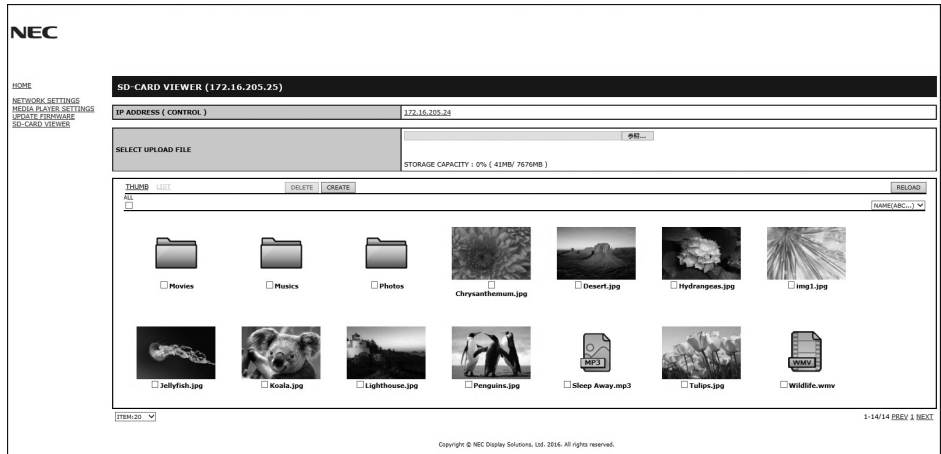

## Setting procedure

1. Open the Monitor LAN control of the network connected monitor then select SD-CARD VIEWER.
2. Select SEARCH to display the IP ADDRESS of the currently connected monitor and all compatible monitors on the same network.
3. Select the IP ADDRESS of the currently connected monitor.
4. Enable upload, delete and sort files that are saved in the microSD memory card connected to the monitor.

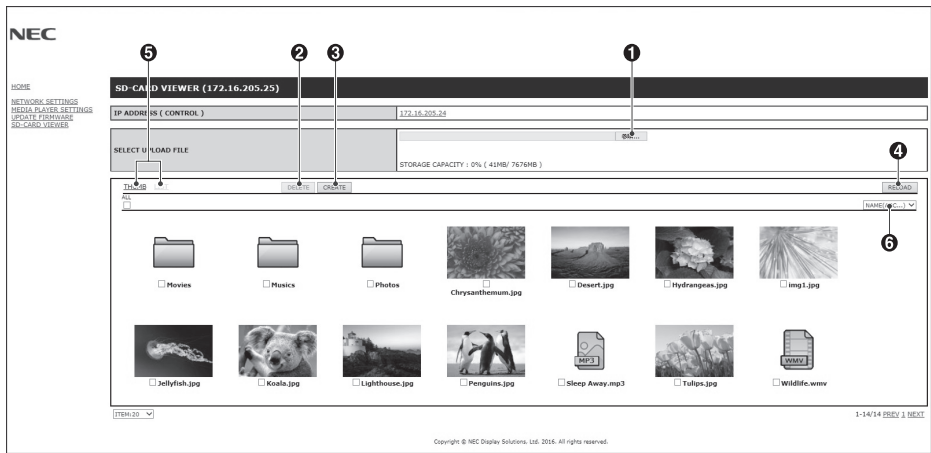

## Function

### 1. SELECT UPLOAD.

Press SELECT then choose the files to be copied to the microSD memory card.

File upload window appears and shows the selected files.

Once OK is selected, file uploading starts.

**NOTE:** Please check the microSD memory card storage capacity before copying files.

STORAGE CAPACITY shows the connected microSD memory card capacity.

### 2. DELETE.

Select files or folders.

DELETE FOLDERS/FILES window appears.

Once OK is selected, the selected files or folders are deleted.

### 3. CREATE.

A new folder is created in the microSD memory card connected to the monitor.

Insert folder name and select OK. A maximum of 255 alphanumeric characters is allowed.

4. RELOAD.  
Updates microSD memory card data.
5. THUMB/LIST.  
The files can be displayed using either icons or thumbnails.  
Displays description of the file or folder if you select thumb name or file name.
6. SORT.  
Select sort type. The folders saved in the microSD are sorted based on what you selected for the sort type.

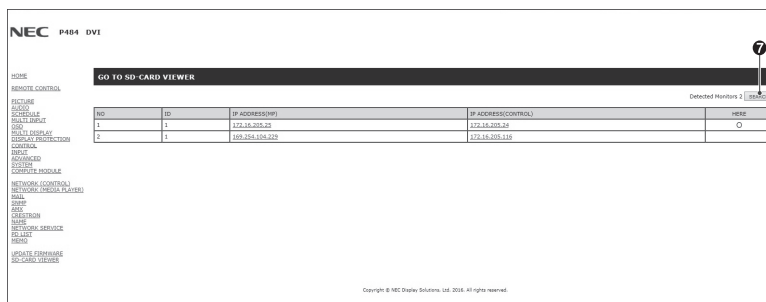

7. Connect to the other monitor's SD-CARD VIEWER then open them.  
By running the SEARCH, as described on the previous page, this window shows all compatible monitors on the same network as the current monitor.  
To open the other monitor's web page in a new tab, right-click on its IP address. To open the other monitor's web page in a new window, left-click on its IP address.

## Using CONTENTS COPY

You can copy all data saved in a USB storage device or saved in a shared folder, which is set in the connected computer or a server, to a microSD memory card.

For copying shared folder data, please set SHARED FOLDER SETTINGS (See page 23) first.

1. Select CONTENTS COPY at the top screen of the Media Player.
2. Select a USB storage device or a folder.
3. Select OK to start copying. All data saved in the folder or device is copied to the microSD memory card and the original data saved in the microSD memory card is deleted.

**NOTE:** "Out of disk space" is displayed if the microSD memory card storage capacity is not enough to copy selected folders. When contents copy has occurred, previous data that was saved in the microSD memory card is deleted. Only devices connected to the monitor are shown. When the monitor is copying a folder, the LED indicator blinks in red. When the monitor is in this condition, do not eject the microSD memory card from the monitor and do not turn off the monitor's main power. Ejecting the microSD card or turning off the monitor while copying files may corrupt the data. If you press the STANDBY button on the remote control or the POWER button on the monitor while the LED indicator is blinking in red, the monitor goes to standby after completing the folder copy.

## Using Emergency contents

In case of emergency sends a command to the monitor, from a computer connected to the monitor, to play the emergency contents folder. Please create an EMERGENCY CONTENTS folder as a root folder in the microSD memory card that is connected to the monitor.

Instructions for the EMERGENCY CONTENTS can be found on the CD included with the monitor. The file is called "External\_control.pdf".

## Information OSD

The Information OSD provides information such as: Input Source, Picture Size, etc. Press the DISPLAY button on the remote to bring up the Information OSD.

MONITOR ID: 1  
IP ADDRESS: 192.168.0.10

HDMI1  
AUDIO:IN1  
ASPECT:FULL  
1024 X 768  
48KHz/60Hz

①

②

③

④

① Input name

② Audio input name

③ Picture aspect

④ Input Signal Information

⑤ Communication Info

## Picture Mode

Select from five different picture modes, either via the OSD menu item PICTURE MODE, or using the PICTURE MODE button on the wireless remote control.

For DisplayPort, VGA (RGB), HDMI1, HDMI2, HDMI3

HIGHBRIGHT → STANDARD → sRGB → CINEMA → CUSTOM1 → CUSTOM2



For VGA (YPbYr), VIDEO, MP

HIGHBRIGHT → STANDARD → CINEMA → CUSTOM1 → CUSTOM2



### PRESET types

PRESET	PURPOSE
HIGH BRIGHT	Highest brightness setting.
STANDARD	Standard setting.
sRGB	The standard color space used for the Internet, Windows® operating systems and digital cameras. Recommended setting for general color management.
CINEMA	A setting that boosts dark tones; best suited for movies.
CUSTOM	Custom setting.

# OSD (On-Screen-Display) Controls

**NOTE:** Some functions may not be available depending on the model or optional equipment.

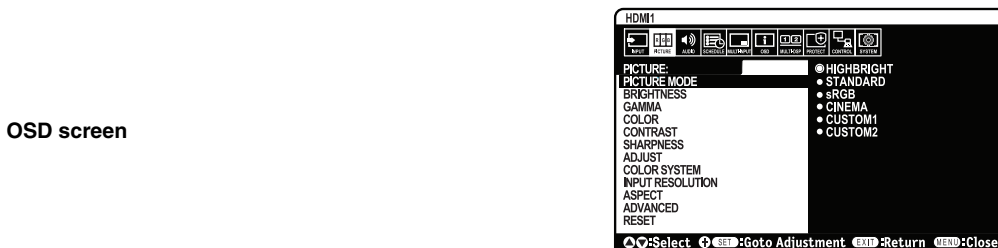
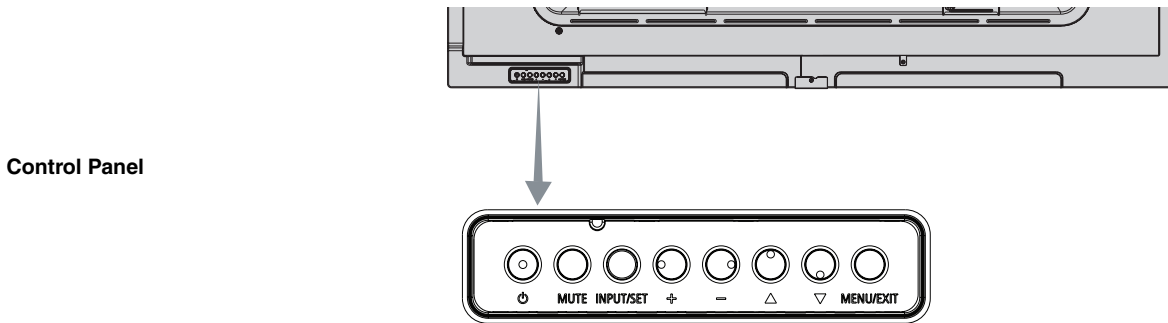
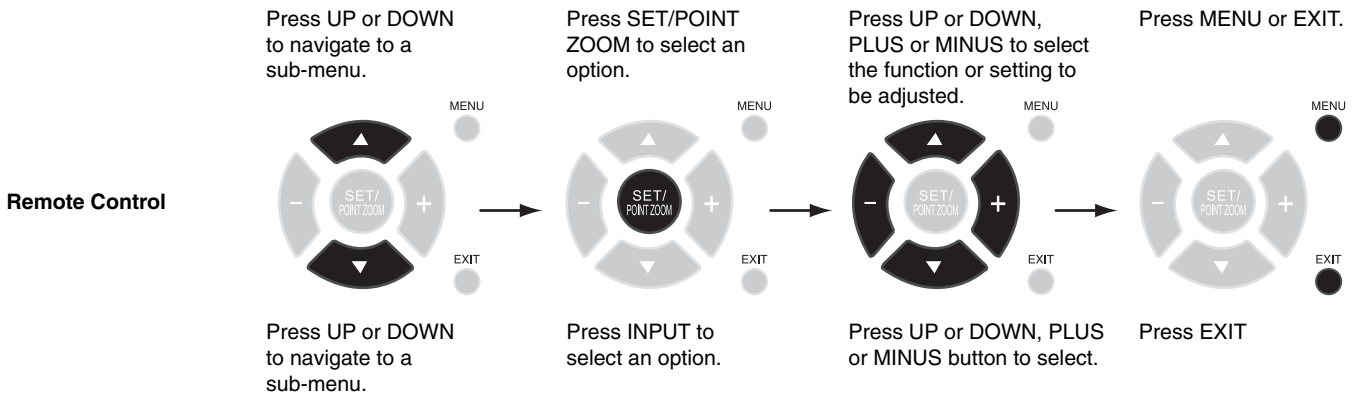
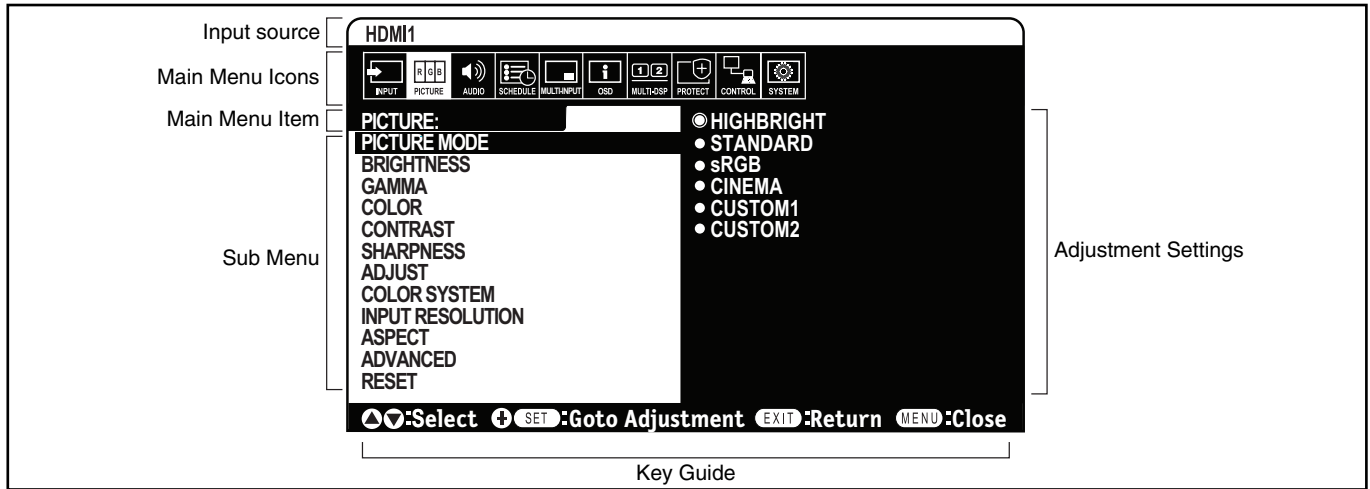

## Setting

INPUT	
DisplayPort	Select input signal.
HDMI1	
HDMI2	
HDMI3	
VGA (RGB/YPbPr)	
VIDEO	
MP	Displays images or movies saved in microSD memory card or USB storage device. Please refer to the Media Player setting (See page 19).
PICTURE	
PICTURE MODE	Select picture mode: [HIGHBRIGHT], [STANDARD], [sRGB], [CINEMA], [CUSTOM1], [CUSTOM2]. See page 26.
BRIGHTNESS	
BACKLIGHT	Adjusts the overall image and background brightness. Press + or - to adjust. NOTE: When MODE1 or MODE2 is selected in ROOM LIGHT SENSING, this function cannot be changed.
BRIGHTNESS*1, *4	Adjusts the image brightness in relationship to the background. Press + or - to adjust.
GAMMA*1	Select a monitor gamma correction for best picture quality. Selection depends on the desired usage.
NATIVE	Gamma correction is handled by the LCD panel.
2.2	Typical monitor gamma for use with a computer.
2.4	Good for video (DVD, etc.)
COLOR*1	
COLOR*2, *4 Except for VGA (RGB) input	Adjusts the color depth of the screen. Press + or - to adjust.
COLOR TEMPERATURE*2	Adjusts the color temperature of the entire screen. A low color temperature will result in a reddish screen. A high color temperature will make the screen bluish. If TEMPERATURE needs further adjustment, the individual R/G/B/ levels of the white point can be adjusted. To adjust the R/G/B levels, set CUSTOM as COLOR TEMP selection. NOTE: Predefined 6500k is set as picture mode, a color temperature of 6500k is predefined so it cannot be changed.
COLOR CONTROL*2	Adjusts the hue of the Red, Yellow, Green, Cyan, Blue and Magenta.
HUE*4 MP, VIDEO inputs only	Adjusts the hue of the screen. Press + or - to adjust.
CONTRAST*1, *2, *4	Adjusts the image brightness in relationship to the input signal. Press + or - to adjust.
SHARPNESS*2, *4 Except for VGA (RGB) input	Adjusts the crispness of the image. Press + or - to adjust.
ADJUST	
AUTO SETUP VGA (RGB) input only	Automatically adjusts Screen Size, H position, V position, Clock and Phase.
AUTO ADJUST VGA (RGB) input only	Please use ON normally. When you select OFF, H Position, V Position and Phase are not adjusted automatically when new timing is detected.
H POSITION*3 VGA (RGB), VGA (YPbPr) inputs only	Controls the horizontal position of the image within the Display area of the LCD. Press + to move right. Press - to move left.
V POSITION*3 VGA (RGB), VGA (YPbPr) inputs only	Controls the vertical position of the image within the Display area of the LCD. Press + to move up. Press - to move down.
CLOCK VGA (RGB) input only	Press + to expand the width of the image on the right of the screen. Press - to narrow the width of the image on the left.
PHASE VGA (RGB) input only	Adjusts the visual "noise" on the image.

\*1: This function is not available when sRGB is selected at PICTURE MODE.

\*2: This function is not available by the selection at HDMI/DisplayPort MODE.

\*3: This function is not available when 1:1 is selected as ASPECT.

\*4: This function is not available for still image by MP input.

<b>COLOR SYSTEM</b> <small>VIDEO input only</small>	The selected Color System depends on the video format of the input signal.
AUTO	Automatically chooses Color System setting based on input signal.
NTSC	
PAL	
SECAM	
4.43 NTSC	
PAL-60	
<b>INPUT RESOLUTION</b> <small>VGA (RGB) input only</small>	Selects one of the following pair of resolutions as the input signal priority: 1366 x 768 or 1280 x 768 or 1024 x 768 (vertical resolution 768)
<b>ASPECT*1</b>	Select the aspect ratio of the screen image. NOTE: When the ASPECT is ZOOM, the image will be changed to FULL image before TILE MATRIX, then start to TILE MATRIX. After TILE MATRIX, the ASPECT will be returned previous ASPECT or set ASPECT during TILE MATRIX. If you change H POSITION and V POSITION settings with a reduced image, the image would not be changed. If SCREEN SAVER is set, the ASPECT setting automatically change to FULL from what you set. Once SCREEN SAVER is off then ASPECT setting will get back to the setting what you originally set. This function is not available when MOTION in SCREEN SAVER is active. When the ASPECT is set to ZOOM while TILE MATRIX is set to active, after releasing TILE MATRIX or ZOOM will be active. POINT ZOOM function has limitations, please refer to POINT ZOOM (See page 50).
NORMAL	Shows the aspect ratio as it is sent from the source.
FULL	Fills the entire screen.
WIDE	Expands a 16:9 letter box signal to fill the entire screen.
1:1	Shows the image in a 1 by 1 Pixel format.
ZOOM	The image can be expanded/reduced. NOTE: The expanded image, which is outside of the active screen area, is not shown. The reduced image may have some image degradation.
ZOOM	Maintains the aspect ratio while zooming.
HZOOM	Horizontal zoom value.
VZOOM	Vertical zoom value.
H POS	Horizontal position.
V POS	Vertical position.
<b>ADVANCED</b>	
<b>OVER SCAN*2</b> <small>HDMI1, HDMI2, HDMI3, DisplayPort, VGA (YPbPr), VIDEO inputs only</small>	Some video formats may require different scanning modes in order to best display the image.
AUTO	Image size is set automatically. NOTE: This function is not available if input signal is VGA (YPbPr), VIDEO or MP.
ON	Image size is larger than what can be displayed. The image edge will appear cropped. Approximately 95% of the image will be shown on the screen.
OFF	Image size stays within the display area. The whole image is displayed on the screen. NOTE: When you use a computer with HDMI out, please set "OFF".
<b>NOISE REDUCTION</b> <small>VIDEO input only</small>	Adjusts the amount of noise reduction. Press + or - to adjust.
<b>TELECINE*2</b> <small>HDMI1, HDMI2, HDMI3, DisplayPort, VIDEO, VGA (YPbPr) inputs only</small>	Automatically senses the sources frame rate for optimal picture quality.
<b>ADAPTIVE CONTRAST*2, *3</b> <small>HDMI1, HDMI2, HDMI3, DisplayPort, VIDEO, VGA (YPbPr), MP inputs only</small>	Sets the level of adjustment for dynamic contrast. If HIGH is set, the image is displayed clearly but it makes brightness unstable due to the wide gap of contrast variation.
<b>RESET</b>	Resets all "PICTURE" settings back to factory settings except for PICTURE MODE.

\*1: Except for MP.

\*2: This function may not be available by the selection at HDMI/DisplayPort MODE.

\*3: This function is not available for still image by MP input.

<b>AUDIO</b>	
VOLUME	Increase or decrease output volume level.
BALANCE	
BALANCE	Select STEREO or MONO for the audio output. If you select STEREO, adjust the L/R volume balance. Press the + button to move the stereo sound image to right. Press the - button to move the stereo sound image to left. NOTE: BALANCE is not available if MONO is set at STEREO/MONO.
SURROUND	Artificial surround sound.
EQUALIZER	
TREBLE	To accentuate or reduce the high frequency range of audio signals. Press the + button to increase TREBLE. Press the - button to decrease TREBLE.
BASS	To accentuate or reduce the low frequency sound. Press the + button to increase BASS. Press the - button to decrease BASS.
AUDIO INPUT	Selects the audio input source: [IN1], [IN2], [DisplayPort], [HDMI1], [HDMI2], [HDMI3], [MP].
LINE OUT	Selecting VARIABLE enables control of the line out level with the VOLUME button.
AUDIO DELAY	
AUDIO DELAY	Activate a delay time to output the audio signal. The DELAY TIME can be set between 0 and 100 milliseconds. Set to ON to activate this function.
DELAY TIME	
RESET	Resets all AUDIO options back to factory settings, except for VOLUME.
<b>SCHEDULE</b>	
SCHEDULE SETTINGS	Creates a working schedule for the monitor. By pressing ▲▼, + - buttons, set below settings. By Input change buttons of the monitor or SET/ZOOM button of the remote control, you can select the check box. NOTE: Please set DAY & TIME before configuring the SCHEDULE SETTINGS. When the SCHEDULE SETTINGS window is closed, any schedules that you set are saved. If schedules are set for the same time, higher SETTINGS numbers are given the priority. If OFF TIMER is ON, SCHEDULE SETTINGS is not available. When you select an invalid input signal or picture mode, it will display in red. While the SCHEDULE SETTINGS window is open, schedules are not operated. Also, see page 37.
SETTINGS	Set ON to activate the schedule. Maximum 30 schedules are set.
POWER	Setting for the monitor power. Please set ON or OFF for each schedule.
TIME	Set the schedule operation time. If there is no specific time for the schedule set [--].
INPUT	Set the input signal for the schedule. To keep the input signal that is active when the schedule starts set [--]. When you set INPUT, please select ON at POWER.
PIC. MODE	Set the picture mode for the schedule. To keep the picture mode that is active when the schedule starts set [--]. When you set PIC. MODE, please select ON at POWER.
	Select one item from below (only one item is available).
DATE	Select this setting if the schedule is for one day schedule or irregular schedules.
EVERY DAY	Select this setting if the schedule is repeating every day.
EVERY WEEK	Select this setting if the schedule is repeating every week.
WEEKDAY	Select this setting if the schedule is on a weekday. This item is set by the WEEKEND and the HOLIDAY settings. A date, which is not selected at WEEKEND and HOLIDAY settings, is set as a weekday.
WEEKEND	Select this setting if the schedule is on a weekend. Schedule operates on the date that is set at WEEKEND SETTINGS.
HOLIDAY	Schedule operates on the date that is set at HOLIDAY SETTINGS.
SCHEDULE LIST	List of working schedules. Displays up to 30 schedules from present time.



<b>HOLIDAY SETTINGS</b>	
No.	Creates holiday schedule for the monitor.
YEAR MONTH DAY WEEK	Set YEAR and MONTH. Select DAY or WEEK. DAY: Set a day. WEEK: Set a week and the day of the week. If you set [--] at MONTH or YEAR, every month or year of the day you set is set as a holiday.
END DAY	Set the end of holiday date. If you schedule beyond a year, please separate the schedule per year. NOTE: If DAY is not set, END DAY is not available. If your holiday setting includes [--] for year or month, END DAY is not available.
SET/DELETE	Sets or deletes a schedule.
<b>WEEKEND SETTING</b>	
WEEKEND	Set the day of the week.
<b>DATE &amp; TIME</b>	
	Sets the date, time, and daylight savings region. Date & time must be set in order for the "SCHEDULE" function to operate. See page 30. NOTE: If the monitor's main power has been turned off for two weeks, the DATE & TIME setting goes back to the default setting and the clock function stops working. When turning on the monitor after the clock function stops, the LED indicator glows red and blue. This indicates that the clock function is back to its default setting. Please set DATE & TIME again.
YEAR	Sets the year for the real-time clock.
MONTH	Sets the month for the real-time clock.
DAY	Sets the day for the real-time clock.
TIME	Sets the time for the real-time clock.
CURRENT DATE TIME	Shows the current date and time.
<b>DAYLIGHT SAVING</b>	
	Sets daylight savings on or off. NOTE: Please set the TIME & DATE setting first if you change the DAYLIGHT SAVING setting.
DAYLIGHT SAVING	If ON is selected, please set daylight savings settings below.
BEGIN MONTH	Set daylight savings beginning date.
END MONTH	Set daylight savings ending date.
TIME DIFFERENCE	Set the time difference.
OFF TIMER	Set the monitor to power off after a pre-set time period. A time period between 1 to 24 hours may be set. NOTE: SCHEDULE is not available if OFF TIMER is ON.
RESET	Resets the following settings within the SCHEDULE menu back to factory setting: DATE & TIME and DAYLIGHT SAVING.
<b>MULTI INPUT</b>	
<b>INPUT DETECT</b>	
NONE	Selects the method of input detection the monitor uses when more than one signal source is connected. The Monitor will not search for signals at the other video input ports.
FIRST DETECT	When the current video input signal is not present, the monitor searches for a video signal from another video input port. If a video signal is present in the other input, the monitor switches from the current video source to this active video source automatically. The monitor will not look for any other video signals while the current video source is present.
CUSTOM DETECT	Sets the priority of input signals. When CUSTOM DETECT is selected, the monitor searches on pre-set inputs only. When you use digital input (DisplayPort, HDMI1, HDMI2 and HDMI3), other digital input is not detected. When you use analog input (VGA or VIDEO), other analog input is not detected.

<b>TERMINAL SETTINGS</b>	
VGA MODE	Selects RGB or YPbPr for VGA input.
DisplayPort BIT RATE	Select RBR or HBR.
VIDEO LEVEL	RAW: For computer settings. Show all input signals of 0-255 gray levels. EXPAND: For audio-visual equipment settings. Expands the input signals from 16-235 gray levels to 0-255 gray levels. AUTO: Automatically sets input signals by adjusting connected equipment. NOTE: This function is available only in HDMI or DisplayPort and is selected at INPUT SIGNAL.
HDMI/DisplayPort MODE	AUTO: It automatically switches the internal signal processing to RGB or YUV depending on the information of the HDMI signal. RGB: For PC or other computer equipment connected. YUV: For DVD player connected.
RESET	Resets MULTI INPUT options back to factory settings, except for INPUT DETECT (priority of input signals only) and DisplayPort BIT RATE.
<b>OSD</b>	
LANGUAGE	Select the language used by the OSD.
ENGLISH	
DEUTSCH	
FRANÇAIS	
ITALIANO	
ESPAÑOL	
SVENSKA	
РУССКИЙ	
中文	
日本語	
OSD TIME	Turns off the OSD after a period of inactivity. The preset choices are 10-240 seconds.
OSD POSITION	Selects the location where the OSD appears on the screen.
INFORMATION OSD	Selects whether the Information OSD is displayed or not. The Information OSD will appear when the input signal or input source changes. The Information OSD will also give a warning when no signal is detected or the signal is out of range. An interval between 3 to 10 seconds is selectable for the Information OSD to appear.
COMMUNICATION INFO.	The MONITOR ID and IP ADDRESS will appear when the remote control Display button is pressed.
OSD ROTATION	Determines the OSD orientation between landscape and portrait.
LANDSCAPE	Shows the OSD in landscape orientation.
PORTRAIT	Shows the OSD in portrait orientation. NOTE: If PORTRAIT is set, CLOSED CAPTION is not available.
KEY GUIDE	Key guide is shown when the OSD menu is displayed.
MEMO	Defines a title and a message via HTTP server. See page 47.
INPUT NAME	You can create a name for the INPUT currently being used. Max: 14 characters, including Space, A-Z, 0-9, and some symbols.
CLOSED CAPTION <small>VIDEO input only</small>	Activates closed captioning. NOTE: This function is released if the following function is activated: PORTRAIT in OSD ROTATION, TILE MATRIX, SCREEN SAVER, STILL, POINT ZOOM.
RESET	Resets the following settings within the OSD menu back to factory setting: OSD TIME, OSD POSITION, INFORMATION OSD, OSD TRANSPARENCY, CLOSED CAPTION.

## MULTI DISPLAY

TILE MATRIX*1 (Except for MP)	<p>Allows one image to be expanded and displayed over multiple screens (up to 100) through a distribution amplifier.</p> <p>NOTE: Low resolution is not suitable for tiling to a large number of monitors. You can operate without a distribution amplifier at a lower number of screens.</p> <p>This function is released when selecting SCREEN SAVER except for NONE.</p> <p>Zoom will not work when Tile Matrix is activated.</p> <p>When "ZOOM" is selected in ASPECT while executing TILE MATRIX, the setting will be applied after completing of TILE MATRIX.</p> <p>When TILE MATRIX is active the following functions are not available: CLOSED CAPTION, STILL, POINT ZOOM. Please refer to the POINT ZOOM function for more detail (see page 50).</p> <p>If Media Player contents are played while TILE MATRIX is active, the image play timing might have a gap within monitors.</p> <p>This function is not available when SCREEN SAVER is active.</p>
H MONITORS	Number of monitors arranged horizontally.
V MONITORS	Number of monitors arranged vertically.
POSITION	Select which section of the tiled image to be displayed on the monitor.
TILE COMP	Turns the TILE COMP feature on. If YES is set to the TILE COMP, you can adjust a displayed image size and position by pressing the + button or the - button on the remote control.
ENABLE	Enables Tile Matrix settings that you set.
TILE MATRIX MEM	When "INPUT" is selected, TILE MATRIX setting is applied to each signal input.
COMMON	All settings in the TILE MATRIX are saved for the all signal input.
INPUT	All settings in the TILE MATRIX are saved for the signal input which signal input you selected.
ID CONTROL	Sets the monitor ID number from 1-100 and group ID from A-J. The Group ID is made of multiple selections. Also see page 38.
RESET	Resets all settings within the MULTI DISPLAY menu back to factory setting.

## DISPLAY PROTECTION

POWER SAVE	Sets ENABLE or DISABLE. If you set it to ENABLE, set how long the monitor waits to go into power save mode after signal is lost. For more detail, please check Power Indicator (See page 36).
AUTO POWER SAVE TIME SETTING	Set the time of the monitor goes into auto power save mode after signal is lost.
QUICK TURN ON	When ENABLE is selected, the monitor will quickly return to the ON state when a signal is detected. Enabling this option increases standby power consumption.
STANDBY USB POWER	When ENABLE is selected, you can use USB port for power supply in standby mode.
POWER SAVE MESSAGE	When the monitor goes into power save mode, a message is displayed when ON is selected.
HEAT STATUS	Shows the actual status of the backlight and temperature sensors.
SCREEN SAVER	<p>Use the SCREEN SAVER function to reduce the risk of Image Persistence.</p> <p>NOTE: When the screen saver is activated, the image will be changed to FULL image. After the screen saver stops the activity, the image will be reproduced again with the current ASPECT setting.</p> <p>When the SCREEN SAVER is set to active, STILL, POINT ZOOM, TILE MATRIX, CLOSED CAPTION are not available.</p>
BACKLIGHT	The brightness of the backlight is decreased when "ON" is selected. NOTE: Do not select this function when ROOM LIGHT SENSING is set to MODE1 or MODE2.
MOTION	The screen image is slightly expanded and moves in 4 directions (UP, DOWN, RIGHT, LEFT) at user determined intervals. You can set interval time and zoom ratio.
SIDE BORDER COLOR	Adjusts the color of the side borders when a 4:3 image is reproduced. By pressing the + button on the remote control. The side borders will become brighter. By pressing the - button, the side borders will become darker. Background color of the Media Player window is also changed.
POWER ON DELAY	Adjusts the delay time between being in "standby" mode and entering "power on" mode.
DELAY TIME	"POWER ON DELAY" can be set between 0 and 50 seconds.
LINK TO ID	When "ON" selected, delay time is linked with Monitor ID. It takes more time as larger ID number.
ALERT MAIL	Set ON to activate alert mail. Please refer to Mail Setting (See page 45).
RESET	Resets the all settings within the DISPLAY PROTECTION menu back to factory setting except for POWER ON DELAY.

\*1: Except for MP.

## CONTROL

NETWORK INFORMATION	Shows the current network settings.
LAN	NOTE: When changing any LAN settings, you need to wait several seconds until modified LAN settings are applied.
IP SETTING	Enabling this option automatically assigns an IP address to the monitor from your DHCP server. Disabling this option allows you to enter a fixed IP address and subnet mask data obtained from your network administrator. NOTE: Consult your network administrator for the IP address when AUTO is selected for [IP SETTING].
IP ADDRESS	Set your IP address for the monitor connected to the network when MANUAL is selected for [IP SETTING].
SUBNET MASK	Set your subnet mask data for the monitor connected to the network when MANUAL is selected for [IP SETTING].
DEFAULT GATEWAY	Set your default gateway for the monitor connected to the network when MANUAL is selected for [IP SETTING]. NOTE: Enter [0.0.0.0] to delete the setting.
DNS	Set the IP addresses of DNS servers. AUTO: The DNS server, which is connected with the monitor, will automatically assign its IP address. MANUAL: Manually enter the IP address of the DNS server which is connected with the monitor.
DNS PRIMARY	Enter the primary DNS server settings of the network connected with the monitor. NOTE: Enter [0.0.0.0] to delete the setting.
DNS SECONDARY	Enter the secondary DNS server settings of the network connected with the monitor. NOTE: Enter [0.0.0.0] to delete the setting.
CHANGE PASSWORD	Allows the security password to be changed. The factory preset password is 0000.
SECURITY	
PASSWORD	Insert a security password.
SECURE MODE	
OFF	The security password is not required when the monitor power is on.
START-UP LOCK	The security password is required when the monitor power is on.
CONTROL LOCK	The security password is required when a remote control button or a control button on the monitor is pressed.
BOTH LOCK	The security password is required when either the monitor is powered on, or a remote control button or a control button on the monitor is pressed.
IR LOCK SETTINGS	Prevents the monitor from being controlled by the wireless remote control. When ACTIVATE is selected, all the settings are activated. NOTE: IR LOCK SETTINGS is a function intended only for the wireless remote control buttons. This function does not lock out access to all buttons of the monitor. To return to normal operation, press the "DISPLAY" button on the remote control then hold it down for more than 5 seconds.
MODE SELECT	Selects the mode UNLOCK, ALL LOCK or CUSTOM LOCK.
UNLOCK	All buttons on the remote control are available for normal operation.
ALL LOCK	Locks all remote control buttons.
CUSTOM LOCK	Selects which buttons to be locked from POWER, VOLUME, and INPUT button. Except for CUSTOM LOCK settings, other buttons on the remote control are locked. POWER: When LOCK is selected, the POWER button is locked. VOLUME: When UNLOCK is selected, set the minimum and maximum volume between VOL.0 to VOL.100. VOLUME (+) button and VOLUME (-) buttons are only available from the minimum volume to the maximum volume you set. When LOCK is selected, VOLUME (+) button and VOLUME (-) buttons are locked. INPUT: When UNLOCK is selected, choose up to three buttons from DisplayPort, HDMI1, HDMI2, HDMI3, VGA (RGB/YPbPr), VIDEO, Media Player which you prefer to be unlocked. The unselected buttons are locked. When LOCK is selected, all INPUT buttons are locked.

KEY LOCK SETTINGS	Prevents the monitor from being controlled by buttons on the monitor. When ACTIVATE is selected, all of the settings are activated. NOTE: KEY LOCK SETTINGS is a function intended only for the buttons of the monitor. This function does not lock out access to all buttons on the remote control. To activate the control key lock function, press the power button for more than 3 seconds. To resume user mode, press the power button for more than 3 seconds.
MODE SELECT	Selects the mode UNLOCK, ALL LOCK or CUSTOM LOCK.
UNLOCK	All buttons are available for normal operations.
ALL LOCK	Locks all remote control buttons.
CUSTOM LOCK	Selects which buttons to be locked from POWER, VOLUME, and INPUT button. Except for CUSTOM LOCK settings, other buttons on the remote control are locked. POWER: When LOCK is selected, the POWER button is locked. VOLUME: When UNLOCK is selected, set the minimum and maximum volume between VOL.0 to VOL.100. The PLUS button (+) and the MINUS button (-) are only available from the minimum volume to the maximum volume you set. When LOCK is selected, the PLUS button (+) and the MINUS button (-) are locked. INPUT: When UNLOCK is selected, the INPUT/SET button is unlocked. CHANNEL: To lock channel buttons on the remote control, select it to LOCK then press ACTIVE, the UP button (▲) and the DOWN button (▼) are locked.
DDC/CI VGA (RGB) Input only	ENABLE/DISABLE: Turns ON or OFF the two-way communication and control of the monitor.
PING	Confirm successful connection with the network by communicating with a preset IP address.
IP ADDRESS	Sets an IP ADDRESS for sending PING.
EXECUTE	Checks a reply can be sent to the monitor or not from the IP ADDRESS by sending PING.
IP ADDRESS RESET	Resets IP ADDRESS SETTINGS back to factory settings.
AUTO DIMMING	Adjusts the backlight of the LCD automatically depending on the amount of ambient light. NOTE: This function is released if INPUT DETECT is set while AUTO DIMMING is active.
ROOM LIGHT SENSING	<p>The backlight of the LCD screen can be set to increase or decrease depending on the amount of ambient light within the room. If the room is bright, the monitor becomes correspondingly bright. If the room is dim, then the monitor will dim accordingly. The purpose of this function is to make the viewing experience more comfortable to the eye in a variety of lighting conditions.</p> <p>NOTE: When ROOM LIGHT SENSING is set, BACKLIGHT and BACKLIGHT in SCREEN SAVER functions are disabled.</p> <p>Do not cover the room light sensing sensor when you use MODE1 or MODE2.</p> <p>AMBIENT parameter setting ROOM LIGHT SENSING in OSD, select MODE1 or MODE2 and set MAX LIMIT, IN BRIGHT and IN DARK in each mode.</p> <p>MAX LIMIT: This is the max level of backlight, which you set. IN BRIGHT: This is the backlight level that the monitor will go up to when the ambient light level is highest. IN DARK: This is the level of backlight that the monitor will go down to when the ambient light level is low.</p> <p>When the ROOM LIGHT SENSING is enabled the Backlight level of the screen changes automatically according to the lighting conditions of the room (see figure below).</p> <p>MAX LIMIT: BACKLIGHT level is limited to your set level. IN DARK: BACKLIGHT level set for the monitor to use when ambient lighting level is low. IN BRIGHT: BACKLIGHT level set for the monitor to use when ambient lighting level is high.</p>

<b>POWER INDICATOR</b>	
POWER INDICATOR	Turns the LED on or off. If OFF is selected, the LED will not glow when the LCD monitor is in active mode.
SCHEDULE INDICATOR	Turns the LED on or off depending on a schedule activity which is set at "SCHEDULE SETTINGS". If OFF is selected, the LED will not glow even if a schedule is in active mode.
<b>CEC*</b>	
This function enables you to control the HDMI CEC compliant device connected via HDMI connector. *: CEC is an abbreviation of Consumer Electronics Control.	
CEC	When ON is set, please set items below. NOTE: If ON is selected, the below functions are activated. When the connected HDMI CEC device receives a play command, the monitor synchronously turns on then changes the input signal to HDMI. If the monitor has been turned on, when a connected HDMI CEC device received a play command, input signal is switched to HDMI. The connected HDMI CEC devices are controlled by the wireless remote control supplied with the monitor. Depending on the connected device, sometimes the device does not work properly.
AUTO TURN OFF	When the monitor goes to standby via remote control or the power button on the monitor, connected HDMI CEC device go to standby synchronously. NOTE: If the connected HDMI CEC device is recording, the device does not go into standby.
AUDIO RECEIVER	Activates HDMI CEC audio amplifier. If YES is set, outputs the sounds of the connected HDMI CEC device from the connected HDMI CEC audio amplifier. If YES is set, the internal speaker is set to mute. NOTE: When a HDMI CEC audio amplifier is connected, set to YES. Please set to NO if there is no connecting HDMI CEC audio device to the monitor.
SEARCH DEVICE	Searches the HDMI CEC device connected to the monitor. When search is success, the connected HDMI CEC device's type and registered device name are shown. When search has been completed or failed, the SEARCH DEVICE is set to NO automatically. To retry the SEARCH DEVICE, set it to YES again. After detected HDMI CEC devices, you can switch the device input by selecting the device.
RESET	Resets all the settings within the CONTROL menu back to factory setting except for LAN, CHANGE PASSWORD, SECURITY and PING.
<b>SYSTEM</b>	
MONITOR INFORMATION	Shows the model name, serial number and firmware version of your monitor. CARBON SAVINGS: Display the estimated carbon saving information in kg-CO2. The carbon footprint factor in the carbon saving calculation is based on the OECD (2008 Edition). CARBON USAGE: Display the estimated carbon usage information in kg-CO2. This is the arithmetic estimation, not actual measurement value. This estimation is based without any options.
FIRMWARE	Displays firmware version that is installed to the monitor.
MAC ADDRESS	Displays the MAC ADDRESS.
FACTORY RESET	All items are returned to factory shipment state. NOTE: You can reset all items in all daisy chained monitors. Please be careful to avoid resetting all items inadvertently.

Default values can be provided on request.

## NOTE 1: CREATING A SCHEDULE

The schedule function allows the monitor to be set to power on or set it to be on standby at different times. Up to seven different schedules can be programmed.

To program the schedule:

1. Enter the SCHEDULE menu. Highlight SCHEDULE SETTINGS using the up and down buttons. Press the SET/POINT ZOOM or the + button to enter the Settings menu. Highlight the desired schedule number and press SET/POINT ZOOM. The box next to the number will turn yellow. The schedule can now be programmed.
2. Use the down button to highlight the POWER. Use the + and - buttons to set ON. To set power off schedule, set OFF.
3. Use the down button to highlight the TIME. Use the + and - buttons to set the time.
4. Use the up and down arrows to highlight INPUT. Use the + and - buttons to choose the input source. Use the up and down arrows to highlight PIC. MODE. Use the + and - buttons to choose the picture mode.
5. Use the down button to select DATE, EVERY DAY, EVERY WEEK, WEEKDAY, WEEKEND or HOLIDAY. Push the SET/POINT ZOOM button on a menu which is suitable for the schedule. If the schedule is to be run a specific day, choose DATE and press the SET/POINT ZOOM button. If the schedule is to be ran every day, choose EVERY DAY and press the SET/POINT ZOOM button. The circle next to EVERY DAY will turn yellow. If a weekly schedule is desired, choose the days of the week using the up and down buttons and pressing SET/POINT ZOOM to select. Then highlight the EVERY WEEK option and press SET/POINT ZOOM. Please set WEEKDAY, WEEKEND, or HOLIDAY in the same manner. For the WEEKDAY, WEEKEND, and HOLIDAY settings are available under the SCHEDULE setting (See page 30).
6. After a schedule is programmed, the remaining schedules can then be set. Press MENU to leave the OSD or press EXIT to go back to the previous menu.

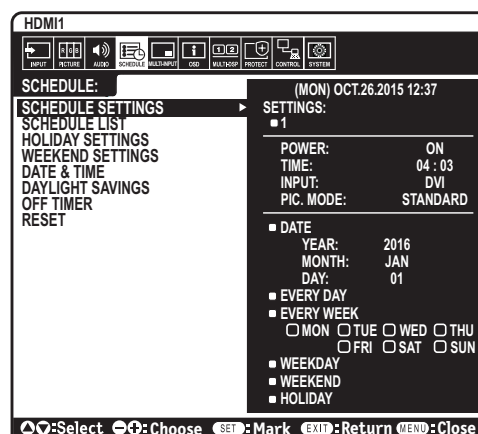

**NOTE:** If schedules are overlapping then the schedule with the highest number will have priority over the schedule with the lowest number. For example, schedule #7 will have priority over schedule #1.

If a selected input or picture mode is not available now, the disabled input or picture mode is shown in red.

## NOTE 2: IMAGE PERSISTENCE

Please be aware that LCD Technology may experience a phenomenon known as Image Persistence. Image Persistence occurs when a residual or "ghost" image of a previous image remains visible on the screen. Unlike CRT monitors, LCD monitors' image persistence is not permanent, but constant images being displayed for a long period of time should be avoided.

To alleviate image persistence, turn off the monitor's main power or set it to standby for as long as the previous image was displayed. For example, if an image was on the monitor for one hour and a residual image remains, the monitor's main power should be turned off or set it to standby for one hour to erase the image.

As with all personal display devices, NEC DISPLAY SOLUTIONS recommends displaying moving images and using a moving screen saver at regular intervals whenever the screen is idle, or turn off the monitor's main power or set it to standby when not in use.

Please set "SCREEN SAVER", "DATE & TIME" and "SCHEDULE SETTINGS" functions to further reduce the risk of Image persistence.

## For long life use as a Public Display

### Image Sticking of LCD Panel

When an LCD panel is operated continuously for long hours, a trace of electric charge remains near the electrode inside the LCD, and a residual or "ghost" image of the previous image may be observed. (Image Persistence)

Image Persistence is not permanent, but when a fixed image is displayed for a long period, ionic impurities inside the LCD are accumulated along the displayed image, and may be permanent. (Image Sticking)

### Recommendations

To prevent Image Sticking, and for longer life usage of the monitor, the following is recommended.

- A fixed image should not be displayed for long periods.
- When not in use, please turn off the monitor via remote control, or use the Power Management function of the PC, or use the built-in Schedule Functions.
- Lower environmental temperatures prolong the lifespan of the monitor. When a protective surface (glass, acrylic) is installed over the monitor's screen surface, the monitor's screen surface is located in an enclosure, or if the monitors are stacked, utilize the temperature sensors inside the monitor. To reduce the internal temperature, use the Screen Saver, the Power Management function of the PC and Low Brightness.
- Please use "Screen Saver Mode" of monitor.

# Remote Control Functions

## REMOTE CONTROL ID FUNCTION

### REMOTE CONTROL ID

The remote control can be used to control up to 100 individual monitors using what is called the REMOTE CONTROL ID mode. The REMOTE CONTROL ID mode works in conjunction with the Monitor ID, allowing control of up to 100 individual monitors. For example, if there are many monitors being used in the same area, a remote control in normal mode would send signals to every monitor at the same time (see Figure 1). Using the remote in REMOTE CONTROL ID mode will only operate one specific monitor within the group (see Figure 2).

### TO SET REMOTE CONTROL ID

While holding down the REMOTE ID SET button on the remote control, use the KEYPAD to input the Monitor ID (1-100) of the monitor to be controlled via remote. The remote can then be used to operate the monitor having that specific Monitor ID number.

When 0 is selected or when the remote control is in normal mode, all monitors will be operated.

### TO SET/RESET REMOTE CONTROL MODE

ID Mode - To enter ID Mode press the REMOTE ID SET button and hold down for 2 seconds.

Normal Mode - To return to Normal Mode press the REMOTE ID CLEAR button and hold down for 2 seconds.

In order for this feature to work properly, the monitor must be assigned a unique Monitor ID number. The Monitor ID number can be assigned under the MULTI DISPLAY menu in the OSD (See page 33).

Point the remote control towards the remote sensor of the desired monitor and press the REMOTE ID SET button. The MONITOR ID number is shown on the screen when your remote control is in ID mode.

### Use the remote to control all monitors in range

1. On the remote control, press and hold down the REMOTE ID SET button while using the keypad to input the REMOTE CONTROL ID number "0".
2. All monitors within range of remote control will now respond to keypad press.

**NOTE:** When the REMOTE ID is set to "0", pressing REMOTE ID SET will make all monitors, within range of the remote signal, display their Monitor ID on screen. This way you can easily see what the monitor ID is if you want to control a single monitor, as described below.

### Use the remote control to operate a monitor that has a specific MONITOR ID number assigned to it

1. Set the MONITOR ID number for the monitor (See page 33). The MONITOR ID number can range from 1-100. This MONITOR ID number allows the remote control to operate this specific monitor without affecting other monitors.
2. On the remote control, press and hold down the REMOTE ID SET button while using the keypad to input the REMOTE CONTROL ID number (1-100). The REMOTE ID NUMBER should match the MONITOR ID number of the monitor to be controlled.
3. Point the remote control towards the remote sensor of the desired monitor and press the REMOTE ID SET button. The MONITOR ID number is shown in red on the monitor.

If the REMOTE CONTROL ID is "0", then all monitors in range will show their respective MONITOR ID number in red.

If the MONITOR ID number is shown in white on the monitor, the MONITOR ID number and the REMOTE CONTROL ID are not the same.

**NOTE:** The GROUP ID cannot be specified via the remote control.

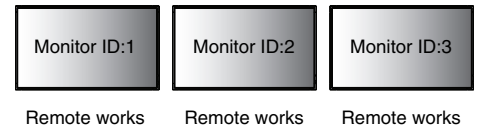

**Figure 1**  
Remote in Normal mode or the REMOTE ID is set to 0

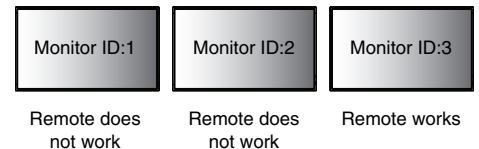

**Figure 2**  
Remote set up to use REMOTE ID:3

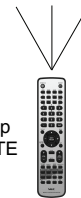



### WIRED REMOTE CONTROL FUNCTION

You can control multiple monitors by connecting REMOTE IN/OUT with Stereo Mini plug cable (Ø 3.5 mm) [Not supplied].

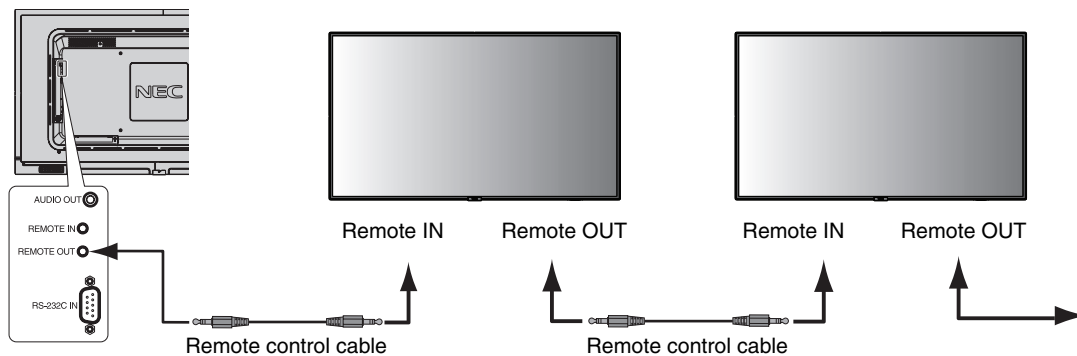

**NOTE:** Turn off the main power switch before connect/disconnect Stereo Mini plug cable.

**NOTE:** Do not use this connector for any other purpose.

# Controlling the LCD monitor via RS-232C Remote Control

This LCD monitor can be controlled by connecting a personal computer with an RS-232C (reverse type) terminal.

Functions that can be controlled by a personal computer are:

- Power ON or standby.
- Switching between input signals.
- Sound Mute ON or OFF.

## Connection

LCD Monitor + computer.

- Please turn off the monitor's main power when connecting a computer to the monitor.
- Please turn on the connecting computer first then turn on the monitor's main power.  
If you turn on the computer and monitor in reverse order, the com port may not work.
- When controlling the monitor connected with an RS-232C cable, please refer to the Control command diagram (See page 48) or see the "External\_Control.pdf" file on the CD-ROM supplied with the monitor.

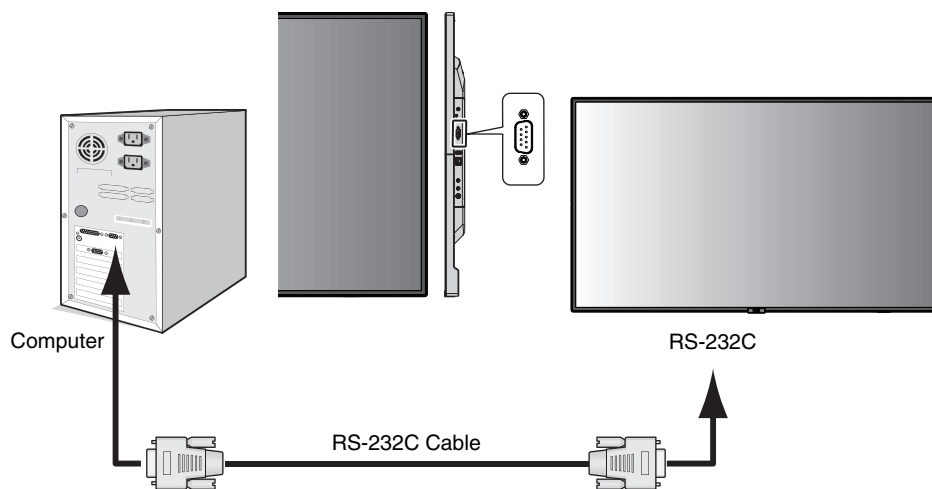

**NOTE:** If your computer is equipped only with a 25-pin serial port connector, a 25-pin serial port adapter is required. Contact your supplier for details.  
For the pin assignment, please see "2) RS-232C input/output" on the next page.

To control a monitor, please use the control command. Instructions for the control command can be found on the CD included with the monitor. The file is called "External\_control.pdf".

1) Interface

PROTOCOL	RS-232C
BAUD RATE	9600 [bps]
DATA LENGTH	8 [bits]
PARITY	NONE
STOP BIT	1 [bit]
FLOW CONTROL	NONE

This LCD monitor uses RXD, TXD and GND lines for RS-232C control.  
 The reverse type cable (null modem cable) (not included) should be used for RS-232C control.

2) PIN ASSIGNMENT

RS-232C input/output

Pin No	Name
1	NC
2	RXD
3	TXD
4	NC
5	GND
6	NC
7	NC
8	NC
9	NC

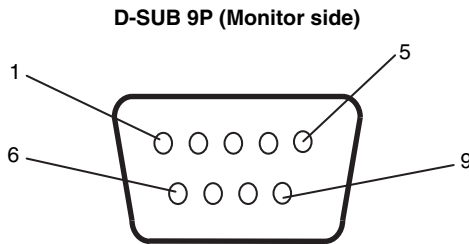

This LCD monitor uses RXD, TXD and GND lines for RS-232C control.

# Controlling the LCD monitor via LAN Control

## Connecting to a Network

Using a LAN cable allows you to specify the Network Settings and the Alert Mail Settings by using an HTTP server function.

To use a LAN connection, you are required to assign an IP address.

### Example of LAN connection:

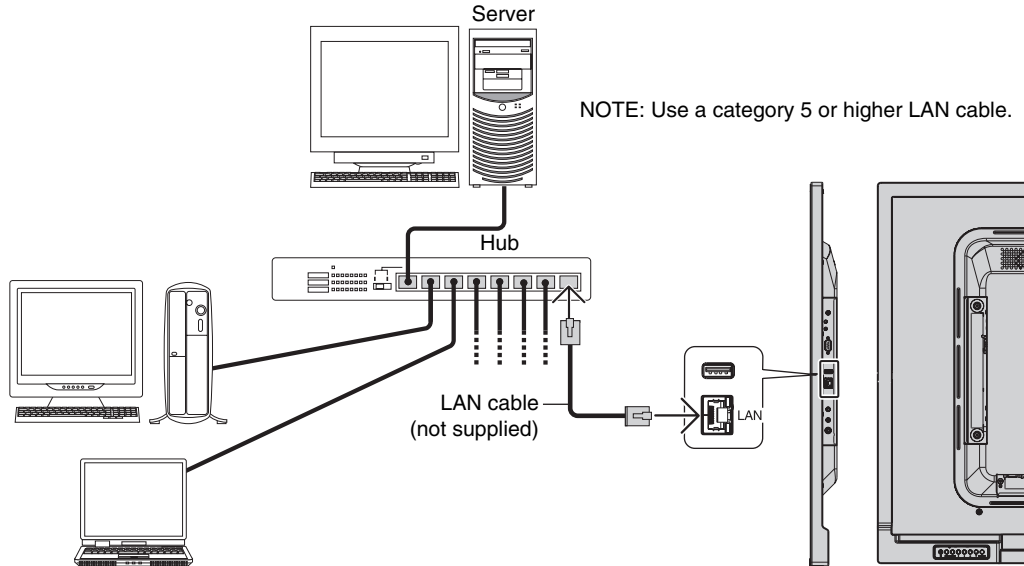

## Network Setting by Using an HTTP Browser

### Overview

Connecting the monitor to a network allows for monitor control from a computer via the network.

The IP address and subnet mask of the monitor can be set on the Network Setting screen of the web browser by using an HTTP server. Please be sure to use "Microsoft Internet Explorer 10" or a higher version for the web browser.

(This device uses "JavaScript" and "Cookies" and the browser should be set to accept these functions. The setting method will vary depending on the version of the browser. Please refer to the help files and the other information provided in your software.)

Access is gained to the HTTP server function by starting the Web browser on the computer via the network connected to the monitor and entering the following URL as described below:

### Network Setting

`http://<the Monitor's IP address>/index.html`

**HINT:** The default IP address is assigned automatically to the monitor.  
The exclusive application can be downloaded from our website.

**NOTE:** If the MONITOR NETWORK SETTINGS screen does not appear in the web browser, press the Ctrl+F5 keys to refresh your web browser (or clear the cache).

If the monitor appears to be slow in response to commands or clicks on buttons in the browser, or the general speed of operation is unacceptable, this may be due to network traffic or the settings on your network. Should this happen, consult your network administrator.

The monitor may not respond if the buttons shown on the browser are repeatedly pressed in rapid intervals. Should this happen, wait a moment and repeat. If you still can't get a response, turn the monitor off and then back on.

To control a monitor please use the control command. See "Control command diagram" (page 48).

## Preparation Before Use

Connect the monitor to the network, using a commercially available LAN cable, before attempting to use browser operations.

Operation with a browser that uses a proxy server may not be possible depending on the type of proxy server and the setting method. Although the type of proxy server will be a factor, it is possible that items that have been set will not be shown, depending on the effectiveness of the cache, and the contents set from the browser may not be reflected in operation. It is recommended that a proxy server is not used unless the network environment requires it.

## Handling of the Address for Operation via a Browser

A host name can be used in the following cases (corresponding to the IP address of the monitor):

The host name must be registered in the domain name server (DNS) by the network administrator. You can then access the network settings of the monitor via this registered host name by using a compatible browser.

If the host name has been configured in the "HOSTS" file of the computer being used, you can then access the network settings of the monitor via this host name by using a compatible browser.

**Example 1:** When the host name of the monitor has been set to "pd.nec.co.jp", access is gained to the network setting by specifying *http://pd.nec.co.jp/index.html* for the address or the entry column of the URL.

**Example 2:** When the IP address of the monitor is "192.168.73.1", access is gained to the mail alert settings by specifying *http://192.168.73.1/index.html* for the address or the entry column of the URL.

## Operation

Access the following address to show HOME.

*http://<the Monitor's IP address>/index.html*

Click each link on the left column below HOME.

## REMOTE CONTROL

Enable an operation to control the monitor equivalent to the keys on the remote control.

## OSD menu

Enable the operation to set the following OSD menu:

INPUT, PICTURE, AUDIO, SCHEDULE, MULTI INPUT, OSD, MULTI DISPLAY, DISPLAY PROTECTION, CONTROL, SYSTEM.

**NOTE:** Function of buttons which are shown on setting pages.

[APPLY]: Save your settings.

[CANCEL]: Return to the previous settings. **NOTE:** CANCEL is disabled after clicking APPLY.

[RELOAD]: Reload the settings.

[RESET]: Resets to the initial setting.

# Network Setting

Click on "NETWORK" on the left column below HOME.

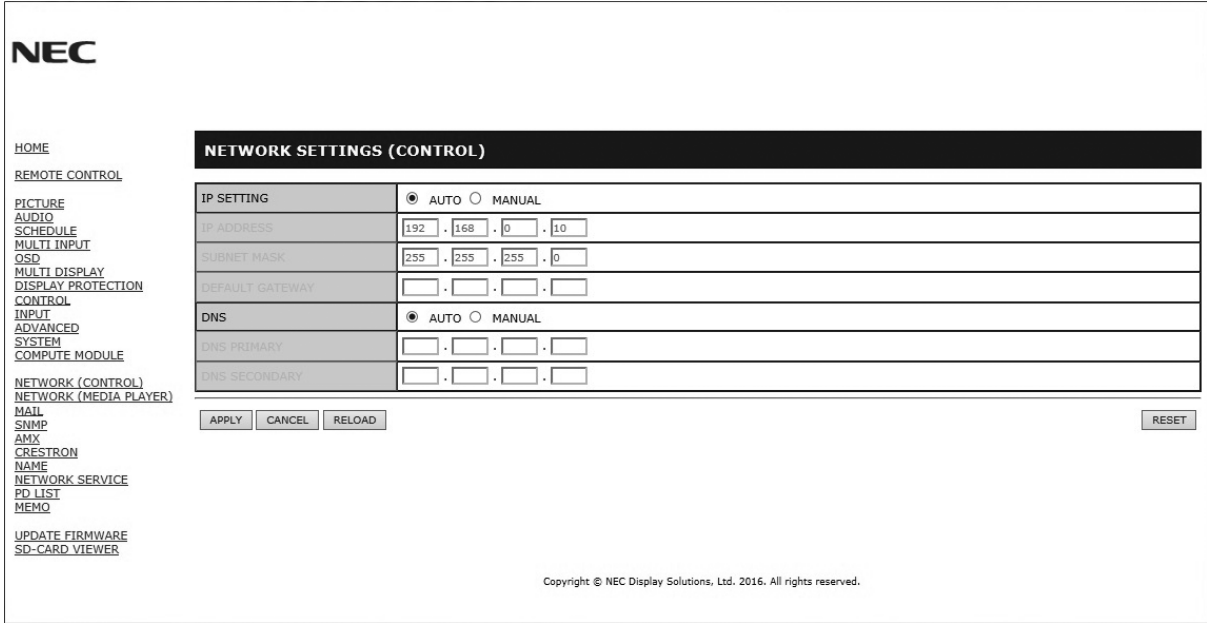

IP SETTING	Select an option for setting the IP ADDRESS. AUTO: Automatically assign an IP address. MANUAL: Manually set an IP address for the monitor connected to the network. NOTE: Consult your network administrator if you have any trouble.
IP ADDRESS	Set your IP address for the monitor connected to the network when [MANUAL] is selected for [IP SETTING].
SUBNET MASK	Set your subnet mask data for the monitor connected to the network when [MANUAL] is selected for [IP SETTING].
DEFAULT GATEWAY	Set your default gateway for the monitor connected to the network when [MANUAL] is selected for [IP SETTING]. NOTE: Set as [0.0.0.0] to delete the setting.
DNS	Set for IP ADDRESS setting of DNS server. AUTO: The DNS server connected to the monitor will automatically assign its IP address. MANUAL: Manually enter the IP address of the DNS server that is connected with the monitor.
PRIMARY DNS	Enter the primary DNS server settings of the network connected with the monitor. NOTE: Enter [0.0.0.0] to delete the setting.
SECONDARY DNS	Enter the secondary DNS server settings of the network connected with the monitor. NOTE: Enter [0.0.0.0] to delete the setting.

**NOTE:** The following settings will be set back to the factory settings when IP ADDRESS RESET is selected at CONTROL of the OSD:  
 [IP SETTING]: AUTO, [IP ADDRESS]: 192.168.0.10, [SUBNET MASK]: 255.255.255.0, [DNS]: AUTO [DEFAULT GATEWAY], [PRIMARY DNS] and [SECONDARY DNS] are blank.

## Mail Setting

Click on "MAIL" on the left column below HOME.

This option notifies your computer about an error message via e-mail when using wired LAN. An error message will be sent when an error occurs in the monitor.

ALERT MAIL	Selecting [ENABLE] will turn on the Alert Mail feature. Selecting [DISABLE] will turn off the Alert Mail feature.
STATUS MESSAGE	Selecting [ENABLE] will turn on the STATUS MESSAGE feature. Selecting [DISABLE] will turn off the STATUS MESSAGE feature.
SENDER'S ADDRESS	Type in the sender's address. Up to 60 alphanumeric and symbols characters can be used.
SMTP SERVER	Type in the SMTP server name to be connected with the monitor. Up to 60 alphanumeric characters can be used.
RECIPIENT'S ADDRESS 1 TO 3	Type in your recipient's address. Up to 60 alphanumeric and symbols characters can be used.
AUTHENTICATION METHOD	This selects the authentication method of the email transmission.
POP3 SERVER	This specifies the address of the POP3 server that is used in the authentication of the email.
USER NAME	This sets the user name for logging into the authentication server when authentication is required for the email transmission. Up to 60 alphanumeric characters can be used.
PASSWORD	This sets the password for logging into the authentication server when authentication is required for the email transmission. Up to 60 alphanumeric characters can be used.
TEST MAIL	Click this button to send a test email to check if your settings are correct.

- NOTE:**
- If you execute a test, you may not receive an Alert email.  
Should this happen, check whether the network settings are correct.
  - If you entered an incorrect address in a test, you may not receive an Alert email.  
Should this happen, check that the Recipient's Address is correct.

**HINT:** For the control command diagram, please see the file "External\_Control.pdf" on the CD-ROM supplied with this monitor.

### Alert error message list

Error number * ErrorCode	Alert mail Message	Explanation	Measure
70h ~ 7Fh	The monitor's power supply is not functioning normally.	Standby power abnormal	Please contact your supplier.
90h ~ 9Fh	The monitor's backlight unit is not functioning normally.	Backlight abnormal	Please contact your supplier.
A0h ~ AFh	The monitor is overheated.	Temperature abnormal	Please contact your supplier.
A2h		A Sensor reached the temperature limit which was specified in the OSD.	Please contact your supplier.
B0h ~ BFh	The monitor does not receive an input signal.	No signal	Please check "No picture" in "Troubleshooting".
D1h	The battery for clocks is empty.	The battery is empty.	Please connect the monitor to the power then recharge the battery. Please set (DATE & TIME) in OSD.
E0h ~ EFh	A system error occurred in the monitor.	System error.	Please contact your supplier.

## SNMP Settings

Click on “SNMP” on the left column below HOME.

The SNMP protocol is used to get status information and to control a monitor directly via the network.

### Version:

SNMP v1 Authenticated plaintext by community name, does not return a confirmation message of the trap.

SNMP v2c Authenticated plaintext by community name, returns a confirmation message of the trap.

### Community name:

The default setting of community name is “public”. It is read only. You can set community names for up to 3 settings.

### Trap:

Sending error message to a specified address when an error occurs in the monitor.

Check Box	Explanation	Error code
Temperature	Temperature abnormal	0xA0, 0xA1, 0xA2
Power	Power abnormal	0x70, 0x71, 0x72, 0x78
Inverter/Backlight	Inverter or backlight abnormal	0x90, 0x91
No Signal	No signal	0xB0
System Error	System error	0xE0

## AMX Settings

Click on “AMX” on the left column below HOME.

AMX BEACON	<p>To turn on or off for the detection from AMX Device Discovery when connecting to a network supported by an AMX’s NetLinx control system.</p> <p><i>HINT:</i>            When using a device that supports AMX Device Discovery, all AMX NetLinx control systems will recognize the device and download the appropriate Device Discovery Module from an AMX server. Selecting [ENABLE] AMX Device Discovery will detect the device. Selecting [DISABLE] AMX Device Discovery will not detect the device.</p>
------------	--

## CRESTRON Settings

Click on “CRESTRON” on the left column below HOME.

### CRESTRON ROOMVIEW compatibility

The monitor supports CRESTRON ROOMVIEW, allowing multiple devices connected in the network to be managed and controlled from a computer or a controller.

For further information, visit <http://www.crestron.com>

ROOMVIEW	<p>ROOMVIEW for managing from the computer.</p> <p>ON: Enables ROOMVIEW.            OFF: Disables ROOMVIEW.</p>
CRESTRON CONTROL	<p>CRESTRON CONTROL for managing from the controller.</p> <p>ON: Enables CRESTRON CONTROL.            OFF: Disables CRESTRON CONTROL.</p>
CONTROLLER IP ADDRESS	Sets the IP address of the CRESTRON SERVER.
IP ID	Sets your CRESTRON SERVER IP ID.

**HINT:** The CRESTRON settings are required only for use with CRESTRON ROOMVIEW. For further information, visit <http://www.crestron.com>



## Name Settings

Click on "NAME" on the left column below HOME.

MONITOR NAME	Defines a monitor name. The name must be max. 16 characters long. The default is the model name.
HOST NAME (CONTROL)	Type in the hostname of the monitor which is connected to the network. Up to 15 alphanumeric characters can be used.
HOST NAME (MP)	Type in the hostname of the network to be used in the Media Player connected to the monitor. Up to 15 alphanumeric characters can be used.
DOMAIN NAME	Type in the domain name of the network which is connected with the monitor. Up to 60 alphanumeric characters can be used.

## Network Password Settings

Click on "NETWORK PASSWORD" on the left column below HOME.

PJLink CLASS	Set a class for PJLink*. NOTE: PJLink is a network interface standard that JBMIA established. <a href="http://pjlink.jbmia.or.jp/index.html">http://pjlink.jbmia.or.jp/index.html</a> This monitor is available for class1 and class2 command.
NOTIFY FUNCTION ENABLE	Enable or disable a notification of the monitor network condition. This function is only for class2.
NOTIFY ADDRESS	Set an IP ADDRESS to which the monitor network status will be sent. This function is only for class2.
PJLink PASSWORD	Set a password for PJLink*. The password must be max. 32 characters long. Do not forget your password. If you forget your password, consult your supplier.
HTTP PASSWORD	Set a password for the HTTP server. The password must be max. 10 characters long.
HTTP PASSWORD ENABLE	An HTTP PASSWORD is required when logging into the HTTP server. Set the monitor name as the USER NAME when entering the password.

\*What is PJLink?

PJLink is a standardization of protocol used for controlling devices of different manufacturers. This standard protocol was established by Japan Business Machine and Information System Industries Association (JBMIA) in 2005. The device supports all commands of PJLink.

## MEMO Settings

Click on "MEMO" on the left column below HOME.

Set a title and message.

TITLE	The title must be max. 24 characters long.
MESSAGE	A message must be max. 240 characters long.
MEMO PASSWORD	The default is "0000".
MEMO PASSWORD ENABLE	A MEMO PASSWORD is required when selecting MEMO PASSWORD ENABLE.

## SD-CARD VIEWER setting

Click "SD-CARD VIEWER" on the left side of HOME.

Please refer to Using SHARED SD card SETTINGS (See page 24).

## External Control

### Connecting external device

There are two ways to connect an external device to the monitor.

- RS-232C terminal.  
Connecting an external device to the RS-232C terminal of the monitor with an RS-232C cable.
- LAN port.  
Connecting an external device to the LAN port of the monitor with a LAN cable.  
For further information regarding the type of LAN cable to use, please consult your network administrator.

**Connecting interface**

RS-232C Interface

PROTOCOL	RS-232C
BAUD RATE	9600 [bps]
DATA LENGTH	8 [bits]
PARITY	NONE
STOP BIT	1 [bit]
FLOW CONTROL	NONE

LAN interface

PROTOCOL	TCP
PORT NUMBER	7142
COMMUNICATION SPEED	AUTO setting (10/100Mbps)

**Control command diagram**

For other commands, please see “External\_Control.pdf” file on the CD-ROM supplied with the monitor.

Function (Monitor ID = 1)	Code Data
Power ON	01 30 41 30 41 30 43 02 43 32 30 33 44 36 30 30 30 31 03 73 0d
Power OFF	01 30 41 30 41 30 43 02 43 32 30 33 44 36 30 30 30 34 03 76 0d
Input Source Select DisplayPort	01 30 41 30 45 30 41 02 30 30 36 30 30 30 30 46 03 04 0d or 01 30 41 30 45 30 41 02 31 31 30 36 30 30 30 46 03 04 0d
Input Source Select HDMI1	01 30 41 30 45 30 41 02 30 30 36 30 30 30 31 31 03 72 0d or 01 30 41 30 45 30 41 02 31 31 30 36 30 30 31 31 03 72 0d
Input Source Select HDMI2	01 30 41 30 45 30 41 02 30 30 36 30 30 30 31 32 03 71 0d or 01 30 41 30 45 30 41 02 31 31 30 36 30 30 31 32 03 71 0d
Input Source Select HDMI3	01 30 41 30 45 30 41 02 30 30 36 30 30 30 38 32 03 78 0d or 01 30 41 30 45 30 41 02 31 31 30 36 30 30 38 32 03 78 0d
Input Source Select VGA (RGB)	01 30 41 30 45 30 41 02 30 30 36 30 30 30 30 31 03 73 0d
Input Source Select VGA (YPbPr)	01 30 41 30 45 30 41 02 30 30 36 30 30 30 30 43 03 01 0d
Input Source Select VIDEO	01 30 41 30 45 30 41 02 30 30 36 30 30 30 30 35 03 77 0d
Input Source Select MP	01 30 41 30 45 30 41 02 30 30 36 30 30 30 38 37 03 7D 0d or 01 30 41 30 45 30 41 02 31 31 30 36 30 30 38 37 03 7D 0d
Sound Mute ON	01 30 41 30 45 30 41 02 30 30 38 44 30 30 30 31 03 09 0d
Sound Mute OFF	01 30 41 30 45 30 41 02 30 30 38 44 30 30 30 32 03 0a 0d

**ASCII Control command**

This monitor supports control command, which is listed in the “External\_Control.pdf” file on the CD-ROM supplied with the monitor, but also supports common ASCII control command, which is used for controlling the NEC monitor or projector from a connected PC. For further information please visit our website.

**Parameter**

Input command

Input signal name	Response	Parameter
DisplayPort	DisplayPort	DisplayPort or DisplayPort1
HDMI1	hdmi1	hdmi1 or hdmi
HDMI2	hdmi2	hdmi2
HDMI3	hdmi3	hdmi3
VGA	vga	vga, vga1, computer, computer1, rgb or rgb1
VIDEO	video	video or video1
MP	mp	mp

Status command

Response	Error status
error:temp	Temperature abnormal
error:light	Inverter or backlight abnormal
error:system	System error

## Supporting HDMI CEC command

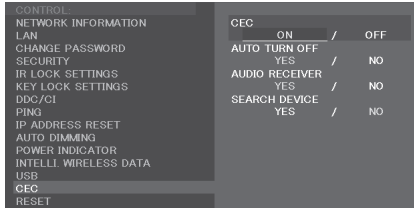
OSD menu	HDMI CEC command name	Explanation	Setting
CEC (Consumer Electronics Control)	One Touch Play	If HDMI CEC supporting devices are turned on, the monitor connected to the devices by HDMI cable is also turned on automatically. After that, the input switches to HDMI from an input, which you selected. If the monitor is turned on when HDMI CEC devices are turned on, it changes the input from the original one to HDMI.	 <p>To set CEC menus please follow the steps below.</p> <p>By using ▲▼ buttons select CONTROL &gt; CEC then press SET/POINT ZOOM button on the CEC. By using + - buttons select ON then press SET/POINT ZOOM button on the ON.</p>
	Remote Control Pass Through	The monitor's wireless remote control button operation is functioning to HDMI CEC supporting devices. For example, if turning on the monitor by wireless remote control and pressing the play button, HDMI CEC supporting devices will also be turned on and play.	
	Power Status	Connected HDMI CEC supporting devices obtains the monitor's power status, such as the monitor is in standby mode or on.	
	System Information	This function obtains the information of a connected HDMI CEC supported device (CEC version, Physical Address). In addition, this function copes with "Change Language function". If the language for the monitor is changed, the language for a connected HDMI CEC supported device is changed to the same language, which is selected for the monitor. For the "Change Language function", it is necessary that the connected HDMI CEC supported device be able to cope with multi-language.	
AUTO TURN OFF	System Standby	If the monitor is set to standby using the wireless remote control supplied with the monitor, HDMI CEC supported devices also go into standby at the same time. If the monitor goes into standby while an HDMI CEC supported device is recording, the device is kept on. Please refer to the user's manual supplied with the HDMI CEC supported device for further information.	<p>By using ▲▼ buttons select AUTO TURN OFF then press SET/POINT ZOOM.</p> <p>By using + - buttons select YES then press SET/POINT ZOOM button on the YES.</p>
AUDIO RECEIVER	System Audio Control	The function sends digital audio signal through the HDMI cable. Please set an HDMI CEC audio amplifier between the monitor and an HDMI CEC supported device with an HDMI cable. The Volume button on the wireless remote control supplied with the monitor is also controlling the volume of the connected HDMI CEC audio amplifier. While this function is active, the internal speaker is set to MUTE automatically.	<p>By using ▲▼ buttons select AUDIO RECIEVER then press SET/POINT ZOOM.</p> <p>By using + - buttons select YES then press SET/POINT ZOOM button on the YES.</p>
SEARCH DEVICE	Device OSD Name Transfer	This function obtains the connected HDMI CEC supported device's name.	By using ▲▼ buttons select SEARCH DEVICE then press SET/POINT ZOOM.
	Routing Control	By selecting a device name, the HDMI CEC supported device input switches to the input you selected. After selecting the device, wireless remote control operation is functioning for the selected device.	By using + - buttons select YES then press SET/POINT ZOOM button on the YES.

This CEC function supports Feature Abort. We recommend that connecting this monitor to a device supporting HDMI CEC. Please refer to Connections (See page 15) for HDMI CEC devices connection.

# POINT ZOOM

---

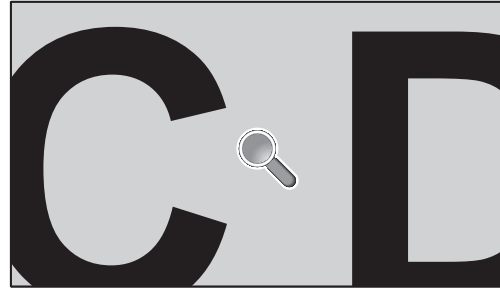
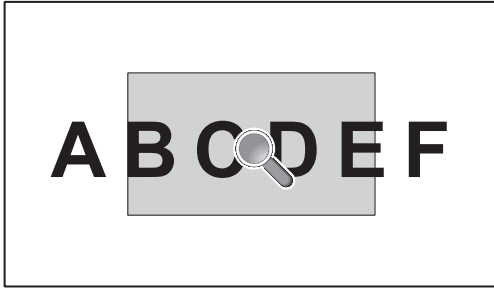

Using the “SET/POINT ZOOM” button on the remote control enlarges part of the screen image. Press the CH+/- button to zoom in or out. The image can be expanded up to 10 times.

- 1 Press the [SET/POINT ZOOM] button on the remote control. The icon looks like a magnifier.
- 2 Move the magnifier icon with the [▲] [▼] [+] [-] buttons.
- 3 Press the [CH+] to zoom in. Press [CH-] to zoom out.
- 4 Press the [SET/POINT ZOOM] to let the icon disappear.
- 5 Press the [EXIT] to return to the normal image size.
- 6 Press the [MENU] to open the OSD menu.

- NOTE:**
- When using this function the image may look distorted.
  - This function is not available when set to SCREEN SAVER, CLOSED CAPTION and TILE MATRIX.
  - When ZOOM is selected in ASPECT, the image will change to FULL. Then start with POINT ZOOM. After exiting POINT ZOOM, ASPECT will return to the previous ASPECT settings. When ASPECT is changed during the POINT ZOOM operation, ZOOM will be set to FULL image.
  - The magnifier icon does not move to a no image area.
  - POINT ZOOM returns to the normal image size after changing the input signal or when the monitor is powered off.
  - POINT ZOOM will become inactive when changing the ASPECT setting during the POINT ZOOM operation.
  - When the POINT ZOOM is active, the STILL function is not available.

# Features

---

**OmniColor:** Combines Six-axis color control and the sRGB standard. Six-axis color control permits color adjustments via six axes (R, G, B, C, M and Y) rather than through the three axes (R, G and B) previously available. The sRGB standard provides the monitor with a uniform color profile. This ensures that the colors displayed on the monitor are exactly the same as on the color printout (with sRGB supporting operating system and sRGB printer). This allows you to adjust the colors on your screen and customise the color accuracy of your monitor to a variety of standards.

**sRGB Color Control:** A color management standard which allows for color matching on computer monitors and other peripherals. The sRGB standard, which is based on a calibrated color space, allows for optimal color representation and backward compatibility with other common color standards.

**OSD (On-Screen-Display) Controls:** Allows you to quickly and easily adjust all elements of your screen image via easy to use on-screen menus.

**Plug and Play:** The Microsoft® solution with the Windows® operating system facilitates setup and installation by allowing the monitor to send its capabilities (such as screen size and resolutions supported) directly to your computer, automatically optimizing display performance.

**IPM (Intelligent Power Manager) System:** Provides innovative power-saving methods that allow the monitor to shift to a lower power consumption level when on but not in use, saving two-thirds of your monitor energy costs, reducing emissions and lowering the air conditioning costs of the workplace.

**FullScan Capability:** Allows you to use the entire screen area in most resolutions, significantly expanding image size.

**VESA Standard (FDMLv1) Mounting Interface:** Allows you to mount the monitor to any VESA standard (FDMLv1) third party mounting arm or bracket. NEC recommends using mounting equipment which complies with TÜV-GS (Germany) and/or UL1678 standard (North America).

**ZOOM:** Expands/reduces the image size in horizontal and vertical direction.

**Self-diagnosis:** If an internal error should occur, a failure state will be indicated.

**HDCP (High-bandwidth Digital Content Protection):** HDCP is a system for preventing illegal copying of video data sent over a digital signal. If you are unable to view material via the digital input, this does not necessarily mean that the monitor is not functioning properly. With the implementation of HDCP, there may be cases in which certain content is protected by HDCP and might not be displayed due to the decision/intention of the HDCP community (Digital Content Protection, LLC).

**TILE MATRIX, TILE COMP:** Shows one image over multiple screens with accuracy while compensating for bezel width.

# Troubleshooting

---

## No picture

- The signal cable should be completely connected to the display card/computer.
- The display card should be completely seated in its slot.
- Check the main Power Switch, it should be in the ON position.
- Power Switches for the monitor and computer should be in the ON position.
- Make sure that a supported resolution has been selected on the display card or system being used. If in doubt, please refer to the user's manual of the display controller or system to change the resolution.
- Check the monitor and your display card with respect to compatibility and recommended signal timings.
- Check the signal cable connector for bent or pushed-in pins.
- The monitor automatically goes into standby at the preset time period after the video signal was lost. Press the power on button on the remote control or press the power button on the monitor.
- If you unplug the signal cable when starting the computer, images may not be displayed. Turn off the monitor and the computer and then connect the signal cable and turn on the computer and the monitor.

## Power Button does not respond

- Unplug the power cord of the monitor from the AC outlet to turn off and reset the monitor.
- Check the main Power Switch on the monitor.

## Image persistence

- Please be aware that LCD Technology may experience a phenomenon known as Image Persistence. Image Persistence occurs when a residual or "ghost" image of a previous image remains visible on the screen. Unlike CRT monitors, the image persistence of LCD monitors is not permanent, but single still image being displayed for a long period of time should be avoided. To alleviate image persistence, put the monitor into standby via remote control or turn the monitor's main power off for as long as the previous image was displayed. For example, if an image was on the monitor for one hour and a residual image remains, the monitor should be in standby or main power off for one hour to erase the image.

**NOTE:** As with all personal display devices, NEC DISPLAY SOLUTIONS recommends displaying moving images, using a moving screen saver, or changing still images at regular intervals whenever the screen is idle, or turning it into standby or main power off of the monitor when not in use.

## The image is blinking

- If you use a signal repeater or distributor or a long cable, this may cause image roughness or blink for a moment. In this case please connect the cable to the monitor directly without using a repeater or a distributor, or replace the cable with a higher quality cable. Using a twisted pair extender may cause image roughness depending on the environment where the monitor is in or the cable you are using. For further information please ask your supplier.

## The image is unstable, unfocused or swimming is apparent

- The signal cable should be completely attached to the computer.
- Use the OSD Image Adjust controls to focus and adjust the display by increasing or decreasing the fine adjustment. When the display mode is changed, the OSD Image Adjust settings may need to be re-adjusted.
- Check the monitor and your display card with respect to compatibility and recommended signal timings.
- If text looks garbled, change the video mode to non-interlaced and use a 60 Hz refresh rate.
- The image may be distorted when turning the power on or changing the settings.

## The image of component signal is greenish

- Check to see if the VGA (YPbPr) input connector is selected.

## LED on the monitor is not lit (no blue or red color can be seen)

- The power Switch should be in the ON position and the power cord should be connected.
- Check the main Power Switch, it should be in the ON position.
- Make certain the computer is not in a power-saving mode (touch the keyboard or move the mouse).
- Check in the OSD that the power indicator option is set to ON.

## LED colors, except for blue, are blinking or glowing

- A certain failure might have occurred, please contact your supplier.
- If the monitor is powered off by the internal temperature being higher than the normal operating temperature, the LED will blink green or amber or red for six times. Power on the monitor again after confirming the internal temperature has been reduced to normal operation temperature.
- The monitor could be in standby. Press the power on button on the remote control or press the power button on the monitor.

## The image is not properly reproduced

- Use the OSD Image Adjust controls to increase or decrease the coarse adjustment.
- Make sure that a supported resolution has been selected on the display card or system being used. If in doubt, please refer to the user's manual of the display card or system to change the resolution.

## Selected resolution is not displayed properly

- Use OSD Display Mode to enter Information menu and confirm that the appropriate resolution has been selected.

**No Sound**

- Check to see if the audio cable is properly connected.
- Check to see if MUTE is activated. Use the remote control to enable or disable the Mute function.
- Check to see if VOLUME is set to a minimum.
- Check to see if the computer supports an audio signal through DisplayPort.  
If unsure, contact your supplier.
- When LINE OUT is not functioning, check to see if SURROUND is ON.
- If HDMI CEC audio device is not connected, please set "AUDIO RECEIVER" to OFF.

**The Remote Control is not functioning**

- Check the batteries status of the Remote Control.
- Check if the batteries are inserted correctly.
- Check if the Remote Control is pointing at the remote control sensor of the monitor.
- Check the status of IR LOCK SETTINGS.
- The remote control system may not function when direct sunlight or strong illumination strikes the remote control sensor of the monitor, or when there is an object in the path.

**The SCHEDULE/OFF TIMER function is not working properly**

- The "SCHEDULE" function will be disabled when the "OFF TIMER" is set.
- If the "OFF TIMER" function is enabled and the power to the LCD monitor is turned off when the power supply is interrupted unexpectedly, then the "OFF TIMER" will be reset.

**Interference in TV**

- Check components for shielding, move away from monitor if necessary.

**RS-232C or LAN control is not available**

- Check RS-232C (reverse type) or the LAN cable. A category 5 or higher LAN cable is required for connection.

**The monitor goes into standby automatically**

- Please check "OFF TIMER" setting.
- Set the "CEC" function to OFF.

**Media Player function does not recognize the USB storage device**

- Please check a USB storage device is connected to the USB (2A).

**USB Hub does not operate**

- Check to make sure the USB cord is properly connected. Refer to your USB device User's Manual.
- Check the format if this device cannot recognize the connected USB memory.

**MicroSD card does not work**

- Check to make sure the microSD card is properly connected.
- Check the microSD memory card format.

Either light vertical or horizontal stripes may appear, depending on the specific image pattern. This is not a product fault or degradation.

# Specifications - C431

## Product Specifications

LCD Module		Pixel Pitch:	43"/107.95 cm diagonal
		Resolution:	0.49 mm
		Color:	1920 x 1080
		Brightness:	Over 1073 million colors (depending on display card used)
		Contrast Ratio:	400 cd/m <sup>2</sup> (Max.) @25°C
		Viewing Angle:	4000:1
			89° (typ) @ CR>10
Frequency		Horizontal:	15.625/15.734 kHz, 31.5 kHz - 91.1 kHz
		Vertical:	50.0 - 85.0 Hz (Analog Input)
			24.0 - 85.0 Hz (Digital Input)
Pixel Clock		Analog:	13.5 MHz, 25.0 MHz - 165.0 MHz
		Digital:	25.0 MHz - 165.0 MHz
Viewable Size		940.90 x 529.25 mm	
Input Signal			
DisplayPort	DisplayPort Connector	Digital RGB	The DisplayPort input complies with Standard V1.1a, applicable to HDCP SVGA60, XGA60, WXGA60, SXGA60, UXGA60, WUXGA60*1, 1920x1080 (60 Hz), 1080p, 1080i, 720p@50Hz/60Hz
VGA (RGB)*2	15pin Mini D-sub	Analog RGB	0.7 Vp-p/75 ohm VGA60, SVGA60, XGA60, WXGA60, SXGA60, UXGA60*1, WUXGA60*1, 1920X1080 (60Hz)
		Sync	Separate: TTL level (Pos./Neg.) Composite sync on Green Video: 0.3 Vp-p Neg.
HDMI	HDMI Connector	Digital YUV Digital RGB	HDMI SVGA60, XGA60, WXGA60, SXGA60, UXGA60, WUXGA60*1, 1920x1080 (60 Hz), 1080p, 1080i, 720p@50Hz/60Hz
VGA (YPbPr)*2	15pin Mini D-sub	Component	Y: 1.0 Vp-p/75ohm, Cb/Cr (Pb/Pr): 0.7 Vp-p/75 ohm HDTV/DVD: 1080p, 1080i, 720p@50Hz/60Hz, 576p@50Hz, 480p@60Hz, 576i@50Hz, 480i@60Hz
VIDEO*2	RCA port	Composite	1.0 Vp-p/75 ohm NTSC/PAL/SECAM/4.43NTSC/PAL60
AUDIO			
AUDIO Input	Stereo Mini Jack	Analog Audio	Stereo L/R 0.5 Vrms x 2
	HDMI Connector	Digital Audio	PCM 32, 44.1, 48 KHz (16/20/24bit)
	DisplayPort Connector	Digital Audio	PCM 32, 44.1, 48 KHz (16/20/24bit)
AUDIO Output	Stereo Mini Jack	Analog Audio	Stereo L/R 0.5 Vrms
Speaker Output		Internal Speaker 10 W + 10 W (Stereo)	
Control		RS-232C In:	9 Pin D-sub
		LAN:	RJ-45 10 BASE-T/100 BASE-TX x1
		Remote IN:	Stereo Mini Jack 3.5 mm Ø
		Remote OUT:	Stereo Mini Jack 3.5 mm Ø
SD card Slot		Port: microSD card. Up to 32GB microSDHC is supported.	
USB Port		USB (2A):	Media Player/Firmware update/Power supply port 5V/2A (max.)
Power Supply		1.35 - 0.55 A @ 100-240V AC, 50/60Hz	
Power Consumption		Normal operation:	Approx. 50 W
Operational Environment		Temperature:	0 - 40°C / 32 - 104°F
		Humidity:	20 - 80% (without condensation)
		Altitude:	0 - 3000 m (Brightness may decrease with altitude)
Storage Environment		Temperature:	-20 - 60°C / -4 - 140°F
		Humidity:	10 - 90% (without condensation) / 90% - 3.5% x (Temp - 40°C) regarding over 40°C
Dimension		970.7 (W) x 558.9 (H) x 45.0 (D) mm/38.2 (W) x 22.0 (H) x 1.8 (D) inches (w/o Deco Dimension)	
Weight		12.5 kg (27.6 lbs)	
VESA compatible mounting interface		300 mm x 300 mm (M6, 4 Holes)	
Power Management		VESA DPM	

**NOTE:** Technical specifications are subject to change without notice.

\*1: Compressed image.

\*2: Common terminal.



# Specifications - C501

## Product Specifications

LCD Module		Pixel Pitch: 0.57 mm Resolution: 1920 x 1080 Color: Over 1073 million colors (depending on display card used) Brightness: 400 cd/m <sup>2</sup> (Max.) @25°C Contrast Ratio: 4000:1 Viewing Angle: 89° (typ) @ CR>10	50"/125.73 cm diagonal
Frequency		Horizontal: 15.625/15.734 kHz, 31.5 kHz - 91.1 kHz Vertical: 50.0 - 85.0 Hz (Analog Input) 24.0 - 85.0 Hz (Digital Input)	
Pixel Clock		Analog: 13.5 MHz, 25.0 MHz - 165.0 MHz Digital: 25.0 MHz - 165.0 MHz	
Viewable Size		1095.84 x 616.41 mm	
Input Signal			
DisplayPort	DisplayPort Connector	Digital RGB	The DisplayPort input complies with Standard V1.1a, applicable to HDCP SVGA60, XGA60, WXGA60, SXGA60, UXGA60, WUXGA60* <sup>1</sup> , 1920x1080 (60 Hz), 1080p, 1080i, 720p@50Hz/60Hz
VGA (RGB)* <sup>2</sup>	15pin Mini D-sub	Analog RGB	0.7 Vp-p/75 ohm VGA60, SVGA60, XGA60, WXGA60, SXGA60, UXGA60* <sup>1</sup> , WUXGA60* <sup>1</sup> , 1920X1080 (60Hz)
		Sync	Separate: TTL level (Pos./Neg.) Composite sync on Green Video: 0.3 Vp-p Neg.
HDMI	HDMI Connector	Digital YUV Digital RGB	HDMI SVGA60, XGA60, WXGA60, SXGA60, UXGA60, WUXGA60* <sup>1</sup> , 1920x1080 (60 Hz), 1080p, 1080i, 720p@50Hz/60Hz
VGA (YPbPr)* <sup>2</sup>	15pin Mini D-sub	Component	Y: 1.0 Vp-p/75ohm, Cb/Cr (Pb/Pr): 0.7 Vp-p/75 ohm HDTV/DVD: 1080p, 1080i, 720p@50Hz/60Hz, 576p@50Hz, 480p@60Hz, 576i@50Hz, 480i@60Hz
VIDEO* <sup>2</sup>	RCA port	Composite	1.0 Vp-p/75 ohm NTSC/PAL/SECAM/4.43NTSC/PAL60
AUDIO			
AUDIO Input	Stereo Mini Jack	Analog Audio	Stereo L/R 0.5 Vrms x 2
	HDMI Connector	Digital Audio	PCM 32, 44.1, 48 KHz (16/20/24bit)
	DisplayPort Connector	Digital Audio	PCM 32, 44.1, 48 KHz (16/20/24bit)
AUDIO Output	Stereo Mini Jack	Analog Audio	Stereo L/R 0.5 Vrms
Speaker Output		Internal Speaker 10 W + 10 W (Stereo)	
Control		RS-232C In: 9 Pin D-sub LAN: RJ-45 10 BASE-T/100 BASE-TX x1 Remote IN: Stereo Mini Jack 3.5 mm Ø Remote OUT: Stereo Mini Jack 3.5 mm Ø	
SD card Slot		Port: microSD card. Up to 32GB microSDHC is supported.	
USB Port		USB (2A): Media Player/Firmware update/Power supply port 5V/2A (max.)	
Power Supply		1.50 - 0.60 A @ 100-240V AC, 50/60Hz	
Power Consumption		Normal operation:	Approx. 65 W
Operational Environment		Temperature: 0 - 40°C / 32 - 104°F Humidity: 20 - 80% (without condensation) Altitude: 0 - 3000 m (Brightness may decrease with altitude)	
Storage Environment		Temperature: -20 - 60°C / -4 - 140°F Humidity: 10 - 90% (without condensation) / 90% - 3.5% x (Temp - 40°C) regarding over 40°C	
Dimension		1124.7 (W) x 645.3 (H) x 45.0 (D) mm/44.3 (W) x 25.4 (H) x 1.8 (D) inches (w/o Deco Dimension)	
Weight		16.1 kg (35.5 lbs)	
VESA compatible mounting interface		300 mm x 300 mm (M6, 4 Holes)	
Power Management		VESA DPM	

**NOTE:** Technical specifications are subject to change without notice.

\*1: Compressed image.

\*2: Common terminal.

# Specifications - C551

## Product Specifications

LCD Module		Pixel Pitch: 0.63 mm Resolution: 1920 x 1080 Color: Over 1073 million colors (depending on display card used) Brightness: 400 cd/m <sup>2</sup> (Max.) @25°C Contrast Ratio: 4000:1 Viewing Angle: 89° (typ) @ CR>10	55"/138.78 cm diagonal
Frequency		Horizontal: 15.625/15.734 kHz, 31.5 kHz - 91.1 kHz Vertical: 50.0 - 85.0 Hz (Analog Input) 24.0 - 85.0 Hz (Digital Input)	
Pixel Clock		Analog: 13.5 MHz, 25.0 MHz - 165.0 MHz Digital: 25.0 MHz - 165.0 MHz	
Viewable Size		1209.6 x 680.40 mm	
Input Signal			
DisplayPort	DisplayPort Connector	Digital RGB	The DisplayPort input complies with Standard V1.1a, applicable to HDCP SVGA60, XGA60, WXGA60, SXGA60, UXGA60, WUXGA60* <sup>1</sup> , 1920x1080 (60 Hz), 1080p, 1080i, 720p@50Hz/60Hz
VGA (RGB)* <sup>2</sup>	15pin Mini D-sub	Analog RGB	0.7 Vp-p/75 ohm VGA60, SVGA60, XGA60, WXGA60, SXGA60, UXGA60* <sup>1</sup> , WUXGA60* <sup>1</sup> , 1920X1080 (60Hz)
		Sync	Separate: TTL level (Pos./Neg.) Composite sync on Green Video: 0.3 Vp-p Neg.
HDMI	HDMI Connector	Digital YUV Digital RGB	HDMI SVGA60, XGA60, WXGA60, SXGA60, UXGA60, WUXGA60* <sup>1</sup> , 1920x1080 (60 Hz), 1080p, 1080i, 720p@50Hz/60Hz
VGA (YPbPr)* <sup>2</sup>	15pin Mini D-sub	Component	Y: 1.0 Vp-p/75ohm, Cb/Cr (Pb/Pr): 0.7 Vp-p/75 ohm HDTV/DVD: 1080p, 1080i, 720p@50Hz/60Hz, 576p@50Hz, 480p@60Hz, 576i@50Hz, 480i@60Hz
VIDEO* <sup>2</sup>	RCA port	Composite	1.0 Vp-p/75 ohm NTSC/PAL/SECAM/4.43NTSC/PAL60
AUDIO			
AUDIO Input	Stereo Mini Jack	Analog Audio	Stereo L/R 0.5 Vrms x 2
	HDMI Connector	Digital Audio	PCM 32, 44.1, 48 KHz (16/20/24bit)
	DisplayPort Connector	Digital Audio	PCM 32, 44.1, 48 KHz (16/20/24bit)
AUDIO Output	Stereo Mini Jack	Analog Audio	Stereo L/R 0.5 Vrms
Speaker Output		Internal Speaker 10 W + 10 W (Stereo)	
Control		RS-232C In: 9 Pin D-sub LAN: RJ-45 10 BASE-T/100 BASE-TX x1 Remote IN: Stereo Mini Jack 3.5 mm Ø Remote OUT: Stereo Mini Jack 3.5 mm Ø	
SD card Slot		Port: microSD card. Up to 32GB microSDHC is supported.	
USB Port		USB (2A): Media Player/Firmware update/Power supply port 5V/2A (max.)	
Power Supply		1.55 - 0.65 A @ 100-240V AC, 50/60Hz	
Power Consumption		Normal operation:	Approx. 75 W
Operational Environment		Temperature: 0 - 40°C / 32 - 104°F Humidity: 20 - 80% (without condensation) Altitude: 0 - 3000 m (Brightness may decrease with altitude)	
Storage Environment		Temperature: -20 - 60°C / -4 - 140°F Humidity: 10 - 90% (without condensation) / 90% - 3.5% x (Temp - 40°C) regarding over 40°C	
Dimension		1238.4 (W) x 709.2 (H) x 45.0 (D) mm/48.8 (W) x 27.9 (H) x 1.8 (D) inches (w/o Deco Dimension)	
Weight		18.8 kg (41.4 lbs)	
VESA compatible mounting interface		300 mm x 300 mm (M6, 4 Holes)	
Power Management		VESA DPM	

**NOTE:** Technical specifications are subject to change without notice.

\*1: Compressed image.

\*2: Common terminal.

# Manufacturer's Recycling and Energy Information

NEC DISPLAY SOLUTIONS is strongly committed to environmental protection and sees recycling as one of the company's top priorities in trying to minimize the burden placed on the environment. We are engaged in developing environmentally-friendly products, and always strive to help define and comply with the latest independent standards from agencies such as ISO (International Organisation for Standardization) and TCO (Swedish Trades Union).

## Disposing of your old NEC product

The aim of recycling is to gain an environmental benefit by means of re-use, upgrading, reconditioning or reclamation of material. Dedicated recycling sites ensure that environmentally harmful components are properly handled and securely disposed. To ensure the best recycling of our products, **NEC DISPLAY SOLUTIONS offers a variety of recycling procedures** and gives advice on how to handle the product in an environmentally sensitive way, once it has reached the end of its life.

All required information concerning the disposal of the product and country-specific information on recycling facilities can be found on our following websites:

<https://www.nec-display-solutions.com/p/greenvision/en/greenvision.xhtml> (in Europe),

<http://www.nec-display.com> (in Japan) or

<http://www.necdisplay.com> (in USA).

## Energy Saving

This monitor features an advanced energy saving capability. When a Display Power Management signal is sent to the monitor, the Energy Saving mode is activated. The monitor enters a single Energy Saving mode.

For additional information visit:

<http://www.necdisplay.com/> (in USA)

<http://www.nec-display-solutions.com/> (in Europe)

<http://www.nec-display.com/global/index.html> (Global)

For ErP requirement/For ErP (Network standby) requirement:

Condition: INPUT DETECT is not NONE, STANDBY USB POWER is ENABLE, or QUICK TURN ON is ENABLE.

Power consumption: 2 W or less (Glowing amber).

Time for power management function: 40 sec. (Default setting)  
(Except for a condition that the monitor has plural signal inputs.)

Power consumption: 0.5 W or less (Blinking amber).

Time for power management function: 3 min. (Default setting)  
(Except for a condition that the monitor has plural signal inputs.)

## WEEE Mark (European Directive 2012/19/EU and amendments)



### Disposing of your used product: In the European Union

EU-wide legislation as implemented in each Member State requires that used electrical and electronic products carrying the mark (left) must be disposed of separately from normal household waste. This includes monitors and electrical accessories, such as signal cables or power cords. When you dispose of such products, please follow the guidance of your local authority or ask the shop where you purchased the product, or if applicable, follow applicable legislation or agreement you may have. The mark on electrical and electronic products may only apply to the current European Union Member States.

### Outside the European Union

If you wish to dispose of used electrical and electronic products outside the European Union, please contact your local authority and ask for the correct method of disposal.



**For EU:** The crossed-out wheeled bin implies that used batteries should not be put to the general household waste! There is a separate collection system for used batteries, to allow proper treatment and recycling in accordance with legislation.

**According the EU directive 2006/66/EC, the battery can't be disposed improperly. The battery shall be separated to collect by local service.**

---

---

## **[Notice] About the MPEG AVC, MPEG-4 Visual license included in this product**

---

---

### **1. MPEG AVC**

THIS PRODUCT IS LICENSED UNDER THE AVC PATENT PORTFOLIO LICENSE. SUCH LICENSE EXTENDS TO THIS PRODUCT ONLY AND ONLY TO THE EXTENT OF OTHER NOTICES WHICH MAY BE INCLUDED HEREIN. THE LICENSE DOES NOT EXTEND TO ANY OTHER PRODUCT REGARDLESS OF WHETHER SUCH PRODUCT IS INCLUDED WITH THIS LICENSED PRODUCT IN A SINGLE ARTICLE. ADDITIONAL INFORMATION MAY BE OBTAINED FROM MPEG LA, L.L.C. SEE [HTTP://WWW.MPEGLA.COM](http://www.mpegla.com)

### **2. MPEG-4 Visual**

THIS PRODUCT IS LICENSED UNDER THE MPEG-4 VISUAL PATENT PORTFOLIO LICENSE FOR THE PERSONAL AND NON-COMMERCIAL USE OF A CONSUMER FOR (i) ENCODING VIDEO IN COMPLIANCE WITH THE MPEG-4 VISUAL STANDARD ("MPEG-4 VIDEO") AND/OR (ii) DECODING MPEG-4 VIDEO THAT WAS ENCODED BY A CONSUMER ENGAGED IN A PERSONAL AND NONCOMMERCIAL ACTIVITY AND/OR WAS OBTAINED FROM A VIDEO PROVIDER LICENSED BY MPEG LA TO PROVIDE MPEG-4 VIDEO. NO LICENSE IS GRANTED OR SHALL BE IMPLIED FOR ANY OTHER USE. ADDITIONAL INFORMATION INCLUDING THAT RELATING TO PROMOTIONAL, INTERNAL AND COMMERCIAL USES AND LICENSING MAY BE OBTAINED FROM MPEG LA, LLC. SEE [HTTP://WWW.MPEGLA.COM](http://www.mpegla.com).