

# datavideo



**HD/SD 4-CHANNEL HDBaseT  
PORTABLE VIDEO STUDIO**

**HS-1500T**

**Instruction Manual**

[www.datavideo.com](http://www.datavideo.com)

# Table of Contents

<b>FCC COMPLIANCE STATEMENT</b> .....	<b>4</b>
<b>WARNINGS AND PRECAUTIONS</b> .....	<b>4</b>
<b>WARRANTY</b> .....	<b>5</b>
STANDARD WARRANTY.....	5
THREE YEAR WARRANTY.....	5
<b>DISPOSAL</b> .....	<b>6</b>
<b>CHAPTER 1 INTRODUCTION</b> .....	<b>7</b>
1.1 FEATURES.....	7
1.2 SYSTEM DIAGRAM.....	8
<b>CHAPTER 2 CONNECTIONS AND CONTROLS</b> .....	<b>9</b>
2.1 REAR PANEL.....	9
2.2 SWITCHER KEYBOARD PANEL.....	11
2.3 MONITOR CONTROL PANEL.....	19
<b>CHAPTER 3 SWITCHER OSD MENU</b> .....	<b>21</b>
3.1 START.....	21
3.1.1 <i>Transition Type</i> .....	21
3.1.2 <i>Transition Speed</i> .....	21
3.1.3 <i>Wipe Effect</i> .....	22
3.1.4 <i>WIPE Border Size</i> .....	22
3.1.5 <i>WIPE Border Color</i> .....	22
3.1.6 <i>BKG Color</i> .....	22
3.2 PIP / SPLIT.....	22
3.2.1 <i>PIP Source</i> .....	23
3.2.2 <i>PIP Size (PIP Window Size)</i> .....	23
3.2.3 <i>Position X</i> .....	24
3.2.4 <i>Position Y</i> .....	24
3.2.5 <i>Split Source</i> .....	24
3.2.6 <i>Border Size</i> .....	24
3.2.7 <i>Border Color</i> .....	24
3.3 PIP CROP.....	24
3.4 LUMAKEY.....	25
3.4.1 <i>Lumakey Source</i> .....	25
3.4.2 <i>Mode</i> .....	25
3.4.3 <i>Cleanup Level</i> .....	26
3.4.4 <i>Transparency</i> .....	26
3.5 AUDIO.....	26
3.5.1 <i>Mute</i> .....	26
3.5.2 <i>HDMI Input</i> .....	26
3.5.3 <i>HDMI Group</i> .....	26
3.5.4 <i>Level</i> .....	26
3.5.5 <i>Tally Mode</i> .....	26
3.6 USER MEMS.....	27
3.6.1 <i>Load Memory</i> .....	27
3.6.2 <i>Save Memory</i> .....	27
3.7 SETUP.....	27

3.7.1	<i>PGM Out Res.</i>	28
3.7.2	<i>MV Out Res.</i>	28
3.7.3	<i>Save Setup</i>	29
3.7.4	<i>Factory Default</i>	29
3.7.5	<i>Language</i>	29
3.7.6	<i>MB and KBD Software</i>	29
3.8	CAMERA	29
3.8.1	<i>Camera CH. Setup</i>	30
3.8.2	<i>PTC-150T-01/02/03</i>	30
	Camera Info	30
	Video	30
	Operator	31
<b>CHAPTER 4</b>	<b>MONITOR</b>	<b>32</b>
4.1	MENU OPTIONS	32
4.1.1	<i>MAIN ADJUST</i>	33
4.1.2	<i>COLOR</i>	33
4.1.3	<i>Information</i>	33
4.1.4	<i>Special Function</i>	33
4.1.5	<i>Factory Reset</i>	34
4.2	FIRMWARE UPDATE PROCEDURE	34
<b>CHAPTER 5</b>	<b>APPLICATIONS</b>	<b>35</b>
5.1	PLACING A LOGO ON THE VIDEO USING THE LUMAKEY FUNCTION	35
5.2	CONNECTING PTC-150T CAMERAS	35
<b>CHAPTER 6</b>	<b>APPENDICES</b>	<b>37</b>
APPENDIX 1	TALLY OUTPUTS	37
APPENDIX 2	FIRMWARE UPGRADE	38
APPENDIX 3	FREQUENTLY-ASKED QUESTIONS	40
APPENDIX 4	TIPS FOR ESTABLISHING AN HDBASET COMPLIANCE ENVIRONMENT AND ETHERNET CABLE SELECTION	41
APPENDIX 5	DIMENSIONS	44
APPENDIX 6	SPECIFICATIONS	45
<b>SERVICE AND SUPPORT</b>		<b>47</b>

### Disclaimer of Product & Services

The information offered in this instruction manual is intended as a guide only. At all times, Datavideo Technologies will try to give correct, complete and suitable information. However, Datavideo Technologies cannot exclude that some information in this manual, from time to time, may not be correct or may be incomplete. This manual may contain typing errors, omissions or incorrect information. Datavideo Technologies always recommend that you double check the information in this document for accuracy before making any purchase decision or using the product. Datavideo Technologies is not responsible for any omissions or errors, or for any subsequent loss or damage caused by using the information contained within this manual. Further advice on the content of this manual or on the product can be obtained by contacting your local Datavideo Office or dealer.

# FCC Compliance Statement

This device complies with part 15 of the FCC rules. Operation is subject to the following two conditions:

- (1) This device may not cause harmful interference, and
- (2) This device must accept any interference received, including interference that may cause undesired operation.

## Warnings and Precautions



1. Read all of these warnings and save them for later reference.
2. Follow all warnings and instructions marked on this unit.
3. Unplug this unit from the wall outlet before cleaning. Do not use liquid or aerosol cleaners. Use a damp cloth for cleaning.
4. Do not use this unit in or near water.
5. Do not place this unit on an unstable cart, stand, or table. The unit may fall, causing serious damage.
6. Slots and openings on the cabinet top, back, and bottom are provided for ventilation. To ensure safe and reliable operation of this unit, and to protect it from overheating, do not block or cover these openings. Do not place this unit on a bed, sofa, rug, or similar surface, as the ventilation openings on the bottom of the cabinet will be blocked. This unit should never be placed near or over a heat register or radiator. This unit should not be placed in a built-in installation unless proper ventilation is provided.
7. This product should only be operated from the type of power source indicated on the marking label of the AC adapter. If you are not sure of the type of power available, consult your Datavideo dealer or your local power company.
8. Do not allow anything to rest on the power cord. Do not locate this unit where the power cord will be walked on, rolled over, or otherwise stressed.
9. If an extension cord must be used with this unit, make sure that the total of the ampere ratings on the products plugged into the extension cord do not exceed the extension cord rating.
10. Make sure that the total amperes of all the units that are plugged into a single wall outlet do not exceed 15 amperes.
11. Never push objects of any kind into this unit through the cabinet ventilation slots, as they may touch dangerous voltage points or short out parts that could result in risk of fire or electric shock. Never spill liquid of any kind onto or into this unit.
12. Except as specifically explained elsewhere in this manual, do not attempt to service this product yourself. Opening or removing covers that are marked "Do Not Remove" may expose you to dangerous voltage points or other risks, and will void your warranty. Refer all service issues to qualified service personnel.
13. Unplug this product from the wall outlet and refer to qualified service personnel under the following conditions:
  - a. When the power cord is damaged or frayed;
  - b. When liquid has spilled into the unit;
  - c. When the product has been exposed to rain or water;
  - d. When the product does not operate normally under normal operating conditions. Adjust only those controls that are covered by the operating instructions in this manual; improper

adjustment of other controls may result in damage to the unit and may often require extensive work by a qualified technician to restore the unit to normal operation;

- e. When the product has been dropped or the cabinet has been damaged;
- f. When the product exhibits a distinct change in performance, indicating a need for service.

## Warranty

### Standard Warranty

- Datavideo equipment are guaranteed against any manufacturing defects for one year from the date of purchase.
- The original purchase invoice or other documentary evidence should be supplied at the time of any request for repair under warranty.
- The product warranty period begins on the purchase date. If the purchase date is unknown, the product warranty period begins on the thirtieth day after shipment from a Datavideo office.
- All non-Datavideo manufactured products (product without Datavideo logo) have only one year warranty from the date of purchase.
- Damage caused by accident, misuse, unauthorized repairs, sand, grit or water is not covered under warranty.
- Viruses and malware infections on the computer systems are not covered under warranty.
- Any errors that are caused by unauthorized third-party software installations, which are not required by our computer systems, are not covered under warranty.
- All mail or transportation costs including insurance are at the expense of the owner.
- All other claims of any nature are not covered.
- All accessories including headphones, cables, and batteries are not covered under warranty.
- Warranty only valid in the country or region of purchase.
- Your statutory rights are not affected.

### Three Year Warranty

- All Datavideo products purchased after July 1st, 2017 are qualified for a free two years extension to the standard warranty, providing the product is registered with Datavideo within 30 days of purchase.
- Certain parts with limited lifetime expectancy such as LCD panels, DVD drives, Hard Drive, Solid State Drive, SD Card, USB Thumb Drive, Lighting, Camera module, PCIe Card are covered for 1 year.
- The three-year warranty must be registered on Datavideo's official website or with your local Datavideo office or one of its authorized distributors within 30 days of purchase.



## Disposal

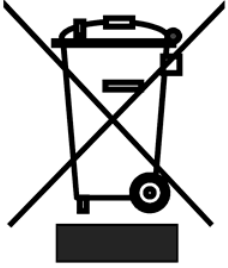

### For EU Customers only - WEEE Marking

This symbol on the product or on its packaging indicates that this product must not be disposed of with your other household waste. Instead, it is your responsibility to dispose of your waste equipment by handing it over to a designated collection point for the recycling of waste electrical and electronic equipment. The separate collection and recycling of your waste equipment at the time of disposal will help to conserve natural resources and ensure that it is recycled in a manner that protects human health and the environment. For more information about where you can drop off your waste equipment for recycling, please contact your local city office, your household waste disposal service or the shop where you purchased the product.



**CE Marking** is the symbol as shown on the left of this page. The letters "CE" are the abbreviation of French phrase "Conformité Européene" which literally means "European Conformity". The term initially used was "EC Mark" and it was officially replaced by "CE Marking" in the Directive 93/68/EEC in 1993. "CE Marking" is now used in all EU official documents.

# Chapter 1 Introduction

Datavideo's HS-1500T Hand-carry Mobile Switcher, the cutting-edge technology that supports **Full HD 1080P**, is designed for broadcast of live events and TV programs with a need for mixing a wide variety of video and audio sources. The HS-1500T is a highly valuable solution for **religion, education and AV markets**.

With its built-in **HDBaseT technology**, the HS-1500T is able to accept the Full HD 1080p video format from three PTC-150T HDBaseT PTZ Cameras through three individual CAT-6 cables. Each cable runs up to **100 meters**. While shooting in the field, the **PoE** feature serves to power the three PTC-150T devices. The PoE feature can also be used in the field where long-distance transmission is required.

The HS-1500T also features an **audio mixer** with balance XLR inputs and unbalance RCA audio inputs; more features include **PIP, WIPE Generator** and **Tally**.

The HS-1500T has a **Joystick** that allows the user to **Pan, Tilt** and **Zoom** the PTC-150T camera. In addition, the HS-1500T also allows the user to adjust the PTC-150T's **Focus, IRIS** and **other settings**.

## 1.1 Features

- Full HD 1080P Video Format
- Built-in HDBaseT technology to connect three PTC-150T HDBaseT PTZ Cameras through three CAT-6 (or higher) cables with each cable running up to 100 meters.
- PoE technology to Power the PTC-150Ts
- Joystick Pan, Tilt and Zoom with speed control
- Iris, Focus, and Gain Control as well as other PTC-150T camera functions
- 4 Video Inputs (RJ-45 x 3 + HDMI x 1)
- 3 Video Outputs (HDMI x 3)
- Audio inputs: XLR Analogue x 2 + RCA Analogue (L/R) x 2
- Versatile Mix Effects: PIP, WIPE, Mix and Fades
- Tally Output
- One 17.3-inch monitor with a resolution of 1920x1080

## 1.2 System Diagram

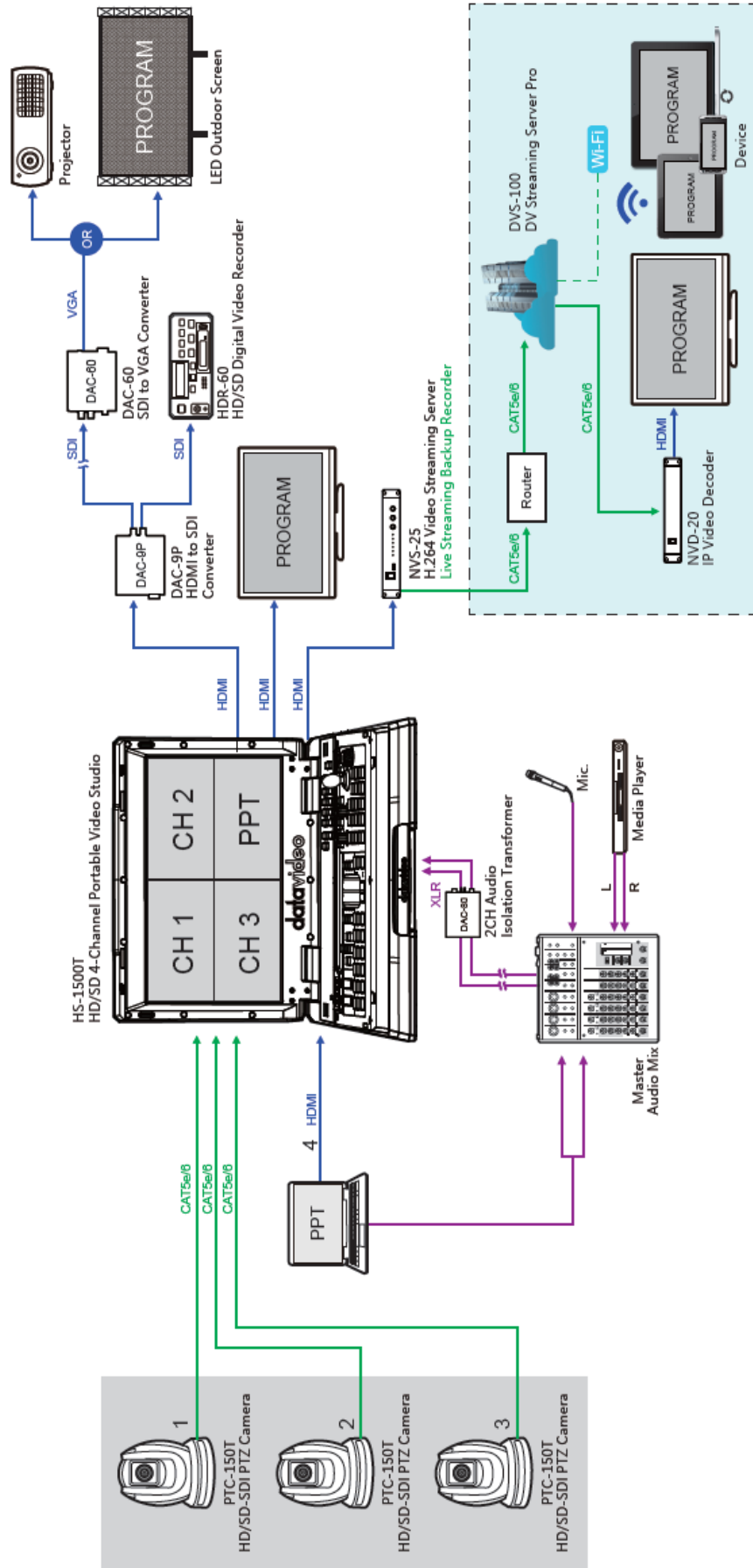



# Chapter 2 Connections and Controls

## 2.1 Rear Panel

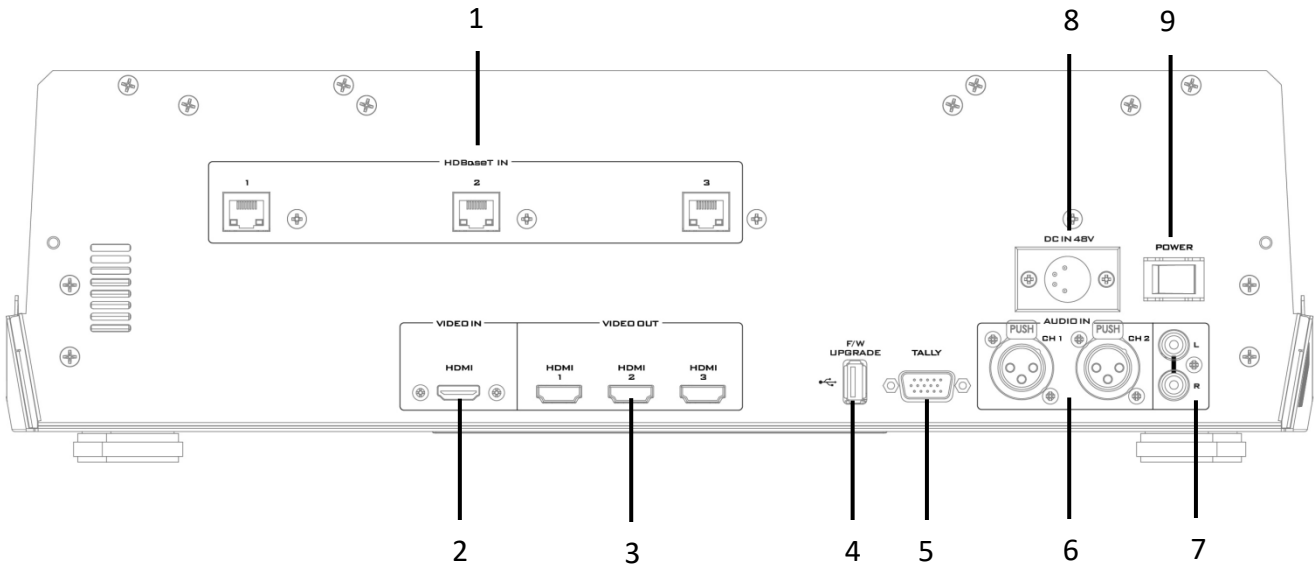

- |   |                      |   |                                       |
|---|----------------------|---|---------------------------------------|
| 1 | HDBaseT Port x 3     | 6 | MIC IN – CH1/CH2                      |
| 2 | HDMI Video IN        | 7 | Audio Input – Stereo RCA (Left/Right) |
| 3 | HDMI Video OUT x 3   | 8 | DC IN                                 |
| 4 | USB F/W Upgrade Port | 9 | Power Switch                          |
| 5 | TALLY Output Port    |   |                                       |

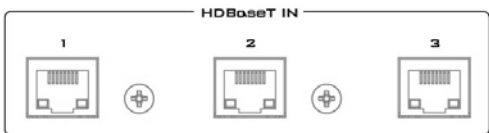

### 1. HDBaseT IN

The HDBaseT ports connect three HDBaseT cameras via three CAT-6 Ethernet cables. The camera videos will be displayed on the respective Multiview quadrants.

### HDMI



### 2. HDMI Video Input

The HDMI Video Input port connects an additional video source device and the video will be displayed on the fourth quadrant.



### 3. HDMI Video Output 1 – 3

Connect to a monitor for Program OUT display or other HDMI destination devices.



### 4. USB F/W Upgrade Port

USB port for firmware upgrade. Please refer to the [Firmware Upgrade](#) section for details.

**TALLY**

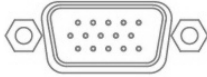

**5. TALLY Output Port**

Sends **Red** and **Green** tally signals to each channel.

**Red** indicates On-Air, and **Green** indicates next camera source. Tally output port can connect other Datavideo peripheral devices such as ITC-100, ITC-200, AM-100 or other monitor models, allowing the peripheral device to communicate with the HS-1500T or send tally signal to be displayed on the monitor.

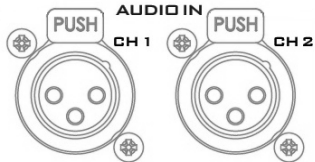

**6. Audio Input – XLR Balanced (CH1/CH2)**

Two channels of XLR Balanced Audio Input.

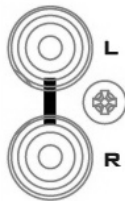

**7. Audio Input – Stereo RCA (Left/Right)**

Connects unbalanced analog audio source (stereo).

Two Channels of unbalanced MIC input.

CH L	CH R	States
MIC1	MIC2	MIC 1(L) and MIC 2(R) are respectively connected to left and right channels.
MIC1	NC*	When MIC 1 is connected to the left channel and MIC 2 is not connected to the right channel, the right channel switch will replicate MIC 1 signal onto the right channel thus both channels are MIC 1 input signals.
NC*	MIC2	When no MIC signal is connected to the left channel and only MIC 2 is connected to the right channel, MIC 2 signal will not be replicated onto the left channel which will thus be grounded.
NC*	NC*	When no MIC is connected to the two channels, the left channel switch will ground the left channel to prevent noise from being generated.

**\*No Connection**

**POWER**

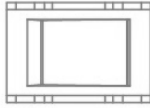

**8. Power Switch**

Power switch ON/OFF

**DC IN 48V**

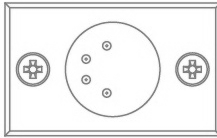

**9. DC IN**



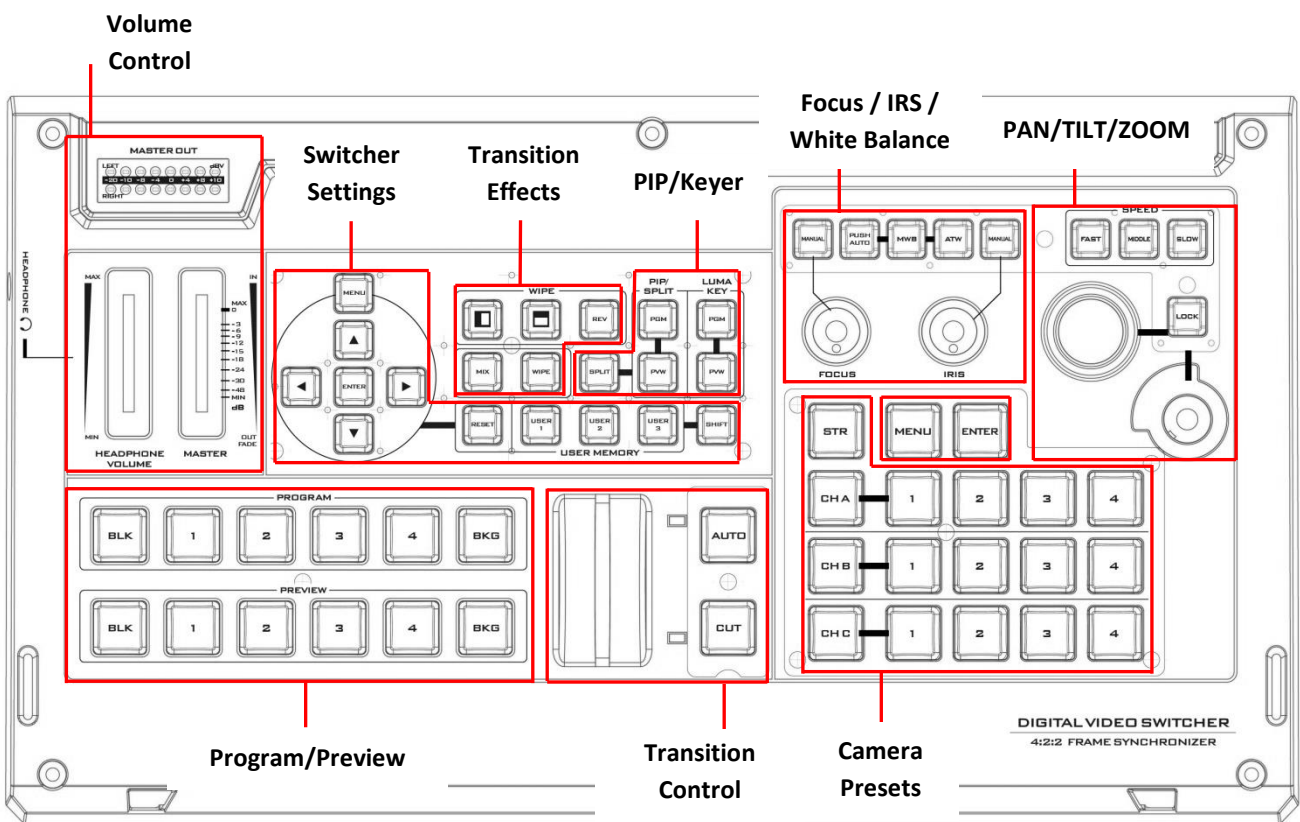

DC in socket connects the supplied 48V / 190W PSU. The connection can be secured by screwing the outer fastening ring of the DC In plug to the socket.

**2.2 Switcher Keyboard Panel**

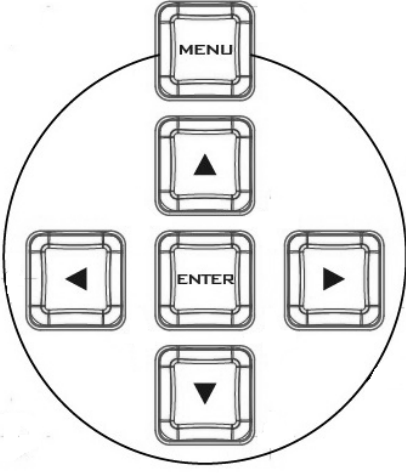

Switcher Settings	Volume Control
Menu browsing buttons	Volume adjustment sliders
RESET button	Headphone jack
User Memory	Audio meter
Shift button	Headphone volume control knob
Transition Effects	Camera Presets
WIPE transition effect selection	Channel Selection Buttons
MIX Enable/Disable button	Preset Buttons
WIPE transition effect Enable/Disable	STR Button
PIP/Keyer	FOCUS / IRIS / White Balance
Enable/Disable buttons for PIP Keyer	Focus Adjustment

Luma Keyer Enable/Disable buttons	IRIS Adjustment
Split Activation button	White Balance
<b>Transition Control</b>	<b>PAN / TILT / ZOOM</b>
T-Bar (manual transition)	Speed Selection Buttons
CUT button	Joystick – PAN/TILT
AUTO transition button	VR Knob – ZOOM
<b>Program/Preview</b>	LOCK Button
Program row	<b>Camera MENU Control</b>
Preview row	MENU Button
	ENTER Button

<b>Switcher Settings</b>	
	<p><b>Menu browsing buttons</b> Press the <b>MENU</b> button to gain access to the menu; use the up/down/left/right <b>arrow buttons</b> to browse through the menu and press <b>ENTER</b> button to select an option or <b>MENU</b> button again to exit.</p>
	<p><b>Reset Button</b> <b>Mode 1</b> – When in Menu Select mode (left hand column of the OSD menu), pressing the 'Reset' button will reset all current menu items to their factory defaults. <b>Mode 2</b> – When in a Sub-Menu, pressing the 'Reset' button will reset the current menu line only.</p>
	<p><b>User Memory</b> User Memory buttons 1-3 allow the user to quickly recall and load previously saved switcher settings with a single button press. This includes PIP and Keyer settings. See the <a href="#">User Memory</a> section for more information.</p>
	<p><b>Shift Button</b> Pressing the <b>Shift</b> button will switch USER 1-3 buttons to USER 4-6 buttons</p>

## Transition Effects

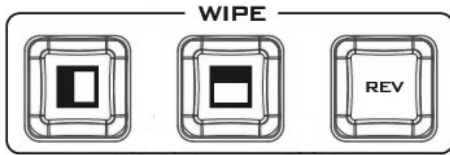

### WIPE Transition Effect Selection

Each Wipe button consists of black and white colors. The white represents the current **Program** image and the black represents the **WIPE-IN** image. The HS-1500T provides 3 WIPE presets with the **Horizontal** and **Vertical** WIPEs selectable on the control panel. The **Center** WIPE can be selected from the menu ([Start](#)).

Pressing the **REV** button reverses the direction of the **WIPE**.



### MIX Enable/Disable Button

A **MIX**, also known as a dissolve, is a transition wherein the Program video is replaced by the Preview video at a smooth rate, and at the same time. Pressing the **MIX** button enables the **MIX** transition effect and automatically disables the **WIPE** button. To trigger the **MIX** effect, simply press the **AUTO** button or move the **T-Bar**.



### WIPE Transition Effect Enable/Disable Button

Pressing the **WIPE** button enables the **WIPE** transition effect after which the **WIPE** transition effect can be selected. To trigger the **WIPE** transition effect, simply press the **AUTO** button or move the **T-Bar**.

**Wipe Transition Effect, Border and Position** settings can be found in the OSD menu ([Start](#)).

## PIP / Keyer







### Enable/Disable Buttons for PIP Keyer

Picture in Picture puts the selected Sub Video Source in a window on the Main Program view, with control over window size and placement. For PIP configuration, please refer to the [PIP](#) section.

**PIP PGM:** Shows the configured PIP on the PGM output after transition, however, the PIP cannot be previewed on the QUAD split view display.

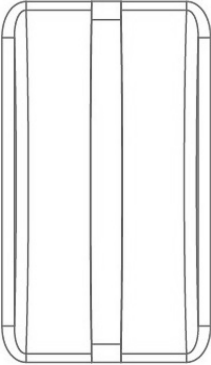
**PIP PVW:** Sets the configured PIP on the next transition. Holding down this button allows selection of the PIP source from the Preview Source row. The selected source button will flash.

<p style="text-align: center;"><b>LUMA KEY</b></p>  <p style="text-align: center;">PGM</p>  <p style="text-align: center;">PVW</p>	<p><b>Luma Keyer Enable/Disable Buttons</b></p> <p><b>Luma Key PGM:</b> Shows the luma key source on the PGM output and enables the luma key effect, however, the luma key effect cannot be previewed on the QUAD split view display.</p> <p><b>Luma Key PVW:</b> Enables luma key source for the PGM output on the next transition. Holding down this button allows selection of the luma key source from the Preview Source row. The selected source button will flash.</p> <p>Please refer to Section 3.4, the <a href="#">Luma Key</a> section, for luma key configurations.</p>
 <p style="text-align: center;">SPLIT</p>	<p><b>Split Activation Button</b></p> <p><b>After activating the PIP window,</b> pressing the <b>Split</b> button will split the PROGRAM output display into two with the program out view on the left and the PIP view on the right.</p> <p>To select the Split source, i.e. the program out view, please see <a href="#">Section 3.2.5</a>.</p>
<b>Transition Control</b>	
	<p><b>T-Bar (Manual Transition)</b></p> <p><b>T-Bar</b> is used for manual transition. The <b>T-Bar</b> can be either all the way up, all the way down or anywhere in between. When the T-Bar is pushed to halfway between the topmost position and the bottommost position, the keyboard functions will be disabled.</p> <p><b>PVW</b> and <b>PGM</b> views can be transitioned at your preferred speed. To include the transition effect, simply press the <b>WIPE</b> or <b>MIX</b> button, after which the <b>Transition Effect</b> will be triggered as you move the <b>T-Bar</b>.</p>
 <p style="text-align: center;">CUT</p>	<p><b>CUT Button</b></p> <p>Pressing the <b>Cut</b> button performs immediate manual switch between PVW and PGM views without the transition effect.</p>
 <p style="text-align: center;">AUTO</p>	<p><b>AUTO Button</b></p> <p>Pressing the <b>Auto</b> button automatically transitions <b>PVW</b> and <b>PGM</b> views according to the selected speed and the configured transition effect.</p>

## Program / Preview Outputs

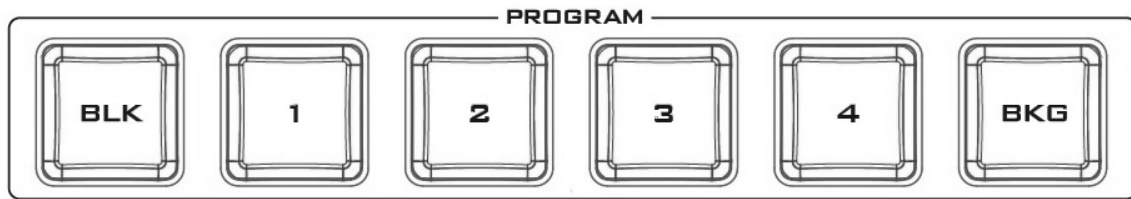

### Program Source Row

Pressing the number buttons along the **PROGRAM** row selects a video source for the **PGM** view.

**BKG** button: Pressing the **BKG** button will switch the background to a **Matte** background. The BKG color can be configured on the OSD MENU and the available color options are listed as follows:

- White
- Yellow
- Cyan
- Green
- Magenta
- Red
- Blue
- Black

**BLK** button: Pressing the **BLK** button places a black screen on the **PROGRAM** view.

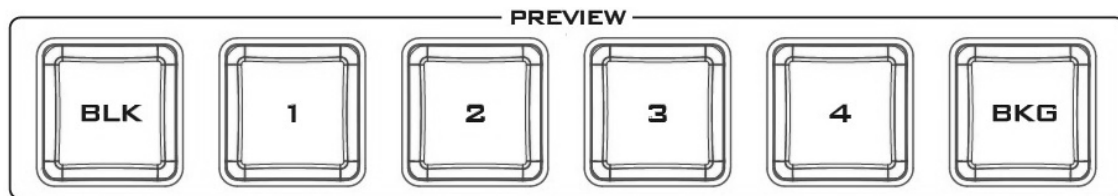

### Preview Source Row

Pressing the number buttons along the **PREVIEW** row selects a video source.

**BKG** button: Pressing the **BKG** button will set the Preview OUT to a **Matte** background, which will be displayed on the **Program OUT** monitor upon the next transition. The BKG color can be configured on the OSD MENU and the available color options are listed as follows:

- White
- Yellow
- Cyan
- Green
- Magenta
- Red
- Blue
- Black

**BLK** button: Pressing the **BLK** button sets the **Preview** OUT to a black screen.

## Volume Control

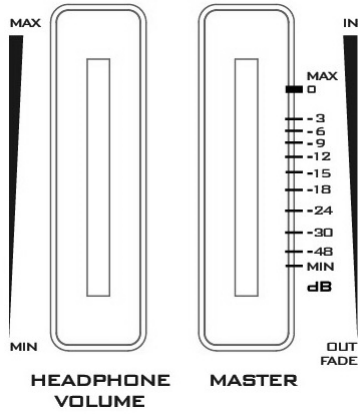

### Volume Adjustment Sliders

Sliders to control audio levels for the Main audio mixer.

**Headphone Volume:** Audio volume of the connected headphone.

**Master:** Main audio output volume.



### Headphone Jack

Headphone jack accepts the mini jack plug of the stereo headphone type. The headphone volume is controlled by the Headphone volume adjustment slider.

### MASTER OUT

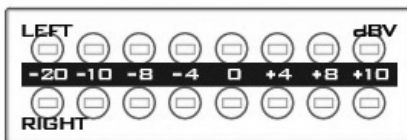

### MASTER OUT Meter

The LED style meters show the audio signal strength at the Main Program Audio Output. The signal strength is determined by the level set with the Master OUT slider. The LEDs turn red at +10 dB to indicate clipping distortion.

Audio Volume (dBV)	-20		-10		-8		-4		0		+4		+8		+10	
LED Color	G		G		G		G		G		Y		Y		R	
Range (dBV)	-20	-12	-11	-9.5	-8.5	-6.5	-5.5	-3	-2	1	2	5.5	6.5	8	9+	

**G: Green Y: Yellow R: Red**

## Camera Presets



### Channel Selection Buttons

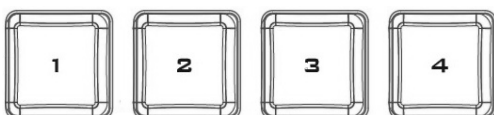

To control or set up a connected camera, first select it by pressing these buttons. The selected channel button will be turned ON.





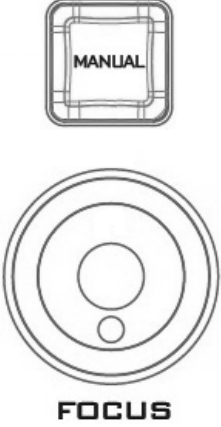
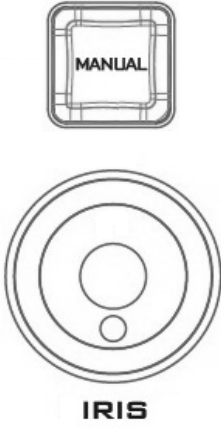

### Preset Buttons

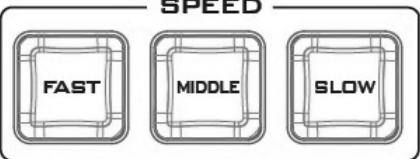
These buttons may be used to store up to four camera positions for each camera. Each button corresponds to one stored camera position. The button LED will be turned ON when selected.

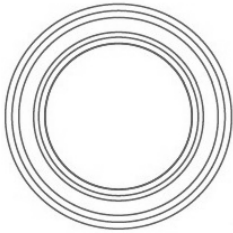
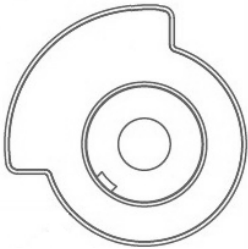

	<p><b>STR Button</b> Pressing this button enters the HS-1500T into <b>STORE MODE</b>. When activated, this allows the current camera position to be stored in a chosen Channel Preset Button. Press again to exit <b>STORE MODE</b>.</p>
<b>FOCUS / IRIS / White Balance</b>	
	<p><b>Focus Adjustment</b> To manually control the <b>FOCUS</b> setting, first press the <b>MANUAL</b> button to enter the manual mode. The button LED will be turned ON to indicate that the manual mode is enabled.</p> <p>The <b>FOCUS</b> dial can then be rotated to set the focus.</p> <p>If the <b>MANUAL</b> button is disabled (OFF), the camera will be in <b>AUTO FOCUS</b> mode.</p>
	<p><b>IRIS Adjustment</b> To manually control the <b>IRIS</b> setting, first press the <b>MANUAL</b> button to enter the manual mode. The button LED will be turned ON to indicate that the manual mode is enabled.</p> <p>The <b>IRIS</b> dial can then be rotated to set the exposure.</p> <p>If the <b>MANUAL</b> button is disabled (OFF), the camera will be in <b>AUTO IRIS</b> mode.</p>
	<p><b>White Balance</b></p> <p><b>Push Auto</b> Push once to automatically adjust the camera white balance setting.</p> <p><b>MWB (Manual White Balance)</b> Push to enable manual white balance setting.</p> <p><b>ATW (Force Automatic White Balance)</b> Push to enable automatic white balance setting.</p>
<b>PAN / TILT / ZOOM</b>	
	<p><b>Speed Selection Buttons</b> The speed at which the selected camera moves can be chosen by pressing one of the three speed buttons.</p>

	<p><b>Joystick – PAN / TILT</b></p> <p><b>PAN</b> – Move the joystick left or right to pan the selected PTZ camera from left to right or vice versa.</p> <p><b>TILT</b> – Move the joystick up or down to tilt the selected PTZ camera up or down.</p> <p><b>Note:</b> Before attempting to use the joystick to PAN or TILT a selected camera, first make sure the <b>LOCK</b> button is not enabled. If the <b>LOCK</b> button LED is ON, the joystick is locked; press the <b>LOCK</b> button to unlock the joystick.</p>
	<p><b>VR Knob – ZOOM</b></p> <p><b>ZOOM</b> – Twist the joystick clockwise (to the right) or anti-clockwise (to the left) to have the selected PTZ camera zoom in or out.</p> <p>Note: Make sure the <b>LOCK</b> button is not enabled. If the <b>LOCK</b> button LED is ON, the joystick is locked; press the <b>LOCK</b> button to unlock the joystick.</p>
	<p><b>LOCK Button</b></p> <p>When enabled, the joystick will be in the lock state. To resume its functional status, simply press the button once to unlock the joystick.</p>
<b>Camera MENU Control</b>	
	<p><b>MENU Button</b></p> <p>Press once to open the <b>OSD MENU</b> of the connected PTC-150T on the monitor screen. Use the <b>P/T</b> joystick to move between options. To select, simply press the <b>ENTER</b> button. Please see the <b>PTC-150T instruction manual</b> for details of the menu operation.</p> <p><b>Note:</b> Pressing the menu button again will not exit the <b>OSD MENU</b>. Select the <b>ESCAPE</b> option on the <b>OSD MENU</b> to exit.</p>
	<p><b>ENTER Button</b></p> <p>Press this button to select a menu option after the camera OSD menu is opened.</p>

## 2.3 Monitor Control Panel

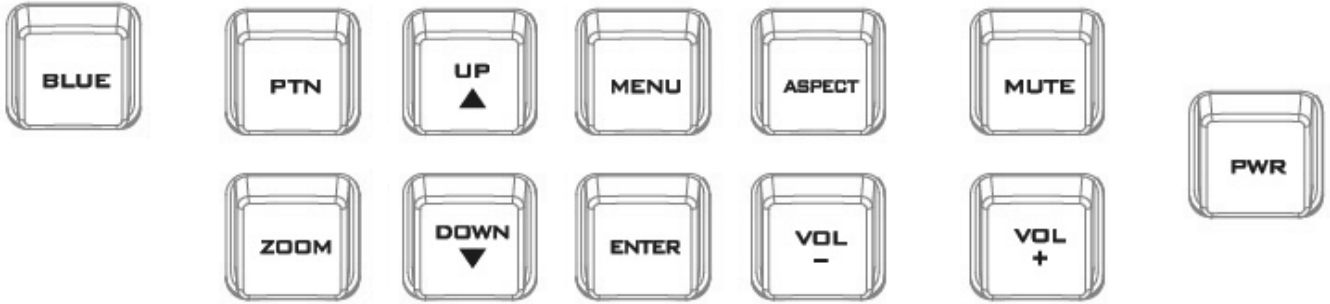

### Power

Switches the HS-1500T Monitor Power ON / OFF



### BLUE

Press this button to eliminate the red and green component of input signals. Only the blue component of an input is displayed on the screen. This allows adjustments of chroma and phase. (Phase adjustment is effective with NTSC signals).



### PTN

When pressed displays internally generated SMPTE 75% Colour Bars. Press again to return to the previously selected video input.



### ZOOM

This feature is designed for use with HD-SDI and HDMI sources above 720p resolution. Press this button to zoom in to the video on the display. This is strictly a zooming function and does not alter the native aspect ratio of the source pixels to fill the screen.

The **ZOOM** button allows you to toggle the Pixel Zoom feature between **zoom x1, x2, x4** and **x8**.



### Menu Navigation Buttons

Display and navigate the setup menus. See [Monitor Menu Options](#) for more details.





**Aspect Ratio Button**

Sets the Aspect Ratio to 16:9 / 4:3



**Volume Control**

Adjusts the speaker / headphone volume up / down.

**MUTE**

Mutes the audio from the internal speakers or headphone socket.

## Chapter 3 Switcher OSD Menu

The switcher's OSD menu allows the user to perform several configurations of video effects, such as picture-in-picture, luma key and etc. The user can also configure the audio settings in the Audio option. In addition, in the setup option, the user is allowed to set video output resolution, reset to factory default, and selects the interface language.

### 3.1 Start

Option	Parameters	Parameter Value or Range	Default Value
Start	Transition Type	MIX WIPE	Mix
	Transition Speed	1-200 frames	60 frames; the duration in second depends on the Program OUT resolution.
	WIPE Effect	1. Horizontal 2. Vertical 3. Center	1
	WIPE Border Size	OFF Small Middle Large	Small
	WIPE Border Color	White Yellow Cyan Green Magenta Red Blue Black	Red
	BKG Color	White Yellow Cyan Green Magenta Red Blue Black	White

#### 3.1.1 Transition Type

The HS-1500T provides two types of transition effect, which are cross dissolve (MIX) and WIPE. The default setting is **MIX**.

#### 3.1.2 Transition Speed

The **Transition Speed** allows the user to set the **MIX** or **WIPE** effect duration, in frames. If the **Transition Speed** is set to a value of 60 then the transition will take effect over a period of 1 second if the progressive video is chosen and 2 seconds if the interlaced video is chosen. When the **AUTO button** is pressed, the transition will take the current **Transition Speed** defined by the user.

**Note:** Pressing the left or right arrow button on the control panel allows the user to either decrement or increment Position X by 1. To change the parameter value at an accelerated rate, simply press and hold the left or right arrow button.

### 3.1.3 Wipe Effect

On the HS-1500T, there are three wipe effects available for the user to choose. The three wipe effects are **HORIZONTAL**, **VERTICAL** and **CENTER**. The default is Horizontal.

### 3.1.4 WIPE Border Size

The **WIPE Border Size** generally allows the user to select an appropriate border width. Setting the **WIPE Border Size** to OFF turns the border off. Setting this parameter to small selects a thin border; middle will yield a medium size width; large is the maximum wipe border width.

### 3.1.5 WIPE Border Color

In this option, you will be allowed to select a color for your wipe border. The available colors are listed as follows:

- White
- Yellow
- Cyan
- Green
- Magenta
- Red
- Blue
- Black

### 3.1.6 BKG Color

In this option, you will be allowed to assign a color to the **BKG** button. The available colors are listed as follows:

- White
- Yellow
- Cyan
- Green
- Magenta
- Red
- Blue
- Black

## 3.2 PIP / Split

Picture-In-Picture (P-In-P) places a sub window on the **PGM** or **Multiview** screen. This option (**PIP/Split**) allows you to configure various parameters of the PIP window.

**Note:** When PIP and LumaKey features are enabled at the same time, the lumaKey source will be the upper layer and the PIP source will be the lower layer. The layer order cannot be changed.

Option	Parameters	Parameter Value or Range	Default Value
PIP/Split	PIP Source	Black	Input 2

		Input 1 Input 2 Input 3 <b>Input 4*</b> Background Color Bar	
	PIP Size	1-100%	30%
	Position X	-50% - +50%	20%
	Position Y	-50% - +50%	10%
	Split Source	Black Input 1 Input 2 Input 3 <b>Input 4*</b> Background Color Bar	Input 2
	Border Size	OFF Small Middle Large	Small
	Border Color	White Yellow Cyan Green Magenta Red Blue Black	Red

### 3.2.1 PIP Source

In this option, the user will be allowed to assign the PIP source; the available sources are listed as follows:

- Black
- Input 1
- Input 2
- Input 3
- **Input 4\***
- Background
- Color Bar

**Tip: To quickly assign the PIP source, simply press and hold the PIP PGM button and then select a source from the Program BUS.**

### 3.2.2 PIP Size (PIP Window Size)

The PIP Size parameter ranges from 1 to 100 with 1% being the smallest and 100 being the largest. Therefore 50% would represent a PIP window which is half the size of the background image. 100% would see the PIP window totally cover the background image unless offset to one side.

### 3.2.3 Position X

Adjusting **Position X** parameter moves the PIP window horizontally. Pressing the left or right arrow button on the control panel allows the user to either decrement or increment **Position X** by 1. To change the parameter value at an accelerated rate, simply press and hold the left or right arrow button.

### 3.2.4 Position Y

Adjusting **Position Y** parameter moves the PIP window vertically. Pressing the up or down arrow button allows the user to either increment or decrement **Position Y** by 10. Press and hold the up and down arrow buttons to change the parameter value at an accelerated rate.

### 3.2.5 Split Source

**After the PIP window is activated**, pressing the Split button will split the PROGRAM output display into two with the program out view on the left and the PIP view on the right. The Split source, i.e. the program out view, can be selected in this option. The available split sources are listed as follows:

- Black
- Input 1
- Input 2
- Input 3
- **Input 4\***
- Background
- Color Bar

### 3.2.6 Border Size

The **Border Size** generally allows the user to select an appropriate PIP border width. Setting the **Border Size** to OFF turns the PIP border off. Setting this parameter to small selects a thin border; middle will yield a medium size width; large is the maximum PIP border width.

### 3.2.7 Border Color

The user is allowed to assign a PIP border color. The available colors are listed as follows:

- White
- Yellow
- Cyan
- Green
- Magenta
- Red
- Blue
- Black

***\*Note: Select Input 4 if you would like to use the video source connected to the HDMI input.***

## 3.3 PIP Crop

The PIP Crop basically adjusts the PIP window borders. You can adjust each side individually (Left / Right / Top / Bottom) or all four sides at the same time (Size).



Option	Parameters	Parameter Value or Range	Default Value
PIP Crop	Size	0 – 100%	0
	Left	0 – 100%	0
	Right	0 – 100%	0
	Top	0 – 100%	0
	Bottom	0 – 100%	0

The effects of all parameters are described below:

- **Left** – Adjusts the position of the left edge of the PIP window.
- **Right** – Adjusts the position of the right edge of the PIP window.
- **Size** – Adjusts the PIP image crop size.
- **Top** – Adjusts the position of the top edge of the PIP window.
- **Bot** – Adjusts the position of the bottom edge of the PIP window.

### 3.4 Lumakey

Keyer of the HS-1500T provides the user with the capability of luma keying.

**Note: When PIP and Lumakey features are enabled at the same time, the lumakey source will be the upper layer and the PIP source will be the lower layer. The layer order cannot be changed.**

Option	Parameters	Parameter Value or Range	Default Value
Lumakey	Lumakey Source	Black Input 1 Input 2 Input 3 <b>Input 4*</b> Background Color Bar	Input 2
	Mode	Black White	Black
	Cleanup Level	0 – 100	20
	Transparency	0 – 64	64

#### 3.4.1 Lumakey Source

Lumakey source is where you can select the image for luma keying. The available sources are listed as follows:

- Black
- Input 1
- Input 2
- Input 3
- **Input 4\***
- Background
- Color Bar

#### 3.4.2 Mode

There are two modes available on the Luma Keyer. Select Black if the image is on a black background and white if the image is on a white background.

### 3.4.3 Cleanup Level

The **Cleanup Level** allows the user to fine tune the effect of the luma key. The default value is 20.

### 3.4.4 Transparency

In this option, you will be able to adjust the transparency of the overall foreground key image.

*\*Note: Select Input 4 if you would like to use the video source connected to the HDMI input.*

## 3.5 Audio

This option allows the user to configure various audio settings such as muting HDMI output audio, set the audio type, selecting your tally type and etc.

Option	Parameters	Parameter Value or Range	Default Value
Audio	Mute	OFF/ON	Off
	HDMI Input	Input 1-4 / Follow	Follow
	HDMI Group	Channel 1/2 Channel 3/4 Channel 5/6 Channel 7/8	Channel 1/2
	Level	Auto / SMPTE / EBU	Auto
	Tally Mode	Normal / Audio Mixer	Normal

### 3.5.1 Mute

The **Mute** allows you to turn ON/OFF the embedded audio component at the **HDMI-in**. The default is OFF.

### 3.5.2 HDMI Input

In this option, you can select the audio source. Selection of input 1-4 allows the HS-1500T to play the enabled audio source. If “**Follow**” is selected, the audio will enter Audio follow Video mode, i.e. playback of the audio of the output video.

### 3.5.3 HDMI Group

The HDMI Group allows the user to assign the HDMI audio channel. The default audio channel is Channel 1/2. Any audio channel pair of the four audio channel pairs can be selected.

### 3.5.4 Level

There are two different audio standards available for selection. The user can either select the EBU or SMPTE standard. By selecting AUTO allows the device to automatically detect the audio standard. When the image is 50 Hz, the audio follows EBU standard and when the image is 59.94/60 Hz, the audio follows SMPTE standard.

### 3.5.5 Tally Mode

Tally output port generally sends two tally signals to each channel. In Datavideo products, **Red** indicates On-Air, and **Green** indicates next camera source.

The HS-1500T provides **two tally modes**:

**Normal:** If in normal mode, tally lights of all camera sources displayed on the PGM monitor will be turned ON (Red). These sources include PGM, PIP and Key sources. While transition is in progress, the next video will be seen on the PGM monitor, tally light of the PVW source camera will thus also be turned ON (Red).

**Audio Mixer:** If Audio Mixer mode is selected, tally light of the PGM source camera selected on the keyboard panel will be turned ON (Red). While transition is in progress, the tally light color will remain unchanged. The tally light color will only change (red/green) after the transition of PGM and PVW views is complete.

### 3.6 User Mems

In “User Mems”, the user is allowed to **load** previously saved settings and **save** the currently configured settings.

Option	Parameters	Parameter Value or Range	Default Value
User Mems	Load Memory	User 1-6	
	Load		
	Save Memory	User 1-6	
	Save		

#### 3.6.1 Load Memory

Use the up/down arrow to select the desired memory location and load the saved setting by selecting “Load”.

**Tip:** The user can also press one of the USER memory shortcut buttons (1-3) on the control panel as a quick way of loading those previously saved User configurations. Use the **SHIFT** button to switch between **USER MEMORY 1-3** and **USER MEMORY 4-6**.

#### 3.6.2 Save Memory

Use the up/down arrow to select the desired memory location and save the current setting by selecting “Save”.

### 3.7 Setup

In the “Setup” menu, the user can change the **output resolution**, reset the HS-1500T to its **Factory Default** values, choose the preferred OSD menu **language**, **upgrade firmware** and view the **current firmware versions** (Mainboard and Keyboard).

Option	Parameters	Parameter Value or Range	Default Value
Setup	PGM Out Res.	1080p/60	
		1080p/59.94	
		1080p/50	
		1080i/60	
		1080i/59.94	
		1080i/50	
		720p/60	
		720p/59.94	
		720p/50	

		576i 480i	
	MV Out Res.	1080p/60 1080p/59.94 1080p/50 1080i/60 1080i/59.94 1080i/50 720p/60 720p/59.94 720p/50	
	Save Setup	[Save]	
	Factory Default	[Reset]	
	Language	English Simplified Chinese Traditional Chinese	
	MB Software	Version	
	KBD Software	Version	

### 3.7.1 PGM Out Res.

In **PGM Out RES.**, the user is allowed to select an appropriate PROGRAM output resolution. The available resolutions are listed as follows:

- 1080p/60
- 1080p/59.94
- 1080p/50
- 1080i/60
- 1080i/59.94
- 1080i/50
- 720p/60
- 720p/59.94
- 720p/50
- 576i
- 480i

Once done, simply go to **“Save Setup”** to confirm the selected output resolution.

**Note: Please make sure the output resolution is same as the input resolution to prevent unexpected issues.**

### 3.7.2 MV Out Res.

In **MV Out RES.**, the user is allowed to select an appropriate MULTIVIEW output resolution. The available resolutions are listed as follows:

- 1080p/60
- 1080p/59.94
- 1080p/50
- 1080i/60
- 1080i/59.94

- 1080i/50
- 720p/60
- 720p/59.94
- 720p/50

Once done, simply go to **“Save Setup”** to confirm the selected output resolution.

**Note:** The new resolution will be effective once selected. If you have selected a resolution that is not supported by the monitor, you will not be able to view the OSD menu. In this case, please reboot your machine to restore the default resolution previously configured in the **“Save Setup”** option.

### 3.7.3 Save Setup

In this option, select **“Save”** to save the current configuration.

### 3.7.4 Factory Default

**Reset:** Once selected, the factory default settings will be restored. The device will start the factory reset process in 2 to 3 seconds after **“Reset”** is selected.

### 3.7.5 Language

The available OSD menu languages are **English, Traditional Chinese and Simplified Chinese.**

### 3.7.6 MB and KBD Software

The **MB** and **KBD** software versions will be respectively displayed.

## 3.8 Camera

In the **“Camera”** menu, the user will be able to change the camera name, view camera information and perform some basic camera settings. The basic camera settings include the video format, mirror mode, PAN/TILT direction and etc.

Option	Sub-options	Parameters	Parameter Value or Range	
Camera	Camera CH. Setup	Yes/No		
	[PTC-150T-01/02/03]	Camera Info	Camera Name	
			Vendor ID	
			MB Version	
			FPGA Version	
			Motor Version	
	Video	Video Format	1080i/60 1080i/50 1080p/29.97 1080p/25 720p/59.94 720p/50 1080p/59.94 1080p/50	
		Mirror Mode	Off V H	

			H+V
			Joystick Pan Normal Reverse
			Joystick Tilt Normal Reverse
			Memory Speed 1-16
		Operator	Power On/Off
			R-Gain 0-255
			B-Gain 0-255
			Tally LED Off Red Green

### 3.8.1 Camera CH. Setup

By selecting this sub-option, you will be able to enable/disable the camera setup.

### 3.8.2 PTC-150T-01/02/03

The PTC-150T-01/02/03 options will allow you to configure basic settings of the respective cameras.

#### **Camera Info**

Selecting the “**Camera Name**” will open up a keyboard on which you will be able to rename the selected camera. Other parameters right below are simply information display such as **Vendor ID**, **MB Version**, **FPGA Version**, and **Motor Version**.

#### **Video**

In the “**Video**” sub-option, you will be able to configure the **Video Format**, **Mirror Mode**, **Joystick Direction** and **Joystick Speed**.

The available resolutions in the **Video Format** parameter are listed as follows:

- 1080i/60
- 1080i/50
- 1080p/29.97
- 1080p/25
- 720p/59.94
- 720p/50
- 1080p/59.94
- 1080p/50

In “**Mirror Mode**”, there are three types of modes available:

- V: Vertical mirroring
- H: Horizontal mirroring
- H+V: Horizontal and Vertical mirroring

In **Joystick Pan/Tilt**, you can either select the normal PAN/TILT direction or reverse the PAN/TILT direction. The PAN/TILT speed can be configured in **Memory Speed**, which ranges from 1-16.

### ***Operator***

The **Operator** sub-option offers the user basic camera operation functions. Parameters of this sub-option are described below:

**“Power”** basically turns ON/OFF the selected camera.

**R-Gain/B-Gain:** The red and blue components can be adjusted, ranging from 0 to 255.

**Tally LED:** You can either turn the tally light off or enable the red or green tally light.

## Chapter 4 Monitor



The HS-1500T Monitor can be configured via an on screen menu. When the **MENU** button is pressed the Main Menu list is displayed on the monitor.

This section covers the Menu options in the order that they appear on the monitor. These settings may also appear in more detail elsewhere in this instruction manual. Options may vary depending on the firmware version in use.

Once the chosen setting has been confirmed with the **ENTER** button, it is stored within the switcher's non-volatile memory.

### 4.1 MENU Options

Main Options	Sub Options	Parameters	Parameters
MAIN ADJUST	BRIGHTNESS	0~100	
	CONTRAST	0~100	
	SHARPNESS	0~100	
	SATURATION	0~100	
	TINT	0~100	
	BACKLIGHT	0~100	
	NR	HIGH / MID / LOW / OFF	
	DLC	ENABLE / DISABLE	
	VOLUME	0~100	
	EXIT		
COLOR	6500		
	9300		
	7500		
	USER COLOR	RED	0~100
		GREEN	0~100
BLUE		0~100	
EXIT			
SCAN SETTING	UNDER SCAN	Full Image	
	OVER SCAN	Cropped Image	
INFORMATION	H. FREQUENCY		
	V. FREQUENCY		
	RESOLUTION		
	VER.		
LANGUAGE	English [default]		
	Francis		
	Deutsch		
	Español		
	Italiano		
	Dutch		
	Português		
	Russian		
EXIT			



SPECIAL FUNCTION	OSD TIMEOUT	5-120 SEC	
	FRAME RATIO	80 / 90 / OFF	
	4:3 MARK LINE	ON / OFF	
	CENTRAL MARK	ON / OFF	
	CINEMA ZONE MARK	ON / OFF	
	AUDIO CHANNEL L*		
	AUDIO CHANNEL R*		
	EXIT		
FACTORY RESET			
EXIT			

\* Selectable on PGM only; external HDMI and MV are allowed on 1 and 2 ONLY.

#### 4.1.1 MAIN ADJUST

After pressing the **MENU** button on the monitor control panel, the first menu option highlighted is the **MAIN ADJUST** option.

Press **ENTER** to access the **MAIN ADJUST** Menu and the **Brightness** option will be highlighted.

To adjust the **Brightness**, press **Enter** again. Use the **Up / Down** buttons to change the value and then press **Enter** to store the new value and return to the main menu.

To configure other settings such as **Contrast, Saturation, Sharpness, TINT** and etc, use the **Up / Down** buttons to select the desired option. Follow the above procedure to set the new value.

#### 4.1.2 COLOR

Press **ENTER** to access the **COLOR** menu and the first option will be highlighted.

Press **ENTER** to select the first color option.

Use the **Up / Down** buttons to navigate the available color options listed as follows.

- **7500**
- **9300**
- **6500**
- **USER COLOR**

#### 4.1.3 Information

The **System Information** displays **Horizontal Frequency, Vertical Frequency, Resolution** and the Firmware Version (**Ver.**) of the monitor.

Once selected, the information below will be displayed.

- **H. FREQUENCY:** 33.7KHZ
- **V. FREQUENCY:** 60.0HZ
- **RESOLUTION:** 1920X1080I
- **VER.:** 0.11

#### 4.1.4 Special Function

In the **Special Function**, you will be able to configure **OSD TIMEOUT, Frame Ratio, 4:3 MARK LINE, Central Mark, Cinema Zone Mark** and **Audio Channel L & R**.

Use the **Up / Down** buttons to navigate the available options listed as follows. Press **ENTER** to access a particular option.

<b>OSD TIMEOUT</b>	5-120 SEC
<b>FRAME RATIO</b>	90 / 80 / OFF
<b>4:3 MARK LINE</b>	ON / OFF
<b>CENTRAL MARK</b>	ON / OFF
<b>CINEMA ZONE MARK</b>	ON / OFF
<b>AUDIO CHANNEL L*</b>	1/2/3/4
<b>AUDIO CHANNEL R*</b>	1/2/3/4

#### 4.1.5 Factory Reset

The monitor menu offers a **Factory Reset** option, which will return all the monitor settings to the factory defaults

To reset the monitor, press the **MENU** button and then use the **UP / Down** buttons to navigate to the **FACTORY RESET** option. Press **ENTER** again to reset the monitor. After a few seconds, the monitor settings will return to factory defaults.

## 4.2 Firmware update procedure

From time to time Datavideo may release new firmware to either add new features or to fix reported bugs in the current **HS-1500T** Monitor firmware. Customers can update the firmware themselves if they wish or they can contact their local dealer or reseller for assistance should they prefer this method.

This section describes the firmware update process and it should take **approximately 15 minutes total time to complete**. Once started **the update process should not be interrupted in any way** as this could result in a non-responsive unit.

#### To update the HS-1500T Monitor, you will need:

- The latest firmware update for the **HS-1500T Monitor**.  
This firmware file can be obtained from your local Datavideo office or dealer.
- USB 2.0 pen drive with a USB A connector.

#### How to update the firmware

1. Unzip / extract the supplied zipped archive or rar folder.
2. Wipe the contents of the USB 2.0 pen drive so it is empty.
3. Transfer / copy the unzipped / extracted file to the USB 2.0 pen drive; make sure the file name is renamed to **MSTFLASH.bin**.
4. Plug the USB 2.0 pen drive into the USB 2.0 port labelled **MONITOR F/W UPGRADE** on the front of the monitor button panel.
5. Reboot **HS-1500T** and the update will start automatically.
6. The **HS-1500T Monitor** will reboot itself at the end of the process.



**Note: The USB port can also be used to power the connected USB LED light.**

## Chapter 5 Applications

### 5.1 Placing a logo on the video using the lumakey function

The HS-1500T allows the user to place a logo on the video using the lumakey function. First of all, create a 1920x1080 (16:9) logo against a black or white background on a laptop. Once the logo is created, please follow the steps outlined as follows to insert the logo layer.

**Note: If the logo is dark, choose a white background; if the logo consists primarily of bright colors, choose a black background.**

1. Connect the laptop to the switcher's **HDMI Input Port**.
2. Press the **MENU** button to open the OSD Menu on the four-quadrant Multiview display.
3. In the **Lumakey** option, set the "**Lumakey Source**" to **Input 4**.
4. In this example, the logo is against a black background so **Black Mode** is chosen.
5. Set the "**Cleanup Level**" to 10 if the background is in total black.
6. "**Transparency**" is set to 64 if an opaque logo is desired. **Opaque** logo can be created by setting the "**Transparency**" parameter to 64. **Semi-transparency** effect can be generated by setting the "**Transparency**" parameter to a value between 0 and 64.
7. Exit the menu after the Logo is properly configured.
8. Press the **Luma Key PGM** button to place the logo on the Program screen or the **Luma Key PVW** button to place the logo on the Preview screen.

### 5.2 Connecting PTC-150T Cameras

DVIP is a communication interface that allows the user to control multiple PTC-150T cameras remotely. Follow the steps outlined below to set up your PTC-150T cameras with the HS-1500T.

1. Locate the DIP switch at the bottom of the PTC-150T camera



2. Set DIP Switch positions 1 and 4 to ON

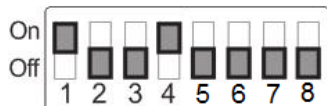

3. Power **ON** the PTC-150T PTZ Camera.
4. Open the main menu by pressing the **MENU** button on the HS-1500T's keyboard panel and select option 4 "**Remote Control**".

```
[MAIN MENU]
1: CAMERA SET (NORMAL)
2: MEMORY
3: VIDEO OUTPUT
4: REMOTE CONTROL
5: SYSTEM
```

```
6: CAMERA SET (ADVANCE)
7: RESET P/T/Z
8: ESCAPE
```

5. Select “**SET DVIP**” to configure the DVIP port

```
[REMOTE CONTROL]
1: PAN/TILT REVERSE: P+T
2: REMOTE SOURCE: DVIP, SW
3: SET RS422
4: SET DVIP
5: SET IR
6: PTZ INFO. OUTPUT: OFF
7: ESCAPE
```

6. Set the **DVIP baud** to 115200

```
[SET DVIP]
1: DVIP BAUDRATE: 115200
2: ESCAPE
```

7. Connect the PTC-150T to the HS-1500T, which should automatically assign an IP to the PTC-150T.

# Chapter 6 Appendices

## Appendix 1 Tally Outputs

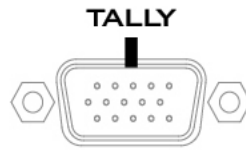

The HS-1500T has a D-sub 15 pin female tally output port. These connections provide bi-colour tally information to a number of other Datavideo products, such as the ITC-100 eight channel talkback system and the TLM range of LCD Monitors. The ports are open collector ports and as such do not provide power to tally light circuits.

The pin outputs are defined as follows:

PIN No.	Signal Name	Input/Output	Description of Signal
1	Program 1	Open collector output	Tally output of input video Program 1
2	--	--	No Function
3	Preview 1	Open collector output	Tally output of input video Preview 1
4	RCOM (GND)	Ground	Ground
5	Program 4	Open collector output	Tally output of input video Program 4
6	Program 2	Open collector output	Tally output of input video Program 2
7	--	--	No Function
8	Preview 2	Open collector output	Tally output of input video Preview 2
9	GND	Ground	Ground
10	- -	- -	No Function
11	Program 3	Open collector output	Tally output of input video Program 3
12	- -	- -	No Function
13	Preview 3	Open collector output	Tally output of input video Preview 3
14	YCOM (GND)	Ground	Ground
15	Preview 4	Open collector output	Tally output of input video Preview 4

## Appendix 2 Firmware Upgrade

Datavideo usually releases new firmware containing new features or reported bug fixes from time to time. Customers can either download the HS-1500T firmware as they wish or contact their local dealer or reseller for assistance.

This section outlines the firmware upgrade process which should take **approximately 10 minutes to complete**. The existing HS-1500T settings should persist through the **firmware upgrade process, which should not be interrupted once started** as this could result in a non-responsive unit.

### Successful firmware upgrade on HS-1500T requires:

- HS-1500T x 1
- 48V Power adapter x 1
- USB thumb drive x 1
- USB Cable x 1

### Update Procedure

1. On the PC, copy the two HS-1500T firmware binary files to the root directory of a USB thumb drive. After the files are successfully copied, safely remove the USB thumb drive from the PC.
  - **HS-1500T.bin**: The HS-1500T Keyboard (KB) Firmware is approximately 27KB and usually with a version number of V1.X.
  - **HS-1500TM.bin**: The firmware file for the HS-1500T Mainboard (MB) and OSD MENU fonts is approximately 2-3 MB (Example of the firmware display is V1.16 for the mainboard and V1.02 for OSD fonts).
2. Connect the USB thumb drive to the F/W Upgrade USB port located on the back of the HS-1500T device.

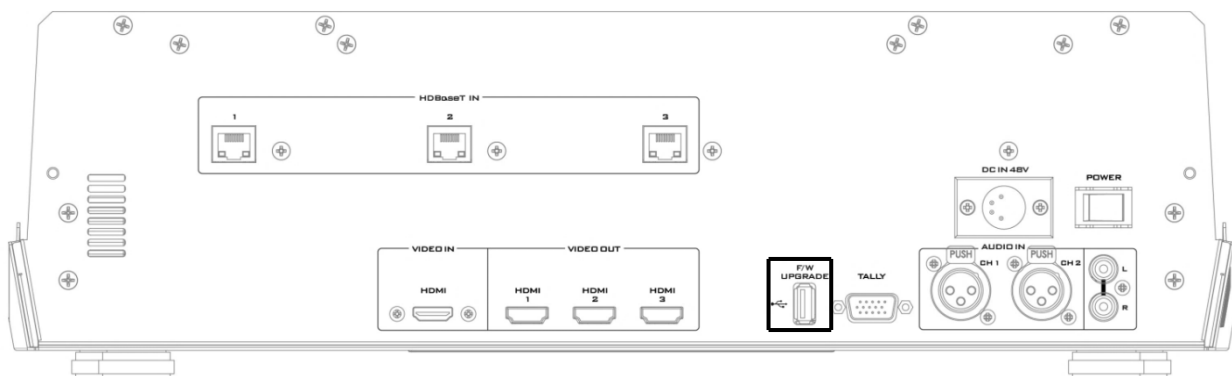

3. Turn on the HS-1500T power.
4. Approximately after 5 seconds, the keyboard firmware will be updated and the update status will be indicated by the LED color of the program row buttons.
  - **Same version number** detected: The firmware will **NOT** be updated and all six buttons will be illuminated red.
  - **Different version number** detected: The BLK button flashes red twice and the firmware will be updated. All six program row buttons will be illuminated red while the firmware is being updated. As soon as the program row buttons are turned off and then turned back on (red) again, the firmware update is complete. The HS-1500T automatically reboots itself after the keyboard

firmware is updated.

5. The Mainboard firmware is automatically updated after the Step 4 is executed and the update status will be indicated by the LED color (green) of the preview row buttons. Approximately 5 seconds after the HS-1500T is rebooted, you will see a startup screen on the monitor with old mainboard version (V1.5) displayed at the bottom right corner. At this point, the BLK button will start flashing green. The mainboard firmware update will start approximately 10 seconds after the mainboard finishes booting.

The startup screen on the monitor disappears and the firmware update will be in progress as the preview row buttons are turned on one at a time from left to right until all buttons are illuminated constant green after approximately **ONE minute**. At this point, the firmware update is complete and the mainboard will reboot itself. After the HS-1500T finishes booting, the new version number (V1.6) will be displayed at the bottom right corner of the HS-1500T startup screen.

6. The OSD fonts will be automatically updated after the Step 5 is executed and the update status will be indicated by the LED color (green) of the preview row buttons. The machine reboots itself after the mainboard is updated, and the BLK button will start flashing green after the reboot. The OSD fonts update will start approximately 10 seconds after the mainboard finishes booting.

The startup screen on the monitor disappears and the firmware update will be in progress as the preview row buttons are turned on one at a time from left to right until all buttons are illuminated constant green after approximately **SIX minutes**. At this point, the monitor will display a four-quadrant Multiview display and this indicates that the OSD fonts update is complete.

7. The update is finished when all six buttons of the program and preview rows are illuminated constant red and green respectively. Remove the USB thumb drive and reboot the HS-1500T.

8. After the machine finishes booting and as soon as you see the Multiview screen, press the MENU button to open the OSD menu to check the MB, OSD and KB versions: Use the Up/Down arrow buttons to move to the Setup option and check if the firmware is successfully updated:

- MB Software: V1.16.1.02
- KBD Software: V1.2 (HS-1500T)

**Note 1:** The device will not be damaged if the USB cable or power is accidentally disconnected while the firmware is being updated; plug the USB thumb drive back in and reboot the device to resume the update process.

**Note 2:** The USB disk drive system supports FAT / FAT32 formats.

**Note 3:** There is no guarantee that the HS-1500T supports all USB disks. When you see all buttons of the program and preview rows are illuminated pink or greenish pink, this indicates that the disk file read error has occurred. Please try using other USB flash drive brands.

## Appendix 3      Frequently-Asked Questions

This section describes problems that you may encounter while using HS-1500T. If you have any questions, please refer to related sections and follow all suggested solutions. If problem still exists, please contact your distributor or the service center.

No.	Problems	Solutions
1.	Audio is switched only after the transition is complete.	It is normal that audio is switched after the transition is complete regardless of the transition method (T-Bar or Auto) used.
2.	Jitter is seen on moving images.	Please make sure the input and output are set to the same resolution and frame rate.



## Appendix 4 Tips for Establishing an HDBaseT Compliance Environment and Ethernet Cable Selection

### Tips for Establishing an HDBaseT Compliance Environment

HDBaseT alliance defines the maximum number of cables in a bundle use case to be six cables per bundle. Table below defines the maximum number of cables in a bundle as a function of cable type & the overlapping length.

**HDBaseT Cabling-Permissible Number of Cables in a Bundle**

Type	30m	50m	70m	100m
CAT5e/6	6	4	2	1
CAT6a/7	6	6	6	6

The following installation practices can help to withstand the external interference when using CAT5e/6 cables:.

- A ) Do not “comb” or “pinstripe” cables in the first 20 meters.
- B ) Use separate patch and equipment cords in the first 20 meters.
- C ) Avoid use of tie-wraps.
- D ) Use horizontal wire management techniques. For example, route odd ports to upper management and even ports to lower management.
- E ) Loosely place cables in vertical wire management.
- F ) Reduce maximum conduit fill density to 40%.
- G ) It is recommended to roll the cable around a fixed radius drum in an orderly manner. This is shown on the left hand side of below. When the turns are ordered, the electromagnetic coupling between the various sections that occurs in a randomly rolled cable is reduced. The FEXT impairment level measured when rolling an Ethernet cable around a 70 cm fixed diameter plastic drum is only slightly higher than that of a fully stretched cable.

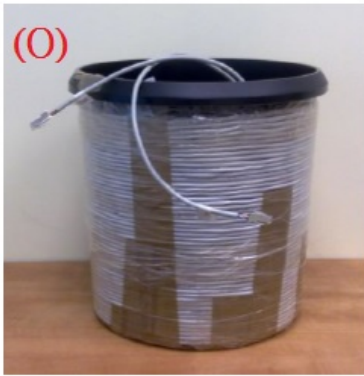

### Tips for Establishing an HDBaseT Compliance Environment Outdoors/for the Strong Interference Environment

1. If customers want to establish an HDBaseT compliance environment outdoors, it is recommended that customers can use the UV resistant Ethernet cable to make sure that the Ethernet cable achieves its best connection quality. Generally speaking, the outdoor UV resistant Ethernet cable is coated with the black PE skin.

2. If there is any interference source at the customer side such as the radio interference, it is highly recommended to adopt the SFTP\* to prevent the Ethernet cable from interference.

\*SFTP: The SFTP(Shielded and Foiled Twisted Pair) is an Ethernet cable with foil shielding around the individual twisted wires and an overall shield which can be a flexible braid. This provides highest protection for the Ethernet cable to prevent it from interference.

### Tips for the Ethernet Cable Selection for the HDBaseT System & Camera Connection

1. Please use the solid conductors rather than the stranded conductors for the HDBaseT system network connection due to that the solid conductors have better electrical performance than the stranded conductors.



2. Please Do NOT use the flat ethernet cable due to following reasons.

A) There is no twisted paired inside the flat ethernet cable to offset the interference.

B) There is no cross-spacer between the cables inside the flat ethernet cable.

C) The diameter of each core can not meet the AWG standard due to cut corners.

- For the CAT5e cable, the diameter for most of the flat Ethernet cables can not meet the 24AWG (0.49~0.51mm) standard and the bandwidth can not meet the 125MHz standard.
- For the CAT6/CAT6a cable, the diameter for most of the flat Ethernet cables can not meet the 23AWG standard and the bandwidth can not meet the 250MHz standard.
- For the CAT7 cable, the diameter for most of the flat Ethernet cables can not meet the 22AWG standard and the bandwidth can not meet the 600MHz standard.

D) For many of the multicore Ethernet cables, the solid conductor for each core is made by the aluminum wire, copper-clad aluminum wire or copper-clad steel wire rather than the anaerobic copper wire.

3. Please visit the website "<http://hdbaset.org/hdbaset-recommended-cables/>" for the ethernet cable providers that are verified by the HDBaseT alliance.

4. For more information about how to establish the HDBaseT environment and the detail about the usage, please visit and register on the website "<http://hdbaset.org/installers/>" to get the free membership.

## Appendix 5      Dimensions

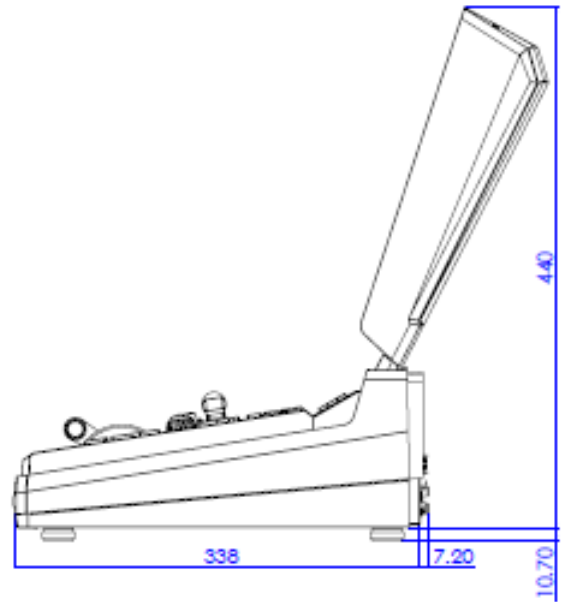
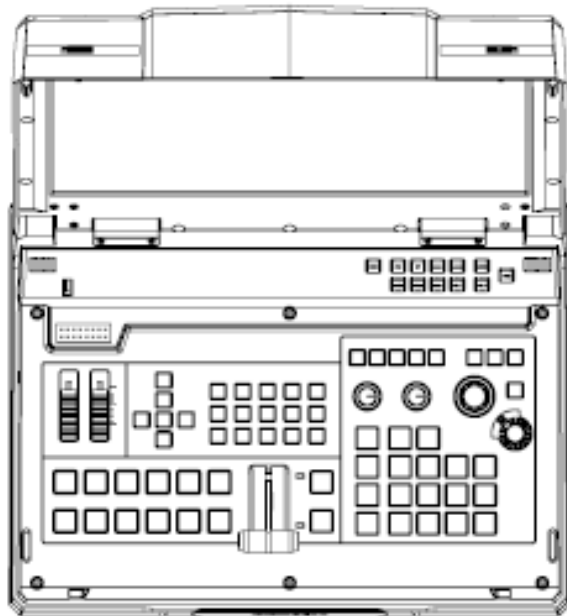
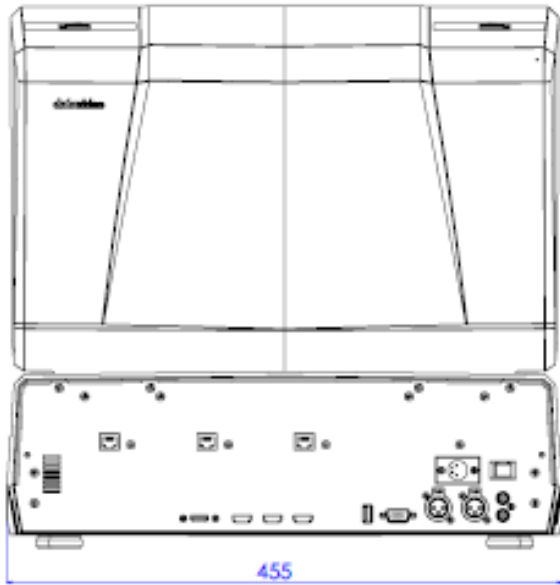

All measurements in millimeters (mm)

## Appendix 6 Specifications

<b>Interfaces</b>	
Video Inputs	3 x HDBaseT LAN Port (for PTC-150T) 1 x HDMI
Video Outputs	3 x HDMI
Audio Inputs	1 x Stereo RCA (L/R) 2 x XLR Balanced Audio Input De-embedded Digital Audio (2 CH)
Tally	Yes / D-Sub 15 male connector
Software Update	USB Port
<b>Monitor</b>	
LCD Display	17.3"
Resolution	1920 x 1080 pixel
Brightness	300 cd/m <sup>2</sup>
Contrast	400 : 1
View Angle	Top : 70 deg / Bottom : 70 deg Left : 60 deg / Right : 60 deg
<b>Standards</b>	
PTC-150T Input Resolution	1920 x 1080p 60/50/30/25 1920 x 1080i 60/50 1280 x 720p 60/50
HDMI Input Resolution	VGA, XGA (1024 x 768), SXGA (1280 x 1024), UXGA (1600 x 1200), WUXGA (1920 x 1200) 1920 x 1080p 60/59.94/50 1920 x 1080i 60/59.94/50 1280 x 720p 60/59.94/50 480i/p, 576i/p
HDMI Output Resolution	1920 x 1080p 60/59.94/50 1920 x 1080i 60/59.94/50 1280 x 720p 60/59.94/50 480p, 576p
Audio Format Support	PCM LPCM 2CH 6CH 8CH
<b>Audio</b>	
Audio Fader	1 VR (Master Audio Output)
Audio LED Meter	2 Rows (Left / Right)
Headphone	¼" ( 6.3mm ) Stereo Headphone Socket

<b>Switcher Function</b>	
Keyers	Luma Keyer
PIP	Yes
Split	Yes
Transition	WIPE / MIX / Fade / CUT
<b>Camera Control Function</b>	
PAN / TILT / ZOOM	Yes
Iris / Focus	Yes
<b>General</b>	
Operating Temperature	0°C to 40°C (32°F to 104°F)
Humidity	10% to 80%
Voltage	DC 48V/190W (48V/4.16A)
Weight	7.6 Kg

# Service & Support

It is our goal to make owning and using Datavideo products a satisfying experience. Our support staff is available to assist you to set up and operate your system. Contact your local office for specific support requests. Plus, please visit [www.datavideo.com](http://www.datavideo.com) to access our FAQ section.

**China Shanghai**  
Datavideo Technologies China Co  
601, Building 10, No. 1228,  
Rd. Jiangchang,  
Jingan District, Shanghai  
Tel: +86 21-5603 6599  
Fax: +86 21-5603 6770  
E-mail: [service@datavideo.cn](mailto:service@datavideo.cn)

**China Beijing**  
Datavideo Technologies China Co  
No. 812, Building B, Wankai Center,  
No. 316, Wan Feng Road, Fengtai District,  
Beijing, China  
Tel: +86 10-8586 9034  
Fax: +86 10-8586 9074  
E-mail: [service@datavideo.cn](mailto:service@datavideo.cn)

**China Chengdu**  
Datavideo Technologies China Co  
B-823, Meinian square, No. 1388,  
Middle of Tianfu Avenue, Gaoxin District,  
Chengdu, Sichuan  
Tel: +86 28-8613 7786  
Fax: +86 28-8513 6486  
E-mail: [service@datavideo.cn](mailto:service@datavideo.cn)

**China Fuzhou**  
Datavideo Technologies China Co  
A1-2318-19 Room, No. 8, Aojiang Road,  
Taijiang District, Fuzhou, Fujian, China  
Tel: 0591-83211756 · 0591-83210187  
Fax: 0591-83211262  
E-mail: [service@datavideo.cn](mailto:service@datavideo.cn)

**China Jinan**  
Datavideo Technologies China Co  
902, No. 1 business building,  
Xiangtai Square, No. 129,  
Yingxiongshan Road, Shizhong District,  
Jinan City, Shandong Province, China  
Tel: +86 531-8607 8813  
E-mail: [service@datavideo.cn](mailto:service@datavideo.cn)

**Hong Kong**  
Datavideo Hong Kong Ltd  
G/F., 26 Cross Lane  
Wanchai, Hong Kong  
Tel: +852-2833-1981  
Fax: +852-2833-9916  
E-mail: [info@datavideo.com.hk](mailto:info@datavideo.com.hk)

**India Noida**  
Datavideo India Noida  
A-132, Sec-63, Noida-201307,  
India  
Tel: +91-0120-2427337  
Fax: +91-0120-2427338  
E-mail: [sales@datavideo.in](mailto:sales@datavideo.in)

**India Kochi**  
Datavideo India Kochi  
2nd Floor- North Wing, Govardhan Building,  
Opp. NCC Group Headquarters, Chittoor Road,  
Cochin- 682035  
Tel: +91 4844-025336  
Fax: +91 4844-047696  
E-mail: [sales@datavideo.in](mailto:sales@datavideo.in)

**Netherlands**  
Datavideo Technologies Europe BV  
Floridadreef 106  
3565 AM Utrecht,  
The Netherlands  
Tel: +31-30-261-96-56  
Fax: +31-30-261-96-57  
E-mail: [info@datavideo.nl](mailto:info@datavideo.nl)

**Singapore**  
Datavideo Visual Technology(S) Pte Ltd  
No. 178 Paya Lebar Road #06-07  
Singapore 409030  
Tel: +65-6749 6866  
Fax: +65-6749 3266  
E-mail: [info@datavideovirtualset.com](mailto:info@datavideovirtualset.com)

**Singapore**  
Datavideo Technologies (S) PTE Ltd  
No. 178 Paya Lebar Road #06-03  
Singapore 409030  
Tel: +65-6749 6866  
Fax: +65-6749 3266  
E-mail: [sales@datavideo.sg](mailto:sales@datavideo.sg)

**Taiwan**  
Datavideo Technologies Co. Ltd  
10F. No. 176, Jian 1st Rd., Chung Ho  
District, New Taipei City 235, Taiwan  
Tel: +886-2-8227-2888  
Fax: +886-2-8227-2777  
E-mail: [service@datavideo.com.tw](mailto:service@datavideo.com.tw)

**United States**  
Datavideo Corporation  
7048 Elmer Avenue.  
Whittier, CA 90602,  
U.S.A.  
Tel: +1-562-696 2324  
Fax: +1-562-698 6930  
E-mail: [sales@datavideo.com](mailto:sales@datavideo.com)

**United Kingdom**  
Datavideo UK Limited  
Brookfield House, Brookfield Industrial  
Estate, Peakdale Road, Glossop,  
Derbyshire, SK13 6LQ  
Tel: +44-1457 851 000  
Fax: +44-1457 850 964  
E-mail: [sales@datavideo.co.uk](mailto:sales@datavideo.co.uk)

**France**  
Datavideo France s.a.r.l.  
Cit  Descartes 1, rue Albert Einstein  
Champs sur Marne 774477 –  
Marne la Vall e cedex 2  
Tel: +33-1-60370246  
Fax: +33-1-60376732  
E-mail: [info@datavideo.fr](mailto:info@datavideo.fr)



Please visit our website for latest manual update.  
[www.datavideo.com/product/HS-1500T](http://www.datavideo.com/product/HS-1500T)

**datavideo**  
[www.datavideo.com](http://www.datavideo.com)