

USER MANUAL

MODEL:

VM-4DT
1:4 HDBT Distributor



Contents

Introduction	1
Getting Started	1
Overview	2
Typical Applications	3
About HDBase™ Technology	3
Using Twisted Pair Cable for HDBT	3
Defining the VM-4DT 1:4 HDBT Distributor	4
Connecting the VM-4DT	5
Operating the VM-4DT	6
Routing the IR and RS-232 Signals	6
Acquiring an EDID	9
Upgrading the Firmware	10
Default EDID	11
Technical Specifications	13
Default Communication Parameters	14
Protocol 3000	15
Understanding Protocol 3000	16
Kramer Protocol 3000 Syntax	17
Protocol 3000 Commands	18

Introduction

Welcome to Kramer Electronics! Since 1981, Kramer Electronics has been providing a world of unique, creative, and affordable solutions to the vast range of problems that confront the video, audio, presentation, and broadcasting professional on a daily basis. In recent years, we have redesigned and upgraded most of our line, making the best even better!

Our 1,000-plus different models now appear in 14 groups that are clearly defined by function: GROUP 1: Distribution Amplifiers; GROUP 2: Switchers and Routers; GROUP 3: Control Systems; GROUP 4: Format/Standards Converters; GROUP 5: Range Extenders and Repeaters; GROUP 6: Specialty AV Products; GROUP 7: Scan Converters and Scalers; GROUP 8: Cables and Connectors; GROUP 9: Room Connectivity; GROUP 10: Accessories and Rack Adapters; GROUP 11: Sierra Video Products; GROUP 12: Digital Signage; GROUP 13: Audio; and GROUP 14: Collaboration.

Getting Started

We recommend that you:

- Unpack the equipment carefully and save the original box and packaging materials for possible future shipment.
- Review the contents of this user manual.



Go to www.kramerav.com/downloads/VM-4DT to check for up-to-date user manuals, application programs, and to check if firmware upgrades are available (where appropriate).

Achieving the Best Performance

- Use only good quality connection cables (we recommend Kramer high-performance, high-resolution cables) to avoid interference, deterioration in signal quality due to poor matching, and elevated noise levels (often associated with low quality cables).
- Do not secure the cables in tight bundles or roll the slack into tight coils.
- Avoid interference from neighbouring electrical appliances that may adversely influence signal quality.
- Position your Kramer **VM-4DT** away from moisture, excessive sunlight and dust.



This equipment is to be used only inside a building. It may only be connected to other equipment that is installed inside a building.

Safety Instructions



- Caution:** There are no operator serviceable parts inside the unit.
- Warning:** Use only the power cord that is supplied with the unit.
- Warning:** Do not open the unit. High voltages can cause electrical shock! Servicing by qualified personnel only.
- Warning:** Disconnect the power and unplug the unit from the wall before installing.

Recycling Kramer Products

The Waste Electrical and Electronic Equipment (WEEE) Directive 2002/96/EC aims to reduce the amount of WEEE sent for disposal to landfill or incineration by requiring it to be collected and recycled. To comply with the WEEE Directive, Kramer Electronics has made arrangements with the European Advanced Recycling Network (EARN) and will cover any costs of treatment, recycling and recovery of waste Kramer Electronics branded equipment on arrival at the EARN facility. For details of Kramer's recycling arrangements in your particular country go to our recycling pages at www.kramerav.com/support/recycling/.

Overview

Congratulations on purchasing your Kramer **VM-4DT 1:4 HDBT Distributor**.

VM-4DT is a high-quality integrated extension product featuring a long-reach 4K@60Hz (4:2:0) HDBaseT extender distributor that takes one long-reach HDBaseT input, equalizes and reclocks the signal and distributes it to four identical HDBaseT outputs. **VM-4DT** distributes native HDBaseT signals with up to 4K video resolution, along with their re-extension over HDBaseT.

VM-4DT is a standard extender that can connect to any market-available HDBaseT compliant extending products.

VM-4DT provides exceptional quality and user-friendly operation.

Exceptional Quality

- Line Extender Distributor – Native 1:4 long-each HDBaseT distributor for deploying mid-way between AV source and distributed-signal displays to gain extra long-reach extension.
- High-quality professional extension, on either input or output lines, of maximum 4K @60Hz (4:2:0) 24bpp video resolution signal to a maximum of 40m (130ft) long-reach over Kramer HDBaseT compliant copper cable.



Reach depends on signal resolution, and quality of copper cable used. Reach extension performance may vary while using non-Kramer twisted pair cables.

- HDMI Signal Transmission – HDMI 2.0 and HDCP 1.4 compliant signal, supporting deep color, x.v.Color™, lip sync, HDMI uncompressed audio channels, Dolby TrueHD, DTS-HD, CEC (OUT 1 only), 2K, 4K, and 3D.
- I-EDIDPro™ Kramer Intelligent EDID Processing™ – An intelligent EDID handling, processing and pass-through algorithm that ensures Plug and Play operation for HDMI source and display systems.

User-friendly Operation

- LED Indicators – Status indicators for HDBaseT input and output connected signals, including far-end active device connection, and a power indicator, easily maintaining and troubleshooting the extended system end-to-end.
- Easy Installation – Twisted-pair cables for HDBaseT signal wiring. Standard half-width 19" (1U) enclosure for ceiling mounting, or side-by-side mounting of 2 units in a 1U rack space with the optional **RK-1** rack adapter.
- A default EDID for fast and efficient connection of the unit. The default EDID feature lets you connect the **VM-4DT** without having to connect a display to the output.
- Supports EDID Designer and firmware upgrade via the USB port.
- Includes an EDID setup button to capture the EDID or select the default EDID.

Typical Applications

The **VM-4DT** is ideal for the following typical applications:

- Native AV signal re-extension and distribution in large rooms.
- Corporate, education, hospitality, and government market segments.

About HDBaseT™ Technology

HDBaseT™ is an advanced all-in-one connectivity technology (supported by the HDBaseT Alliance). It is particularly suitable in the ProAV – and also the home – environment as a digital networking alternative, where it enables you to replace numerous cables and connectors by a single LAN cable used to transmit, for example, uncompressed full high-definition video, audio, IR, as well as various control signals.

Using Twisted Pair Cable for HDBT

Kramer engineers have developed special twisted pair cables to best match our digital twisted pair products that significantly outperform regular CAT 5 / CAT 6 cables.



We strongly recommend that you use shielded twisted pair cable. For details, go to our website at www.kramerav.com/product/VM-4DT.

Defining the VM-4DT 1:4 HDBT Distributor

This section defines the **VM-4DT**.

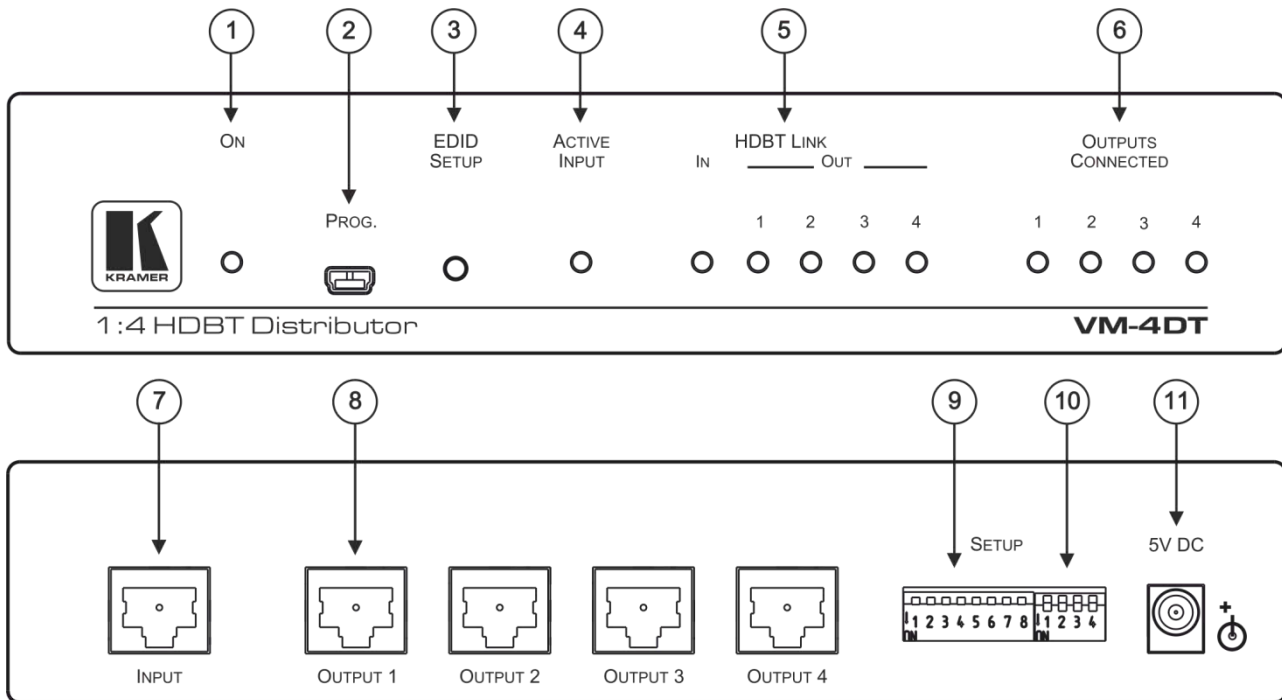







Figure 1: VM-4DT 1:4 HDBT Distributor Front Panel

#	Feature	Function	
①	ON LED	Lights when the unit receives power.	
②	PROGRAM Mini USB Connector	Use to send serial commands, see Protocol 3000 on page 15. Connect to a PC to perform firmware upgrades (via K-Upload) and work with the EDID Designer. K-Upload and EDID Designer can be downloaded from our Web site at: www.kramerav.com/support/product_downloads.asp .	
③	EDID SETUP Button	Press to capture the input EDID or select the default EDID, see Acquiring an EDID on page 9.	
④	ACTIVE INPUT LED	Lights when an HDMI signal is embedded on the HDBaseT input	
⑤	HDBT LINK LEDs	IN	Lights when a link is established with the transmitter.
		OUT	Lights when a link is established with the receiver (from 1 to 4).
⑥	OUTPUTS CONNECTED LEDs	Lights when an acceptor (sink) is detected on the HDBaseT receiver connected to the output (from 1 to 4)	
⑦	INPUT HDBT Connector	Connects to the HDBT source, for example TP-580T .	
⑧	HDBT OUT Connectors	Connect to an HDBT acceptor (from 1 to 4), for example TP-580R .	
⑨	SETUP 8-way DIP-switches	Used to set the IR and RS-232 command behavior, see Setting the DIP-Switches for Routing on page 6.	
⑩	SETUP 4-way DIP-switch	For future use.	
⑪	5V DC Connector	Connects to the 5V DC power supply.	

Connecting the VM-4DT

 Always switch off the power to each device before connecting it to your **VM-4DT**. After connecting your **VM-4DT**, connect its power and then switch on the power to each device.

To connect the **VM-4DT** as illustrated in the example in [Figure 2](#):

1. Connect the HDBT input source (for example, **TP-580T**) to the HDBT IN connector .
2. Connect the four HDBT outputs  to four HDBT receivers (for example, **TP-580R** devices).
3. Connect the 5V DC power adapter to the power socket  unit and then connect the adapter to the mains electricity (not shown in [Figure 2](#)). The ON LED lights .

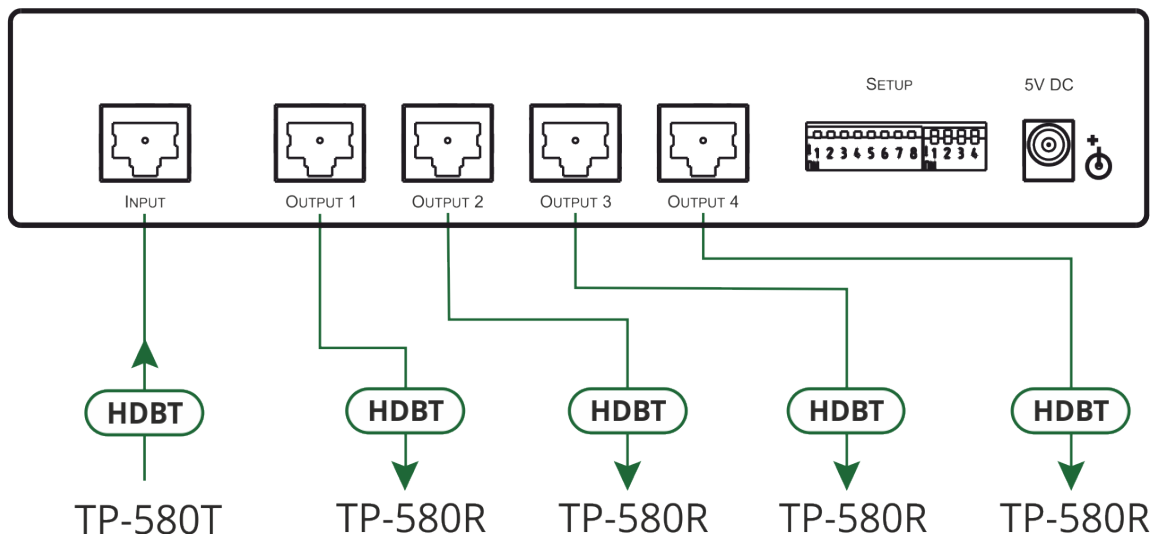

Figure 2: Connecting to the VM-4DT Rear Panel

Operating the VM-4DT

This section describes how to:

- Route the IR and RS-232 signals via the HDBT ports (see [Routing the IR and RS-232 Signals](#) on page 6).
- Acquire the EDID (see [Acquiring an EDID](#) on page 9).
- Perform firmware upgrade via K-Upload (see [Upgrading the Firmware](#) on page 10).

Routing the IR and RS-232 Signals

VM-4DT transports IR and RS-232 signals between the HDBT input and the four HDBT outputs. Each signal can pass bidirectional commands via the **VM-4DT** HDBT ports (one input and four outputs).

The IR/RS-232 signal routing is set via the SETUP DIP-switches ⑨.

Setting the DIP-Switches for Routing

Set the DIP-switches as defined by the following table:

Output #	IR Routing is enabled when:	RS-232 Routing is enabled when:
OUT 1	DIP 1 – OFF (up)	DIP 5 – OFF (up)
OUT 2	DIP 2 – OFF (up)	DIP 6 – OFF (up)
OUT 3	DIP 3 – OFF (up)	DIP 7 – OFF (up)
OUT 4	DIP 4 – OFF (up)	DIP 8 – OFF (up)

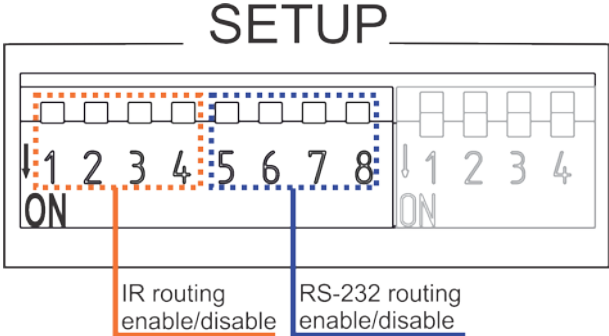

 By default, all DIP-switches are set to OFF (up)

Figure 3: **VM-4DT** DIP-Switches

For example, in the DIP-switch setup shown in [Figure 4](#), DIPs 1, and 6 are set to OFF (up). This means that IR signals can traverse between IN and OUT 1 ports and RS-232 commands can traverse between IN and OUT 2 ports. DIP-switches 2, 3, 4, 5, 7, and 8 are set to ON (down) and are therefore disabled.

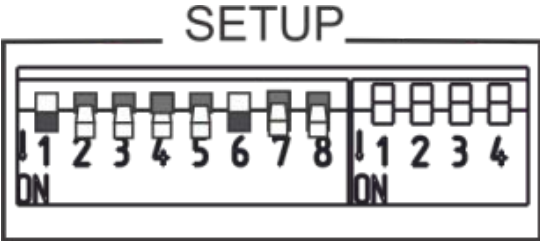

Figure 4: **VM-4DT** DIP-Switches Setup

Signal Routing Example

The example in [Figure 5](#) shows the **VM-4DT** connected to two **TP-580R** devices. Two additional **TP-580R** devices can also be connected. The table below summarizes the types of connections:

Output #	HDMI OUT:	INPUT	IR	RS-232
VM-4DT		TP-580T (Blu-ray player)	Emitter	RC-43SL
TP-580R (1)	Projector			Projector
TP-580R (2)	Display		Sensor	Display



RS-232 and IR signals are transparently routed between the **VM-4DT** source and two acceptors. Since RS-232 is designed for point-to-point communication, make sure that only one RS-232 signal is sent to a destination. However, although only one device may send RS-232 signals down a line, sending RS-232 signals to multiple devices is permissible.

You can send RS-232 signals to an AV device via the transmitter or receivers that are connected to the **VM-4DT**. If you have set the DIP-switches to traverse to all outputs, any command sent to a destination on one of the outputs will also pass to the other output destinations, so you must verify that it will not have an unwanted effect on the other destinations.

In general, we recommend that you set the DIP-switches to traverse to all outputs only when all destination devices are identical (same vendor and same product model) and avoid the sending of concurrent responses.

Routing the IR signal

In the example in [Figure 5](#), an IR emitter cable is connected from **TP-580T** to the Blu-ray player and an IR sensor cable is connected to the **TP-580R** (2) receiver for receiving IR remote signals. This setup lets you remotely control the Blu-ray player via the **TP-580R** (2) receiver device, using the Blu-ray player IR remote control transmitter.



To route the IR signal you have to use the Kramer external IR Receiver cable on one end and the Kramer IR emitter cable on the other end. Note that IR Emitter Extension Cables are also available, if required. For further details, see www.kramerav.com/product/VM-4DT.

Routing the RS-232 Signal

An RS-232 controller can be used to control the AV devices via the **TP-580T** RS-232 port by sending RS-232 commands over HDBaseT lines to the remote connected AV devices.

In the example in [Figure 5](#), the Kramer **RC-43SL** control keypad is used to control AV devices that are connected to both **TP-580R** (1) and **TP-580R** (2). **RC-43SL** is connected to the **TP-580T** RS-232 port. The RS-232 ports on **TP-580R** (1) and **TP-580R** (2) are connected to a projector and display, respectively. This type of setup enables you to control the projector and display via the **RC-43SL**.

When **RC-43SL** sends a command to the projector on **TP-580R** (1), it bears no effect on the display that is connected to **TP-580R** (2). If **TP-580R** (1) and **TP-580R** (2) were connected each to identical projectors, both would respond to the sent RS-232 command.

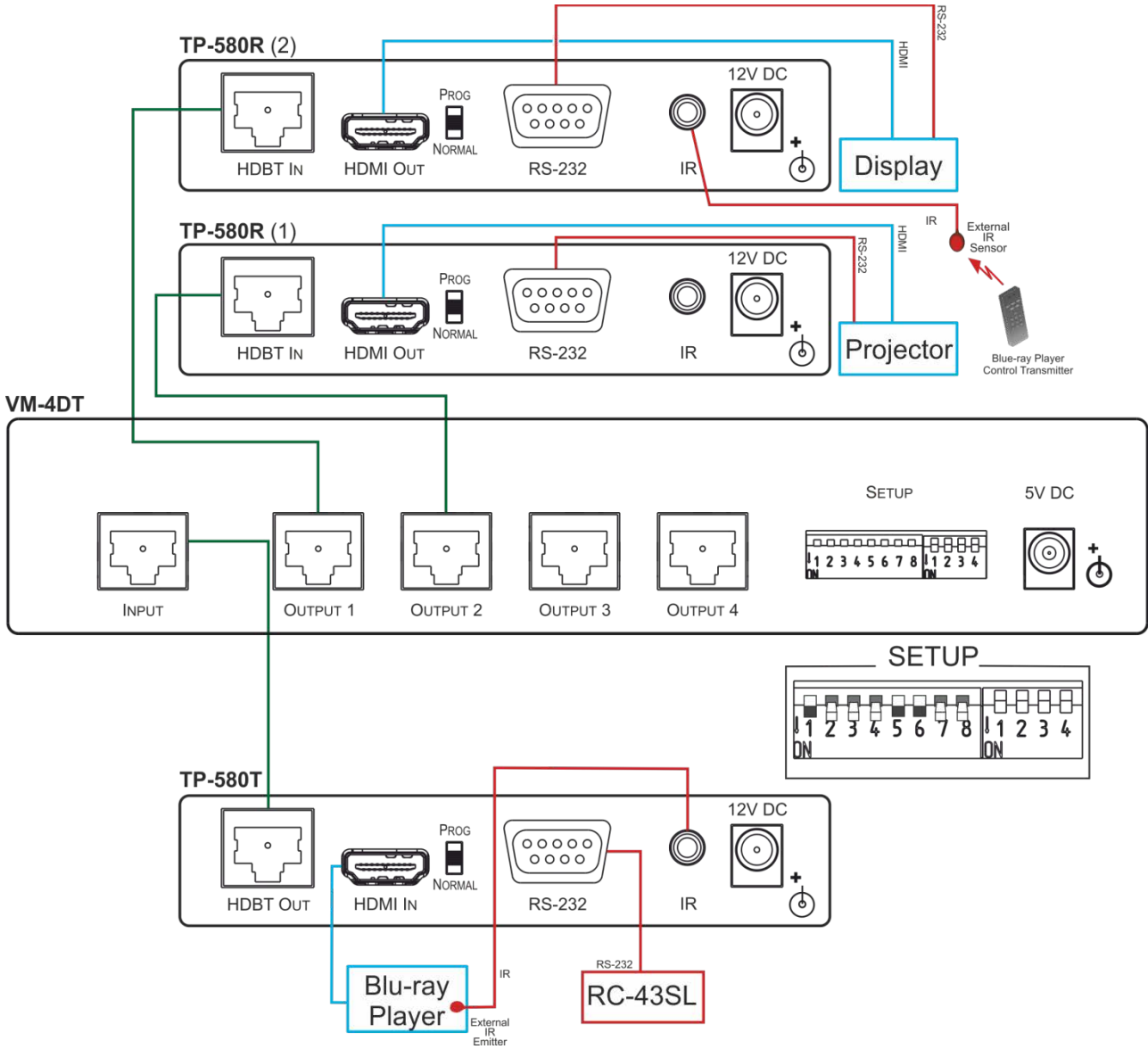

Figure 5: IR/RS-232 Routing Example

Acquiring an EDID

You can acquire the EDID from a connected output or set the **VM-4DT** to the default EDID.

To acquire an EDID, press the EDID SETUP button as follows:

1. Press **EDID SETUP** ③ once.
The OUTPUTS CONNECTED LEDs flash to indicate the current EDID used: 1, 2, 3, 4, or all if the default EDID is currently used.
2. Press **EDID SETUP** ③ again to enter the EDID read mode and then press repeatedly to cycle through the EDID source options until the desired EDID source is reached:
OUT 1 -> OUT 2 -> OUT 3 -> OUT 4 -> all LEDs flash (for a default EDID).
3. Wait a few seconds for the **VM-4DT** to read the EDID.
When complete, all LEDs return to display the present output connection status.



Note that if an unconnected output is chosen or the EDID cannot be read, the **VM-4DT** loads the default EDID.

VM-4DT supports Kramer EDID Designer (via the mini USB port), available at our website: [Kramer EDID Designer](#).

In order to use the mini USB port ②, you need to download and install the Kramer USB driver from our web site at: www.kramerav.com/support/product_downloads.asp.

Forcing the RGB Mode

VM-4DT can acquire EDID in normal mode (default) or in RGB mode (EDID supports only RGB color space).

To enter RGB-only mode:

1. Press and hold **EDID SETUP** ③.
The output LEDs flash 4 times and then turn off.
2. If required, read the EDID (see [Acquiring an EDID](#), on page 9).

To return to the normal mode:

1. Press and hold **EDID SETUP** ③.
The output LEDs light once and then turn off.
2. If required, read the EDID (see [Acquiring an EDID](#), on page 9).



Upon power on, the output LEDs flash according to their EDID mode: four times for RGB mode and once for normal mode.

Upgrading the Firmware

Use the Kramer **K-UPLOAD** software to upgrade the firmware via the **VM-4DT** PROG. Mini USB port ②.

The latest version of **K-UPLOAD** and installation instructions can be downloaded from our website at: www.kramerav.com/support/product_downloads.asp.



Note that in order to use the mini USB port, you need to install the Kramer USB driver, available at: www.kramerav.com/support/product_downloads.asp.

Default EDID



This section lists the default HD EDID.

Monitor

Model name..... VM-4DT
 Manufacturer..... KMR
 Plug and Play ID..... KMR0672
 Data string..... Default-EDID
 Serial number..... 2
 Manufacture date..... 2012, ISO week 255
 Filter driver..... None

 EDID revision..... 1.3
 Input signal type..... Digital
 Color bit depth..... Undefined
 Display type..... RGB color
 Screen size..... 520 x 320 mm (24.0 in)
 Power management..... Standby, Suspend, Active off/sleep
 Extension blocs..... 1 (CEA-EXT)

 DDC/CI..... Not supported

Color characteristics

Default color space..... Non-sRGB
 Display gamma..... 2.20
 Red chromaticity..... Rx 0.674 - Ry 0.319
 Green chromaticity..... Gx 0.188 - Gy 0.706
 Blue chromaticity..... Bx 0.148 - By 0.064
 White point (default).... Wx 0.313 - Wy 0.329
 Additional descriptors... None

Timing characteristics

Horizontal scan range.... 30-83kHz
 Vertical scan range..... 56-76Hz
 Video bandwidth..... 170MHz
 CVT standard..... Not supported
 GTF standard..... Not supported
 Additional descriptors... None
 Preferred timing..... Yes
 Native/preferred timing.. 1280x720p at 60Hz (16:10)
 Modeline..... "1280x720" 74.250 1280 1390 1430 1650 720 725 730 750 +hsync +vsync

Standard timings supported

720 x 400p at 70Hz - IBM VGA
 640 x 480p at 60Hz - IBM VGA
 640 x 480p at 75Hz - VESA
 800 x 600p at 60Hz - VESA
 800 x 600p at 75Hz - VESA
 1024 x 768p at 60Hz - VESA
 1024 x 768p at 75Hz - VESA

1280 x 1024p at 75Hz - VESA
 1280 x 1024p at 60Hz - VESA STD
 1600 x 1200p at 60Hz - VESA STD
 1152 x 864p at 75Hz - VESA STD

EIA/CEA-861 Information

Revision number..... 3
 IT underscan..... Supported
 Basic audio..... Supported
 YCbCr 4:4:4..... Supported
 YCbCr 4:2:2..... Supported
 Native formats..... 1
 Detailed timing #1..... 1920x1080p at 60Hz (16:10)
 Modeline..... "1920x1080" 148.500 1920 2008 2052 2200 1080 1084 1089 1125 +hsync +vsync
 Detailed timing #2..... 1920x1080i at 60Hz (16:10)
 Modeline..... "1920x1080" 74.250 1920 2008 2052 2200 1080 1084 1094 1124 interlace +hsync +vsync
 Detailed timing #3..... 1280x720p at 60Hz (16:10)
 Modeline..... "1280x720" 74.250 1280 1390 1430 1650 720 725 730 750 +hsync +vsync
 Detailed timing #4..... 720x480p at 60Hz (16:10)
 Modeline..... "720x480" 27.000 720 736 798 858 480 489 495 525 -hsync -vsync

CE video identifiers (VICs) - timing/formats supported

1920 x 1080p at 60Hz - HDTV (16:9, 1:1)
 1920 x 1080i at 60Hz - HDTV (16:9, 1:1)
 1280 x 720p at 60Hz - HDTV (16:9, 1:1) [Native]
 720 x 480p at 60Hz - EDTV (16:9, 32:27)
 720 x 480p at 60Hz - EDTV (4:3, 8:9)
 720 x 480i at 60Hz - Doublescan (16:9, 32:27)
 720 x 576i at 50Hz - Doublescan (16:9, 64:45)
 640 x 480p at 60Hz - Default (4:3, 1:1)
 NB: NTSC refresh rate = (Hz*1000)/1001

CE audio data (formats supported)

LPCM 2-channel, 16/20/24 bit depths at 32/44/48 kHz

CE vendor specific data (VSDB)

IEEE registration number. 0x000C03
 CEC physical address..... 1.0.0.0
 Maximum TMDS clock..... 165MHz

CE speaker allocation data

Channel configuration.... 2.0
 Front left/right..... Yes
 Front LFE..... No
 Front center..... No
 Rear left/right..... No
 Rear center..... No
 Front left/right center.. No
 Rear left/right center... No
 Rear LFE..... No

Report information

Date generated..... 01/12/2016
 Software revision..... 2.90.0.1020
 Data source..... Real-time 0x0071
 Operating system..... 6.1.7601.2.Service Pack 1

Technical Specifications

Input:	1 HDBT on an RJ-45 female connector
Outputs:	4 HDBT on RJ-45 female connectors
Extension Line / Range:	HDBaseT 1.0 compliant Up to 40m (130ft) at 4K@60Hz (4:2:0) Up to 70m (230ft) at full HD (1080p@60Hz 36bpp) Note: The specs only apply when using Kramer HDBaseT cables. This reach applies to each IN and OUT port separately; the total end-to-end reach is the sum of all ports' reach.
Video:	Up to 4K@60Hz (4:2:0) resolution; Up to 10.2Gbps (3.4Gbps per graphic channel) data rate; Complies with HDMI 2.0 and HDCP 1.4
Controls:	Front panel: EDID SETUP button Indicator LEDs: OUTPUTS CONNECTED 1-4, HDBT LINK 1-4, ACTIVE INPUT, ON Mini-USB for RS-232 Protocol 3000 communication Rear Panel: SETUP DIP-switches
Power Source:	5.2V DC/4A power supply unit
Power Consumption:	5V DC, 3.5A
Enclosure:	Desktop size, Aluminum type
Cooling:	Fan ventilation
Operating Temperature:	0° to +40°C (32° to 104°F)
Storage Temperature:	-40° to +70°C (-40° to 158°F)
Humidity:	10% to 90%, RHL non-condensing
Dimensions:	21.5cm x 16.3cm x 4.4cm (8.4" x 6.4" x 1.8") W, D, H
Shipping Dimensions:	35.1cm x 21.2cm x 7.2cm (13.8" x 8.3" x 2.8") W, D, H
Weight:	0.53kg (1.17lb)
Shipping Weight:	1.29kg (2.84lb)
Included Accessories:	Power supply
<p>Specifications are subject to change without notice at www.kramerav.com For optimum range and performance use the recommended Kramer cables available at www.kramerav.com/product/VM-4DT</p>	

Default Communication Parameters

Serial USB	
Baud Rate:	115,200
Data Bits:	8
Stop Bits:	1
Parity:	None
Factory Reset	
Protocol 3000:	FACTORY command to reset to factory default configuration
Protocol 3000	
Command Format:	ASCII protocol 3000
Example (get the input signal status):	#SIGNAL? 1,1<cr>

Protocol 3000

The **VM-4DT 1:4 HDBT Distributor** can be operated using the Kramer Protocol 3000 serial commands. The command framing varies according to how you interface with the **VM-4DT**.

Generally, a basic video input switching command that routes a layer 1 video signal to HDMI out 1 from HDMI input 2 (`ROUTE 1,1,2`), is entered as follows:

- Terminal communication software, such as Hercules:

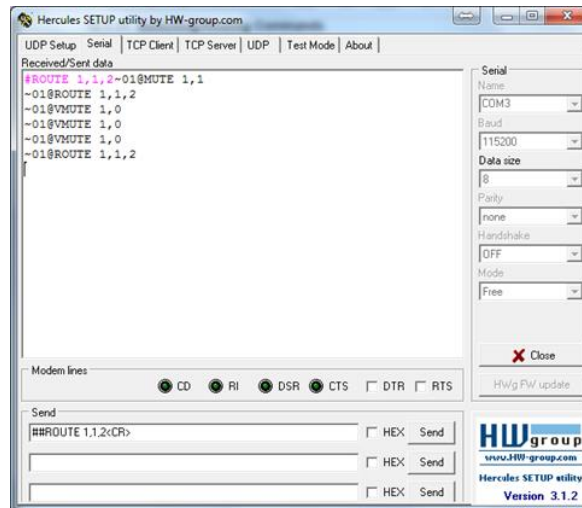

The framing of the command varies according to the terminal communication software.

- K-Touch Builder (Kramer software):

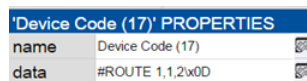

- K-Config (Kramer configuration software):

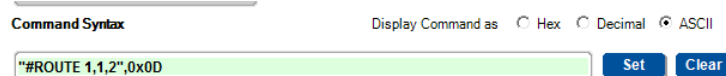

All the examples provided in this section are based on using the K-Config software.

You can enter commands directly using terminal communication software (e.g., Hercules) by connecting a PC to the serial or Ethernet port on the **VM-4DT**. To enter `CR` press the Enter key (`LF` is also sent but is ignored by the command parser).

Commands sent from various non-Kramer controllers (e.g., Crestron) may require special coding for some characters (such as, `/X##`). For more information, refer to your controller's documentation.

For more information about Protocol 3000 commands, see:

- [Understanding Protocol 3000](#) on page [16](#)
- [Kramer Protocol 3000 Syntax](#) on page [17](#)
- [Protocol 3000 Commands](#) on page [18](#)

Understanding Protocol 3000

Protocol 3000 commands are structured according to the following:

- **Command** – A sequence of ASCII letters (A-Z, a-z and -). A command and its parameters must be separated by at least one space.
- **Parameters** – A sequence of alphanumeric ASCII characters (0-9, A-Z, a-z and some special characters for specific commands). Parameters are separated by commas.
- **Message string** – Every command entered as part of a message string begins with a message starting character and ends with a message closing character.



A string can contain more than one command. Commands are separated by a pipe (|) character.

- **Message starting character:**
 - # – For host command/query
 - ~ – For device response
- **Device address** – K-NET Device ID followed by @ (optional, K-NET only)
- **Query sign** – ? follows some commands to define a query request
- **Message closing character:**
 - CR – Carriage return for host messages (ASCII 13)
 - CR LF – Carriage return for device messages (ASCII 13) and line-feed (ASCII 10)
- **Command chain separator character** – Multiple commands can be chained in the same string. Each command is delimited by a pipe character (|). When chaining commands, enter the message starting character and the message closing character only at the beginning and end of the string.



Spaces between parameters or command terms are ignored. Commands in the string do not execute until the closing character is entered. A separate response is sent for every command in the chain.

Kramer Protocol 3000 Syntax

The Kramer Protocol 3000 syntax uses the following delimiters:

- **CR** = Carriage return (ASCII 13 = 0x0D)
- **LF** = Line feed (ASCII 10 = 0x0A)
- **SP** = Space (ASCII 32 = 0x20)

Some commands have short name syntax in addition to long name syntax to enable faster typing. The response is always in long syntax.

The Protocol 3000 syntax is in the following format:

- **Host Message Format:**

Start	Address (optional)	Body	Delimiter
#	<i>Device_id@</i>	Message	CR

- **Simple Command** – Command string with only one command without addressing:

Start	Body	Delimiter
#	Command SP <i>Parameter_1,Parameter_2,...</i>	CR

- **Command String** – Formal syntax with command concatenation and addressing:

Start	Address	Body	Delimiter
#	<i>Device_id@</i>	Command_1 <i>Parameter1_1,Parameter1_2,... </i> Command_2 <i>Parameter2_1,Parameter2_2,... </i> Command_3 <i>Parameter3_1,Parameter3_2,... ...</i>	CR

- **Device Message Format:**

Start	Address (optional)	Body	Delimiter
~	<i>Device_id@</i>	Message	CR LF

- **Device Long Response** – Echoing command:

Start	Address (optional)	Body	Delimiter
~	<i>Device_id@</i>	Command SP [<i>Param1 ,Param2 ...</i>] result	CR LF

Protocol 3000 Commands

This section includes the following commands:

- [System Commands](#) on page [18](#)
- [EDID Handling Commands](#) on page [23](#)

System Commands

Command	Description
#	Protocol handshaking (system mandatory)
BUILD-DATE	Get device build date (system mandatory)
FACTORY	Reset to factory default configuration
HELP	Get command list (system mandatory)
MODEL	Get device model (system mandatory)
PROT-VER	Get device protocol version (system mandatory)
RESET	Reset device (system mandatory)
SN	Get device serial number (system mandatory)
DISPLAY	Get output HPD status
NAME	Set/get machine (DNS) name (system – Ethernet)
SIGNAL	Get input signal lock status (system)
HDCP-STAT	Get HDCP signal status

#

Functions		Permission	Transparency
Set:	#	End User	Public
Get:	-	-	-
Description		Syntax	
Set:	Protocol handshaking	# <input type="checkbox"/> CR	
Get:	-	-	
Response			
~ <input type="checkbox"/> <input type="checkbox"/> @ <input type="checkbox"/> SP <input type="checkbox"/> OK <input type="checkbox"/> CR LF			
Notes			
Validates the Protocol 3000 connection and gets the machine number Step-in master products use this command to identify the availability of a device			
K-Config Example			
"#", 0x0D			

BUILD-DATE

Functions		Permission	Transparency
Set:	-	-	-
Get:	BUILD-DATE?	End User	Public
Description		Syntax	
Set:	-	-	
Get:	Get device build date	# <input type="checkbox"/> BUILD-DATE? <input type="checkbox"/> CR	
Response			
~ <input type="checkbox"/> <input type="checkbox"/> @ <input type="checkbox"/> BUILD-DATE <input type="checkbox"/> SPdate <input type="checkbox"/> SPtime <input type="checkbox"/> CR LF			
Parameters			
date – Format: YYYY/MM/DD where YYYY = Year, MM = Month, DD = Day time – Format: hh:mm:ss where hh = hours, mm = minutes, ss = seconds			
K-Config Example			
"#BUILD-DATE?", 0x0D			

FACTORY

Functions		Permission	Transparency
Set:	FACTORY	End User	Public
Get:	-	-	-
Description		Syntax	
Set:	Reset device to factory default configuration	#FACTORY <code>CR</code>	
Get:	-	-	
Response			
~ <code>nn</code> @FACTORY <code>SP</code> OK <code>CR LF</code>			
Notes			
This command deletes all user data from the device. The deletion can take some time. Your device may require powering off and powering on for the changes to take effect.			
K-Config Example			
"#FACTORY" , 0x0D			

HELP

Functions		Permission	Transparency
Set:	-	-	-
Get:	HELP	End User	Public
Description		Syntax	
Set:	-	-	
Get:	Get command list or help for specific command	1. #HELP <code>CR</code> 2. #HELP <code>SP</code> COMMAND_NAME <code>CR</code>	
Response			
1. Multi-line: ~ <code>nn</code> @Device available protocol 3000 commands: <code>CR LF</code> command , <code>SP</code> command... <code>CR LF</code>			
2. Multi-line: ~ <code>nn</code> @HELP <code>SP</code> command: <code>CR LF</code> description <code>CR LF</code> USAGE:usage <code>CR LF</code>			
Parameters			
COMMAND_NAME – name of a specific command			
Notes			
To get help for a specific command use: HELP <code>SP</code> COMMAND_NAME <code>CR LF</code>			
K-Config Example			
"#HELP" , 0x0D			

MODEL

Functions		Permission	Transparency
Set:	-	-	-
Get:	MODEL?	End User	Public
Description		Syntax	
Set:	-	-	
Get:	Get device model	#MODEL? <code>CR</code>	
Response			
~ <code>nn</code> @MODEL <code>SP</code> model_name <code>CR LF</code>			
Parameters			
model_name – String of up to 19 printable ASCII chars			
Notes			
This command identifies equipment connected to Step-in master products and notifies of identity changes to the connected equipment. The Matrix saves this data in memory to answer REMOTE-INFO requests			
K-Config Example			
"#MODEL?" , 0x0D			

PROT-VER

Functions		Permission	Transparency
Set:	-	-	-
Get:	PROT-VER?	End User	Public
Description		Syntax	
Set:	-	-	
Get:	Get device protocol version	# PROT-VER? <input type="checkbox"/> CR	
Response			
~ <input type="checkbox"/> <input type="checkbox"/> @ PROT-VER <input type="checkbox"/> SP3000:version <input type="checkbox"/> CR LF			
Parameters			
version - XX.XX where X is a decimal digit			
K-Config Example			
"#PROT-VER?" , 0x0D			

RESET

Functions		Permission	Transparency
Set:	RESET	Administrator	Public
Get:	-	-	-
Description		Syntax	
Set:	Reset device	# RESET <input type="checkbox"/> CR	
Get:	-	-	
Response			
~ <input type="checkbox"/> <input type="checkbox"/> @ RESET <input type="checkbox"/> SPOK <input type="checkbox"/> CR LF			
Notes			
To avoid locking the port due to a USB bug in Windows, disconnect USB connections immediately after running this command. If the port was locked, disconnect and reconnect the cable to reopen the port.			
K-Config Example			
"#RESET" , 0x0D			

SN

Functions		Permission	Transparency
Set:	-	-	-
Get:	SN?	End User	Public
Description		Syntax	
Set:	-	-	
Get:	Get device serial number	# SN? <input type="checkbox"/> CR	
Response			
~ <input type="checkbox"/> <input type="checkbox"/> @ SN <input type="checkbox"/> SPserial_number <input type="checkbox"/> CR LF			
Parameters			
serial_number – 11 decimal digits, factory assigned			
Notes			
This device has a 14 digit serial number, only the last 11 digits are displayed			
K-Config Example			
"#SN?" , 0x0D			

DISPLAY

Functions		Permission	Transparency
Set:	-	-	-
Get:	DISPLAY?	End User	Public
Description		Syntax	
Set:	-	-	
Get:	Get output HPD status	# DISPLAY? [SP]out_id[CR]	
Response			
~nn@ DISPLAY [SP]out_id,status[CR LF]			
Parameters			
out_id – 1 (Output 1), 2 (Output 2), 3 (Output 3) , 4 (Output 4) status – HPD status according to signal validation : 0 (Off), 1 (On), 2 (On and all parameters are stable and valid)			
Response Triggers			
A response is sent to the com port from which the Get was received, after command execution and: After every change in output HPD status from On to Off (0) After every change in output HPD status from Off to On (1) After every change in output HPD status form Off to On and all parameters (new EDID, etc.) are stable and valid (2)			
K-Config Example			
Get the output HPD status of Output 1: "#DISPLAY? 1" , 0x0D			

NAME

Functions		Permission	Transparency
Set:	NAME	Administrator	Public
Get:	NAME?	End User	Public
Description		Syntax	
Set:	Set machine (DNS) name	# NAME [SP]machine_name[CR]	
Get:	Get machine (DNS) name	# NAME? [CR]	
Response			
Set: ~nn@ NAME [SP]machine_name[CR LF] Get: ~nn@ NAME? [SP]machine_name[CR LF]			
Parameters			
machine_name - String of up to 14 alpha-numeric characters (can include hyphens but not at the beginning or end)			
Notes			
The machine name is not the same as the model name. The machine name is used to identify a specific machine or a network in use (with DNS feature on).			
K-Config Example			
Set the DNS name of the device to "room-442": "#NAME room-442" , 0x0D			

SIGNAL

Functions		Permission	Transparency
Set:	-	-	-
Get	SIGNAL?	End User	Public
Description		Syntax	
Set:	-	-	
Get:	Get input signal lock status	#SIGNAL?[SP]inp_id[CR]	
Response			
~nn@SIGNAL[SP]inp_id,status[CR LF]			
Parameters			
inp_id – input number: 1 (Input) status – signal status according to signal validation: 0 (Off), 1 (On)			
Response Triggers			
After execution, a response is sent to the com port from which the Get was received A response is sent after every change in input signal status from On to Off or from Off to On			
K-Config Example			
Get the input signal status: "#SIGNAL? 1",0x0D			

HDCP-STAT

Functions		Permission	Transparency
Set:	-	-	-
Get	HDCP-STAT?	End User	Public
Description		Syntax	
Set:	None	-	
Get:	Get HDCP signal status	#HDCP-STAT?[SP]stage,stage_id[CR]	
Response			
~nn@HDCP-STAT[SP]stage,stage_id,status[CR LF]			
Parameters			
stage – 0 (input), 1 (output) stage_id – for input stage: 1 (Input), for output stage 1 (Output 1), 2 (Output 2), 3 (Output 3) , 4 (Output 4) status – signal encryption On/Off status: 0 (HDCP Off), 1 (HDCP On), 2 (Follow input), 3 (Mirror output (Mac mode))			
Response Triggers			
Response is sent to the com port from which the Set (before execution) / Get command was received Response is sent to all com ports after execution if HDCP-STAT was set by any other external control device (button press, device menu and similar) or HDCP mode changed.			
Notes			
On output – sink status On input – signal status			
K-Config Example			
Get the HDCP signal status of the input: "#HDCP-STAT? 0,1",0x0D			

EDID Handling Commands

Additional EDID data functions can be performed via a compatible EDID management application, such as Kramer EDID Designer (see www.kramerav.com/product/EDID%20Designer).

Command	Description
CPEDID	Copy EDID data from the output to the input EEPROM

CPEDID

Functions	Permission	Transparency
Set: CPEDID	End User	Public
Get: -	-	-
Description	Syntax	
Set: Copy EDID data from the output to the input EEPROM	#CPEDID[SP]src_type,src_id,dst_type,dest_bitmap[CR]	
Get: -	-	
Response		
~[nm]@CPEDID[SP]src_type,src_id,dst_type,dest_bitmap[CR LF]		
Parameters		
<i>src_type</i> – EDID source type (usually output): 0 (Input), 1 (Output), 2 (Default EDID) <i>src_id</i> – for input source: 1 (Input), for output source: 0 (Default EDID source), 1 (Output 1), 2 (Output 2), 3 (Output 3), 4 (Output 4) <i>dst_type</i> – EDID destination type (usually input): 0 (input), 1 (output), 2 (default EDID) <i>dest_bitmap</i> – bitmap representing destination IDs. Format: XXXX...X, where X is hex digit. The binary form of every hex digit represents corresponding destinations. Setting '1' indicates that EDID data is copied to this destination. Setting '0' indicates that EDID data is not copied to this destination.		
Response Triggers		
Response is sent to the com port from which the Set was received (before execution)		
Notes		
Destination bitmap size depends on device properties (for 64 inputs it is a 64-bit word) Example: bitmap 0x0013 means inputs 1, 2 and 5 are loaded with the new EDID. In this device, if the destination type is input (0), the bitmap size is 1 bit, for example bitmap 0x1 means the input is loaded with the new EDID.		
K-Config Example		
Copy the EDID data from Output 1 (EDID source) to the Input: "#CPEDID 1,1,0,0x1",0x0D Copy the EDID data from the default EDID source to the Input: "#CPEDID 2,0,0,0x1",0x0D		

The warranty obligations of Kramer Electronics Inc. ("Kramer Electronics") for this product are limited to the terms set forth below:

What is Covered

This limited warranty covers defects in materials and workmanship in this product.

What is Not Covered

This limited warranty does not cover any damage, deterioration or malfunction resulting from any alteration, modification, improper or unreasonable use or maintenance, misuse, abuse, accident, neglect, exposure to excess moisture, fire, improper packing and shipping (such claims must be presented to the carrier), lightning, power surges, or other acts of nature. This limited warranty does not cover any damage, deterioration or malfunction resulting from the installation or removal of this product from any installation, any unauthorized tampering with this product, any repairs attempted by anyone unauthorized by Kramer Electronics to make such repairs, or any other cause which does not relate directly to a defect in materials and/or workmanship of this product. This limited warranty does not cover cartons, equipment enclosures, cables or accessories used in conjunction with this product.

Without limiting any other exclusion herein, Kramer Electronics does not warrant that the product covered hereby, including, without limitation, the technology and/or integrated circuit(s) included in the product, will not become obsolete or that such items are or will remain compatible with any other product or technology with which the product may be used.

How Long this Coverage Lasts

The standard limited warranty for Kramer products is seven (7) years from the date of original purchase, with the following exceptions:

1. All Kramer VIA products are covered by a standard three (3) year warranty for VIA hardware and a standard one (1) year warranty for firmware and software updates. (An extended software warranty plan for an additional 2 years can be purchased separately).
2. All Kramer fiber optic cables and adapters, all Kramer speakers and Kramer touch panels are covered by a standard one (1) year warranty.
3. All Kramer Cobra products, all Kramer Calibre products, all Kramer Minicom digital signage products, all HighSecLabs products, all streaming, and all wireless products are covered by a standard three (3) year warranty.
4. All Sierra Video MultiViewers are covered by a standard five (5) year warranty.
5. Sierra switchers & control panels are covered by a standard seven (7) year warranty (excluding power supplies and fans that are covered for three (3) years).
6. K-Touch software is covered by a standard one (1) year warranty for software updates.
7. All Kramer passive cables are covered by a ten (10) year warranty.

Who is Covered

Only the original purchaser of this product is covered under this limited warranty. This limited warranty is not transferable to subsequent purchasers or owners of this product.

What Kramer Electronics Will Do

Kramer Electronics will, at its sole option, provide one of the following three remedies to whatever extent it shall deem necessary to satisfy a proper claim under this limited warranty:

1. Elect to repair or facilitate the repair of any defective parts within a reasonable period of time, free of any charge for the necessary parts and labor to complete the repair and restore this product to its proper operating condition. Kramer Electronics will also pay the shipping costs necessary to return this product once the repair is complete.
2. Replace this product with a direct replacement or with a similar product deemed by Kramer Electronics to perform substantially the same function as the original product.
3. Issue a refund of the original purchase price less depreciation to be determined based on the age of the product at the time remedy is sought under this limited warranty.

What Kramer Electronics Will Not Do Under This Limited Warranty

If this product is returned to Kramer Electronics or the authorized dealer from which it was purchased or any other party authorized to repair Kramer Electronics products, this product must be insured during shipment, with the insurance and shipping charges prepaid by you. If this product is returned uninsured, you assume all risks of loss or damage during shipment. Kramer Electronics will not be responsible for any costs related to the removal or re-installation of this product from or into any installation. Kramer Electronics will not be responsible for any costs related to any setting up this product, any adjustment of user controls or any programming required for a specific installation of this product.

How to Obtain a Remedy Under This Limited Warranty

To obtain a remedy under this limited warranty, you must contact either the authorized Kramer Electronics reseller from whom you purchased this product or the Kramer Electronics office nearest you. For a list of authorized Kramer Electronics resellers and/or Kramer Electronics authorized service providers, visit our web site at www.kramerav.com or contact the Kramer Electronics office nearest you.

In order to pursue any remedy under this limited warranty, you must possess an original, dated receipt as proof of purchase from an authorized Kramer Electronics reseller. If this product is returned under this limited warranty, a return authorization number, obtained from Kramer Electronics, will be required (RMA number). You may also be directed to an authorized reseller or a person authorized by Kramer Electronics to repair the product.

If it is decided that this product should be returned directly to Kramer Electronics, this product should be properly packed, preferably in the original carton, for shipping. Cartons not bearing a return authorization number will be refused.

Limitation of Liability

THE MAXIMUM LIABILITY OF KRAMER ELECTRONICS UNDER THIS LIMITED WARRANTY SHALL NOT EXCEED THE ACTUAL PURCHASE PRICE PAID FOR THE PRODUCT. TO THE MAXIMUM EXTENT PERMITTED BY LAW, KRAMER ELECTRONICS IS NOT RESPONSIBLE FOR DIRECT, SPECIAL, INCIDENTAL OR CONSEQUENTIAL DAMAGES RESULTING FROM ANY BREACH OF WARRANTY OR CONDITION, OR UNDER ANY OTHER LEGAL THEORY. Some countries, districts or states do not allow the exclusion or limitation of relief, special, incidental, consequential or indirect damages, or the limitation of liability to specified amounts, so the above limitations or exclusions may not apply to you.

Exclusive Remedy

TO THE MAXIMUM EXTENT PERMITTED BY LAW, THIS LIMITED WARRANTY AND THE REMEDIES SET FORTH ABOVE ARE EXCLUSIVE AND IN LIEU OF ALL OTHER WARRANTIES, REMEDIES AND CONDITIONS, WHETHER ORAL OR WRITTEN, EXPRESS OR IMPLIED. TO THE MAXIMUM EXTENT PERMITTED BY LAW, KRAMER ELECTRONICS SPECIFICALLY DISCLAIMS ANY AND ALL IMPLIED WARRANTIES, INCLUDING, WITHOUT LIMITATION, WARRANTIES OF MERCHANTABILITY AND FITNESS FOR A PARTICULAR PURPOSE. IF KRAMER ELECTRONICS CANNOT LAWFULLY DISCLAIM OR EXCLUDE IMPLIED WARRANTIES UNDER APPLICABLE LAW, THEN ALL IMPLIED WARRANTIES COVERING THIS PRODUCT, INCLUDING WARRANTIES OF MERCHANTABILITY AND FITNESS FOR A PARTICULAR PURPOSE, SHALL APPLY TO THIS PRODUCT AS PROVIDED UNDER APPLICABLE LAW.

IF ANY PRODUCT TO WHICH THIS LIMITED WARRANTY APPLIES IS A "CONSUMER PRODUCT" UNDER THE MAGNUSON-MOSS WARRANTY ACT (15 U.S.C.A. §2301, ET SEQ.) OR OTHER APPLICABLE LAW, THE FOREGOING DISCLAIMER OF IMPLIED WARRANTIES SHALL NOT APPLY TO YOU, AND ALL IMPLIED WARRANTIES ON THIS PRODUCT, INCLUDING WARRANTIES OF MERCHANTABILITY AND FITNESS FOR THE PARTICULAR PURPOSE, SHALL APPLY AS PROVIDED UNDER APPLICABLE LAW.

Other Conditions

This limited warranty gives you specific legal rights, and you may have other rights which vary from country to country or state to state.

This limited warranty is void if (i) the label bearing the serial number of this product has been removed or defaced, (ii) the product is not distributed by Kramer Electronics or (iii) this product is not purchased from an authorized Kramer Electronics reseller. If you are unsure whether a reseller is an authorized Kramer Electronics reseller, visit our web site at www.kramerav.com or contact a Kramer Electronics office from the list at the end of this document.

Your rights under this limited warranty are not diminished if you do not complete and return the product registration form or complete and submit the online product registration form. Kramer Electronics thanks you for purchasing a Kramer Electronics product. We hope it will give you years of satisfaction.



P/N: 2900-300799



Rev: 1



SAFETY WARNING

Disconnect the unit from the power supply before opening and servicing

For the latest information on our products and a list of Kramer distributors, visit our Web site where updates to this user manual may be found.

We welcome your questions, comments, and feedback.