

LynTec NPAC

Instruction Bulletin

Networkable Power Automation Control

Retain for future use.

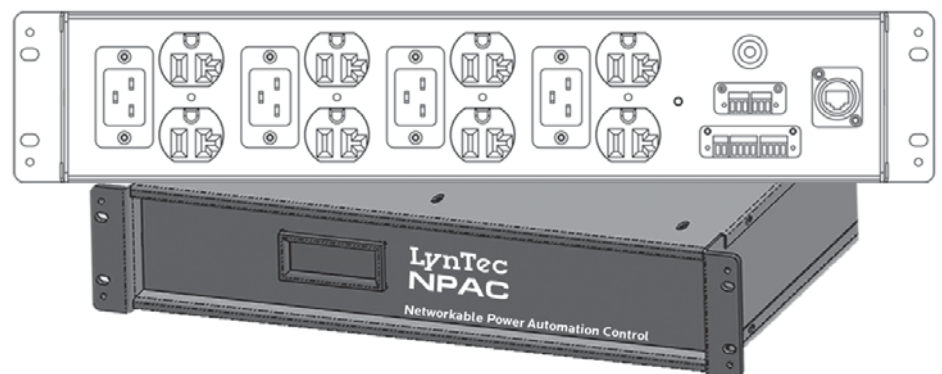

DISCLAIMER

LynTec shall under no circumstances be held responsible for any loss, damage or injury resulting from the use of the NPAC in a manner inconsistent with any of the procedures outlined in this document.

The user is responsible for determining whether this product is appropriate for the intended application.

LynTec is not responsible for any indirect, secondary or ancillary loss or damage, including personal injury, loss of or damage to property or loss of income resulting from the operation or failure of this unit.

Contents	
Disclaimer	2
Chapter 1--Introduction.....	5
OVERVIEW.....	5
CONTENTS	5
Hardware Components	5
Software Features	6
Front & Back Panel Overview	7
Chapter Two--Safety Precautions.....	8
Chapter Three--Quick Start Guide	10
Introduction	10
Chapter 4--Wiring	11
Emergency Shutdown Wiring:	11
Switch Wiring Instructions	12
LynTec SS-2 Switch Set	12
SS-2PL and SS-2LRP Locking Switch Sets.....	13
Initial Power up procedure.....	14
Chapter 5--Control Setup (Web Page)	15
OVERVIEW.....	15
Status	15
Control	15
Setup	15
Support.....	15
event log.....	15
Setup.....	16
Setup Home	16
Network setup.....	17
Panel Setup	20
Relay setup	20
Zone setup.....	21
Global Preferences	25
Setup	25
Labeling	25
Global Control Preferences.....	25
Selecting Relays for Emergency Shutdown or Brownout	26
Voltage Thresholds.....	26
Schedule Setup	27
Assigning Schedules to Zones	27
Contact Closure Setup.....	28
Assigning Contact Closures to Zones	28
Individual Momentary Contact ON and OFF Pushbuttons	29

NPAC Table of Contents

Email Alert Setup	30
Chapter Six: Operating your NPAC.....	31
Using the built-in web page	31
Using a secondary controller	31
Appendix A--Telnet and TCP/IP Protocols	32
Telnet Protocol.....	32
Addressing Scheme	32
Relay Related Commands	32
Zone Related Commands.....	34
Event Related Commands.....	35
Checksum	37
TCP/IP Protocol.....	37
Relay Control = B.....	37
Zone Control = Z	37
Events Control = E	38
Appendix B--Troubleshooting.....	39
Troubleshooting the NPAC.....	39
Appendix C--Installation Diagram	41

Chapter 1--Introduction

OVERVIEW

This bulletin explains how to install and operate the LynTec NPAC rack-mount relay unit. The unit has four 20A IEC inputs that can control either 4 or 8 single-pole relays (80A max). In the case of the NPAC 240, the unit contains either 4 or 8 double-pole relays (80A max). Control signals originate externally from commands received via the communications network or from dry contact inputs. Acceptable communications protocols include HTTP, sACN, DMX-512 and Telnet.

CONTENTS

Hardware Components

Each NPAC comes standard with the following hardware components installed:

- Four IEC C20, 20A inputs
- Eight NEMA 5-20 outputs (NPAC-120-4 and NPAC-120-8)
- Eight NEMA 6-20 outputs (NPAC-240-4 and NPAC-240-8)
- Ethernet input
- DMX In & Thru inputs
- Emergency override input
- Four contact closure inputs

Optional additional components include

- 4-IEC power cord

Software Features

Each NPAC comes standard with the following software features:

- Built-in web server with browser interface for super-easy set up.
- Circuit level sequencing with selectable individual step-rates (25ms to 999s)
- Smart phone, tablet or laptop control and monitoring built in.
- Built in scheduling program with astronomical clock and 84 schedule events.
- Can be interfaced with any control system that communicates individual circuit addresses in HTTP, Telnet, DMX, sACN or contact closure.
- Circuit selectable load-shedding feature for emergency shutoff
- Brownout (under-voltage) and over-voltage protection with automatic shutdown and controlled restart.

Front & Back Panel Overview

Figure 1-1: NPAC Front Panel

Figure 1-1 shows the NPAC front panel. A brief description of each part follows in Table 1-1.

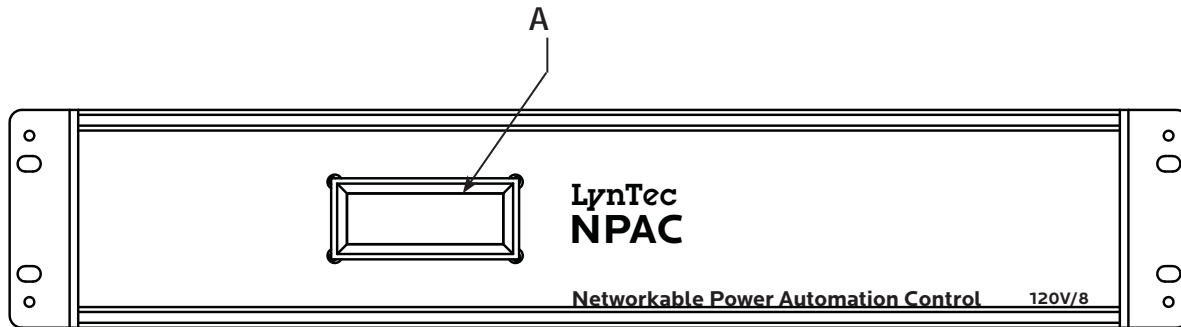

Figure 1-2: NPAC Rear Panel

Figure 1-2 shows the NPAC back panel. A brief description of each part follows in Table 1-2.

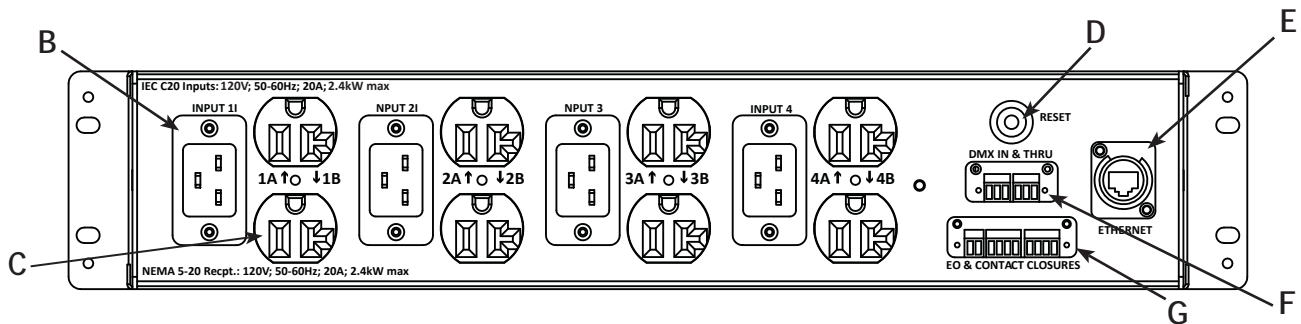

Table 1-1: Parts of the NPAC Front & Back Panel

Component	Description
A. LCD Screen	Screen shows the IP address and relay status
B. IEC C-20 20A Input	Inputs 20A. Used in both 120V and 240V models
C. NEMA Output	NEMA 5-20 in 120V models; NEMA 6-20 in 240V models
D. Reset Button	Resets the controller.
E. Ethernet Port	Connects the panel to a computer or network for initial setup or long-term operation using the built-in web interface. Port also provides sACN connection
F. DMX Input and Thru	Allows the panel to be directed by a secondary DMX controller. When DMX is enabled, the control page is disabled.
G. Emergency Override & Contact closure Inputs	One set of contacts for emergency override and four contact closure inputs.

Chapter Two--Safety Precautions

This chapter contains important safety precautions that must be followed before attempting to install, service, or maintain electrical equipment. Carefully read and follow the safety precautions below.

READ AND FOLLOW ALL SAFETY INSTRUCTIONS

IMPORTANT SAFEGUARDS

When using electrical equipment, basic safety precautions should always be followed including the following:

READ AND FOLLOW ALL SAFETY INSTRUCTIONS.

- The NPAC must be grounded. Ungrounded operation may cause a hazard.
- There are no user servicable parts inside the NPAC. Do not attempt to service yourself.
- This equipment has more than one power supply cord. To reduce the risk of electric shock disconnect four (4) power supply cords before servicing
- Do not expose the NPAC to moisture.
- Do not use outdoors - the enclosure is not rated for outdoor use
- Do not mount near gas or electric heaters.
- Do not feed after midnight.
- Equipment should be mounted in locations and at heights where it will not readily be subjected to tampering by unauthorized personnel.
- The use of accessory equipment not recommended by the manufacturer may cause an unsafe condition.
- Do not use this equipment for other than intended use.

SAVE THESE INSTRUCTIONS

Ce chapitre contient des consignes de sécurité importantes qui Doit être suivi avant d'essayer d'installer, de Maintenir l'équipement électrique. Lisez et suivez attentivement Les précautions de sécurité ci-dessous.

LIRE ET SUIVRE TOUTES LES INSTRUCTIONS DE SÉCURITÉ

GARANTIES IMPORTANTES

Lors de l'utilisation d'équipements électriques, des précautions de sécurité de base Devrait toujours être suivie, y compris les suivantes:

LISEZ ET SUIVEZ TOUTES LES INSTRUCTIONS DE SÉCURITÉ.

- Le NPAC doit être mis à la terre. Une opération non mise à la terre peut Causer un risque.
- Il n'y a pas de pièces utilisables par l'utilisateur à l'intérieur du NPAC. Ne pas Tentez de vous entretenir.
- Cet équipement comporte plus d'un cordon d'alimentation. À Réduire le risque de décharge électrique déconnecter quatre (4) puissance Cordons d'alimentation avant l'entretien
- Ne pas exposer le NPAC à l'humidité.
- Ne pas utiliser à l'extérieur - l'enceinte n'est pas évaluée pour l'extérieur utilisation
- Ne montez pas près de gaz ou de radiateurs électriques.
- Ne pas nourrir après minuit.
- L'équipement doit être monté dans des endroits et à des hauteurs Où il ne sera pas facilement soumis à une altération par Personnel non autorisé.
- L'utilisation d'accessoires non recommandés par les Le fabricant peut causer un état dangereux.
- N'utilisez pas cet équipement pour une utilisation autre que prévue

CONSERVEZ CES INSTRUCTIONS

Chapter Three--Quick Start Guide

INTRODUCTION

This chapter is a quick reference listing the steps necessary to install the NPAC system. The steps in this chapter are provided as an installation checklist. For complete installation instructions, refer the chapter listed.

Steps	Reference
1. Connect power to each 20A IEC input. Input 1 must be connected to a power source during programming and operation.	Chapter 1--Back Panel Overview
2. Connect the controller to a computer or network for panel setup.	Chapter 4--Wiring
3. Access the web page by entering the displayed IP address or NetBIOS name into web browser on a connected computer.	Chapter 5--Control Setup
4. Complete the setup.	Chapter 5--Control Setup
5. Connect the controller to a secondary controller or add contact closures if necessary.	Chapter 4--Wiring Chapter 5--Control Setup

Note: The NPAC is factory programmed to place all relays in Zone 1 and in a brownout condition. Applying power to input #1 will start brownout recovery sequence and power all outlets on.

Chapter 4--Wiring

Emergency Shutdown Wiring:

To connect your fire alarm or emergency management system to the NPAC, follow these steps.

1. From the fire alarm unit or latching Emergency Shutoff switch, wire the contacts to the first pair of inputs on the rear panel. Default is Normally Open, but this can be changed in setup (see Ch. 5)
2. When the contacts change state, all relays that have been selected for E. Shutoff will cycle to OFF.
3. When the contacts change state all relays that were ON when E. Shutoff was activated will return to the ON state.

See Chapter 5 to configure the software for emergency shutdown.

Figure 4-1: Emergency shutdown wiring

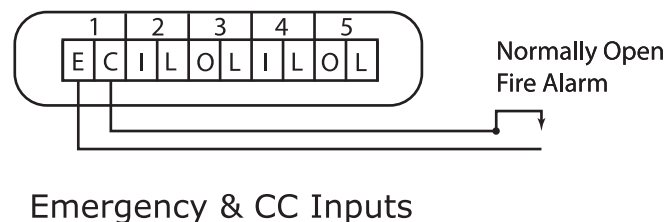

Switch Wiring Instructions

The I/O ports on your NPAC controller allow for a variety of switch options.

LynTec SS-2 Switch Set

Using a standard LynTec SS-2 Switch Set with illuminated ON switch. See Figure 4-2

1. Wire the ON switch to Digital I/O port 2 on the rear panel as follows:
 - i. Connect the 24VDC Common to the C pin of the ON switch. Jumper the C pin of the ON switch to the + pin.
 - ii. Connect the Input terminal (arrow pointing towards header) to the NO pin of the ON switch.
 - iii. Connect the Output terminal (arrow pointing away from header) to the - pin of the ON switch.
2. Wire the OFF switch to Digital I/O port 3 on the rear panel as follows:
 - i. Connect the 24VDC Common terminal to the C pin of the OFF switch.
 - ii. Connect the Input terminal to the NO pin of the OFF switch

Repeat on ports 4 & 5 for the second zone

Figure 4-2
LynTec SS-2 Wiring Diagram

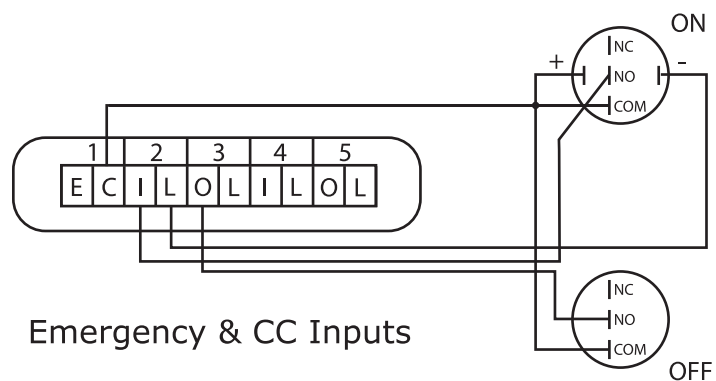

To configure the Digital I/O port and link it to a zone see Chapter 5.

SS-2PL and SS-2LRP Locking Switch Sets

Using a standard LynTec SS-2PL or SS-2 LRP Switch Set with illuminated ON switch. See Figure 4-3

1. Wire the ON switch to Digital I/O port 2 on the rear panel as follows:
 - i. Connect the 24VDC Common to the + pin of the ON switch.
 - ii. Connect the + pin on the on switch to the 1 pin on the lock.
 - iii. Connect the Input terminal (arrow pointing towards header) to the NO pin of the ON switch.
 - iv. Connect the Output terminal (arrow pointing away from header) to the - pin of the ON switch.
 - v. Connect the C pin on the ON switch to the 3 pin on the lock.
2. Wire the OFF switch to Digital I/O port 3 on the rear panel as follows:
 - iii. Connect the 3 pin on the lock to the C pin on the OFF switch.
 - iv. Connect the Input terminal to the NO pin of the OFF switch

Figure 4-3

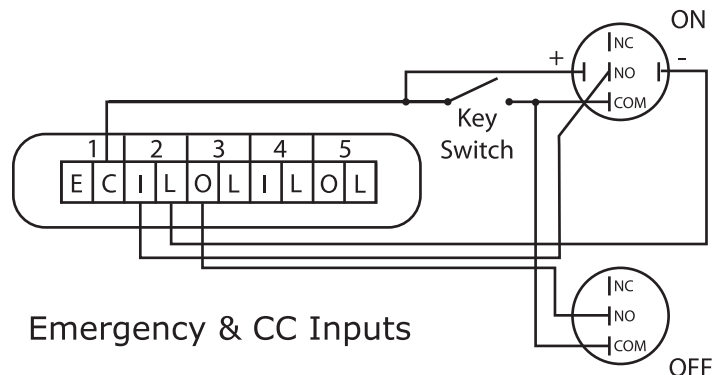

To configure the Digital I/O port and link it to a zone see Chapter 5.

INITIAL POWER UP PROCEDURE

Connect a computer with an Ethernet port and installed web browser program to the NPAC Network connector using the provided crossover cable. Then enter the IP address displayed on the front panel.

Note: All relays will sequence on when power is connected to input #1.

Chapter 5--Control Setup (Web Page)

OVERVIEW

There are 5 main tabs on your NPAC web page. This page will give you a quick overview of the pages and their functions.

STATUS

The status page allows you to view the current status of the relays and zones. Zones and individual relays cannot be manipulated from this page.

CONTROL

This page allows the user to manipulate individual relays as well as relay zones. "All ON/OFF" and "Hurry-Off" commands can also be triggered from this page.

SETUP

The setup section allows you to setup and use the NPAC controller. From this section you can manipulate the network settings, assign relays to zones, create sequences, activate emergency management features, create schedules and assign contact closures.

SUPPORT

This page provides contact information for LynTec.

EVENT LOG

This page provides a log of events.

Setup

This section will guide you through the process of setting up your NPAC Controller. First enter the IP address or NetBios name into your web browser. When the NPAC screen pulls up. Select "Setup" and "SetupHome" Tabs.

SETUP HOME

Figure 5-1--Setup Home

To set the username and password for your panel, click the Setup tab. The Setup Home tab should be displayed. The default username displayed should be "admin" and the password fields should be "pw". Enter the desired username in the first field, password (without spaces or symbols) in the second and then retype the password again in the third field. When ready, click the Update Login Info button to save the changes to the controller's memory.

Contact information for service can also be entered on this page. Under the Serial Number field, enter the name and phone number of the installing contractor (Electrician) and the system integrator (A/V Technician) for future reference. Save this information by clicking the

Basic date and time information will be displayed in the Clock Set fields. Verify that the year, month and day are correct. Set the hour to the appropriate time for your time zone and verify that the minute displayed is correct. Save this information by clicking the Update Information button below the Clock Set portion of the window.

Click the radio buttons for any pages to be printed out under the Printable Pages header. To print the Network Setup, Panel Setup or Panel Schedules pages at any time, ensure the desired buttons have been selected and then click the Print Pages button to the right. Please print a copy for your records after setup is complete.

Network setup

Figure 5-2--Network Configuration

Figure 5-2 shows the network configuration portion of the Network setup.

Network Configuration			
Hostname	LYNTECRPC220		
Enable DHCP	<input checked="" type="checkbox"/> <i>If checked, DHCP is enabled. This module will automatically be assigned an IP, Subnet and Gateway address.</i>		
IP Address:	192.168.1.111	DNS1:	192.168.1.254
Subnet Mask:	255.255.255.0	DNS2:	0.0.0.0
Gateway Address:	192.168.1.254	MAC Address:	00:23:50:01:02:18

This screen shows the current network values. If DHCP is enabled then the fields will be greyed out. It is recommended that the user consult with the network administrator before changing these values.

The IP, Subnet and Gateway addresses are only used in the following situations:

- When DHCP is disabled
- When DHCP is enabled, but there is no DHCP server available on the network
- When the NPAC provides DHCP addresses

If DHCP is enabled and available on the network, all these values will be obtained from the DHCP server.

If DHCP is disabled and a static address is used, save changes and then press "Reset NPAC" to apply changes.

Figure 5-3: Interface options

The screenshot shows a 'Parameters' configuration window with a 'Port Type' section. It includes radio buttons for RS232, DMX512, and SACN (E1.31). The RS232 section has a Baud Rate dropdown set to 115200 and threshold settings. The DMX512 section has checkboxes for Set 1-4 and RDM. The SACN (E1.31) section has checkboxes for Universe 1-4 and RDMnet, with associated address fields and 'Loss of Signal Options' radio buttons.

Port Type

The port type section is used to select the preferred communication protocol. The controller defaults to Ethernet (TCP/IP) for setup but can be controlled in conjunction with sACN or DMX-512 protocols.

DMX

For DMX operation use the following steps:

The NPAC allows up to four different sets of DMX starting addresses within a single universe.

In the first set, enter the first relay address. All relays need to be assigned addresses manually. Do this by clicking on each relay in the order you would like them to be addressed. If you need to skip an address or group of addresses, simply create a new zone and enter the desired starting address. If you would like the NPAC to automatically assign relays to consecutive addresses, you may change that in the "Panels" tab.

Streaming ACN E1.31

For sACN operation use the following steps:

The NPAC allows up to four different universes with sACN operation.

First, assign a number to the universe.

In the first set, enter the first individual relay address. All relays need to be assigned addresses manually. Do this by clicking on each relay in the order you would like them to be addressed. If you need to skip an address or group of addresses, simply create a new zone and enter the desired starting address. If you would like the NPAC to automatically assign relays to consecutive addresses, you may change that in the "Panels" tab.

Please note that selecting sACN/DMX control for a relay or zone, will disable web browser or contact closure control for that relay/zone. Although, relay/zone status may still be monitored by web browser or smartphone.

DMX and sACN are exclusive and cannot be used on the same controller at the same time. Either can be used to control relays in zones while other zones are controlled by IP commands or contact closures.

Panel Setup

This section explains how to setup your NPAC for remote operation.

RELAY SETUP

To add slave panels to the interface, follow these steps:

1. Under Setup, go to the Panels tab.
2. After slave units are wired, click the "Scan Circuits" button.

Figure 5-4

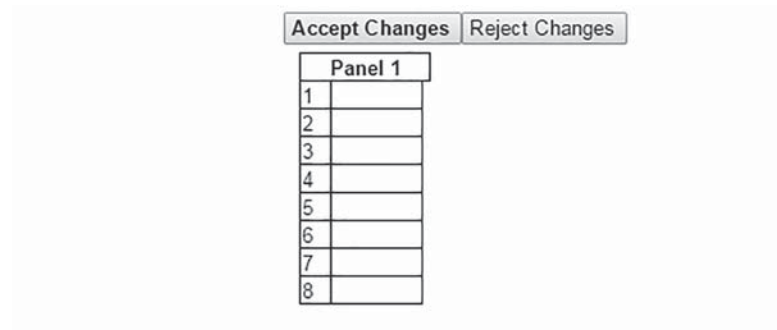

3. If panel configurations are correct, click "Accept Changes"

4. Assign names to the relays. (Figure 5-5)

Figure 5-5

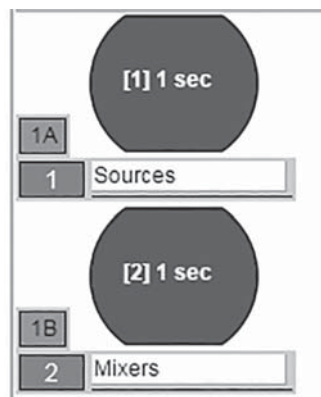

ZONE SETUP

Relays can be controlled individually or arranged into zones. Relays in zones can be toggled at 25 ms intervals (Grouped Operation), at variable intervals (Sequenced Operation), or via DMX or sACN.

To setup a Zone follow these steps:

1. Choose which zone you would like to edit. (Figure 5-6)

Figure 5-6

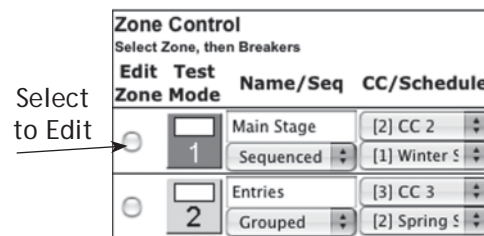

2. Name the Zone. (Figure 5-7)
3. Choose Grouped, Sequenced, DMX or sACN operation.
Note: DMX and sACN may not be used within the same NPAC (Figure 5-7)

Figure 5-7

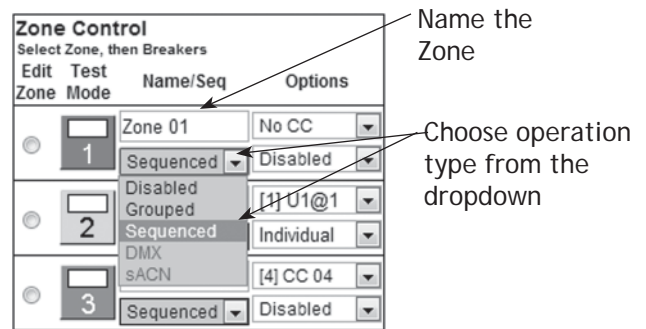

4. If using DMX or sACN operation, select the address set (Figure 5-8) or universe (Figure 5-9) from the

Figure 5-8

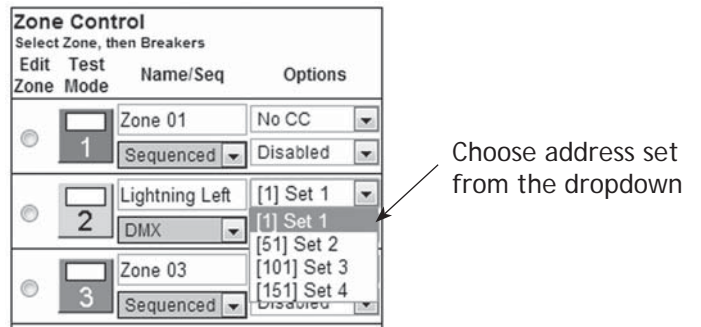
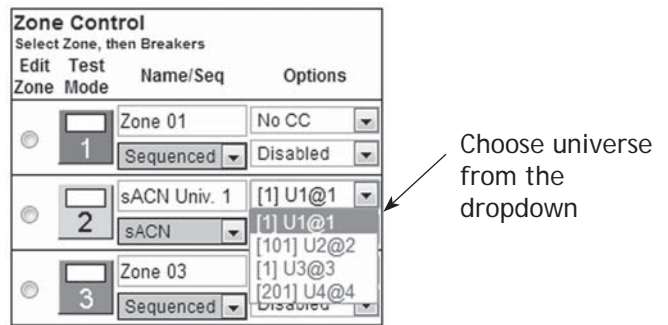
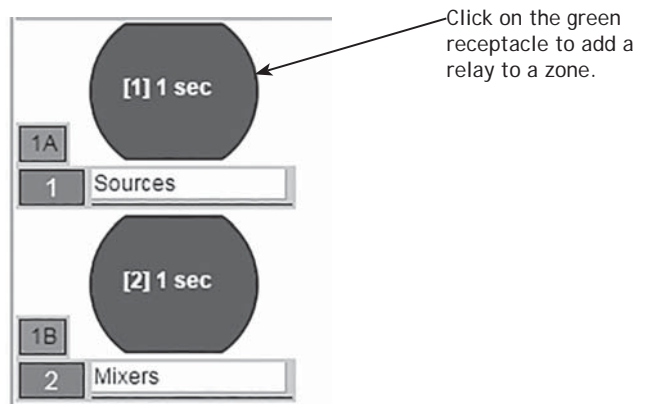

Figure 5-9



5. Select a relay to add to the zone by clicking on the relay you want to add. (Figure 5-10)

Figure 5-10



6. Select the position of the relay in the zone. This sets the order in which they turn on and off. Or in the case of DMX or sACN, the address order. (Figure 5-11). Note: DMX and sACN zones default to individual addressing. If you choose "All Available" the entire panel or panels will change to DMX or sACN.
7. For sequenced operation, select a delay time from the dropdown. Relays in grouped zones toggle in 25ms intervals. (Figure 5-11) Delay time is the amount of time after a relay changes state, before the new relay in sequence changes state. If using one of the custom delay settings, enter the desired delay time in the custom delay setting field. (Figure 5-12)

Figure 5-11

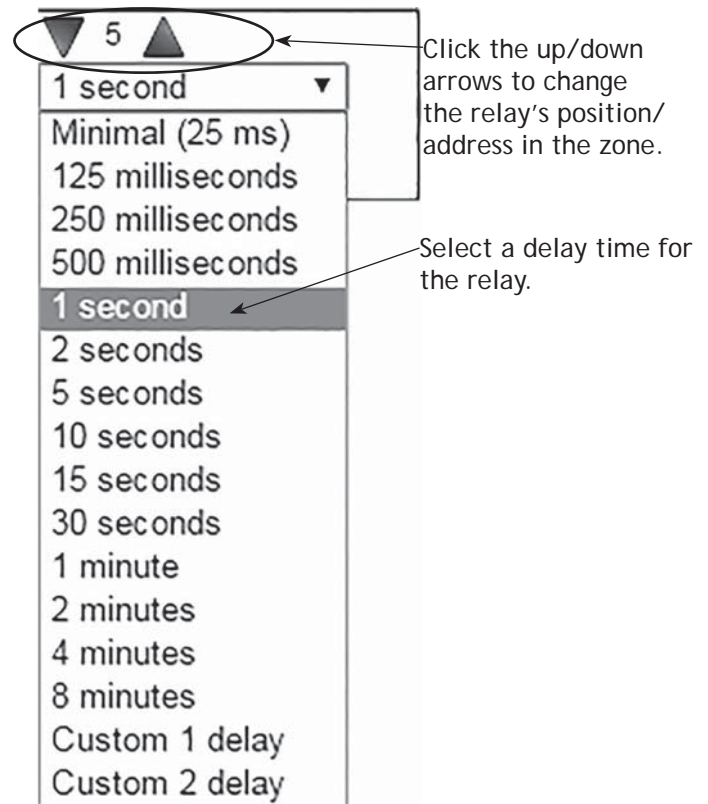
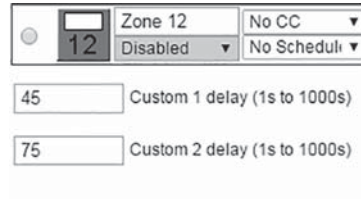
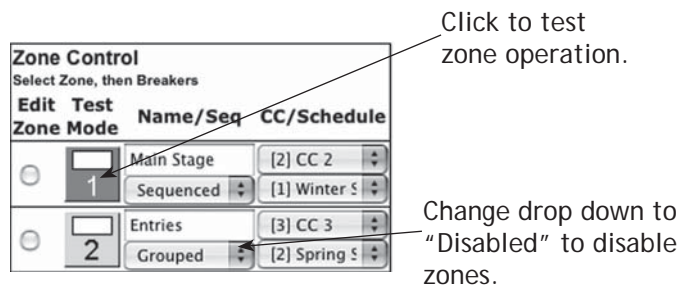

Figure 5-12



8. Click the "Close" button when finished to save. Or, click "Remove" to remove the relay from the zone.
9. When finished adding relays to the zone, click the "Test Mode" (Figure 5-13) button to do a blind test (relays will not actually toggle). Please note that delay times larger than one second are reduced to one second in Test Mode for expediency.

Figure 5-13



10. Disable zones that are not in use so they do not appear in the status and control pages (Figure 5-13).
11. Click "Save Changes" (Figure 5-14) to save zone information when finished.

Figure 5-14



**GLOBAL PREFERENCES
SETUP**

This section guides you through the setup process for the many features and preferences in your NPAC system.

Labeling

In addition to labeling relays, each unit in your NPAC system can be named (up to 16 characters). (Figure 5-15) For multi-NPAC systems, scroll down to see additional panels.

Figure 5-15



Global Control Preferences

The following features can be selected for additional system flexibility

Figure 5-16

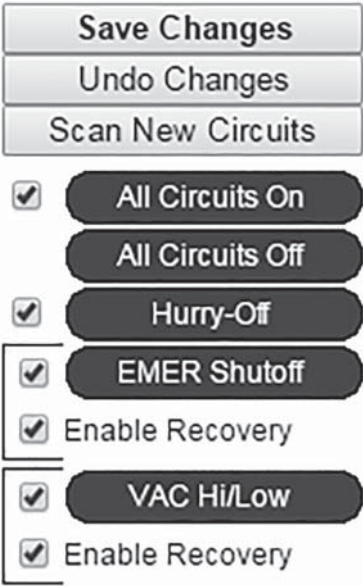
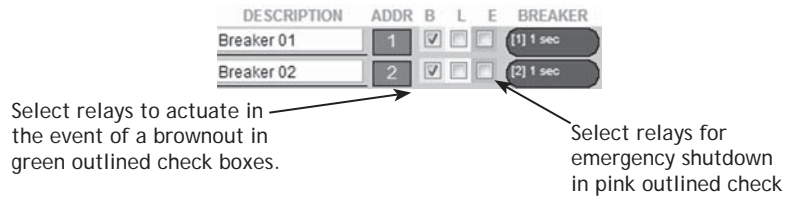

Table 5-1

All Circuits On/Off	Turns all the relays on or off by order of zone and sequence
Hurry-Off	Turns relays off rapidly without sequencing
E. Shutoff	Turns selected relays off when external contacts or emergency management system activates (uses I/O CC#1)
VAC Hi/Low	Turns selected relays off in the event of a brownout or overvoltage event. Sequences circuits back on when voltage has stabilized for 4 seconds.

Selecting Relays for Emergency Shutdown or Brownout

Figure 5-17



Select relays to actuate in the event of a brownout by checking the green box next to the relay. Select relays to turn off in the event of a fire or other emergency by checking the red box next to the relay. The status of unchecked relays will remain unaffected.

Voltage Thresholds

Figure 5-18

Before:

After:

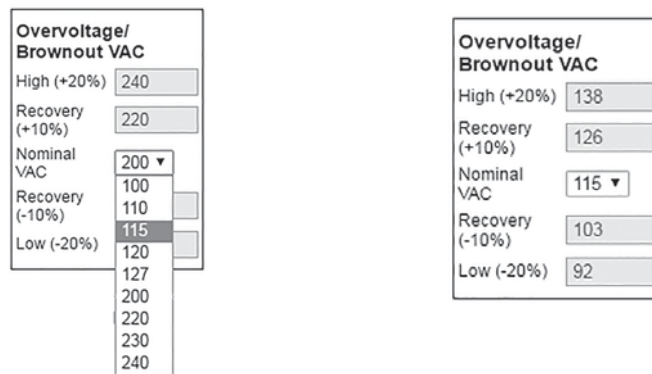

If the brownout and/or overvoltage feature has been selected, the nominal AC Voltage should be set for proper operation. Click the pull down menu in the brownout/overvoltage VAC box and select the nominal operation voltage for the panel (100-240 VAC) The brownout/overvoltage thresholds will automatically adjust for shutoff at nominal -20% and recovery at nominal -10%.

Schedule Setup

Follow these steps to set a schedule (not compatible with DMX or sACN).

1. Enable Schedules in Setup Home tab
2. Rename each schedule as desired
3. Assign weekday (M-F) on and off times by clicking on time and off time buttons, using pull-down menu and clicking the pick button to select.
4. Assign weekend (S-S) on and off times by clicking on time and off time buttons, using pull-down menu and clicking the pick button to select.
5. Enable each schedule by clicking the checkbox for that line.

Figure 5-19

<div style="display: flex; justify-content: space-between; border-bottom: 1px solid black;"> Status Control Setup Contact </div> <div style="display: flex; justify-content: space-between; border-bottom: 1px solid black;"> Setup Home Network Panels Schedules Contact Closures </div> <div style="text-align: center; border-bottom: 1px solid black;"> Save Changes </div>						
Schedule Name	Enabled	Monday - Friday		Weekend		
		On Time	Off Time	On Time	Off Time	
Winter Schedule	<input checked="" type="checkbox"/>	On Time: 10:15 am	Off Time: 5:15 pm	On Time: 10:00 am	Off Time: 3:15 pm	
Spring Schedule	<input checked="" type="checkbox"/>	On Time: 10:15 am	Off Time: 5:15 pm	On Time: 10:00 am	Off Time: 3:15 pm	
Summer Schedule	<input checked="" type="checkbox"/>	On Time: 10:15 am	Off Time: 5:15 pm	On Time: 10:00 am	Off Time: 3:15 pm	
Fall Schedule	<input checked="" type="checkbox"/>	On Time: 10:15 am	Off Time: 5:15 pm	On Time: 10:00 am	Off Time: 3:15 pm	

Assigning Schedules to Zones

To assign a schedule to a zone in the "Panel" screen:

1. Select the desired zone from the drop down box.
2. Save changes.

Figure 5-20

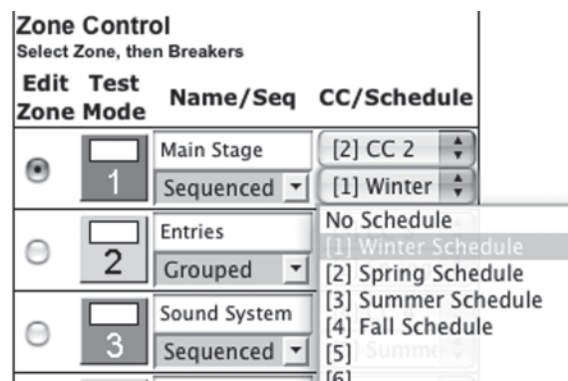

Contact Closure Setup

Configure the digital I/O port and link it to a zone as follows:

Note: If the Emergency Shutoff feature is selected, the first position in the Onboard field (on the Controller) is automatically assigned to that.

1. Rename each contact closure as desired
2. Select contact closure action type
3. Use CC Module 1 and CC Module 2 only if I/O Expander boards are installed.
4. Save Changes

Figure 5-21

Onboard			
	Name	Action	Merge
11	Emergency Shutoff	Maintain N.O. ▼	
22	Parking Lights	Momentary N.O. ▼	U
33	CC 03	Momentary N.O. ▼	M
44	CC 04	Momentary Toggle ▼	M
55	CC 05	Momentary Toggle ▼	

Assigning Contact Closures to Zones

To assign a contact closure to a zone in the "Panel" screen:

1. Select the desired zone from the drop down box.

Figure 5-22

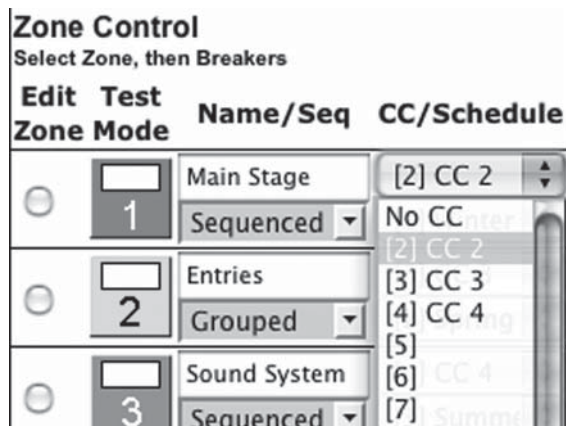

Individual Momentary Contact ON and OFF Pushbuttons

Using a standard LynTec SS-2 Switch Set with illuminated ON switch or two illuminated pushbuttons:

Configure the Digital I/O port and link it to a zone as follows:

1. Follow the previous instructions for naming the contact closure and setting closure type.
2. Click the M button at the right side of the first of the two ports used. The name box and M button in the second port should turn gray and the Action selections should default to Momentary NO. (normally open)
3. Ensure that both of the Action selections for both ports are set to Momentary NO.
4. Enter a name in the text field of the CC used that is indicative of the zone it will control.
5. Click the "Save Changes" button at the top of the Onboard I/O box.
6. Follow the previous instructions for assigning a contact closure to a zone, selecting the merged ports.
7. Click the Save Changes button in the upper left corner of the Panels page.

Verify proper operation of your Switch Set:

1. Press the ON switch. Relays in the selected zone should immediately begin actuating.
2. The ON indicator should flash steadily until all of the relays are in the on state.
3. When the zone has completed, the ON indicator should remain constantly lit.
4. Press the OFF switch. Relays in the selected zone should immediately begin actuating.
5. The ON indicator should flash steadily until all of the relays are in the off state.
6. When the zone has completed, the ON indicator should remain constantly dark. Note: When using two illuminate pushbuttons the OFF indicator will remain constantly lit when the zone has completed. (OFF indicator will extinguish immediately when ON is pressed again.)

Email Alert Setup

Follow these steps to set an email alert

1. Go to Setup Alerts tab
2. Enter email addresses.
3. Select alert types (tripped relay, BO/EO/EL, On Recovery and/or Temperature)
4. If using Temperature alerts, enter the temperature threshold.

Figure 5-24

Email Alerts							
Enter the alert contact email where alert messages should be sent							
	Enter email address(es)	Breaker Trip	BO/EO/EL	On Recovery	Temp	Current Monitoring Only:	
						Branch Overcurrent	Phase Loss
Alert Contact 1:	<input type="text" value="dan@lyntec.com"/>	<input checked="" type="checkbox"/>	<input type="checkbox"/>	<input type="checkbox"/>	<input type="checkbox"/>	<input type="checkbox"/>	<input type="checkbox"/>
Alert Contact 2:	<input type="text"/>	<input type="checkbox"/>	<input type="checkbox"/>	<input type="checkbox"/>	<input type="checkbox"/>	<input type="checkbox"/>	<input type="checkbox"/>
Alert Contact 3:	<input type="text"/>	<input type="checkbox"/>	<input type="checkbox"/>	<input type="checkbox"/>	<input type="checkbox"/>	<input type="checkbox"/>	<input type="checkbox"/>
Alert Contact 4:	<input type="text"/>	<input type="checkbox"/>	<input type="checkbox"/>	<input type="checkbox"/>	<input type="checkbox"/>	<input type="checkbox"/>	<input type="checkbox"/>
Alert Contact 5:	<input type="text"/>	<input type="checkbox"/>	<input type="checkbox"/>	<input type="checkbox"/>	<input type="checkbox"/>	<input type="checkbox"/>	<input type="checkbox"/>
Repeats:	<input type="radio"/> Hourly <input type="radio"/> Daily <input type="radio"/> Weekly				> 150 °F	> 15 A	< 85 V
Ends:	<input type="radio"/> Never <input type="radio"/> After <input type="text" value="2"/> Emails						
If your firewall settings prevents alert messages from being sent by the embedded SMTP server, or if your ISP blocks SMTP port 25, enter a remote SMTP server that alert email messages can be routed through. Some SMTP servers will reject non-fully qualified hostnames, so you may need to change the hostname on this device to FQDN format, e.e. use myhost.domain.com instead of myhost.							
SMTP server:	<input type="text" value="mail.lyntec.com"/>		Port:	<input type="text" value="25"/>			
	<input type="checkbox"/> Use SSL (usually port 465)						
User:	<input type="text" value="rpc_v2@lyntec.com"/>		Optional				
Password:	<input type="text" value="dan321"/>		Optional				
Message:	<input type="text" value="Alert message from RPC Panel"/>						
<input type="button" value="Send Test Message"/>							

Chapter Six: Operating your NPAC

Figure 6-1

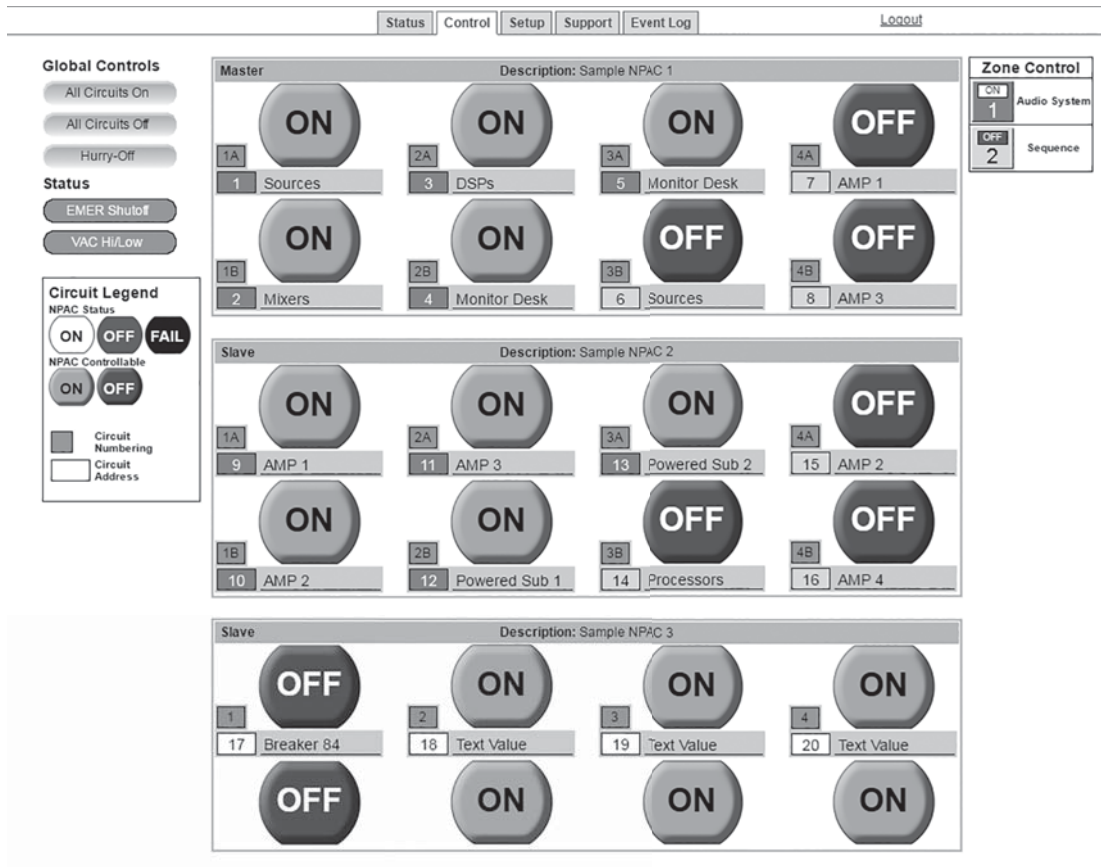

Using the built-in web page

To operate the NPAC using the built in web page, select the control tab from the top of the page. Once on the CONTROL page, simply click each relay for individual control. Or, click a zone for zone control. "All Relays ON" and "All relays OFF" commands can also be executed

Using a secondary controller

For DMX and sACN follow the manufacturer's instructions using the DMX addresses entered in the NETWORK page (see page 16).

TCP/IP schemes are in Appendix B (page 38).

Appendix A--Telnet and TCP/IP Protocols

TELNET PROTOCOL

Note: Telnet port = 23. Send Telnet commands to NPAC IP address/23 (e.g. 192.168.1.250/23)

Table B-1 Command Codes

Command	Decimal	Hexidecimal
Start Byte	176	0xB0
Activate relays	180	0xB4
Deactivate relays	181	0xB5
Request all relays status	183	0xB6
Activate zones	183	0xB7
Deactivate zones	184	0xB8
Request zones status	185	0xB9
Event ON	186	0xBA
Event OFF	187	0xBB
Event status	188	0xBC
Request relays status	189	0xBD
Request bus status	190	0xBE
Relay status identifier	200	0xC8
Zone status identifier	201	0xC9
Event status identifier	202	0xCA
Emergency override identifier	203	0xCB
Checksum identifier	204	0xCC
Checksum digits	205-214	0xCD - 0xD6
Stop byte	240	0xF0

Addressing Scheme

Relay address:

1 byte. Numbers 1 through 168 (0x01 - 0xA8) are assigned to populated relays in sequential order

Zone number: 1 byte (1-12)

Relay Related Commands

Activate relays

0xB0, 0xB4, relay_address_1, ..., relay_address_m, 0xF0

relay_address_1, ..., relay_address_m - addresses of relays to be activated m<=168

Deactivate relays

0xB0, 0xB5, relay_address_1, ..., relay_address_n, 0xF0

relay_address_1, ..., relay_address_n - addresses of relays to be deactivated n<=168

Activate/deactivate relays

0xB0, 0xB5, relay_address_1, ..., relay_address_m, 0xB6, relay_address_1, ..., relay_address_n, 0xF0

relay_address_1, ..., relay_address_m - addresses of relays to be activated relay_address_1, ..., relay_address_n - addresses of relays to be deactivated m+n<=168

Request all relays status

0xB0, 0xB6, 0xF0

Request relays status

0xB0, 0xBD, relay_address_i, relay_address_j, ..., relay_address_n, 0xF0

relay_address_1, ..., relay_address_n - addresses of relays, status of which is requested

Request bus status

0xB0, 0xBE, bus, 0xF0

bus=0-7 - number of bus, status of which is requested

Reply to activate/deactivate relays command: status of updated relays

0xB0, 0xC8, relay_address_i, relay_status_i, relay_address_j, relay_status_j, ..., relay_address_n, relay_status_n, 0xF0

relay_address_i, relay_status_i, relay_address_j, relay_status_j, ..., relay_address_n, relay_status_n

Addresses and status of relays updated by the command reply is generated for

Reply to request relays status command:

Same format as "Request Bus Status"; contains addresses and status of the relays specified in the request command

Reply to request all relays status command: status of all relays

0xB0, 0xB6, byte_1, ..., byte_84, 0xF0

byte_i: bits 7-4: status of relay # 2i, bits 3-0: status of relay # 2i-1, i=1-84

Reply to request bus status command: status of all relays of the requested bus

0xB0, 0xBE, byte_1, ..., byte_11, 0xF0

byte_i format is identical to 3.9, except i=1-11

Relay status description (4 bits) (3,5 &6 panels only)

Value	1	2	3	4	5	6
Status	Off	On	Tripped	Faulty	Empty	Manual On

Zone Related Commands

Activate zone

0xB0, 0xB7, zone_number_1, ..., zone_number_m, 0xF0

zone_number_1, ... zone_number_m - numbers of zones to be activated m<=12

Deactivate zone

0xB0, 0xB8, zone_number_1, ..., zone_number_n, 0xF0

zone_number_1, ... zone_number_n - numbers of zones to be deactivated n<=12

Activate/deactivate zone

0xB0, 0xB7, zone_number_1, ... zone_number_m, 0xB8, zone_number_1, ..., zone_number_n, 0xF0

zone_number_1, ... zone_number_m - numbers of zones to be activated
 zone_number_1, ... zone_number_n - numbers of zones to be deactivated
 m+n<=12

Request zones status*0xB0, 0xB9, 0xF0***Reply to activate/deactivate zone command: status of updated zones***0xB0, 0xC9, zone_address_i, zone_status_i, zone_address_j, zone_status_j, ..., zone_address_n, zone_status_n, 0xF0*

zone_address_i, zone_status_i, zone_address_j, zone_status_j, ..., zone_address_n, zone_status_n - addresses and status of zones updated by the command reply is generated for

Reply to request zone status command: status of all 12 zones*0x40, 0xB9, byte_1, byte_2, byte_3, 0x80*

byte_i: bits 7-6: status of zone # 4i, bits 5-4: status of zone 4i-1, bits 3-2: status of zone 4i-2, bits 1-0: status of zone 4i-3, i=1-3

Event Related Commands**Zone status description (2 bits)**

Value	1	2	3
Status	Off	On	Sequencing

Event ON*0xB0, 0xBA, event_number_1, ..., event_number_m, 0xF0*

event_number_1, ... event_number_m - numbers of events to be turned on

$m \leq 2$

Event OFF*0xB0, 0xBB, event_number_1, ..., event_number_n, 0xF0*

event_number_1, ... event_number_n - numbers of events to be turned off

$n \leq 2$

Event ON/OFF*0xB0, 0xBA, event_number_1, ... event_number_m, 0xBB, event_number_1, ..., event_number_n, 0xF0*

event_number_1, ... event_number_m - numbers of events

to be activated

event_number_1, ... event_number_n - numbers of events to be deactivated

$m+n \leq 2$

Request event status

0xB0, 0xBC, 0xF0

Reply to activate/deactivate event command: status of updated events

0xB0, 0xCA, event_address_i, event_status_i, < event_address_j, event_status_j>, 0xF0

event_address_i, event_status_i, < event_address_j, event_status_j>- addresses and status of events updated by the command reply is generated for

Reply to request event status command: status of all 2 events

0xB0, 0xBC, status_byte, 0xF0

status_byte: bits 3-2: status of event #2, bits 1-0: status of event #1

Device Discovery

Event status description (1 bit)

Value	1	2	3
Status	Off	On	Processing

Beacon request

"AMX\r"

Beacon

"AMXB<-SDKClass=Utility><-Make=Lyntec><-Model=NPAC><-Revision=1.1.4>\r"

(rev changed from 1.1.3; 1.1.3 supported old protocol)

Emergency override response to relay, zone, or event on/off command

Checksum

If system is in Emergency Override mode, it replies to relay, zone or event on/off command with emergency override response

0xB0, 0xCB, 0xF0

Checksum is optional. It is calculated as a sum of all bytes of the message starting with start byte and ending with checksum identifier. Checksum is transmitted as a sequence TCP/IP communications and control via a third party control system is facilitated by the use of the HTTP GET command. In the example below, GET= the NPAC's IP address

TCP/IP PROTOCOL

Example of GET command:

GET /p2.NPAC?IPB002=1

Three modes of control are:

Relay control = "B" Zone control = "Z" Event Control = "E"

Relay Control = B

Refer to LynTec NPAC browser set-up for relay numbering

GET /p2.NPAC?IPB002=1

This control string will turn relay #2 on.

GET /p2.NPAC?IPB002=0

This control string will turn relay #2 off.

Zone Control = Z

Control of up to 167 relays (4 panel system) is possible.

Configure your zones (relay groups) using the LynTec NPAC browser set-up when connected to the LynTec NPAC panel.

GET /p2.NPAC?IPZ002=1

This control string will turn zone #2 on.

GET /p2.NPAC?IPZ002=0

This control string will turn zone #2 off.

Events Control = E

Events include:

- Event 1 = "All Relays ON"
- Event 2 = "All Relays OFF"
- Event 3 = "Hurry OFF" zips all relays off fast.
- Event 4 = "EO" Emergency override (status only)
- Event 5 = "Audio Timer" (NA) (status only)
- Event 6 = "BO" Brown-Out (status only)
- Event 7 = "DMX/sACN"
- Event 8 = "EL" Emergency Lighting

Verification Scheme:

The following GET command will return the current status of all relays, zones and events in the NPAC system.

GET /p2.NPAC

The system will return the following:

*relays=10110111111111111111
zones=111111111011
events=1000000*

The above return is displaying the status of a 20 circuit relays system in which all are presently ON, with the exceptions of relay #2 and relay #5, which are OFF.

The above return is also showing the status of 12 zones, all are ON with the exception of zone #10, which is OFF.

The events return is showing that event #1 is active = "All Relays ON"

Status returns for Relays:	Status returns for Zones and Events:
0 = OFF	0 = OFF
1 = ON	1 = ON
2 = Relay Tripped (panels only)	2 = Processing
3 = Failure	
4 = Manual On (panels only)	
5 = Empty	

Appendix B--Troubleshooting

TROUBLESHOOTING THE NPAC Use the following table if you need to troubleshoot the NPAC controller.

Table B-1: NPAC Controller Troubleshooting

Condition	Possible Causes	Solutions
Front panel LCD Dark, no activity	No power connected to input #1.	Connect power to input #1
Unable to connect to web page	Incorrect IP address	Verify IP address on front panel display
	Anti-Virus software on PC	Disable AV software to test
Unable to control with switch set	Incorrect wiring	Test continuity of wiring. Check to make sure solder connections are secure
	Contact closure setup incomplete	Check to make sure CC setup is complete. See Ch.5 for instructions

Inputs	Five (5) independently configurable digital inputs/ outputs
Input Types	Maintained N.O. Maintained N.C. Momentary N.O. Momentary N.C. Momentary toggle
Status Output	24 Vdc (60mA maximum load for all outputs combined) Indicator output on each I/O port
Communication Interface	RJ-45 (8P8C) Ethernet/Web Server DMX in/thru 3-wire
Circuit relay delay	0.025 sec to 999 sec (selectable)
Environmental Standards	Operating Temperature: -5°C to +60°C (internal emperature) Storage Temperature: -20°C to 85°C Operating Humidity: 5% to 95%
Time Clock	Operation during absence of power = >2 years
Memory Retention	Program: > 20 years
Standards	Pending
ESD Immunity	IEC 1000, Level 4
RF Susceptibility	IEC 1000, Level 3
Electrical Fast Transient Susceptibility	IEC 1000, Level 3
Electrical Surge Suceptibility-- power line	IEC 1000, Level 4
Electrical Surge Suceptibility-- data line	IEC 1000, Level 3
FCC--Part 15, Class A	
ETL Tested to: Pending	

Appendix C--Installation Diagram

