

VocoPro[®]

PROFESSIONAL VOCAL SYSTEMS[™]

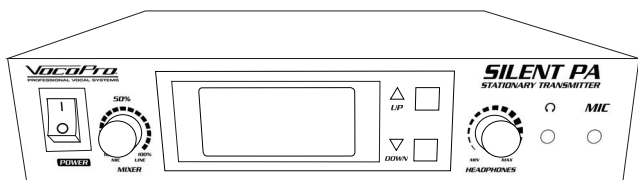
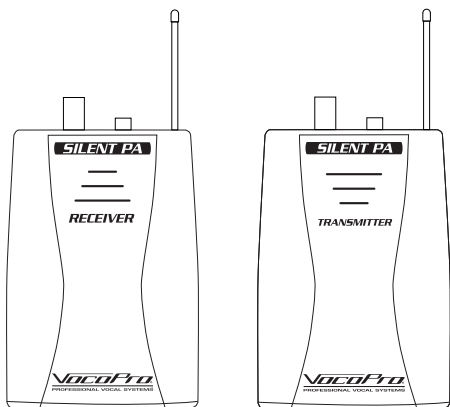

Silent PA

Wireless Audio Broadcast System

o w n e r ' s m a n u a l

TABLE OF CONTENTS

Safety Instructions	3
FCC Information	5
Welcome.	7
Listening for a Lifetime	8
Getting Started.	9
Getting Connected	10-13
• Connecting Stationary Transmitter	10
• Connecting Bodypack Transmitter	12
• Connecting Bodypack Receiver	13
Setting the Wireless Channel	14
Descriptions & Details.	15-18
• Stationary Transmitter	15
• Bodypack Transmitter	16
• Bodypack Receiver	17
Brackets and Mounting	18
Troubleshooting	20
Commonly Asked Questions	20



CAUTION RISK OF SHOCK



CAUTION: To reduce the risk of electric shock, do not remove cover (or back). No user-serviceable parts inside. Only refer servicing to qualified service personnel.

Explanation of Graphical Symbols



The lightning flash & arrowhead symbol, within an equilateral triangle, is intended to alert you to the presence of danger.



The exclamation point within an equilateral triangle is intended to alert you to the presence of important operating and servicing instructions.

WARNING

To reduce the risk of fire or electric shock, do not expose this unit to rain or moisture.

- 1. Read Instructions** - All the safety and operating instructions should be read before the appliance is operated.
- 2. Retain Instructions** - The safety and operating instructions should be retained for future reference.
- 3. Heed Warnings** - All warnings on the appliance and in the operating instructions should be adhered to.
- 4. Follow Instructions** - All operating and use instructions should be followed.
- 5. Attachments** - Do not use attachments not recommended by the product manufacturer as they may cause hazards.
- 6. Water and Moisture** - Do not use this unit near water. For example, near a bathtub or in a wet basement and the like.
- 7. Carts and Stands** - The appliance should be used only with a cart or stand that is recommended by the manufacturer.
- 7 A.** An appliance and cart combination should be moved with care. Quick stops, excessive force, and uneven surfaces may cause an overturn.



- 8. Ventilation** - The appliance should be situated so its location does not interfere with its proper ventilation. For example, the appliance should not be situated on a bed, sofa, rug, or similar surface that may block the ventilation slots.
- 9. Heat** - The appliance should be situated away from heat sources such as radiators, heat registers, stoves, or other appliances (including amplifiers) that produce heat.
- 10. Power Sources** - The appliance should be connected to a power supply only of the type described in the operating instructions or as marked on the appliance.
- 11. Grounding or Polarization** - Precautions should be taken so that the grounding or polarization means of an appliance is not defeated.
- 12. Power-Cord Protection** - Power-supply cords should be routed so that they are not likely to be walked on or pinched by items placed upon or against them, paying particular attention to cords at plugs, convenience receptacles, and the point where they exit from the appliance.
- 13. Cleaning** - Unplug this unit from the wall outlet before cleaning. Do not use liquid cleaners or aerosol cleaners. Use a damp cloth for cleaning.
- 14. Power lines** - An outdoor antenna should be located away from power lines.
- 15. Nonuse Periods** - The power cord of the appliance should be unplugged from the outlet when left unused for a long period of time.
- 16. Object and Liquid Entry** - Care should be taken so that objects do not fall and liquids are not spilled into the enclosure through openings.
- 17. Damage Requiring Service** - The appliance should be serviced by qualified service personnel when:
 - A. The power supply cord or plug has been damaged; or
 - B. Objects have fallen into the appliance; or
 - C. The appliance has been exposed to rain; or
 - D. The appliance does not appear to operate normally or exhibits a marked change in performance; or
 - E. The appliance has been dropped, or the enclosure damaged.
- 18. Servicing** - The user should not attempt to service the appliance beyond that described in the operating instructions. All other servicing should be referred to qualified service personnel.

Note:

To CATV system installer's (U.S.A.): This reminder is provided to call the CATV system installer's attention to Article 820-40 of the NEC that provides guidelines for proper grounding and, in particular, specifies that the cable ground shall be connected as close to the point of cable entry as practical.

1. IMPORTANT NOTICE: DO NOT MODIFY THIS

UNIT!: This product, when installed as indicated in the instructions contained in this manual, meets FCC requirements. Modifications not expressly approved by Vocopro may void your authority, granted by the FCC, to use this product.

2. IMPORTANT: When connecting this product to accessories and/or another product use only high quality shielded cables. Cable(s) supplied with this product **MUST** be used. Follow all installation instructions. Failure to follow instructions could void your FCC authorization to use this product in the U.S.A.

3. NOTE: This product has been tested and found to comply with the requirements listed in FCC Regulations, Part 15 for Class "B" digital devices. Compliance with these requirements provides a reasonable level of assurances that your use of this product in a residential environment will not result in harmful interference with other electronic devices. This equipment generates/uses radio frequencies and, if not installed and used according to the instructions found in the owner's manual, may cause interference harmful to the operation of other electronic devices. Compliance with FCC regulations does not guarantee that interference will not occur in all installations. If this product is found to be the source of interference, which can be determined by turning the unit "Off" and "On", please try to eliminate the problem by using one of the following measures:

Relocate either this product or the device that is being affected by the interference.

Use power outlets that are on different branch (circuit breaker or fuse) circuits or install AC line filter(s).

In the case of radio or TV interference, relocate/reorient the antenna. If the antenna lead-in is 300-ohm ribbon lead, change the lead-in to coaxial type cable.

If these corrective measures do not produce satisfactory results, please contact your local retailer authorized to distribute Vocopro products. If you can not locate the appropriate retailer, please contact Vocopro, 1728 Curtiss Court, La Verne, CA 91750.

CAUTION

The apparatus is not disconnected from the AC power source if it is connected to the wall outlet, even if the apparatus itself is turned off. To fully ensure that the apparatus is indeed fully void of residual power, leave unit disconnected from the AC outlet for at least fifteen seconds.

CALIFORNIA PROP 65 WARNING

WARNING: This product contains chemicals known to the state of California to cause cancer and birth defects or other reproductive harm. (California law requires this warning to be given to customers in the State of California.)

For more information: www.vocopro.com/prop65

CAUTION:

READ THIS BEFORE OPERATING YOUR UNIT

1. To ensure the finest performance, please read this manual carefully. Keep it in a safe place for future reference.
2. Install your unit in a cool, dry, clean place - away from windows, heat sources, and too much vibration, dust, moisture or cold. Avoid sources of hum (transformers, electric motors). To prevent fire or electrical shock, do not expose to rain and water.
3. Do not operate the unit upside-down.
4. Never open the cabinet. If a foreign object drops into the set, contact your dealer.
5. Place the unit in a location with adequate air circulation. Do not interfere with its proper ventilation; this will cause the internal temperature to rise and may result in a failure.
6. Do not use force on switches, knobs or cords. When moving the unit, first turn the unit off. Then gently disconnect the power plug and the cords connecting to other equipment. Never pull the cord itself.
7. Do not attempt to clean the unit with chemical solvents: this might damage the finish. Use a clean, dry cloth.
8. Be sure to read the "Troubleshooting" section on common operating errors before concluding that your unit is faulty.
9. This unit consumes a fair amount of power even when the power switch is turned off. We recommend that you unplug the power cord from the wall outlet if the unit is not going to be used for a long time. This will save electricity and help prevent fire hazards. To disconnect the cord, pull it out by grasping the plug. Never pull the cord itself.
10. To prevent lightning damage, pull out the power cord and remove the antenna cable during an electrical storm.
11. The general digital signals may interfere with other equipment such as tuners or receivers. Move the system farther away from such equipment if interference is observed.

NOTE:

Please check the copyright laws in your country before recording from records, compact discs, radio, etc. Recording of copyrighted material may infringe copyright laws.

Voltage Selector (General Model Only)

Be sure to position the voltage selector to match the voltage of your local power lines before installing the unit.

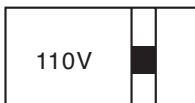

Welcome

And thank you for purchasing the Silent P.A. from VocoPro, your ultimate choice in Karaoke entertainment! With years of experience in the music entertainment business, VocoPro is a leading manufacturer of Karaoke equipment, and has been providing patrons of bars, churches, schools, clubs and individual consumers the opportunity to sound like a star with full-scale club models, in-home systems and mobile units. All our products offer solid performance and sound reliability, and to reinforce our commitment to customer satisfaction, we have customer service and technical support professionals ready to assist you with your needs. We have provided some contact information for you below.

VocoPro

1728 Curtiss Court

La Verne, CA 91750

Toll Free: 800-678-5348

TEL: 909-593-8893

FAX: 909-593-8890

VocoPro Company Email Directory

Customer Service & General Information

info@vocopro.com

Tech Support

techsupport@vocopro.com

Remember Our Website

Be sure to visit the VocoPro website www.vocopro.com for the latest information on new products, packages and promos. And while you're there don't forget to check out our Club VocoPro for Karaoke news and events, chat rooms, club directories and even a KJ Service directory!

We look forward to hearing you sound like a PRO, with VocoPro, the singer's ultimate choice.

Selecting fine audio equipment such as the unit you've just purchased is only the start of your musical enjoyment. Now it's time to consider how you can maximize the fun and excitement your equipment offers. VocoPro and the Electronic Industries Association's Consumer Electronics Group want you to get the most out of your equipment by playing it at a safe level. One that lets the sound come through loud and clear without annoying blaring or distortion and, most importantly, without affecting your sensitive hearing.

Sound can be deceiving. Over time your hearing "comfort level" adapts to a higher volume of sound. So what sounds "normal" can actually be loud and harmful to your hearing. Guard against this by setting your equipment at a safe level BEFORE your hearing adapts.

To establish a safe level:

- Start your volume control at a low setting.
- Slowly increase the sound until you can hear it comfortably and clearly, and without distortion.

Once you have established a comfortable sound level:

- Set the dial and leave it there.
- Pay attention to the different levels in various recordings.

Taking a minute to do this now will help to prevent hearing damage or loss in the future. After all, we want you listening for a lifetime.

Used wisely, your new sound equipment will provide a lifetime of fun and enjoyment. Since hearing damage from loud noise is often undetectable until it is too late, this manufacturer and the Electronic Industries Association's Consumer Electronics Group recommend you avoid prolonged exposure to excessive noise. This list of sound levels is included for your protection.

Some common decibel ranges:

Level	Example
30	Quiet library, Soft whispers
40	Living room, Refrigerator, Bedroom away from traffic
50	Light traffic, Normal conversation
60	Air conditioner, at 20ft., Sewing machine
70	Vacuum cleaner, Hair Dryer, Noisy restaurant
80	Average city traffic, Garbage disposals, Alarm clock at 2ft.

The following noises can be dangerous under constant exposure:

Level	Exposure
90	Subway, Motorcycle, Truck traffic, Lawn mower
100	Garbage truck, Chainsaw, Pneumatics drill
120	Rock band concert in front of speakers
140	Gunshot blast, Jet plane
180	Rocket launching pad

-Information courtesy of the Deafness Research Foundation

GETTING STARTED

WHAT'S IN THE BOX: STATIONARY TRANSMITTER

- Stationary Transmitter (ST)
- 1/4"-to-1/4" Stereo Cable
- Antenna
- Rack Mount Kit
- Power Adapter

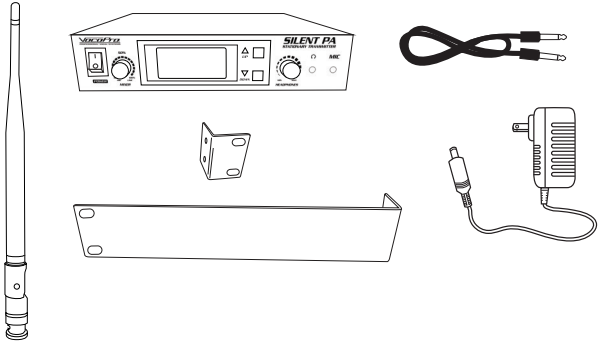

WHAT'S IN THE BOX: BODYPACK TRANSMITTER

- Bodypack Transmitter (BT)
- 1/8"-to-1/8" Stereo Cable
- 1/8"-to-1/4" Stereo Conversion Cable
- Micro-USB Charging Cable (Adapter Not Included)
- Lavalier Microphone

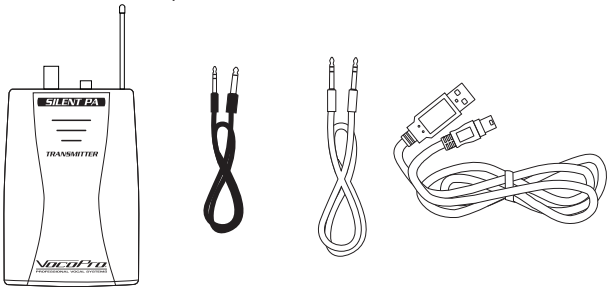

WHAT'S IN THE BOX: BODYPACK RECEIVER

- Bodypack Receiver (BR)
- (2) 1/8"-to-1/8" Stereo Cable
- (2) 1/8"-to-1/4" Stereo Conversion Cable
- Micro-USB Charging Cable (Adapter Not Included)

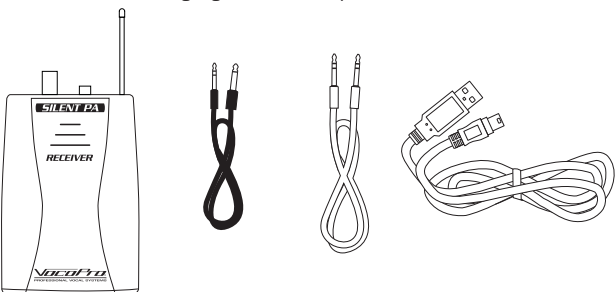

GETTING CONNECTED

CONNECTING THE STATIONARY TRANSMITTER (ST)

1. Plug the included power adapter into the ST.
2. Insert the music signal:
 - With the Input Select set to LINE IN, plug in the LEFT & RIGHT channels from the music source output (i.e. mixer, player, etc.) into the LEFT/RIGHT XLR-1/4" Combo Input Jacks on the back of the ST.

OR

- Plug an 1/8" stereo cable from the music source (i.e. laptop, smartphone, MP3 player, etc.) into the 1/8" LINE IN jack on the back of the ST.
3. Insert the Microphone Signal:
 - Plug in the microphone into the MIC IN available on the back of the ST.

OR

- With the Input Select set to MIC IN, plug in up to two (2) microphones into LEFT/RIGHT XLR-1/4" Combo Jacks on the back of the ST; one in each jack.
- Plug in a third microphone into the MIC IN jack on the far right side in the back of the ST.

Note: When the Input Select is set to MIC IN, microphones plugged into the LEFT/RIGHT XLR-1/4" Combo Jacks will be considered LINE inputs on the front MIC/LINE Mixer knob. See Descriptions & Details for more information.

Note: The 1/8" LINE IN jack enables the Silent PA to accommodate up to three (3) microphones, plus music. MIC/LINE Mixer knob must be in middle position to hear all three mic signals simultaneously.

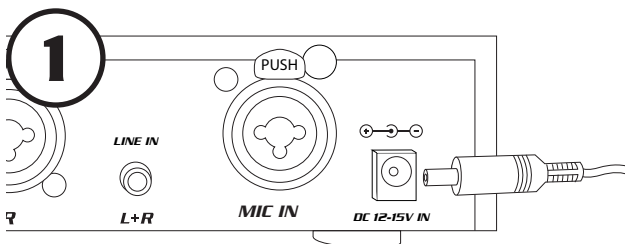

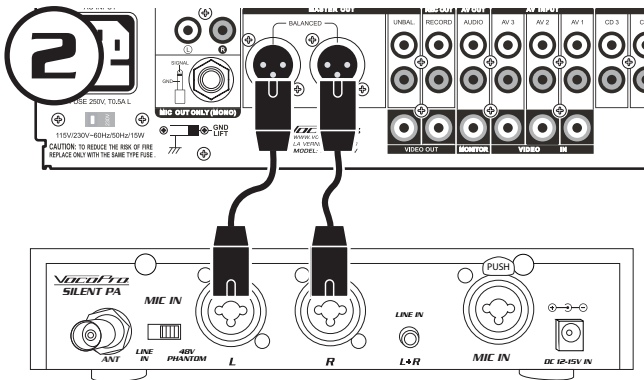
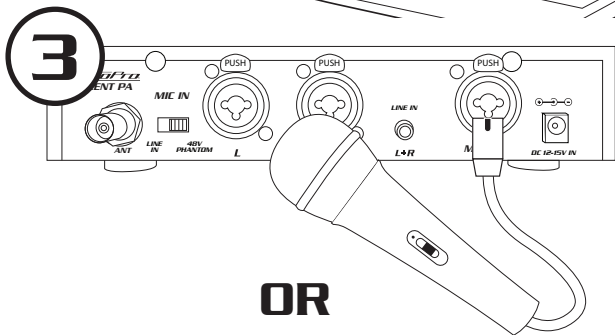
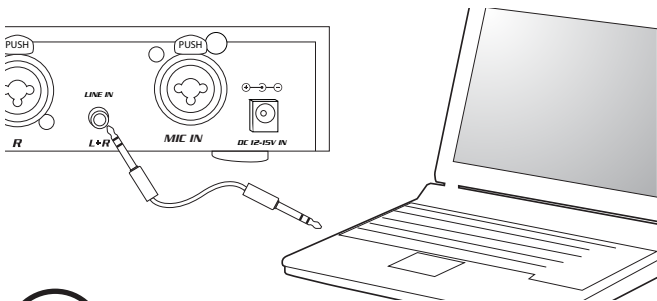
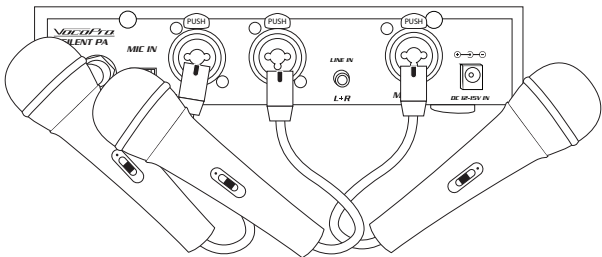

Illustration shown using XLR cables. Connection can also be made using 1/4" Stereo Cables

OR



OR



Illustrations shown with XLR connections. Microphones with 1/4" cables can also be connected to the MIC IN and LEFT/RIGHT XLR-1/4" Combo Jacks.

CONNECTING THE BODYPACK TRANSMITTER (BT)

1. Insert (2) AA batteries into the Bodypack Transmitter.
2. Insert the music signal:
 - Plug in an 1/8" stereo cable from the music source output (i.e. laptop, smartphone, MP3 player, etc.) into the AUX input available on the side of the BT.
3. Insert the microphone signal:
 - Plug in the included microphone into the MIC IN mini-XLR jack available on the Top of the BT.

Note: The BT has no music volume control; it must be controlled from the music source. The volume knob on the BT controls the mixed volume of BOTH microphone & music signals.

1

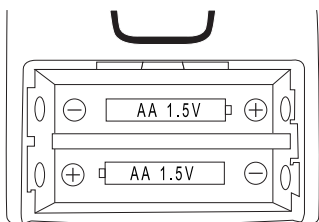

2

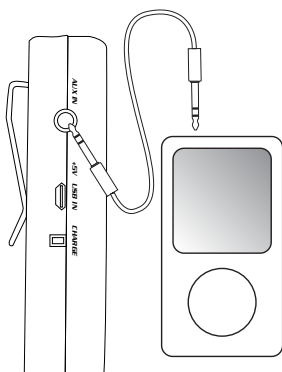

3

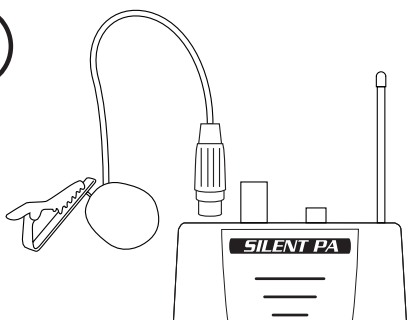

CONNECTING THE BODYPACK RECEIVER (BR)

1. Insert (2) AA batteries into the Bodypack Receiver.
2. Output the audio signal to sound systems:
 - To Powered Speakers–
Plug in an 1/8" stereo cable from the headphone output on the BR to an available input on the powered speakers.
 - To a stereo Receiver–
Plug in an 1/8" stereo cable from the headphone output on the BR to an available input on the stereo receiver.

Note: With the appropriate cables, the BR can be connected to any type of sound system that accepts audio signal.

Note: Depending on the connections needed on the powered speakers or stereo receiver, you may require an 1/8"-to-1/8" stereo cable OR an 1/8"-to-RCA.

1

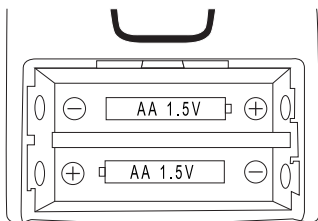

2

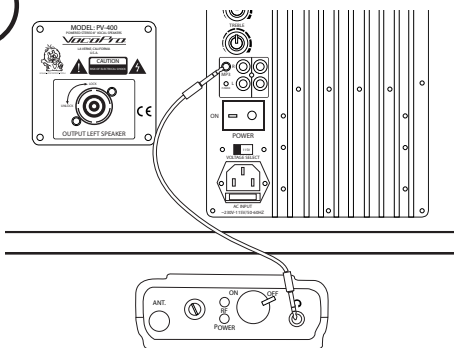

POWERED SPEAKER CONNECTION

ALSO

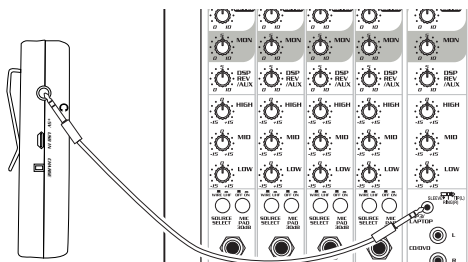

STEREO RECEIVER CONNECTION

SETTING THE WIRELESS CHANNEL

Once the physical connections to the transmitters and receiver are made, the next step is establishing a wireless connection.

SELECTING A CLEAR CHANNEL ON THE BODYPACK RECEIVER (BR)

1. Power **ONLY** the BR on; leave the Stationary and Bodypack Transmitters powered off.
2. Change the channel by twisting the Channel Select knob
3. Observe the Status Indicator as the channel changes
 - If the LED stays on, the channel is not clear.
 - If the LED blinks, the channel is not clear.
 - If the LED stays off, the channel is clear and is good to use.

After a channel has been discovered, tune either the Stationary Transmitter (ST) or the Bodypack Transmitter (BT) to the same channel. Refer to Descriptions & Details for more information.

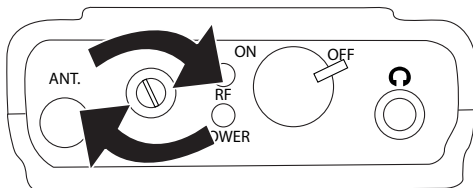

DESCRIPTIONS & DETAILS

STATIONARY TRANSMITTER (ST)

FRONT PANEL

1. **Power** - This powers the ST OFF/ON.
2. **Mixer Knob** - This balances the audio signals plugged into the MIC and LINE IN jacks.
 - Turn completely counter-clockwise for only Microphone audio.
 - Turn completely clockwise for only Line audio.
 - Turn knob to middle position for 50/50 mix of both Microphone and Line audio.

Note: Microphones plugged into the L/R XLR-1/4" Combo Jacks will be inaudible when Mixer knob is set to 100% MIC.

3. **Frequency Display** - This LCD display shows the current channel and its frequency.
4. **Channel Selectors** - These buttons select the channel to be used.
 - Up - This button cycles the channel selector upwards numerically.
 - Down - This button cycles the channel selector downwards numerically.
5. **Headphone Volume** - This knob adjusts the volume of the headphone jack.
6. **Headphone Jack** - This jack outputs both mic & music signal via an 1/8" Stereo jack.

Note: Audio will still be transmitted if headphones are inserted in the headphone jack.

7. **Mic In** - This jack is available for a microphone with an 1/8" connection.

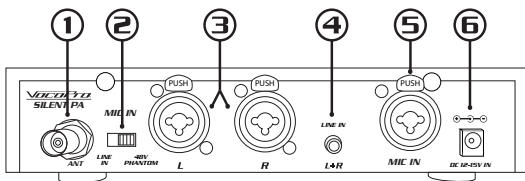
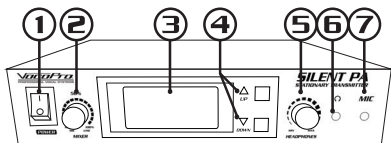

STATIONARY TRANSMITTER (ST)

REAR PANEL

1. **Ant** - Connect the antenna to this post.
2. **Input Selector** - This switch determines the assignment of the L/R XLR-1/4" Combo Jacks:
 - LINE IN - When set to this position, the L/R XLR-1/4" Combo Jacks are LINE inputs able to accept signal from an instrument or music source (i.e. Laptop, smartphone, MP3 player, etc.).

Note: If using a music source, the volume must be controlled from the source to strike a balance between the music and microphone volume in order to hear the microphones clearly.

- **MIC IN** - When set to this position, the L/R XLR-1/4" Combo Jacks are Microphone Inputs, able to accept signal from microphones via XLR or 1/4" cables.
- **48V Phantom** - When set to this position, 48 volt phantom power is applied to XLR jacks for use with Powered Microphones.

Note: A popping noise will occur if instruments are connected with XLR jacks in the L/R XLR-1/4" Combo Jacks and the input selector is set to 48V Phantom. Use the 1/4" plug to use BOTH instruments and powered microphones.

- 3. L/R XLR-1/4" Combo Jacks** - These jacks double as both XLR and 1/4" input jacks. The larger, center hole is the 1/4" input, and the triangular 3-pins are the XLR input.
 - These jacks can accept signal from an instrument, music source, or microphone. The Input Selector switch determines which to use.
- 4. 1/8" LINE IN** - This stereo jack accepts signal from a music source (i.e. laptop, smartphone, MP3 player, etc.).
- 5. MIC IN** - This XLR-1/4" Combo Jack accepts signals from microphones. It can accept either an XLR or 1/4" connection. It can also accept a powered microphone if the Input Selector is set to 48V Phantom.
- 6. DC 12-15V IN** - This is where the power adapter is connected.

BODYPACK TRANSMITTER (BT)

- 1. Ant** - This permanent antenna sends signals to the receiver.
- 2. Channel Selector** - This knob changes the operational frequency. Twist the knob either direction to change the channel. As it turns, the knob will click; one click is one channel change. See Setting the Wireless Channel for instructions to find a clear channel.
- 3. Power LED** - This LED indicates power to the transmitter.
 - If the LED is green, the battery level is good.
 - If the LED is red, the battery level is low. Change or recharge the batteries.
- 4. Power/Volume** - This knob doubles as the power and volume knob. Twist clockwise until it clicks to power on the transmitter. Once powered on, this adjusts the transmitted volume.
 - If using both a music source and microphone, the music source volume must be balanced with the microphone audio in order to get audible audio from the microphone.
- 5. MIC IN** - This mini-XLR jack accepts a microphone, such as a headset or lavalier.
- 6. AUX IN** - This 1/8" stereo input jack accepts signal from a music source (i.e. laptop, smartphone, MP3 player, etc.).
- 7. +5V USB IN** - This mini-USB connection is used to recharge the batteries, if rechargeable batteries are installed.

Note: DO NOT ATTEMPT TO RECHARGE ALKALINE BATTERIES; BATTERIES MAY EXPLODE.

Note: This input will NOT interface with a computer or any other device; it will only charge the batteries if plugged into a computer.

8. **Charge Indicator** - This LED indicates the charge level when recharging the batteries
 - If LED is green, batteries are charged.
 - If LED is red, batteries are charging.
9. **Battery Compartment** - This is where the two (2) AA batteries are installed.
 - Either alkaline or rechargeable batteries can be used. Only rechargeable batteries can be used with the +5V USB IN.
10. **Clip** - This metal spring will hold the transmitter in place when attached.

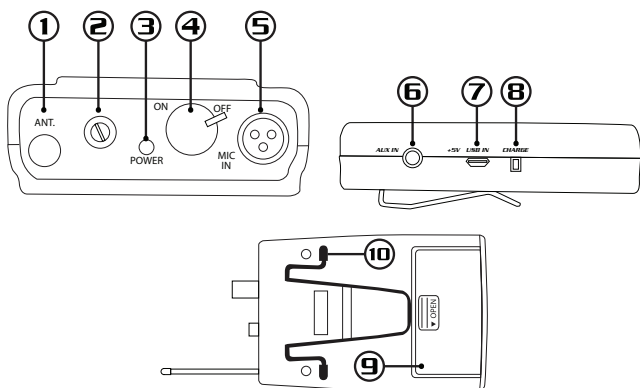

BODYPACK RECEIVER (BR)

1. **Ant** - This permanent antenna receives signals from the transmitter.
2. **Channel Selector** - This knob changes the operational frequency. Twist knob either direction to change the channel. As it turns, the knob will click; one click is one channel change. See Setting the Wireless Channel for instructions to find a clear channel.
3. **Power LED** - This LED indicates power to the receiver.
 - If the LED is green, the battery level is good.
 - If the LED is red, the battery level is low. Change or recharge the batteries.
4. **RF Status** - This LED indicates connection status.
 - If the LED is red, there is a connection between the receiver and transmitter.
 - If the LED is off, there is no connection.
5. **Power/Volume** - This knob doubles as the power and volume knob. Twist clockwise until it clicks to power on the receiver. Once powered on, this adjusts the receiver output volume.
6. **Headphone Out #1** - This 1/8" stereo jack outputs the received audio.
7. **Headphone Out #2** - This second 1/8" stereo jack outputs the received audio.

Note: The output audio will be slightly lower if both Headphone Out #1 & #2 are used simultaneously.

8. **+5V USB IN** - This mini-USB connection is used to recharge the batteries, if rechargeable batteries are installed.

Note: DO NOT ATTEMPT TO RECHARGE ALKALINE BATTERIES; BATTERIES MAY EXPLODE.

Note: This input will NOT interface with a computer or any other device; it will only charge the batteries if plugged into a computer.

9. **Charge Indicator** - This LED indicates the charge level when recharging the batteries.

- If LED is green, batteries are charged.
- If LED is red, batteries are charging.

10. **Battery Compartment** - This is where the two (2) AA batteries are installed.

- Either alkaline or rechargeable batteries can be used. Only rechargeable batteries should be used with the +5V USB IN.

11. **Clip** - This metal spring will hold the receiver in place when attached.

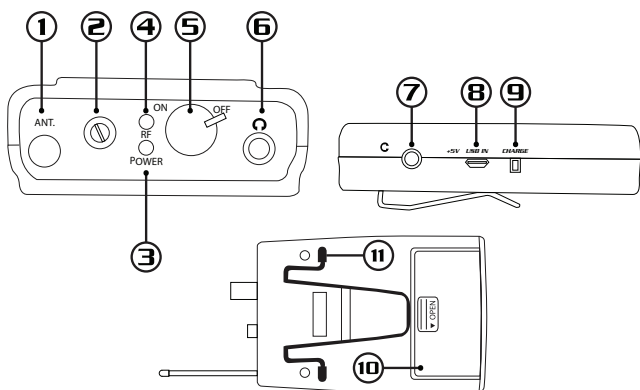

BRACKETS AND MOUNTING

The Silent P.A. is packaged with a bracket kit to allow installation into standard 19" rack mounts.

Mounting with a single Stationary Transmitter (ST):

1. Remove the 4 phillips head screws; 2 on either side of the ST.
2. Attach the large and small brackets on either sides of the ST.
3. Secure the entire receiver into a 19" rack case with the mounting brackets.

Note: When installed into a rack case, the antennas will need an open back to the rack to ensure full range.

1

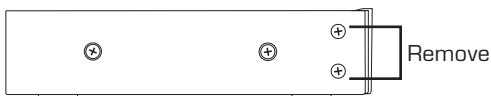

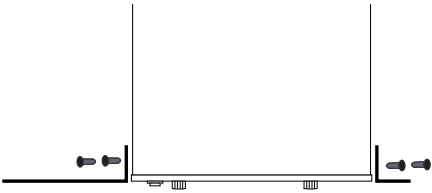
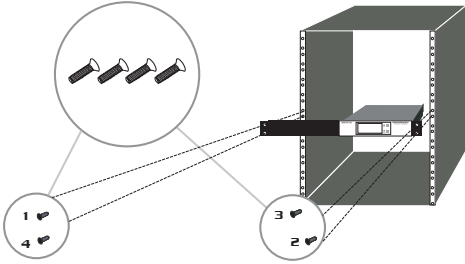
2**3**

Mounting with 2 Stationary Transmitters (ST):

1. Remove the 4 phillips head screws; 2 on either side of the STs.
2. Remove 1 screw from the bottom of each ST.
3. Attach the included small square bracket to bottom plate of both STs; secure with 1 screw on each side.
4. Attach the included small bracket on both sides of the ST.
5. Secure both STs into a standard 19" rack case.

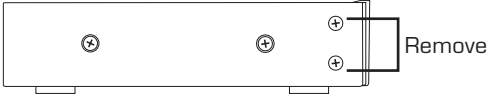
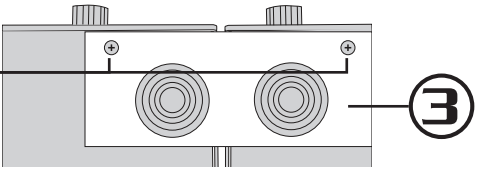
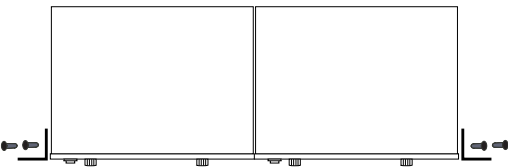
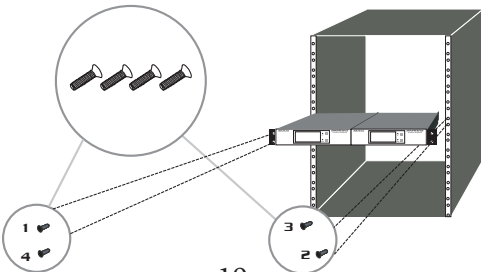
1**2****4****5**

TROUBLESHOOTING

1. There is no audio output.

- Ensure transmitter and receiver are on the same channel.
- Check the Power LED on both Bodypack Transmitter and Bodypack Receiver, if red, change or recharge batteries.
- Check the power adapter on the Stationary Transmitter to ensure it is the correct adapter and that it is not faulty.
- Make sure the antenna is securely fastened into place.
- Double-check the connections between the music sources, microphones, and the Silent PA.

2. There is no music audio.

- If connecting the music source with the L/R XLR-1/4" Combo Jacks, make sure the Input Select switch is set to the LINE IN position.
- If mixer knob is set to greater than 50% MIC, the music volume will be very low.
- Make sure music source volume is turned up.
- Check the connections between the music source and the Silent PA Transmitters.

3. There is no microphone audio.

- If connection microphones into the L/R XLR-1/4" Combo Jacks, make sure the Input Select switch is set to the MIC IN position.
- If connecting microphones into the L/R XLR-1/4" Combo Jacks, the Mixer knob on the front must be set to at least 50% LINE to be audible.
- If connecting a microphone into the MIC IN XLR-1/4" Combo Jack, the Mixer knob on the front must be set to at least 50% MIC to be audible.
- If your microphone is powered, make sure the Input Select switch is set to 48V Phantom.
- Double-check all microphone connections to the Silent PA.

4. There is a popping noise in the instrument and music audio

- This will occur if the Input Select switch is set to 48V Phantom and the instrument/music sources were plugged into the L/R XLR inputs.
- Change the Input Selector switch to LINE IN
OR
- Use the L/R 1/4" inputs

5. The music audio is much louder than the microphone.

- Turn the volume down on the music source.
- If the microphone is plugged into MIC IN, turn the Mixer knob counter-clockwise to apply more microphone signal and less music.
- Adjust both of the above until the audio is balanced.

COMMONLY ASKED QUESTIONS

There are 16 channels, does that mean I can have 16 sources all on their own channel?

If there was no frequency interference on any of the 16 channels then yes you can. More than likely, there will be some channels that cannot be used due to local interference.

How many microphones can I plug into the Silent PA Stationary Transmitter?

The Stationary Transmitter has jacks for up to 4 microphones; three (3) XLR-1/4" Combo Jacks and one (1) 1/8" Microphone input.

What kind of rechargeable batteries can be installed in the Bodypack Transmitter and Receiver?

Any type of rechargeable battery will work so long as they are AA. (i.e. Lithium-Ion, Nickel Metal-Hydride, Nickel-Cadmium, etc.)

What do I do if I'm missing components from my box?

Please call VocoPro regarding any missing or defective accessories at 1-800-678-5348.