

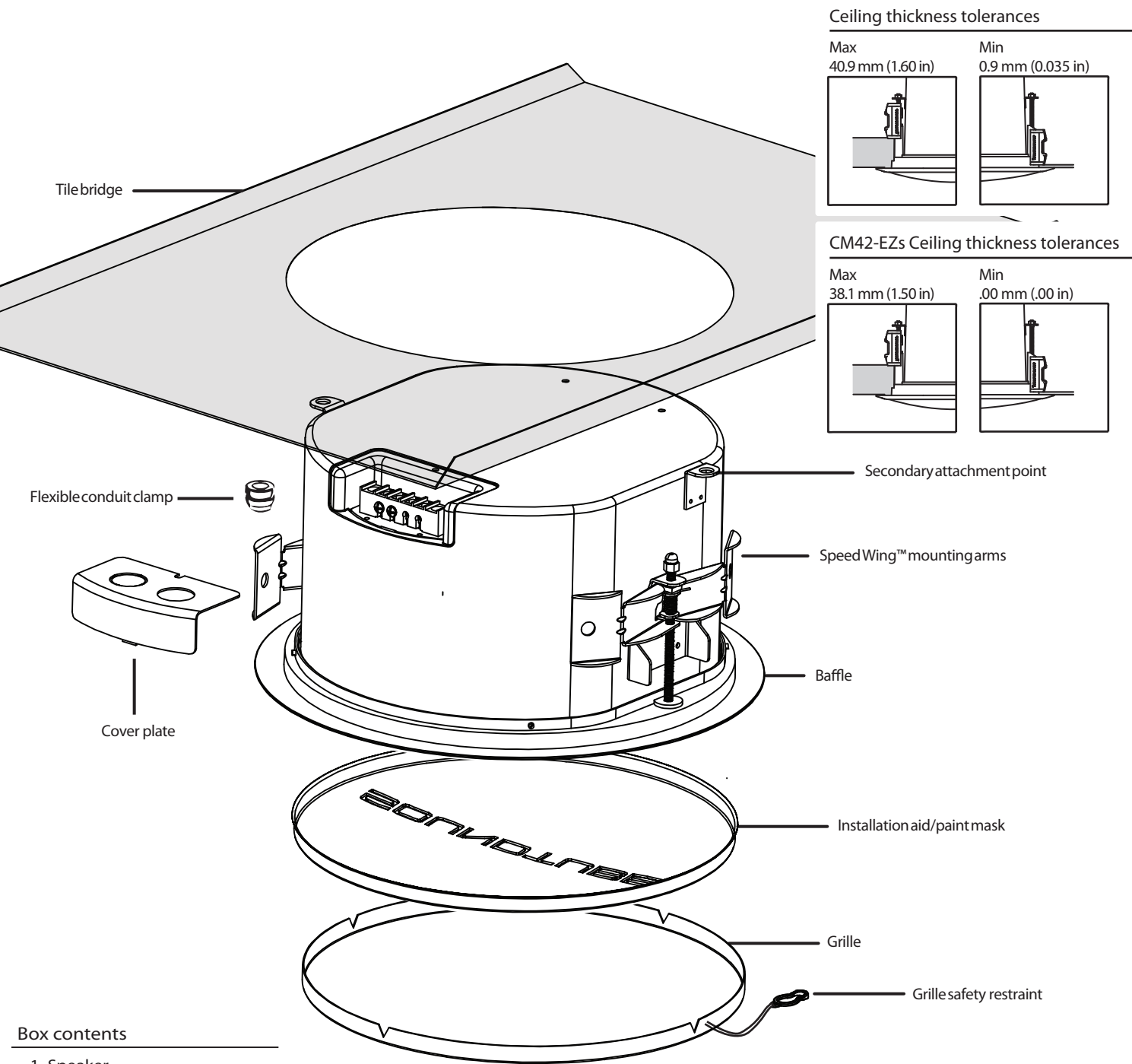

CM-EZ/BGM Series

Install Instructions For:
CM42-EZs-II, CM62-EZ-II, CM62-EZs-II, CM82-EZ-II, CM82-EZs-II, CM82-EZ-FS, CM82-EZs-FS, CM52-BGM, CM52s-BGM, CM62-BGM and CM82-BGM



Ceiling thickness tolerances

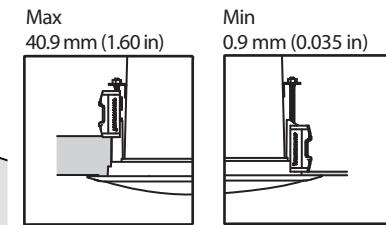

CM42-EZs Ceiling thickness tolerances

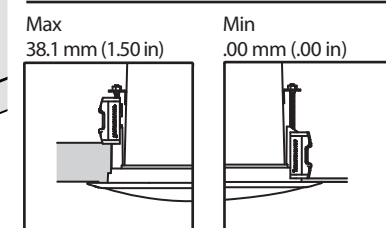

Box contents

- 1 Speaker
- 1 Flexible conduit clamp
- 1 Cover plate
- 1 Grille
- 1 Installation aid/paint mask

1.435.647.9555 | 800.647.TUBE | www.soundtube.com

UL listed 1480 & 2043 (CM82-EZ-FS and CM82-EZs-FS are UL1480 UUMW listed, all other CMEZ speakers are UL1480 UEAY listed. **BGM series not UL listed**) ©2011 SoundTube Entertainment, Inc. All rights reserved. PN INS-CMEZ25 Rev07.05.11

Warning
SoundTube speakers must be installed by a professional audio installer/contractor. For safety and for optimum audio performance, installer must follow all directions issued by SoundTube Entertainment.

Warning
Do not spec or install speaker near support beam, ventilation duct or other structure that may interfere with speaker function or dispersion.

CM-EZ/BGM Series

Droptile Ceiling Install Instructions For:
CM42-EZs-II, CM62-EZ-II, CM62-EZs-II, CM82-EZ-II, CM82-EZs-II, CM82-EZ-FS, CM82-EZs-FS, CM52-BGM, CM52s-BGM, CM62-BGM and CM82-BGM

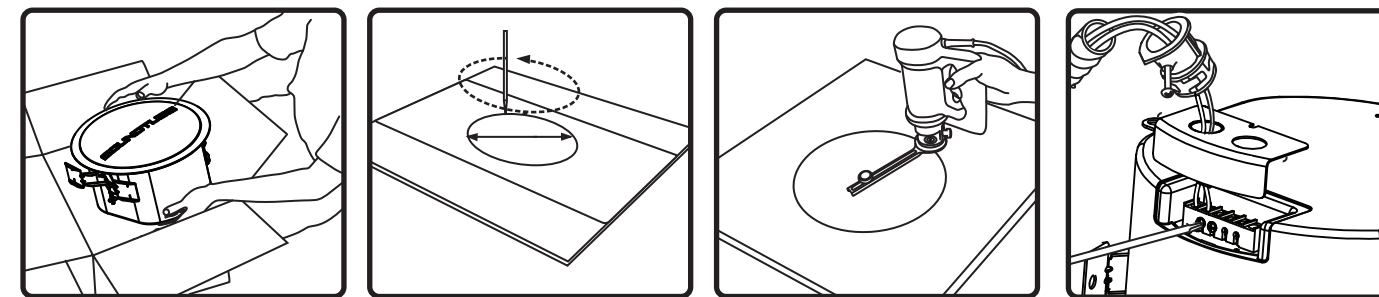

1. Unpack speaker & set aside grille assembly.
2. Use included tile bridge to mark cutout in tile.
3. Use Rotozip or other tool to cut hole.
Hole Diameters
CM42-EZs-II
165.1 mm (6.50 in)
All other CMEZ and BGM models
266.7 mm (10.50 in)
4. Run signal wires through conduit connector, then through cover plate. Connect to ceramic terminal strip. Two + and two - connectors are provided for daisy chaining.

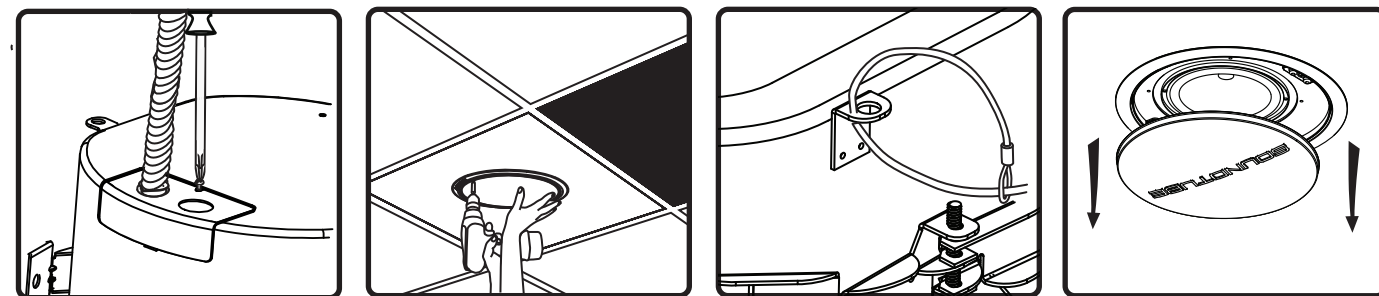

5. Tighten screw on terminal plate, and push conduit connector into knockout.
6. Insert speaker into mounting hole with installation aid in place. Screw down both bolts on the baffle face to actuate the mounting wings. Firmly secure both bolts – **do not over-tighten**.
7. If required, a sheet-metal tab located on the rear panel of the speaker serves as a secondary point of attachment (cable not included).
8. Once all painting and finish work is completed, remove the paint mask.

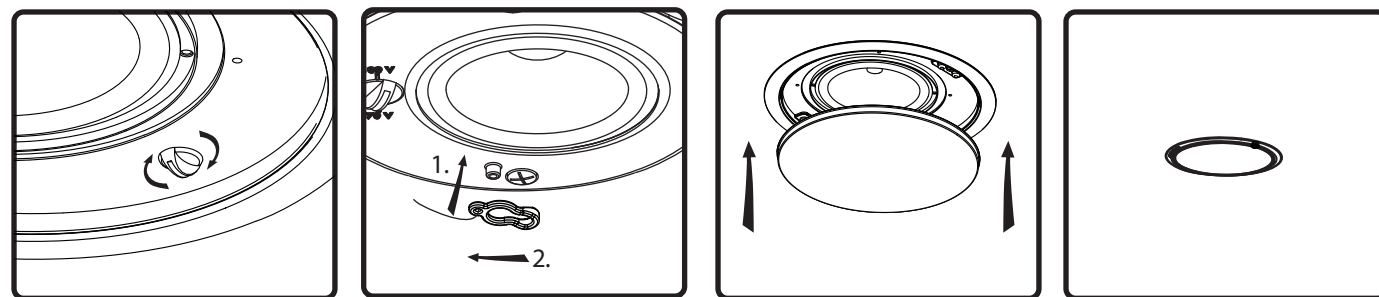

9. Select the tap position by adjusting rotary switch to desired high impedance value or voice coil direct mode.
9. Attach grille safety clip by placing the large end of the clip over snap-fit post (1), then sliding clip until small end snaps into place around post (2).
10. Press grille into place.
11. Done!

1.435.647.9555 | 800.647.TUBE | www.soundtube.com

CM-EZ/BGM Series

Sheetrock Ceiling Install Instructions For:
CM42-EZs-II, CM62-EZ-II, CM62-EZs-II, CM82-EZ-II, CM82-EZs-II, CM82-EZ-FS, CM82-EZs-FS, CM52-BGM, CM52s-BGM, CM62-BGM and CM82-BGM

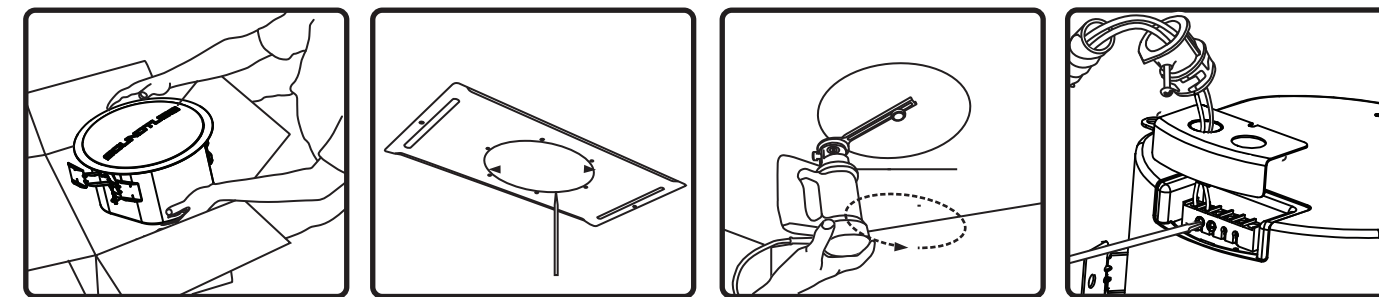

1. Unpack speaker & set aside grille assembly.
2. Use included tile bridge to mark cutout in sheetrock.
3. Use Rotozip or other tool to cut hole.
Hole Diameters
CM42-EZs-II
165.1 mm (6.50 in)
All other CMEZ and BGM models
266.7 mm (10.50 in)
4. Run signal wires through conduit connector, then through cover plate. Connect to ceramic terminal strip. Two + and two - connectors are provided for daisy chaining.

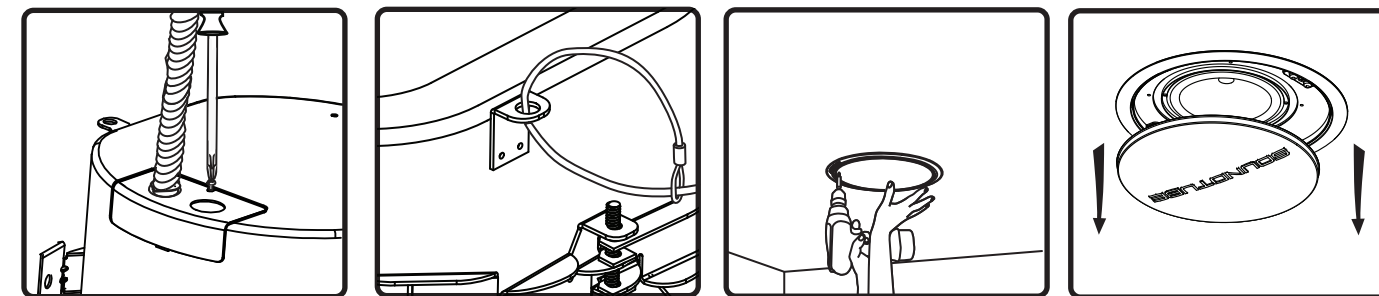

5. Tighten screw on terminal plate, and push conduit connector into knockout.
6. If required, a sheet-metal tab located on the rear panel of the speaker serves as a secondary point of attachment (cable not included).
7. Insert speaker into mounting hole with installation aid in place. Screw down both bolts on the baffle face to actuate the mounting wings. Firmly secure both bolts – **do not over-tighten**.
8. Once all painting and finish work is completed, remove the paint mask.

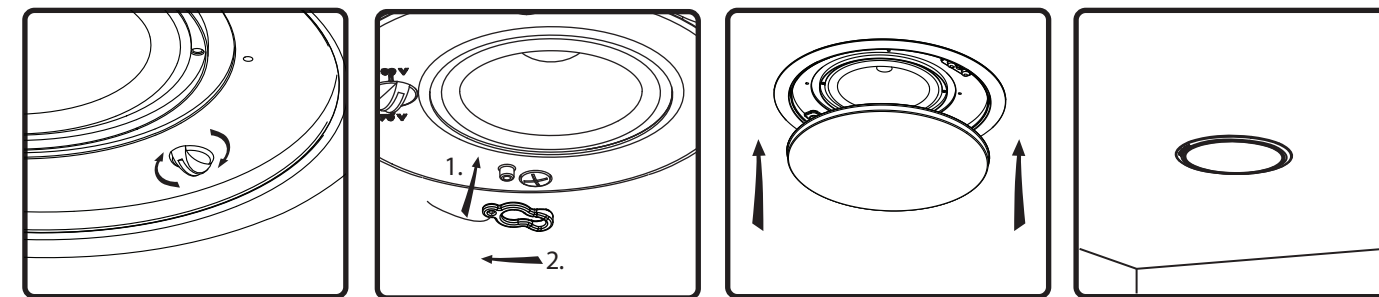

9. Select the tap position by adjusting rotary switch to desired high impedance value or voice coil direct mode.
9. Attach grille safety clip by placing the large end of the clip over snap-fit post (1), then sliding clip until small end snaps into place around post (2).
10. Press grille into place.
11. Done!

1.435.647.9555 | 800.647.TUBE | www.soundtube.com

CM-EZ/BGM Series

Pre-Construction Bracket Instructions For:
CM42-EZs-II, CM62-EZ-II, CM62-EZs-II, CM82-EZ-II, CM82-EZs-II, CM82-EZ-FS, CM82-EZs-FS, CM52-BGM, CM52s-BGM, CM62-BGM and CM82-BGM

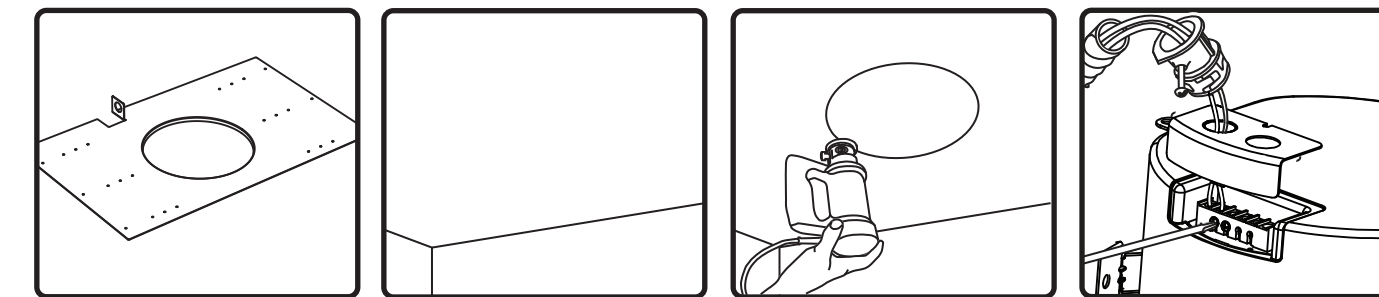

1. Nail or screw bracket to joists. Secure conduit/signal wire away from hole in bracket.
2. Complete Finish work.
3. Use Rotozip or other tool to cut hole.
Hole Diameters
CM42-EZs-II
165.1 mm (6.50 in)
All other CMEZ and BGM models
266.7 mm (10.50 in)
4. Run signal wires through conduit connector, then through cover plate. Connect to ceramic terminal strip. Two + and two - connectors are provided for daisy chaining.

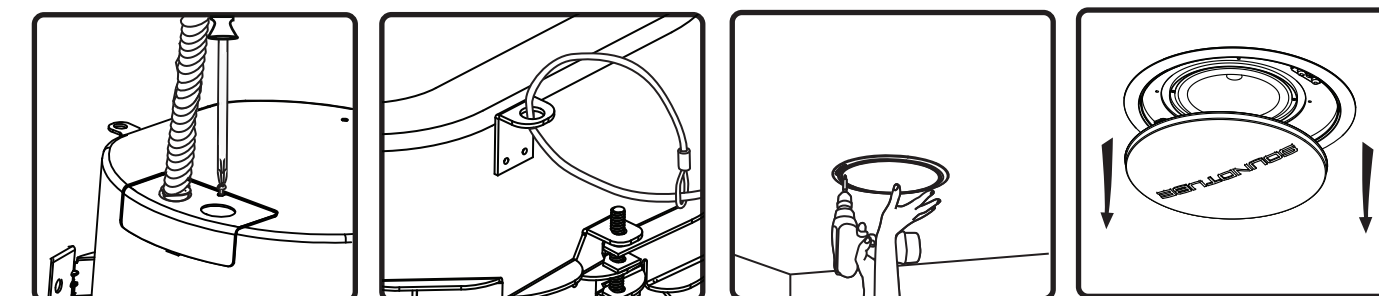

5. Tighten screw on terminal plate, and push conduit connector into knockout.
6. If required, a sheet-metal tab located on the rear panel of the speaker serves as a secondary point of attachment (cable not included).
7. Insert speaker into mounting hole with installation aid in place. Screw down both bolts on the baffle face to actuate the mounting wings. Firmly secure both bolts – **do not over-tighten**.
7. Once all painting and finish work is completed, remove the paint mask.

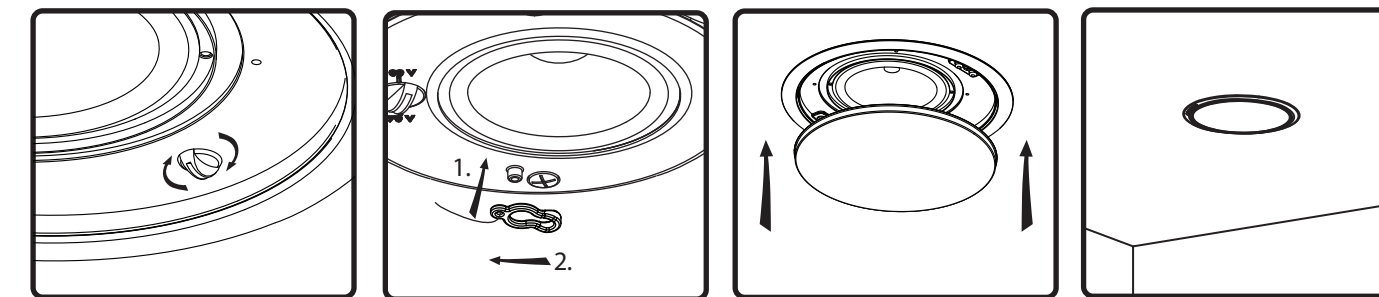

9. Select the tap position by adjusting rotary switch to desired high impedance value or voice coil direct mode.
9. Attach grille safety clip by placing the large end of the clip over snap-fit post (1), then sliding clip until small end snaps into place around post (2).
10. Press grille into place.
11. Done!

1.435.647.9555 | 800.647.TUBE | www.soundtube.com