

MAC Encore™ Performance

CLD and WRM

Safety and Installation Manual



Martin[®]
by HARMAN

Dimensions

All measurements are given in millimeters

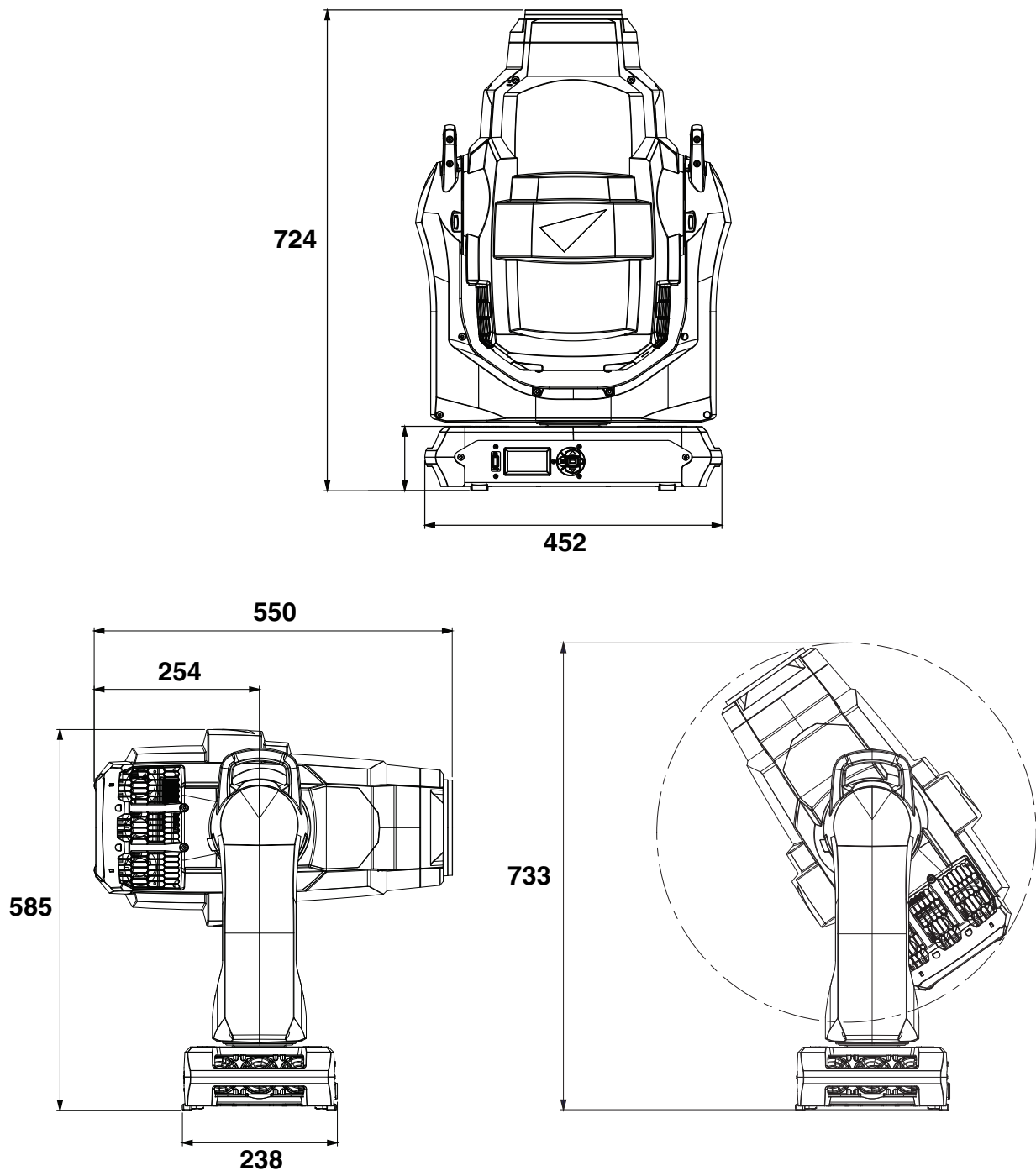

Information subject to change without notice. HARMAN Professional Denmark ApS disclaims liability for any injury, damage, direct or indirect loss, consequential or economic loss or any other loss occasioned by the use of, inability to use or reliance on the information contained in this document.

©2017 HARMAN Professional Denmark ApS. All rights reserved. Martin® is a trademark of HARMAN Professional Denmark ApS registered in the United States and other countries. Features, specifications and appearance are subject to change without notice.

HARMAN Professional Denmark - Olof Palmes Allé 18 - 8200 Aarhus N - Denmark
www.martin.com

Contents

Safety Information.....	4
Introduction.....	7
Unpacking.....	7
Packing.....	8
Physical installation.....	9
AC power.....	11
Power input.....	11
DMX data link.....	12
Service and maintenance.....	13
Tilt lock.....	13
Access to the head.....	13
Access to the multi-module.....	15
Cleaning.....	16
Lubrication.....	17
Replacing optical components.....	17
Using the fixture.....	23
Applying power.....	23
Troubleshooting.....	24
Specifications.....	25

Safety Information



WARNING!

Read the safety precautions in this section before installing, powering, operating or servicing this product.

The following symbols are used to identify important safety information on the product and in this document:



DANGER!
Safety hazard.
Risk of severe injury or death.



DANGER!
Hazardous voltage. Risk of lethal or severe electric shock.



WARNING!
Fire hazard.



WARNING!
Burn hazard. Hot surface. Do not touch.



WARNING!
Intense light emission.



WARNING! Refer to user documentation.



Warning! The MAC Encore™ Performance™ contains components that are accessible and live at high voltage while the fixture is connected to power. These components remain under tension for up to 30 minutes after power is disconnected. Only technicians who are authorized by Martin® and who have access to the Martin® service documentation for the MAC Encore™ Performance are permitted to open the fixture.



Warning! Risk Group 2 product according to EN 62471. This product produces intense light output that may be hazardous if suitable precautions are not taken. Do not view the light output with optical instruments or any device that may concentrate the beam.



This product presents risks of severe injury or death due to fire and burn hazards, electric shock and falls if the safety precautions in this manual are not followed.

Read this manual before installing, powering or servicing the fixture. Follow the safety precautions and observe all warnings in this manual, in the MAC Encore™ Performance User Guide, and printed on the fixture.

The latest versions of this Safety and Installation Manual and the MAC Encore™ Performance User Guide are available for download from the MAC Encore™ Performance Support & Downloads page on the Martin® website at www.martin.com. Before you install, operate or service the MAC Encore™ Performance, check the Martin® website and make sure that you have the latest user documentation for the fixture. Document revisions are indicated at the bottom of page 2.

The product is for professional use only. It is not for household use. Respect all locally applicable laws, codes and regulations when installing, powering, operating or servicing the fixture.

Install, operate and service Martin® products and accessories only as directed in their user documentation, or you may create a safety hazard or cause damage that is not covered by product warranties.

If you have questions about how to operate the fixture safely, please contact your Martin® supplier or call the Martin® 24-hour service hotline on +45 8740 0000, or in the USA on 1-888-tech-180.



PROTECTION FROM ELECTRIC SHOCK

- Do not remove any cover from the fixture except as described under “Service and maintenance” on page 13.
- Disconnect the fixture from AC power before servicing it and when it is not in use.
- Ensure that the fixture is electrically connected to ground (earth).
- Use only a source of AC power that complies with local building and electrical codes and has both overload and ground-fault (earth-fault) protection.

- The cable used to connect the fixture to AC power must be 14 AWG or 1.5 mm² minimum conductor size and heat-resistant to 90° C (194° F) minimum. It must have three conductors and an outer cable diameter of 5 - 15 mm (0.2 - 0.6 in.). In the USA and Canada, the cable must be UL/CSA-recognized, hard usage, type SJT or equivalent. In the EU, the cable must be type H07RN-F or equivalent.
- Before using the fixture, check that all power distribution equipment and cables are in perfect condition and rated for the current requirements of all connected devices.
- Isolate the fixture from power immediately if the power plug or any seal, cover, cable, or other component is damaged, defective, deformed, wet or showing signs of overheating. Do not reapply power until repairs have been completed.
- Use only a Neutrik TRUE1 NAC3FX-W cable connector to connect to the power input socket.
- Do not expose the fixture to rain or moisture.
- The MAC Encore™ Performance contains components that are accessible and live at high voltage while the fixture is connected to power and that remain under tension for 30 minutes after power is disconnected. Only technicians who are authorized by Martin® and who have the Martin® service documentation for the MAC Encore™ Performance are permitted to open the fixture.
- Refer any service operation not described in this manual or in the MAC Encore™ Performance User Guide to Martin® Service or an authorized Martin® Service partner.
- The light source contained in this fixture may only be replaced by Martin® Service or an authorized Martin® Service partner.



PROTECTION FROM BURNS AND FIRE

- The exterior of the fixture becomes hot during use. After 5 minutes of operation a surface temperature of 75° C (167° F) shall be expected. The maximum steady state surface temperature is also 75° C (167° F). Avoid contact by persons and materials.
- Allow the fixture to cool for at least 30 minutes before handling.
- Keep all combustible materials (e.g. fabric, wood, paper) at least 0.2 m (8 in.) away from the fixture.
- Keep flammable materials well away from the fixture.
- Ensure that there is free and unobstructed airflow around the fixture.
- Provide a minimum clearance of 0.2 m (8 in.) around fans and air vents.
- Do not illuminate surfaces within 2.0 m (6.6 ft.) of the fixture.
- Do not expose the front glass to sunlight or any other strong light source from any angle. Lenses can focus the sun's rays inside the fixture, creating a potential fire hazard.
- Do not attempt to bypass thermostatic switches or fuses.
- Do not operate the fixture if the ambient temperature (Ta) exceeds 40° C (104° F).
- Do not modify the fixture in any way not described in this manual or the fixture's User Guide or install other than genuine Martin® parts. Do not stick filters, masks or other materials onto any lens or other optical component. Use only accessories approved by Martin® to mask or modify the light beam.



PROTECTION FROM EYE INJURY

- This fixture is a Risk Group 2 product according to EN 62471. It emits possibly hazardous optical radiation. It falls into the Risk Group categories shown below according to EN 62471.

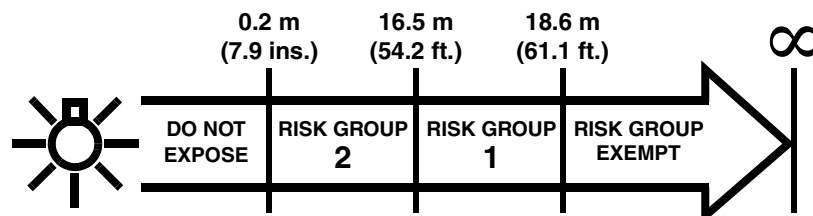

- Do not look directly into the fixture's light output.
- Do not expose persons to the fixture's light output from a distance of less than 0.2 m (8 ins.).
- Do not look at LEDs with magnifiers, telescopes, binoculars or similar optical instruments that may concentrate the light output.
- Ensure that persons are not looking at the LEDs when the fixture lights up suddenly. This can happen when power is applied, when the fixture receives a DMX signal, or when certain control menu items are selected.

- To minimize the risk of eye irritation or injury, disconnect the fixture from power at all times when the fixture is not in use, and provide well-lit conditions to reduce the pupil diameter of anyone working on or near the fixture.



PROTECTION FROM INJURY

- Fasten the fixture securely to a fixed surface or structure when in use. The fixture is not portable when installed.
- Do not lift or carry the fixture alone.
- Use two evenly spaced omega brackets with clamps to suspend the fixture from rigging structures. Do not use only one clamp.
- When clamping the fixture to a truss or other supporting structure at any other angle than with the yoke hanging vertically downwards, use two half-coupler clamps. Do not use G-clamps, quick-trigger clamps or any other type of clamp that does not completely encircle the supporting structure when fastened.
- When suspending the fixture, check that the supporting structure and all hardware used to suspend the fixture can hold at least 10 times the weight of all devices suspended from them and that the installation respects all similar safety factors that are required by locally applicable regulations. Check that the structure and hardware are in perfect condition and suitable for their purpose.
- If the fixture is installed in a location where it may cause injury or damage if it falls, install as described in this manual a secondary attachment such as a safety cable that is approved by an official body such as TÜV as a safety attachment for the weight that it secures. The safety cable must comply with EN 60598-2-17 Section 17.6.6 or BGV C1 / DGUV 17, and must be capable of bearing a static suspended load at least six times (or more if required by locally applicable regulations) the weight that it secures.
- Eliminate as much slack as possible in the secondary attachment (by looping the safety cable more than once around the rigging truss, for example).
- If the safety cable attachment point becomes deformed, do not suspend the fixture. Have the fixture repaired by an authorized Martin® service partner.
- Check that all external covers and rigging hardware are securely fastened.
- Block access below the work area and work from a stable platform whenever installing, servicing or moving the fixture.
- Allow enough clearance around the head to ensure that it cannot collide with an object or another fixture when it moves.

Introduction

Thank you for selecting the MAC Encore™ Performance from Martin®. This moving-head spotlight is available in CLD (cold white LED) and WRM (warm white LED) variants. Both variants offer the following features:

- CLD (cold white LED) and WRM (warm white LED) variants
- Powerful white LED engine
- Full-spectrum CMY color mixing and color temperature control
- Color wheel
- Rotating gobo wheel
- Gobo animation
- Frost effect
- Iris effect
- Motorized zoom and focus
- Rotating framing
- Pre-programmed synchronizable FX (effect combination presets) including *Animation FX*
- Full-range dimming with four dimming curve options
- Electronic shutter effect with variable speed regular and random strobe
- Backlit graphic display and battery power (mains power not required for fixture setup)
- Auto-sensing switch-mode power supply.

For the latest firmware updates, documentation, and other information about this and all Martin® products, please visit the Martin® website at <http://www.martin.com>

Comments or suggestions regarding this document may be e-mailed to service@martin.dk or posted to: Technical Documentation, Martin® Professional, Olof Palmes Allé 18, DK-8200 Aarhus N, Denmark.

Unpacking

The MAC Encore™ Performance is packed in a cardboard box that is designed to protect the fixture during shipment. Two packaging options are available in the cardboard box – the fixture can be supplied in either:

- expanded polystyrene that is not intended for re-use, or
- a SIP (Superior Impact Protection) insert that is designed to be installed in the 2-unit Martin® MAC Encore™ Performance flightcase or custom-made flightcases.

This Safety and Installation Manual is included with the fixture. The MAC Encore™ Performance User Guide, containing full details of setting up, controlling and monitoring the fixture, is available for download from the MAC Encore™ Performance Product Support page on the Martin® website at www.martin.com. If you have any difficulty locating either of these two documents, please contact your Martin® supplier for assistance.

Tilt lock

Release the tilt lock before applying power to the fixture.
See Figure 1. Release the tilt lock by pushing the lock in towards the yoke (you can reapply the tilt lock by first checking that the power is off and then pushing the lock back in towards the yoke from the other side).

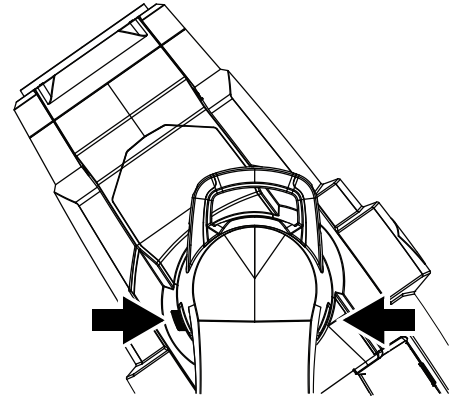

Figure 1: Tilt lock

Packing

Important! *Allow the fixture to cool and release the tilt lock before packing it in its flightcase.*

A rugged two-unit flightcase (see Figure 2) is available from Martin® for the MAC Encore™. The flightcase accepts two durable molded SIP (Superior Impact Protection) foam inserts that are supplied in cardboard boxes with fixtures if you select the SIP option at time of ordering.

The SIP inserts are designed to protect the head without the tilt lock (see Figure 1) applied. Release the tilt lock before putting a fixture into a flightcase for transport. Leaving the tilt lock applied may cause damage that is not covered by the product warranty.



Figure 2: Martin® flightcase for the MAC Encore

Physical installation



Warning! The MAC Encore™ Performance has a powerful pan motor. The torque reaction when the head is panned suddenly can cause the base to move if the fixture is standing unsecured on a surface. Do not apply power to the MAC Encore™ Performance unless the base is securely fastened to a surface or to rigging hardware.

Warning! Use two clamps to rig the fixture. Do not hang the fixture from only one clamp. Lock each clamp with both 1/4-turn fasteners. Fasteners are locked only when turned a full 90° clockwise.

Warning! When suspending the fixture above ground level, secure it against failure of primary attachments by attaching a safety wire that is approved as a safety attachment for the weight of the fixture to the attachment point in the base. Do not use the carrying handles for secondary attachment.

Warning! When clamping the fixture to a truss or other structure at any other angle than with the yoke hanging vertically downwards, use two clamps of half-coupler type. Do not use any type of clamp that does not completely encircle the structure when fastened.



Warning! Position or shade the head so that the front lens will not be exposed to sunlight or another strong light source from any angle – even for a few seconds. See Figure 3. The MAC Encore™ Performance's lens can focus the sun's rays, creating a potential fire hazard and causing damage.

Important! Do not point the output from other lighting fixtures at the MAC Encore™ Performance, as powerful light can damage the display.

See Figure 3. Lenses can focus sunlight and strong light, presenting a risk of fire and damage to the fixture. Shield or shade the head if necessary.

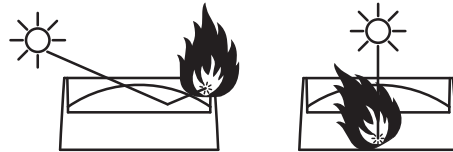

Figure 3: Potential sunlight damage

The MAC Encore™ Performance can be fastened to a surface such as a stage or clamped to a truss in any orientation. Clamps must be half-coupler type (see Figure 5) or equivalent type that fully encircles the truss unless the fixture is installed with the yoke hanging vertically downwards, in which case other clamp types that are approved for the supported weight may be used.

The mounting points in the base allow omega brackets and rigging clamps to be fastened as shown in Figure 4.

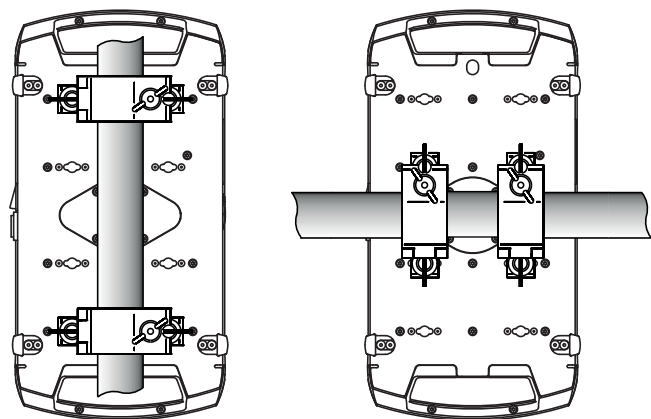
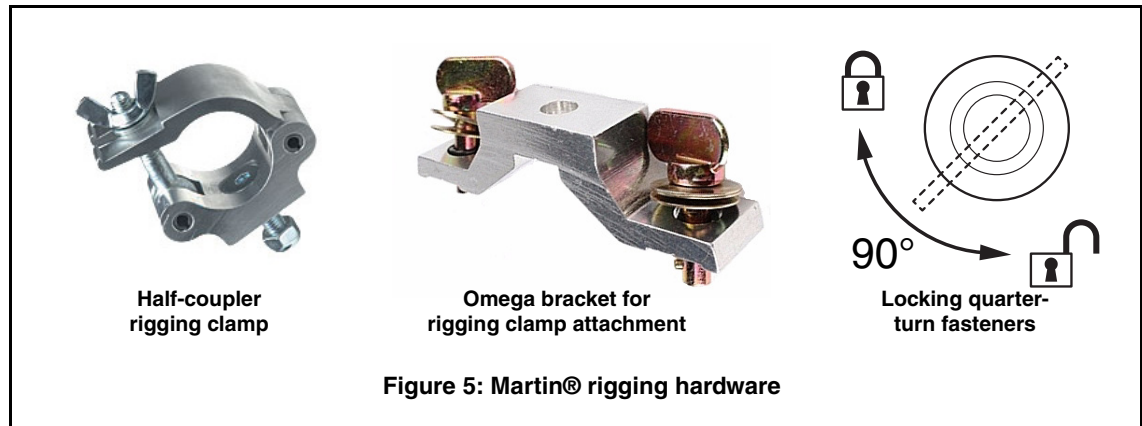

Figure 4: Clamp bracket positions

Clamping the fixture on a truss

1. Check that all rigging hardware is undamaged and can bear at least 10 times the weight of the fixture or as required by locally applicable regulations. Check that the supporting structure can safely bear the weight of all installed fixtures, clamps, cables, auxiliary equipment, etc. and complies with locally applicable regulations.
2. Bolt each rigging clamp securely to an omega bracket with an M12 bolt (minimum grade 8.8) and self-locking nut.



3. See Figure 4 on page 9. Align the first clamp and bracket with 2 mounting points in the base, and engage both the clamp bracket's quarter-turn fasteners in corresponding sockets in the base. See Figure 5. Turn the levers on the quarter-turn fasteners a full 90° clockwise to lock. Repeat for the second clamp.

4. Block access under the work area. See Figure 6. Note the position of the arrow marked **FRONT** on the base of the fixture. Working from a stable platform, hang the fixture on the truss with the arrow marked **FRONT** facing towards the area to be illuminated. Tighten the rigging clamps.

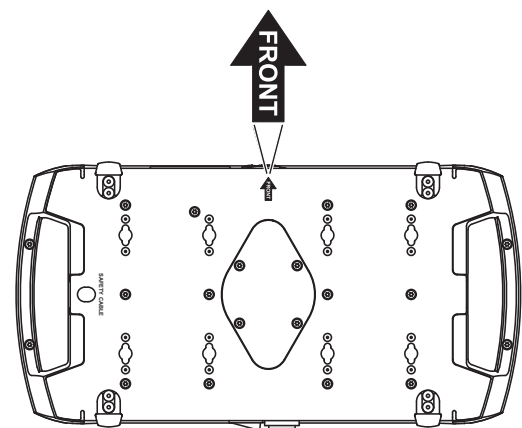

Figure 6: Front of fixture

5. See Figure 7. Install a safety cable that is approved as a safety attachment for the weight of the fixture by looping it through the safety attachment point (arrowed) in the bottom of the base and around a secure anchoring point so that the safety cable will catch the fixture if a primary attachment fails. Remove as much slack as possible from the safety cable (by looping it twice around the anchoring point, for example).

6. Check that the tilt lock is released. Check that there are no combustible materials within 0.2 m (8 in.) or surfaces to be illuminated within 2.0 m (6.6 ft.) of the fixture, and that there are no flammable materials nearby.

7. Check that there is no possibility of heads or yokes colliding with other fixtures. Note that pan and tilt range on the MAC Encore™ Performance can be limited via the control panel to allow fixtures to be installed closer to each other or to obstacles with no risk of collision (see User Guide for details).

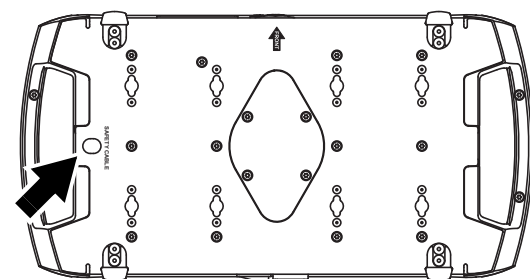

Figure 7: Safety cable attachment point

8. Check that other lighting fixtures cannot project light at the MAC Encore™ Performance, as powerful illumination can damage the fixture's display.

AC power



Warning! Read “Safety Information” on page 4 before connecting the fixture to AC mains power.

For protection from electric shock, the fixture must be electrically connected to ground (earth). The AC mains power distribution circuit must be equipped with a fuse or circuit breaker and ground-fault (earth-fault) protection.



Power input



Important! Connect the MAC Encore™ Performance directly to AC power. Do not connect it to a dimmer system; doing so may damage the fixture.

The MAC Encore™ Performance features an auto-sensing switch-mode power supply that automatically adapts to AC mains power at 120-240 V (nominal), 50/60 Hz. Do not connect the fixture to power that is not within this range.

The MAC Encore™ Performance requires a power input cable with a Neutrik TRUE1 NAC3FX-W cable connector for AC mains power input. The cable must meet the requirements listed under “Protection from electric shock” on page 4.

Connecting to an AC mains power source

The power cable can be hard-wired to a building installation circuit or fitted with a mains plug (cord cap) to allow connection to local AC mains power outlets. If you install a mains plug, install a grounding-type (earthed) plug rated minimum 10 A, 250 V (example rating: EN 60309-2 CEE 2P+E 16A/250VAC), following the plug manufacturer’s instructions. Table 1 shows some possible mains power pin identification schemes; if the pins are not clearly identified, or if you have any doubts about proper installation, consult a qualified electrician.



Wire Color (US)	Wire Color (EU)	Pin	Symbol	Screw (US)
black	brown	live	L	yellow or brass
white	blue	neutral	N	silver
green	yellow/green	ground (earth)	 or 	green

Table 1: Cord cap (mains plug) connections

Applying power

To apply power to the MAC Encore™ Performance:

1. Check that the tilt lock is released, that the base is held securely, and that personal safety will not be put at risk when the fixture lights up and moves.
2. See Figure 8. insert the TRUE1 power connector into the Mains Input socket (arrowed) and twist clockwise to engage.

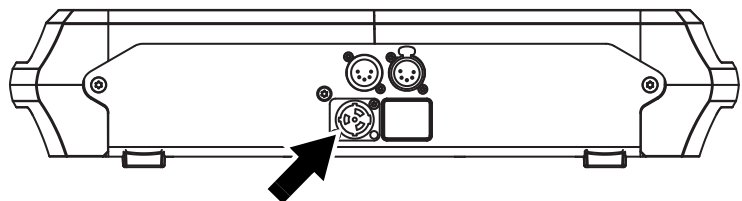

Figure 8: Mains input socket

DMX data link

The MAC Encore™ Performance has 5-pin locking XLR sockets for DMX and RDM input and output (see Figure 8 on page 11). The default pin-out on both sockets is:

- pin 1 to shield
- pin 2 to data 1 cold (-)
- pin 3 to data 1 hot (+).

Pins 4 and 5 are not used by the fixture but are bridged between input and output sockets. These pins can therefore be used as a pass-through connection for an additional data signal if required.

Tips for reliable data transmission

- Use shielded twisted-pair cable designed for RS-485 devices: standard microphone cable cannot transmit control data reliably over long runs. 24 AWG cable is suitable for runs up to 300 meters (1000 ft). Heavier gauge cable and/or an amplifier is recommended for longer runs.
- To split the data link into branches, use one of the splitter-amplifiers available from Martin® (see under “Accessories” in the product specifications given at the end of this document.)
- Do not overload the link. Up to 32 devices may be connected on a serial link.
- Install a DMX termination plug on the last fixture on the link.

Connecting the data link

1. Connect the DMX data output from the controller to the MAC Encore™ Performance's data input (male XLR) socket.
2. Run the data link from the MAC Encore™ Performance's data output (female XLR) socket to the data input of the next fixture.
3. Terminate the data link by connecting a 120 Ohm, 0.25 Watt resistor between the data 1 hot (+) and cold (-) conductors (and between data 2 hot and cold if used) at the data output of the last fixture on the link. If a splitter is used, terminate each branch of the link.

Service and maintenance



Warning! Read “Safety Information” on page 4 before servicing the MAC Encore™ Performance.

Warning! Disconnect the fixture from AC mains power and allow to cool for at least 30 minutes before handling. Do not stare into the light output. Be prepared for the fixture to light and move suddenly when connected to power.



Warning! The MAC Encore™ Performance™ contains components that are accessible and live at high voltage while the fixture is connected to power and that remain under tension for 30 minutes after power is disconnected. Only technicians who are authorized by Martin® and who have the Martin® service documentation for the MAC Encore™ Performance are permitted to open the fixture. Users may carry out external cleaning as described in this section, following the warnings and instructions provided, but any service operation not described in this manual or in the fixture’s User Guide must be referred to a qualified service technician.



Important! Excessive dust, smoke fluid, and particle buildup degrades performance, causes overheating and will damage the fixture. Damage caused by inadequate cleaning or maintenance is not covered by the product warranty.



The user must clean the MAC Encore™ Performance periodically to maintain optimum performance and cooling. The user may also upload firmware (fixture software) to the fixture via the DMX data input port or USB port using firmware and instructions from Martin®. All other service operations on the MAC Encore™ Performance must be carried out by Martin®, its approved service agents or trained and qualified personnel using the official Martin® service documentation for the MAC Encore™ Performance.

Installation, on-site service and maintenance can be provided worldwide by the Martin® Professional Global Service organization and its approved agents, giving owners access to Martin’s expertise and product knowledge in a partnership that will ensure the highest level of performance throughout the product’s lifetime. Please contact your Martin® supplier for details.

It is Martin® policy to apply the strictest possible calibration procedures and use the best quality materials available to ensure optimum performance and the longest possible component lifetimes. However, optical components are subject to wear and tear over the life of the product, resulting in gradual changes in color over many thousands of hours of use. The extent of wear and tear depends heavily on operating conditions and environment, so it is impossible to specify precisely whether and to what extent performance will be affected. However, you may eventually need to replace optical components if their characteristics are affected by wear and tear after an extended period of use and if you require fixtures to perform within very precise optical and color parameters.

Tilt lock

The tilt position of the head can be locked for service. See Figure 1 on page 8. Push the lock in towards the yoke in one direction to lock the head and back in from the other side to unlock the head.

Important! Release the tilt lock before applying power to the fixture and before packing the fixture in its flightcase.

Access to the head



Warning! Disconnect from power and allow to cool for 30 minutes before opening the head.

To open the head:

1. Disconnect the fixture from power, allow components to cool for 30 minutes and apply the tilt lock.
2. See Figure 9. Remove the top head cover by loosening its two Torx 25 captive retaining screws **A** until the screws turn freely. Lift the front of the cover slightly away from the head, then slide the cover towards the front of the head to release the rear of the cover.



3. You can let the head cover hang on its safety wire, but for easiest access push the cover's safety wire retaining clip **B** in towards the head chassis, slide the clip until you can remove it, then remove the head cover completely from the fixture.



Figure 9: Access to the head

4. For easiest access to the components inside the head, position the head at an angle with the front facing downwards as shown in Figure 9, then apply the tilt lock.

To reinstall the top head cover:

1. See Figure 9. Hold the cover up to the head and fasten its safety wire retaining clip **B** into the head chassis by pressing the clip through its hole and then sliding it until it is held securely.
2. Slide the rear of the cover towards the back of the head until its retaining clips locate, then swing the front of the cover in towards the head and fully tighten the cover's two Torx 25 retaining screws. Check that the cover is securely fastened to the head.
3. Release the tilt lock before applying power or packing the MAC Encore™ Performance in its flightcase.

Access to the multi-module

The multi-module contains the rotating gobo, color and animation wheels as well as the CMY flags. Access to these is easiest if you remove the module from the head.

To remove the multi-module:

1. Remove the top head cover, position the head with the front glass angled downwards and the top side facing upwards, and apply the tilt lock (see "Access to the head" on page 13).
2. See Figure 10. Unhook the multi-module wiresets from their cutout **A** in the zoom/focus module chassis.

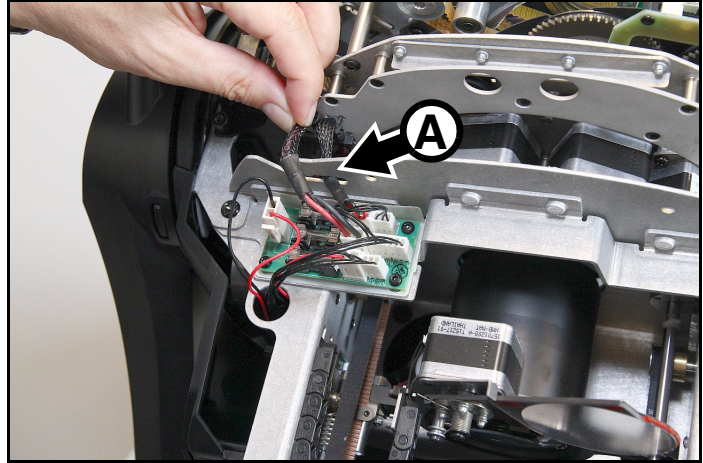

Figure 10: Multi-module wireset routing

3. See Figure 11. Unplug the two pairs of power and data multi-module connectors **B** and **C** from their sockets on the distribution PCB **D**.

When you reconnect the wiresets you must plug in the connectors as pairs (power and data connectors **B** beside each other and power and data connectors **C** beside each other), but it does not matter which pair of sockets you plug which pair of connectors into. The fixture will recognize which plugs are installed in which sockets.

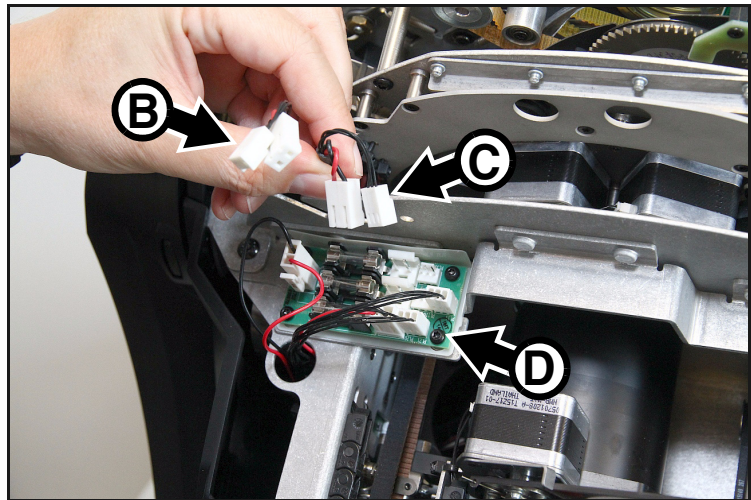

Figure 11: Disconnecting the multi-module

- See Figure 12. Loosen the four Torx 20 screws **D** (arrowed) to release the multi-module, then lift the module out of the head and place it on a work surface as shown in Figure 12.

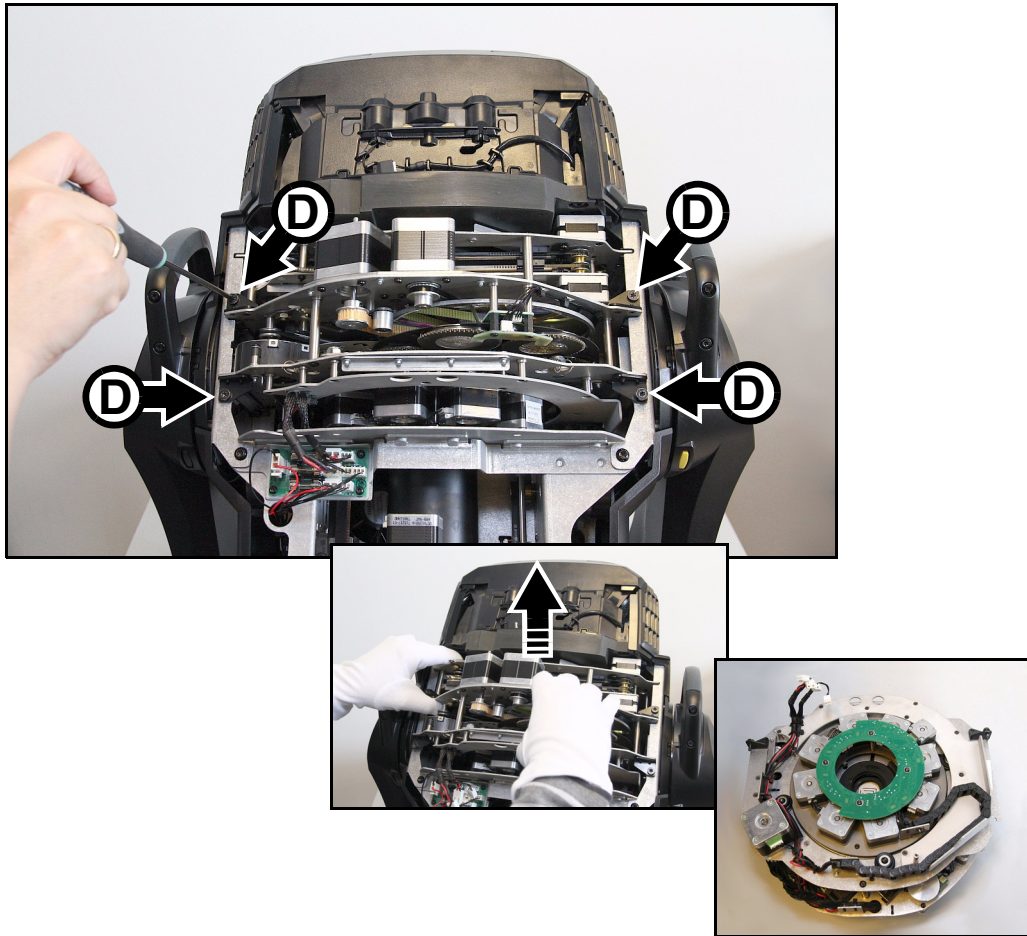

Figure 12: Removing the multi-module

- Use the steps above as a guide when reinstalling the multi-module. Check that you do not trap any wires during reinstallation.

Do not disassemble the multi-module itself without service documentation or assistance from Martin® Service.

Cleaning

Regular cleaning is very important for fixture life and performance. Buildup of dust, dirt, smoke particles, fog fluid residues, etc. degrades the fixture's light output and cooling ability.

Cleaning schedules for lighting fixtures vary greatly depending on the operating environment. It is therefore impossible to specify precise cleaning intervals for the MAC Encore™ Performance. Cooling fans suck in airborne dust and smoke particles, and in extreme cases fixtures may require cleaning after surprisingly few hours of operation. Environmental factors that may result in a need for frequent cleaning include:

- Use of smoke or fog machines.
- High airflow rates (near air conditioning vents, for example).
- Presence of cigarette smoke.
- Airborne dust (from stage effects, building structures and fittings or the natural environment at outdoor events, for example).

If one or more of these factors is present, inspect fixtures within their first few hours of operation to see whether cleaning is necessary. Check again at frequent intervals. This procedure will allow you to assess cleaning requirements in your particular situation. If in doubt, consult your Martin® dealer about a suitable maintenance schedule.

Work in a clean, well lit area. Use gentle pressure only when cleaning. Do not use any product that contains abrasives. Do not use solvents. Use care when cleaning optical components: surfaces are fragile and easily scratched.

To clean the fixture:

1. Disconnect the fixture from power and allow it to cool for at least 30 minutes.
2. Vacuum or gently blow away dust and loose particles from the outside of the fixture and the air vents at the back and sides of the head and in the base with low-pressure compressed air.
3. Clean the front glass on the front of the head by wiping gently with a soft, clean, lint-free cloth moistened with a weak detergent solution. Do not rub the surface hard: lift particles off with a soft repeated press. Dry with a soft, clean, lint-free cloth or low-pressure compressed air. Remove stuck particles with an unscented tissue or cotton swab moistened with glass cleaner or distilled water.
4. Check that the fixture is dry before reapplying power.

Lubrication

The MAC Encore™ Performance does not require lubrication under normal circumstances. Moving parts can be checked and a long-lasting teflon-based grease reapplied by a Martin® service partner if necessary.

Replacing optical components

Optical components have fragile coatings and are exposed to very high temperatures. Use only genuine Martin® parts. Handle and store components with care. Wear cotton gloves while handling them and keep them perfectly clean to reduce the risk of heat damage.

Gobos: general

The MAC Encore™ Performance uses specially designed borosilicate 3.3 gobos with a heavy matted aluminum coating that require particularly careful handling and storage. The MAC Encore™ Performance User Guide available for download from www.martin.com gives names, illustrations and part numbers of the gobos installed as standard.

The use of metal gobos in the MAC Encore™ Performance is not recommended.

Do not use gobos with dark coatings on any side, as these will absorb heat – either directly from the LEDs or reflected back from other gobos and optical components – and will not be durable.

Gobo orientation

The orientations shown in Figure 13 are correct in most cases, but consult your Martin® dealer or gobo supplier if you are in any doubt about the orientation of a specific gobo type.

Coated Glass Gobos

The heavy matted aluminum coated borosilicate gobos in the MAC Encore™ Performance are factory-installed with the more reflective sides facing towards the light source. Replacement gobos must also be installed with more reflective sides facing the LEDs in order to avoid heat damage.

More reflective side towards LEDs

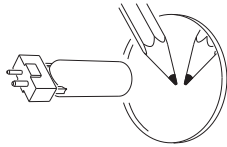

To minimize the risk of gobo overheating and damage, turn the more reflective side of a coated gobo towards the light source.

Less reflective side away from LEDs

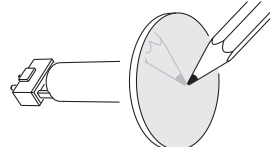

The less reflective side of a coated gobo will absorb less heat if it faces away from the light source.

Textured Glass Gobos

Textured side towards LEDs

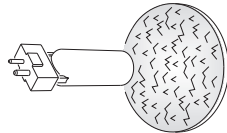

Textured glass gobos in the MAC Encore™ Performance sit most squarely in the gobo wheel with the textured side towards the light source. If in doubt, consult your Martin dealer or gobo supplier.

Smooth side away from LEDs

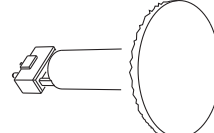
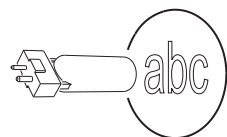

Image / text Gobos

True image towards LEDs



Reversed image away from LEDs

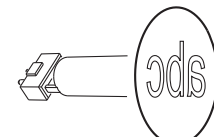

Figure 13. Correct gobo orientation

Gobo handling and storage

1. Store all gobos in a dust-free environment with approx. 50% humidity.
2. Always use clean gloves when handling gobos.
3. Avoid touching the other gobos when taking out a gobo from a rack: the sharp edge of one gobo can scratch the others.
4. Clean the coated side of gobos with dust and oil-free compressed air only.
5. Clean the uncoated side of gobos with photographic quality lens-cleaner and optics cleaning tissues. Use a repeated dabbing action rather than a rubbing action.
6. Avoid scratching coated and uncoated sides.
7. Never place a gobo with the coated side face-down on any surface.
8. Mount the gobo with the non-reflective coating facing towards the front of the fixture, away from the light source.

Replacing rotating gobos

Important! A gobo can fall out of its holder if its spring is inserted the wrong way round.

Do not lubricate gobo bearings: excess grease can cause loss of step.

Correct gobo orientation is critical. Read the guidelines in Figure 13 carefully before installing a gobo.

The MAC Encore™ Performance has a rotating gobo wheel with rotating texture/breakup gobos. Gobos are interchangeable.

To replace a gobo:

1. Disconnect the fixture from power and allow it to cool for 30 minutes.
2. Remove the top head cover, and position the head with the front glass angled downwards and the open top side facing upwards.(see “Access to the head” on page 13). Apply the tilt lock.
3. Remove the multi-module from the head (see “Access to the multi-module” on page 15).

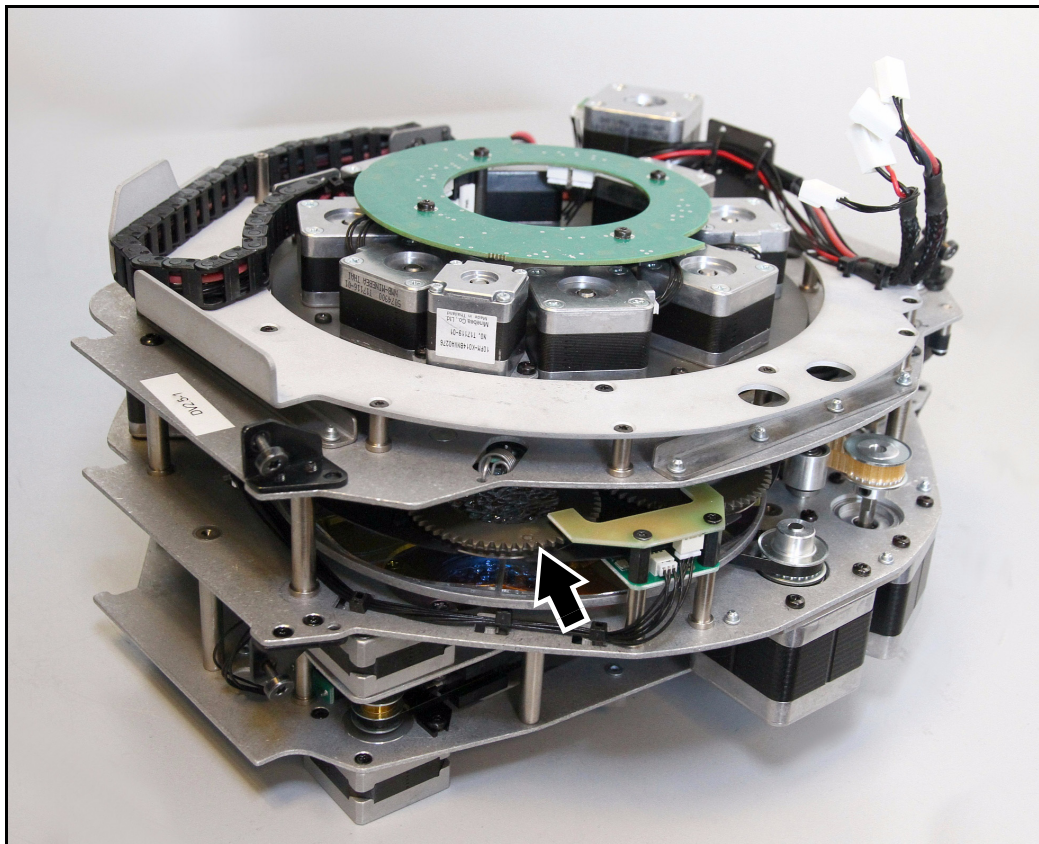

Figure 14: Access to rotating gobos

4. See Figure 14. Turn the gobo wheel until the gobo you want to replace is accessible from the side of the module.

- See Figure 15. Rotate the goboholder until its magnet (arrowed) lines up with a reference point that you choose on the module chassis. Remove and insert any gobos you replace one by one, with the goboholder magnets lined up with your reference point, and avoid rotating the gobo wheel while a gobo is removed. This will keep gobos in the orientation they were designed for and avoid the need to reprogram the controller because a gobo orientation has changed during service.

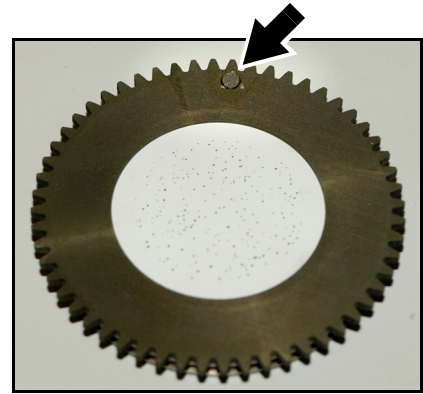

Figure 15: Goboholder magnet

- See Figure 16. Grasp the goboholder **A** by its edge and pull it out of its clip **B**, ensuring that it clears the surrounding plate **C** in the gobo wheel to remove it from the wheel. You may need to press gently down on the plate **C** while you pull the gobo free.
- Note that fused glass gobos such as Limbo/Crystal are glued into the goboholder and cannot be removed from it. If you need to replace a fused glass gobo, you must replace the entire goboholder. Other types of glass gobo are held in their holders by springs and can be removed from the holders as described below.

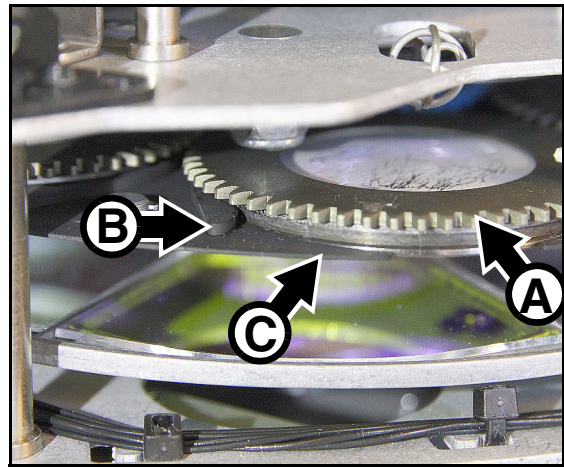

Figure 16: Gobo removal

- See Figure 17. With a small screwdriver or similar, unhook the end of the gobo spring furthest from the gobo and pull out the spring. Drop the gobo out of the holder onto a clean, soft surface.
- Insert the new gobo in the holder with that must face towards the lamp – the more reflective side – facing upwards towards the spring (see Figure 17 and Figure 13).

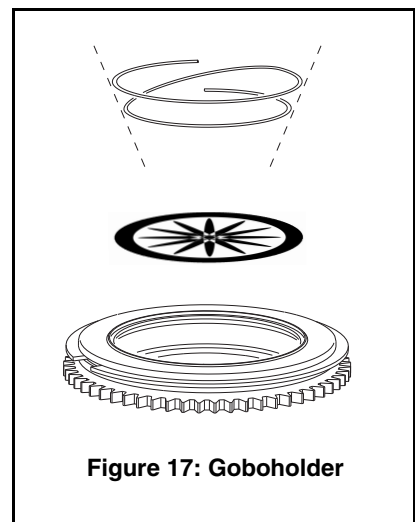

Figure 17: Goboholder

10. See Figure 18. Rotate the gobo in its holder if necessary to line up the alignment marks (arrowed) in the gobo and goboholder.
11. Insert the spring with the narrow end against the gobo, as shown in Figure 17. To identify the narrow end, press the spring flat: the narrow end is on the inside. Push the wide end of the spring in under the lip of the holder.
12. Check that the gobo is seated flush against the holder. Press the spring as flat as possible against the back of the gobo.



Figure 18: Gobo alignment marks

13. See Figure 19. Push the goboholder back into its clip so that the jaws **A** of the clip engage in the groove **B** around the goboholder and the magnet lines up with your reference point. Rotate the goboholder with a finger to check that it is correctly held in the clip and that the goboholder teeth mesh correctly in the teeth of the actuation cog in the center of the gobo wheel.
14. If necessary, continue replacing gobos one by one as described above.
15. If no further service work is to be carried out, reinstall the module and head cover as described in "Access to the multi-module" on page 15 and "Access to the head" on page 13. Release the tilt lock before reapplying power.

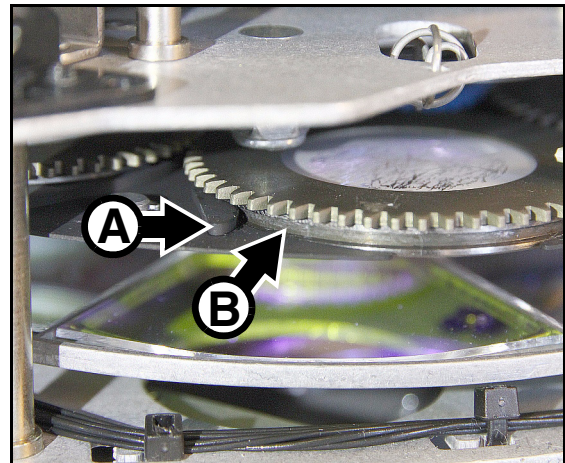

Figure 19: Reinstalling a gobo

Replacing color filters

The MAC Encore™ Performance has six dichroic color filters. See the MAC Encore™ Performance User Guide available for download from www.martin.com for filter names and part numbers.

Use only genuine Martin™ color filters. Handle and store filters with care. Wear cotton gloves while handling them and keep them perfectly clean.

To replace a color filter:

1. Disconnect the fixture from power and allow it to cool for 30 minutes.
2. Remove the top head cover, position the head with the front glass angled downwards and the top side facing upwards, and apply the tilt lock (see “Access to the head” on page 13).
3. Remove the multi-module from the head (see “Access to the multi-module” on page 15).
4. See Figure 20. Turn the color wheel **A** until the filter **B** that you want to replace is accessible. Put on clean cotton gloves. Push the outer edge of the filter up and away from the color wheel slightly to release it, then pull the filter carefully out of its clip and remove it. Store the filter resting on a clean, soft surface or in a filter rack.

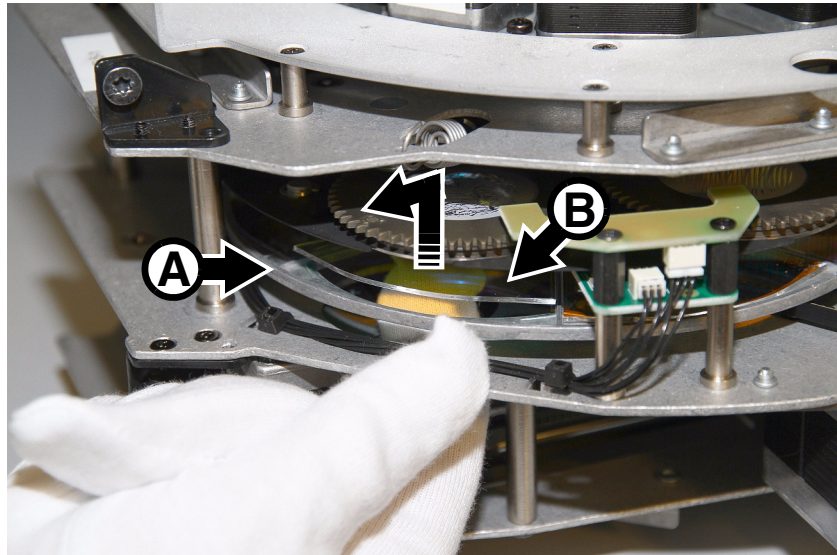

Figure 20: Color filter removal

5. To insert a color filter, put on clean cotton gloves and turn the filter so that its coated side will face towards the LEDs (in the MAC Encore™ Performance this means that the coated side must face *away from* the gobo wheel). To find out which side of a color filter is coated, hold an object up against the glass. There will be a small gap between the object and its reflection on the non-coated side.
6. See Figure 21. Slide the filter fully into its clip in the center of the color wheel. Make sure that the outer edge of the filter locates inside the lip (arrowed) on the edge of the color wheel so that the filter is held securely.
7. If necessary, continue replacing filters one by one as described above.
8. If no further service work is to be carried out, reinstall the module and head covers as described in “Access to the multi-module” on page 15 and “Access to the head” on page 13. Release the tilt lock before reapplying power.

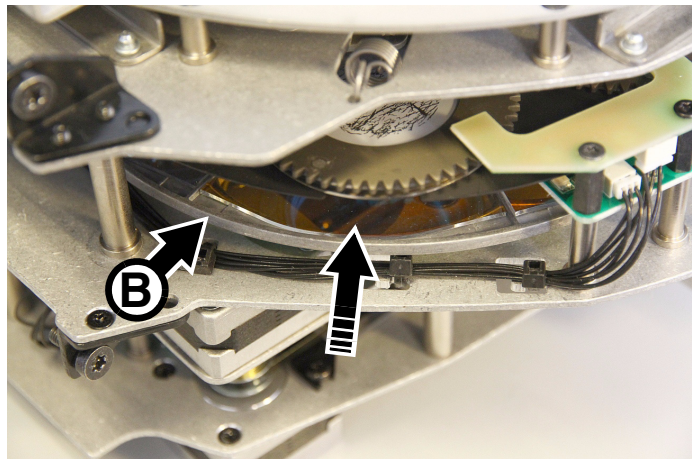

Figure 21: Color filter installation

Using the fixture

Before using the fixture, download and read the latest version of the MAC Encore™ Performance User Guide from the MAC Encore™ Performance Product Support page on the Martin® website at www.martin.com. The User Guide contains details of:

- The effects available in the fixture.
- The control options available using DMX.
- The setup, monitoring and control options available using the onboard control and display panel.
- RDM (Remote Device Management) compatibility.
- Software service functions.

Applying power



Warning! Before applying power to the fixture:

- ***Carefully review the safety information starting on page 4 of this manual.***
- ***Check that the head covers are correctly installed.***
- ***Check that the installation is safe and secure.***
- ***Check that the base is fastened securely so that the torque reaction when the head is panned will not cause the base to move.***
- ***Check that the head tilt lock is released (see “Tilt lock” on page 8).***

To apply power, connect a power cable with a TRUE1 power input connector to the MAINS IN power input socket. Insert the connector and twist clockwise to engage.

Troubleshooting

Problem	Probable cause(s)	Remedy
One or more of the fixtures is completely dead.	No power to fixture.	Check that power is switched on and cables are plugged in.
	Fuse blown or internal fault.	Contact Martin® Service or authorized service partner. Do not remove base or yoke covers, attempt to replace a fuse or carry out any repairs or service that are not described in this Safety and Installation Manual unless you have both authorization from Martin® and official Martin® service documentation.
Fixtures reset correctly but respond erratically or not at all to the controller.	Bad data link.	Inspect connections and cables. Correct poor connections. Repair or replace damaged cables.
	Data link not terminated.	Insert DMX termination plug in data output socket of the last MAC Encore™ Performance on the data link.
	Incorrect addressing of fixtures.	Check fixture address and protocol settings.
	One of the fixtures is defective and is disturbing data transmission on the link.	Unplug the XLR in and out connectors and connect them directly together to bypass one fixture at a time until normal operation is regained. Have the fixture serviced by a qualified technician.
Timeout error after fixture reset.	Effect requires mechanical adjustment.	Check fixture's stored error messages for more information. Contact Martin® Service or authorized Martin® service partner.
Mechanical effect loses position.	Mechanical train requires cleaning, adjustment, or lubrication.	Check fixture's stored error messages for more information. Contact Martin® Service or authorized Martin® service partner.
Light output cuts out intermittently.	Fixture is too hot.	Check fixture's stored error messages for more information. Allow fixture to cool. Clean fixture. Reduce ambient temperature.

Table 2: Troubleshooting

Specifications

Physical

Length	452 mm (17.8 in.)
Width (across yoke)	480 mm (18.9 in.)
Height (maximum)	733 mm (28.9 in.)
Height (head straight up)	724 mm (28.6 in.)
Weight	31 kg (68.4 lbs.)
Minimum center-to-center distance in side-by-side installation	700 mm (27.5 in.)

Dynamic Effects

Color mixing	CMY, independently variable 0 - 100%
Color temperature control, CLD variant	Variable 2700 - 6000 K
Color temperature control, WRM variant	Variable 3000 - 7000 K
Color wheel	6 interchangeable dichroic filters + open, indexing, continuous rotation, random color
Rotating gobo wheel	5 interchangeable gobos + open, indexing, continuous rotation, shake
Gobo animation	Interchangeable animation wheel, indexing, continuous rotation with variable speed and direction
Framing	Rotatable framing, +/- 55°, 4 individually controllable blades with variable angle and position
Iris	Variable 0 - 100%
Frost	Variable 0 - 100%
Dimmer/shutter	0 - 100% continuous dimming, regular and random strobe and pulse effects, instant open and blackout
Dimming options	Choice of four dimming curves
Pre-programmed effects	Two ranges of FX, independent or synchronized/combined
Focus	Range varies with zoom angle, from approx. 2 m (6.6 ft.) / 6 m (19.7 ft.) to infinity
Zoom	12° - 48°
Pan	540°
Tilt	268°
Position correction system	Absolute position monitoring

Control and Programming

DMX channels	38
Setting and addressing	Control panel with backlit graphic display and jog wheel or via DMX
16-bit control	Dimming, rotating gobos, zoom, focus, pan and tilt
Movement control options	Tracking and vector
Fixture identification	User-settable ID number
DMX compliance	USITT DMX512-A
RDM compliance	ANSI/ESTA E1.20
Transceiver	RS-485
Receiver	Opto-isolated RS-485
Fixture software update	USB memory device or over DMX link

Optics

Light source	6000 K white LEDs (CLD variant) / 3000 K white LEDs (WRM variant)
Total LED engine power	468 W
Minimum LED lifetime	50 000 hours (to >80% luminous output)*

*Figure obtained under manufacturer's test conditions

Photometric Data

CLD variant

Light engine luminous output	≥ 39 400 lumens
Fixture luminous output	≥ 11 600 lumens
CRI (Color Rendering Index)	> 80
CQS (Color Quality Scale)	> 80
TM-30 Rf (IES TM-30-15 Fidelity Index)	> 80
TM-30 Rg (IES TM-30-15 Gamut Index)	> 95
TLCI (Television Lighting Consistency Index)	> 70

WRM variant

Light engine luminous output	≥ 31 500 lumens
Fixture luminous output	≥ 9200 lumens
CRI (Color Rendering Index)	> 90
CQS (Color Quality Scale)	> 90
TM-30 Rf (IES TM-30-15 Fidelity Index)	> 90
TM-30 Rg (IES TM-30-15 Gamut Index)	> 98
TLCI (Television Lighting Consistency Index)	> 90

Construction

Color	Black
Housing	High-impact flame-retardant thermoplastic
Protection rating	IP20

Installation

Mounting points	4 pairs of 1/4-turn locks
Location	Dry location only, must be fastened to surface or structure
Orientation	Any
Minimum distance to combustible materials	0.2 m (8 in.)
Minimum distance to illuminated surfaces	2.0 m (6.6 ft.)

Connections

AC power input	Neutrik TRUE1 socket (accepts Neutrik TRUE1 NAC3FX-W connector)
DMX and RDM data in/out	5-pin locking XLR

Electrical

AC power	120-240 V nominal, 50/60 Hz
Power supply unit	Auto-ranging electronic switch mode
Power consumption, all effects static, zero light output	.64 W
Half-cycle RMS inrush current at 230 V, 50 Hz	10.3 A

Typical Power and Current

120 V, 60 Hz	5.0 A, 596 W, PF 0.998
208 V, 60 Hz	2.9 A, 581 W, PF 0.988
230 V, 50 Hz	2.6 A, 580 W, PF 0.981
240 V, 50 Hz	2.2 A, 585 W, PF 0.979

Figures are typical, not maximum. Measurements made at nominal voltage with all LEDs at full intensity.

Allow for a deviation of +/- 10%.

PF = power factor

Thermal

Cooling	Combined convection and forced air (temperature-regulated, low noise, user-definable levels)
Maximum surface temperature, steady state, at Ta 40° C	75° C (167° F)
Maximum ambient temperature (Ta max.)	40° C (104° F)
Minimum ambient temperature (Ta min.)	5° C (41° F)
Total heat dissipation (calculated, +/- 10%)	2000 BTU/hr.

Approvals



EU safety	EN 60598-2-17, EN 62471, EN62493
EU EMC	EN 55015, EN 55032, EN 55103-2, EN 61000-3-2, EN 61000-3-3, EN 61547
US safety	UL 1573
US EMC	FCC Part 15 Class A
Canadian safety	CSA C22.2 No. E598-2-17
Canadian EMC	ICES-003 Class A
Australia/NZ	RCM

Included Items

Two omega brackets with 1/4 turn fasteners for rigging clamp attachment

Accessories

Cables and connectors

Power Input Cable, H07RN-F, 2.5 mm ² , bare ends to Neutrik TRUE1 NAC3FX-W (female), 1.5 m (4.9 ft.)	P/N 91611797
Power Input Cable, H07RN-F, 2.5 mm ² , bare ends to Neutrik TRUE1 NAC3FX-W (female), 5 m (16.4 ft.)	P/N 91611786
Power Input Cable, SJOOW, 12 AWG, bare ends to TRUE1 NAC3FX-W (female), 1.5 m (4.9 ft.)	P/N 91610173
Power Input Cable, SJOOW, 12 AWG, bare ends to TRUE1 NAC3FX-W (female), 5 m (16.4 ft.)	P/N 91610174
Cable Connector, Neutrik PowerCON TRUE1 NAC3FX-W (female)	P/N 91611789

Installation hardware

G-clamp (suspension with fixture hanging vertically downwards only)	P/N 91602003
Quick Trigger Clamp (suspension with fixture hanging vertically downwards only)	P/N 91602007
Half-coupler Clamp	P/N 91602005
Safety Cable, SWL 60 kg, BGV C1 / DGUV 17, black	P/N 91604006
Safety Cable, SWL 60 kg, BGV C1 / DGUV 17, silver	P/N 91604007

Flightcases

Two-unit Flightcase for MAC Encore™ (please order SIP variant fixtures to obtain the required SIP foam flightcase inserts)	P/N 91515048
---	--------------

Related Items

Martin® M-PC 2U incl. Martin® M-DMX USB-DMX Interface	P/N 90737070
Martin® M-PC Pro-64 / LJ-4 Controller Kit incl. Martin® M-DMX USB-DMX Interface	P/N 90737060
Martin® RDM 5.5 Splitter™	P/N 90758150

Ordering Information

MAC Encore™ Performance CLD EPS (in cardboard box, polystyrene packaging)	P/N 90234000
MAC Encore™ Performance CLD SIP (in cardboard box with SIP foam flightcase insert)	P/N 90234005
MAC Encore™ Performance WRM EPS (in cardboard box, polystyrene packaging)	P/N 90234015
MAC Encore™ Performance WRM SIP (in cardboard box with SIP foam flightcase insert)	P/N 90234016

Specifications subject to change without notice. For the latest product specifications, including photometric data, see www.martin.com

Photobiological Safety Warning

The label shown on the right is displayed on this product. If it becomes difficult or impossible to read, it must be replaced using the illustration on the right to reproduce a new label.

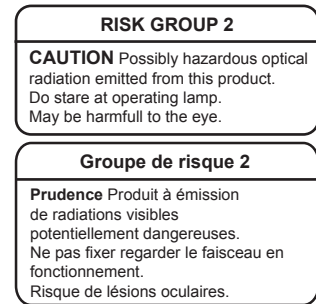

FCC Compliance

This device complies with Part 15, Class A, of the FCC Rules. Operation is subject to the following two conditions: (1) This device may not cause harmful interference, and (2) this device must accept any interference received, including interference that may cause undesired operation.

Canadian Interference-Causing Equipment Regulations - *Règlement sur le Matériel Brouilleur du Canada*

This Class A digital apparatus meets all requirements of the Canadian Interference-Causing Equipment Regulations.
Cet appareil numérique de la classe A respecte toutes les exigences du Règlement sur le Matériel Brouilleur du Canada.

EU Declaration of Conformity

An EU Declaration of Conformity covering this product is available on the product's Tech Docs / Support & Downloads page on the Martin@ website at www.martin.com.

Conditional Connection

For conformity with mains voltage fluctuations and flicker according to EN 61000-3-11 during extensive use of continuous strobe effects, the user must determine, in consultation with the mains power supply authority if necessary, that the equipment is connected to a supply impedance of less than 0.34 ohms at 50 Hz.

Hibernation Mode

"Hibernation mode" is intended as an option to reduce the consequences of having a product fully operational in dirty environments or in situations where noise level is crucial such as during live performances. The small reduction in energy consumption in Hibernation Mode is only a subordinate effect.

Intellectual Property Rights

MAC Encore™ products are covered by one or more of these patents:

CN101430080; CN102713425; CNZL200810128720.0; CNZL200810128776.6; CNZL200810144668.8; CNZL201080025103.3; CNZL201180014884.0; CNZL201380004370.6; CZ17567; EP2058586; EP2113714; EP2117284; EP2136136; EP2326150; EP2443381; EP2536974; EP2550686; EP2828577; EP2881650; US6971770; US7,703,948; US7,789,543; US7,905,630; US7,942,535; US7,990,673; US7222997; US7498756; US8,449,141; US8,708,535; US8,770,762; US9217551; US9217559;

and/or one or more of these patent applications:

CN104696882; CN104698579; CN104976548; CN105402641; CN201410740291.8; CN201410742572; DKPA201700088; EP17167067.2; EP2091302; EP2881651; EP2881652; EP2881653; EP2927579; EP2995852; US2015/0285483; US20150159827; US20150159828; US20150159830; US20160069540; US20160102850;

and/or one or more other intellectual property rights, including one or more intellectual property rights listed on www.martin.com/ipr



Disposing of this product

Martin@ products are supplied in compliance with Directive 2012/19/EC of the European Parliament and of the Council of the European Union on WEEE (Waste Electrical and Electronic Equipment), where applicable.

Help preserve the environment! Ensure that this product is recycled at the end of its life. Your supplier can give details of local arrangements for the disposal of Martin@ products.

This product contains a lithium battery. Ensure that it is disposed of correctly and responsibly by an authorized recycling or waste disposal center at the end of its life. Where applicable, Martin@ participates in schemes whose aim is to ensure that local recycling and/or waste disposal centers accept batteries from Martin@ products.



www.martin.com • Olof Palmes Allé 18 • 8200 Aarhus N • Denmark
Tel: +45 8740 0000 • Fax +45 8740 0010