

RD10MD2

**Dual HD to SD
Down Converter
R-series Card Module**

Published: 6/30/10

Installation and Operation Guide

Because it matters.

AJA[®]
VIDEO SYSTEMS

Trademarks

AJA®, KONA®, Ki Pro®, and XENA® are registered trademarks of AJA Video, Inc. FiDO™, Io HD™ and Io™ are trademarks of AJA Video, Inc. HDMI, the HDMI logo and High-Definition Multimedia Interface are trademarks or registered trademarks of HDMI Licensing LLC. DVI is a registered trademark of DDWG. All other trademarks are the property of their respective holders.

Notice

Copyright © 2010 AJA Video, Inc. All rights reserved. All information in this manual is subject to change without notice. No part of the document may be reproduced or transmitted in any form, or by any means, electronic or mechanical, including photocopying or recording, without the express written permission of AJA Inc.

Contacting Support

To contact AJA Video for sales or support, use any of the following methods:

180 Litton Drive, Grass Valley, CA. 95945 USA

Telephone: 800.251.4224 or 530.274.2048

Fax: 530.274.9442

Web: <http://www.aja.com>

Support Email: support@aja.com

Sales Email: sales@aja.com

When calling for support, have all information at hand prior to calling.

Limited Warranty

AJA Video warrants that this product will be free from defects in materials and workmanship for a period of five years from the date of purchase. If a product proves to be defective during this warranty period, AJA Video, at its option, will either repair the defective product without charge for parts and labor, or will provide a replacement in exchange for the defective product.

In order to obtain service under this warranty, you the Customer, must notify AJA Video of the defect before the expiration of the warranty period and make suitable arrangements for the performance of service. The Customer shall be responsible for packaging and shipping the defective product to a designated service center nominated by AJA Video, with shipping charges prepaid. AJA Video shall pay for the return of the product to the Customer if the shipment is to a location within the country in which the AJA Video service center is located. Customer shall be responsible for paying all shipping charges, insurance, duties, taxes, and any other charges for products returned to any other locations.

This warranty shall not apply to any defect, failure or damage caused by improper use or improper or inadequate maintenance and care. AJA Video shall not be obligated to furnish service under this warranty a) to repair damage resulting from attempts by personnel other than AJA Video representatives to install, repair or service the product, b) to repair damage resulting from improper use or connection to incompatible equipment, c) to repair any damage or malfunction caused by the use of non-AJA Video parts or supplies, or d) to service a product that has been modified or integrated with other products when the effect of such a modification or integration increases the time or difficulty of servicing the product.

THIS WARRANTY IS GIVEN BY AJA VIDEO IN LIEU OF ANY OTHER WARRANTIES, EXPRESS OR IMPLIED. AJA VIDEO AND ITS VENDORS DISCLAIM ANY IMPLIED WARRANTIES OF MERCHANTABILITY OR FITNESS FOR A PARTICULAR PURPOSE. AJA VIDEO'S RESPONSIBILITY TO REPAIR OR REPLACE DEFECTIVE PRODUCTS IS THE WHOLE AND EXCLUSIVE REMEDY PROVIDED TO THE CUSTOMER FOR ANY INDIRECT, SPECIAL, INCIDENTAL OR CONSEQUENTIAL DAMAGES IRRESPECTIVE OF WHETHER AJA VIDEO OR THE VENDOR HAS ADVANCE NOTICE OF THE POSSIBILITY OF SUCH DAMAGES.

Introduction

The RD10MD2 is a 10-bit broadcast-quality Dual channel HD down converter. Channels 1 and 2 are fully independent. Channel 1 has 1 re-clocked HD/SD-SDI outputs and channel 2 also has 1 re-clocked HD/SD-SDI output. Both Channel 1 and 2 have 2 down converted outputs, which can be independently configured as SDI or composite analog. All HD formats are supported including 24p/psf with 3:2 pulldown. The SD output can be formatted for either 4:3 or 16:9 monitors. For 4:3 monitors both Letterbox and Crop modes are supported. The RD10MD2 is dual-rate (HD/SD) and supports SDI inputs.

The RD10MD2 is compatible with AJA's FR1 or FR2 frames.

Features

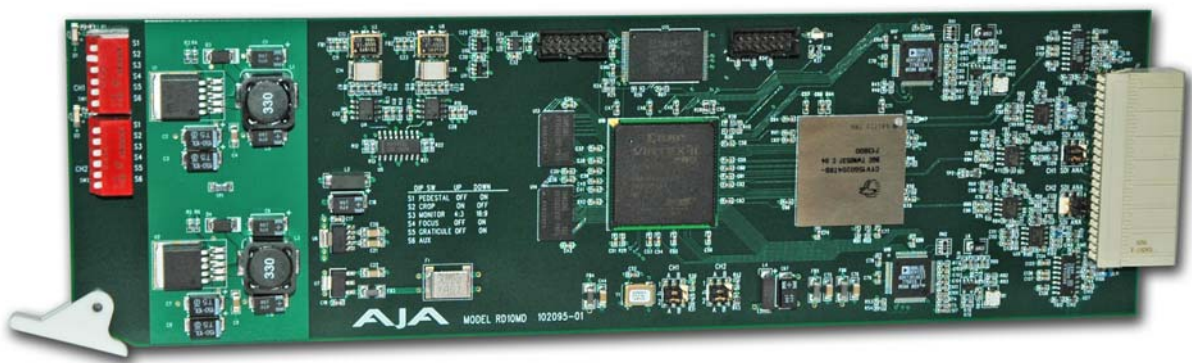

RD10MD2 Card Module, Side View

- Dual Independent Channel HD to SD Down Conversion
- Re-clocking HD-SDI/SDI input loop outputs
- Multi-Standard HD-SDI or SDI Input
- SDI and Composite Analog Outputs
- 3/2 Pulldown for 23.98/24 Hz P/PSF inputs
- Full 10-bit Data Path, Multi-point Interpolation
- Configurable for 16:9 or 4:3 Monitors
- Letterbox and Crop Modes
- 4:3 Safe-Zone Graticule
- Pedestal on Composite Analog Outputs

Block Diagram

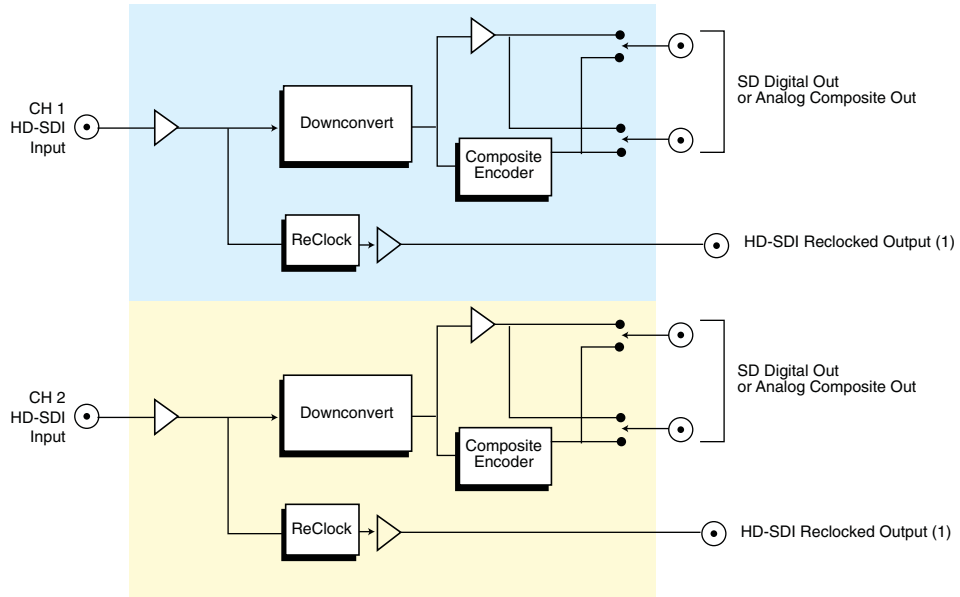

RD10MD2, Block Diagram

I/O Connections

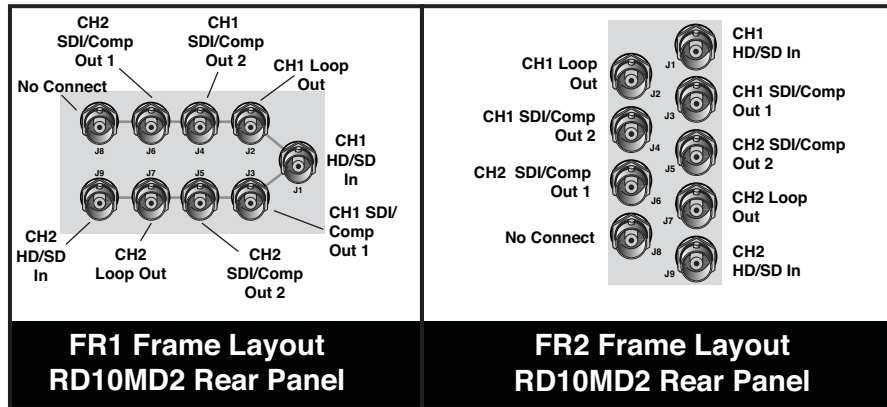

FR1 and FR2 BNC Connector Assignments, RD10MD2 Card Module

When the RD10MD2 module is installed in an AJA FR1 or FR2 frame, a corresponding group of 9 BNCs on the rear panel then provide I/O for the module. The illustration above shows the connector assignments for both the FR1 and FR2 when used with the RD10MD2.

Output configuration is discussed next in *User Controls*.

User Controls

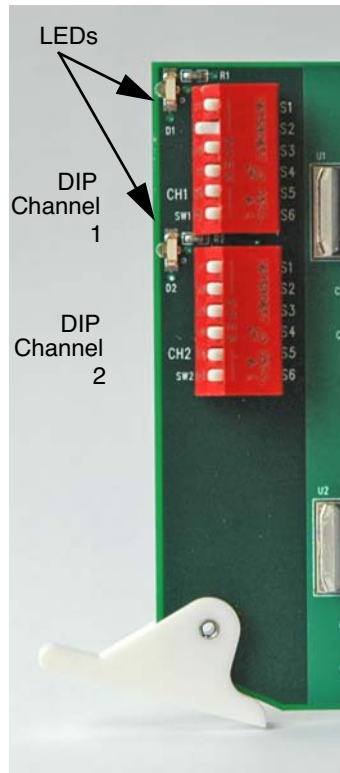

The user interface for configuring the RD10MD2 and selecting output formats is a pair of dipswitches at the front of the card and several jumpers in the middle and at the back of the card (see J2, J3, J5, and J6 in the photo below).

Two multi-color LEDs at the front of the card additionally show the type of input present at each channel (HD=Orange or SD=Green).

The loop outputs always reflect the reclocked input. Each channel has a reclocked looped output.

The format of the downconverter outputs, either SDI or analog composite, are configured by the jumpers J5 and J6. Jumpers J2 and J3 configure the HD to SD delay and the type of embedded timecode (RP188 or RP215). Tables later in the manual define the jumper settings and their corresponding meanings.

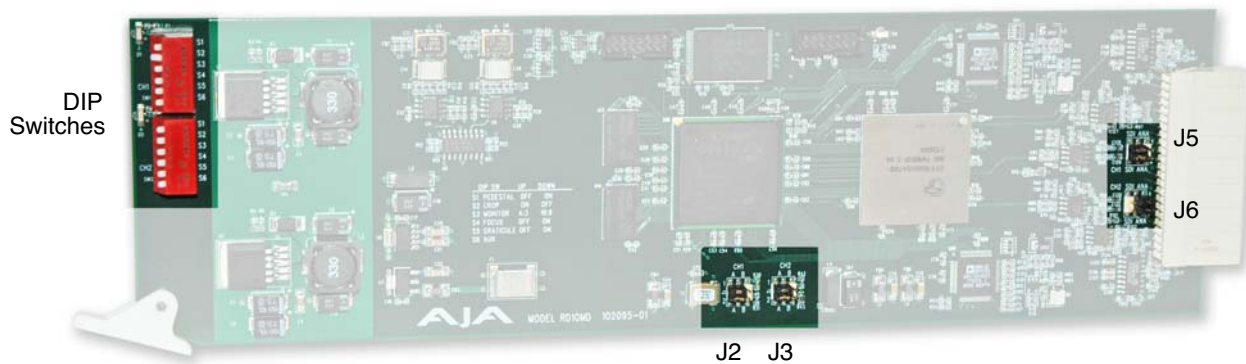

RD10MD2 Card Module, User Controls

DIP Switch Settings

There is a separate 6-position dipswitch for each channel that controls a number of configuration settings for the RD10MD2 card. The top dipswitch controls channel 1 and the one beneath it, channel 2. Settings are the same for both dipswitches. These are described in the following table.

Switch Number	Description	Details
1	Pedestal	UP = Pedestal Off DOWN = Pedestal On
2	Crop	UP = Crop On—the Horizontal Edges are cropped off from the input lines; all output lines are used DOWN = Crop Off—black bars are on top and bottom; all of the input line is visible horizontally
3	Monitor	UP = 4:3 monitor DOWN = 16:9 monitor
4	Focus	UP = Off, not in focus mode DOWN = On, in focus mode: passes the middle 720 pixels and 486 lines without filtering
5	Graticule	UP= Graticule Off DOWN = Display Graticule showing safe area for 4:3 material on the 16:9 raster
6	AUX	Unused

Jumper Settings

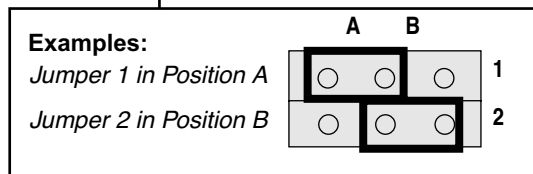
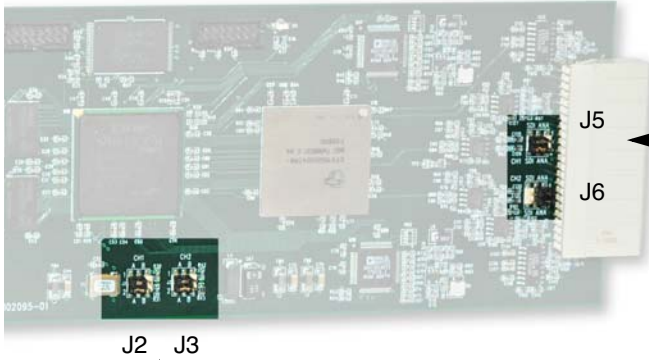

Jumpers J2 & J3 set Delay and Timecode Type
 J2 configures Channel 1 Output
 J3 configures Channel 2 Output

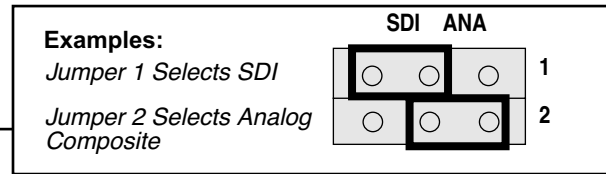

Jumpers J5 & J6 select SDI or Analog Output.
 J5 configures Channel 1 Output
 J6 configures Channel 2 Output

RD10MD2 Card Module, Jumper Settings

Jumper	Meaning of Settings
J2 Channel 1	<p>Jumper placed in 1A: Sets Channel 1 HD to SD delay to align with VSYNC (per Panasonic deck)</p> <p>Jumper placed in 1B: Sets Channel 1 HD to SD delay to align with the end of active (per Nvision gen)</p> <p>Jumper placed in 2A: Select Channel 1 to have RP188 embedded timecode</p> <p>Jumper placed in 2B: Select Channel 1 to have RP215 embedded timecode</p>
J3 Channel 2	<p>Jumper placed in 1A: Sets Channel 2 HD to SD delay to align with VSYNC (per Panasonic deck)</p> <p>Jumper placed in 1B: Sets Channel 2 HD to SD delay to align with the end of active (per Nvision gen)</p> <p>Jumper placed in 2A: Select Channel 2 to have RP188 embedded timecode</p> <p>Jumper placed in 2B: Select Channel 2 to have RP215 embedded timecode</p>
J5 Channel 1	<p>Jumper placed in 1 SDI: Set Channel 1 output 1 to SDI</p> <p>Jumper placed in 1 ANA: Set Channel 1 output 1 to Analog Composite</p> <p>Jumper placed in 2 SDI: Set Channel 1 output 2 to SDI</p> <p>Jumper placed in 2 ANA: Set Channel 1 output 2 to Analog Composite</p>
J6 Channel 2	<p>Jumper placed in 1 SDI: Set Channel 2 output 1 to SDI</p> <p>Jumper placed in 1 ANA: Set Channel 2 output 1 to Analog Composite</p> <p>Jumper placed in 2 SDI: Set Channel 2 output 2 to SDI</p> <p>Jumper placed in 2 ANA: Set Channel 2 output 2 to Analog Composite</p>

Installation

Typically, RD10MD2 installation consists of the following:

1. disconnect power from the frame (remove line cord)
2. remove the FR1/FR2 front panel
3. install RD10MD2 card module
4. replace the FR1/FR2 front panel
5. apply power to the frame by connecting a north american-style power cord from the frame to mains power (90 to 260 VAC)



Warning!

Ensure Mains Power is disconnected before installing the FR1 or FR2 frame R-series modules into the frame, or installing and removing options. If a Mains switch is not provided, the power cord(s) of this equipment provide the means of disconnection. The socket outlet must be installed near the equipment and must be easily accessible.



Warning!

FR2 Dual Power Cord Notice—please read this. To reduce the risk of electrical shock, disconnect both power cords before servicing equipment.



Caution!

The FR1/FR2 front fan door is heavy and is not hinged. Remove with Caution.

Instructions for removing the frame front door for module installation is discussed in the *FR1/FR2 User Manual*.

Specifications

Item	Specification
Formats:	HD: 1080i 50/59.94/60 Hz 1080p/psf 23.98/24/25/29.97/30 Hz 720p 23.98/24/25/29.97/30/50/60 Hz
Inputs:	2 Channels, HD-SDI or SDI SMPTE 259/292/296, 10-bit, 2x BNC
Outputs:	Each Channel has two outputs configurable for either SDI (SMPTE 259M, 10-bit) or analog composite NTSC/PAL, 2x BNC Channel 1 has one reclocked loop-through output, 1 BNC Channel 2 has one reclocked loop-through output, 1 BNC
Downconversion:	Multi-point interpolation, 10-bit processing 3:2 conversion for 23.98/24p/psf inputs
Size:	Fits AJA R-Series Frames
Power Consumption:	7 watts

Appendix A: Safety & Compliance

Federal Communications Commission (FCC) Compliance Notices

Class A Interference Statement

This equipment has been tested and found to comply with the limits for a Class A digital device, pursuant to Part 15, Subpart B of the FCC Rules. These limits are designed to provide reasonable protection against harmful interference in a commercial installation. This equipment generates, uses, and can radiate radio frequency energy and, if not installed and used in accordance with the instructions, may cause harmful interference to radio communications. However, there is no guarantee that interference will not occur in a particular installation. Operation of this equipment in a residential area is likely to cause harmful interference in which case the user will be required to correct the interference at his own expense. If this equipment does cause harmful interference to radio or television reception, which can be determined by turning the equipment off and on, the user is encouraged to try to correct the interference by one or more of the following measures:

- Reorient or relocate the receiving antenna.
- Increase the separation between the equipment and receiver.
- Connect the equipment into an outlet on a circuit different from that to which the receiver is connected.
- Consult the dealer or an experienced radio/TV technician for help.

FCC Caution

This device complies with Part 15 of the FCC Rules. Operation is subject to the following two conditions: (1) This device may not cause harmful interference, and (2) this device must accept any interference received, including interference that may cause undesired operation.

Canadian ICES Statement

Canadian Department of Communications Radio Interference Regulations

This digital apparatus does not exceed the Class A limits for radio-noise emissions from a digital apparatus as set out in the Radio Interference Regulations of the Canadian Department of Communications. This Class A digital apparatus complies with Canadian ICES-003.

Règlement sur le brouillage radioélectrique du ministère des Communications

Cet appareil numérique respecte les limites de bruits radioélectriques visant les appareils numériques de classe A prescrites dans le Règlement sur le brouillage radioélectrique du ministère des Communications du Canada. Cet appareil numérique de la Classe A est conforme à la norme NMB-003 du Canada.

European Union and European Free Trade Association (EFTA) Regulatory Compliance

This equipment may be operated in the countries that comprise the member countries of the European Union and the European Free Trade Association. These countries, listed in the following paragraph, are referred to as The European Community throughout this document:

AUSTRIA, BELGIUM, BULGARIA, CYPRUS, CZECH REPUBLIC, DENMARK, ESTONIA, FINLAND, FRANCE, GERMANY, GREECE, HUNGARY, IRELAND, ITALY, LATVIA, LITHUANIA, LUXEMBOURG, MALTA, NETHERLANDS, POLAND, PORTUGAL, ROMANIA, SLOVAKIA, SLOVENIA, SPAIN, SWEDEN, UNITED KINGDOM, ICELAND, LICHTENSTEIN, NORWAY, and SWITZERLAND.

Declaration of Conformity

Marking by this symbol indicates compliance with the Essential Requirements of the EMC Directive of the European Union 2004/108/EC.



This equipment meets the following conformance standards:

Safety:

CB- IEC 60065:2001 + A1:2005

NRTL - UL 60065:2003 R11.06, CSA C22.2 NO. 60065:2003 + A1:06

GS - EN 60065:2002 + A1

Additional licenses issued for specific countries available on request.

Emissions:

EN 55103-1: 1996

EN61000-3-2:2006, EN61000-3-3:1995 +A1:2001 +A2:2005

Immunity:

EN 55103-2: 1996

EN61000-4-2:1995 + A1:1999 + A2:2001, EN61000-4-3:2006, EN61000-4-4:2004,

EN 61000-4-5: 2005, EN 610004-6:2007, EN61000-4-11:2004

The product is also licensed for additional country specific standards as required for the International Marketplace.



Warning!

This is a Class A product. In a domestic environment, this product may cause radio interference, in which case, the user may be required to take appropriate measures.

Achtung! Dieses ist ein Gerät der Funkstörgrenzwertklasse A. In Wohnbereichen können bei Betrieb dieses Gerätes Rundfunkstörungen auftreten, in welchen Fällen der Benutzer für entsprechende Gegenmaßnahmen verantwortlich ist.

Attention! Ceci est un produit de Classe A. Dans un environnement domestique, ce produit risque de créer des interférences radioélectriques, il appartiendra alors à l'utilisateur de prendre les mesures spécifiques appropriées.

Korea KCC Compliance Statement

1) Class A ITE

<p>A급 기기 (업무용 방송통신기기)</p>	<p>이 기기는 업무용 (A 급) 으로 전자파적합등록을 한 기기이오니 판매자 또는 사용자는 이 점을 주의하시기 바라며, 가정외의 지역에서 사용하는 것을 목적으로 합니다.</p>
-------------------------------	--

1) Class A device

<p>Class A (Broadcasting and Communication Equipment for Business Use)</p>	<p>Please note that this equipment has obtained EMC registration for business use (Class A), and it is intended to use in other than home area.</p>
--	---

Taiwan Compliance Statement

警告使用者：
這是甲類的資訊產品，在居住的環境中使用時，可能會造成射頻干擾，在這種情況下，使用者會被要求採取某些適當的對策。

This is a Class A product based on the standard of the Bureau of Standards, Metrology and Inspection (BSMI) CNS 13438, Class A.

Japanese Compliance Statement

1. Class A ITE

この装置は、クラスA 情報技術装置です。この装置を家庭環境で使用すると電波妨害を引き起こすことがあります。この場合には使用者が適切な対策を講ずるよう要求されることがあります。VCCI-A

This is a Class A product based on the standard of the VCCI Council (VCCI V-3/2008.04). If this equipment is used in a domestic environment, radio interference may occur, in which case, the user may be required to take corrective actions.

Translated caution statements, warning conventions and warning messages

The following caution statements, warning conventions, and warning messages apply to this product and manual.



Warning Symbol



Caution Symbol

Before operating your unit, please read the instructions in this document



Warning!

Read and follow all warning notices and instructions marked on the product or included in the documentation.

Avertissement ! Lisez et conformez-vous à tous les avis et instructions d'avertissement indiqués sur le produit ou dans la documentation.

Warnung! Lesen und befolgen Sie die Warnhinweise und Anweisungen, die auf dem Produkt angebracht oder in der Dokumentation enthalten sind.

¡Advertencia! Lea y siga todas las instrucciones y advertencias marcadas en el producto o incluidas en la documentación.

Aviso! Leia e siga todos os avisos e instruções assinalados no produto ou incluídos na documentação.

Avviso! Leggere e seguire tutti gli avvisi e le istruzioni presenti sul prodotto o inclusi nella documentazione.

**Warning!**

Do not use this device near water and clean only with a dry cloth.

Avertissement! N'utilisez pas cet appareil près de l'eau et nettoyez-le seulement avec un tissu sec..

Warnung! Das Gerät nicht in der Nähe von Wasser verwenden und nur mit einem trockenen Tuch säubern.

¡Advertencia! No utilice este dispositivo cerca del agua y límpielo solamente con un paño seco.

Aviso! Não utilize este dispositivo perto da água e limpe-o somente com um pano seco.

Avviso! Non utilizzare questo dispositivo vicino all'acqua e pulirlo soltanto con un panno asciutto.

**Warning!**

Do not block any ventilation openings. Install in accordance with the manufacturer's instructions.

Avertissement ! Ne bloquez aucune ouverture de ventilation. Suivez les instructions du fabricant lors de l'installation.

Warnung! Die Lüftungsöffnungen dürfen nicht blockiert werden. Nur gemäß den Anweisungen des Herstellers installieren.

¡Advertencia! No bloquee ninguna de las aberturas de la ventilación. Instale de acuerdo con las instrucciones del fabricante.

Aviso! Não obstrua nenhuma das aberturas de ventilação. Instale de acordo com as instruções do fabricante.

Avviso! Non ostruire le aperture di ventilazione. Installare in conformità con le istruzioni del fornitore.

**Warning!**

Do not install near any heat sources such as radiators, heat registers, stoves, or other apparatus (including amplifiers) that produce heat.

Avertissement ! N'installez pas l'appareil près d'une source de chaleur telle que des radiateurs, des bouches d'air de chauffage, des fourneaux ou d'autres appareils (amplificateurs compris) qui produisent de la chaleur.

Warnung! Nicht in der Nähe von Wärmequellen wie Heizkörpern, Heizregistern, Öfen oder anderen Wärme erzeugenden Geräten (einschließlich Verstärkern) aufstellen.

¡Advertencia! No instale cerca de fuentes de calor tales como radiadores, registros de calor, estufas u otros aparatos (incluidos amplificadores) que generan calor.

Aviso! Não instale perto de nenhuma fonte de calor tal como radiadores, saídas de calor, fogões ou outros aparelhos (incluindo amplificadores) que produzam calor.

Avviso! Non installare vicino a fonti di calore come termosifoni, diffusori di aria calda, stufe o altri apparecchi (amplificatori compresi) che emettono calore.

**Warning!**

Refer all servicing to qualified service personnel. Servicing is required when the device has been damaged in any way, such as power-supply cord or plug is damaged, liquid has been spilled or objects have fallen into the device, the device has been exposed to rain or moisture, does not operate normally, or has been

dropped.

Avertissement ! Référez-vous au personnel de service qualifié pour tout entretien. L'entretien est exigé quand l'appareil a été endommagé de quelque manière que ce soit, par exemple lorsque le cordon d'alimentation ou la prise sont endommagés, que du liquide a été versé ou des objets sont tombés dans l'appareil, que l'appareil a été exposé à la pluie ou à l'humidité, ne fonctionne pas normalement ou est tombé.

Warnung! Das Gerät sollte nur von qualifizierten Fachkräften gewartet werden. Eine Wartung ist fällig, wenn das Gerät in irgendeiner Weise beschädigt wurde, wie bei beschädigtem Netzkabel oder Netzstecker, falls Flüssigkeiten oder Objekte in das Gerät gelangen, das Gerät Regen oder Feuchtigkeit ausgesetzt wurde, nicht ordnungsgemäß funktioniert oder fallen gelassen wurde.

¡Advertencia! Consulte al personal calificado por cuestiones de reparación. El servicio de reparación se requiere cuando el dispositivo ha recibido cualquier tipo de daño, por ejemplo cable o espigas dañadas, se ha derramado líquido o se han caído objetos dentro del dispositivo, el dispositivo ha sido expuesto a la lluvia o humedad, o no funciona de modo normal, o se ha caído.

Aviso! Remeta todos os serviços de manutenção para o pessoal de assistência qualificado. A prestação de serviços de manutenção é exigida quando o dispositivo foi danificado mediante qualquer forma, como um cabo de alimentação ou ficha que se encontra danificado/a, quando foi derramado líquido ou caíram objetos sobre o dispositivo, quando o dispositivo foi exposto à chuva ou à humidade, quando não funciona normalmente ou quando foi deixado cair.

Avviso! Fare riferimento al personale qualificato per tutti gli interventi di assistenza. L'assistenza è necessaria quando il dispositivo è stato danneggiato in qualche modo, ad esempio se il cavo di alimentazione o la spina sono danneggiati, è stato rovesciato del liquido è stato rovesciato o qualche oggetto è caduto nel dispositivo, il dispositivo è stato esposto a pioggia o umidità, non funziona correttamente o è caduto.



Caution!

This device is a Class A product. Operation of this equipment in a residential area is likely to cause harmful interference, in which case users will be required to take whatever measures may be necessary to correct the interference at their own expense.

Attention! Le périphérique est un produit de Classe A. Le fonctionnement de cet équipement dans une zone résidentielle risque de causer des interférences nuisibles, auquel cas l'utilisateur devra y remédier à ses propres frais.

Achtung! Dies ist ein Gerät der Klasse A. Bei Einsatz des Geräts in Wohngebieten kann es Störungen des Radio- und Fernsehempfangs verursachen. In diesem Fall muss der Benutzer alle notwendigen Maßnahmen ergreifen, die möglicherweise nötig sind, um die Störungen auf eigene Rechnung zu beheben.

¡Precaución! Este es un producto clase A. El uso de este equipo en áreas residenciales puede causar interferencias nocivas, en cuyo caso, se requerirá que los usuarios tomen cualquier medida necesaria para corregir la interferencia por cuenta propia.

Cuidado! Este dispositivo é um produto Classe A. Operar este equipamento em uma área residencial provavelmente causará interferência prejudicial; neste caso, espera-se que os usuários tomem as medidas necessárias para corrigir a interferência por sua própria conta.

Attenzione! Questo dispositivo è un prodotto di Classe A. Il funzionamento di questo apparecchio in aree residenziali potrebbe causare interferenze dannose, nel cui caso agli utenti verrà richiesto di adottare tutte le misure necessarie per porre rimedio alle interferenze a proprie spese.



Warning!

Disconnect the external AC power supply line cord(s) from the mains power before moving the unit.

Avertissement ! Retirez le ou les cordons d'alimentation en CA de la source d'alimentation principale lorsque vous déplacez l'appareil.

Warnung! Trennen Sie die Wechselstrom-Versorgungskabel vom Netzstrom, bevor Sie das Gerät verschieben.

¡Advertencia! Cuando mueva la unidad desenchufe de la red eléctrica el/los cable(s) de la fuente de alimentación CA tipo brick.

Advertência! Remova os cabos CA de alimentação brick da rede elétrica ao mover a unidade.

Avvertenza! Scollegare il cavo dell'alimentatore quando si sposta l'unità.



Warning!

Ensure Mains Power is disconnected before installing the FR1 or FR2 frame R-series modules into the frame, or installing and removing options. If a Mains switch is not provided, the power cord(s) of this equipment provide the means of disconnection. The socket outlet must be installed near the equipment and must be easily accessible.

Avertissement ! S'assurer que la source principale d'alimentation est débranchée avant d'installer les modules des cartes série R de boîtier FR1 ou FR2 sur l'appareil, ou avant d'installer ou de supprimer des options. Si aucun commutateur principal n'est fourni, le ou les cordons d'alimentation de cet équipement fournissent le moyen nécessaire pour le débranchement. La prise doit être installée près de l'équipement et doit être facilement accessible.

Warnung! Vor der Installation der FR1 oder FR2 Steckkartenmodule der R-Serie in den Rahmen bzw. vor der Installation oder dem Entfernen von Optionen muss sichergestellt werden, dass der Netzstrom ausgeschaltet bzw. abgetrennt ist. Wenn kein Netzschalter verfügbar ist, kann der Netzstrom mithilfe des/der Netzkabel(s) am Gerät getrennt werden. Die Steckdose muss in der Nähe des Geräts installiert und leicht zugänglich sein.

¡Advertencia! Asegúrese de que la energía de la red de electricidad esté desconectada antes de instalar el módulo de tarjeta de cuadro FR1 o FR2 serie R dentro del cuadro, o antes de instalar o desinstalar opciones. Si el interruptor de la red eléctrica no se encuentra disponible, desconecte el/los cable(s) eléctrico(s) del equipo. La toma de corriente debe ser instalada cerca del equipo y debe estar fácilmente accesible.

Advertência! Certifique-se de que a alimentação principal esteja desconectada antes de instalar os cartões R-series FR1 ou FR2 no quadro ou ao instalar e desinstalar opcionais. Se não houver um interruptor de alimentação principal, o próprio cabo de alimentação do equipamento é o meio de desconexão. A tomada de alimentação deve ser instalada próxima ao equipamento e seu acesso deve ser fácil.

Avvertenza! Verificare che la rete di alimentazione sia scollegata prima di installare i moduli FR1 o FR2 serie R nel telaio, o installare o rimuovere le opzioni. Se non è disponibile un interruttore di alimentazione, il/i cavo/i di alimentazione di questa apparecchiatura forniscono i mezzi di sconnessione. La presa deve essere installata vicino all'apparecchio e deve essere facilmente accessibile.



Warning!

FR2 Dual Power Cord Notice—please read this. To reduce the risk of electrical shock, disconnect both power cords before servicing equipment.

Avertissement ! Notice relative aux doubles cordons d'alimentation de FR2—veuillez lire. Pour réduire le risque de choc électrique, débranchez les deux cordons d'alimentation avec d'effectuer tout entretien de l'équipement.

Warnung! Hinweis zum FR2 mit doppeltem Netzkabel – bitte beachten. Um das Risiko eines Elektroschocks zu verringern, sind beide Netzkabel vor der Wartung des Geräts abzutrennen.

¡Advertencia! Aviso: Cable eléctrico FR2 dual — Por favor leer. Para reducir el riesgo de electrocución, desconecte ambos cables eléctricos antes de reparar el equipo.

Advertência! Aviso do cabo duplo de alimentação FR2 — leia isto. Para reduzir o risco de choque elétrico, desconecte ambos os cabos de alimentação antes de qualquer manutenção no equipamento.

Avvertenza! Avviso cavo a doppia potenza FR2. Per ridurre il rischio di scosse elettriche, scollegare entrambi i cavi di alimentazione prima di effettuare qualsiasi operazione di manutenzione.

**Caution!**

The FR1/FR2 front fan door is heavy and is not hinged. Remove with Caution.

Attention ! La porte frontale du ventilateur de FR1/FR2 est lourde et ne repose pas sur des charnières. Retirer avec précaution.

Achtung! Die vordere Gebläsetür des FR1/FR2 ist schwer und lässt sich nicht klappen. Bitte vorsichtig entfernen.

¡Precaución! La puerta del ventilador delantero del FR1/FR2 es pesada y no posee bisagras. Extraer con precaución.

Atenção! A porta frontal de acesso aos ventiladores do FR1/FR2 é pesada e não possui dobradiças. Remova com cuidado.

Attenzione! La porta anteriore della ventola FR1/FR2 è pesante e non è a cerniera. Rimuovere con cautela.

