



INSTRUCTION MANUAL

ACB-2110

ACB-2107

ACENDO BOOK

10" & 7" SCHEDULING TOUCH PANELS

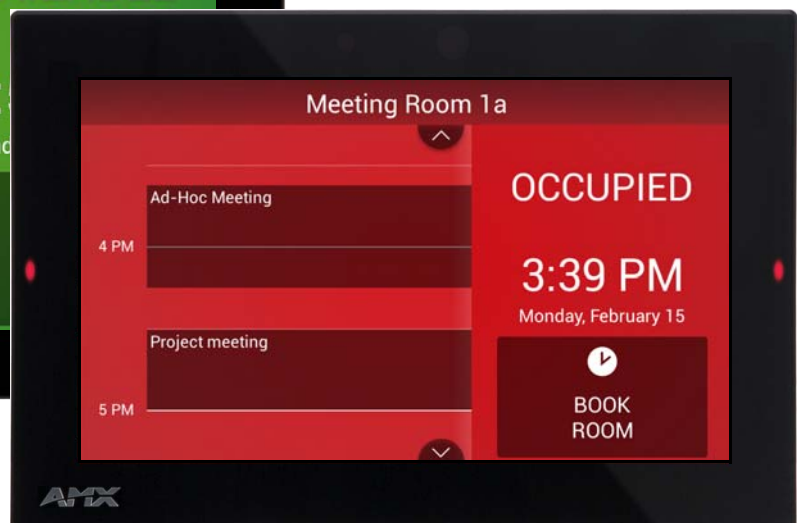
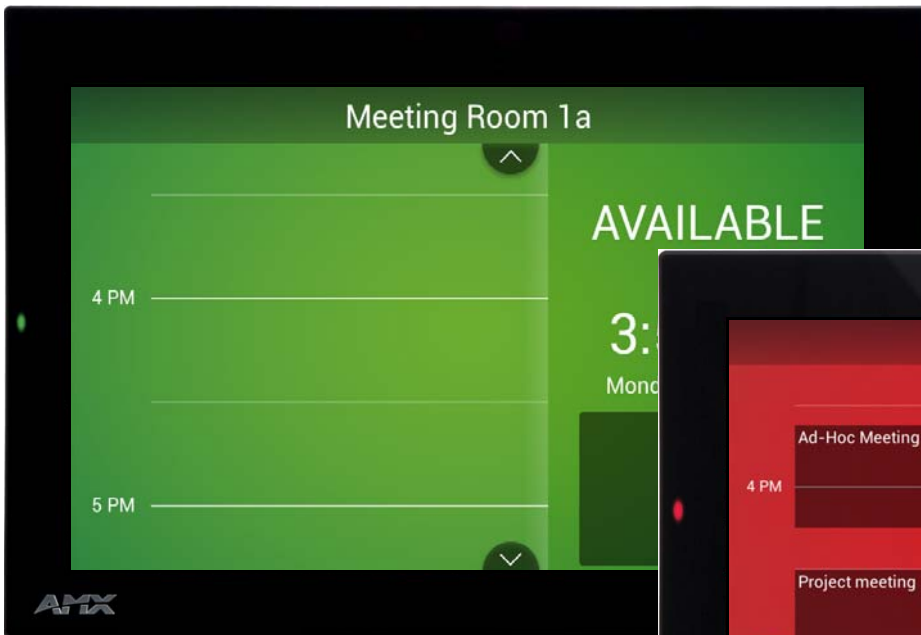

IMPORTANT SAFETY INSTRUCTIONS

1. READ these instructions.
2. KEEP these instructions.
3. HEED all warnings.
4. FOLLOW all instructions.
5. DO NOT use this apparatus near water.
6. CLEAN ONLY with dry cloth.
7. DO NOT block any ventilation openings. Install in accordance with the manufacturer's instructions.
8. DO NOT install near any heat sources such as radiators, heat registers, stoves, or other apparatus (including amplifiers) that produce heat.
9. DO NOT defeat the safety purpose of the polarized or grounding type plug. A polarized plug has two blades with one wider than the other. A grounding type plug has two blades and a third grounding prong. The wider blade or the third prong are provided for your safety. If the provided plug does not fit into your outlet, consult an electrician for replacement of the obsolete outlet.
10. PROTECT the power cord from being walked on or pinched, particularly at plugs, convenience receptacles, and the point where they exit from the apparatus.
11. ONLY USE attachments/accessories specified by the manufacturer.



12. USE ONLY with a cart, stand, tripod, bracket, or table specified by the manufacturer, or sold with the apparatus. When a cart is used, use caution when moving the cart/apparatus combination to avoid injury from tip-over.
13. UNPLUG this apparatus during lightning storms or when unused for long periods of time.
14. REFER all servicing to qualified service personnel. Servicing is required when the apparatus has been damaged in any way, such as power-supply cord or plug is damaged, liquid has been spilled or objects have fallen into the apparatus, the apparatus has been exposed to rain or moisture, does not operate normally, or has been dropped.
15. DO NOT expose this apparatus to dripping or splashing and ensure that no objects filled with liquids, such as vases, are placed on the apparatus.
16. To completely disconnect this apparatus from the AC Mains, disconnect the power supply cord plug from the AC receptacle.
17. Where the mains plug or an appliance coupler is used as the disconnect device, the disconnect device shall remain readily operable.
18. DO NOT overload wall outlets or extension cords beyond their rated capacity as this can cause electric shock or fire.



The exclamation point, within an equilateral triangle, is intended to alert the user to the presence of important operating and maintenance (servicing) instructions in the literature accompanying the product.



The lightning flash with arrowhead symbol within an equilateral triangle is intended to alert the user to the presence of uninsulated "dangerous voltage" within the product's enclosure that may be of sufficient magnitude to constitute a risk of electrical shock to persons.



ESD Warning: The icon to the left indicates text regarding potential danger associated with the discharge of static electricity from an outside source (such as human hands) into an integrated circuit, often resulting in damage to the circuit.

- WARNING:** To reduce the risk of fire or electrical shock, do not expose this apparatus to rain or moisture.
- WARNING:** No naked flame sources - such as lighted candles - should be placed on the product.
- WARNING:** Equipment shall be connected to a MAINS socket outlet with a protective earthing connection.

COPYRIGHT NOTICE

AMX© 2017, all rights reserved. No part of this publication may be reproduced, stored in a retrieval system, or transmitted, in any form or by any means, electronic, mechanical, photocopying, recording, or otherwise, without the prior written permission of AMX. Copyright protection claimed extends to AMX hardware and software and includes all forms and matters copyrightable material and information now allowed by statutory or judicial law or herein after granted, including without limitation, material generated from the software programs which are displayed on the screen such as icons, screen display looks, etc. Reproduction or disassembly of embodied computer programs or algorithms is expressly prohibited.

LIABILITY NOTICE

No patent liability is assumed with respect to the use of information contained herein. While every precaution has been taken in the preparation of this publication, AMX assumes no responsibility for error or omissions. No liability is assumed for damages resulting from the use of the information contained herein. Further, this publication and features described herein are subject to change without notice.

AMX WARRANTY AND RETURN POLICY

The AMX Warranty and Return Policy and related documents can be viewed/downloaded at www.amx.com.

ESD WARNING

	<p>To avoid ESD (Electrostatic Discharge) damage to sensitive components, make sure you are properly grounded before touching any internal materials.</p> <p>When working with any equipment manufactured with electronic devices, proper ESD grounding procedures must be followed to make sure people, products, and tools are as free of static charges as possible. Grounding straps, conductive smocks, and conductive work mats are specifically designed for this purpose.</p> <p>Anyone performing field maintenance on AMX equipment should use an appropriate ESD field service kit complete with at least a dissipative work mat with a ground cord and a UL listed adjustable wrist strap with another ground cord</p>
---	--

	<p>WARNING: Do Not Open! Risk of Electrical Shock. Voltages in this equipment are hazardous to life. No user-serviceable parts inside. Refer all servicing to qualified service personnel.</p> <p>Place the equipment near a main power supply outlet and make sure that you can easily access the power breaker switch.</p>
---	---

WARNING: This product is intended to be operated ONLY from the voltages listed on the back panel or the recommended, or included, power supply of the product. Operation from other voltages other than those indicated may cause irreversible damage to the product and void the products warranty. The use of AC Plug Adapters is cautioned because it can allow the product to be plugged into voltages in which the product was not designed to operate. If the product is equipped with a detachable power cord, use only the type provided with your product or by your local distributor and/or retailer. If you are unsure of the correct operational voltage, please contact your local distributor and/or retailer.

WARNING: Avoid exposure to extreme heat or cold.

FCC AND CANADA EMC COMPLIANCE INFORMATION:

This device complies with part 15 of the FCC Rules. Operation is subject to the following two conditions:

(1) This device may not cause harmful interference, and (2) this device must accept any interference received, including interference that may cause undesired operation.

NOTE: This equipment has been tested and found to comply with the limits for a Class B digital device, pursuant to part 15 of the FCC Rules. These limits are designed to provide reasonable protection against harmful interference in a residential installation. This equipment generates, uses and can radiate radio frequency energy and, if not installed and used in accordance with the instructions, may cause harmful interference to radio communications. However, there is no guarantee that interference will not occur in a particular installation. If this equipment does cause harmful interference to radio or television reception, which can be determined by turning the equipment off and on, the user is encouraged to try to correct the interference by one or more of the following measures:

- Reorient or relocate the receiving antenna.
- Increase the separation between the equipment and receiver.
- Connect the equipment into an outlet on a circuit different from that to which the receiver is connected.
- Consult the dealer or an experienced radio/TV technician for help.

CAN ICES-3 (B)/NMB-3(B)

EU COMPLIANCE INFORMATION:

Eligible to bear the CE mark; Conforms to European Union Low Voltage Directive 2014/35/EC; European Union EMC Directive 2014/30/EU; European Union Restriction of Hazardous Substances Recast (RoHS2) Directive 2011/65/EU; European Union WEEE (recast) Directive 2012/19/EU; European Union Eco-Design Directive 2009/125/EC; European Union Registration, Evaluation, Authorization and Restriction of Chemicals (REACH) Directive 2006/121/EC.

You may obtain a free copy of the Declaration of Conformity by visiting <http://www.amx.com/techcenter/certifications.asp>.

WEEE NOTICE:

	<p>This appliance is labeled in accordance with European Directive 2012/19/EU concerning waste of electrical and electronic equipment (WEEE). This label indicates that this product should not be disposed of with household waste. It should be deposited at an appropriate facility to enable recovery and recycling.</p>
---	--

ENVIRONMENTAL:



	<p>This device is designed and evaluated under the condition of non-tropical climate; it can only be used in locations in non-tropical climate areas. Using the device in tropical climate areas could result in a potential safety hazard.</p>
	<p>This device is designed and evaluated under the condition of altitude below 2000 meters above sea level; it can only be used in locations below 2000 meters above sea level. Using the device above 2000 meters could result in a potential safety hazard.</p>

Table of Contents

Acendo Book Scheduling Panels	9
Overview	9
ACB-2110	9
ACB-2107	11
Supported Scheduling Systems	12
Configuring Acendo Book Touch Panels	12
Initial Panel Configuration (Scheduling Panel Setup Wizard)	12
Accessing the SETTINGS Window	13
Configuring Scheduler Settings	13
Configuring Touch Panel Settings	13
Powering Off the Panel	13
Cleaning the Touch Panel	13
Installation	14
Overview	14
A Note About Wall and Rack Installation	14
Installation Recommendations	15
Mounting Options	15
Power Over Ethernet	15
Plastic Backbox	15
STEP 1: Install the Plastic Backbox	16
STEP 2: Insert Connectors on the Touch Panel.....	18
STEP 3: Secure the Touch Panel To the Backbox	18
UPPER TABS FIRST	18
LOWER TABS - Gently Snap Into Place	18
Removing the ACB-2110/701 Panel from the Backbox.....	19
Installation Dimensions.....	20
ACB-2110 Dimensions	20
ACB-2107 Dimensions	21
Using the Scheduling Panel Setup Wizard	22
Overview	22
Setup Wizard: Step 1 - OVERVIEW	22
Using the On-Screen Keyboard/Keypad	22
Setup Wizard: Step 2 - NETWORK	23
Setup Wizard: Step 3 - CALENDAR.....	24
Calendar Types	24
Microsoft Exchange	24
SSL Validation Schemes	25
Office 365.....	25
Google Calendar	26

Setup Wizard: Step 4 - LOCALIZATION	28
Setup Wizard: Step 5 - GROUP	29
Creating a Scheduling Group	30
Configuring the Master Panel.....	30
Configuring Member Panels	30
Setup Wizard: Step 6 - ROOM	31
Changing the Logo Image	31
Setup Wizard: Step 7 - SECURITY	33
Changing the Administrator Password on the Panel	33
Setting a Meeting PIN Code.....	34
Privacy Mode.....	34
Privacy Mode: Meetings Scheduled from an Acendo Book Panel	34
Privacy Mode: Meetings Scheduled from Mail/Web Client	34
Editing the Private Meeting Subject Message Text	34
Exiting the Scheduling Panel Setup Wizard	35
Scheduler Settings	36
Overview	36
Accessing the Scheduler Settings Pages	36
Viewing/Editing Network Settings	37
Changing the IP Address on the Acendo Book Panel.....	37
Proxy Setup.....	38
SERVICE CONTROLLER.....	38
PROXY SETTINGS.....	38
ACCOUNT INFORMATION	38
Viewing/Editing Calendar Settings	39
More Information.....	39
Viewing/Editing Localization Settings.....	39
Changing the Language Displayed On the Acendo Book Panel	40
Changing the Timezone Displayed On the Acendo Book Panel.....	40
Changing the Time Format Displayed On the Acendo Book Panel.....	40
Changing the Date Format Displayed On the Acendo Book Panel.....	40
Changing the Default Meeting Length Displayed On the Acendo Book Panel.....	41
Changing the Default Meeting Length Increment Displayed On the Acendo Book Panel.....	41
Viewing/Editing Group Settings	41
Viewing/Editing Room Settings.....	42
Viewing/Editing Security Settings.....	42
Advanced Settings	43
Overview	43
Accessing the Advanced Settings Pages	43
Using the Advanced Settings Menu	43
Advanced Settings Menu Options.....	43
Opening Advanced Settings pages.....	44
Closing the Advanced Settings menu.....	44

INFO - Device Info	44
DEVICE	44
MEMORY AND FILES	44
MISC	44
INFO - Maintenance	45
Rebooting the Panel	45
Shutting Down the Panel	45
DEVICE - Sound	46
SOUND	46
SYSTEM SOUNDS	46
Adjusting Volumes	46
Selecting a Default Notification Sound	46
DEVICE - Display	47
Adjusting Panel Brightness	47
Adjusting Display Timeout	48
Calibration Test	48
Calibrate	49
DEVICE - VNC	49
VNC	49
VNC SERVER	49
Enabling VNC	49
Configuring VNC Access	50
CONNECTIONS - Ethernet	50
Setting Static IP Information	51
Entering a New Hostname	51
SYSTEM - Date & Time	52
Manually Setting a Custom NTP Server	52
Manually Setting the Time Zone	53
SYSTEM - Language & Input	53
KEYBOARD & INPUT METHODS	53
PHYSICAL KEYBOARD	53
Selecting the Panel's Language	54
Personal Dictionary	54
MOUSE/TRACKPAD	54
Changing Input Methods	55
Changing the Pointer Speed	56
SYSTEM - Security	57
PASSWORDS	57
CREDENTIAL STORAGE	57
Setting a Password for This Panel	57
Viewing Trusted CA Certificates (System/User)	58
Disabling and Enabling Trusted CA Certificates	59
Installing Certificates	60
Clearing Credentials	60

SYSTEM - Reset and Update	61
DEVICE RESET	61
UPDATE MANAGER.....	61
Factory Data Reset.....	61
Reset Settings	62
Enable/Disable Web Services	62
Firmware Manager.....	62
Reverting to Factory-Installed Firmware	63
Installing New Firmware From An External USB Stick	63
Install Firmware From Web	64
Using AMX System Recovery	65
SYSTEM - Diagnostics	65
Acendo Book Scheduling Panels - User Guide	66
Overview	66
Room Available Page	66
Room Occupied Page	66
Scheduling an Ad-Hoc Meeting	67
Scheduling a Meeting for Later	68
Browse Rooms for Scheduling	69
BROWSE ROOMS Button.....	69
Viewing/Editing Meeting Details	70
Editing Meeting Details	71
Editing Meeting Times	71
Deleting a Meeting From the Calendar	72
Appendix A: Troubleshooting	73
Overview	73
Configuring Delegation (Exchange 2010).....	76
Using Exchange Admin Center (EMC)	76
Using PowerShell.....	77
Appendix B: Configuring Acendo Book Panels for Microsoft Exchange & Office 365	78
Overview	78
Acendo Book Service Account	78
Microsoft Exchange / Office 365: Username and Calendar Email IDs	78
Microsoft Exchange / Office 365: Certificate Validation.....	79
Microsoft Documentation	79
Configuring Exchange To Hide/Show Meeting "Organizer", "Title" and "Details"	79
Microsoft Documentation	79
Privacy Flag.....	79

Appendix C: Creating Room Mailboxes	80
Overview	80
Creating a New Room Mailbox: Exchange 2010	80
Additional Documentation	80
Creating a New Room Mailbox: Exchange 2013 and Exchange 2016.....	80
Additional Documentation	81
Creating a New Room Mailbox: Office 365	81
Additional Documentation	81
Appendix D: Configuring Google Resources	82
Overview	82
1) Create Resources.....	82
2) Share Resource Calendars With Administrator	84
3) Share Service Calendars With Room Manager Account	85
4) Ensure Calendar Is Set To Deny Conflicts	86

Acendo Book Scheduling Panels

Overview

The **ACB-2110**, 10" Acendo Book Scheduling Panel (FG4221-10) and The **ACB-2107**, 7" Acendo Book Scheduling Panel (FG4221-07) are standalone touch panels that integrate directly with popular room scheduling software like Microsoft Exchange, Office 365 and Google Calendar without additional system hardware requirements. The user interface background color and built-in room availability bars change between red and green to show room availability so users can easily locate and book an available room directly from the panel and, if that room is currently booked, users can quickly locate the nearest available room or the next available time with ease.

Leveraging the style and cost-efficiency of our award winning Modero S Series Touch Panel, Acendo Book Scheduling Panels include SmoothTouch™ Technology, a brilliant full-color high-resolution display, wide viewing angle of screen and availability bar LEDs, and a low profile design for a subtle aesthetic. The ACB-2110/2107 can be mounted on any flat surface, including glass or stone, inside or outside a conference room or classroom.

Acendo Book Scheduling Panels are easy to install using a one-time, panel-based configuration wizard, to get the panel operational in a matter of minutes with minimal training.

NOTE: For end-user instructions on using the Acendo Book panels once they are installed and configured, refer to the Acendo Book Scheduling Panels - User Guide section on page 66.

ACB-2110

The ACB-2110, 10" Acendo Book Scheduling Panel is shown in FIG. 1:

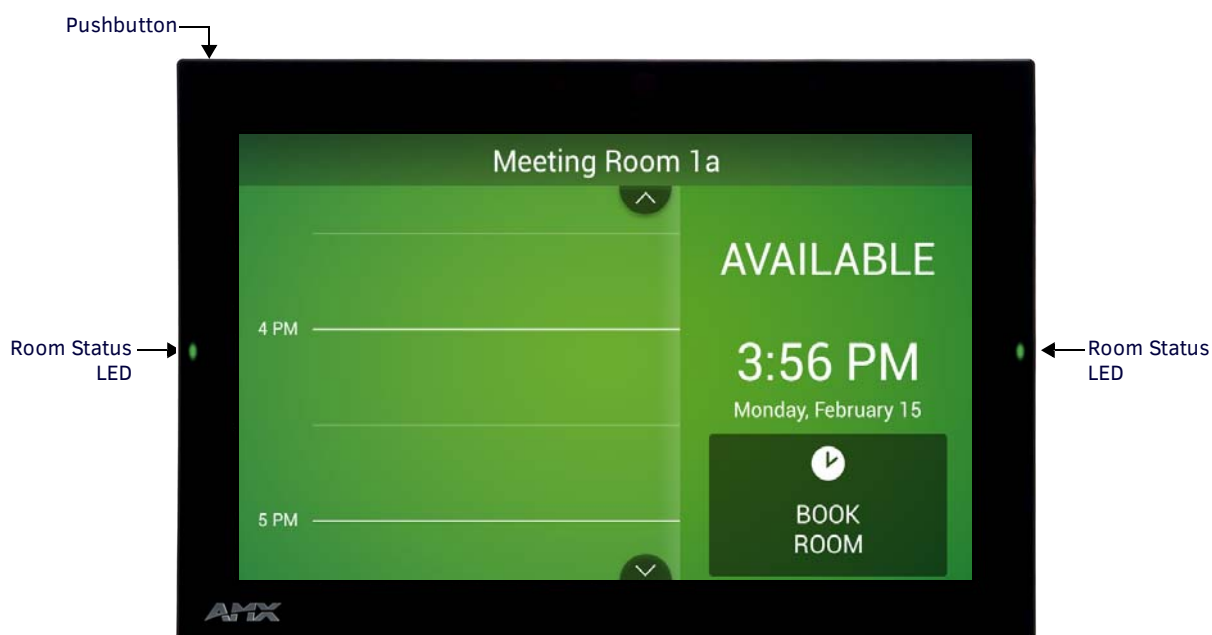

FIG. 1 ACB-2110, 10" Acendo Book Scheduling Panel

ACB-2110 Product Specifications	
DIMENSIONS (HWD):	6 13/16" x 10 1/16" x 2" (174 mm x 255 mm x 51 mm)
WEIGHT:	<ul style="list-style-type: none"> • 1.95 lbs (.885 Kg), with back box • 1.5 lbs (.680 Kg), without back box
POWER CONSUMPTION:	<ul style="list-style-type: none"> • Full-On: 14.5 W (max) • Typical: 7.5 W • Standby: 4.7 W • Shutdown: 0.8 W
EXTERNAL POWER SUPPLY REQUIRED	Optimal performance requires use of one of the following AMX PoE power supplies (not included): <ul style="list-style-type: none"> • PS-POE-AF-TC, PoE Injector, 802.3AF Compliant (FG423-83) • NXA-ENET8-2POE, Gigabit PoE Ethernet Switch (FG2178-63)

ACB-2110 Product Specifications (Cont.)	
TOUCH SCREEN DISPLAY	<ul style="list-style-type: none"> • Display Type: TFT Active Matrix Color LCD with Fringe Field Switching (FFS) - Wide Viewing Angle Technology • Display Size (WH): Landscape: 9.1" x 5.9" (230 mm x 149 mm), 10.8" (274 mm) diagonal • Viewable Area (WH): Landscape: 8.5" x 5.4" (217 mm x 136 mm), 10.0" (256 mm) diagonal • Resolution: Landscape: 1280x800 • Aspect Ratio: Landscape: 16:9 • Brightness: 350 cd/m² • Contrast Ratio: 800:1 • Color Depth: 16.7M colors • Illumination: LED • Touch Overlay: Resistive
VIEWING ANGLE	85°/85°/85°/85° (Up/Down/Left/Right)
MEMORY	<ul style="list-style-type: none"> • SDRAM: 1 GB • Flash: 16 GB
COMMUNICATIONS	Ethernet: 10/100 Mbps/s (full duplex) Auto MDI-X, RJ-45 connector. Supported IP and IP-Based Protocols: UCP, TCP, ICMP, DHCP.
FRONT PANEL COMPONENTS	<ul style="list-style-type: none"> • Room Status LEDs: 2 red/green LEDs on either side of the panel indicate the current room status (green = available, red = occupied). Note that these LEDs can be disabled via options on the Room setup page (see the <i>Setup Wizard: Step 6 - ROOM</i> section on page 31). • Recessed Settings pushbutton (located on the left top edge) provides access to the SETTINGS window. To open the SETTINGS window, use a paper-clip or similar tool to press and hold the pushbutton for 5 seconds. See the <i>Accessing the SETTINGS Window</i> section on page 13 for details.
CONNECTIONS	<ul style="list-style-type: none"> • Ethernet: 10/100 port, RJ-45 connector • USB: (1) USB host 2.0, type A port • Power: PoE (Power over Ethernet), 802.3af, class 0
REGULATORY	<ul style="list-style-type: none"> • FCC Part 15 Class B • AUS/NZ • EN 55032:2012/AC:2013 Class B • CISPR32:2015 • Brazil InMetro • IEC/EN-60950 • KN32 Class B • CAN-ICES-3(B)/NMB-3(B) • UL 60950-1 • RoHS/WEEE compliant
OPTIONAL ACCESSORIES	<ul style="list-style-type: none"> • MXSA-REM-TL, Panel Removal Tool (FG5968-99) • MSA-AMK2-10, Any Mount Kit for 10.1" Modero S Series and Acendo Book Touch Panels (FG2265-36) • MSA-MMK2-10, Multi Mount Kit, 10.1" Modero S Series and Acendo Book Touch Panels (FG2265-21) • PS-POE-AF-TC, PoE Injector, 802.3AF Compliant (FG423-83) • NXA-ENET8-2POE, Gigabit PoE Ethernet Switch (FG2178-63) • CB-MSA-10, Rough-In Box and Cover Plate for 10.1" Modero S Series Wall Mount Touch Panel (FG2265-08) • MSA-RMK-10, Rack Mount Kit for 10" Modero S Series Wall Mount Touch Panel (FG2265-14) • MXA-CLK, Modero X/S Series Cleaning Kit (FG5968-16)

ACB-2107

The ACB-2107, 7" Acendo Book Scheduling Panel is shown in FIG. 2:



FIG. 2 ACB-2107, 7" Acendo Book Scheduling Panel

ACB-2107 Product Specifications	
DIMENSIONS (HWD):	4 7/8" x 7 3/8" x 2 1/4" (123.9 mm x 187.5 mm x 58 mm)
WEIGHT:	<ul style="list-style-type: none"> • 1.05 lbs (.680 Kg), with back box • 0.8 lbs (.363 Kg), without back box
POWER CONSUMPTION:	<ul style="list-style-type: none"> • Full-On: 11 W (max) • Typical: 7.5 W • Standby: 4.5 W • Shutdown: 0.7 W
EXTERNAL POWER SUPPLY REQUIRED	Optimal performance requires use of one of the following AMX PoE power supplies (not included): <ul style="list-style-type: none"> • PS-POE-AF-TC, PoE Injector, 802.3AF Compliant (FG423-83) • NXA-ENET8-2POE, Gigabit PoE Ethernet Switch (FG2178-63)
TOUCH SCREEN DISPLAY	<ul style="list-style-type: none"> • Display Type: TFT Active Matrix Color LCD with Fringe Field Switching (FFS) - Wide Viewing Angle Technology • Display Size (WH): Landscape: 7.3" x 4.8" (186 mm x 122 mm), 8.8" (222 mm) diagonal • Viewable Area (WH): Landscape: 6.05" x 3.54" (154 mm x 90 mm), 7.0" (178 mm) diagonal • Resolution: Landscape: 1024x600 • Aspect Ratio: Landscape: 16:9 • Brightness: 400 cd/m2 • Contrast Ratio: 800:1 • Color Depth: 16.7M colors • Illumination: LED • Touch Overlay: Resistive
VIEWING ANGLE	89°/89°/89°/89° (Up/Down/Left/Right)
MEMORY	<ul style="list-style-type: none"> • SDRAM: 1 GB • Flash: 16 GB
COMMUNICATIONS	Ethernet: 10/100 Mbps/s (full duplex) Auto MDI-X, RJ-45 connector. Supported IP and IP-Based Protocols: UCP, TCP, ICMP, DHCP.
FRONT PANEL COMPONENTS	<ul style="list-style-type: none"> • Room Status LEDs: 2 red/green LEDs on either side of the panel indicate the current room status (green = available, red = occupied). Note that these LEDs can be disabled via options on the Room setup page (see the <i>Setup Wizard: Step 6 - ROOM</i> section on page 31). • Recessed Settings pushbutton (located on the left top edge) provides access to the SETTINGS window. To open the SETTINGS window, use a paper-clip or similar tool to press and hold the pushbutton for 5 seconds. See the <i>Accessing the SETTINGS Window</i> section on page 13 for details.
CONNECTIONS	<ul style="list-style-type: none"> • Ethernet: 10/100 port, RJ-45 connector • USB: (1) USB host 2.0, type A port • Power: PoE (Power over Ethernet), 802.3af, class 0

ACB-2107 Product Specifications (Cont.)	
REGULATORY	<ul style="list-style-type: none"> • FCC Part 15 Class B • AUS/NZ • EN 55032:2012/AC:2013 Class B • CISPR32:2015 • Brazil InMetro • IEC/EN-60950 • KN32 Class B • CAN-ICES-3(B)/NMB-3(B) • UL 60950-1 • RoHS/WEEE compliant
OPTIONAL ACCESSORIES	<ul style="list-style-type: none"> • MXSA-REM-TL, Panel Removal Tool (FG5968-99) • MSA-AMK2-07 Any Mount Kit for 7" Modero S Series and Acendo Book Touch Panels (FG2265-35) • MSA-MMK2-07, Multi Mount Kit for 7" Modero S Series and Acendo Book Touch Panels (FG2265-22) • PS-POE-AF-TC, PoE Injector, 802.3AF Compliant (FG423-83) • NXA-ENET8-2POE, Gigabit PoE Ethernet Switch (FG2178-63) • CB-MXSA-07, Rough-In Box and Cover Plate for the 7" Wall Mount Modero X/S Series Touch Panels (FG039-18) • MSA-RMK-07, Rack Mount Kit for Modero S Series Touch Panel, 7" (FG2265-15) • MXA-CLK, Modero X/S Series Cleaning Kit (FG5968-16)

Supported Scheduling Systems

Acendo Book Scheduling Panels support the following scheduling systems: **Microsoft Exchange**, **Office 365** and **Google Calendar**. The following table indicates the specific versions of each scheduling system that was tested and verified:

Supported Scheduling Systems	
Microsoft Exchange	<ul style="list-style-type: none"> • Exchange 2010 SP3 (Microsoft Exchange Server 2010 Service Pack 3) • Exchange 2013 CU11 (Cumulative Update 11 for Exchange Server 2013) • Exchange 2016 RTM
Office 365	Office 365 Business Premium and Exchange Online (Plan 1)
Google Calendar	Google Apps for Work

Configuring Acendo Book Touch Panels

Initial Panel Configuration (Scheduling Panel Setup Wizard)

The initial configuration for Acendo Book panels is easily accomplished using the *Scheduling Panel Setup Wizard* (FIG. 3):

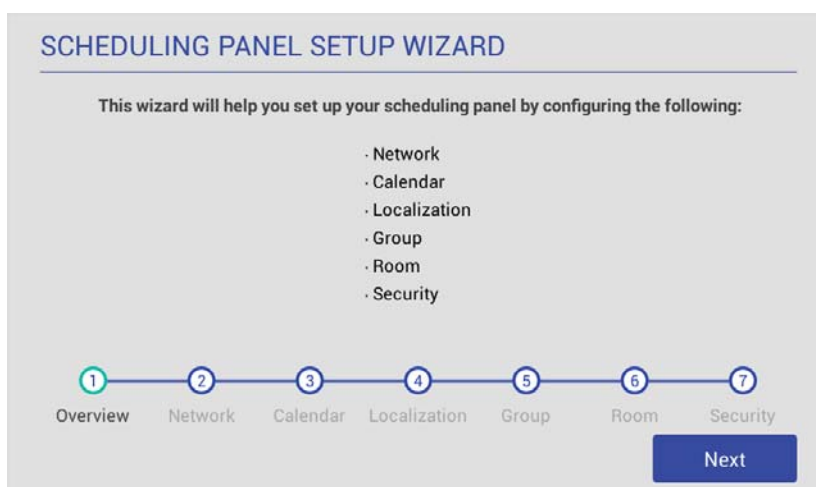

FIG. 3 Scheduling Panel Setup Wizard

The *Scheduling Panel Setup Wizard* is automatically launched the first time the Acendo Book panel is powered up. This wizard steps you through the process of configuring network/communications settings for the touch panel, and presents required configuration options for the selected calendar system. See the *Using the Scheduling Panel Setup Wizard* section on page 22 for details on initial setup and configuration.

Accessing the SETTINGS Window

Scheduler Settings and *Advanced Settings* are both accessed via the SETTINGS window on the Acendo Book panel.

To invoke the SETTINGS window, use a paper-clip or similar tool to press and hold the recessed *Settings* pushbutton located on the top edge of the panel (left side - see FIG. 4) for 5 seconds.

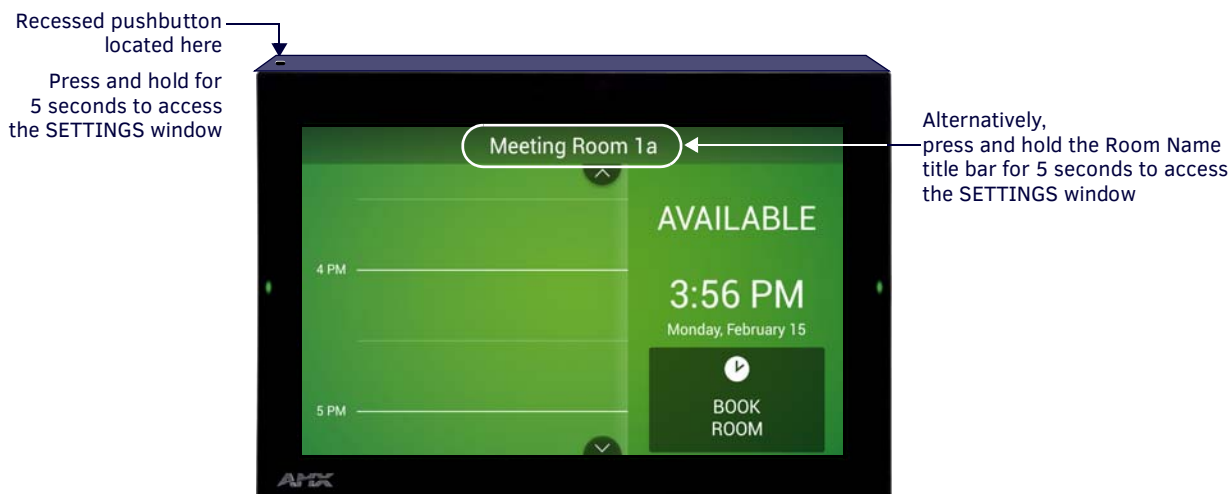

FIG. 4 Pushbutton - Located on the top edge of the panel (left side)

Alternatively, A long press of the room name (5 seconds minimum), will also invoke the SETTINGS window.

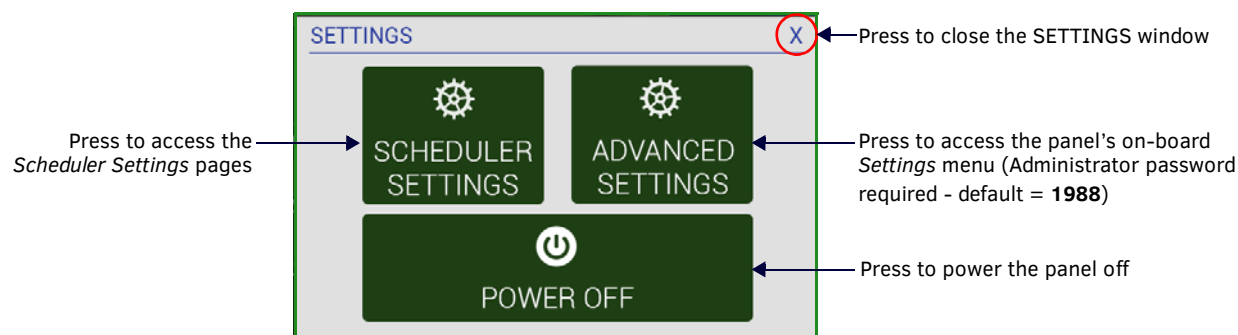

FIG. 5 SETTINGS window

Acendo Book touch panels have two sets of configuration options: *Scheduler Settings*, and *Advanced Settings*:

NOTE: *Scheduler Settings* and *Advanced Settings* are both password-protected. The default Administrator password is "1988". The Administrator password can be changed via options in the Security Setup page - see *Changing the Administrator Password on the Panel* on page 33 for details.

Configuring Scheduler Settings

While the initial configuration for Acendo Book panels is managed via the *Scheduling Panel Setup Wizard* (FIG. 3 on page 12), most of the settings made in the Scheduling Panel Setup Wizard can be edited via the *Scheduler Settings* pages.

Press **SCHEDULER SETTINGS** in the SETTINGS window to open the *Scheduler Settings* pages. Refer to the *Scheduler Settings* section on page 36 for details.

Configuring Touch Panel Settings

ADVANCED SETTINGS are used to configure settings for the touch panel itself. Touch panel-specific settings can be viewed and edited via the ADVANCED SETTINGS option.

Press **ADVANCED SETTINGS** in the SETTINGS window, and enter the Administrator password to access the panel's on-board *Settings* menu. Refer to the *Advanced Settings* section on page 43 for information on viewing/edit touch panel-specific options.

Powering Off the Panel

Note that the SETTINGS window also provides the option to gracefully power down the touch panel.

Press **POWER OFF** to power down the panel.

Cleaning the Touch Panel

When cleaning the device, do not directly spray the device with cleaning fluid. Instead, spray the cloth and then apply the cloth to the touch screen.

CAUTION: Do NOT use abrasives of any type to clean the device, as abrasives may permanently damage or remove the device's finish.

Installation

Overview

Acendo Book Scheduling (wall mount) Touch Panels can be installed via several mounting options:

- Use the included clear plastic Backbox to attach the panel to most standard wall materials.
- Other optional AMX mounting solutions include the MSA-MMK-xx Multi Mount Kit, the MSA-AMK-xx Any Mount Kit, and the CB-MXSA-xx Rough-In Box. Refer to the Quick Start Guide included with each mounting kit for instructions.

A Note About Wall and Rack Installation

Some products are installed in areas of differing temperature and cooling methodologies. These include products installed in walls, racks, cabinets, etc. Those areas may have different temperatures and/or cooling approaches that must be taken into consideration to maintain the product within the specified operating temperature.

FIG. 6 shows an AMX device installed in a wall with a filled volume (such as with insulation or concrete), as well as with a closed volume (such as between studs in an otherwise finished wall). The diagram shows how heat generated by the device or other devices may have no way to escape, and may build up to levels that may affect device operation.

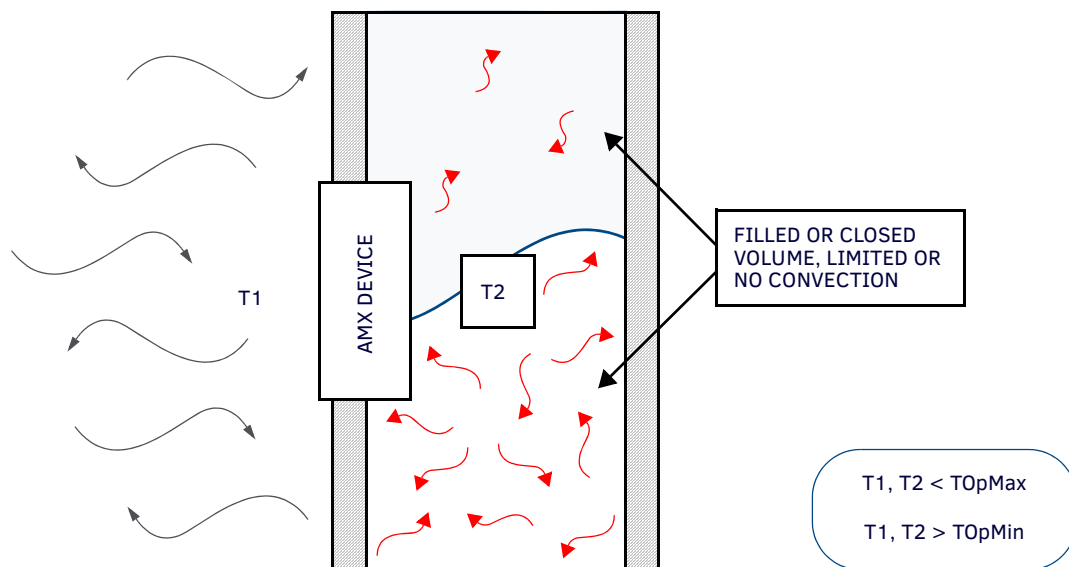

FIG. 6 Heat convection in filled or closed volume, limited or no convection

In FIG. 7, the diagram displays an AMX device in a typical rack mounting, with full air circulation around the front and back of the device. In this case, the main concern is with heat building up between components, possibly to levels that may affect device operation.

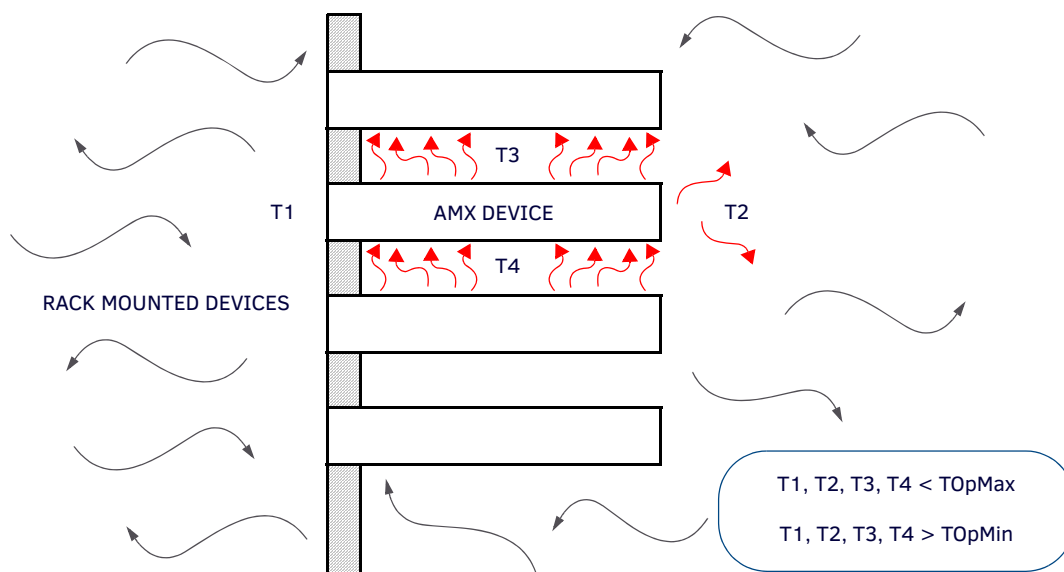

FIG. 7 Heat convection in rack-mounted devices

Installation Recommendations

During any installation, a lack of ventilation may produce conditions that may adversely affect the device's operation. In these circumstances, special care must be made to make sure that temperatures within enclosed areas do not exceed the device's maximum rated temperature.

NOTE: While the outside temperature of the device may be at or below its maximum operating temperature, special care must be taken before and during installation to ensure that the maximum operating temperature is not exceeded within wall or rack installation spaces.

Mounting Options

Acendo Book Scheduling Panels can be installed via several mounting options:

Use the included clear plastic Backbox to attach the panel to most standard wall materials.

Other optional AMX mounting solutions include the MSA-MMK2-07/10 Multi Mount Kits, and the MSA-AMK2-07/10 Any Mount Kits, and CB-MXSA-07/10 Rough-In Boxes. Refer to the Quick Start Guide included with each mounting kit for instructions.

Power Over Ethernet

Power for Acendo Book Scheduling Panels is supplied via Power Over Ethernet (PoE), utilizing an AMX-certified PoE injector such as the PS-POE-AF-TC PoE Injector (FG423-83). The incoming Ethernet cable should be connected to the RJ-45 port on the ACB-2110/2107.

Plastic Backbox

Acendo Book Scheduling Panels come with a clear plastic Backbox. This Backbox can be used to mount the touch panel into most standard wall materials. The Backbox can also be used to mount the panel into other mounting options.

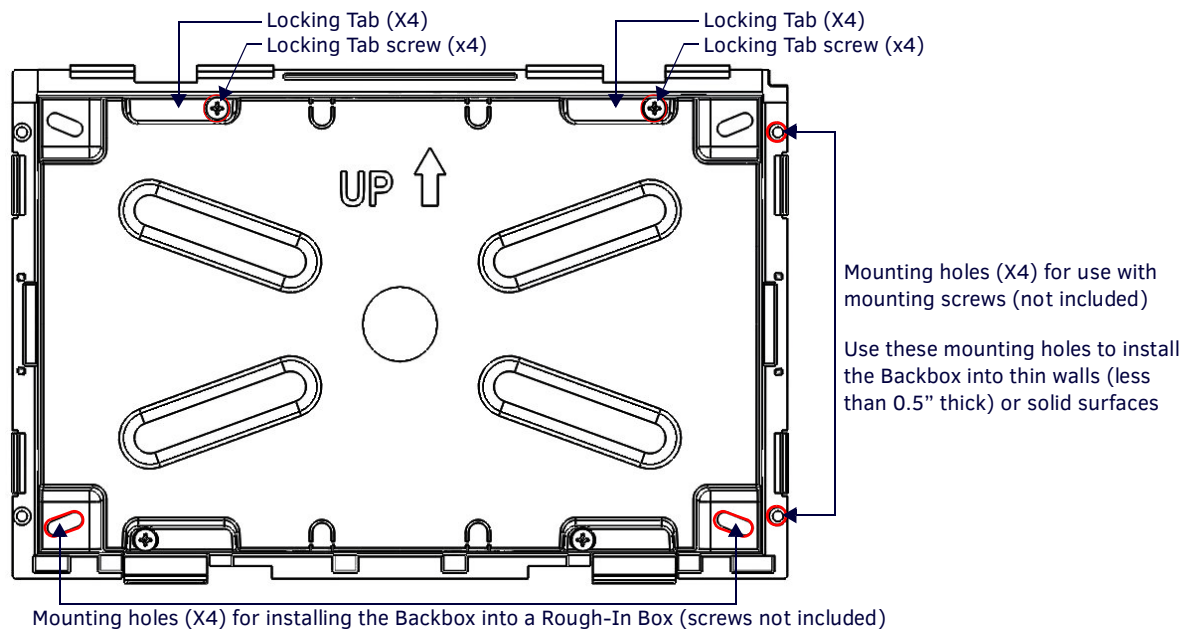

FIG. 8 ACB-2110 Backbox (Front View)

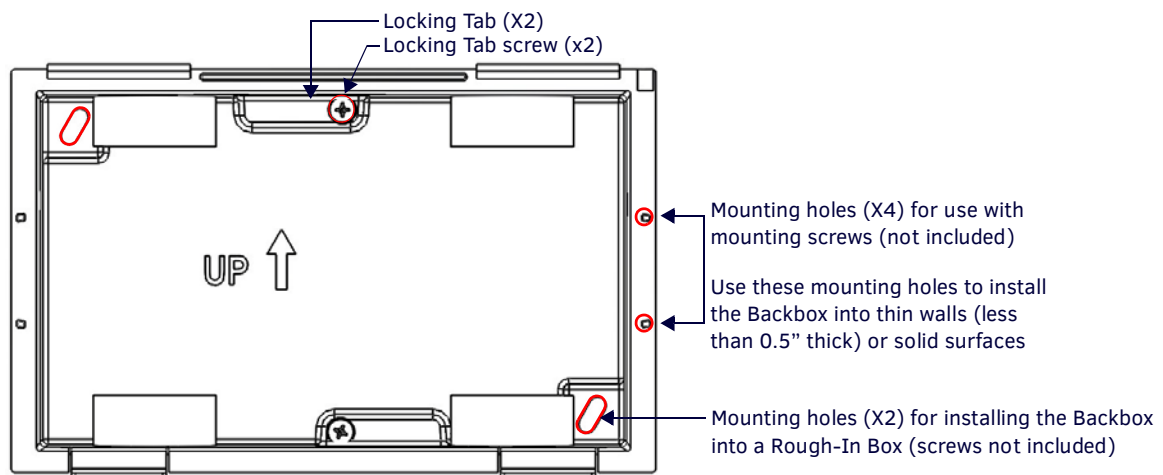

FIG. 9 ACB-2107 Backbox (Front View)

NOTE: For typical mounting surfaces, such as drywall, use the locking tabs as the primary method for securing the Backbox to the surface. For thin walls or solid surfaces, use mounting screws (not included).

STEP 1: Install the Plastic Backbox

Use the included Installation Template to determine the placement of the Backbox in the mounting surface. The outside edges of the template are the same dimensions as the touch panel, which allows you to troubleshoot possible conflicts with wall edges, doors, and other potential obstacles.

NOTE: Prepare the area by removing any screws or nails from the drywall before beginning the cutout process.

- **MXD-1001-L** - Template, Backbox, 10.1" Touch Panel, Modero S Series (**68-2265-03**)

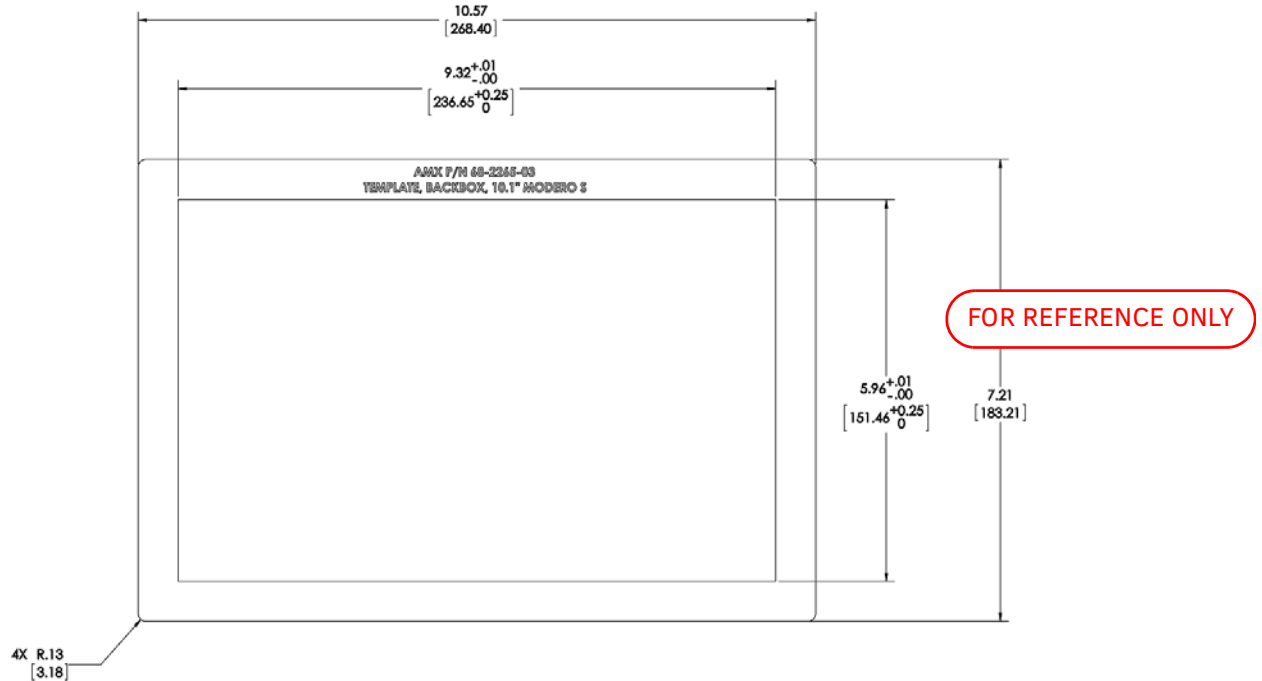

FIG. 10 S Series Installation Templates

- **MXD-701-L** - Template, Backbox, 7.0" Touch Panel, Modero S Series (**68-2265-02**)

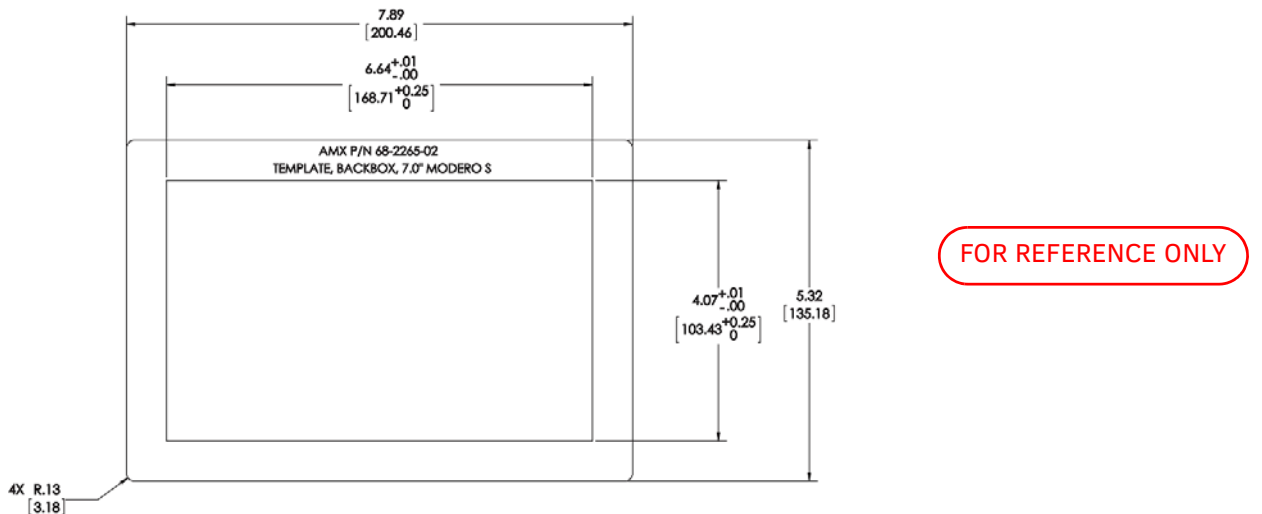

FIG. 11 S Series Installation Templates

The templates are marked to ensure that the touch panel and Backbox are properly aligned.

1. After ensuring proper placement, cut an opening in the mounting surface for the Backbox, using the included Installation Template as a guide.

NOTE: When installing the Backbox, make sure that the assembly is in the correct position and in the correct place. Once the locking tabs are extended and locked into place, removing the Backbox may be difficult without having access to the back of the wall or causing damage to the wall.

NOTE: Consider making the actual cutout opening slightly smaller than the provided dimensions. This provides a margin of error if the opening needs to be expanded. Too little wall material removed is always better than too much.

2. Thread the incoming cables (Ethernet and Micro-USB) from their terminal locations through the surface opening, leaving enough slack in the wiring to accommodate any re-positioning of the panel.
3. Remove the Backbox knockouts and thread incoming cables through the knockout holes.
4. Gently push the Backbox into the mounting surface.
 - This Backbox uses two Locking Tabs to secure the Backbox to the wall. For typical mounting surfaces, such as drywall, the locking tabs are the primary method for securing the Backbox to the wall.
 - To ensure a stable installation, the thickness of the wall material must be a minimum of .50 inches (1.27cm) and a maximum of .875 inches (2.22cm). The mounting surface should also be smooth and flat. For thin walls or solid surfaces, use mounting screws (not included) - see FIG. 8.
5. Extend the Locking Tabs by tightening the Locking Tab screws until snug.
 - FIG. 12 and FIG. 13 show the Locking Tabs on the ACB-2110 and ACB-2107 Backboxes:

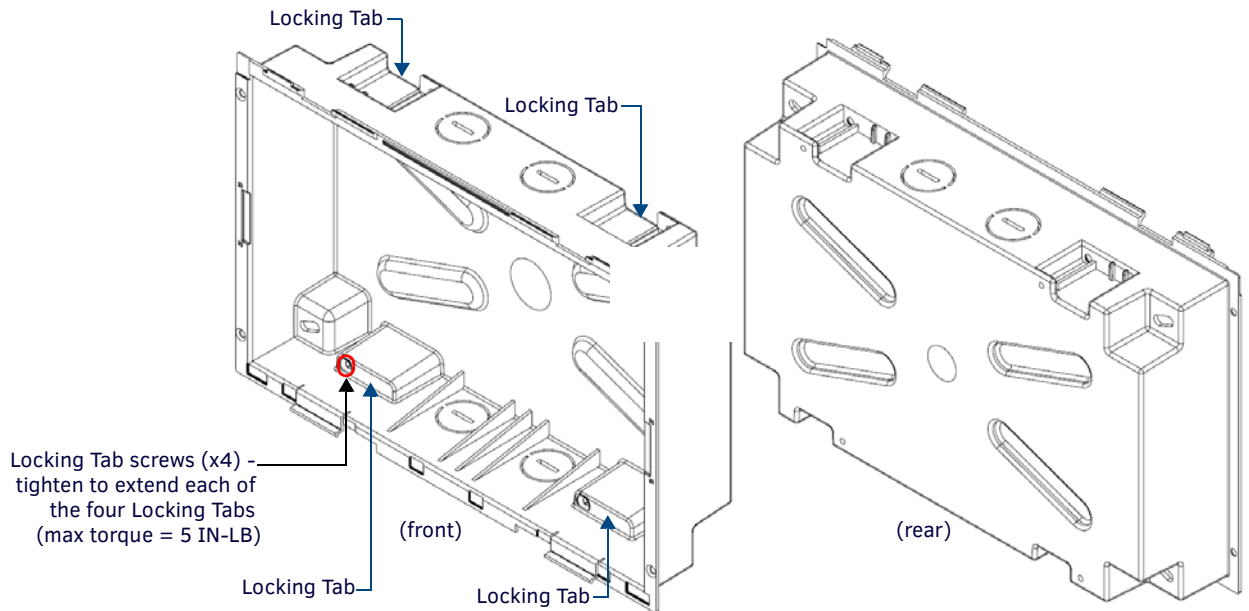

FIG. 12 ACB-2110 Backbox - Locking tab and locking tab screws (X4)

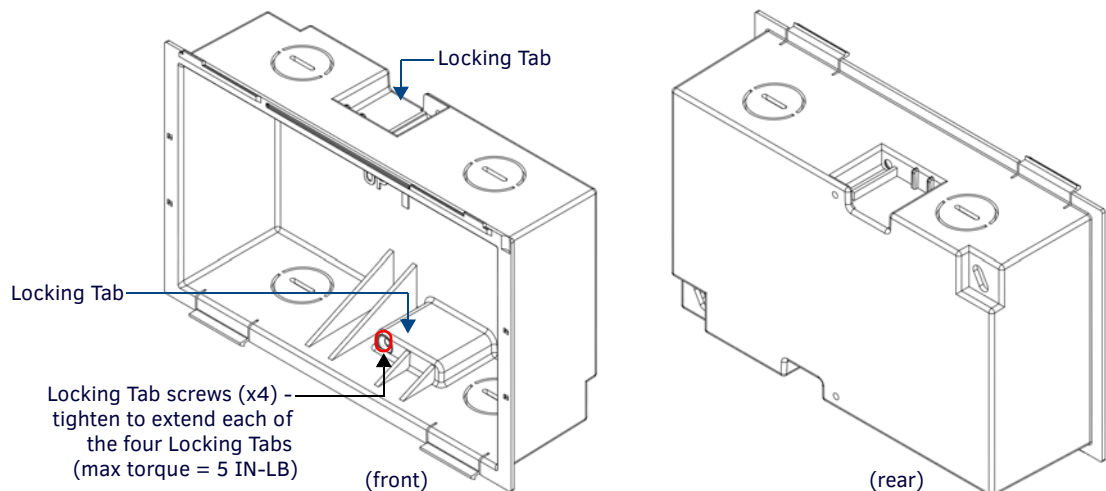

FIG. 13 ACB-2107 Backbox - Locking tab and locking tab screws (X2)

CAUTION: The maximum recommended torque to screw in the locking tabs on the plastic Backbox is 5 IN-LB [56 N-CM]. Excessive torque on the tab screws can strip out the locking tabs or damage the Backbox.

- Extend the Locking Tabs only AFTER the Backbox is inserted into the wall.
- When installing the Backbox, make sure that it is positioned correctly.
- The Backbox is clear to allow visual confirmation that the tabs have been extended and are gripping the wall, as well as in assisting with removal if necessary.

STEP 2: Insert Connectors on the Touch Panel

1. Before installing the touch panel into the Backbox, connect the Ethernet and USB cables to the rear of the panel.
2. Remove power at the terminal end before continuing with the installation.

NOTE: Do not disconnect the connectors from the touch panel. The panel must be installed with the connectors attached before being inserted into the mounting surface.

STEP 3: Secure the Touch Panel To the Backbox

The Backbox uses notches and tabs on the front edges (top and bottom) to secure the panel into place. Follow the steps below to install the panel into the Backbox, starting the upper edge of the touch panel:

UPPER TABS FIRST

1. Center the top edge of the touch panel against the upper outside edge of the Backbox and latch the top of the panel onto the Backbox top-hooks (FIG. 14):

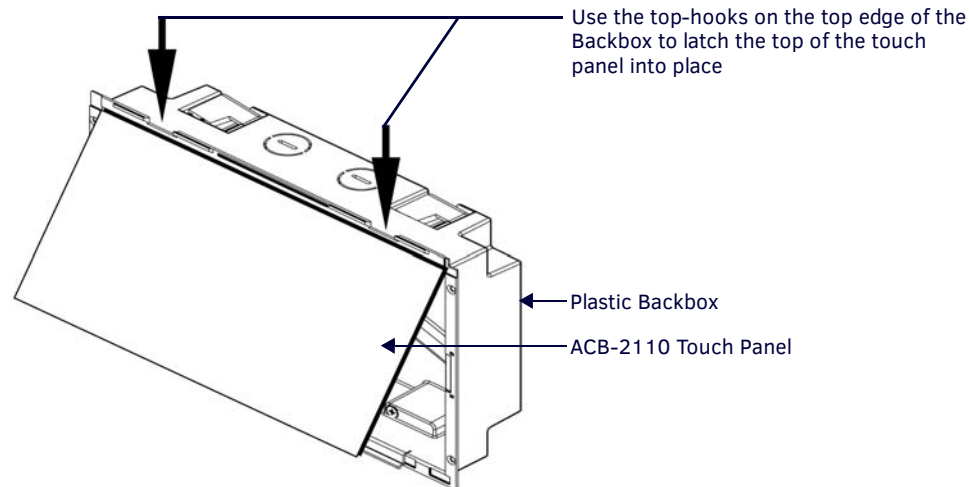

FIG. 14 Engaging the top edge of the panel with the top hooks on the Backbox

2. Gently press the top edge of the touch panel into place to engage the panel's notches and the top-hooks on the Backbox.

LOWER TABS - Gently Snap Into Place

1. Swing the bottom edge of the touch panel into position until it rests against the lower outside edge of the Backbox.

NOTE: If a gap is observed between the panel and the Backbox, or binding is felt while locking down the panel, stop and verify there are no cables in the way. Do not force the panel into position, or the touch screen or the panel electronics may be damaged.

2. Gently press the bottom edge of the panel gently but firmly and ONLY IN THE PLACES INDICATED BELOW until the tabs click into place to secure the panel (FIG. 15):

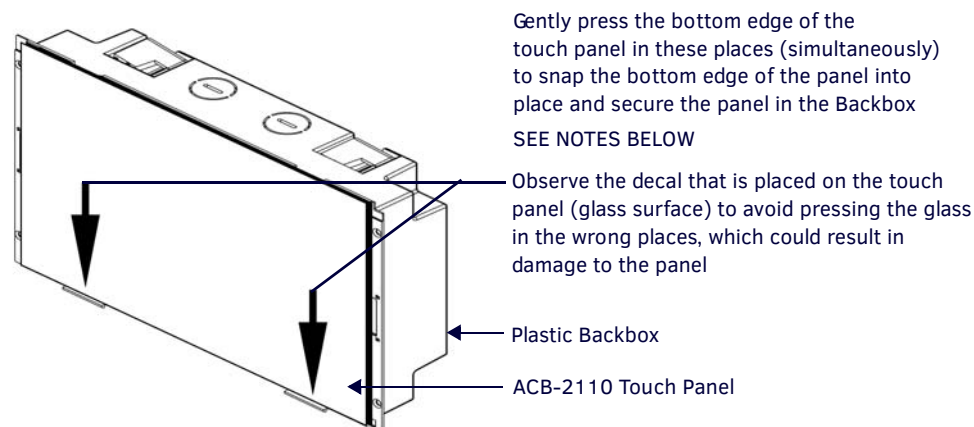

FIG. 15 SNAPPING THE BOTTOM EDGE OF THE PANEL INTO THE BACKBOX

3. Reconnect the terminal Ethernet and USB to their respective locations on either the Ethernet port.

Removing the ACB-2110/701 Panel from the Backbox

The tabs on the bottom edge of the Backbox lock down the ACB-2110 and must be unlatched in order to remove the touch panel from the Backbox. To do this, you'll need a thin probe such as an straightened paper clip, or the (optional) MXSA-REM-TL Bezel Removal Tool:

NOTE: The (optional) MXSA-REM-TL, Bezel Removal Tool (FG5968-99) provides a convenient method to release these clips. The Bezel Removal Tool makes it easy to locate the appropriate release points for each panel size. Refer to the MXSA-REM-TL Quick Start Guide for details.

1. With a thin probe, carefully press straight into the access holes on the bottom of the bezel (near the center of the bottom tabs) to disconnect the two bottom clips (FIG. 16, FIG. 17).

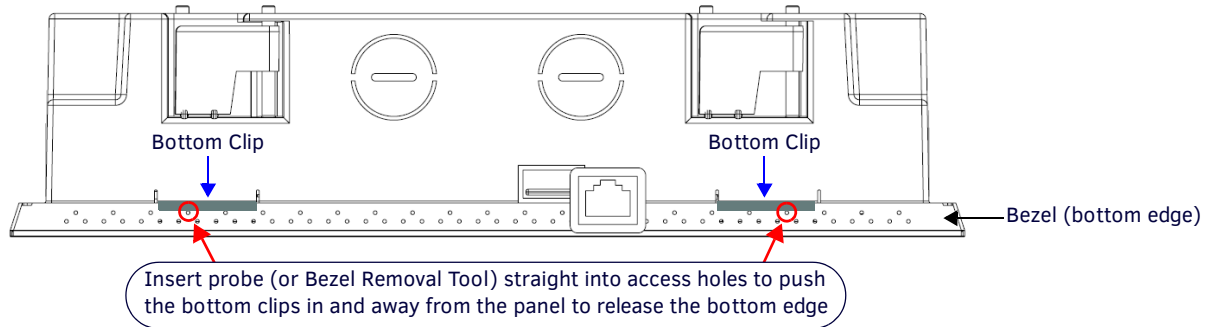

FIG. 16 ACB-2110/Backbox assembly

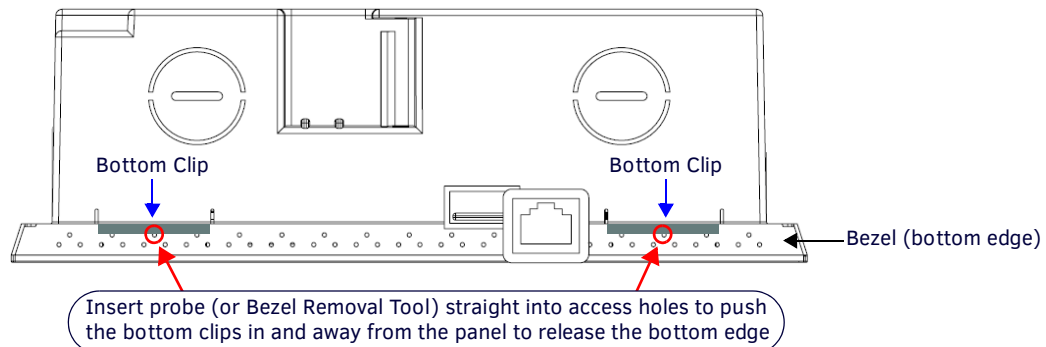

FIG. 17 ACB-2107/BACKBOX ASSEMBLY - BOTTOM VIEW

2. Grasp the bottom of the panel and pull gently outward until the side of the panel is free of the snap. Use your other hand to stabilize the front of the touch panel (FIG. 18):

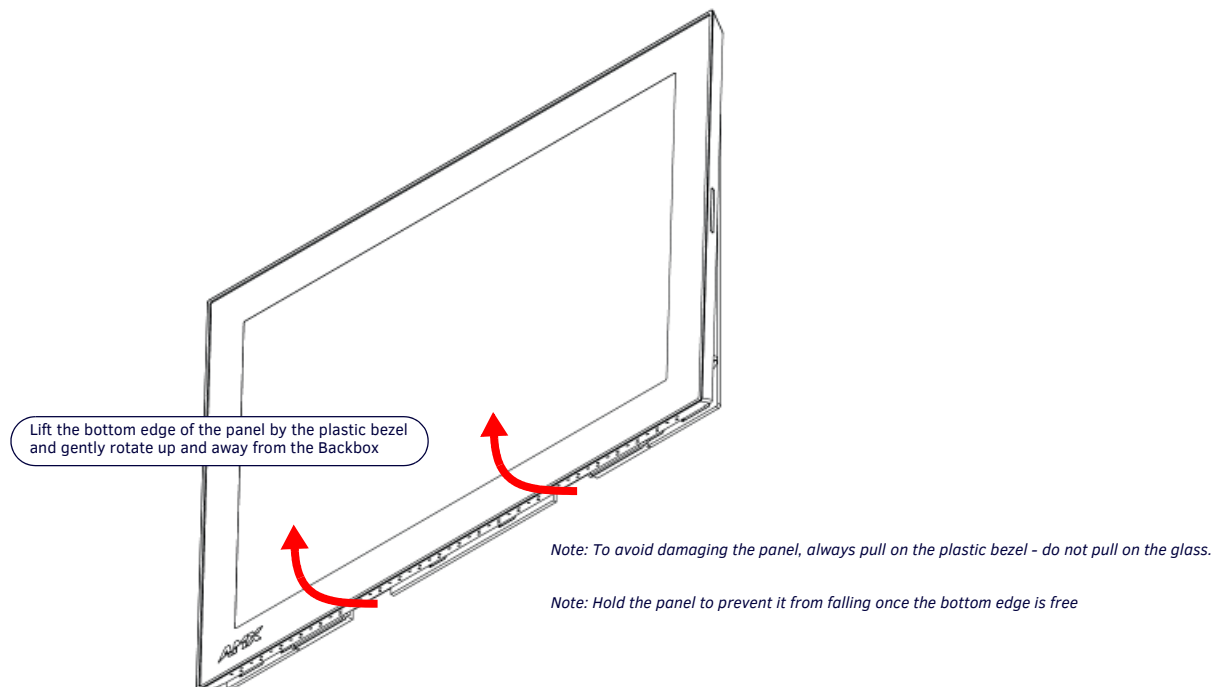

FIG. 18 ACB-2110/BACKBOX ASSEMBLY (RELEASING THE BOTTOM EDGE OF THE PANEL)

NOTE: Always pull on the frame of the touch panel. NEVER pull on the glass edge.

3. With the bottom edge of the panel free, carefully lift up and out to release the tabs on the top edge of the panel.

Installation Dimensions

ACB-2110 Dimensions

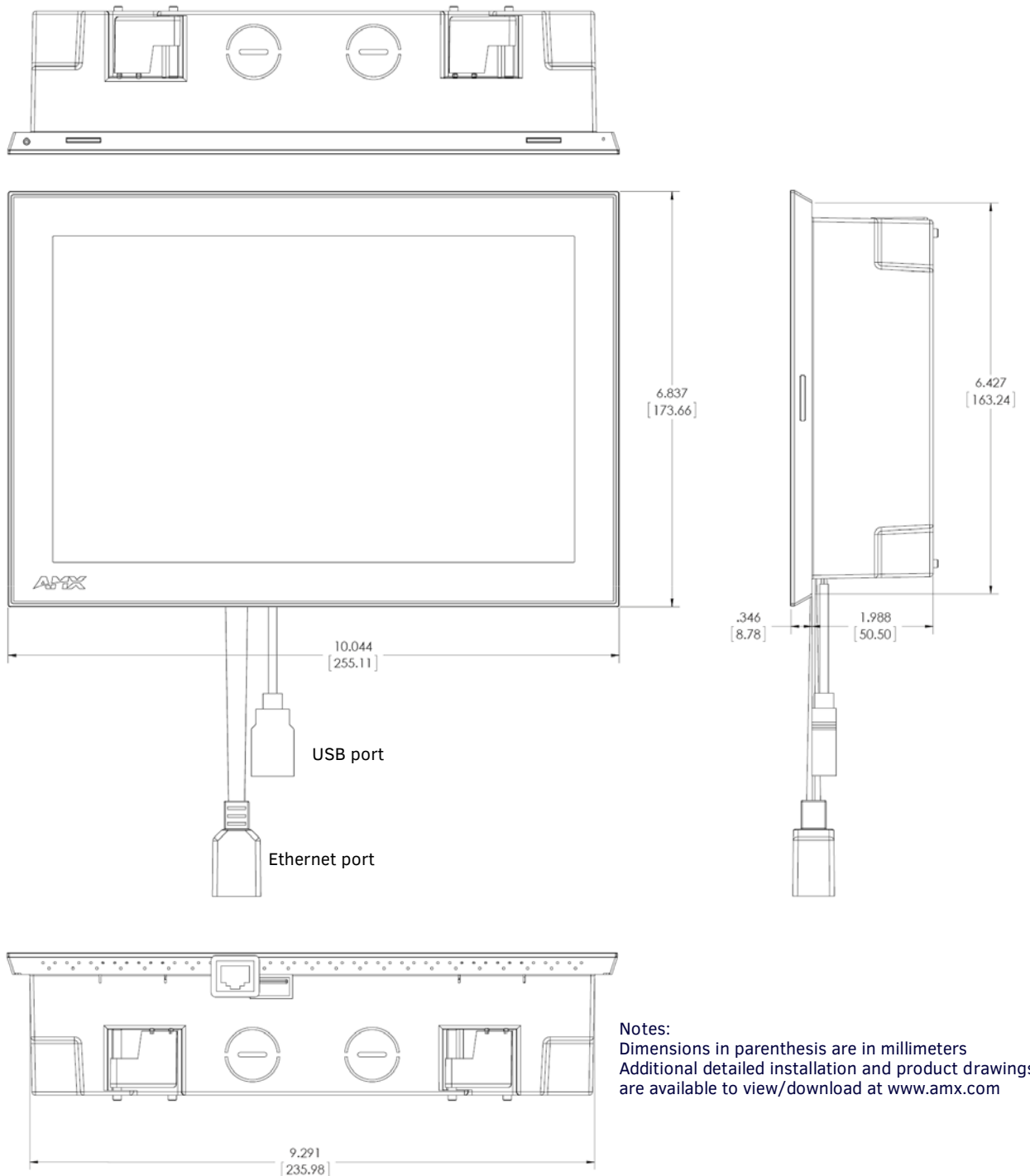

Notes:
 Dimensions in parenthesis are in millimeters
 Additional detailed installation and product drawings
 are available to view/download at www.amx.com

FIG. 19 ACB-2110

- Detailed specifications drawings for the [ACB-2110](http://www.amx.com) are available to download from www.amx.com.

ACB-2107 Dimensions

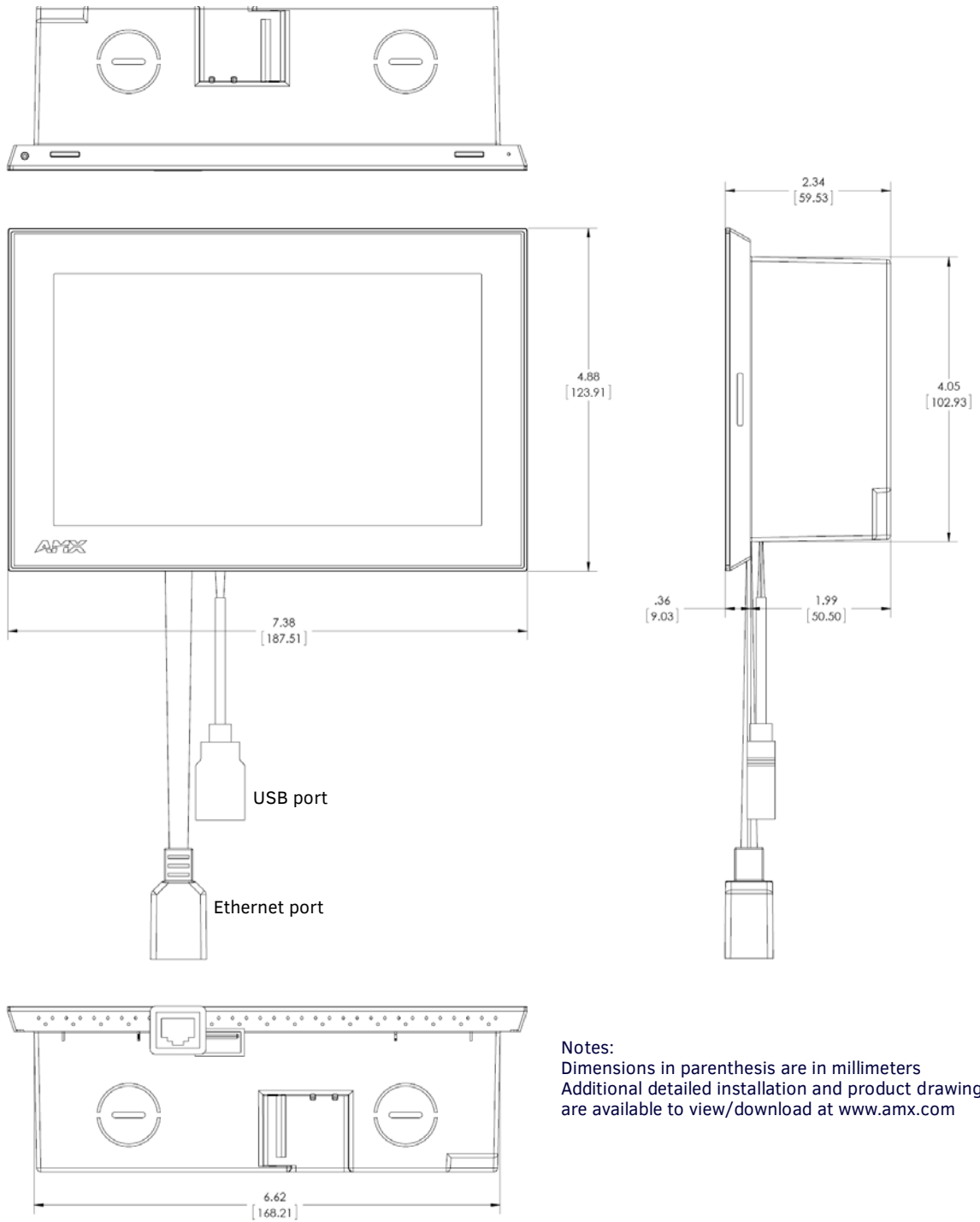

Notes:
 Dimensions in parenthesis are in millimeters
 Additional detailed installation and product drawings
 are available to view/download at www.amx.com

FIG. 20 ACB-2107

- Detailed specifications drawings for the ACB-2107 are available to download from www.amx.com.

Using the Scheduling Panel Setup Wizard

Overview

Acendo Book Scheduling Panels are easy to set up using the *Scheduling Panel Setup Wizard* - a one-time, panel-based configuration wizard to get the panels operational in a matter of minutes with minimal training. The Scheduling Panel Setup Wizard is automatically launched the first time the Acendo Book panel is powered on. This section describes each of the screens presented in the *Scheduling Panel Setup Wizard*.

NOTE: The *Scheduling Panel Setup Wizard* will be launched again if "Factory Data Reset" or "Reset Settings" is performed on the panel (via *Advanced Settings options*; see *SYSTEM - Reset and Update* on page 61 for details).

- Press the **Next** button in each Wizard page to save changes and proceed to the next page.
- Note that these settings can be changed later via the Settings pages (see the *Scheduler Settings* section on page 36 for details).

Setup Wizard: Step 1 - OVERVIEW

The *Overview* page presents a summary of the steps that entail the *Scheduling Panel Setup Wizard* (FIG. 21):



FIG. 21 Scheduling panel Setup Wizard - Overview page

Review this information and press **Next** to proceed (to the *Network* page).

Using the On-Screen Keyboard/Keypad

When each Setup Wizard page opens, the cursor is automatically placed in the first editable text field on the page and the on-screen keyboard or keypad is opened to allow editing of the active field. The example in FIG. 22 shows the NETWORK page with the cursor in the *Hostname* field (the first and only editable field in this example) and the on-screen keyboard displayed:

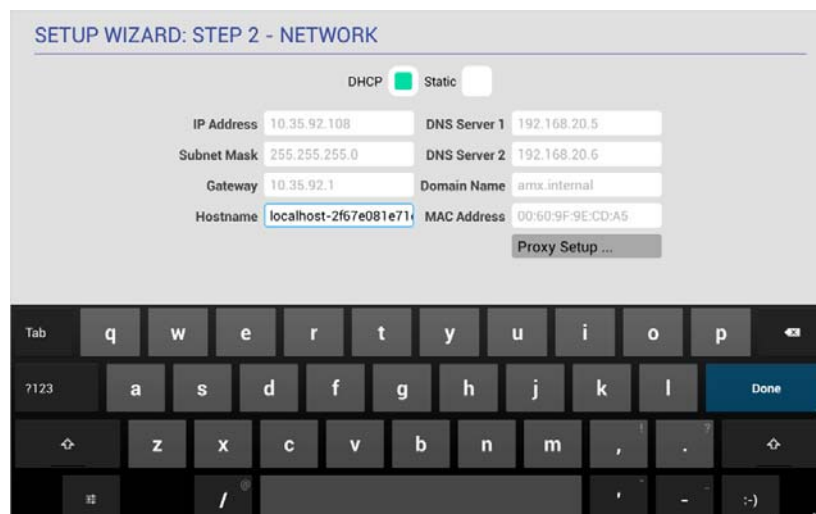

FIG. 22 On-Board Keyboard (Network page)

Note that if the selected field requires numeric entry, the on-screen keypad is opened instead. The example in FIG. 23 shows the cursor in the *IP Address* field, and the on-screen keypad displayed:

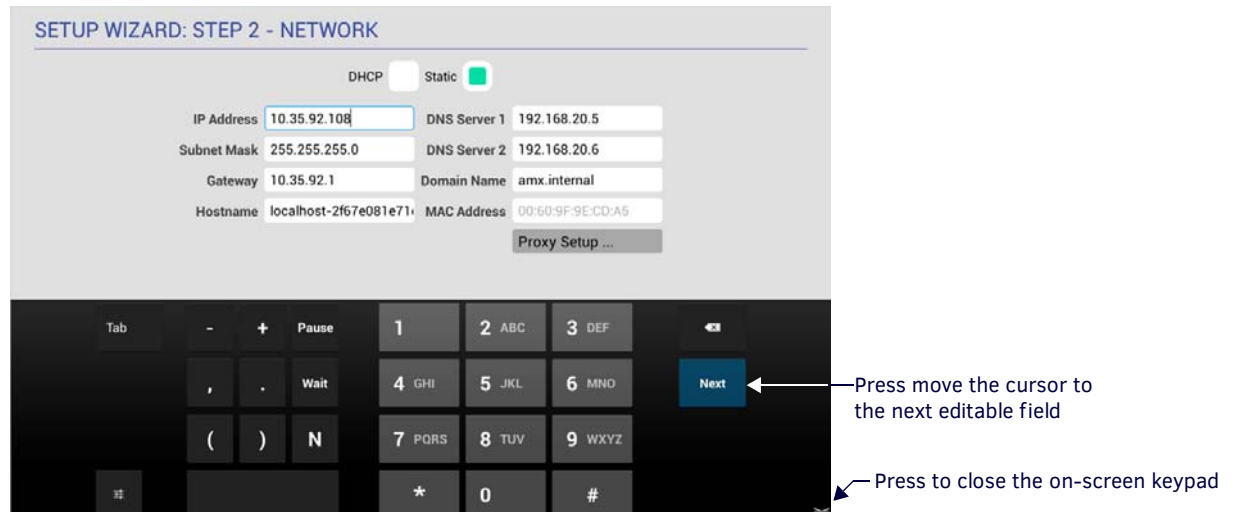

FIG. 23 On-Board Keypad (Network page)

Setup Wizard: Step 2 - NETWORK

Use the options in the *NETWORK* page to configure the scheduling panel's connection to the network (FIG. 24):



FIG. 24 Setup Wizard: Step 2 - NETWORK

Setup Wizard - NETWORK page options	
DHCP/Static	Select how to assign an IP Address to this panel: <ul style="list-style-type: none"> DHCP (default setting): Select this option to use DHCP to automatically assign an IP address to the panel. Note that when DHCP is selected, the other fields on this page are disabled. Static: Select to manually configure the IP address for this panel using the fields provided on this page.
IP Address	Enter a valid IP Address for this panel.
Subnet Mask	Enter a valid Subnet Mask address for this panel (as required).
Gateway	Enter a valid Gateway address for this panel (as required).
Hostname	Enter a valid Hostname for this panel (as required).
DNS Server 1	Enter a valid DNS Server #1 address for this panel (as required).
DNS Server 2	Enter a valid DNS Server #2 address for this panel (as required).
Domain Name	Enter a valid Domain Name for this panel (as required).
MAC Address	This read-only field provides the MAC Address associated with this panel.
Proxy Setup	Press to configure this scheduling panel to connect to a proxy server (only if necessary), via options in the Proxy Settings page. For information on Proxy Settings, refer to the <i>Proxy Setup</i> section on page 38.

Fill in these fields and press **Next** to proceed (press *Back* to return to the OVERVIEW page).

NOTE: These settings can be changed later if necessary, via the *NETWORK Settings* page (see *Viewing/Editing Network Settings* on page 37).

Setup Wizard: Step 3 - CALENDAR

Use the options in the *CALENDAR* page to configure the scheduling panel's connection to the scheduling system (FIG. 25):

FIG. 25 Setup Wizard: Step 3 - CALENDAR (Microsoft Exchange options shown)

Setup Wizard - CALENDAR page options	
Calendar Type Selection	Select the scheduling system that this panel will use: <ul style="list-style-type: none"> • Microsoft Exchange (see page 24) • Office 365 (see page 25) • Google Calendar (see page 26)
Verify	Press to verify that the scheduling panel can connect to the scheduling system using the information currently entered on this page. The system will indicate whether or not is able to connect to the calendar system using the current settings (see FIG. 27 on page 25). If the panel fails to connect, review all information entered on the Calendar page and try again. Note that the <i>Next</i> button remains disabled until the calendar settings have successfully been verified.

Calendar Types

Use the *Calendar Type Selection* options at the top of the *CALENDAR* page to specify the scheduling system that this panel will use. This selection will invoke configuration settings specific to the selected Calendar type, as described below:

Microsoft Exchange

To configure the Acendo Book Panel for use with Microsoft Exchange:

1. In the *Setup Wizard: Step 3 - Calendar* page, select **Microsoft Exchange** to invoke the following options (FIG. 26) :

FIG. 26 Microsoft Exchange Calendar Configuration Settings

Microsoft Exchange Calendar Configuration Settings	
Server URL	Enter the full URL for the scheduling server. Example syntax: https://<EXCHANGE_SERVER_HOSTNAME>/EWS/Exchange.asmx
Username	Enter the Username (including domain) required to login to the scheduling server (as required). Example: "JaneDoe@acme.onmicrosoft.com".
Password	Enter the Password required to login to the scheduling server (as required).
Calendar Email ID	Enter the Email ID (including domain) used by the scheduling service. Example: "ConfRoom1@acme.onmicrosoft.com"
Certificate Validation	<ul style="list-style-type: none"> Select Strict to include hostname validation and apply certain certificate requirements - see <i>SSL Validation Schemes</i> (below). Select None to disable validation schemes - see <i>SSL Validation Schemes</i> (below). Select Manage Certificates to open the <i>Security</i> (Advanced Settings) page (see FIG. 100 on page 57), which provides access to <i>Credential Storage</i> options, as described in the <i>Installing Certificates</i> section on page 60.

- Fill in these fields and press **Verify** to verify that the scheduling panel can connect to the scheduling system using the information currently entered on this page. The panel will indicate if the connection attempt was successful (FIG. 27):

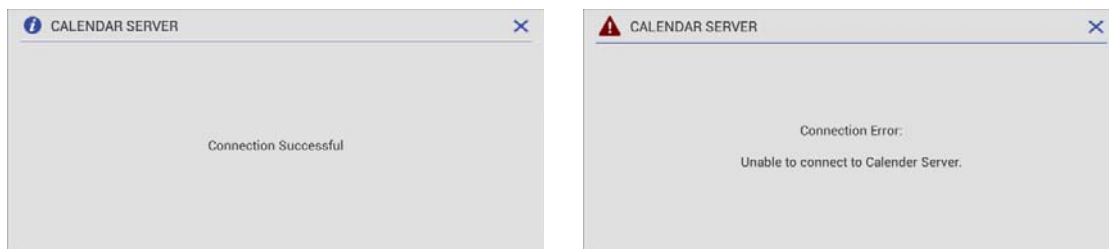

FIG. 27 CALENDAR SERVER (Verify) - Connection Successful/Connection Error

If the panel indicates that the connection attempt was unsuccessful, review all Calendar settings and retry.

- Press **Next** to proceed (press Back to return to the NETWORK page).

NOTE: For more information, see *Appendix B: Configuring Acendo Book Panels for Microsoft Exchange & Office 365* on page 78.

SSL Validation Schemes

Strict	None
Includes hostname validation	no hostname validation
do not allow "certificate has expired"	allows "certificate has expired"
do not allow "root certificate to be untrusted/self-signed"	allows "root certificate to be untrusted/self-signed"
do not allow "certificate signature is invalid"	allows "certificate signature is invalid"

Office 365

To configure the Acendo Book Panel for use with Office 365:

- In the *Setup Wizard: Step 3 - Calendar* page, select **Office 365** (FIG. 28) to invoke the following configuration settings:

FIG. 28 Office 365 Calendar Configuration Settings

Office 365 Calendar Configuration Settings	
Username	Enter the Username (including domain) required to login to the scheduling server (as required). Example: "JaneDoe@acme.onmicrosoft.com".
Password	Enter the Password required to login to the scheduling server (as required).
Calendar Email ID	Enter the Email ID (including domain) used by the scheduling service. Example: "ConfRoom1@acme.onmicrosoft.com"

Office 365 Calendar Configuration Settings (Cont.)

Certificate Validation	<ul style="list-style-type: none"> Select Strict to include hostname validation and apply certain certificate requirements - see <i>SSL Validation Schemes</i> (below). Select None to disable validation schemes - see <i>SSL Validation Schemes</i> section on page 25. Select Manage Certificates to open the <i>Security (Advanced Settings)</i> page (see FIG. 100 on page 57), which provides access to <i>Credential Storage</i> options, as described in the <i>Installing Certificates</i> section on page 60.
------------------------	---

- Fill in these fields and press **Verify** to verify that the scheduling panel can connect to the scheduling system using the information currently entered on this page.
- Press **Next** to proceed (press *Back* to return to the NETWORK page).

NOTE: For more information, see *Appendix B: Configuring Acendo Book Panels for Microsoft Exchange & Office 365* on page 78.

Google Calendar

To use Google calendar with Acendo Book, a Google *Services* account must be available. Refer to the *Appendix D: Configuring Google Resources* on page 82 for details.

To configure the Acendo Book Panel for use with Google calendar:

- In the *Setup Wizard: Step 3 - Calendar* page, Select **Google Calendar** (FIG. 29) to invoke the **Add** option:



FIG. 29 Google Calendar Configuration Settings

- Press **Add** to invoke the Google sign-in page (FIG. 30):

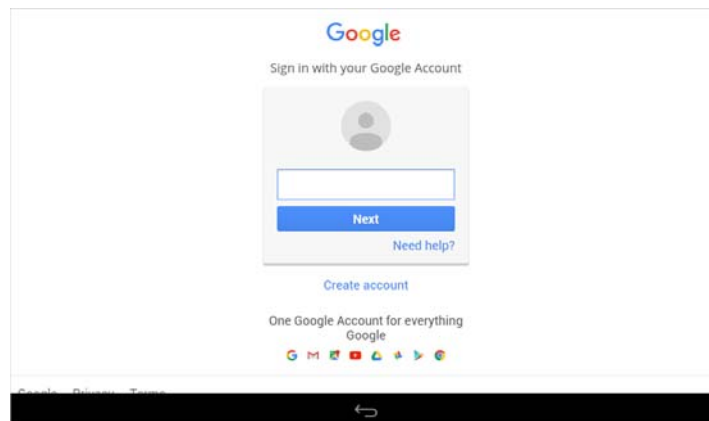

FIG. 30 Google Sign-In Page

- In the Google Sign-In Page, enter your Google Service account login information and press **Next**.
- When prompted to allow Acendo Book to manage your calendars, review the terms described, and press **Allow** to proceed (FIG. 31):

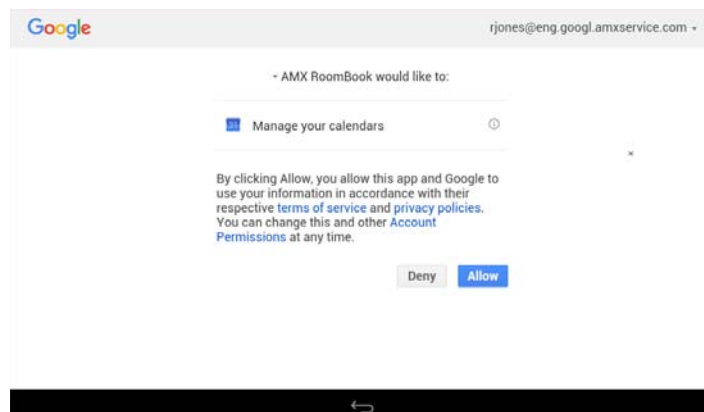

FIG. 31 Allow Acendo Book to manage Google calendars

- The SELECT CALENDAR window presents a listing of all Acendo Book panel-equipped rooms that are associated with Google calendar. Press to select a Calendar/Room to use as the source of scheduling information for this panel (FIG. 32):

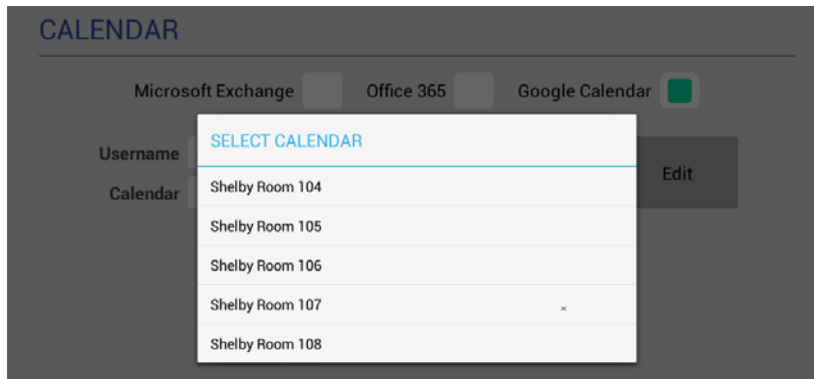

FIG. 32 SELECT CALENDAR Window indicating a sample list of Calendars/Rooms

- This selection closes the SELECT CALENDAR window, and displays an updated CALENDAR page, indicating the current Google Username and the Calendar/Room associated with this panel (FIG. 33):

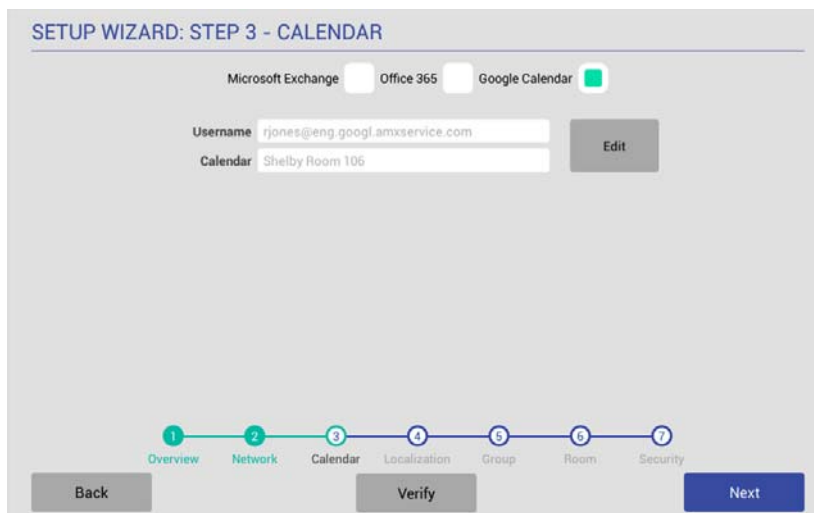

FIG. 33 CALENDAR Page indicating Google Username and selected Calendar

- Fill in these fields and press **Verify** to verify that the scheduling panel can connect to the scheduling system using the information currently entered on this page.
- Press **Next** to proceed (press **Back** to return to the NETWORK page).

NOTE: These settings can be changed later if necessary, via the CALENDAR Settings page (see Viewing/Editing Calendar Settings on page 39).

Setup Wizard: Step 4 - LOCALIZATION

Use the options in the *LOCALIZATION* pages to select a language and time zone to be displayed on this panel (FIG. 34):

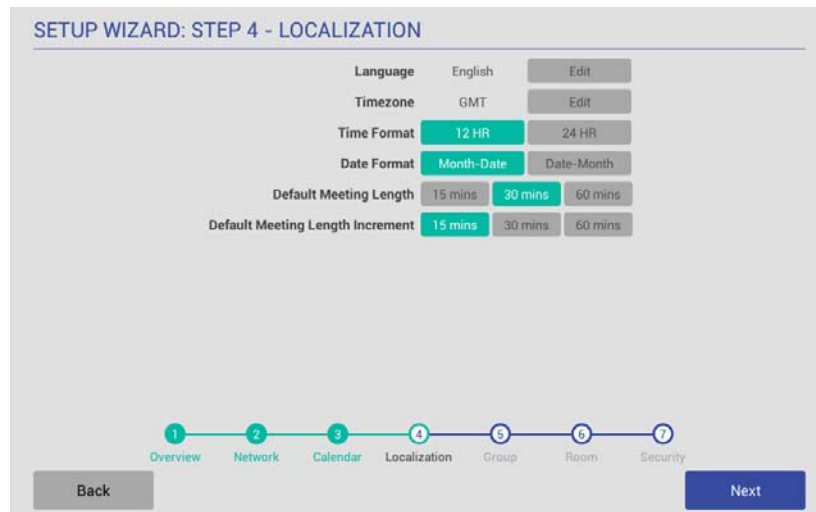

FIG. 34 Setup Wizard: Step 4 - LOCALIZATION

Setup Wizard - LOCALIZATION page options	
Language	Indicates the current language setting for this panel (default = <i>English</i>). To change languages, press the <i>Language Edit</i> button. This invokes the SELECT LANGUAGE window (see FIG. 35). Press to select a language.
Time Zone	Indicates the current time zone setting for this panel (default = <i>GMT</i>). To change the time zone setting, press the <i>Time Zone Edit</i> button. This invokes the SELECT TIME ZONE window (see FIG. 35). Press to select the appropriate time zone.
Time Format	Indicates the current time display setting for this panel (default = <i>12-hour</i>). To change the time display to 24-hour format, press the 24-hour button.
Date Format	Indicates the current date display setting for this panel (default = <i>Month-Date</i>). To change the date display to Month-Date format, press the Month-Date button.
Default Meeting Length	This setting specifies how many times each hour this panel can indicate separate meetings. The default setting is <i>15 minutes</i> , in which case this panel can schedule up to 4 meetings in an hour. To change the default meeting increment setting, press either the 30 mins or 60 mins button. <ul style="list-style-type: none"> • With <i>30 mins</i> selected, this panel can schedule a meeting every 30 minutes. • With <i>60 mins</i> selected, this panel can schedule a meeting every 60 minutes.
Default Meeting Increment	Indicates the current default meeting length setting for this panel (default = <i>30 minutes</i>). To change the default meeting length setting, press either the 15 mins or 60 mins button.

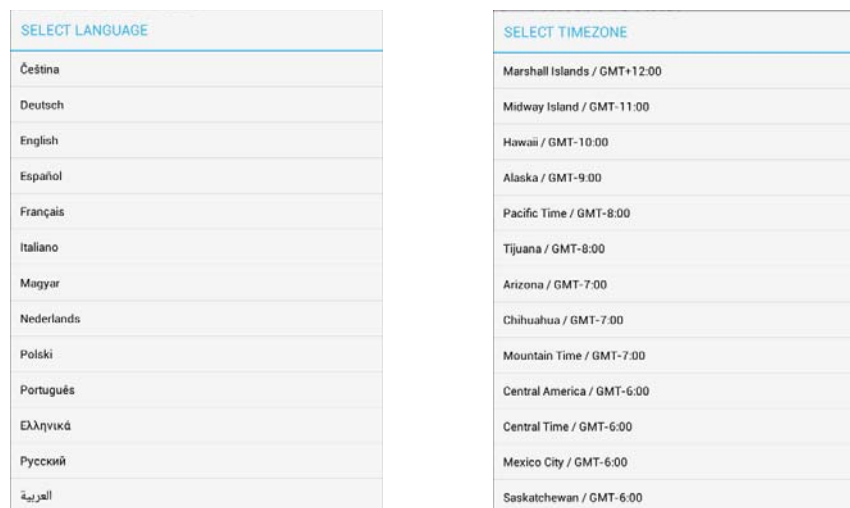

FIG. 35 SELECT LANGUAGE and SELECT TIMEZONE dialogs

Fill in these fields and press **Next** to proceed (press *Back* to return to the CALENDAR page).

NOTE: These settings can be changed later if necessary, via the *LOCALIZATION Settings* page (see *Viewing/Editing Localization Settings* on page 39).

Setup Wizard: Step 5 - GROUP

Acendo Book touch panels can be configured either as a *Master* or a *Member* of a Scheduling Panel *Group*. Members of a Group communicate with the Master panel, which enables panels to browse the schedules of all Member panels in the same Group. This provides users with the ability to schedule a meeting in any room included in the Scheduling Panel Group, from any panel in the Group. For example, when a room is occupied, users can browse other rooms and schedule a meeting in any of the rooms in the Group.

Use the options in the *GROUP* page to configure this panel as either the Master, or a Member of a Scheduling Panel Group. Note that there can be only one Master panel for a Group. If there is only one stand-alone Acendo Book panel, then it must be configured as a Master.

NOTE: All Acendo Book scheduling panels in a Group must have firmware version 1.1.x or higher. Scheduling panels running version 1.0.x will not show availability information correctly; a room listed in the Available Rooms page (after pressing *Browse Rooms*) will be listed as "NOT AVAILABLE".

NOTE: Up to 49 Acendo Book panels can be configured as Members of a Master panel's Group (for a total of 50 panels including the Master). However, note that when configuring Scheduling Groups, smaller Room Groups typically have quicker responsiveness for "Browse Rooms" requests.

Note that when this page is opened, *Master* is selected by default. Therefore the configuration options presented are specific to configuring this panel as a Master (FIG. 36):

FIG. 36 Setup Wizard: Step 5 - GROUP page

Press the *Info* icon next to Master and Member buttons to open the *GROUP MASTER/MEMBER* window, which provides a summary of how scheduling panels relate to Groups (FIG. 37):

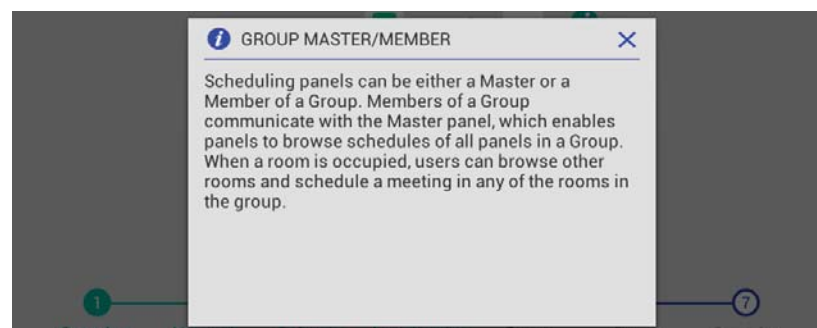

FIG. 37 Group page (GROUP MASTER/MEMBER Information window)

Setup Wizard - GROUP page options	
Master/Member	Specify to use this panel either as a Master panel, or as a member of a Scheduling Panel Group (default = <i>Master</i>).
Master Configuration	With <i>Master</i> selected, the following Master Configuration options are presented:
Master IP/Hostname	This read-only field displays the Master IP/Hostname currently assigned to this panel.
Username	Enter a Username to associate with this panel (required for Master panels).
Password	Enter a Password to associate with this panel (required for Master panels).

Setup Wizard - GROUP page options	
Clear Members	Press to clear any and all members of the Group with which this Master panel is associated.

Member Configuration	With <i>Member</i> selected, the following Member Configuration options are presented:
Master IP/Hostname	Enter the Master IP/Hostname of the Master panel for the Group to which this Member panel belongs.
Username	Enter the Username associated with the Master panel for this panel's Group.
Password	Enter the Passwords associated with the Master panel for this panel's Group.

Creating a Scheduling Group

Creating a Group entails configuring one Acendo Book panel to be the *Master* panel, and configuring other panels to be *Member* panels:

Configuring the Master Panel

Only one Acendo Book panel can be assigned as the Master panel. If there only one Acendo Book panel, then it must be configured as the Master (see FIG. 36 on page 29).

1. In the *Setup Wizard: Step 5 - GROUP* page, select **Master**.
2. Enter a *Username* and *Password* for this panel. These credentials will be required for the Member panels to communicate with the Master panel.
3. Press **Next** to proceed to the ROOM page.

Configuring Member Panels

Once an Acendo Book panel has been configured as the Master panel, up to 49 Acendo Book panels can be configured as Members of the Master panel's Group:

FIG. 38 Setup Wizard: Step 5 - GROUP page (Member Settings)

1. In the *Setup Wizard: Step 5 - GROUP* page, select **Member**.
2. Enter the IP or Hostname of the Master panel.
3. Enter the *Username* and *Password* for the Master panel.
4. Press **Next** to proceed to the ROOM page.

Once a Group has been configured, users can browse other Acendo Book panels in the Group for availability, and reserve a meeting on any available panel in the Group. See the *Browse Rooms for Scheduling* section on page 69 for details.

NOTE: *These settings can be changed later if necessary, via the GROUP Settings page (see Viewing/Editing Group Settings on page 41).*

Setup Wizard: Step 6 - ROOM

Use the options in the *ROOM* pages to set room-level options for this panel (FIG. 39):

FIG. 39 Setup Wizard: Step 6 - ROOM page

Setup Wizard - ROOM page options	
Room Name	Enter the room name as it will appear on this panel.
Default Meeting Subject	Enter a default meeting subject to be displayed on this panel. Note that this default subject can be over-written in the Room page (see the <i>Editing Meeting Details</i> section on page 71).
Support Contact Name	Enter the name of the support personnel as it will appear on this panel.
Support Contact Phone	Enter the phone number of the support personnel as it will appear on this panel.
Room Status LED	Press to toggle the Room Status LEDs on the panel, which light green when the Room is available, or red when the Room is occupied (default = <i>enabled</i>).
Logo Image	Indicates the current logo image, if applicable. Press Add to add a custom logo image. <ul style="list-style-type: none"> Supported Formats: JPG, PNG The custom logo image window is 375 x 165. Acendo Book Panels will take the downloaded image and scale it down to fit in the window. However, to maximize the available space, the downloaded logo should have a similar aspect ratio (~2.2).

Fill in these fields and press **Next** to proceed (press *Back* to return to the GROUP page).

NOTE: These settings can be changed later if necessary, via the *ROOM Settings* page (see *Viewing/Editing Room Settings* on page 42).

Changing the Logo Image

The Main Room page on each scheduling panel includes a graphic window for a logo. The logo image can be changed via the *Logo Image* option in the Room page:

- In the *Setup Wizard: Step 6 - ROOM* page, select **Add**.
- In the LOGO IMAGE WINDOW, enter a URL to an image file and press **Upload** to upload the selected file to the panel.

The LOGO IMAGE PREVIEW window provides a preview of the selected image (FIG. 40):

FIG. 40 Setup Wizard: Step 6 - Room page (LOGO IMAGE PREVIEW window showing an example logo image)

NOTE: The custom logo image window is 375 x 165 (pixels). Acendo Book Panels will automatically scale the uploaded image down to fit in the window. For best results the downloaded logo should be at least 375 x 165 pixels and have a similar aspect ratio (~2.2).

Press **Preview** to preview the specified image. The LOGO IMAGE window provides a preview of the selected logo, as it will appear on both the Available (green) and Occupied (red) backgrounds (FIG. 41):

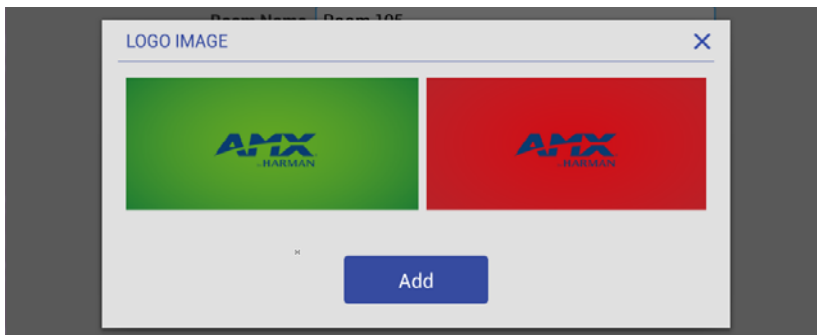

FIG. 41 Setup Wizard: Step 6 - Room page (LOGO IMAGE PREVIEW window showing an example logo image)

3. Press **Add** to upload the specified image.

Note that if the image file fails to load, the panel will prompt you to verify that the image URL is correct (FIG. 42):



FIG. 42 Setup Wizard: Step 6 - Room page (LOGO IMAGE PREVIEW window showing an example logo image)

In this case, verify the URL and try again.

When an image is successfully uploaded, it is displayed next to *Logo Image* (FIG. 44):

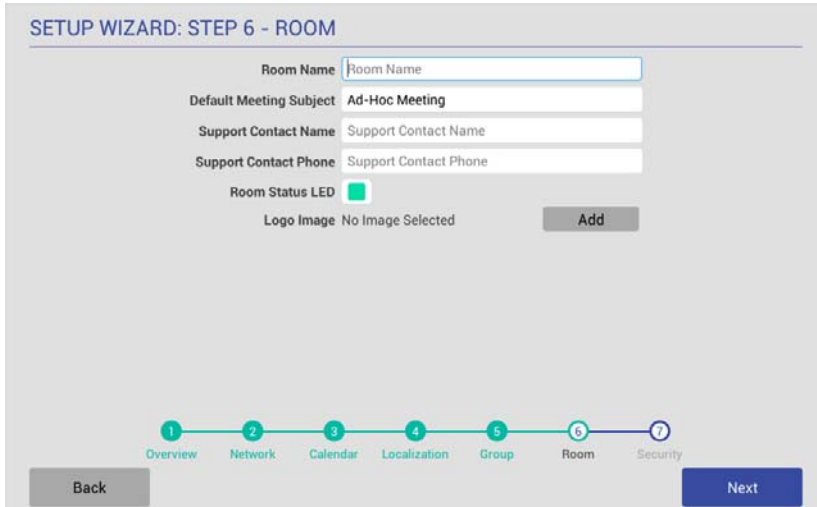

FIG. 43 Setup Wizard: Step 7 - ROOM page (indicating an uploaded Logo Image)

Once a logo image has been uploaded, a Delete button is provided on this page. Press **Delete** to delete the current custom logo image.

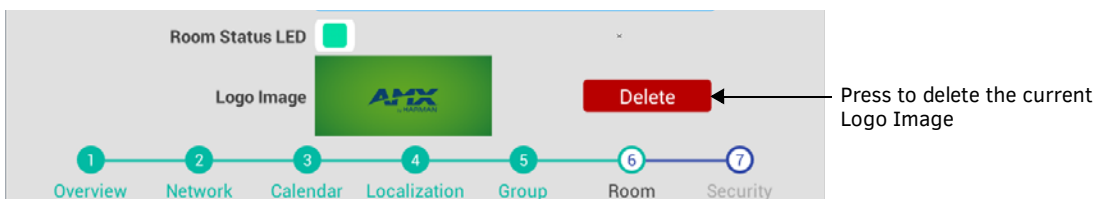

FIG. 44 Setup Wizard: Step 7 - ROOM page (indicating an uploaded Logo Image)

Setup Wizard: Step 7 - SECURITY

Use the options in the *SECURITY* page to configure the security settings for this panel (FIG. 45):

SETUP WIZARD: STEP 7 - SECURITY

Administrator Password: 1988

Require Meeting PIN Code:

Read Only Mode:

Privacy Mode:

Private Meeting Subject: Private Meeting

Progress bar: 1 Overview, 2 Network, 3 Calendar, 4 Localization, 5 Group, 6 Room, 7 Security

Buttons: Back, Finish

Press to close the Scheduling Panel Setup Wizard

FIG. 45 Setup Wizard: Step 7 - SECURITY page

Setup Wizard - SECURITY page options	
Administrator Password	Press to change the Administrator password that is required to access Scheduler Settings, and Advanced (touch panel) Settings on this panel (default = 1988).
Require Meeting PIN Code	When enabled, the PIN code will be required to reserve a meeting, edit Meeting Time/Details and Delete Meeting. Press to enable this option (default = disabled).
Meeting PIN Code	Enter the 4-digit PIN code that will be required to reserve, edit or delete a meeting on this panel, only if the <i>Require Meeting PIN Code</i> option (above) is enabled.
Read Only Mode	Press to toggle this option (default = disabled). When enabled, all fields on the Room page are displayed, but are read-only. In this case, users will be able to see all meetings and reservation details, but will not be allowed to reserve, edit or delete meetings on this panel.
Privacy Mode	Press to toggle this option (default = disabled). When in Privacy Mode, information considered to be private is hidden and immutable on this panel. See the <i>Privacy Mode</i> section on page 34 for details. <i>Note: If a meeting is booked outside of an Acendo Book panel (i.e. directly via the scheduling system software), then the subject line of the meeting will be replaced with the Private Meeting Subject text (default = "Private Meeting"). The default Private Meeting Subject text can be edited if desired (see page 34).</i>
Private Meeting Subject	Press to enter the text that will be used as the meeting subject displayed for private meetings. The text entered here provides the meeting subject for all types of private meetings: <ul style="list-style-type: none"> It will be used when <i>Privacy Mode</i> is enabled on the Acendo Book panel. Will be used when a meeting is marked as <i>Private</i> by the calendar server (Exchange/Office 365/Google).
Finish	Press to exit the Setup Wizard (see <i>Exiting the Scheduling Panel Setup Wizard</i> on page 35).

Changing the Administrator Password on the Panel

The Administrator password is required to access the Acendo Book panel's SCHEDULER SETTINGS and ADVANCED SETTINGS pages. The default Administrator password is **1988**. It is recommended to change this password:

1. Press the **Administrator Password** text field in the SECURITY page to invoke an on-screen keyboard.
2. Enter the new password and press **Done**.

Setting a Meeting PIN Code

The Meeting PIN Code is a 4-digit PIN code that will be required in order to reserve a meeting, edit meeting details or delete a meeting on this panel, only if the *Require Meeting PIN Code* option is enabled (FIG. 46):

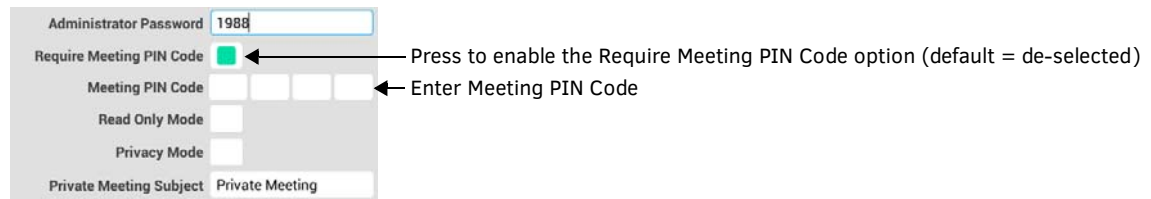

FIG. 46 Security page - Require Meeting PIN Code selected and Meeting PIN Code entry field enabled

To set a Meeting PIN Code:

1. Press the **Meeting PIN Code** field in the SECURITY page to invoke an on-screen keypad.
2. Enter the new 4-digit PIN.
3. The keypad automatically closes when 4 digits are entered.

Privacy Mode

When the Acendo Book panel is in *Privacy Mode*, information considered to be private is hidden (and immutable) on the Acendo Book panel's interface.

Privacy Mode: Meetings Scheduled from an Acendo Book Panel

- When a booking is made, the user cannot define meeting details (subject, message body).
- After reservation is made, meeting is displayed on the Acendo Book Panel with Default Meeting Subject (defined in Room Settings Page).
- If the meeting is selected, no organizer or details are shown and the user is unable to edit the meeting details.

Privacy Mode: Meetings Scheduled from Mail/Web Client

If a meeting is booked directly via the scheduling system software, then the subject line of the meeting will be replaced with the Private Meeting Subject text (default = "Private Meeting").

- Meeting subject is replaced with the *Default Private Meeting Subject* text, as defined in the SECURITY page (see *Editing the Private Meeting Subject Message Text* below).
- If the meeting is selected, no organizer or details are shown.

NOTE: *Acendo Book panels use Exchange, Office 365 or Google "privacy" flag. A meeting marked as private will behave the same way the global Acendo Book "Privacy Mode" behaves. In order for the Acendo Book panel to be able to read the privacy mode flag in Exchange and Office 365, the Exchange server must set the room's "-RemovePrivateProperty" to \$false. By default, this is set to \$true.*

Editing the Private Meeting Subject Message Text

1. Press inside the **Privacy Mode** field to edit the **Private Meeting Subject** message text.
2. Press **Done** to save changes and close the on-screen keyboard.

NOTE: *These settings can be changed later if necessary, via the SECURITY Settings page (see *Viewing/Editing Security Settings* on page 42).*

Exiting the Scheduling Panel Setup Wizard

Press the **Finish** button on the *Setup Wizard: Step 7 - Security* page to close the Scheduling Panel Setup Wizard (FIG. 47):



FIG. 47 Setup Wizard: Step 7 - SECURITY page

When the SETUP WIZARD is closed, the Room page for this panel is displayed (FIG. 48):

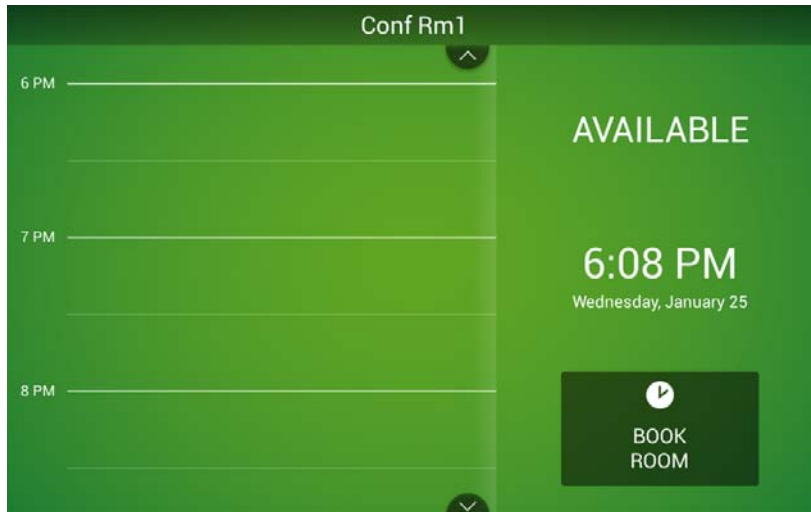

FIG. 48 Example Room Available page (Meeting room)

- Note that the settings made in the *Scheduling Panel Setup Wizard* can be changed via the Scheduler Settings pages. Refer to the *Scheduler Settings* section on page 36 for details.
- For information on using Acendo Book panels to schedule meetings, refer to the *Acendo Book Scheduling Panels - User Guide* section on page 66.

Scheduler Settings

Overview

Most of the settings made in the *Scheduling Panel Setup Wizard* (see page 22) can be viewed and edited via the *Scheduler Settings* options, as described below.

NOTE: Refer to the *Advanced Settings* section on page 43 for information on viewing/edit touch panel-specific options.

Accessing the Scheduler Settings Pages

1. Press and hold the pushbutton on the top of the touch panel for 5 seconds to invoke the SETTINGS window (FIG. 49):

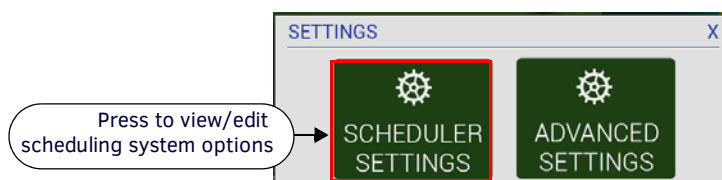

FIG. 49 SETTINGS window - SCHEDULER SETTINGS

NOTE: Alternatively, press and hold the room name for approximately 5 seconds to open the Settings window.

2. Press **SCHEDULER SETTINGS**. These settings are password-protected. Enter the Administrator password for the scheduling system in the ENTER PASSWORD field (FIG. 50):



FIG. 50 Administrator Login window

- The default password is **1988**.
 - This password is configured in the Security page of the Setup Wizard - see *Setup Wizard: Step 7 - SECURITY* on page 33.
3. Press **Submit**. If the password entered was valid, the SETTINGS pages are opened (FIG. 51):

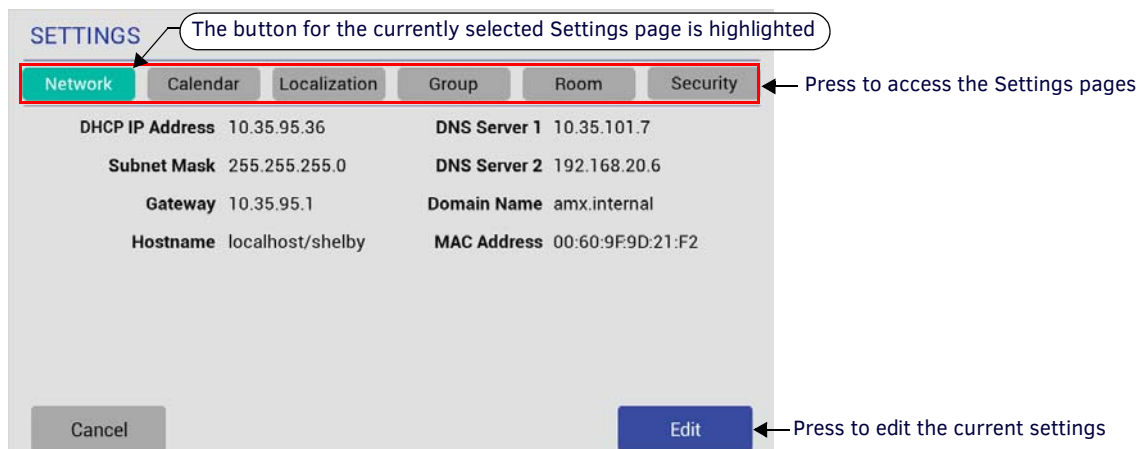

FIG. 51 SETTINGS Pages (Network Settings page shown)

The SETTINGS pages provide the ability to view/edit the *Scheduler Settings* on this panel.

Note that these pages are presented in a similar fashion to the pages in the Scheduling Panel Setup Wizard - the initial Settings page presented is the *Network Settings* page (shown in FIG. 51).

4. Press any of the buttons along the top of the page to access each Settings page.

Viewing/Editing Network Settings

1. Press **Network** to view the current Network settings for this panel (FIG. 52):

The screenshot shows the 'SETTINGS' page with a top navigation bar containing buttons for 'Network', 'Calendar', 'Localization', 'Group', 'Room', and 'Security'. The 'Network' button is highlighted in green. Below the navigation bar, the current network settings are displayed in a table-like format:

DHCP IP Address	10.35.82.28	DNS Server 1	192.168.20.5
Subnet Mask	255.255.254.0	DNS Server 2	192.168.20.6
Gateway	10.35.82.1	Domain Name	amx.internal
Hostname	localhost-48ec602166a8f4d7	MAC Address	00:60:9F:9E:CD:BD

At the bottom of the settings page, there are two buttons: 'Exit' and 'Edit'.

FIG. 52 SETTINGS Page - Network

2. Press **Edit** to open the NETWORK Settings page, to edit the current settings as required (FIG. 53).

The screenshot shows the 'NETWORK' settings page. At the top, there are two radio buttons: 'DHCP' (which is selected and highlighted in green) and 'Static'. Below this, there are input fields for various network parameters:

IP Address	10.35.92.108	DNS Server 1	192.168.20.5
Subnet Mask	255.255.255.0	DNS Server 2	192.168.20.6
Gateway	10.35.92.1	Domain Name	amx.internal
Hostname	chrismbk3	MAC Address	00:60:9F:9E:CD:A5

At the bottom right of the settings page, there is a button labeled 'Proxy Setup ...' which is highlighted with a red box. An arrow points from this button to the text 'Press to open the Proxy Settings page'. Below the settings page, an on-screen keyboard is visible, showing keys for letters, numbers, and symbols.

FIG. 53 NETWORK Settings page

3. Press on any enabled field and use the on-screen keyboard or keypad to edit these fields as necessary.
4. Press **Next** to jump to the next editable field on this page. The fields on the NETWORK Settings page are described on page 23.

NOTE: The example in FIG. 53 shows all fields enabled. This is because with "Static" selected, all network information must be manually entered. When DHCP is selected, only the "Hostname" field is enabled for editing.
5. Press **Proxy Setup** to enable/disable the Proxy option and configure Proxy Settings and Account Information as required, in the Proxy Settings page. By default Proxy is disabled on RBMK panels, Refer to the Proxy Setup section on page 38 for details.
6. Press **Save** to save changes and close the NETWORK Settings page.

NOTE: The panel's Network settings can be also be edited via Advanced Settings (see CONNECTIONS - Ethernet on page 50).

Changing the IP Address on the Acendo Book Panel

Select either *DHCP* or *Static* at the top of the NETWORK Settings page.

- Note that by default, *DHCP* is selected (and the remaining addressing options on this page are disabled).
- If *Static* is selected, the fields on this page are enabled and must be filled in manually.

Proxy Setup

Press the **Proxy Setup** button on the NETWORK Settings page (see FIG. 53 on page 37) to access the *Proxy Settings* page (FIG. 54):

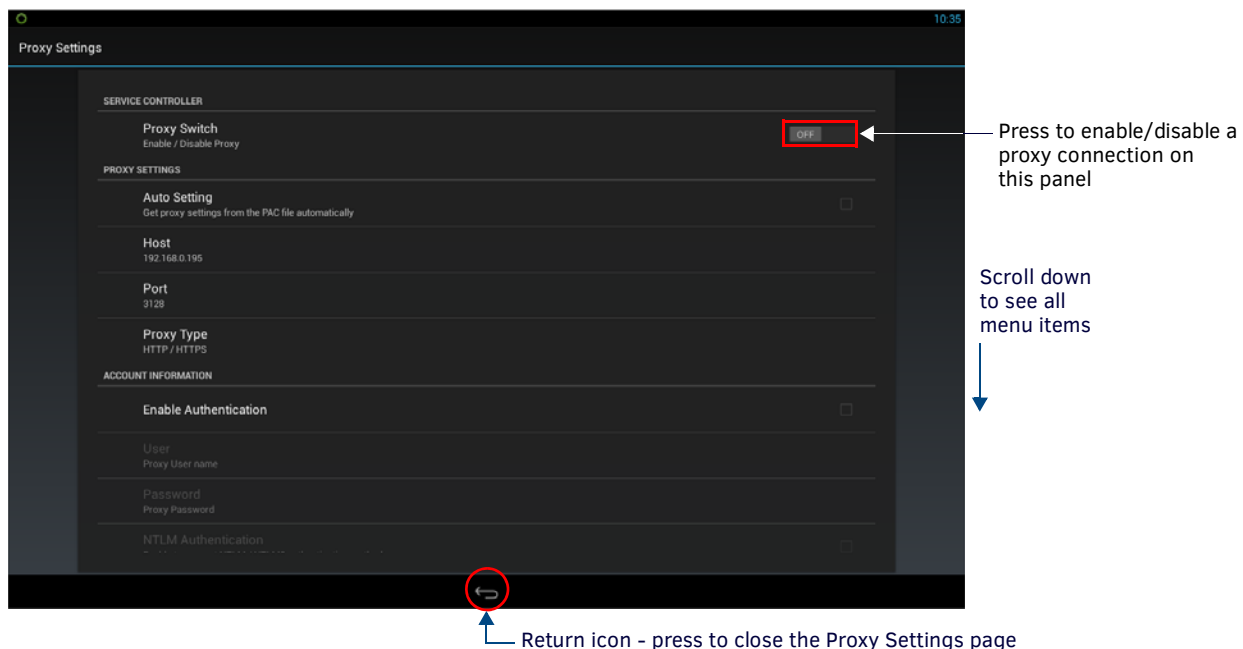

FIG. 54 Proxy Settings page

Use the options in the *Proxy Settings* page to enable/disable the Proxy option and configure *Proxy Settings* and *Account Information* as required.

NOTE: By default Proxy is disabled on RMBK panels.

Proxy Settings page options	
SERVICE CONTROLLER	
Proxy Switch	Push this button to enable or disable Proxy support on this panel. Note that by default, the Proxy Switch is set to "OFF", indicating that proxy support is disabled. If this panel will connect to a proxy server, press this button to toggle the Proxy Switch to "ON" (enabled). Note that when the Proxy Switch is set to ON, the proxy configuration options on this page are disabled. These options can only be set when the Proxy Switch is set to OFF.
PROXY SETTINGS	
Auto Setting	When enabled, this panel will automatically retrieve the proxy settings from a PAC (proxy auto-config) file on the proxy server. To use this option, a valid PAC file must reside on the proxy server. Press this option to enable using a PAC file for proxy settings. A blue checkmark in the Auto Setting option indicates that this option is enabled. Note that when this option is enabled, the remaining PROXY SETTINGS on this page are disabled, since manual entry is not needed.
Host	Press to manually enter the Host (IP Address) of the proxy server.
Port	Press to manually enter the Port number on the proxy server that will be used for this RMBK panel.
Proxy Type	Press to select the Proxy Type used on the proxy server to which this RMBK panel will connect. The options are <i>HTTP/HTTPS</i> (the default setting), <i>SOCKS4</i> and <i>SOCKS5</i> .
ACCOUNT INFORMATION	
Enable Authentication	If this panel will connect to a secured proxy server (one that requires a Proxy Username and Proxy Password in order to connect), press this option to enable the User and Password options described below. Note that by default, the Enable Authentication option is set to "OFF". A blue checkmark in the Enable Authentication option indicates that this option is enabled. Note that when this option is enabled, the remaining ACCOUNT INFORMATION options on this page are enabled.
User	If the <i>Enable Authentication</i> option is selected, press this option to enter the Proxy User name required by the server.
Password	If the <i>Enable Authentication</i> option is selected, press this option to enter the Proxy Password required by the server.
NTLM Authentication	If this panel will connect to a NTLM/NTLM2 secured proxy server (one that uses NT LAN Manager authentication methods), press this option to enable the <i>Domain</i> option described below. Note that by default, the NTLM Authentication option is set to "OFF".
Domain	If the <i>NTLM Authentication</i> option is selected, press to enter the Domain name required for proxy server.

Viewing/Editing Calendar Settings

1. In any SETTINGS page, press **Calendar** to view the current Calendar settings for this panel (FIG. 55):

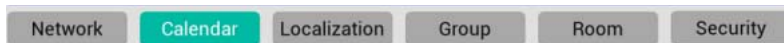

FIG. 55 SETTINGS Page - Calendar

2. Press **Edit** to open the CALENDAR Settings page, to edit the current settings as required (FIG. 56).

 A screenshot of the CALENDAR Settings page. At the top, there are three toggle switches: Microsoft Exchange (checked), Office 365 (unchecked), and Google Calendar (unchecked). Below these are input fields for Server URL (https://10.35.85.178/EWS/Exchange.asmx), Username (rmservice@pv2010.local), Password (masked with dots), and Calendar Email ID (keypad2@pv2010.local). At the bottom, there is an on-screen keyboard with a 'Next' button on the right side.

FIG. 56 CALENDAR Settings page

3. Press on any enabled field and use the on-screen keyboard or keypad to edit these fields as necessary. Press **Next** to jump to the next editable field on this page. The fields on the CALENDAR Settings page are described on page 24.
4. Press **Save** to save changes and close the CALENDAR Settings page.

More Information

- See *Appendix B: Configuring Acendo Book Panels for Microsoft Exchange & Office 365* on page 78.
- See *Appendix D: Configuring Google Resources* on page 82.
- See *Appendix A: Troubleshooting* on page 73.

Viewing/Editing Localization Settings

1. In any SETTINGS page, press **Localization** to view the current Localization settings for this panel (FIG. 57):



FIG. 57 SETTINGS Page - Localization

2. Press **Edit** to open the LOCALIZATION Settings page, to edit the current settings as required (FIG. 58).

 A screenshot of the LOCALIZATION Settings page. It features several settings with buttons to edit them: Language (English), Timezone (CST), Time Format (12 HR selected, 24 HR), Date Format (Month-Date selected, Date-Month), Default Meeting Length (15 mins selected, 30 mins, 60 mins), and Default Meeting Length Increment (15 mins selected, 30 mins, 60 mins). At the bottom, there are 'Cancel' and 'Save' buttons.

FIG. 58 LOCALIZATION Settings page

3. Press **Save** to save changes and close the LOCALIZATION Settings page. The fields on the LOCALIZATION Settings page are described on page 28.

NOTE: The panel's Localization settings can be also be edited via Advanced Settings (see *SYSTEM - Date & Time* on page 52 and *SYSTEM - Language & Input* on page 53).

Changing the Language Displayed On the Acendo Book Panel

1. Open the SCHEDULER SETTINGS - **Localization** Page.
2. Press **Edit** to access the *LOCALIZATION Settings* page.
3. Press the **Edit** button next to *Language* to access a listing of all languages that can displayed on this Acendo Book Panel, in the *SELECT LANGUAGE* window (FIG. 59):

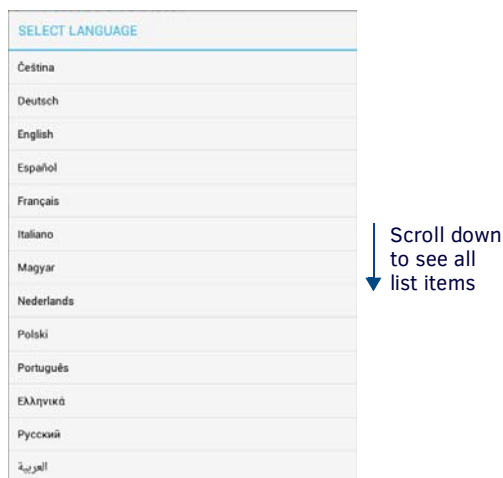

FIG. 59 SELECT LANGUAGE window

NOTE: Press anywhere outside the *SELECT LANGUAGE* window to close the window without making a selection.

4. Press **Save** in the *LOCALIZATION Settings* page to save this change.

Changing the Timezone Displayed On the Acendo Book Panel

1. Open the SCHEDULER SETTINGS - **Localization** Page.
2. Press **Edit** to access the *LOCALIZATION Settings* page.
3. Press the **Edit** button next to *Timezone* to access a listing of all time zones that can displayed on this Acendo Book Panel, in the *SELECT TIMEZONE* window (FIG. 60):

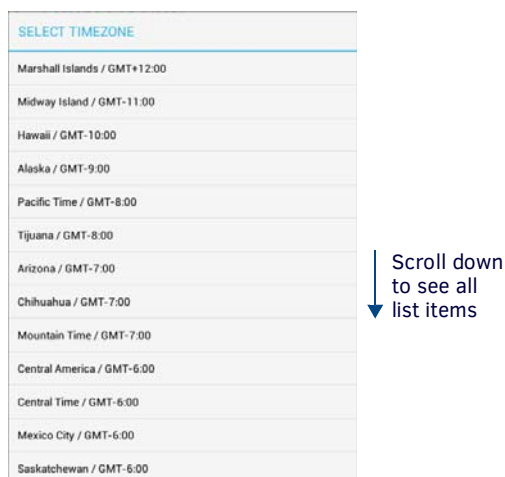

FIG. 60 SELECT TIMEZONE window

NOTE: Press anywhere outside the *SELECT TIMEZONE* window to close the window without making a selection.

4. Press **Save** in the *LOCALIZATION Settings* page to save this change.

Changing the Time Format Displayed On the Acendo Book Panel

1. Open the SCHEDULER SETTINGS - **Localization** Page.
2. Press **Edit** to access the *LOCALIZATION Settings* page.
3. Next to **Time Format**, press to select either **12HR** (default setting) or **24 HR** time format.
4. Press **Save** in the *LOCALIZATION Settings* page to save this change.

Changing the Date Format Displayed On the Acendo Book Panel

1. Open the SCHEDULER SETTINGS - **Localization** Page.
2. Press **Edit** to access the *LOCALIZATION Settings* page.
3. Next to **Date Format**, press to select either **Month-Date** (default setting) or **DATE-MONTH** date format.

4. Press **Save** in the *LOCALIZATION Settings* page to save this change.

Changing the Default Meeting Length Displayed On the Acendo Book Panel

1. Open the SCHEDULER SETTINGS - **Localization** Page.
2. Press **Edit** to access the *LOCALIZATION Settings* page.
3. Next to **Default Meeting Length**, press to select **15 mins**, **30 mins** (default setting) or **60 mins**.
4. Press **Save** in the *LOCALIZATION Settings* page to save this change.

Changing the Default Meeting Length Increment Displayed On the Acendo Book Panel

1. Open the SCHEDULER SETTINGS - **Localization** Page.
2. Press **Edit** to access the *LOCALIZATION Settings* page.
3. Next to **Default Meeting Length Increment**, press to select **15 mins** (default setting), **30 mins** or **60 mins**.
4. Press **Save** in the *LOCALIZATION Settings* page to save this change.

Viewing/Editing Group Settings

1. In any SETTINGS page, press **Group** to view the current Group settings for this panel (FIG. 61):

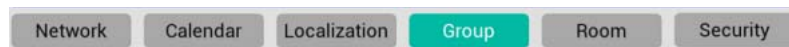

FIG. 61 SETTINGS Page - Group

2. Press **Edit** to open the GROUP Settings page, to edit the current settings as required (FIG. 62).

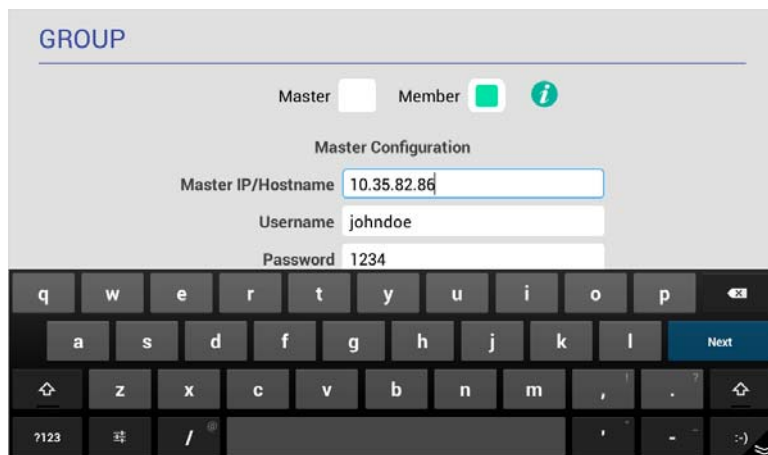

FIG. 62 GROUP Settings page

3. Press on any enabled field and use the on-screen keyboard or keypad to edit these fields as necessary. Press **Next** to jump to the next editable field on this page. The fields on the GROUP Settings page are described on page 29.
4. Press **Save** to save changes and close the GROUP Settings page.

Viewing/Editing Room Settings

1. In any SETTINGS page, press **Room** to view the current Room settings for this panel (FIG. 61):

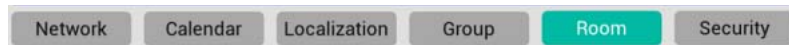

FIG. 63 SETTINGS Page - Room

2. Press **Edit** to open the ROOM Settings page, to edit the current settings as required (FIG. 62).

FIG. 64 ROOM Settings page

3. Press on any enabled field and use the on-screen keyboard or keypad to edit these fields as necessary. Press **Next** to jump to the next editable field on this page. The fields on the ROOM Settings page are described on page 31.
4. Press **Save** to save changes and close the ROOM Settings page.

Viewing/Editing Security Settings

1. In any SETTINGS page, press **Security** to view the current Room settings for this panel (FIG. 61):

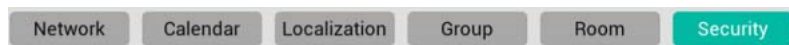

FIG. 65 SETTINGS Page - Room

2. Press **Edit** to open the SECURITY Settings page, to edit the current settings as required (FIG. 62).

FIG. 66 SECURITY Settings page

3. Press on any enabled field and use the on-screen keyboard or keypad to edit these fields as necessary. Press **Next** to jump to the next editable field on this page. The fields on the SECURITY Settings page are described on page 33.
4. Press **Save** to save changes and close the SECURITY Settings page.

Advanced Settings

Overview

Acendo Book panels present all panel configuration information via the touch panel's on-board *Advanced Settings* menu. Select *Advanced Settings* in the Settings menu to access the Advanced Settings menu.

NOTE: Refer to the *Scheduler Settings* section on page 36 for information on viewing/editing Scheduler-specific options.

Accessing the Advanced Settings Pages

1. Press and hold the pushbutton on the top of the touch panel for 5 seconds (see FIG. 4 on page 13) to invoke the SETTINGS window (FIG. 67):

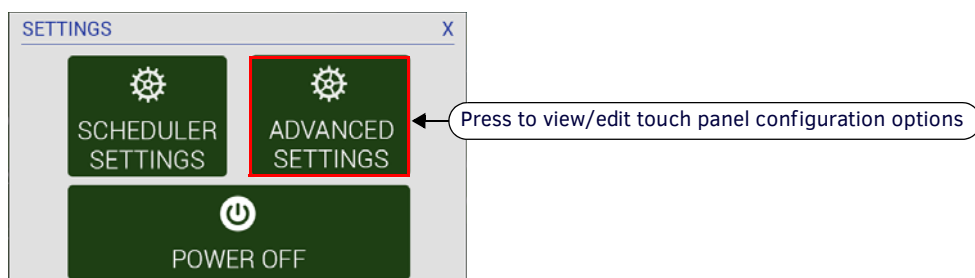

FIG. 67 SETTINGS window - ADVANCED SETTINGS

NOTE: Alternatively, A long press of the room name (5 seconds minimum), will invoke the Settings window.

2. Press ADVANCED SETTINGS to access the Panels Settings menu.

NOTE: The panel will prompt you to enter the Administrator Password before opening protected Advanced Settings pages. The default Administrator password is "1988".

Using the Advanced Settings Menu

Many of the entries in the Advanced Settings menu are read-only. Information on the *Device Info* page (the initial view) will update when modified on subsequent pages.

The information on each Settings page appears in white under the main category title. Press the text to edit that field. Gray text indicates that the option associated with that category is disabled for editing. This may be altered with changes in connectivity (connecting a USB stick to the panel, for instance) or changes to other pages within the menu.

Advanced Settings Menu Options

The Advanced Settings Menu is separated into four main pages: *INFO*, *DEVICE*, *CONNECTIONS*, and *SYSTEM*:

Advanced Settings Menu Options		
Page Name	Description	Page #
INFO (initial view)		
Device Info	Displays basic panel information, such as available memory and screen resolution dimensions.	page 44
Maintenance	Provides control of basic panel functions, including rebooting or shutting down the panel.	page 45
DEVICE		
Sound	Allows adjustment of volume levels and panel sounds settings.	page 46
Display	Provides controls for basic functions of the panel display, including brightness.	page 47
VNC	Enables/disables and configures VNC server functionality on the panel.	page 49
CONNECTIONS		
Ethernet	Allows configuration of Ethernet communication settings with the panel.	page 50
SYSTEM		
Date & Time	Allows setting and adjusting of time and date information on the panel.	page 52
Language & Input	Controls the language used by the Advanced Settings menu, as well as the keyboard input used for data entry	page 53
Security	Allows setting or changing the admin password for this panel as well as managing CA Certificates.	page 57
Reset and Update	Allows resetting and updating of panel settings and firmware.	page 61
Diagnostics	Displays the current processor temperature, provides access to panel logs.	page 65

NOTE: The *DEVICE*, *CONNECTIONS*, *ACCOUNTS*, and *SYSTEM* pages are password-protected. The default Administrator password is "1988", and can be changed via the options in the *SECURITY* page - see *Changing the Administrator Password on the Panel* on page 33 for details.

Opening Advanced Settings pages

1. Select the appropriate page from the Advanced Settings menu.
2. In the *Password* keypad, enter the Administrator password and select **OK**.

NOTE: The default password is "1988".

Closing the Advanced Settings menu

To close the Advanced Settings menu and return to the panel's scheduling pages, select the **Return** icon at the bottom of the Advanced Settings window (see FIG. 68).

INFO - Device Info

The *INFO - Device Info* page (FIG. 68) displays basic panel information, such as available memory and screen resolution dimensions (read-only).

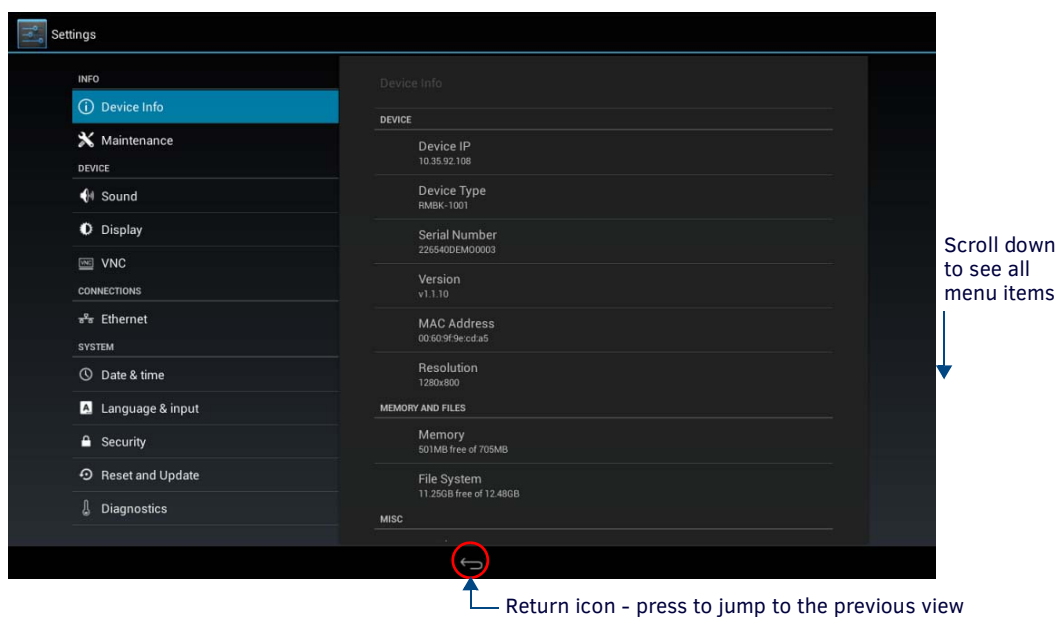

Return icon - press to jump to the previous view

FIG. 68 INFO - Device Info page

INFO - Device Info page options	
DEVICE	
Device IP	Displays the panel's IP address.
Device Type	Displays the panel model.
Serial Number	Displays the specific serial number value assigned to the panel.
Version	Displays the current version of the panel's firmware.
MAC Address	Displays the panel's MAC address.
Resolution	Displays the panel's screen height and width in pixels.
MEMORY AND FILES	
Memory	Displays the amount of memory available on the panel.
File System	Displays the amount of MicroSD card memory available on the panel.
MISC	
Up Time	Displays the time elapsed since the panel was last started.
Legal Information	Select this entry to open the <i>Legal Information</i> window, which displays information on intellectual property notices and information on copyright concerns.

INFO - Maintenance

The *INFO - Maintenance* page (FIG. 69) provides control of basic panel functions, including rebooting or shutting down the panel.

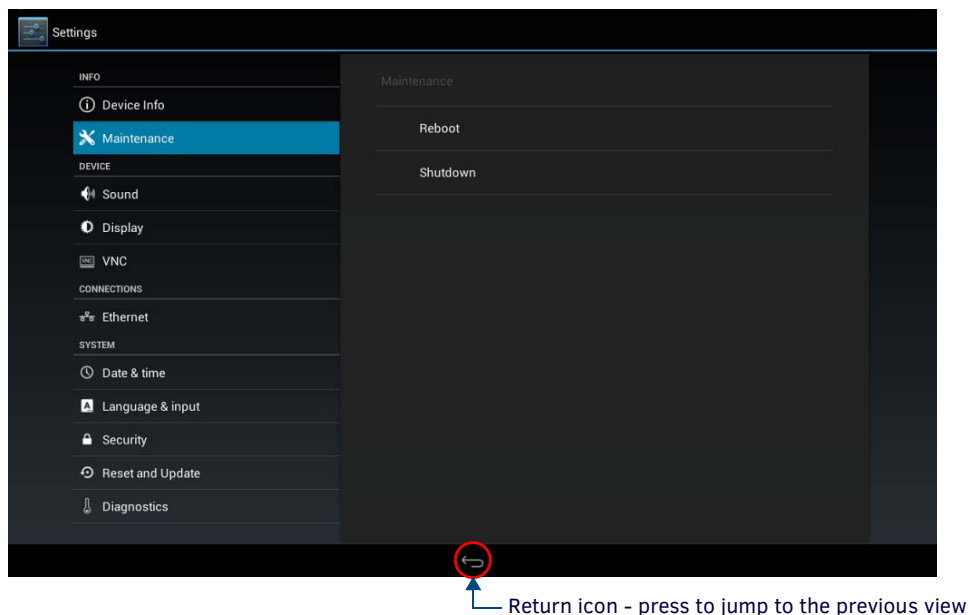

FIG. 69 INFO - Maintenance page

INFO - Maintenance page options	
Reboot:	Select this entry to open the <i>Reboot</i> window.
Shutdown:	Select this entry to open the <i>Shutdown</i> window.

Rebooting the Panel

1. In the *Maintenance* page, select **Reboot**. This opens the *Reboot* window (FIG. 70).

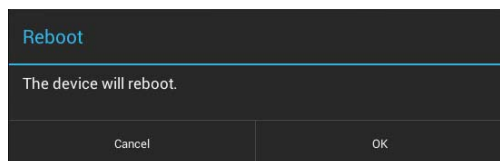

FIG. 70 Reboot window

2. Press **OK** to reboot.

To return to the *Maintenance* page without rebooting, press *Cancel* (or press outside the *Reboot* window).

Shutting Down the Panel

1. In the *Maintenance* page, select **Shutdown**. This opens the *Shutdown* window (FIG. 71):

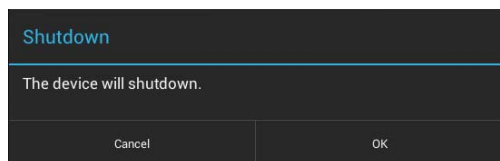

FIG. 71 Shutdown window

2. Press **OK** to shut down the panel.

To return to the *Maintenance* page without shutting down the panel, press *Cancel* (or press outside the *Shutdown* window).

DEVICE - Sound

The *Sound* page (FIG. 72) allows adjustment of volume levels and panel sounds settings.

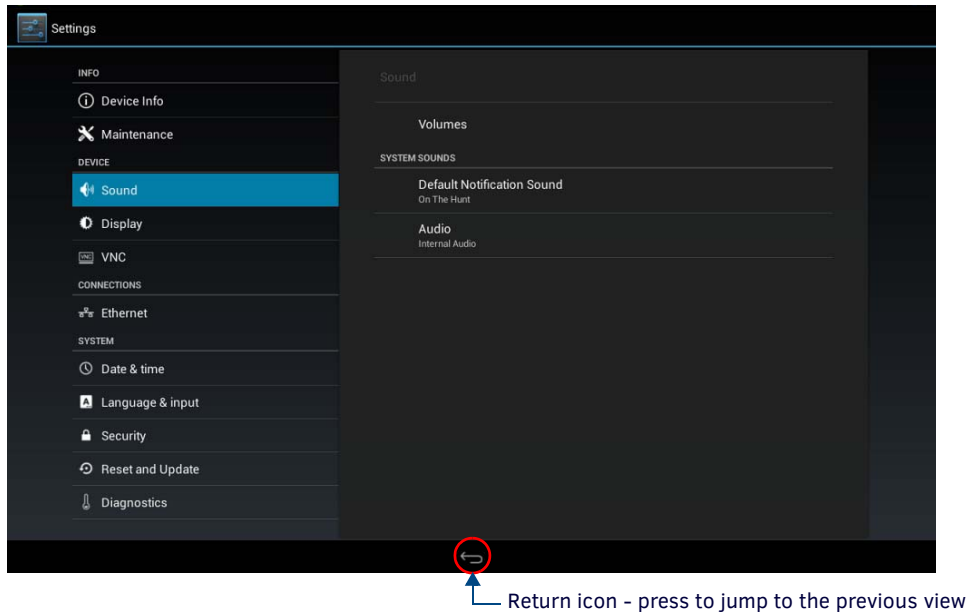

FIG. 72 DEVICE - Sound page

Sound page options	
SOUND	
Volumes	Press to open the <i>Volumes</i> window, which provides options to adjust volume for Music, video, games and other media as well as Notifications and Alarms. See the <i>Adjusting Volumes</i> section on page 46 for details.
SYSTEM SOUNDS	
Default Notification Sound:	Select this entry to choose a default notification sound from the menu provided. See <i>Selecting a Default Notification Sound</i> section on page 46.
Audio:	Displays the current audio options. The current and only available option is " <i>Internal Audio</i> ".

Adjusting Volumes

In the *Sound* page, press *Volumes* icon (FIG. 73) to open the *Volumes* window (FIG. 73):

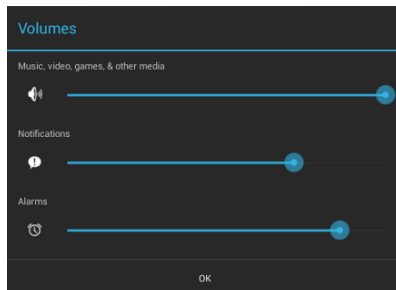

FIG. 73 Sound page - Volumes window

Use these controls to adjust all of the available volume controls on the panel.

Press **OK** to save changes and close the *Volumes* window.

To return to the *Sound* page without saving changes, *press outside the Volumes window*.

Selecting a Default Notification Sound

To select a particular sound to be the default notification sound for all panel functions:

1. In the *Sound* page, under **SYSTEM SOUNDS**, select *Default Notification Sound*. This opens the *Default notification sound* window (FIG. 74):
2. Choose a sound from the presented list: selecting a new sound will play it once. The sound will only be audible if the *Notifications* slide bar in *Volumes* is not muted.
3. Press **OK** to set the selected sound as the Default Notification Sound.

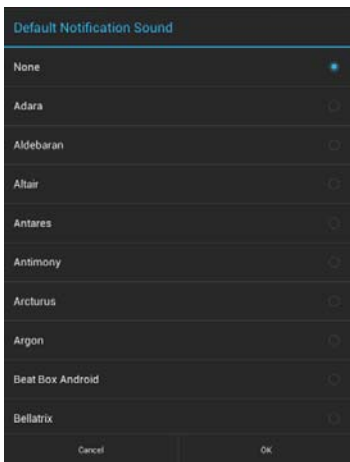
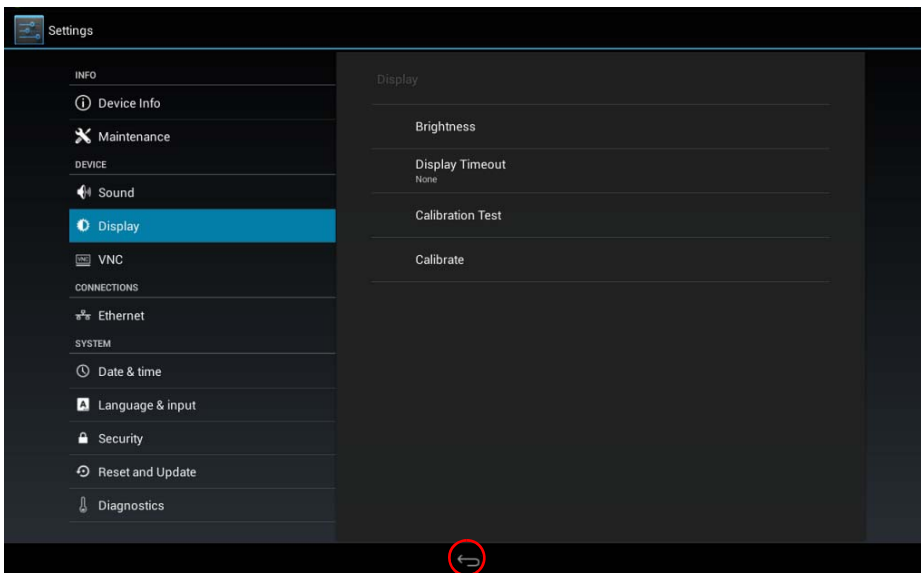

FIG. 74 Default Notification Sound window

To return to the *Sound* page without making any changes, press *Cancel* (or press outside the *Default Notification Sound* window).

DEVICE - Display

The *Display* page (FIG. 75) controls the basic functions of the panel display, including the panel brightness, display timeout settings and touch calibration.



Return icon - press to jump to the previous view

FIG. 75 DEVICE - Display page

DEVICE - Display page options	
Brightness:	Sets the display brightness and contrast levels of the panel. See <i>Adjusting Panel Brightness</i> on page 47 for details.
Display Timeout:	Indicates the length of time that the panel can remain idle before the display automatically powers down. Select the Display Timeout setting. Range = 30 seconds, 1, 5, 10, 30 minutes, 1, 2, 4 and 8 hours. The default setting is 8 hours. Set the timeout value to <i>None</i> to disable Display Timeout mode. See the <i>Adjusting Display Timeout</i> on page 48 for details.
Calibration Test:	Select this to open the <i>Calibration Test</i> page. See <i>Calibration Test</i> on page 48 for details.
Calibrate:	Select to open the <i>Calibrate</i> window, to manually calibrate the panel. See <i>Calibrate</i> on page 49 for details.

Adjusting Panel Brightness

1. In the *Display* page, select **Brightness** to open the *Brightness* window (FIG. 76).
2. Use the slider for manual adjustment of the panel's display brightness.

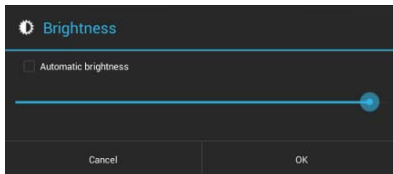

FIG. 76 Brightness window

3. Press **OK** to save changes and close this window.

To return to the *Display* page without making any changes, press *Cancel* (or press outside the *Brightness* window).

Adjusting Display Timeout

1. In the *Display* page, select **Display Timeout** to open the *Display Timeout* window (FIG. 77).

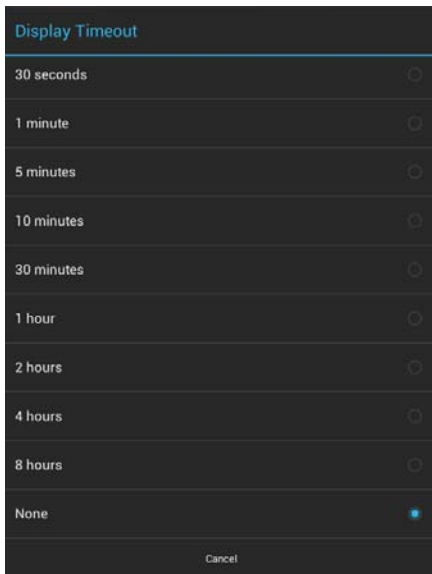

FIG. 77 Display Timeout window

2. Select the time period that will pass before the panel enters sleep mode, or select *None* to keep the panel from shutting down its display. The default settings is *8 hours*. When a timeout setting is selected, the *Display Timeout* window closes immediately, having applied the selected setting.

To return to the *Display* page without making any changes, press *Cancel* (or press outside the *Display Timeout* window).

Calibration Test

Acendo Book panels automatically self-calibrate on startup. The *Calibration Test* page may be used to verify the accuracy of that calibration. Select **Calibration Test** to open the *Calibration Test* page (FIG. 78):

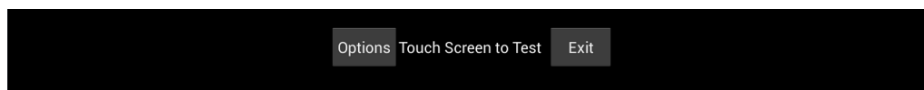

FIG. 78 Calibration Test menu

NOTE: *In order to ensure a correct calibration upon starting, the panel display should not be touched while the panel is booting.*

To run a calibration test on the touch panel:

1. In the *Display* page, select *Calibration Test*.
2. Touch the screen to test the calibration.
3. For options when testing the calibration of the touch panel, select **Options** to open the *Calibration Test Options* window (FIG. 79).
 - **Fade** is the default setting: it causes the cursor to fade away after touching; press it again to retain all touches on the display screen. Select this option to disable the Fade feature.
 - Press **Clear** to clear the memory of previous touches. When finished, select *Exit* to return to the *Calibration Test* page.

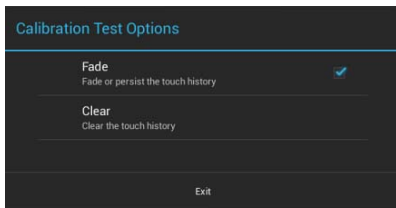

FIG. 79 Calibration Test Options window

4. When finished with the calibration test, select **Exit** to return to the *Display* page.

Calibrate

To manually calibrate the panel:

1. Select **Calibrate** to open the Calibrate window.
2. Follow the on-screen instructions.

DEVICE - VNC

An on-board VNC (Virtual Network Computing) server allows the panel to connect to any remote PC running a VNC client. Once connected, the client can view and control the panel remotely. The options on the *VNC* page (FIG. 80) allow you to enable or disable VNC server functionality on the panel.

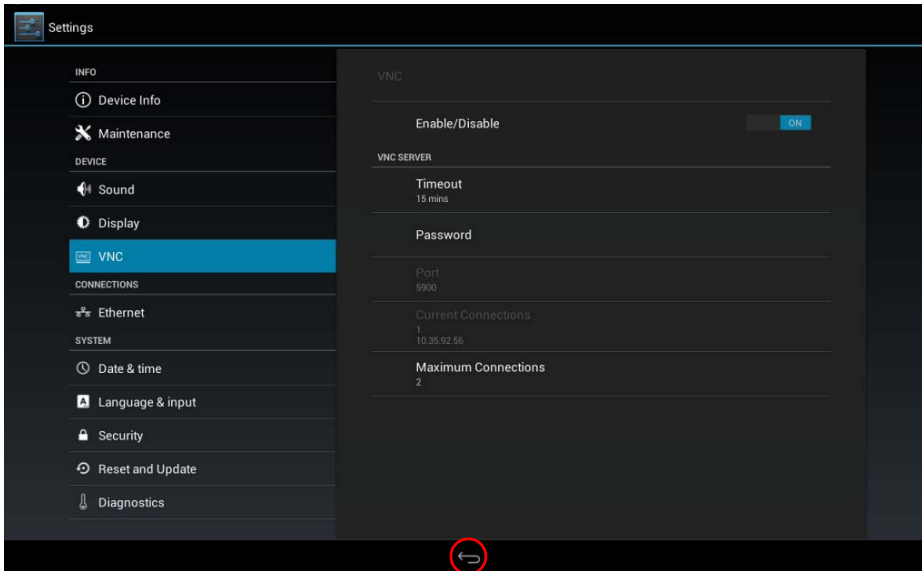

Return icon - press to jump to the previous view

FIG. 80 DEVICE - VNC page

DEVICE - VNC page options	
VNC	
Enable/Disable:	Press to toggle on/off the VNC server on the panel (default = <i>enabled</i>)
VNC SERVER	
Timeout:	Sets the length of time (in minutes) that the panel can remain idle, detecting no cursor movements, before the VNC session is terminated. (default = <i>15 minutes</i>).
Password:	Enter the VNC Authentication session password required for VNC access to the panel.
Port:	Use this field to enter the number of the port used by the VNC Web Server. Note that this field is enabled only while VNC is disabled (default = <i>5900</i>).
Current Connections:	Displays the number of users currently connected to this panel via VNC (read-only).
Maximum Connections:	Displays the maximum number of users that can be simultaneously connected to this panel via VNC. Press this field to increase the number allowed to connect to this panel. (default = <i>2</i>).

NOTE: The VNC server takes snapshots of the display buffer and sends them via VNC at a low frame rate.

Enabling VNC

In the *VNC* page, press **Enable/Disable** to toggle VNC to *ON* (the default setting is *OFF*).

Configuring VNC Access

In the *VNC* page, use the options under **VNC SERVER** to configure various aspects of VNC access on the panel:

- Press **Timeout** to specify a timeout period for VNC connections, in the *Timeout* window. Press **OK** to save changes.
- Press **Password** to assign the password to be required to establish a VNC connection, in the *Password* window. By default, no VNC password is set. Press **OK** to save changes.
- Press **Port** to specify the port to be used by the VNC Web Server, in the *Port* window. This option is not available if VNC is currently enabled. Press **OK** to save changes.
- Press **Maximum Connections** to set the maximum number of users that can be simultaneously connected to this panel via VNC. Press **OK** to save changes.

CONNECTIONS - Ethernet

The *Ethernet* page (FIG. 81) controls the configuration of settings for Ethernet communication with the panel.

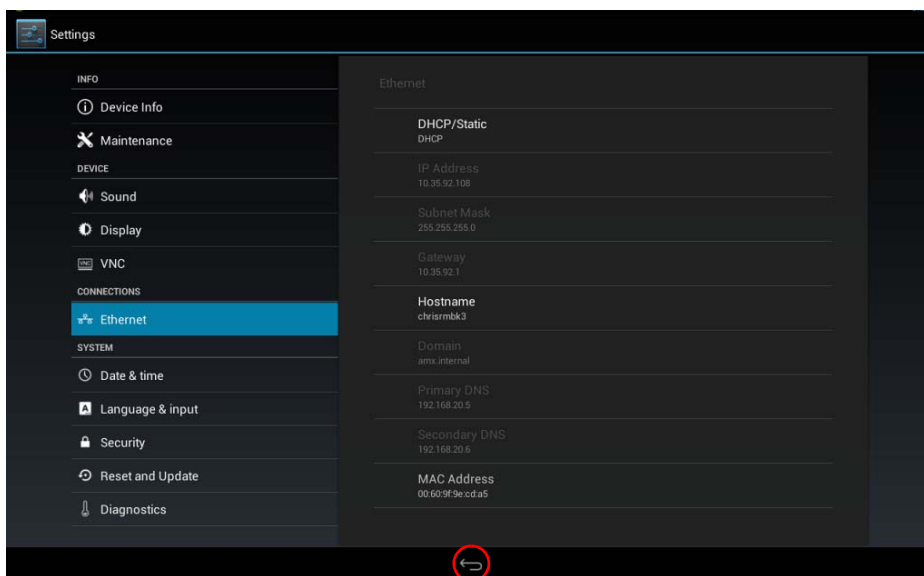

Return icon - press to jump to the previous view

FIG. 81 CONNECTIONS - Ethernet page

CONNECTIONS - Ethernet page options	
DHCP/Static:	Sets the panel to either DHCP or Static communication modes. <ul style="list-style-type: none"> • <i>DHCP</i> is an IP Address assigned to the panel by a DHCP server. If DHCP is selected, the other <i>Network Connection</i> fields are disabled (see below). • <i>Static IP</i> is a permanent IP Address assigned to the panel. If Static IP is selected, the other <i>Network Connection</i> fields are enabled.
IP Address:	Displays the IP address for this panel. If DHCP is enabled, this field will be disabled.
Subnet Mask:	Displays the subnetwork for this panel. If DHCP is enabled, this field will be disabled.
Gateway:	Displays the gateway address for this panel. If DHCP is enabled, this field will be disabled.
Hostname:	Displays the hostname for this panel.
Domain:	Displays a name to the panel for DNS look-up. If DHCP is enabled, this field will be disabled.
Primary DNS:	Displays the address of the primary DNS server used by this panel for host name lookups. If DHCP is enabled, this field will be disabled.
Secondary DNS:	Displays the secondary DNS address for this panel. If DHCP is enabled, this field will be disabled.
MAC Address:	This unique address identifies the Ethernet connection in the panel (read-only).

Setting Static IP Information

When using *DHCP* settings for a panel, the DHCP server will automatically populate almost all of the *Ethernet* page fields, with the exception of *Hostname*. When setting the panel for *Static*, however, this information must be entered manually. To enter the network connection information:

1. Press *DHCP/Static* to access the *DHCP/Static* options window (FIG. 82):

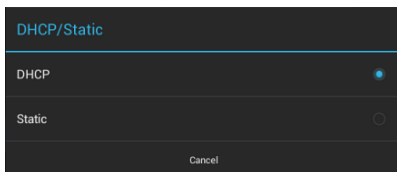

FIG. 82 DHCP/Static window

To return to the *Ethernet* page without making any changes, press **Cancel** (or press outside the *DHCP/Static* window).

2. Press **Static** to select to use Static IP information, and open the *Static IP* window (FIG. 83).

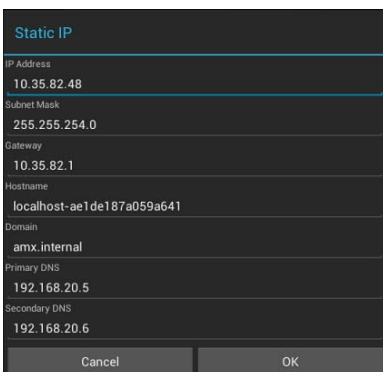

FIG. 83 Static IP window

3. Press any field in this window to open the *on-screen* keypad.
4. Enter the information for each field presented.
 - If the field accepts alphanumeric characters, a keyboard opens instead.
 - Press **Next** (in the on-screen keypad) to proceed to the next field.
5. When complete, press **OK** to save changes and return to the *Static IP* window. The new connection information is presented in the *Ethernet* page.

To return to the *Ethernet* page without making any changes, press **Cancel** (or press outside the *Static IP* window).

Entering a New Hostname

In order to facilitate DNS lookup of the panel, you should set a new hostname for the panel.

To add a new hostname, or to change an existing one:

1. From the *Ethernet* page, select *Hostname* to open the *Hostname* window (FIG. 84).

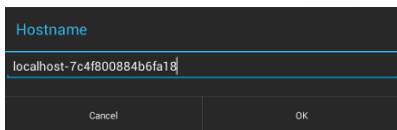
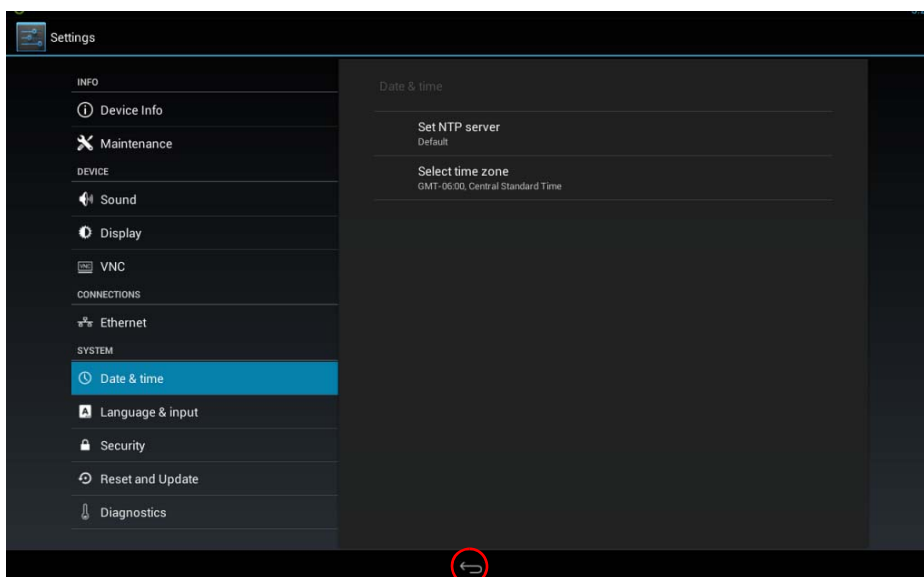

FIG. 84 Hostname window

2. Enter the new hostname and press **OK**. The new hostname will now appear in the *Hostname* field.
To return to the *Ethernet* page without making any changes, press **Cancel** (or press outside the *Hostname* window).

SYSTEM - Date & Time

The *Date & Time* page (FIG. 85) allows setting and adjusting the NTP/time and date information on the panel.



Return icon - press to jump to the previous view

FIG. 85 SYSTEM - Date & Time page

SYSTEM - Date & Time page options	
Set NTP Server:	Date and time information is retrieved from an NTP Server. A default public NTP server is pre-configured on the panels. Press <i>Set NTP Server</i> option to manually specify a custom NTP Server (see below).
Select Time Zone:	Use the <i>Select Time Zone</i> window (FIG. 88) to select the current time zone.

NOTE: The network configuration must allow the Acendo Book Scheduling panel to communicate with the specified NTP Server (default or custom) in order for the Acendo Book panel to function.

Manually Setting a Custom NTP Server

1. In the *Date & Time* page, press **Set NTP Server**. This opens the *Set NTP Server* window (FIG. 86):

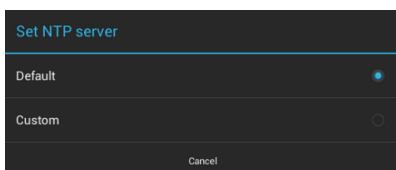

FIG. 86 Set NTP Server window

To return to the *Date & Time* page without making any changes, press **Cancel** (or press outside the *Set NTP Server* window).

2. Select **Custom** to invoke the *NTP Server* window (FIG. 87):

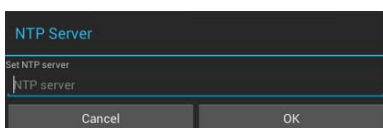

FIG. 87 NTP Server window

3. Press **Set NTP server** to enter the IP address of the NTP Server to use (via the on-screen keyboard).
4. Press **OK** to save changes and close this window.
To return to the *Date & Time* page without making any changes, press **Cancel** (or press outside the *NTP Server* window).

Manually Setting the Time Zone

1. Press **Select Time Zone** to open the *Select Time Zone* window (FIG. 88).

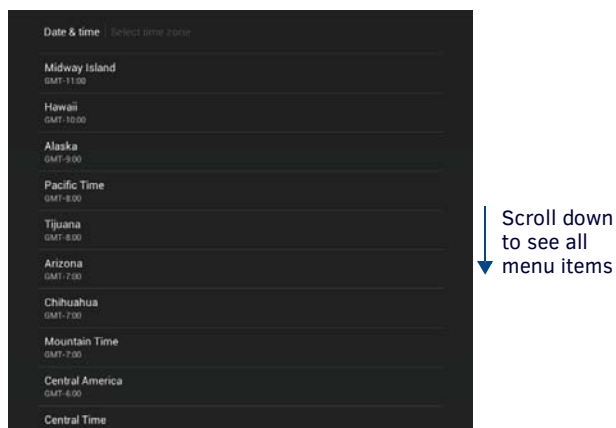

FIG. 88 Select Time Zone window

2. Select the time zone desired. The window will automatically close and return to the *Date & Time* page.

SYSTEM - Language & Input

The *Language & Input* page (FIG. 89) controls the language used by the *Settings* menu, as well as the keyboard input used for *Settings* menu field entries.



FIG. 89 Language & Input page

Language & Input page options	
Language:	Select a language for the <i>Settings</i> menu. See <i>Selecting the Panel's Language</i> on page 54 for details.
Spell Checker:	Enable this option to include an automatic spell checker in all <i>Settings</i> menu fields.
Personal Dictionary:	Lists all words saved in the panel's personal dictionary file. See <i>Personal Dictionary</i> on page 54 for details.
KEYBOARD & INPUT METHODS	
Default:	Specify the default system keyboard. Refer to <i>Changing Input Methods</i> on page 55 for details.
System Keyboard:	Choose the keyboard matching the selected panel language, or another language-format keyboard. Refer to <i>Changing Input Methods</i> on page 55 for details.
PHYSICAL KEYBOARD	
Generic:	Selects the format for a physical keyboard connected to the panel.
Auto-Replace:	Select this for automatic correction of commonly mistyped words.
Auto-Capitalization:	Select this for automatic capitalization of the first word in a sentence.
Auto-Punctuate:	Select this for automatic addition of a period when the space key is pressed twice.

Language & Input page options (Cont.)

MOUSE/TRACKPAD

Pointer Speed:	Provides the ability to adjust the speed of the cursor on the panel. Refer to <i>Changing the Pointer Speed</i> on page 56 for details.
----------------	---

Selecting the Panel's Language

English is the default language for Acendo Book panels, but this may be changed at any time through the *Language & Input* page. To change the panel's language:

1. In the *Language & Input* page, press **Language** to open the *Language* window (FIG. 90).

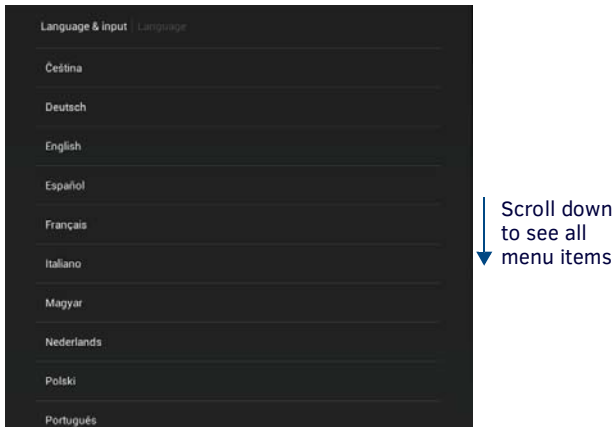

FIG. 90 Language Selection window

2. Choose a language from the list shown. To return to the default language without making any changes, select *Language & input* at the top of the window to close the window.

Personal Dictionary

Acendo Book panels have automatic spell-checking capabilities. Additionally, words and phrases may be added to the panel's personal dictionary:

1. In the *Language & Input* page, press **Personal dictionary** to open the *Personal Dictionary* window (FIG. 91).

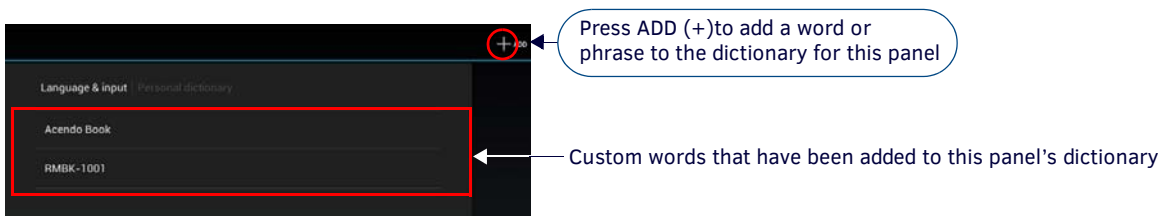

FIG. 91 Personal Dictionary window

2. Press the *Add* button in the upper right hand corner of the page to open the *Personal dictionary entry* window.
3. Press in the field beneath *PHRASE* to open the *Personal Dictionary* keyboard, and enter the word or phrase (FIG. 92):

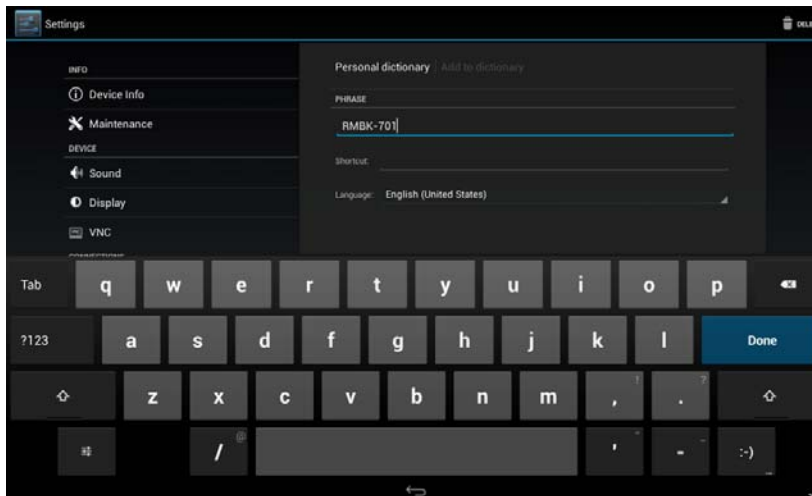

FIG. 92 Personal Dictionary (Add window and Keyboard shown)

- To add a shortcut for long or complex words, enter it in the *Shortcut* field.
 - If the word you add is in a language other than English, select the arrow in the lower right corner of the window to open the *Language* menu. This gives you the option of adding the word to the English dictionary, a dictionary for a language other than English, or for use across all languages. The *Language* page will automatically close after the language is selected.
 - To delete a word or phrase, select it in the *Personal dictionary* window and then press **Delete** in the upper right hand corner of the *Settings* menu.
4. Press **Done** to close the keyboard and add the specified word or phrase to the panel's dictionary.

Changing Input Methods

While a standard English keyboard is the default input language, you may also change the input method, such as choosing a Dvorak keyboard. To change the keyboard layout:

1. In the *Language & Input* page, under *KEYBOARD & INPUT METHODS*, press **Default** to open the *Choose Input Method* window (FIG. 93):



FIG. 93 Choose Input Method window

2. Press **Set up input methods** to open the *Keyboard Options* window (FIG. 94).

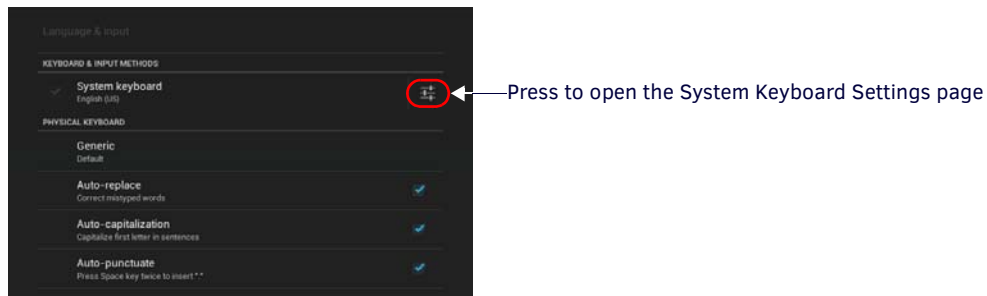

FIG. 94 Keyboard Options window

3. Press the **Settings** icon next to *System keyboard* to access the *System Keyboard Settings* page (FIG. 95):

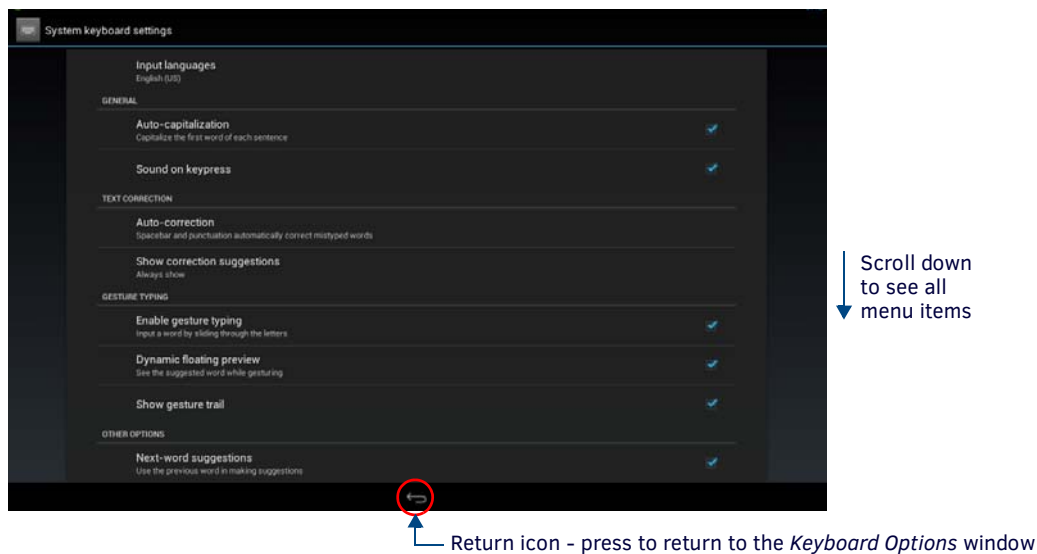

FIG. 95 System Keyboard Settings page

4. Edit these settings as desired, and press the return icon to close this page and return to the *Keyboard Options* window.
5. Under *PHYSICAL KEYBOARD*, press **Generic** to open the *Choose Keyboard Layout* window (FIG. 96):



FIG. 96 Choose Keyboard Layout window

6. Press **Set up keyboard layouts** to open the *Keyboard Layout* window (FIG. 97):

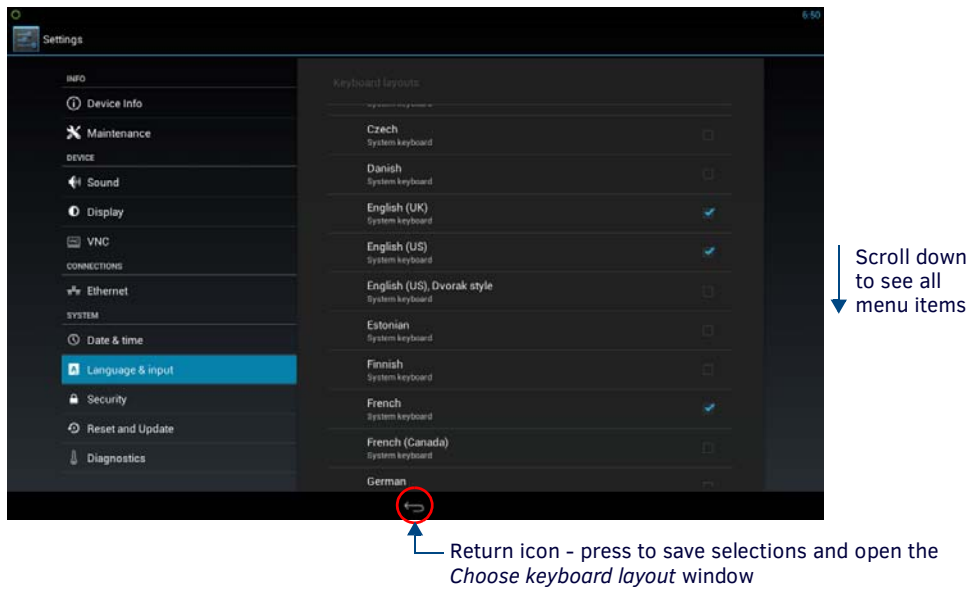

FIG. 97 Keyboard Layout window (indicating three layouts selected)

7. Select the desired keyboard layout(s).
The selected layouts will be available for selection via the *Choose Input Method* window (select **Default** under **KEYBOARD & INPUT METHODS** to access).
8. Press the return icon to close the *Keyboard Layouts* window and open the *Choose Keyboard Layout* window (FIG. 98):

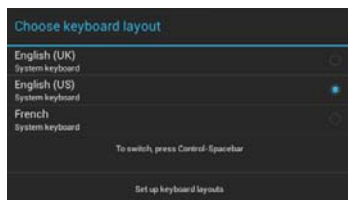

FIG. 98 Choose Keyboard Layout window

9. Select the desired layout (or press outside of the window to close the *Choose Keyboard Layout* window without changing the selection) to return to the *Keyboard Options* window (FIG. 94 on page 55).

Changing the Pointer Speed

1. Under **MOUSE/TRACKPAD**, press **Pointer Speed** to open the Pointer Speed window (FIG. 99):

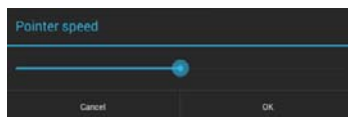

FIG. 99 Pointer Speed window

2. Use the slide bar to choose the preferred speed.
3. Press **OK** to save changes and close this window.

SYSTEM - Security

The *Security* page (FIG. 100) sets the admin password for this panel, and allows for the management of CA certificates.

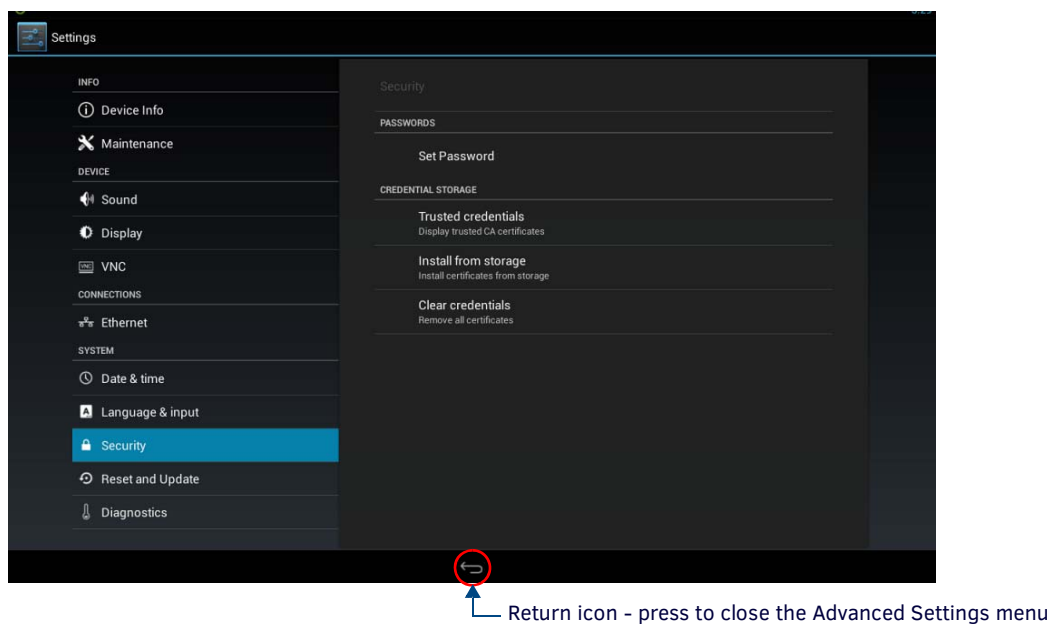

FIG. 100 Security page

Security page options	
PASSWORDS	
Set Password:	Specify the default admin password for this panel. See the <i>Setting a Password for This Panel</i> section on page 57 for details.
CREDENTIAL STORAGE	
Trusted Credentials	Press this option to view a listing of all trusted CA certificates currently loaded on this panel (SYSTEM level certificates and USER level certificates). See the <i>Viewing Trusted CA Certificates (System/User)</i> section on page 58 for details.
Install from Storage	Press this option to install CA Certificates on this panel via USB. See the <i>Installing Certificates</i> section on page 60 for details.
Clear Credentials	Press this option to clear all credentials from this panel. See the <i>Clearing Credentials</i> section on page 60 for details.

Setting a Password for This Panel

1. In the Security page, press **Set Password** to invoke the *Enter Password* dialog (FIG. 101):

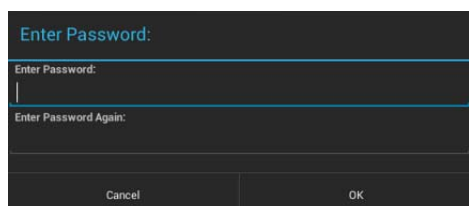

FIG. 101 Enter Password dialog

2. Enter the new password in the first text field.
3. Enter the new password again in the second text field.
4. Press **OK** to close this dialog and save the new password.

Viewing Trusted CA Certificates (System/User)

1. In the Security page, under CREDENTIAL STORAGE, press **Trusted Credentials** to invoke the *Trusted Credentials* page (FIG. 101):

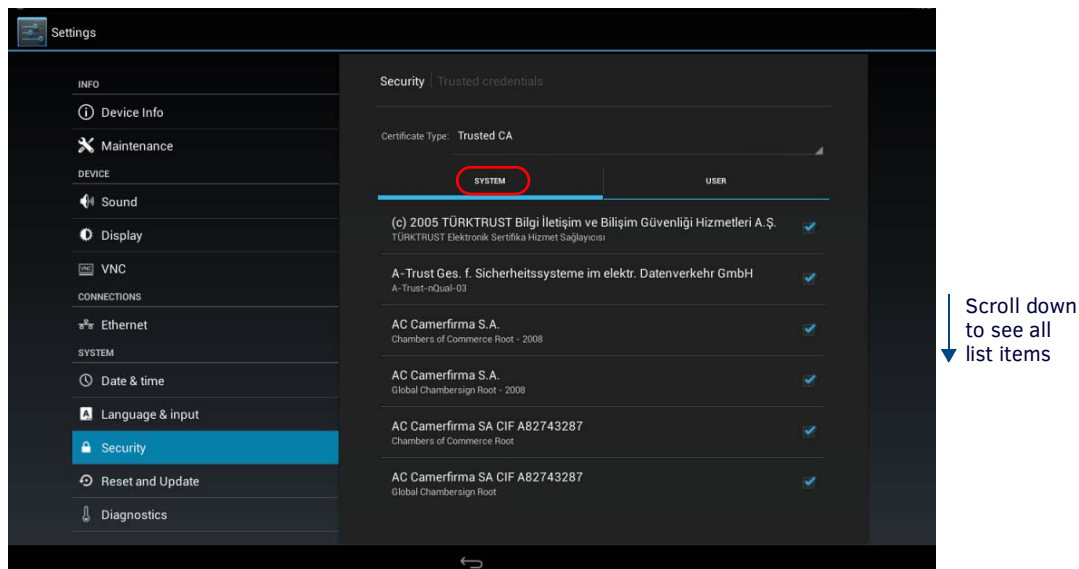

FIG. 102 Trusted Credentials page - SYSTEM list

The listing of trusted CA certificates is separated into two categories: *System* and *User*. The initial view of the *Trusted Credentials* page is the SYSTEM list (an example is shown in FIG. 102).

NOTE: *It may be necessary to scroll down to view the entire list.*

To view a listing of User-level certificates currently loaded on this panel, press USER in the *Trusted Credentials* page (FIG. 103):

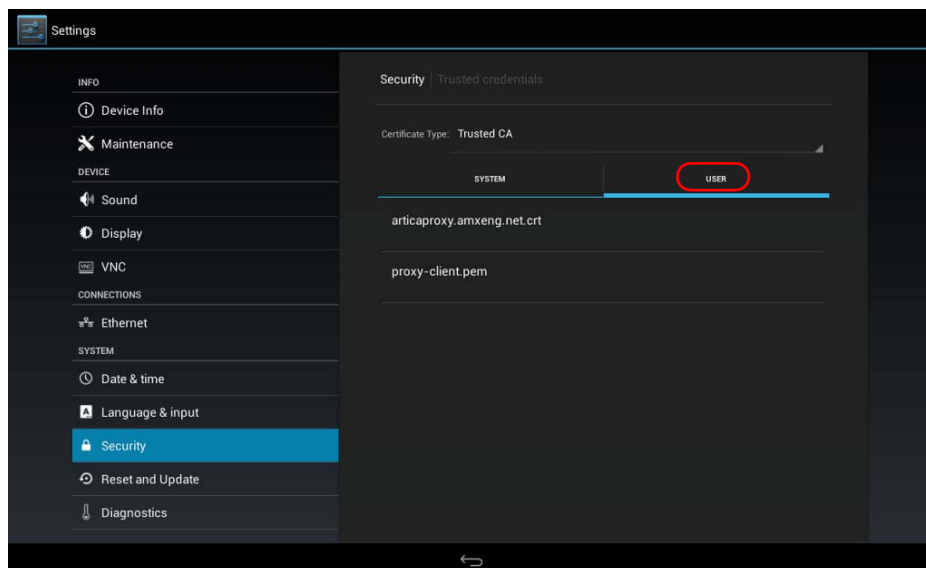

FIG. 103 Trusted Credentials page - USER list

Disabling and Enabling Trusted CA Certificates

System certificates that are currently enabled are indicated with a blue checkmark. Note that by default, all installed certificates are enabled, as indicated in FIG. 104:

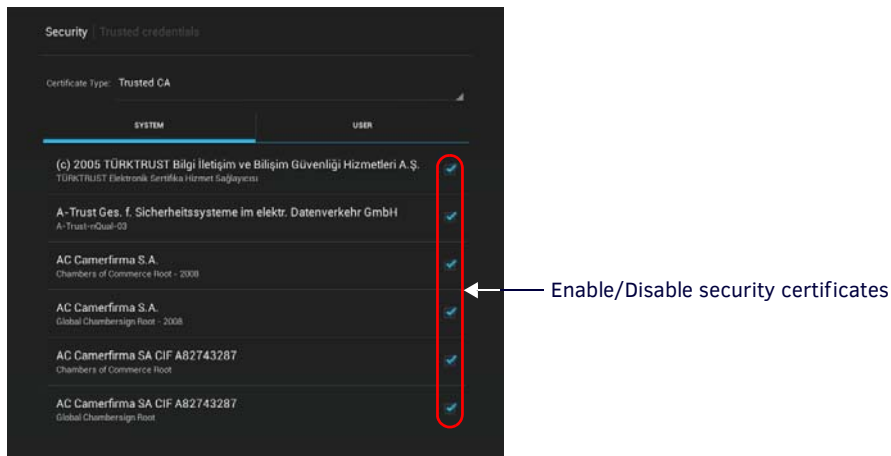

FIG. 104 System CA Certificates list - indicating all security certificates are enabled

To disable a system certificate, press to select a system certificate. This invokes the *Security certificate details* dialog for the selected certificate. An example is shown in FIG. 105:

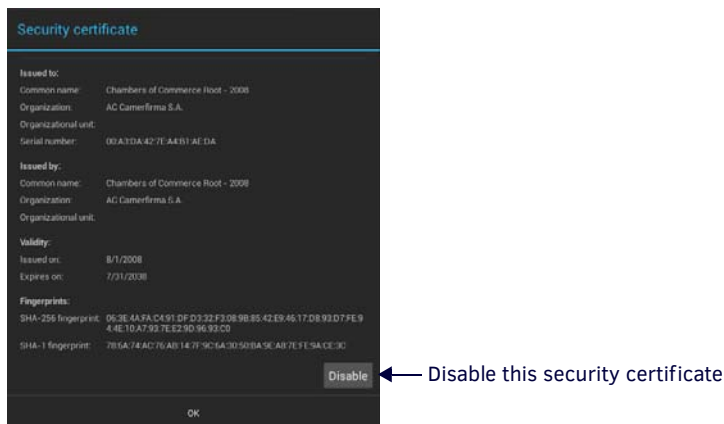

FIG. 105 Example Security certificate details dialog

To disable this system certificate, press the **Disable** button. The panel will prompt you to verify this action (press **OK** to proceed):

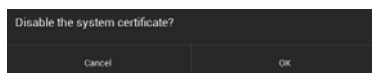

FIG. 106 Disabling a System Certificate

FIG. 107 shows an example of a disabled system certificate (FIG. 107):

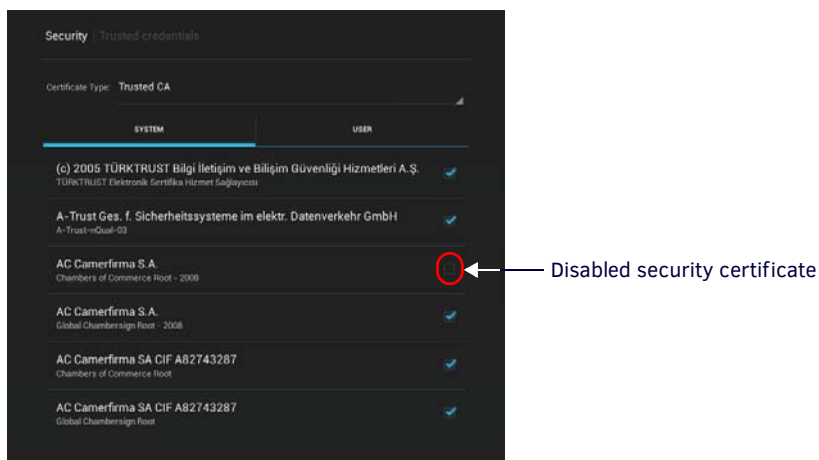

FIG. 107 System CA Certificates list - indicating all security certificates are enabled

NOTE: Disabled system certificates can be enabled later; disabled system certificates are not cleared from the panel (see the *Clearing Credentials* section on page 60).

To enable a system certificate, select a disabled system certificate. This invokes the *Security certificate details* dialog for the selected certificate. An example is shown in FIG. 105:

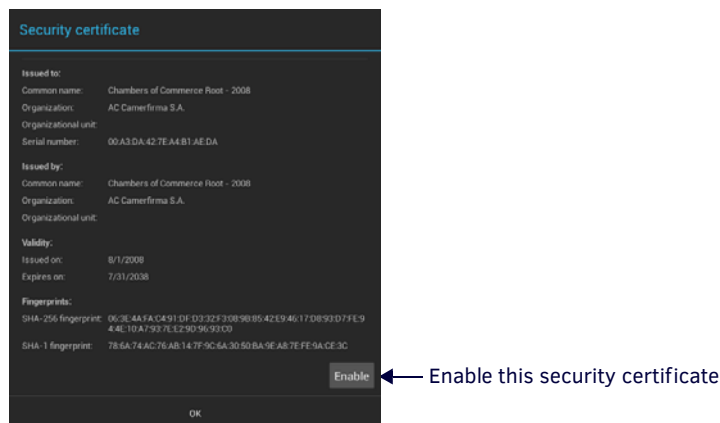

FIG. 108 Example Security certificate details dialog (for a disabled system certificate)

To enable this system certificate, press the **Enable** button. The panel will prompt you to verify this action (press **OK** to proceed):

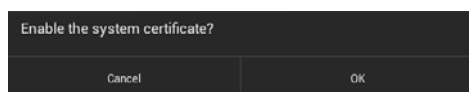

FIG. 109 Enabling a System Certificate

Installing Certificates

System certificates can be installed to the panel via USB, using the *Install From Storage* option on the Security Settings page.

- System certificates can be used with Microsoft Exchange and Office 365 Calendar setups (see FIG. 25 on page 24).
 - Supported certificate file extensions are: *.crt, *.pem and *.der.
1. Insert an external USB storage device into the USB port on the Acendo Book panel.

NOTE: The USB port extends from the bottom of the panel (see FIG. 19 on page 20 and FIG. 20 on page 21).
 2. In the Security page, under CREDENTIAL STORAGE (see FIG. 100 on page 57), press **Install From Storage** to invoke the *Certificate File Browser* page (FIG. 110):

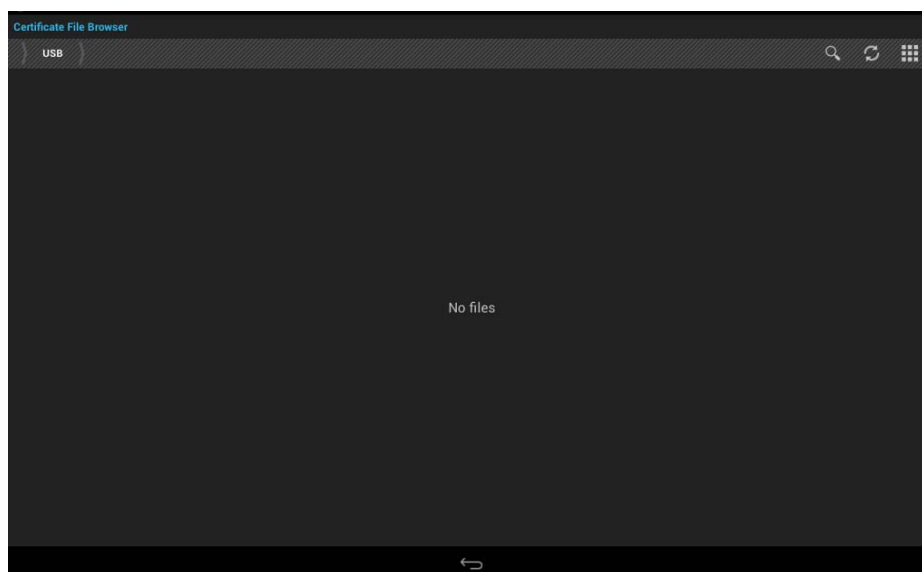

FIG. 110 Certificate File Browser page

Clearing Credentials

To clear all security credentials (CA certificates) from this Acendo Book Panel:

1. In the Security page, press **Clear Credentials**.
2. The panel will prompt you to verify this action (FIG. 111):

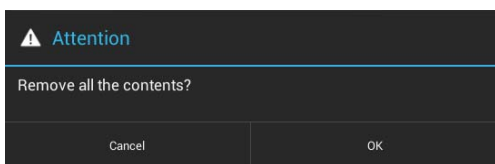
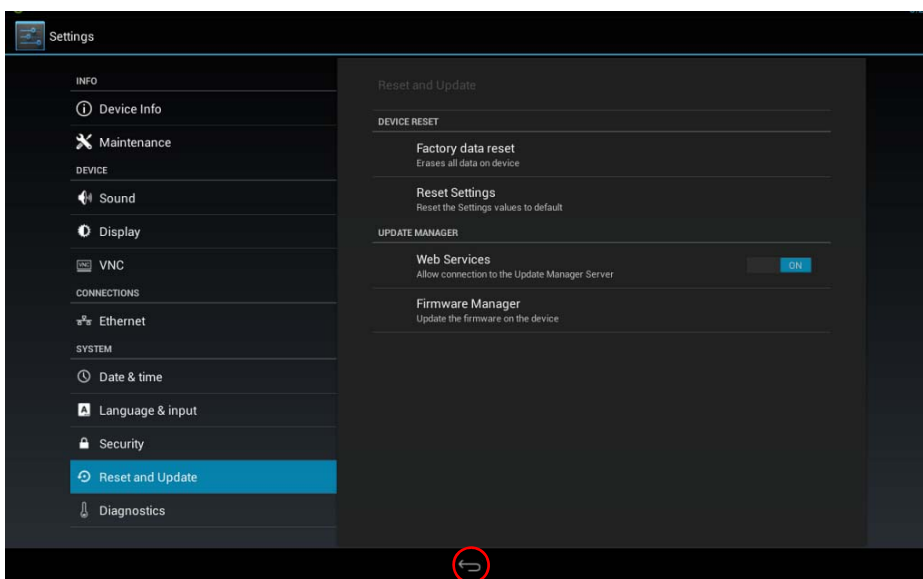

FIG. 111 Verify Clearing Credentials from this panel

3. Press **OK** to proceed (or press *Cancel* to return to the Security page without clearing credentials).

SYSTEM - Reset and Update

The *Reset and Update* page (FIG. 112) allows resetting and updating of panel settings and firmware, including installation of new firmware from an external drive.



Return icon - press to close the Advanced Settings menu

FIG. 112 Reset and Update page

Reset and Update page options	
DEVICE RESET	
Factory Data Reset	Erases all data on the panel and resets the panel back to it's factory default settings. See <i>Factory Data Reset</i> on page 61 for details.
Reset Settings	Select to revert the panel back to its default settings, but does not erase all data from the panel. Note that the panel will be rebooted. See <i>Reset Settings</i> on page 62 for details.
UPDATE MANAGER	
Web Services	Use this switch to toggle Update Manager Web Services on the panel: If this switch is on, the Update Manager will attempt to connect to the Update Manager Server (hosted on amx.com). If the switch is off, then the Update Manager will not attempt to connect to the Update Manager Server.
Firmware Manager	Select to open the <i>Firmware Manager</i> page. Use the options on this page to update the firmware on the panel. See the <i>Firmware Manager</i> section on page 62 for details.

Factory Data Reset

To reset the panel to its factory defaults and remove all data stored in the panel (including user pages):

1. Under *DEVICE RESET*, press **Factory Data Reset** to open the *Factory Data Reset* window (FIG. 113).



FIG. 113 Factory Data Reset window

To return to the *Reset and Update* page without making any changes, press *Reset and Update*.

2. To erase all data from the panel, press **Reset Device**.

NOTE: *The Scheduling Panel Setup Wizard will be launched again if a Factory Data Reset is performed on the panel (see page 22).*

Reset Settings

To reset the Settings values to their default values:

1. Under *DEVICE RESET*, press **Reset Settings**.
2. The panel will prompt you to verify this action (FIG. 114):.

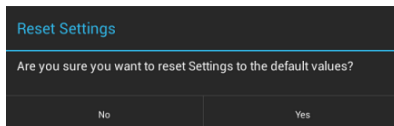

FIG. 114 Reset Settings prompt window

3. Press **Yes** to proceed. To return to the Reset and Update page without saving any changes, press *No*.

NOTE: *The Scheduling Panel Setup Wizard will be launched again if a Reset Settings is performed on the panel (see page 22).*

Enable/Disable Web Services

This option enables/disables Web Services on this Acendo Book panel (FIG. 115): .

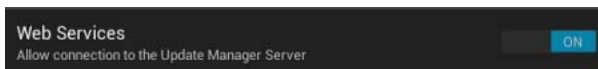

FIG. 115 UPDATE MANAGER - Web Services option

Web Services allow the Acendo Book panel to connect to the Update Manager server, to receive firmware updates from www.amx.com. By default, this option is *enabled (ON)*.

To disable Web Services on this panel, toggle this option to **OFF**.

Firmware Manager

Select **Firmware Manager** under UPDATE MANAGER in the *Reset and Update* page to access the *Firmware Manager* page (FIG. 116):

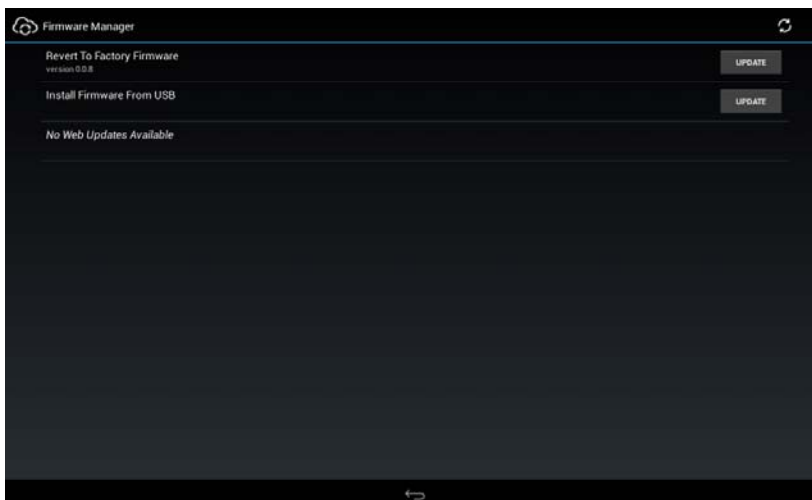

FIG. 116 Firmware Manager page

Reverting to Factory-Installed Firmware

In certain circumstances, it may be necessary to uninstall the current firmware on a panel and return it to the original factory default firmware. To reset the panel to its original factory firmware:

1. From the *Firmware Manager* window, select **UPDATE** next to *Revert to Factory Firmware* (FIG. 117):



FIG. 117 Firmware Manager - Revert To Factory Firmware

2. A System Message window is displayed that indicates the factory firmware version that will be installed, and prompting you to verify this action (FIG. 118):

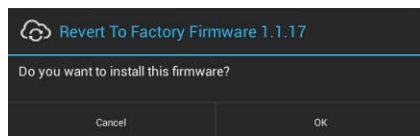

FIG. 118 System Prompt - Revert To Factory Firmware?

3. Select **OK** to install the previous firmware version and **Cancel** to return to the *Firmware Manager*.
4. If you choose **OK**, the panel will reboot and restart with the factory installed firmware.

NOTE: *Resetting the panel to its original factory firmware will remove all updates made to the Settings menu since that version.*

Installing New Firmware From An External USB Stick

To install new firmware to the panel from a USB stick:

1. Download the latest Acendo Book panel firmware from www.amx.com and save it to a USB stick or other external drive with USB capability.

NOTE: *The firmware can be saved at the root directory, or be saved in a folder in the USB stick directory. The folder name is not case sensitive.*
2. Insert the USB stick into an available USB port. This may require disassembling wall-mounted panels to access the USB ports if a USB extension was not already installed.
3. From the *Firmware Manager* window (FIG. 116 on page 62), select **UPDATE** next to *Install Firmware from USB* (FIG. 119):



FIG. 119 Firmware Manager - Install Firmware from USB

4. The *KIT File Browser* window presents a listing of firmware available on the USB stick (FIG. 120):

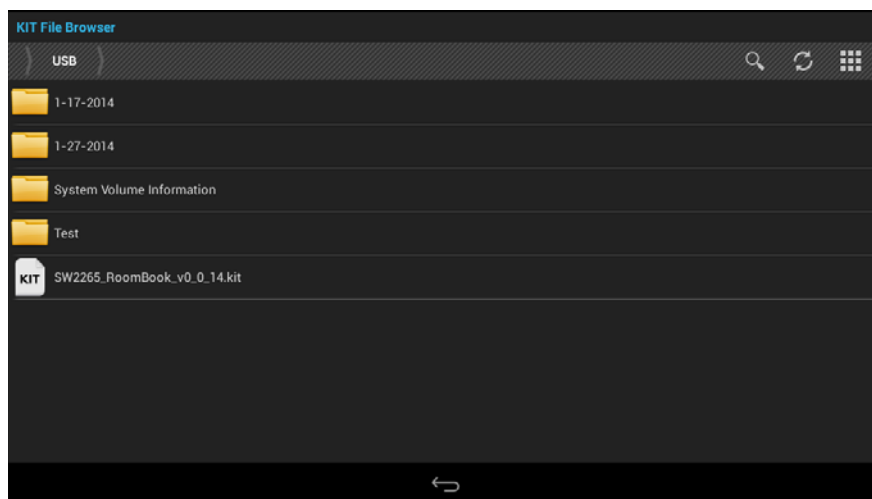

FIG. 120 KIT File Browser window

5. Select the KIT file to be installed.
6. The panel will prompt you to verify this action. Press **OK** to proceed (FIG. 121): .

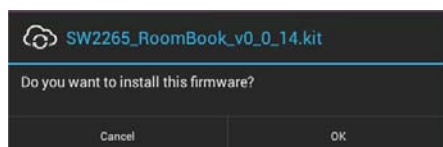

FIG. 121 Verify Firmware Installation

- The panel will upload the new firmware (FIG. 122) and then reboot.



FIG. 122 Update Progress display

Install Firmware From Web

This option provides the ability to download new panel firmware from AMX, and install it on the Acendo Book panel.

If a firmware update is available for the panel, the *Install Firmware From Web* option is presented on the Firmware Manager page (see FIG. 116 on page 62), indicating the firmware version that is available to download from AMX and install on the Acendo Book panel.

NOTE: *If this option is not included on the Firmware Manager page, this panel already has the most recent firmware.*

To install new firmware to the panel from the web:

- From the *Firmware Manager* window (FIG. 116 on page 62), select **UPDATE** next to *Install Firmware from Web* (FIG. 123):



FIG. 123 Firmware Manager - Install Firmware from Web

NOTE: *Press README to view any notes associated with the selected firmware file (press Close to close the README window).*

- The panel will prompt you to verify this action - Press **OK** to proceed with the update (FIG. 124):

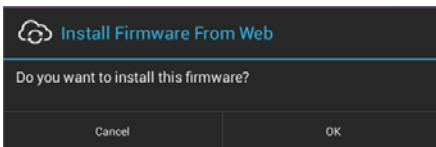

FIG. 124 System Prompt - Install Firmware From Web

- The progress of the download is indicated on the *Firmware Manager* page (FIG. 125).

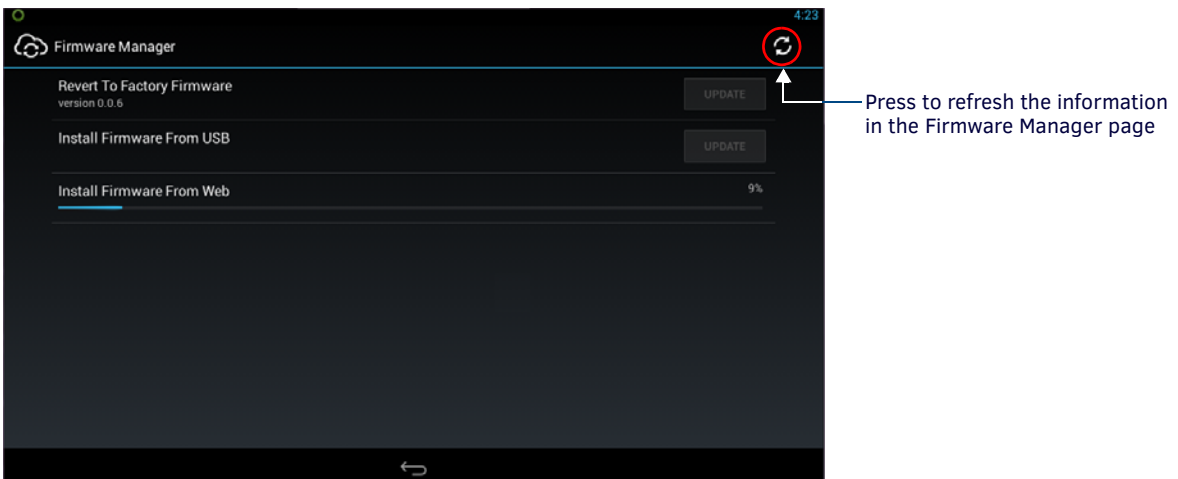

FIG. 125 Firmware Manager page - Install Firmware From Web (in progress)

NOTE: *Press the Refresh icon to refresh the information on this page, if necessary.*

- The firmware update will begin the install process (FIG. 126):

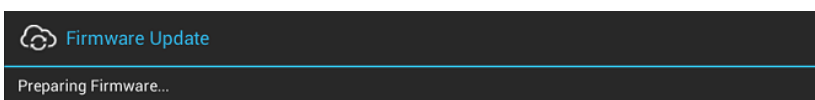

FIG. 126 Firmware Update - Preparing Firmware

- After copying the firmware package to the staging location, the panel will reboot and complete the firmware installation process (FIG. 127):

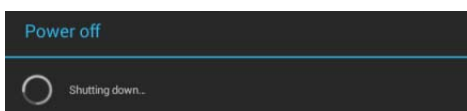

FIG. 127 Firmware Update - reboot and complete firmware update

Using AMX System Recovery

During a normal firmware upgrade, if a Acendo Book panel is unable to boot all the way, *AMX System Recovery* can be used to try to reset system data or re-install firmware. To initiate system recovery:

1. Power up the panel while holding the **Sleep/Settings** button.
2. Release the button 3 seconds after seeing the AMX boot logo, and wait a few seconds for recovery mode to begin.
3. A text screen titled "AMX System Recovery" is displayed, presenting the following options:
 - Reboot Device
 - Factory Data Reset
 - Revert to Factory Firmware
 - Install Firmware from USB
4. Navigate the menu options by pressing the **Sleep/Settings** button.

To select an item, press and hold the Sleep/Settings button for 2 or more seconds. Alternatively, if the panel has a USB keyboard plugged in at bootup, use the *Up/Down* arrows and *Enter* keys to navigate the menus.

- Select **Reboot Device** to reboot the panel.
- Select **Factory Data Reset** and then select **Yes** on the confirmation window to erase all of the user data (settings, application data, user pages) on the panel.
- Select **Revert to Factory Firmware** and then select **Yes** on the confirmation window for the system to extract the factory firmware (this can take a minute) and then automatically initiate a firmware upgrade as usual.
- Select **Install Firmware from USB** for a new menu to come up, where the user can navigate the files on the USB drive. Selecting the "../" entry will take the user back to the previous directory. Entries with a trailing "/" on the name are directories, and selecting a directory will bring up a new menu with the contents of that directory shown. All other entries will be ".kit" files. Selecting a KIT file and selecting **Yes** on the confirmation screen will extract the firmware (this can take a minute) and then automatically initiate a firmware upgrade as usual.

SYSTEM - Diagnostics

The *Diagnostics* page (FIG. 128) displays the current processor temperature and provides access to panel logs.

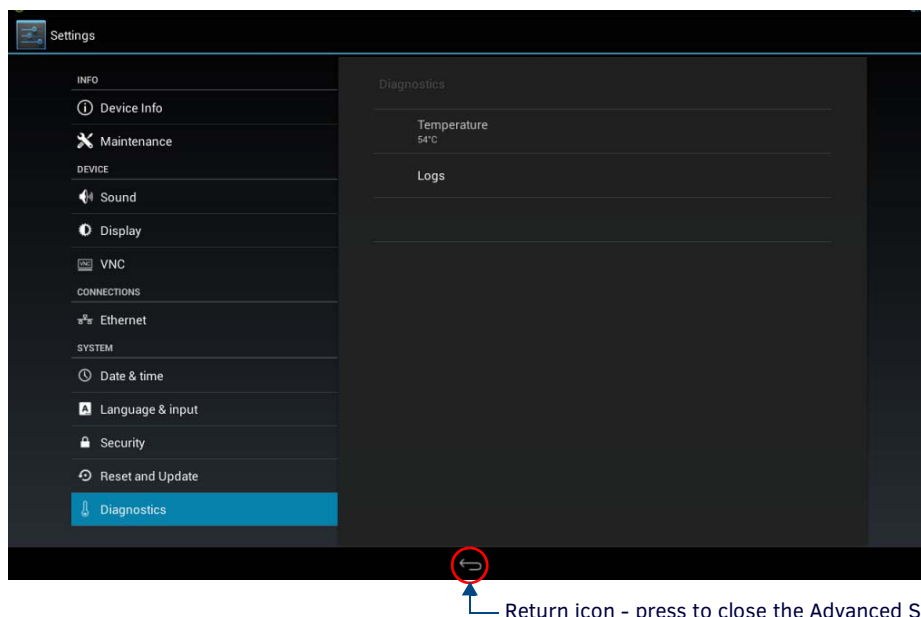

Return icon - press to close the Advanced Settings menu

FIG. 128 Diagnostics page

Diagnostics page options	
Temperature	Displays the current temperature of the panel in Celsius.
Logs	Select this option to display the panel logs.

The *Logs* window chronicles all previous connections between the panel and the network. To access the *Logs* window, select *Logs* in the *Diagnostics* page.

Acendo Book Scheduling Panels - User Guide

Overview

This section describes using Acendo Book Touch Panels that have been installed and configured. In this section, "Room" refers to the Room associated with a Acendo Book panel.

Room Available Page

If the Room is currently available, the *Room Available* page is displayed (FIG. 129):

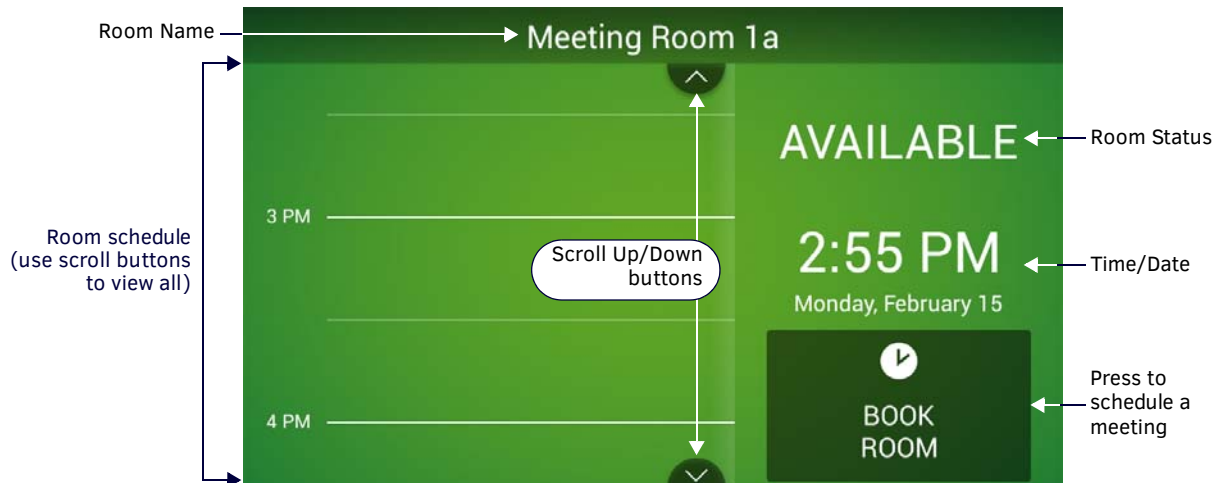

FIG. 129 Room Page - AVAILABLE

When the Room Available Page is displayed, the Room Status LEDs light green, unless the LEDs have been disabled via the "Room Status LED" option in the Room setup page (see the *Viewing/Editing Room Settings* section on page 42).

NOTE: Room Status may not be shown if a custom logo is in use.

Room Occupied Page

If the Room is currently in use for a scheduled meeting, the *Room Occupied* page is displayed.

The information and options displayed are identical to the ROOM AVAILABLE page - the only difference is the red color scheme (FIG. 130):



FIG. 130 Room page - OCCUPIED

When the Room Occupied Page is displayed, the Room Status LEDs light red, unless the LEDs have been disabled via the "Room Status LED" option in the Room setup page (see the *Viewing/Editing Room Settings* section on page 42).

Scheduling an Ad-Hoc Meeting

If the room is available, an ad-hoc meeting can be scheduled to start immediately:

1. In the Room Available page, press **BOOK ROOM** (FIG. 131):

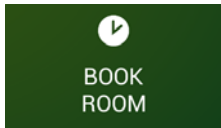

FIG. 131 BOOK ROOM button

2. This invokes the BOOK ROOM page. Use the options in this page to change the default settings, as desired. By default, ad-hoc meetings are set to start immediately, and last for 30 minutes (FIG. 132):

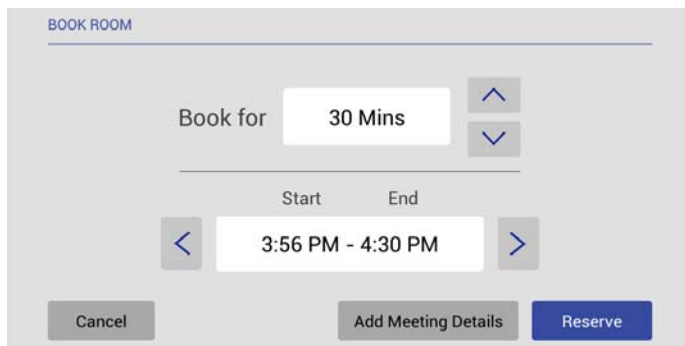

FIG. 132 BOOK ROOM page

- Use the **Book for** Up/Down arrows to adjust the duration of the meeting (if necessary).
 - Use the **Start/End** Left/Right arrows to adjust the start time of the meeting (if necessary).
3. Press **Reserve** to reserve this room for the time allotted.
 4. If prompted, enter the *Meeting PIN Code* (FIG. 133):

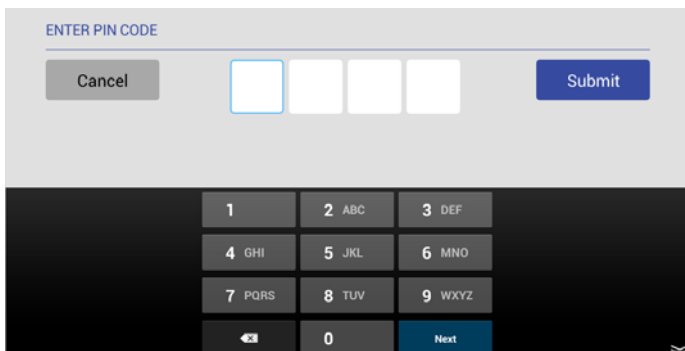

FIG. 133 ENTER PIN CODE

Note: The Meeting PIN Code is only required if the "Meeting PIN Code" option is enabled in the Security setup page.

The Meeting PIN Code is set on the Security Setup page as well (see page 33 for details).

5. Press **Submit** to reserve the meeting.
6. Once the meeting has been added to the calendar, the Room page is changed to indicate that it is currently **OCCUPIED** (FIG. 134):

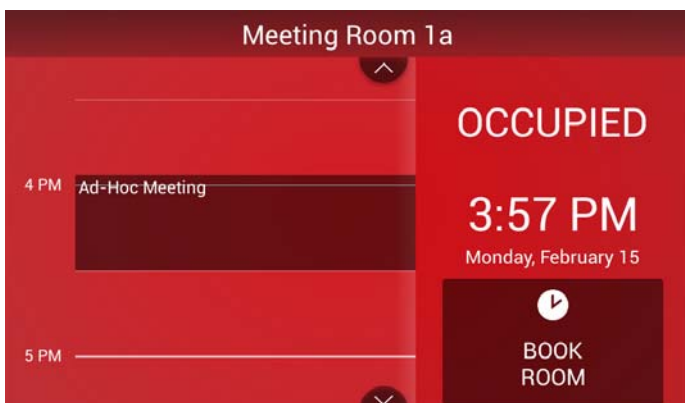

FIG. 134 Room page (OCCUPIED)

Scheduling a Meeting for Later

To schedule a meeting for later in the day:

1. In the Room page, press **BOOK ROOM** (FIG. 135):



FIG. 135 BOOK ROOM button

NOTE: Meetings can be scheduled for a later time, regardless of whether the room is currently AVAILABLE or OCCUPIED.

2. This invokes the BOOK ROOM page. Use the options in this page to change the default settings, as desired. By default, meetings are set to last for 30 minutes (FIG. 132):

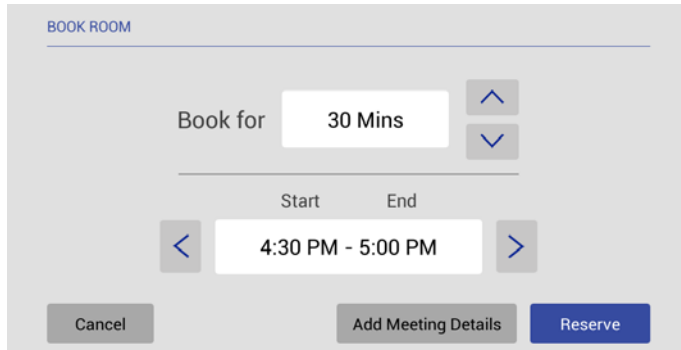

FIG. 136 BOOK ROOM page

3. Press **Add Meeting Details** to open the ADD MEETING DETAILS page (FIG. 137):

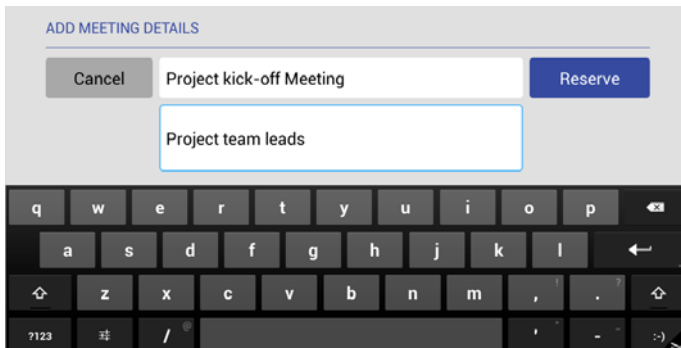

FIG. 137 ADD MEETING DETAILS page

4. Press **Reserve** to reserve the meeting as specified.
5. If prompted, enter the *Meeting PIN Code* (FIG. 138):



FIG. 138 ENTER PIN CODE

6. Press **Submit** to reserve the meeting.
7. Once the meeting has been added to the calendar, it is represented on the Room page (FIG. 139):

Note: The Meeting PIN Code is only required if the "Meeting PIN Code" option is enabled in the Security setup page.

The Meeting PIN Code is set on the Security Setup page as well (see page 33 for details).

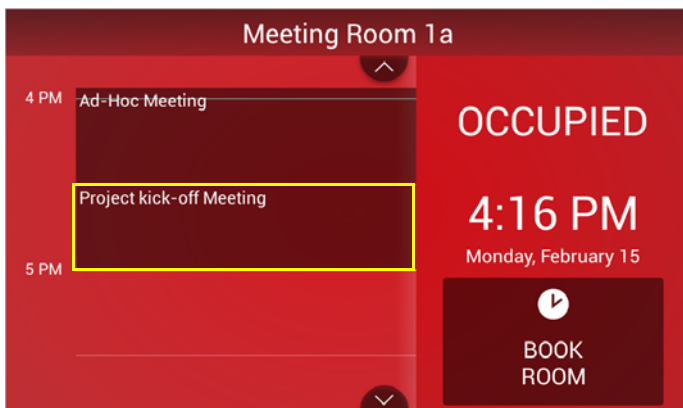

FIG. 139 Room page

Browse Rooms for Scheduling

If this panel is part of a Group, the BROWSE ROOMS option allows you to browse other Acendo Book panels in the same Scheduling Group to check for availability. Other panels/rooms in the Group that are available can be scheduled from any panel in the group.

BROWSE ROOMS Button

- The *BROWSE ROOMS* button is always displayed on panels that are configured as a *Member* panel of a Scheduling Group (see *Viewing/Editing Group Settings* on page 41 for details on Scheduling Groups).
- If the device is configured as the *Master* panel of a Scheduling Group, the *BROWSE ROOMS* button is automatically removed if no Member panels have communicated with the Master panel for 5 minutes.

1. In the Room page, press **BROWSE ROOMS** (FIG. 140):

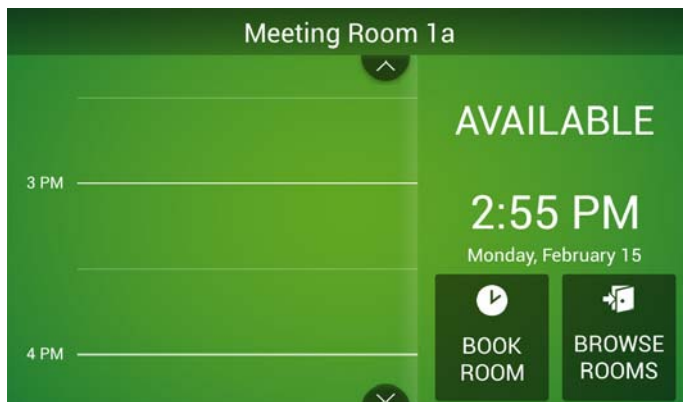

FIG. 140 BROWSE ROOMS button

2. The AVAILABLE ROOMS page displays a list of the other Acendo Book panels in the Scheduling Group that are available for booking immediately.

NOTE: Rooms in the Scheduling Group that are not available for booking at the current time will not show up in the AVAILABLE ROOMS list, even though they may be available later.

The example in FIG. 141 shows that there are several other Acendo Book panels in the group, three of which are available for booking right now:

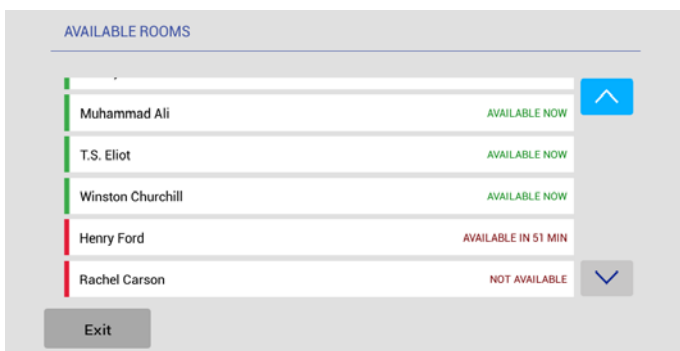

FIG. 141 AVAILABLE ROOMS page

Note that the AVAILABLE ROOMS page uses color coding to indicate which rooms in the group are currently available for booking (**AVAILABLE NOW** in green). Rooms that are unavailable at the moment indicate when they will be available for booking (**AVAILABLE IN XX MIN** in red). Rooms that are unavailable the rest of the day are listed as **NOT AVAILABLE** (in red).

3. Press one of the rooms in the list to reserve or schedule a meeting in that room. This invokes the BOOK ROOM page (FIG. 142). Use the options in this page to set the meeting duration, start/end times, add meeting details, and reserve the room for the specified time:

FIG. 142 BOOK ROOM page

- a. **Book for** - Use the up/down arrow buttons to adjust the length of the meeting reservation (default = 15 minutes).
- b. **Start/End** - Use the left/right arrow buttons to set the Start and End time of the meeting reservation (based on the specified *Book for* value).
- c. **Add Meeting Details** - Press to open the ADD MEETING DETAILS page to enter a *Subject* and *Comments* for the meeting (FIG. 143):

FIG. 143 ADD MEETING DETAILS page

NOTE: The Add Meeting Details option will not be available if Privacy Mode is enabled.

- d. Press **RESERVE** to add this meeting to the selected panel's schedule.

Viewing/Editing Meeting Details

Press on any scheduled meeting on the Room Page to open the MEETING DETAILS page for the selected meeting (FIG. 144):

FIG. 144 MEETING DETAILS page

This page indicates the current Title, Start/End Times and Comments associated with the selected meeting. The buttons along the bottom of this page allow you edit the selected meeting's Meeting Details, Start/End Time, as well as to delete this meeting from the calendar.

- If Privacy Mode is on, *Meeting Organizer* and *Comments* are not displayed,
- If Privacy Mode is on, the *Edit Meeting Details* button is not provided.
- If the meeting was NOT scheduled via the Acendo Book panel (i.e. directly via the Email/Web client software), the *Edit Meeting Details*, *Edit Meeting Time* and *Delete* buttons are disabled.

Editing Meeting Details

1. In the MEETING DETAILS page, press **Edit Meeting Details** to open the EDIT MEETING DETAILS page (FIG. 145):

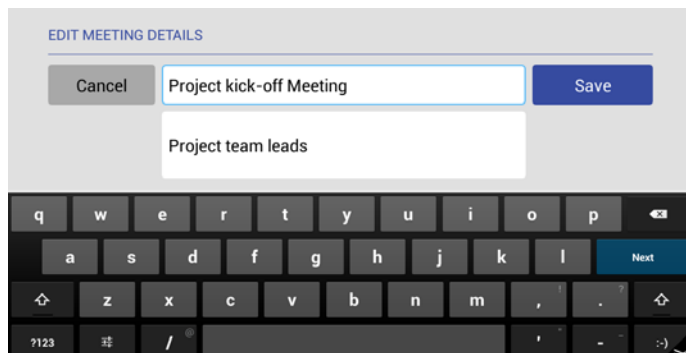

FIG. 145 EDIT MEETING DETAILS page

2. Press inside the first text field to edit the *Meeting Title* text via the on-screen keyboard.
3. Press inside the second text field to edit the *Meeting Details* text via the on-screen keyboard.
4. Press **Save** to save changes.
5. If prompted, enter the *Meeting PIN Code* in the ENTER PIN CODE page (FIG. 146):

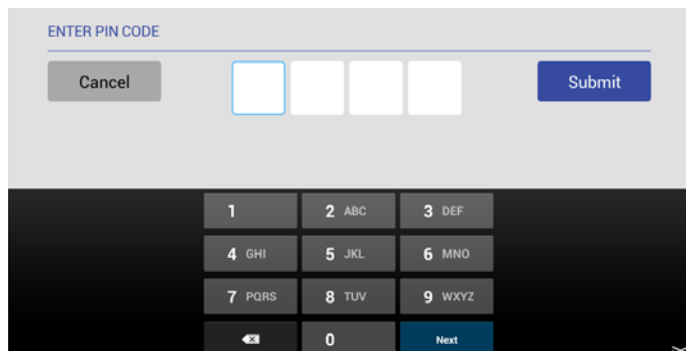

FIG. 146 ENTER PIN CODE page

Note: The Meeting PIN Code is only required if the "Meeting PIN Code" option is enabled in the Security setup page.

The Meeting PIN Code is set on the Security Setup page as well (see page 33 for details).

6. Press **Submit** to return to the Room page.
Edits made for the selected meeting are reflected in the updated calendar.

Editing Meeting Times

1. In the MEETING DETAILS page, press **Edit Meeting Time** to open the EDIT MEETING TIME page (FIG. 147):

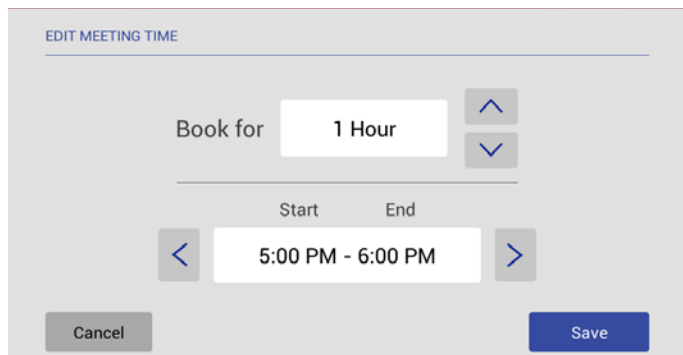

FIG. 147 EDIT MEETING TIME page

2. Press **Save** to save changes.

3. If prompted, enter the *Meeting PIN Code* in the ENTER PIN CODE page (FIG. 148):

Note: The Meeting PIN Code is only required if the "Meeting PIN Code" option is enabled in the Security setup page.

The Meeting PIN Code is set on the Security Setup page as well (see page 33 for details).

FIG. 148 ENTER PIN CODE page

4. Press **Submit** to return to the Room page.
Edits made for the selected meeting are reflected in the updated calendar.

Deleting a Meeting From the Calendar

1. In the MEETING DETAILS page, press **Delete** to open the DELETE MEETING (FIG. 149):

FIG. 149 DELETE MEETING page

2. Press **OK** to proceed.
3. If prompted, enter the *Meeting PIN Code* in the ENTER PIN CODE page (FIG. 150):

Note: The Meeting PIN Code is only required if the "Meeting PIN Code" option is enabled in the Security setup page.

The Meeting PIN Code is set on the Security Setup page as well (see page 33 for details).

FIG. 150 ENTER PIN CODE page

4. Press **Submit** to return to the Room page.
The selected meeting is removed from the updated calendar (FIG. 151):

FIG. 151 Room page

Appendix A: Troubleshooting

Overview

This section provides information to help address several potential issues relative to Acendo Book Scheduling panels and supported Scheduling services. Please check these topics before contacting AMX Technical Support.

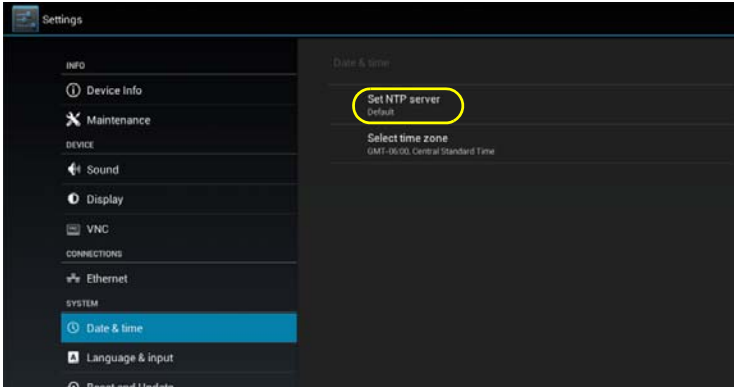
Acendo Book Scheduling Panels - Troubleshooting Topics	
Problem	Possible Solution(s)
<p>NO CALENDAR SERVER CONNECTION DETECTED - Username and Password</p> <p>Meeting Room 1a</p> <p>NO CALENDAR SERVER CONNECTION DETECTED</p> <p>Please check Username and Password.</p> <p>Contact Administrator to restore connection. Customer Support: 555-624-0000</p>	<ul style="list-style-type: none"> Calendar Settings - Review the current Calendar settings (Username with domain, Password and Room account with domain). See <i>Viewing/Editing Calendar Settings</i> on page 39), and verify that the settings are correct. Service Account Properties and Configuration - Review the Google Service account configuration. See <i>Appendix D: Configuring Google Resources</i> on page 82.
<p>NO CALENDAR SERVER CONNECTION DETECTED - SSL Certificate Time Validation</p> <p>Meeting Room</p> <p>NO CALENDAR SERVER CONNECTION DETECTED</p> <p>SSL Certificate time validation error.</p> <p>Contact Administrator to restore connection. Chris: 222-252-2525</p> <p><i>This error indicates that the SSL certificate did not pass the date/time validation check, typically because the time on the Acendo Book Scheduling Panel is incorrect - this can cause the certificate to appear to have expired.</i></p>	<p>Verify that the current network configuration allows the panel to access the NTP Server specified on the panel.</p> <p>NTP-related settings are made via <i>Advanced Settings</i> on the panel (see the <i>Advanced Settings</i> section on page 43). In the <i>Settings</i> menu, select SYSTEM > Date & Time to access the <i>Set NTP Server</i> and <i>Select Time Zone</i> settings:</p>  <p>Check the current date/time. Time is displayed in the top right corner of each Advanced Settings page. If the time is incorrect, check the Set NTP Server setting:</p> <ul style="list-style-type: none"> If Default is selected, verify that the current network configuration is allowing NTP through the firewall. If Custom is selected, verify that: <ul style="list-style-type: none"> the specified URL is valid the specified NTP server is online the current network configuration is allowing NTP through the firewall
<p>Exchange: Intermittent issues connecting to calendar server'</p> <p>SSH logs show "The request failed. The server cannot service this request right now. Try again later:"</p>	<p>Exchange throttling parameters may need to be adjusted.</p>

Acendo Book Scheduling Panels - Troubleshooting Topics (Cont.)	
Problem	Possible Solution(s)
<p>Exchange: Meeting Reservation Not Indicated on the Panel (No Error Message)</p> <p><i>When reserving a meeting (in Exchange), the meeting never shows up on the Acendo Book panel, and the panel is not indicating an error.</i></p>	<p>The Exchange Administrator should create a Service Account and Room Delegate, and enable "Auto Accept" for meeting reservations from an Acendo Book panel, as described below:</p> <p>1) Creating a Service Account</p> <p>This simply a user account. The following command creates the service account for the room:</p> <pre>New-Mailbox -Alias <alias> -Name <name> -FirstName <first> -LastName <last> -DisplayName <name> -UserPrincipalName <UPN> -ResetPasswordOnNextLogon \$false</pre> <p>2) Creating a Room Delegate</p> <p>The following command creates the new mailbox for the room:</p> <pre>New-Mailbox -Name <name> -Alias <alias> -UserPrincipalName <UPN> -FirstName <first> -LastName <last> -DisplayName <name> -Room}</pre> <p>The following command sets the various parameters for the previously created mailbox:</p> <pre>Set-CalendarProcessing -Identity <alias> -DeleteComments \$false -DeleteSubject \$false -DeleteNonCalendarItems \$false -AddOrganizerToSubject \$false -TentativePendingApproval \$false -AutomateProcessing AutoAccept -AllowRecurringMeetings \$true -BookingWindowInDays 1080 -AllRequestOutOfPolicy \$false -AddNewRequestsTentatively \$false -ProcessExternalMeetingMessages \$true</pre> <p>NOTE 1: In the case you want to set the ability to allow conflicting meeting requests to a room resource, you can use the <i>AllowConflicts</i> parameter with the <i>Set-CalendarProcessing</i> command. The <i>AllowConflicts</i> parameter specifies whether to allow conflicting meeting requests. Valid input for this parameter is <i>\$true</i> or <i>\$false</i>. The default value is <i>\$false</i>.</p> <p>NOTE 2: In the scenario that you do not want the recurring meetings rejected when they have an end date beyond the booking window; you will need to change the <i>AllowConflicts</i> parameter to <i>\$false</i>.</p> <ul style="list-style-type: none"> •When the <i>AllowConflicts</i> parameter is <i>\$true</i>, a recurring meeting request is automatically declined if the meetings start on or before the date specified by the <i>BookingWindowInDays</i> parameter, and the meetings extend beyond the specified date. •When the <i>AllowConflicts</i> parameter is <i>\$false</i>, a recurring meeting request is automatically accepted if the meetings start on or before the date specified by the <i>BookingWindowInDays</i> parameter, and the meetings extend beyond the specified date. However, the number of meetings is reduced so meetings won't occur after the specified date. •When <i>BookingWindowInDays</i> is 0, an end date isn't enforced for any recurring meetings. •When <i>BookingWindowInDays</i> is greater than 0 and <i>EnforceSchedulingHorizon</i> is <i>\$true</i>, the recurring meeting request is automatically declined if the end date is greater than the value specified by <i>BookingWindowInDays</i>. •When <i>BookingWindowInDays</i> is greater than 0 and <i>EnforceSchedulingHorizon</i> is <i>\$false</i>, the end date of a recurring meeting is automatically truncated to the value specified by <i>BookingWindowInDays</i>. The following command will change the default behavior: <pre>Set-CalendarProcessing -Identity <alias> -BookingWindowInDays 181 -EnforceSchedulingHorizon \$false</pre> <p>See Also:</p> <ul style="list-style-type: none"> •<i>Configuring Delegation (Exchange 2010)</i> on page 76 •<i>Using Exchange Admin Center (EMC)</i> on page 76 •<i>Using PowerShell</i> on page 77 <p>3) Configure the Room to Auto Accept</p> <p>The <i>AutomateProcessing</i> parameter enables or disables calendar processing on the mailbox, and <i>AutoUpdate</i> sets it so that only the Calendar Attendant processes meeting requests and responses.</p> <pre>Set-CalendarProcessing -Identity <alias> -AutomateProcessing AutoAccept</pre>

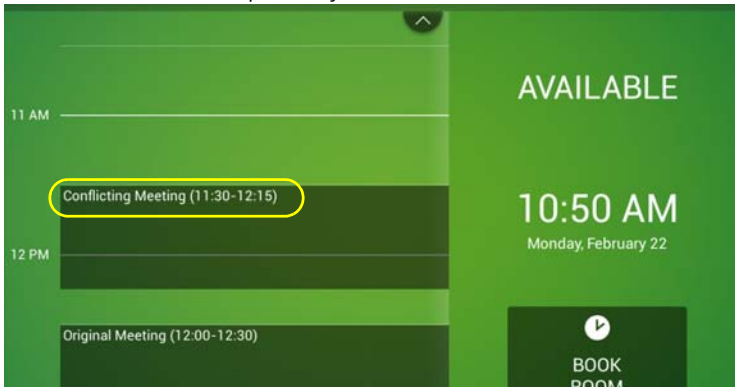
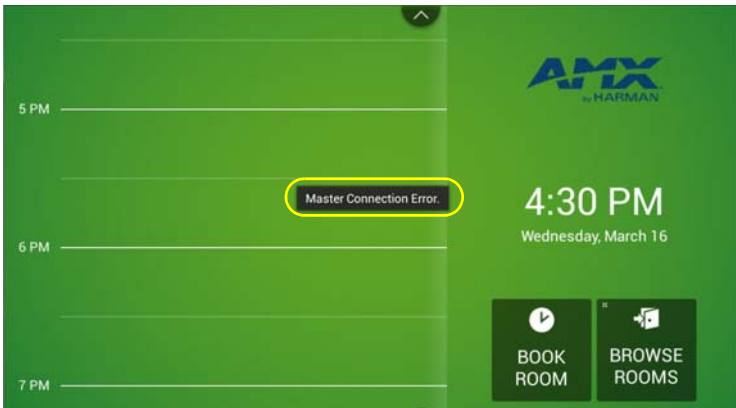
Acendo Book Scheduling Panels - Troubleshooting Topics (Cont.)	
Problem	Possible Solution(s)
<p>Exchange/Office 365: Conflicting Meetings Indicated at Incorrect Time <i>If a meeting is scheduled for a time that has already been reserved for a given room, it is a Conflicting Meeting.</i></p>	<p>If conflicts are allowed (in Exchange/Office 365), then conflicting meetings may be indicated at a time other than what was requested by the user.</p>  <p>To disable conflicts in Exchange/Office 365, verify that the <i>AllowConflicts</i> property is set to False for the room with which the Acendo Book panel is associated. Once disabled, conflicting meetings will be declined by the scheduling system.</p>
<p>Exchange/Office 365: The Meeting Subject shown on Acendo Book indicates the organizer of the meeting instead of the meeting subject</p>	<p>In order for the Acendo Book panel to be able to read the privacy mode flag, the Exchange resource's "--AddOrganizerToSubject" has to be set to \$false. By default, this is set to <i>\$true</i>.</p>
<p>Exchange/Office 365: Private meeting flag not detected by Acendo Book panel</p>	<p>the Exchange resource's "--RemovePrivateProperty" has to be set to \$false. By default, this is set to <i>\$true</i>.</p>
<p>Exchange/Office 365: Private meeting flag not updated when private flag is changed from checked to unchecked.</p>	<p>To change meeting from private to "visible", delete the meeting and re-enter it.</p>
<p>"Master Connection Error" Displayed <i>If the Master panel goes offline for any reason, the Master panel as well as all Member panels in the Scheduling Group display the Master Connection Error message.</i></p>	 <p>Check the connection status of the Master panel and verify that the network configuration. For example, has the Username, Password or IP Address of the Master Panel been changed? Once the Master panel is connected to the network, the Member panels should recover automatically.</p>
<p>(Google): Meetings Are Not Indicated on Room Page</p>	<p>Verify that the <i>Auto-accept invitations that do not conflict</i> property is selected for the room with which the Acendo Book panel is associated. See <i>Appendix D: Configuring Google Resources</i> on page 82 for details.</p>
<p>"Browse Rooms" Button Is Not Displayed On the Group Master <i>If the master device does not have a Browse Rooms button, then a Member panel has not checked in with the Master panel in the last 5 minutes.</i></p>	<p>Verify that the Member panels are online and configured with the Scheduling Group Master panel's IP, username, and password.</p>
<p>The panel is locked, and the admin password has been lost or forgotten</p>	<p>If the administrator forgets the Administrator password, the panel can be reset to return the password to the default value ("1988") via the <i>Factory Data Reset</i> option. <i>Note: In this event, all panel settings will be lost.</i> Refer to the <i>Using AMX System Recovery</i> section on page 65 for details.</p>

Acendo Book Scheduling Panels - Troubleshooting Topics (Cont.)

A room listed in the Available Rooms screen (after pressing Browse Rooms) is always listed as "NOT AVAILABLE".

All Acendo Book scheduling panels in a Group must have firmware version 1.1.x or higher. Scheduling panels running version 1.0.x will not show availability information correctly.

Configuring Delegation (Exchange 2010)

The following example illustrates configuring a delegate that can manage scheduling for the Room Mailbox:

1. In the *Resource Policy* tab of the mailbox Properties dialog, click **Add**
2. Select the user that will become a delegate of the Room Mailbox (FIG. 152):

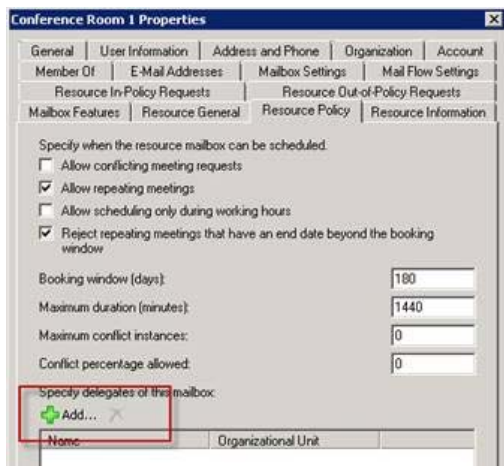

FIG. 152 Mailbox Properties dialog - Resource Profiles tab

Delegates also need Editor access to the calendar and free/busy folder of the mailbox itself so that they can manage meeting requests. There are two ways to achieve this:

- **Option 1:** Grant an administrator Full Access Permissions to the Room Mailbox, open it in Outlook, and edit the Calendar and Mailbox permissions.
- **Option 2:** Grant the delegate Full Access Permissions to the Room Mailbox

The following example uses Option #2:

```
Add-MailboxPermission -Identity "Delegation Room 1" -User rmsservice -AccessRights FullAccess
```

The delegate *rmsservice* can now manage room bookings.

The example in FIG. 153 indicates a meeting that is still unconfirmed, waiting for *rmsservice* to approve or reject it:

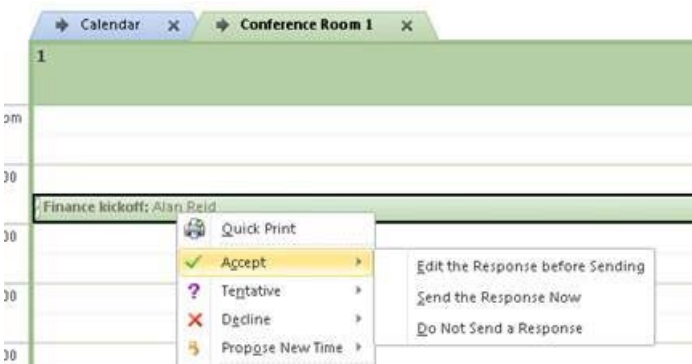

FIG. 153 Unconfirmed Meeting indicated (waiting for *rmsservice* to approve or reject)

After *rmsservice* approves the meeting the organizer (in this example - "Alan Reid") receives a message confirming acceptance.

Using Exchange Admin Center (EMC)

NOTE: You need to have permissions assigned before you can perform this procedure. To see what permissions are required, see the "Resource Mailbox Configuration Permissions" section in the Mailbox Permissions topic.

1. In the console tree, navigate to **Recipient Configuration > Mailbox**.
2. In the result pane, select the resource mailbox that you want to configure.
3. In the action pane, under the name of the resource mailbox, click **Properties**.
4. In **<Resource Mailbox Name> Properties**, click the *Resource Policy* tab.

5. Under *Specify delegates of this mailbox*, perform the following:
 - a. To add a resource delegate, click **Add**, and then select the recipient.
 - b. To remove a resource delegate, select the delegate, and then click **Remove**.
6. To forward all meeting requests to the delegates listed, select the **Forward meeting requests to delegates** option
7. Click **Apply** to save your changes, or click **OK** to save your changes and close the dialog.

Using PowerShell

NOTE: *You need to have permissions assigned before you can perform this procedure. To see what permissions are required, see the "Resource Mailbox Configuration Permissions" section in the Mailbox Permissions topic.*

The following example uses the primary SMTP address for *Ed*, *Ayla*, and *Tony* to set them as the delegates for the resource mailbox *Room222*:

```
Set-CalendarProcessing -Identity "Room222" -ResourceDelegates "ed@contoso.com", "ayla@contoso.com",  
"tony@contoso.com"
```

Appendix B: Configuring Acendo Book Panels for Microsoft Exchange & Office 365

Overview

This section provides information regarding setting up Acendo Book panels to communicate with Exchange 2010/2103/2016 or Office 365 Servers.

Acendo Book Service Account

The Acendo Book Service Account on the Exchange or Office 365 server must meet the following requirements:

- The account must have an associated Exchange Mailbox.
- The account information entered here must match the account information for the Acendo Book Service Account (as entered in the CALENDAR Settings page (see page 39).
- The account must have rights to add, modify, and cancel/delete appointments in each Exchange Room Mailbox with which Acendo Book will synchronize. This may be accomplished via any of the following three methods:
 - Delegate access to the mailbox.
 - Impersonate the mailbox owner using Exchange Impersonation.
 - Assign full-access permissions to the mailbox.

Microsoft Exchange / Office 365: Username and Calendar Email IDs

The Exchange 2010/2103/2016 or Office 365 Server has a unique *User Name* for each user and a unique *Calendar Email ID* for each room. The Username and Calendar Email ID is entered for each room in the CALENDAR Settings page (see FIG. 56 on page 39).

To configure each Acendo Book user and room for use with Microsoft Exchange / Office 365:

- Enter the **Username**: Enter a valid name for a user with access rights that are appropriate for the room specified in the *Calendar Email ID* field (see below). The Username must include the fully qualified domain name
Example: JaneDoe@acme.onmicrosoft.com
- Enter the **Calendar Email ID**: Enter the email address for a valid room. The Calendar Email ID must include the fully qualified domain name.
Example: ConfRoom1@acme.onmicrosoft.com

NOTE: The *Calendar Email ID* field is the only field that is unique to each room: "Server URL", "username", and "password" are the same across all rooms in the system (FIG. 154):

SETTINGS

Network **Calendar** Localization Group Room Security

Calendar Server Office 365

Username JaneDoe@acme.onmicrosoft.com

Password 12admin34

Calendar Email ID ConfRoom1@acme.onmicrosoft.com

Certificate Validation Strict

Exit Edit

Calendar Server, Username and Password fields are the same for all rooms in the Exchange or Office 365 deployment

Calendar Email ID and Certificate Validation is unique for each room

FIG. 154 SETTINGS > Calendar page (showing sample Calendar information - Exchange/Office 365)

Microsoft Exchange / Office 365: Certificate Validation

The Exchange 2010/2103/2016 or Office 365 Server has a unique *User Name* for each user and a unique *Calendar Email ID* for each room. The Username and Calendar Email ID is entered for each room in the CALENDAR Settings page (see FIG. 56 on page 39).

Microsoft Documentation

The following links provide access to online Microsoft documentation regarding each of these methods for each supported Server OS:

Exchange 2010	Set a Delegate on a Resource Mailbox: http://technet.microsoft.com/en-us/library/bb124973(v=exchg.141).aspx
Exchange 2013, Office 365	Delegating Permissions: http://technet.microsoft.com/en-us/library/jj215781%28v=exchg.150%29.aspx (go to Create a room mailbox > Use the EAC to create a room mailbox) <i>Note: If you selected the option requiring that booking requests are sent to delegates, use this section to select delegates.</i> <ul style="list-style-type: none"> To add a delegate, click <i>Add</i>. On the Select Delegates page, select a user, click <i>Add</i>, and then click <i>OK</i> to return to the New room mailbox page. To remove a delegate, select the user and then click <i>Remove</i>. Assigning Full-Access Permissions: http://technet.microsoft.com/en-us/library/jj919240%28v=exchg.150%29.aspx Configuring Impersonation: https://msdn.microsoft.com/en-us/library/office/dn722376(v=exchg.150).aspx
Exchange 2016, Office 365	Delegating Permissions: https://technet.microsoft.com/en-us/library/jj215781(v=exchg.160).aspx (go to Create a room mailbox > Use the EAC to create a room mailbox) <i>Note: If you selected the option requiring that booking requests are sent to delegates, use this section to select delegates.</i> <ul style="list-style-type: none"> To add a delegate, click <i>Add</i>. On the Select Delegates page, select a user, click <i>Add</i>, and then click <i>OK</i> to return to the New room mailbox page. To remove a delegate, select the user and then click <i>Remove</i>. Assigning Full-Access Permissions: https://technet.microsoft.com/en-us/library/jj919240(v=exchg.160).aspx Configuring Impersonation: https://msdn.microsoft.com/en-us/library/office/dn722376(v=exchg.150).aspx

Configuring Exchange To Hide/Show Meeting "Organizer", "Title" and "Details"

For **Exchange 2010**, see information under **Resource Information** in the *Use the EMC to configure resource mailbox properties* section:

[https://technet.microsoft.com/en-us/library/bb124255\(v=exchg.141\).aspx](https://technet.microsoft.com/en-us/library/bb124255(v=exchg.141).aspx)

Exchange 2013, 2016 and Exchange Online require the use of Exchange cmdlets to change the room mailbox properties.

The cmdlet of interest is the *Set-CalendarProcessing* which will allow you to configure what information Exchange provides to the Acendo Book panel.

Set-CalendarProcessing parameters of particular significance:

- AddOrganizerToSubject
- DeleteComments
- DeleteSubject

Microsoft Documentation

The following links provide access to online Microsoft documentation that provide details needed to use the above mentioned cmdlet for each supported Server OS:

Exchange Server 2010	https://technet.microsoft.com/en-us/library/dd335046(v=exchg.141).aspx
Exchange Online, Exchange Server 2013	https://technet.microsoft.com/en-us/library/dd335046(v=exchg.150).aspx
Exchange Online, Exchange Server 2016	https://technet.microsoft.com/en-us/library/dd335046(v=exchg.160).aspx

Privacy Flag

Acendo Book panels use Exchange, Office 365 or Google "privacy" flag. A meeting marked as private will behave the same way the global Acendo Book "Privacy Mode" behaves (see the *Privacy Mode* section on page 34).

In order for the Acendo Book panel to be able to read the privacy mode flag in Exchange and Office 365, the Exchange server must set the room's "*-RemovePrivateProperty*" to **\$false**. By default, this is set to **\$true**.

Appendix C: Creating Room Mailboxes

Overview

Exchange 2010, 2013, 2016 and Office 365 use *Room Mailboxes* to manage meeting room schedules. Each Acendo Book location (meeting room) that will synchronize with the Microsoft scheduling application (Exchange / Office 365) must be represented by a Room Mailbox.

NOTE: *Appropriate administrator access is required to perform these tasks.*

Creating a New Room Mailbox: Exchange 2010

1. On the Exchange 2010 server, select **Microsoft Exchange Server 2010 > Exchange Management Console** to launch the *Exchange Management Console* utility.
2. Under *Recipient Configuration*, right-click on **Mailbox** and select **New Mailbox** from the context menu. This selection opens the *New Mailbox - Introduction* dialog.
3. Select **Room Mailbox**, and click **Next** to proceed to the *New Mailbox - User Type* dialog.
4. Select either **New User** or **Existing users**:
 - **New User** - select this option to create a new user.
 - **Existing users** - select this option to assign an existing user that is not currently associated with an Exchange 2010 Mailbox.
5. Click **Next** to proceed to the *New Mailbox - User Information* dialog.
6. Fill in the user information fields in this dialog and click **Next** to proceed to the *New Mailbox - Mailbox Settings* dialog.
7. The default settings in this dialog are sufficient - click **Next** to proceed to the *New Mailbox New Mailbox (Confirmation Summary)* dialog.
 - Use this dialog to review the information entered.
 - To copy the summary information presented in this dialog, click CTRL+C.
8. Click **New** to create the new Mailbox, and proceed to the *New Mailbox - Completion* dialog.
9. Click **Finish**.

Repeat this process for each RMS Location that will synchronize with RMS.

Additional Documentation

For more detailed information on creating a room mailbox, creating a room list and changing room mailbox properties in Exchange 2010, refer to the Microsoft® article "*Managing Resource Mailboxes and Scheduling*":

[http://technet.microsoft.com/en-us/library/bb124374\(v=EXCHG.141\).aspx](http://technet.microsoft.com/en-us/library/bb124374(v=EXCHG.141).aspx)

Note that this article also provides instructions on using the Exchange Management Shell to create room mailboxes and room lists.

Creating a New Room Mailbox: Exchange 2013 and Exchange 2016

1. Log in to the Exchange Admin Center (EAC):
 - `https://<ip address of Exchange server>/ecp`
 - or -
 - `https://<host name of Exchange server>/ecp`
 - a. Provide your credentials to log into Exchange.
 - b. The Exchange Admin Center opens in your browser window.
2. Under *Recipients*, select **Resources**.
3. In the *Resources* page toolbar, click the **Add (+)** button then select **Room mailbox** to open the *New Room Mailbox* dialog.
4. Fill in the fields, and click **Save** to create the new mailbox and close the *New Room Mailbox* dialog.

NOTE: *The only required fields in this dialog are Room name and Email address.*

The new room should now be included in the list of Resources (on the *Resources* page).
5. Select the new mailbox and click **Edit** to open the *Room Mailbox* dialog. Use the options in this dialog to configure the new room mailbox.
6. Select **Booking Delegates**.
7. Under *Booking requests*, verify that **Accept or decline booking automatically** is selected (the default setting).
8. Click **Save** to save changes and close the *New Room Mailbox* dialog.

Repeat this process for each RMS Location that will synchronize with RMS.

Additional Documentation

For more detailed information on creating a room mailbox, creating a room list and changing room mailbox properties in Exchange 2013, refer to the Microsoft® article "Create and manage room mailboxes":

<http://technet.microsoft.com/en-us/library/jj215781%28v=exchg.150%29.aspx>

For more detailed information on creating a room mailbox, creating a room list and changing room mailbox properties in Exchange 2016, refer to the Microsoft® article "Create and manage room mailboxes":

[https://technet.microsoft.com/en-us/library/jj215781\(v=exchg.160\).aspx](https://technet.microsoft.com/en-us/library/jj215781(v=exchg.160).aspx)

NOTE: *These articles also provide instructions on using the Exchange Management Shell to create room mailboxes and room lists.*

Creating a New Room Mailbox: Office 365

1. Log in to the Exchange Admin Center (EAC):
<https://outlook.office365.com/ecp/>
 - a. Provide your credentials to log into Office 365.
 - b. The Exchange Admin Center opens in your browser window.
2. Under *Recipients*, select **Resources**.
3. In the *Resources* page toolbar, click the **Add (+)** button to open the *New Room Mailbox* dialog.
4. Fill in the fields, and click **Save** to create the new mailbox and close the *New Room Mailbox* dialog.

NOTE: *The only required fields in this dialog are Room name and Email address.*

The new room should now be included in the list of Resources (on the *Resources* page).

5. Select the new mailbox and click **Edit** to open the *Room Mailbox* dialog. Use the options in this dialog to configure the new room mailbox.
6. Select **Booking Delegates**.
7. Under *Booking requests*, verify that **Accept or decline booking automatically** is selected (the default setting).
8. Click **Save** to save changes and close the *New Room Mailbox* dialog.

Repeat this process for each RMS Location that will synchronize with RMS.

Additional Documentation

For more detailed information on creating a room mailbox, creating a room list and changing room mailbox properties in Office 365, refer to the Microsoft® article "Create and manage room mailboxes":

<http://technet.microsoft.com/en-us/library/jj215781%28v=exchg.150%29.aspx>

Note that this article also provides instructions on using the Exchange Management Shell to create room mailboxes and room lists.

Appendix D: Configuring Google Resources

Overview

This section provides instructions for configuring Google resources to work correctly with Acendo Book panels.

These instructions make the following assumptions:

- A Google Business *Service* account is available
- A Room Administrator account has been created that will be shared with each resource

The process of configuring Google resources for use with Acendo Book panels entails the following:

1. Create Resources (see below)
2. Share resource calendars with administrator - see page 84
3. Share service calendars with room administrator account - see page 85
4. Ensure calendar is set to deny conflicts - see page 86

1) Create Resources

1. Log in to the Google Admin Console using the credentials for the Administrator account for *Google Apps for Business* used by Acendo Book (FIG. 155):

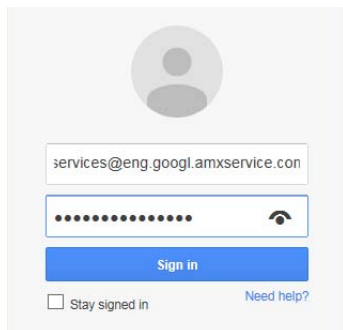

Note that your Google Admin Console user interface may vary slightly from the illustrations provided here, based on your specific software version. The concepts described in this section apply to all supported versions of Google for Business.

FIG. 155 Google Admin Console Login Screen

2. In the Admin Console, select **Apps** (FIG. 155):

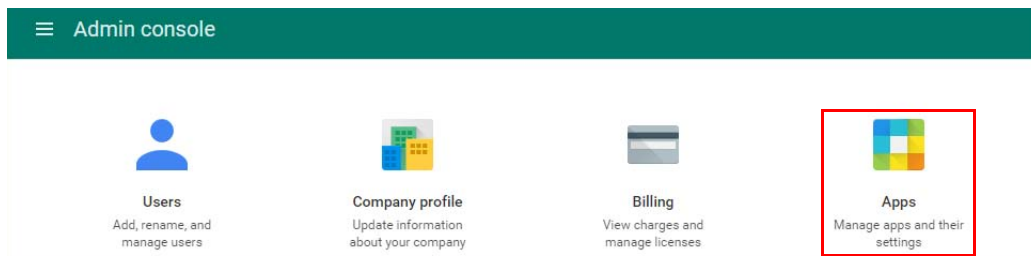

FIG. 156 Google Admin Console (detail)

3. In the *Apps* page, select **Google Apps** (FIG. 157):

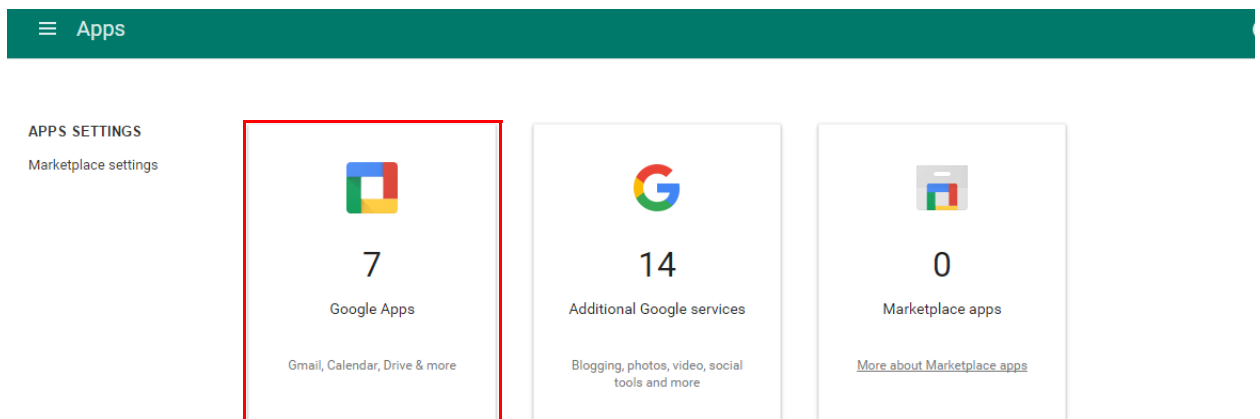

FIG. 157 Google Admin Console - Apps Page (detail)

4. In the *Google Apps* page, select **Calendar** (FIG. 158):

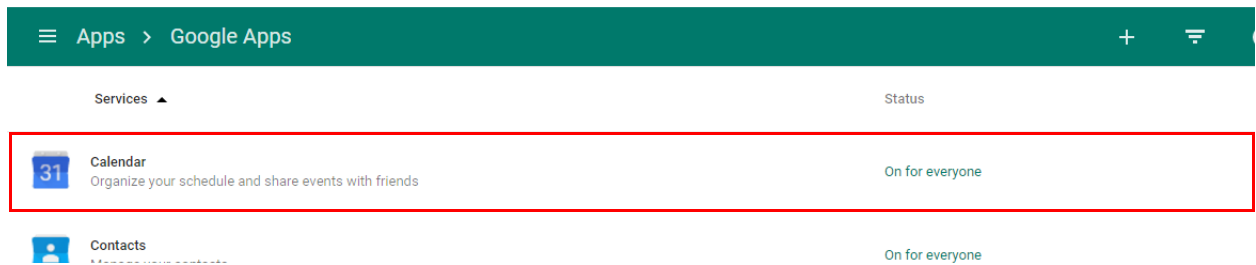

FIG. 158 Google Admin Console - Google Apps Page (detail)

5. In the *Calendar* page, select **Resources** (FIG. 159):

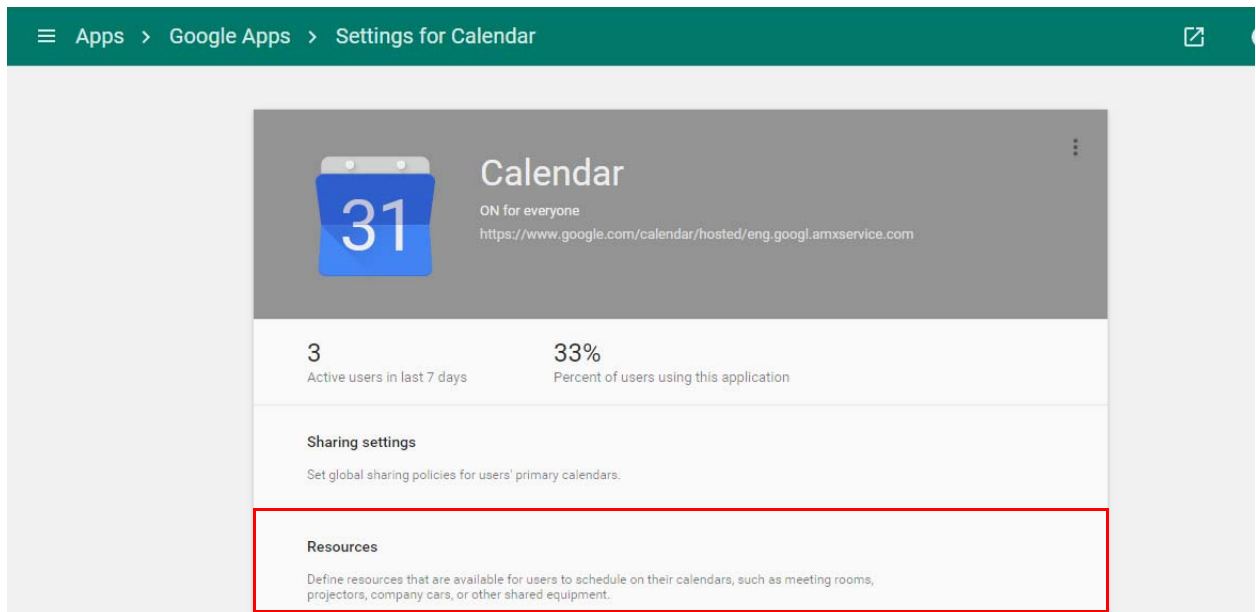

FIG. 159 Google Admin Console - Calendar Page (detail)

6. In the *Resources* pane, select **Create a new resource** (FIG. 160):

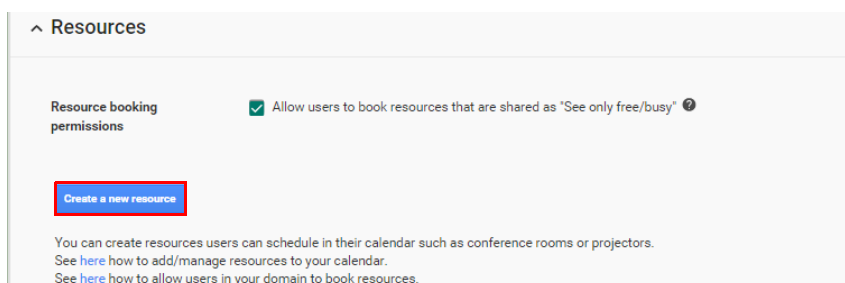

FIG. 160 Google Admin Console - Calendar Page - Resources Pane (detail)

7. Define the *Resource Name*, *Resource Type* and *Description* (FIG. 161):

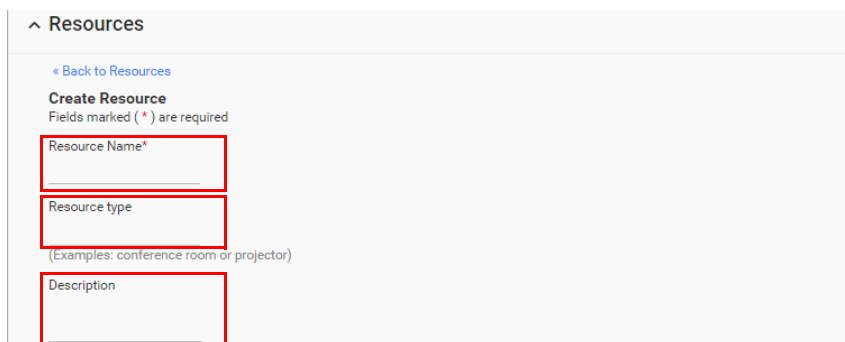

FIG. 161 Google Admin Console - Calendar Page - Resources Pane (Create a new resource)

8. Save changes.

2) Share Resource Calendars With Administrator

1. From the *Resources* list, select the resource just created and copy the resource email address (FIG. 162):

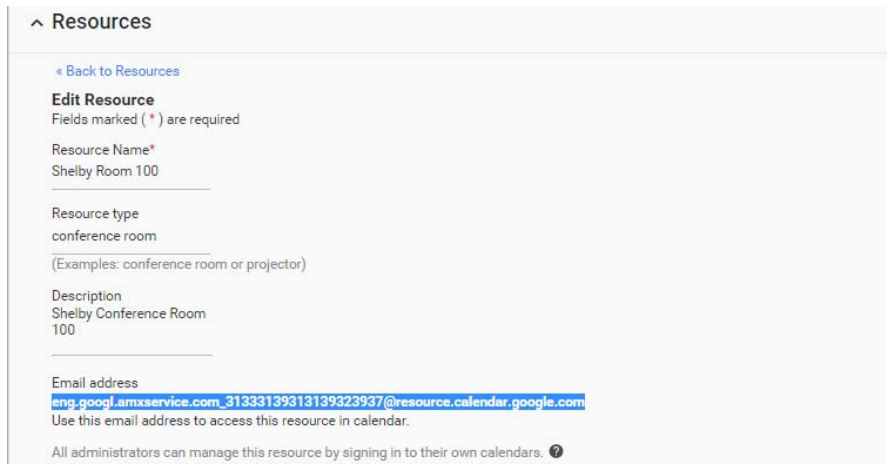

FIG. 162 Google Admin Console - Calendar Page - Resources Pane (Copy new resource email address)

2. In the Google toolbar, select the *Apps* icon (FIG. 163):

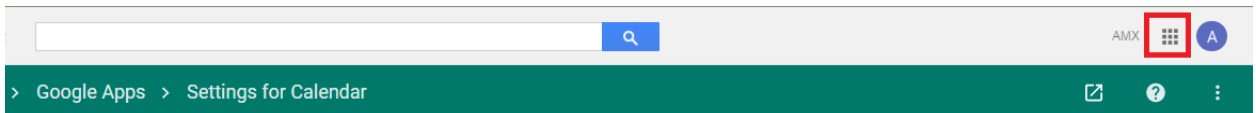

FIG. 163 Google Admin Console Toolbar - Apps Icon

3. In the Apps window, select the **Calendar** app (FIG. 164):

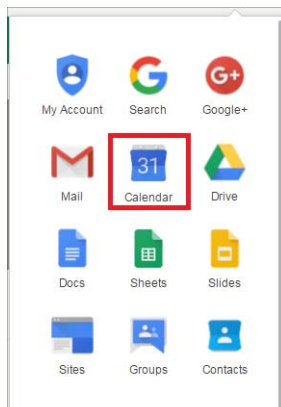

FIG. 164 Google Apps - Calendar

4. In the Calendar, share the new resource calendar by selecting **Add a Coworkers Calendar** under *Other Calendars* (FIG. 165):

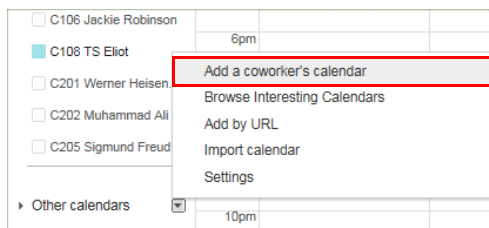

FIG. 165 Google Calendar - Other Calendars > Add a Coworkers Calendar

5. In the *Add Coworkers Calendar* window, paste the email address for the resource (in the *Contact Email* field) and select **Add** (FIG. 166):

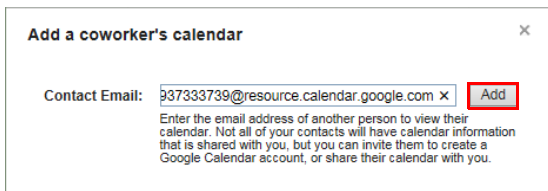

FIG. 166 Add a Coworkers Calendar - Contact Email

6. The resource calendar should now show up in the list of calendars under *My Calendars* (see "Room 101" in FIG. 167):

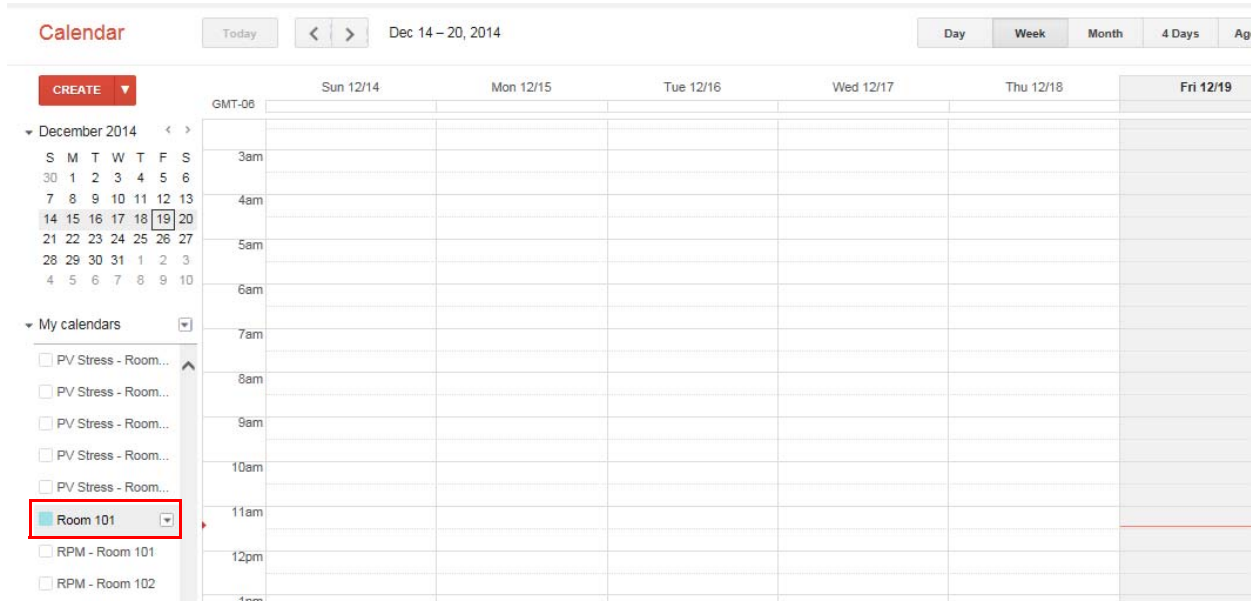

FIG. 167 Google Calendar indicating new Calendar ("Rom 101")

3) Share Service Calendars With Room Manager Account

1. Share the room administrator account with the resource calendar by selecting **Share this Calendar** for the resource calendar in the *My Calendars* list (FIG. 168):

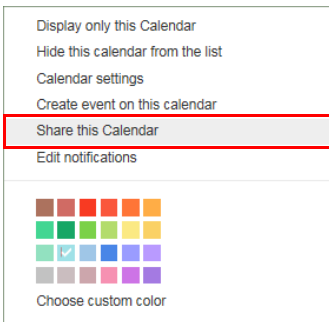

FIG. 168 Share This Calendar

2. In the *Room Details - Share This Calendar* page, paste the Room Manager account email address in the *Person* field (FIG. 169):

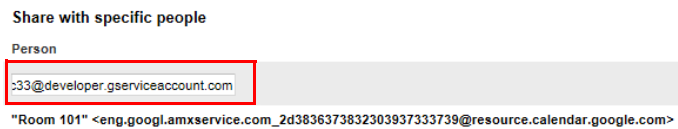

FIG. 169 Google Calendar > Room Details > Share This Calendar > Share With Specific People > Person

3. Under *Permission Settings*, select **Make changes AND manage sharing** (FIG. 170):

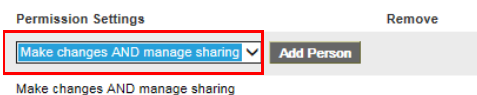

FIG. 170 Google Calendar > Room Details > Share This Calendar > Permission Settings

4. Select **Add Person** (FIG. 171):

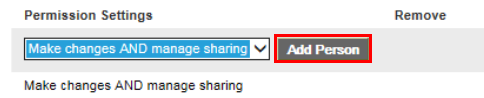

FIG. 171 Google Calendar > Room Details > Share This Calendar > Permission Settings > Add Person

5. Click **Save**. At this point, Google will prompt you to verify these changes. Select **OK** to proceed (FIG. 172):

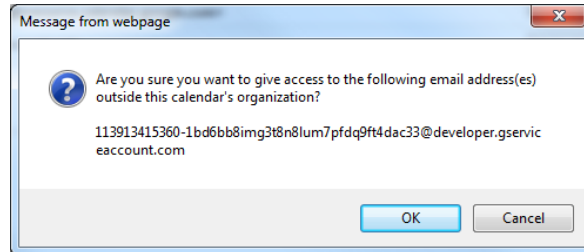

FIG. 172 Google Calendar - Message From Webpage

4) Ensure Calendar Is Set To Deny Conflicts

1. Right-click on the new calendar resource, and select **Calendar Settings** (FIG. 173):

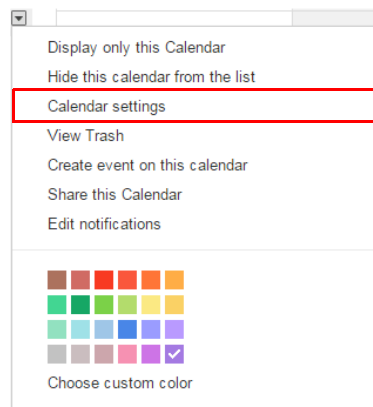

FIG. 173 Google Calendar - Calendar Settings option

2. In the *Calendar Details* page - *Auto-accept invitations* section, verify that **Auto-accept invitations that do not conflict** is selected (FIG. 174):

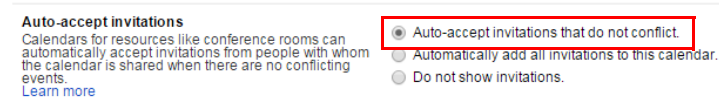

FIG. 174 Calendar Details page > Auto-accept invitations > Auto-accept invitations that do not conflict

3. Save changes.



© 2017 Harman. All rights reserved. SmoothTouch, AMX, Acendo Book, AV FOR AN IT WORLD, and HARMAN, and their respective logos are registered trademarks of HARMAN. Oracle, Java and any other company or brand name referenced may be trademarks/registered trademarks of their respective companies.

AMX does not assume responsibility for errors or omissions. AMX also reserves the right to alter specifications without prior notice at any time.

The AMX Warranty and Return Policy and related documents can be viewed/downloaded at www.amx.com.

3000 RESEARCH DRIVE, RICHARDSON, TX 75082 AMX.com | 800.222.0193 | 469.624.8000 | +1.469.624.7400 | fax 469.624.7153

AMX (UK) LTD, AMX by HARMAN - Unit C, Auster Road, Clifton Moor, York, YO30 4GD United Kingdom • +44 1904-343-100 • www.amx.com/eu/

Last Revised:
8/16/2017