



**TSS-2470**

*BROADCAST TIME DELAY*

# Operations Manual

Model TSS-2470 Time Delay

Version 622  
June 2016

Copyright© 2016, 360 Systems  
All rights reserved  
Printed in the United States of America

100-145-0024 TSS-2470 Time Delay Operations Manual



# Table of Contents

<b>Safety Notices</b> .....	<b>4</b>
Safety Terms and Symbols .....	4
General Safety Caution .....	4
Personal Injury Precautions .....	4
Product Damage Precautions .....	5
Product Registration .....	5
Product Improvements and Upgrades .....	5
Trademarks and Software Copyrights .....	6
<b>Introduction</b> .....	<b>7</b>
<b>TSS-2470 Time Delay Features</b> .....	<b>8</b>
<b>Installation</b> .....	<b>9</b>
Unpacking .....	9
Rack Mounting .....	9
System Cooling .....	10
Power Conditioning .....	10
About TSS-2470 Time Delay Software .....	12
<b>Front Panel Features</b> .....	<b>13</b>
Front Panel .....	13
Power Button .....	13
Indicators .....	13
<b>Rear Panel Drawing</b> .....	<b>14</b>
<b>Rear Panel Connectors</b> .....	<b>15</b>
<b>Operations</b> .....	<b>16</b>
The Graphical User Interface .....	16
Run/Stop Control .....	17
Time Delay Setting .....	17
Configure Options Dialog .....	18
Configure Network .....	21
Date and Time .....	23
Network Time Protocol .....	23
<b>Technical Specifications</b> .....	<b>27</b>
<b>Connector Pin Designations</b> .....	<b>28</b>
HDBNC Connectors .....	28
System Board Ports .....	28
<b>Mechanical Drawing</b> .....	<b>29</b>
<b>Program Updates from USB Memory</b> .....	<b>30</b>
<b>Maintenance</b> .....	<b>31</b>
Fault Diagnostics .....	31
Front Panel Indicators .....	31
Other Error Indicators .....	31
Gigabit Ethernet Indicators .....	32
Access to Components .....	32
Removing the Front Panel .....	32

Removing the Top Cover .....	33
General Handling Precautions .....	33
Installing/Removing I/O Cards .....	34
Accessing the Main System Board .....	34
Managing the RAID Disk Array.....	35
<b>Notices .....</b>	<b>38</b>
Product Registration .....	38
Product Improvements and Upgrades .....	38
Repair Policy .....	38
Trademarks .....	38
Software .....	38
<b>End User License Agreement.....</b>	<b>39</b>
<b>Limited Warranty .....</b>	<b>41</b>
<b>Index.....</b>	<b>42</b>



## Safety Notices

### Safety Terms and Symbols

The following warning symbols are used in this manual



English	ATTENTION: refer to owner's manual for important information.
Français	ATTENTION: veuillez vous référer au mode d'emploi pour une information importante.
Italiano	ATTENZIONE: fate riferimento al manuale per informazioni importanti.
Español	ATENCIÓN: favor de referir al manual de operacion por informacion importante.



English	WARNING: electrical shock hazard.
Français	AVERTISSEMENT: danger de choc électrique.
Italiano	AVVERTIMENTO: pericolo di shock elettrico.
Español	ADVERTENCIA: peligro de choque electrico.

### General Safety Caution

Heed the following important cautions regarding the TSS-2470 Time Delay in order to avoid personal injury or equipment damage.

Only qualified personnel should perform installation and service. Refer to appropriate sections of this product manual for instruction. Contact 360 Systems Customer Support for further explanation, or to clarify any uncertainty.

Disconnect both power cords before removing the cover.

### Personal Injury Precautions

To avoid electric shock, do not operate this product with cover removed.

To avoid risk of fire, replace the power cord only with same type and rating as specified. Replace damaged power cords immediately.

This product is grounded through the grounding conductor of the power cord. To avoid electric shock, do not remove or modify the contacts on the plug.

Prevent the power cord from being walked on, pinched, or abraded.

To reduce the risk of fire or electric shock, do not expose this unit to rain or moisture.

Remove jewelry, such as rings, watches, or necklaces before servicing this equipment.

## Product Damage Precautions

The TSS-2470 Time Delay contains hard disk drives and other fragile electronic and mechanical devices. While this product is very reliable, it is still vulnerable to shock. Handle it with care, and exercise caution not to drop or bump the recorder as damage to internal components may result. Turn off power before moving the Time Delay.

Do not obstruct air vents. Maintain an ambient temperature below 30°C (86°F).

Clean only with a soft cloth dampened with water. Do not spray cleaners or solvents directly on the product.



### WARNING:

Do not ingest the battery, Chemical Burn Hazard

This product contains a coin/button cell battery. If the coin/button cell battery is swallowed, it can cause severe internal burns in just 2 hours and can lead to death.

Keep new and used batteries away from children.

If the battery compartment does not close securely, stop using the product and keep it away from children. If you think batteries might have been swallowed or placed inside any part of the body, seek immediate medical attention.



### CAUTION:

Replace battery only with the same, or equivalent, battery type. Follow all local laws regarding the disposal of BR and CR Lithium batteries. Batteries should be fully discharged prior to disposal.



### CAUTION:

Never shutdown the Time Delay by removing the power cords. Doing so may cause errors in the hard disk array. Should this happen, the array can be reinitialized without any data loss; however, the process may take several hours. Shutdown the system only by momentarily pressing the front panel reset button, or through the On-Screen user interface.

## Product Registration

**Important:** As the owner of new capital equipment, you will want to take advantage of product information, enhancements, upgrades, or notifications issued by 360 Systems. Please register your product so 360 Systems can remain in contact with you. To register your product, visit <http://360systems.com/support/product-registration/> or call our Customer Service Department at 818-991-0360.

## Product Improvements and Upgrades

360 Systems reserves the right to make changes and/or improvements to its products without incurring any obligation to incorporate such changes or improvements in units previously sold. Certain features mentioned in this document may not be present in all models. Time Delays are not offered for sale in all countries.



## **Trademarks and Software Copyrights**

Image Server, MAXX, 360 Systems, 360 Systems Broadcast, and Direct Digital Import are trademarks or registered trademarks of 360 Systems in the U.S. and/or foreign countries. Other trademarks referred to in this document are the property of their respective owners.

Software in this product is based on the work of, or is copyright by, 360 Systems, Trolltech, and FreeType Team. Copyright 2003-2016 by 360 Systems.

# TSS-2470 Time Delay

## Introduction

360 Systems TSS-2470 Time Delay is a high-quality program delay for television broadcast, satellite delivery, and other applications requiring a user-settable delay time for video, audio, and ancillary data. Applications for the delay include:

- Compensation for time zone differences, where a program is received at a different time than when it needs to air.
- Program origination delays, where content is time-shifted prior to transmission or distribution.
- “+ 1” channels that allow cable casters to offer multiple feeds of the same program content to maximize channel exposure with limited additional cost. Viewers can choose to see a variety of different shows in their chosen viewing time, or see an immediate repeat of a show that interested them simply by changing the channel.
- The TSS-2470 model can be used in a disaster recovery system where a 24 hour delay provides a guarantee of airing appropriate content for the time of day.

The TSS-2470 can be thought of as a black box that records video, audio, and specific ancillary data information; it then delays the playback of the program by a user-selectable time period. Whatever goes in, comes out later.

The TSS-2470 Time Delay will operate as a set-and-forget box with no user intervention. On restarting after a power failure, it will again start delaying the input according to the most recent user settings. The delay time is user-programmable from 30 seconds to greater than 40 hours. The programmed delay interval is frame-accurate over an indefinite time period; if several Time Delays are fed identical input signals, they will remain in sync indefinitely.

The TSS-2470 Time Delay is convertible from an SD delay server to an HD delay server with no additional hardware or software. It employs high quality, HD video encoding at 100 Mb/s or SD encoding at 30 Mb/s which is ideal for this application, providing superior final image quality when used in conjunction with other codec processes such as MPEG or H.264 for satellite transmission and cable distribution.

16 embedded audio channels are provided. Alternately, two +4 dBu analog channels are available.

Vertical Interval Ancillary (VANC) data is reproduced. The payload capacity is set by default to 4K per frame or field and is adjustable.



## TSS-2470 Time Delay Features

- Functions in a stand-alone configuration with no external machine controls, and requires no third-party software.
- Operates unattended for long periods of time. No operator intervention or file maintenance required for continuous operation.
- All settings are non-volatile, allowing unattended restart on power-up. The unit automatically reconfigures itself for the last-specified delay time, and re-enters the record/playback cycle.
- System configuration is accomplished through a GUI interface using a local keyboard, mouse and VGA monitor.
- Allows user to specify a frame-accurate delay time, such that multiple units will play back in frame-accurate sync when fed identical input video.
- RAID-5 drive array protects stored data against a single drive failure.
- 1 HD-SDI/SD-SDI program input.
- 1 E-E monitor output, 1 delayed program output. HD-SDI/SD-SDI connectors provided.
- Records video in 10-bit, at 100 Mb/s for visually lossless picture quality.
- Records 8 stereo pairs SDI embedded. (4 in SD).
- Synchronizes to video input, or to an external reference.
- Upon loss of input video, records black and uses internal reference until input is restored.
- Outputs black and audio silence during the recording interval preceding the desired program output delay.
- Captures and plays VANC data.
- Front panel status LEDs: network, system, power.
- 1 rack-unit (1 ¾") height. Redundant, forced-air cooling.



## Installation

### Unpacking

Your TSS-2470 Time Delay has been carefully inspected and calibrated before shipment to allow immediate operation upon installation. Check all items for signs of visible damage which may have occurred during shipment. If any item is damaged, contact the carrier to file a claim.

Keep the packing materials in the event that the unit must be shipped. If the original packaging is not available, make sure that the following criteria are met:

- Packaging must be able to withstand the product weight.
- Product must be held firmly within the package.
- There must be at least two inches (50mm) of space between the product and outer container.
- The corners of the product must be protected.

### Package Contents

Confirm that all items on the packing list have been received. Contact 360 Systems if any item is missing.

- ✓ Model TSS-2470 Time Delay
- ✓ Keyboard
- ✓ 2-Button Wheel Mouse.
- ✓ Software backup on USB memory stick
- ✓ Operations Manual
- ✓ Power cord

The TSS-2470 Time Delay is not shipped with a video monitor. Select a VESA-compliant CRT or LCD monitor capable of a refresh rate of at least 75 Hz. **Note that the TSS-2470 Time Delay may not start correctly if an unsuitable monitor is connected.**

If you own more than one TSS-2470 Time Delay, it may be appropriate to use a single keyboard, monitor, and mouse with a KVM switch to select between units. Not all KVM switching systems are compatible. The KVM switch must supply an active signal to the TSS-2470 Time Delay at all times, even when switched away from it. When first powering up the TSS-2470 Time Delay, use only the supplied keyboard and mouse directly connected. Then test the KVM switch system that will be used thoroughly before installation is completed. Be especially careful about this when using extender cables.

### Rack Mounting

Cables attached to the rear of the TSS-2470 Time Delay should be supported by proper cable management. Do not support substantial cable weight from the TSS-2470 Time Delay's Mini BNC connectors as this may damage the video board.

In stall the provided rack rails into the rack first then remove the front panel to expose the rack screw slots. Fasten the TSS-2470 Time Delay into the rack. Replace the front panel.



## Important Installation Notes

### System Cooling

When many pieces of equipment are mounted in an equipment rack, a considerable amount of heat may be produced, which must be removed efficiently. Further, a lower operating temperature will make equipment operate more reliably, and it will last longer. In the extreme case, excessive temperatures cause rapid equipment failure, and damage which can be difficult to repair.

Heat in an equipment rack should be removed by forced air. This is often accomplished by blowers installed in the top of the rack, venting into the room. An alternative is to draw hot air from the top of the rack into an air-conditioning return duct, and not vent it into the equipment room; cold air should be ducted into the bottom of the rack.

The optimum air temperature for cooling electronic equipment is 25° C (72° F). When many pieces of equipment are contributing to the heat load, a substantial air-flow will be needed, and the inlet temperature may need to be lower.

### Check These Points

- Are all ventilation holes in the TSS-2470 Time Delay free of obstruction?
- Can blowers or HVAC system adequately remove heat from the equipment rack?
- Have you measured the actual temperature inside the rack? Do this near the top.
- Verify that the HVAC system is not on a timer that can shut off on weekends or holidays.
- What procedures are in place to protect the equipment when the HVAC system fails?

### Power Conditioning

It is good practice to operate an on-air TSS-2470 Time Delay from an Uninterruptible Power Source, or UPS. All utility power systems experience occasional transient events, including brownouts and dropouts, which are capable of taking the TSS-2470 Time Delay off the air. It is the station operator's job to plan for and overcome such contingencies.

UPS units suitable for smoothing short-term power line problems come in two varieties:

#### Change-over UPS Design

This design senses drop-outs and low line voltage, and switches its output to an internal inverter operating from a battery. This UPS is low in cost, and is most often used in non-critical applications such as desk-top computers. A disadvantage is that it may create its own power transients when switching between utility power and its inverter supply. For this reason **360 Systems does not recommend this type for use with the TSS-2470 Time Delay.**

#### Continuous Conversion UPS Design

This improved design continuously converts utility power to DC, stores it in a battery, then produces isolated AC power from an inverter. It never switches, and is immune to input transients, brownouts, and blackouts. Models are available with batteries of almost any size, making the continuous-conversion UPS suitable for transient suppression or long-term operating power in the absence of utility power.

## Recommended UPS Models

There are several manufactures of continuous conversion UPS systems are suitable for use with 360 Systems' video products. APC and Eaton/Powerware Corporation are two of the most common.

UPS's are available in several different configurations to accommodate various current load and power failure support times.

The minimum requirement for maximum current load for a single TSS-2470 Time Delay is 2 amps.

## Operating Environment

A TSS-2470 Time Delay is a critical element in broadcast operations. Its installation should safeguard it from every external event that can interfere with it doing the task expected of it. 360 Systems' engineers have experience with thousands of installations, and have become aware of a number of environmental factors that can adversely affect performance. Two of these have already been discussed: power conditioning and inadequate cooling. Two others, less obvious, should also be considered:

### RF Interference by Cell Phones

Many people are not aware that cell phones can attain a very substantial power output, even when no conversation is taking place. You may have experienced the effect of a cell phone interfering with a common desk phone placed nearby. Carrying a cell phone into a machine room where it is in close proximity to broadcast equipment and its associated wiring is unwise. They are able to interfere with serial control commands, video synchronization, and in some cases can crash the CPU in equipment.

Some major broadcasters prohibit the carrying of cell phones into certain machine areas. 360 Systems believes that the risk of undesired equipment behavior from their RF fields is very real.

### Static Discharge

Static electricity discharge is accepted by most people as an inevitable consequence of living in a dry area. It is, rather, a result of floor coverings that may enhance appearances, but are inappropriate for use around critical pieces of broadcast equipment. Static discharge can do two adverse things:

- Discharge into a connector can—and will—destroy internal circuitry of equipment. The result will always be difficult to diagnose and repair.
- Discharge to equipment frames or wiring can crash a CPU and take the station off the air. The event may seem random or unrelated to static, but it is clearly a catastrophic event—and one that can repeat indefinitely as humidity varies.

Several steps can be taken to protect equipment from static discharge:

- Do not install critical broadcast equipment in a room with carpeting.
- Connect equipment racks directly to an earth ground with a heavy copper conductor.
- Do not operate equipment with a lifted safety ground (green frame ground).
- Install a humidifier, if necessary, to reduce the likelihood of static discharge.



## **About TSS-2470 Time Delay Software**

The TSS-2470 Time Delay is shipped with its application programs and operating system installed.

The first time that it is started, it must be connected to a keyboard, monitor and mouse in order to enter the operational parameters. It is recommended that these always be available, however once set up the delay process will start automatically when the system powers up and the input signals are present.

If for any reason it becomes necessary to reinstall any software, refer to the *Software / Firmware updates* chapter on page 30 for instructions.

## Front Panel Features



### Front Panel

The front panel is held on by two roller clips, one on each end of the panel. To remove the front panel, grasp the left or right end of the panel and pull straight out. The front panel is reinstalled by reversing this process.

### Power Button

The Power button is located directly behind the front panel on the right side. To turn the system on, press and release the power button. A sequence of start-up screens will appear, ending with the graphical user interface.

When the TSS-2470 Time Delay is running, pressing the Power button momentarily will cause the system to begin an orderly shutdown. This can also be initiated from the GUI by selecting **START > SHUTDOWN > SHUTDOWN**. In most cases the power will shut off automatically, however if the front panel lights begin to blink, the file system has been properly closed and it is safe to force the power off by holding the front panel button in for 4 seconds.

In the event that the system has stopped responding to commands and will not shutdown, hold the button in for 4 seconds to force a power down.

#### **CAUTION:**

**LOSS OF DATA CAN OCCUR IF THE POWER IS TURNED OFF WITHOUT A SHUTDOWN.  
USE THE FOUR SECOND SHUTDOWN ONLY IF THE SYSTEM IS NOT RESPONDING OR THE  
SHUTDOWN PROCESS DOES NOT TURN THE POWER OFF AUTOMATICALLY.**

### Indicators

Three blue LED Status Indicators appear on the front panel. These indicators are illuminated continuously or in some cases are dark when inactive or not connected. The NIC indicator will flash on and off if a network cable is attached indicating network activity. Error conditions are indicated by flashing of the SYS indicator. See the table *Front Panel Indicators* on page 31 for diagnostic meanings.

## Rear Panel Drawing

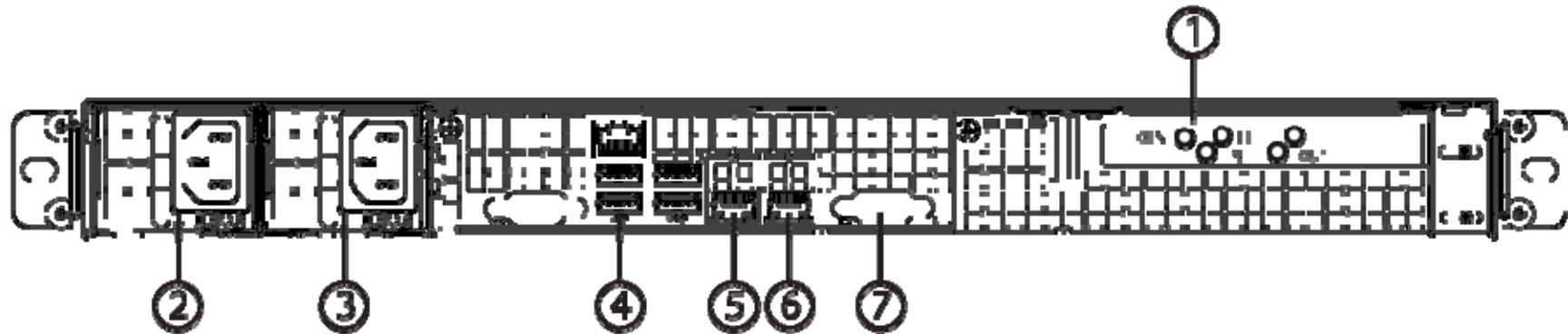

1. SDI Video I/O
2. Power Supply Module 1
3. Power Supply Module 2
4. USB ports for Keyboard / Mouse
5. Gigabit Ethernet port 1
6. Gigabit Ethernet port 2
7. VGA Video monitor output

## Rear Panel Connectors

The TSS-2470 Time Delay provides one video input with up to 16 Embedded audio channels, one delayed video output with audio, and a second monitoring output which reflects input video and audio (E-E).

REAR PANEL DESIGNATION	CONNECTOR TYPE	FUNCTION
IN	HDBNC	HD-SDI/SD-SDI Video Program Input
OUT	HDBNC	Main HD-SDI/SD-SDI Video Program Out
GEN	HDBNC	Black Burst / Tri level reference input
USB	USB	Keyboard / Mouse / Program updates
NET 1	RJ-45	Gigabit Ethernet (for diagnostic use)
Other Motherboard I/O	various	future use



## Operations

### The Graphical User Interface

The TSS-2470 Time Delay uses a Graphical User Interface (GUI) to control most functions. A keyboard and mouse are included, and the user needs to supply an SVGA compliant monitor.

The GUI is divided into two sections: Run/Stop control, and Time Delay Set. Controls and displays for each section are described below.

In addition, the Menu Bar provides two dialogs, accessed through **Configure > Options**, and **Help > About**.

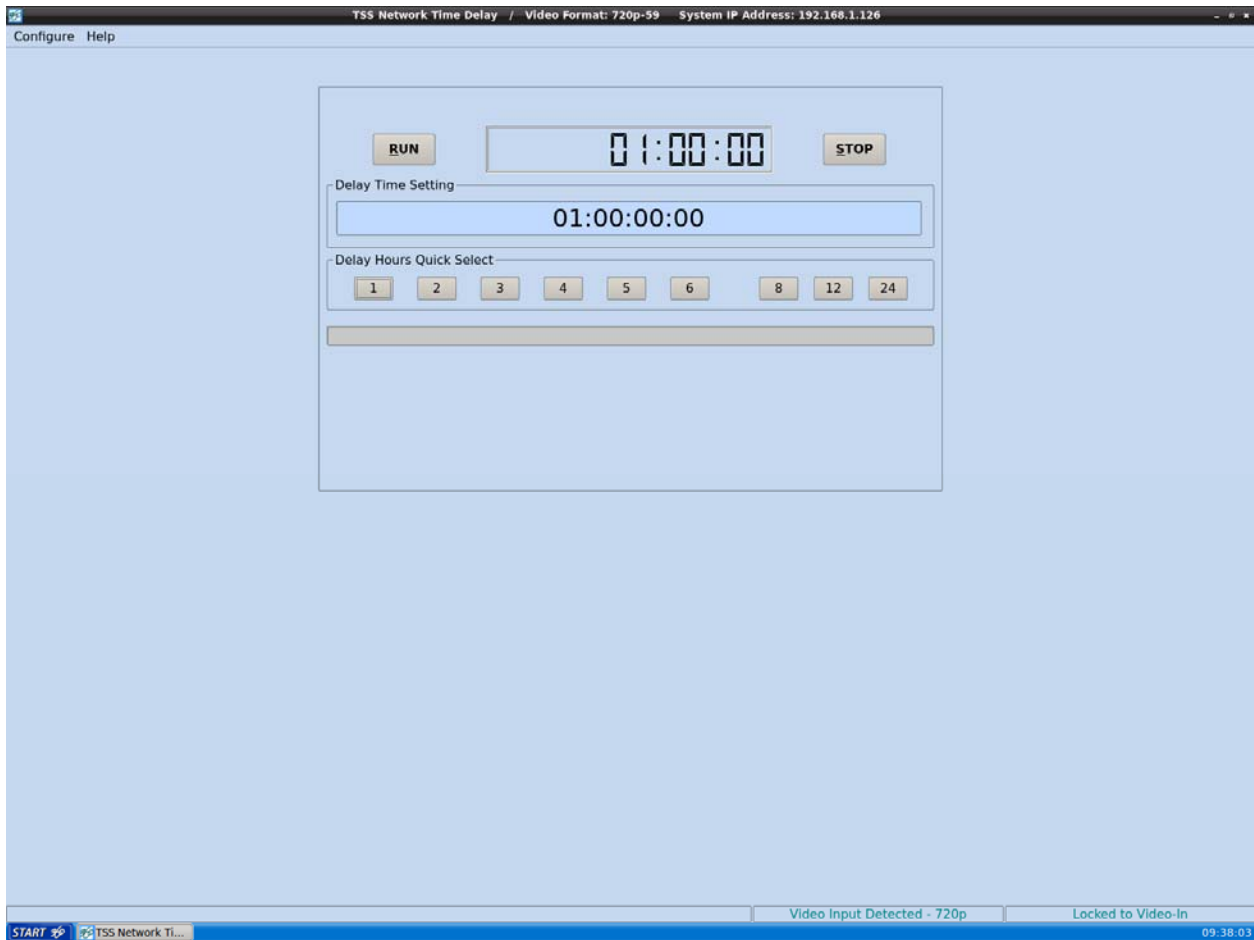

Graphical User Interface



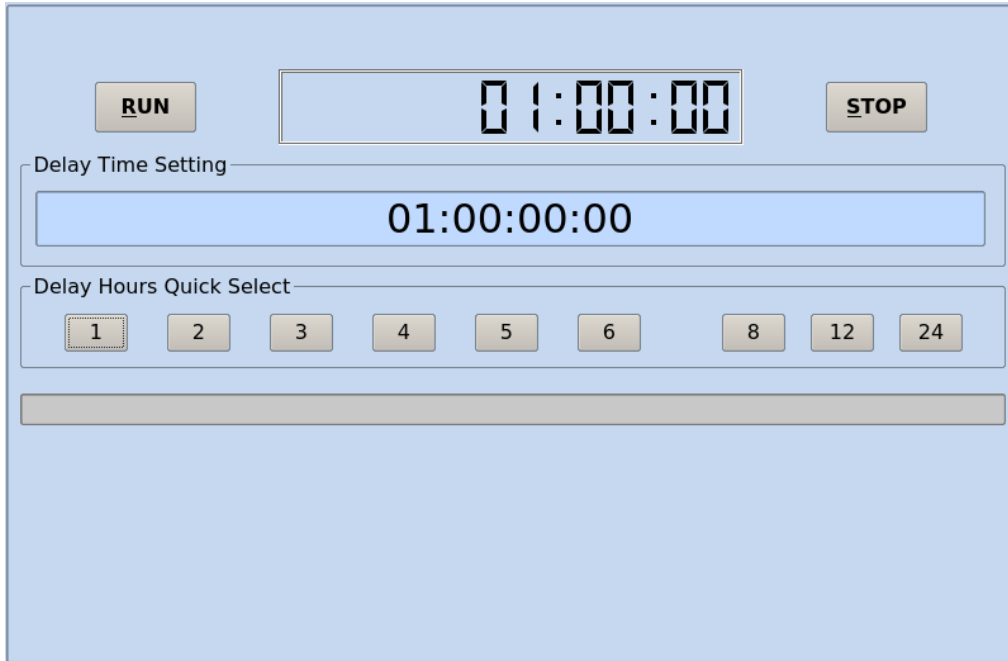

Run, Stop, Time to Air display  
Time Delay Setting and Quick Select Presets

## Run/Stop Control

### Run

The **RUN** button initiates or restarts the TSS-2470 Time Delay process. Press **RUN** to begin a new delay cycle and start the Time-to-Air countdown. When the countdown reaches zero, it changes to ON LINE, and the delayed video begins playing from the main Program Output.

Upon power up the TSS-2470 Time Delay will automatically enter Run mode and start the delay process if a valid input is detected, or if Frame Synchronizer is selected a valid reference signal is detected..

### Stop

The **STOP** button stops playout and clears stored program content from memory. Note that the Time Delay value can only be changed when the machine is in the **STOP** mode.

### Time to Air

Initially, the Time to Air display shows the selected Time Delay Setting. Once **RUN** is pressed and the recording process sets up and commences, Time to Air is a countdown value, displaying the time remaining before delayed program material reaches the output. It is an approximate display value; it is not directly locked to the video timing.

### Time Delay Setting

Delay time is entered and displayed in the **DELAY TIME** window in HH:MM:SS:FF format. (Hours:Minutes:Seconds:Frames) The desired time is entered from the keyboard from left-to-right.

Delay times may also be entered as whole units of seconds, minutes, hours, by appending a suffix, (s, m, or h) to the value entered into the text box, such as "120m" or "30s." "1d" will set a 24 hour delay.



## Delay Hours Quick Select

Nine preset buttons provide a rapid way to set a delay time to an even number of hours from 1 to 24. With the machine stopped, clicking on one of these buttons will immediately load that time value, expressed in hours. An appropriate number of zeros will also be entered for MM:SS:FF. The presets are not active while the machine is running.

## Configure Options Dialog

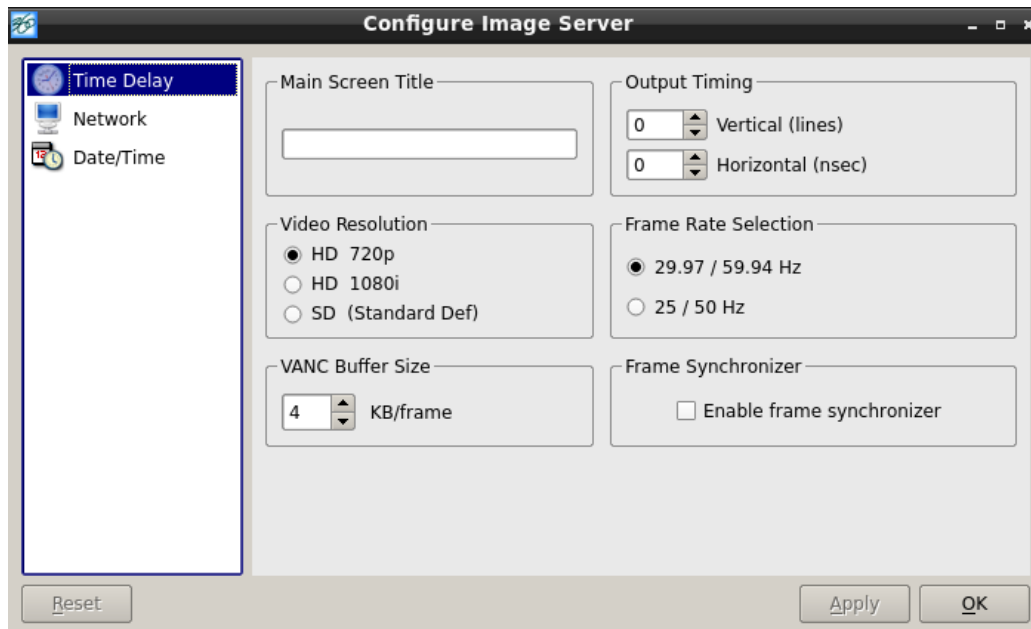

Configure Options Dialog

## Main Screen Title



This allows a user selected title to replace the default “TSS-2470 Time Delay” in the title bar of the main GUI window.

## Video Mode

Four radio buttons select the Video Mode, which includes the frame rate and video format. These are:

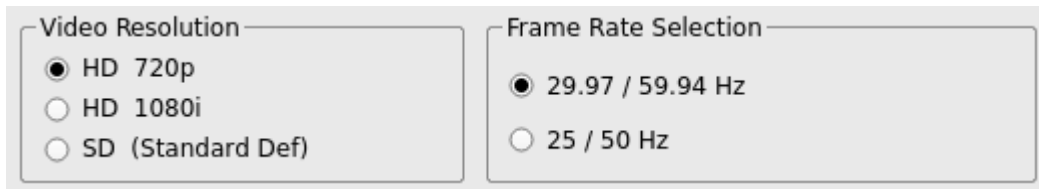

The screenshot shows two control panels. The first panel, titled "Video Resolution", contains three radio buttons: "HD 720p" (selected), "HD 1080i", and "SD (Standard Def)". The second panel, titled "Frame Rate Selection", contains two radio buttons: "29.97 / 59.94 Hz" (selected) and "25 / 50 Hz".

This setting can only be changed when the TSS-2470 Time Delay is stopped. When it is changed, the unit will display a warning and then automatically perform a quick restart to initialize in the newly selected mode.

## VANC Buffer Size

This field adjusts the amount of VANC data (such as Closed Captions) stored by the server. Valid range is from 0KB per frame to 4KB per frame. Consult with 360 Systems technicians before setting this to values higher than 4 KB/frame.



The screenshot shows a control panel titled "VANC Buffer Size" with a numeric input field containing the value "4" and a unit label "KB/frame".

## Output Timing

This controls the timing relationship of the output to the reference, which is the input video or the genlock reference as set by the Frame Synchronizer checkbox.

Note that these timing adjustments apply only to the Delay output, not the Monitor output. The monitor outputs are designed for confidence monitoring only, and are not timed.

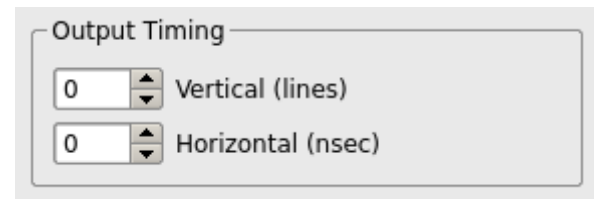

The screenshot shows a control panel titled "Output Timing" with two numeric input fields. The first field is labeled "Vertical (lines)" and contains the value "0". The second field is labeled "Horizontal (nsec)" and also contains the value "0".

In most applications these adjustments are not necessary. They are only used in environments where the output must be adjusted to match other timed equipment, for example when using a switcher or video mixer that requires precise timing alignment.

Both adjustments are made by using numeric entry from the keyboard or the Up and Down Arrow buttons next to the parameter's numeric display.

The Output Timing values are the only parameters that are adjustable while the TSS-2470 Time Delay is in RUN to allow timing while in operation. Adjustments take effect immediately without using Apply or OK, allowing the effects to be seen easily. The picture will blank while the change takes effect.



### **Vertical (Lines)**

Adjusts the output line timing in relation to the reference, by an amount equal to one complete line. The adjustment range is -4 to +30 lines.

### **Horizontal (nsec)**

Adjusts the output line timing in relation to the reference, by an amount equal to one half pixel. The adjustment range is  $\pm 100,000$ .

The Up/Down Arrow buttons increment in steps of 10 nsec.

### **Frame Synchronizer**

This makes the timing of the output reference the Genlock input rather than the input signal. This is used in systems where the output of the Time Delay is contributing to a timed system such as a video switcher.

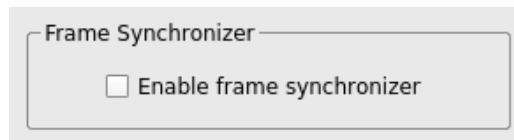

There must be a valid Black/burst or Tri-level sync signal present on the input before the delay recording process will start. If the signal is lost after that, the time delay will run from its internal generator until the reference signal returns. The internal sync generator is also referenced to the genlock and tries to maintain its rate when it is lost, so there will be little disturbance of the signal if the interruption is brief.

## Configure Network

Network parameters are set in the Configure Network dialog. Network communication for the TSS-2470 Time Delay is designed primarily to support access to error logs and factory diagnostics. It can also support automatic time updates using the NTP protocol. **The system time is used only in the diagnostic system message logs, it does not affect the operation of the TSS-2470 Time Delay in any way.** Therefore, it is not mandatory to connect the system to a network if you are not taking advantage of these features.

Use only the NET1 connection on the rear panel to connect to the network. Make no connection to NET2.

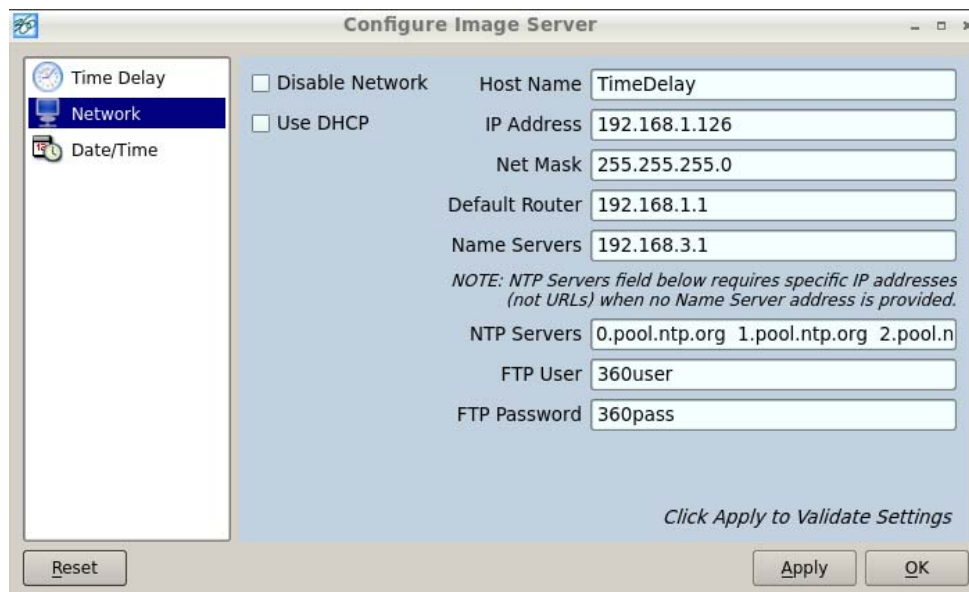

Configure Network dialog

Use the Configure Network dialog to configure network communication settings.

From the Main Menu selection bar at the top of the screen, select **Setup > Options**, then in the window on the left select Network.

Each TSS-2470 Time Delay is shipped with a unique default network Host Name and IP Address. Qualified network engineers may change these configurations to suit your specific network environment. Factory defaults for networking are:

- Disable Network is checked
- Use DHCP is unchecked

Do not connect the system to a network if you are not sure that the IP Address and other settings are appropriate for that network. If you must connect it, be sure that Disable Network is checked.

### Disable Network Checkbox

This selection turns the network off or on. The default is Disable.



## Use DHCP Checkbox

Enabling DHCP will configure the network interface automatically.

If the DHCP box is not selected, the user may then manually enter assignments in the following windows:

- Host Name
- IP Address
- Net Mask
- Default Router
- Name Server

Host Name may be a fully qualified domain name, such as edit1.mydomain.com. All other manually configured addresses must be properly formatted IP addresses.

## FTP User and Password

In order to obtain log files from the server for use when troubleshooting technical issues, you must FTP to the server from a remote computer. Setting the user name and password adds a layer of security so that accidental or unauthorized access to the server is not permitted.

## Saving Network Configuration

Click on OK or APPLY to accept new entries. To abandon unsaved changes and return to the current setting, click the red close box at the upper right of the dialog window.

Some changes may not take full effect until the TSS-2470 Time Delay is restarted. It is recommended that a full restart be performed after enabling DHCP.

## Date and Time

Date and Time are used only for display in the GUI and internal error-logging, the system time has no effect on the operation of the video delay.

From the Main Menu selection bar at the top of the screen, select Configure > Options, then select Date/Time in the window at left.

The date and time in the TSS-2470 Time Delay's system clock can be set by entering values in the Time Set window. To enable the NTP service, check the Automatic Updates box. A valid entry for at least one NTP server must be made in the Network setup dialog, and the network must be configured and connected. See the next section for information on NTP.

The date and time should only be set when the TSS-2470 Time Delay is in STOP mode.

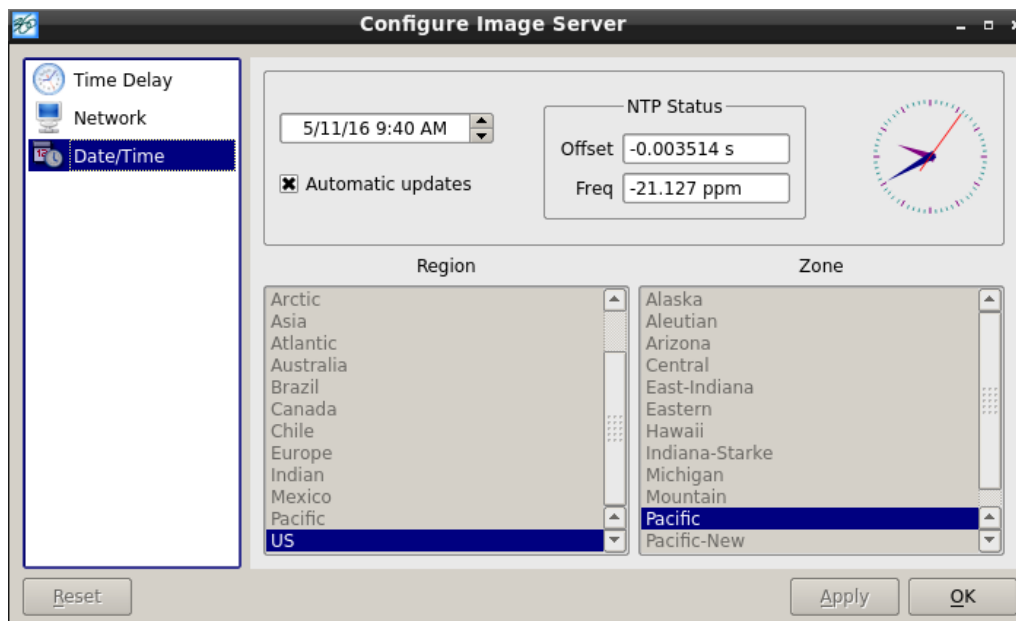

Date and Time dialog

## Network Time Protocol

### Automatic Date/Time Updates

The TSS-2470 Time Delay's clock can be set automatically from a network time server that is referenced to Coordinated Universal Time (UTC).

This is accomplished using the Network Time Protocol (NTP). A time server could be an in-house computer that is equipped with a GPS receiver, or a radio receiver locked to signals from the NIST radio station WWV. Alternatively, public time servers may be used which are accessible through an Internet connection.

## Connecting to the Network

To obtain automatic date/time updates from the public time servers on the Internet, you will need to provide the server with Internet access. Generally, servers would be connected on a secure high-speed local area network, with any Internet connection going through a router with an integrated firewall. The Network Time Protocol uses TCP/IP port number 123, so be sure the firewall is configured to allow access to this port per Figure 1.

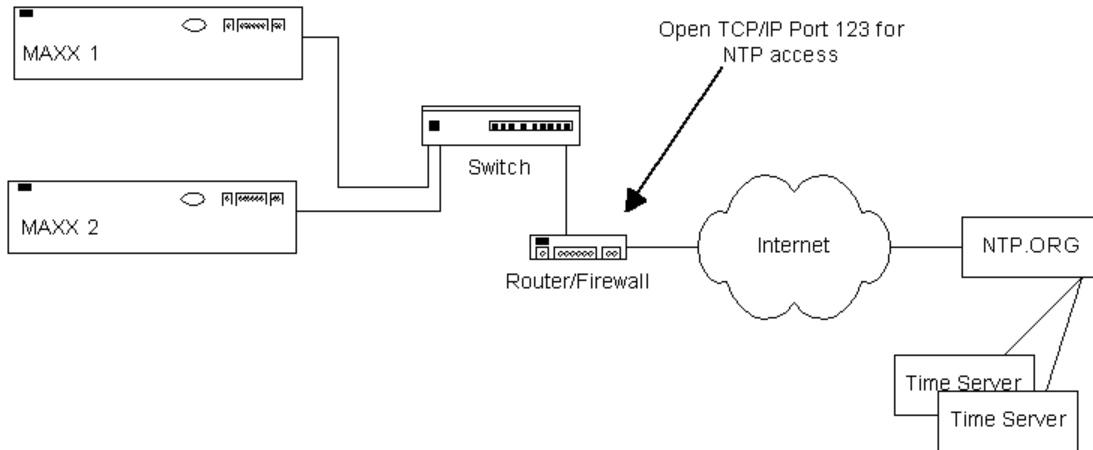

Figure 1 - NTP Network Block Diagram

## Configuring NTP

The TSS-2470 Time Delay GUI is used to set the time zone and to enter the networking parameters.

## Selecting the Time Zone

Starting at the main menu bar, Click **Edit->Configure->Date-Time screen**. When “Automatic Updates” is not checked, the Region and Zone lists are enabled. Select your region and then the zone within that region. There may be more than one way to your zone; America/New York, for example, is the same as US/Eastern. Click the **APPLY** button to activate the settings.

After changing the time zone a Full Restart must be performed before changes become effective.



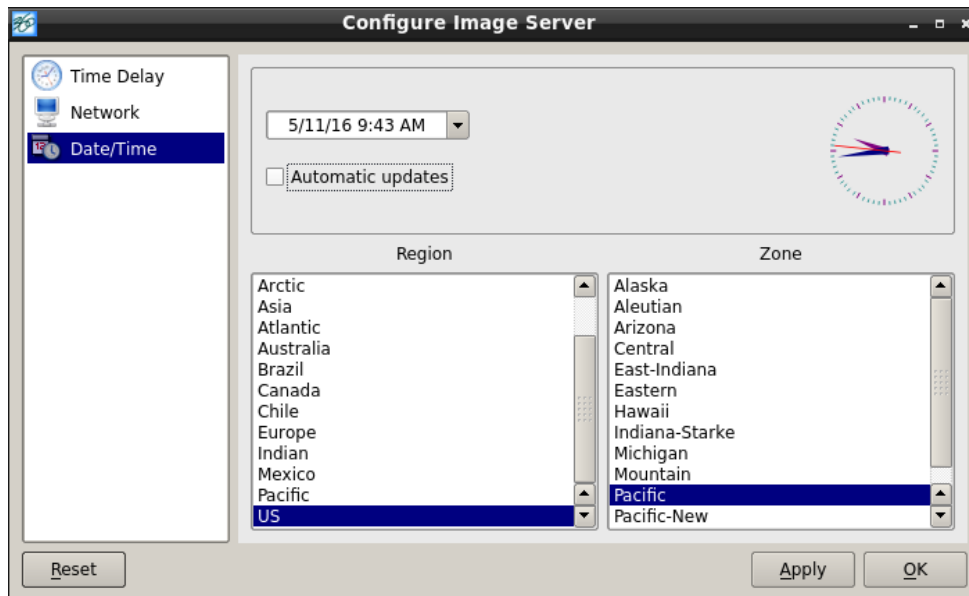

**Date/Time Configuration Screen**

### Entering Network Parameters

From the GUI's main menu bar, Click **EDIT > CONFIGURE > NETWORK**. The screen below appears. Make sure the basic network parameters have been entered.

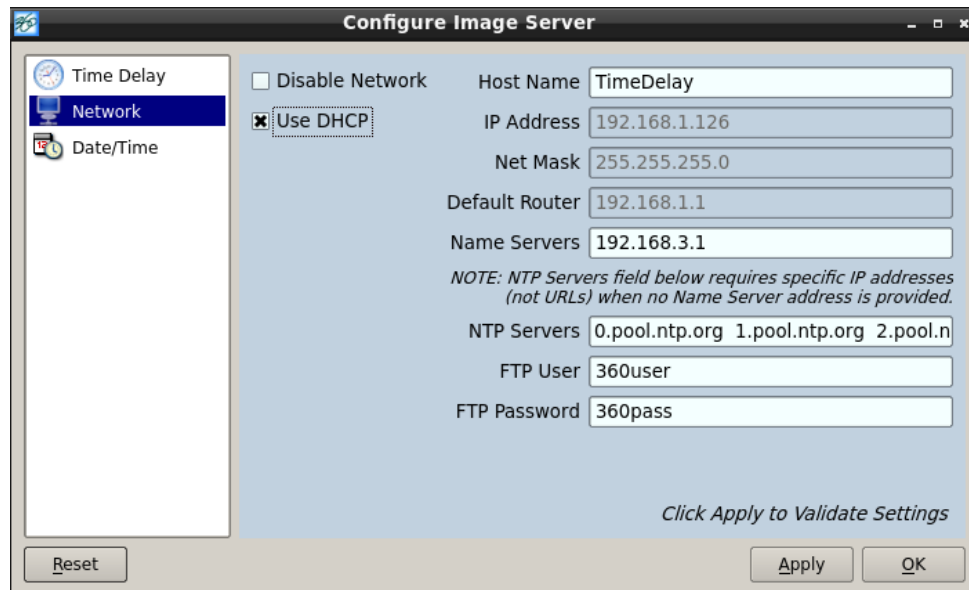

**Network Configuration Screen**



**Disable Network:** uncheck

**Host Name:** (Any name will suffice, but since this name appears on each line of the TSS-2470 Time Delay's diagnostic logs, it is a good idea to keep this short.) The name should also be unique from other devices on the network.

If "**Use DHCP**" if not checked, then enter a fixed IP address compatible with your local subnet. For example,

<b>IP Address:</b>	192.168.1.20
<b>Net Mask:</b>	255.255.255.0
<b>Default Router:</b>	192.168.1.1

Do not use these examples unless you know that they are appropriate, as addressing errors can cause problems for the entire network. If you are in doubt consult with your IT specialist.

The **Name Servers** and **NTP Servers** fields provide the information needed to reach the public time servers. **Note that NTP and the System Time in no way affects the accuracy of the Time Delay.**

The **NTP Servers** field contains a list of time servers, either by numeric IP address, or by site name (URL). Entries are separated by spaces.

The nonprofit Internet Systems Consortium, Inc. (ISC) maintains sites that automatically return lists of public time servers to an NTP client such as the server. Hence, the **NTP Servers** field is initially filled in with the URL's for these sites (0.pool.ntp.org, for example). Of course, this list with the addresses of specific time servers you may want to use can be overwritten. However, any attempt to clear the **NTP Servers** field will reset it to the default list.

**Note:** When URLs (non-numeric site address such as pool.ntp.org) are used in the **NTP Servers** field, the IP address of at least one DNS (Domain Name server) in the **Name Servers** field must be provided. Typically, this address is supplied by your Internet Service Provider.

These name servers translate URL names into numeric IP addresses needed to access the sites in question.

When using a GPS-based time server which is connected directly to a local area network, enter its numeric IP address (such as 192.168.1.60) into the **NTP Servers** field, leaving the **Name Servers** field blank.

Also, if the numeric IP addresses of the public or corporate time servers on the Internet is known, these addresses can be entered, separated by spaces, in the **NTP Servers** field, leaving the **Name Servers** field blank, since there would be no URLs to be resolved.

**Note:** Not all time servers allow unlimited public access. Refer to [www.ntp.org](http://www.ntp.org) for more information.

Click the **APPLY** button to save your changes.

## Technical Specifications

### Video

Time delay	Adjustable, 30 sec to >40 hrs.
Time set format	HH:MM:SS:FF (True number of frames per hour)
Video reference	Synchronizes to video input.
Accuracy	Frame accurate.
Inputs	1 HD-SDI/SD-SDI, 75Ω HDBNC connector
Outputs	1 delayed output, 1 E-E monitor. Each available as both HD-SDI/SD-SDI 75Ω HDBNC
Video standards	1080i, 720p, or SD (NTSC or PAL) selectable
Field (frame) rates	50 Hz (25 interlaced) or 59.94 Hz (29.97 interlaced) selectable
Compression format	

### Audio

Embedded Audio	16 channels Groups 1-4 per SMPTE 299M
Audio coding	48k sample rate, 24-bit word, Linear PCM

### Ancillary Data

Payload size	Selectable from 0 (no ancillary data saved) to 4 MB per field.
Closed Captions	Records and plays CC data from VANC per EIA-708B in HD, and will reproduce whatever method is used on the input signal as it relates to true 708 data or 608 data in 708 format. Records and plays Line 21 in picture in SD.

### Network Communications

Network port	Gigabit Ethernet
Transfer protocol	FTP
Data available	System log

### Disk Storage

Drives	(4) Serial ATA in RAID-5 array
Drive access	Accessible/replaceable from front panel

### Miscellaneous

Operating system	Linux®
Front panel indicators	LED: Power-on, Network Connectivity, System alarm
Miscellaneous ports	USB, SVGA display, Ethernet
Cooling	Forced air
Power	100 to 240 volts universal, 50/60 Hz, 165 watts
Mechanical	3½" x 19" x 18" (89 x 483 x 457 mm) H-W-D
Mounting	Rack mount (1U)
Weight	27 lb. (10.6 Kg) net
Country of origin	U.S.A.



## Connector Pin Designations

### HDBNC Connectors

The following note applies to all video and genlock connectors:

A HDBNC connector used as an output has a 75-ohm source impedance.

A HDBNC connector used as an input has a fixed 75-ohm termination.

### System Board Ports

Standard computer I/O ports on the TSS-2470 Time Delay include video monitor, keyboard, mouse, (USB) and two Gigabit Ethernet ports.

### SVGA Port

A VESA-compliant VGA or SVGA computer monitor should be connected to the 15-pin video port. The TSS-2470 Time Delay is pre-configured to an SVGA screen resolution of 1024 x 768 and 64,000 colors. The refresh rate will auto-negotiate with the attached monitor to achieve the best appearance. This resolution is best viewed on 17-inch or larger monitors. 360 Systems does not provide monitors for the TSS-2470 Time Delay.

Use only VESA compliant monitors with a maximum refresh rate of at least 75 Hz.

### Unused Ports

An unused RS-232 serial port may be present on the unit. This is not active and no connection should be made to it.

## Mechanical Drawing

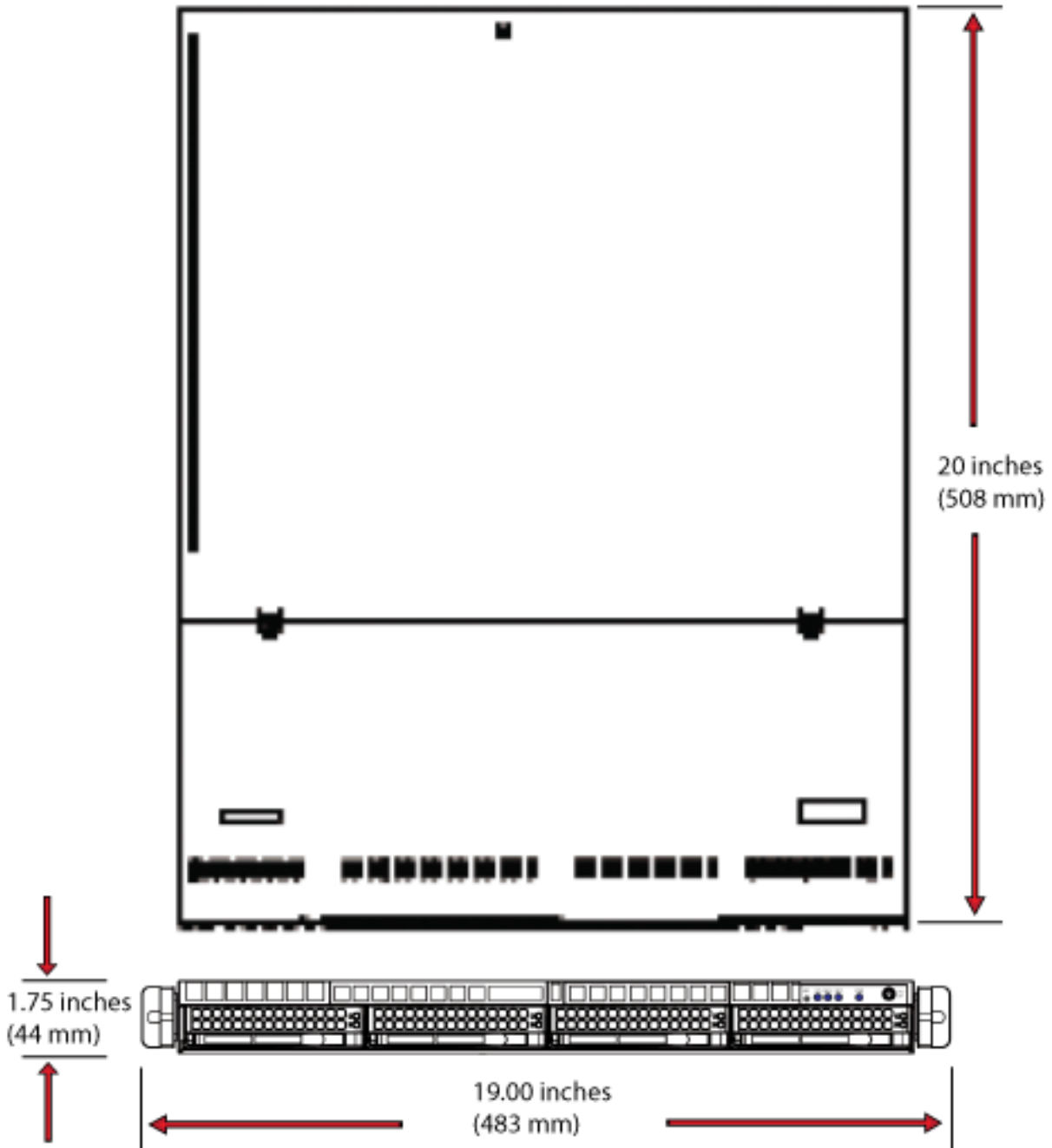

Dimensional Drawing



## Program Updates from USB Memory

Program updates for the TSS-2470 Time Delay may be issued from time to time. The operating system and application programs can be updated by the user from a USB Flash Drive distributed by 360 Systems.

The software version that is installed on the TSS-2470 may be determined by looking in the GUI **Help > About** dialog. In the top line there will be a number such as 1.08.561-211H. The software version is the first set of numbers before the "-", for example the current version at this writing is 1.08.561. The numbers after the "-" are the firmware version, currently 211. The final letter refers to the motherboard used, currently "H".

To install a program update, follow these instructions. Please read them completely before beginning.

1. Discontinue all record, play, network transfer or system-level operations.
2. With power applied, insert a 360 Systems USB Flash Drive into one of the USB sockets.
3. Press the front panel power switch briefly to shutdown the TSS-2470 Time Delay.
4. Wait 5 seconds, then press the front panel power switch again to boot from the USB Flash Drive.
5. The Installer menu provides a choice to Update the TSS-2470 Time Delay operating system, begin a new complete install, or cancel the install.

Choose Update to install or reinstall only the Software, without reformatting the RAID or losing your configuration data.

Choose NEW to partition and reformat the drive array, and install the new operating system. You will have to re-enter your configuration information once the installation is complete.

The message, "Please wait while server is being installed" will appear with an activity indicator. When installation is complete, the server will automatically reboot from its hard disk array, and will display a copyright notice while starting up.

6. **IMPORTANT!** Remove the USB Flash Drive. Never leave it plugged into the server.

## Maintenance

### Fault Diagnostics

#### Front Panel Indicators

The five LED indicators on the front panel are used to diagnose fault conditions. The meaning of each indicator is noted in the following table. During normal operation all five indicators will be on.

<b>POWER</b>	FLASHING indicates that there is a fault in the system power supply.	Shut down the TSS-2470 Time Delay and contact 360 Systems Customer Support for further hardware diagnosis.
<b>SYSTEM</b>	FLASHING indicates that the CPU fan is running slow, or stopped; or that the CPU temperature or voltage is not within manufacturer's specification.	Shut down the TSS-2470 Time Delay and contact 360 Systems Customer Support for further hardware diagnosis.

#### Other Error Indicators

The bottom line of the GUI will announce error conditions, in some cases giving further detail on the nature of a fault. For example, when the System light is flashing, the GUI may indicate a temperature error or a power supply voltage that is out of tolerance.

	Repairs should be performed only by qualified electronics technicians.
---	--

## Gigabit Ethernet Indicators

The Gigabit Ethernet port NET1 has the following indicator LEDs:

Label	Indication	Meaning
ACT/LNK (Left)	Green on	The port is connected to a valid link partner
	Green flashing	Data activity
	Off	No link
10=OFF 100=YELLOW 1000=GREEN (Right)	Off	10 Mbps
	Yellow flashing	100 Mbps
	Green	1000 Mbps

NET 2 is not active. Make no connection to this port.

## Access to Components

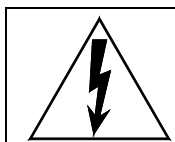

Be certain to shut down the TSS-2470 Time Delay, turn off the rear panel power switch and disconnect the power cord before opening the unit for service.

The following sections provide instruction on disassembly and re-assembly for maintenance.

The front panel is removed to allow access to the hard drives.

The top cover is removed to service an I/O card or fans.

## Removing the Front Panel

The front panel is easily removed for access to the four disk drives, or for removing the server from an equipment rack. Simply grasp the panel with both hands and pull on one side. The panel will snap off.

To re-install the front panel, Simply grasp the panel with both hands and push on one side, then the other. The panel will snap on.

NOTE: The TSS-2470 Time Delay is vulnerable to accidental system reset while removing or re-installing the front panel. It is recommended that the front panel be removed or attached only while the system is OFF.



## Removing the Top Cover

Using a No. 2 Philips head screwdriver, unscrew the two 6-32 Philips head screw attaching the top cover to the chassis. Push down on the two silver buttons on the top panel and slide the cover back to remove.

## General Handling Precautions

### ESD Precautions

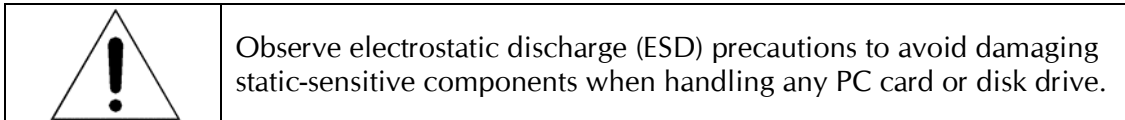

- When the case of your server is open and its internal parts are exposed, do not touch any internal part without first grounding yourself to the chassis.
- Always wear a ground strap or work on an ESD-protective mat.
- DO NOT remove components from protective packaging until you are properly grounded.
- Handle printed circuit boards by their edges or by the metal bracket.
- Don't touch any pin, contact, lead or component on the printed circuit boards.
- Keep disk drives in their anti-static package until installed in the server.

### Mechanical Concerns

- Be careful when installing I/O cards into your system. Excessive force can damage the PC boards, cables, hard drives or the motherboard.
- Be sure each board is aligned with its slot in the mating connector before installing. Use care to not flex any PC boards.
- Interface cable connectors must be mated carefully. Use care to not bend any of the pins. The connectors provided are keyed to prevent upside-down insertion.
- Interface cables are fragile and must not be pinched. Ensure that their dress does not restrict airflow from fans or heat sinks within the enclosure.
- Prior to installation, keep disk drives stored in a foam-lined protective carton to protect them from physical damage.



## **Installing/Removing I/O Cards**

Follow the preceding instructions to remove the top cover. The I/O cards are accessible from the top of the chassis.

### **Video I/O Card**

Slide the gray plastic locking tab up by gently pulling on the tab.

Slide the card out of the riser card to remove.

Reverse the procedure to install a card. After all the screws are reinstalled, check that the riser card, RAID card, and video card are all seated properly in their PCI connectors.

### **Accessing the Main System Board**

There are no user-configurable options on the main system board. If you suspect that the system board is not operating properly, consult with 360 Systems before proceeding. **DO NOT** undertake any repairs on it.

## Managing the RAID Disk Array

The RAID Disk Array is for the most part, self maintaining. Any errors that occur are generally automatically assessed and the proper steps are taken by the system to correct the errors. A BIOS level configuration utility is included on the system but is only used in conjunction with the initial setup of the drives.

A single drive fault should not cause data loss; but remember: the drive array is degraded and no longer has storage redundancy. Hence, another disk failure (or removal of the wrong disk) may cause a complete loss of data and system failure. After a drive failure it is strongly recommended that at the earliest time diagnostics be performed, and the server be taken off line while the RAID array is rebuilt.

### Error Notification and Repair

The TSS-2470 Time Delay will notify users in the event of a fault by an indicator in the GUI status bar, on the bottom of the screen and highlighted in yellow as shown below. A drive fault can be triggered by a variety of conditions. The first step in response to an error warning is to wait 10 minutes and see if the status indicator changes. In most cases the system will detect the error and initiate a rebuild process. The GUI will display an updated message indicating the percent of the drive rebuild.



GUI Drive Fault Indication

Status messages you may see on the status line:

- **Initializing**, indicated by "Initializing"
- **Degraded**, indicated by "Degraded"
- **Resyncing**, indicated by "Resyncing x%"
- **Recovering**, indicated by "Recovering x%"
- **Drive Removed**, indicated by "Drive 'n' removed" where 'n' corresponds the drive number of a drive that has either failed or been physically removed. Drives are numbered 0 through 3, 0 is the leftmost drive when viewing from the front of the unit.

"Recovering" or "Resyncing" is the process by which the array controller creates the data parity information or corrects data parity errors that may have occurred because of power loss, incorrect shutdown or some other data error.

The term "degraded" refers to the state of the Array data, not necessarily the hardware or disk drives themselves. It indicates that the parity information that protects the data is not up to date.

Parity errors may occur if the TSS-2470 Time Delay loses power, or is improperly shut off. No data will be lost, but the parity re-initialization process may take several hours. NEVER directly unplug the power cords from the unit without first properly shutting down the system. Shut down the system only by momentarily pressing the front panel **Power** button or selecting **Start > Shutdown > Shutdown** from the graphic user interface.



Note that in some cases the power may not automatically shut off after a Shutdown is executed. If the system does not turn itself off within three minutes, force the power off by holding the **Power** switch in until the unit turns off.

## Drive Replacement

If the array continues to indicate a failed drive, replace the drive. Although the drives are hot swappable and can be replaced while the system is running, it is recommended that if possible the unit be taken offline and powered off prior to conducting any maintenance or repairs.

If the drive is hot swapped, the system should recognize within no more than 5 minutes that a new drive has been installed, and start to rebuild the array.

If the rebuild process does not start automatically, it may be necessary to cycle power. If this does not result in the rebuild starting automatically, contact 360 Systems support.

When powering up with a newly replaced drive, the RAID boot up screen should indicate that the drive is present. Once the system has powered up the rebuild operation should start and be indicated in the status line. The system can be used immediately, but if possible allow the RAID to finish rebuilding before putting the system back in service. If the Recording process starts automatically, simply click the Stop button in the GUI.

A hard disk array ideally should be repaired using the same drive model and capacity as other drives in the array. Because specific drive models become unavailable as time goes on, 360 Systems recommends that maintenance spares be purchased at the same time as the server. It is possible to use a larger drive than the original, in this case the drive will be partitioned to match the size of the original.

When ordering spare drives, note carefully which model TSS-2470 Time Delay you have:

Model TSS-**2470** requires a 1 TB Western Digital WD 1003FBYX drive or currently qualified drive.

360 Systems part number 500-119-0035

The server hard disk drives have been factory tested and configured in a RAID 5 array. Each drive is numbered (0-3) and must be attached to the correctly numbered data cable. Drive bays are also numbered.

Please read *Removing the Front Panel* on page 32 for instructions on accessing the hard drive bays.

## Replacing a Hard Drive

Each hard drive bay is numbered 0 through 3, as are the drives. If for any reason one or more drives have been removed, they must be reinstalled in a bay whose number matches the drive. Installation in the wrong location will damage data stored on all drives.

Although the drives are hot swappable and can be replaced while the system is running, it is recommended that if possible the unit be taken offline and powered off prior to conducting any maintenance or repairs.

1. Turn system power OFF with the front panel button. After it has shut down, turn off the AC power switch and unplug the AC power cords.
2. Remove the front panel as described on page 32.

3. Release the lever on the front of the drive and pull the drive out of the chassis.
4. Replace the drive and fasten the holding plate in place.
5. Replace the front panel.
6. Replace the AC power cords and turn on the rear panel AC switch.
7. Turn the system ON using the front panel button and check the RAID array status.
8. Check for correct operation of the TSS-2470 Time Delay.

NOTE: All drives in the RAID array must be “RAID Enabled” or “RAID Edition” drives. Any replacement must have an actual capacity equal to or larger than the drives that existed when the array was originally created.

Drives that are advertised as being a particular size vary in actual size. Before attempting to rebuild an array, check that the size of the drive reported when it is installed is at least equal to or larger than the existing drives in the array. The size is reported in the bootup screen for the RAID system during power up.



## Notices

### Product Registration

**Important:** As the owner of new capital equipment, you will want to take advantage of product information, enhancements, upgrades, or notifications issued by 360 Systems. Please register your product so 360 Systems can remain in contact with you. To register your product, visit <http://360systems.com/support/product-registration/> or call our Customer Service Department at 818-991-0360.

### Product Improvements and Upgrades

360 Systems reserves the right to make changes and/or improvements to its products without incurring any obligation to incorporate such changes or improvements in units previously sold. Certain features mentioned in this document may not be present in all models. The TSS-2470 Time Delay is not offered for sale in all countries.

### Repair Policy

A product being returned under warranty shall be sent to 360 Systems, freight prepaid, in the original or equivalent packaging. Call 360 Systems for a return authorization number *before* returning a product.

Use the following address for shipping and correspondence. 360 Systems' offices are open Monday through Friday, from 8:30 AM to 5:00 PM, Pacific Time.

360 Systems	Telephone	(818) 991-0360
Customer Service Dept.	Fax	(818) 991-1360
3281 Grande Vista Drive,	E-mail	<a href="mailto:support@360systems.com">support@360systems.com</a>
Newbury Park, CA 91320	Website	<a href="http://www.360systems.com">www.360systems.com</a>

### Trademarks

360 Systems and 360 Systems Broadcast are trademarks or registered trademarks of 360 Systems in the U. S. and/or foreign countries. Other trademarks referred to in this document are the property of their respective owners.

### Software

Software in this product is based on the work of, or copyright by, 360 Systems, Montavista, Trolltech, and FreeType Team. Copyright 2003-2016 by 360 Systems.



## End User License Agreement

### For 360 Systems® TSS-2470 Time Delay Software

#### **IMPORTANT**

THIS IS A LEGAL AGREEMENT BETWEEN YOU (“YOU”) AND 360 SYSTEMS® (“COMPANY”). COMPANY IS WILLING TO LICENSE THE TSS-2470 TIME DELAY SOFTWARE TO YOU ONLY UPON THE CONDITION THAT YOU ACCEPT ALL OF THE TERMS CONTAINED IN THIS SOFTWARE LICENSE AGREEMENT (“AGREEMENT”). PLEASE READ THE TERMS CAREFULLY BEFORE OPENING THIS PACKAGE, OR IF DOWNLOADED, BEFORE INSTALLING THE SOFTWARE, AS OPENING THE PACKAGE, OR IN THE CASE OF DOWNLOADED SOFTWARE, INSTALLING IT, WILL INDICATE YOUR ASSENT TO THEM. IF YOU DO NOT AGREE TO THE LICENSE TERMS, THEN COMPANY IS UNWILLING TO LICENSE THE SOFTWARE TO YOU, IN WHICH EVENT YOU MAY RETURN THE UNOPENED SOFTWARE PACKAGE TO THE PLACE FROM WHICH IT WAS ACQUIRED WITHIN 14 DAYS OF THE DATE OF PURCHASE AND YOUR MONEY WILL BE REFUNDED. IF YOU ARE VIEWING THIS AGREEMENT ELECTRONICALLY, SELECT THE “ACCEPT” BUTTON AT THE BOTTOM OF THIS PAGE TO INDICATE YOUR ACCEPTANCE OF THE TERMS OF THIS AGREEMENT. IF YOU ARE NOT WILLING TO BE BOUND BY ITS TERMS, SELECT THE “DECLINE” BUTTON AT THE BOTTOM OF THIS PAGE AND THE REGISTRATION OR INSTALLATION PROCESS WILL NOT CONTINUE.

1. Company grants to You a non-exclusive license to use the TSS-2470 Time Delay software program (the “Software”) and any accompanying documentation (“Documentation”) solely for your internal business needs pursuant the terms and conditions of this Agreement. The license to use the Software is conditioned upon Your compliance with the terms of this Agreement. You shall be solely responsible for installation of the Software.

Your use of the Software is limited to the licensing option set forth on your invoice. Each licensing option is defined as follows:

Single User License. Software provided to You under this option may only be installed on any TSS-2470 owned or controlled by You, but in no event may it be used on more than one TSS-2470 at the same time.

Multiple User License. Software provided under this option may be installed on more than one TSS-2470 owned or controlled by You, the maximum number of which is indicated on the purchase invoice for this Software.

2. You may not transfer the Software to another entity or person. Any such transfer terminates your license under this Agreement. You shall not modify, translate, reverse assemble or reverse compile in whole or in part the Software that is provided in object code. You may not rent, sell, time-share, lease, sublicense, transfer, publish, disclose, display, or otherwise make available the object code or copies thereof to others. You may not make copies of the object code except as provided herein. You shall not tamper with, bypass or alter any security features of the Software or attempt to do so.
3. This license is not a sale. Title, ownership rights, and intellectual property rights in and to the Software and Documentation shall remain with the Company. You agree to abide by the copyright laws and all other applicable laws of the United States, your country, and international law. You acknowledge that the Software design remains a confidential trade secret of Company. Failure to comply with the above restrictions will result in automatic termination of this license and will make available to Company other legal remedies. You may not disclose any of Company’s proprietary or trade secret information relating



to the Software to any third party.

4. Company warrants that the Software will perform substantially in accordance with its Documentation. Your exclusive remedy for breach of this limited warranty and Company's entire liability shall be, in Company's discretion, either return of the price paid to Company by You for the Software, or repair or replacement of the Software after Software and Documentation are returned to Company with an applicable receipt. Company's warranty is void if failure of the Software has resulted from accident, abuse, modification or misapplication. COMPANY MAKES NO OTHER WARRANTIES, EXPRESS OR IMPLIED, WITH RESPECT TO THE SOFTWARE AND DOCUMENTATION, AND SPECIFICALLY DISCLAIMS THE IMPLIED WARRANTIES OF MERCHANTABILITY AND FITNESS FOR A PARTICULAR PURPOSE. COMPANY DOES NOT WARRANT THAT THE OPERATION OF THE SOFTWARE WILL BE UNINTERRUPTED OR ERROR FREE.
5. TO THE MAXIMUM EXTENT PERMITTED BY LAW, IN NO EVENT SHALL COMPANY BE LIABLE FOR ANY SPECIAL, INCIDENTAL, CONSEQUENTIAL OR PUNITIVE DAMAGES WHATSOEVER, INCLUDING ANY CLAIMS FOR LOST PROFITS, BUSINESS INTERRUPTION, LOST INFORMATION OR OTHER DAMAGES ARISING OUT OF THE USE OR INABILITY TO USE THE SOFTWARE. IN ALL EVENTS, COMPANY'S SOLE OBLIGATION OR LIABILITY UNDER THIS LICENSE IS THE REPLACEMENT OR REPAIR OF THE SOFTWARE OR A REFUND OF THE PURCHASE PRICE.
6. You may terminate the license granted in Section 1 of this Agreement at any time by destroying or erasing your copy of the Software. Company may terminate this Agreement immediately and without notice if you fail to comply with any term or condition of this Agreement. In the event of termination of this Agreement, all the sections of this Agreement will survive except for Section 1.
7. This Agreement shall be governed by and construed in accordance with the laws of the State of California, U.S.A., without reference to conflicts of laws provisions or the 1980 U. N. Convention on Contracts for the International Sale of Goods and, as to matters affecting copyrights, trademarks and patents, by U.S. federal law. Any dispute with respect to this Agreement shall be brought and heard either in the California state courts located in Los Angeles County, California, or the federal district court for the Central District, Western Division, located in Los Angeles, California. In such event, the parties to this Agreement each consent to the *in personam* jurisdiction and venue of such courts. The parties agree that service of process upon them in any such action may be made if delivered in person, by courier service, by telegram, by facsimile or by first class mail, and shall be deemed effectively given upon receipt.

This Agreement sets forth the entire agreement between You and Company pertaining to the licensing of the Software, and supersedes in its entirety any and all written or oral agreements previously existing between the parties with respect to such subject matter. If any provision of this Agreement is held invalid or unenforceable, such provision shall be revised to the extent necessary to cure the invalidity or unenforceability, and the remainder of this Agreement shall continue in full force and effect. In the event of any conflict between any provision of this Agreement and applicable law, the provisions of this Agreement affected shall be modified to remove such conflict and permit compliance with such law, and as so modified this Agreement shall continue in full force and effect. This Agreement may not be assigned without the consent of Company.





## Limited Warranty

This product is warranted to the original purchaser against defects in material and workmanship for a period of one year from the date of original purchase. This warranty covers parts and labor and is effective when the product is used without alteration for the purpose intended by 360 Systems. This warranty excludes products with modified or unauthorized software, that have been subject to misuse or neglect, that have been modified, repaired improperly or by unauthorized personnel, damaged by rough handling, abuse, improper operation, excessive temperature, lightning strike, static electricity, electrical surges or other electrical system malfunctions, improper or inadequate maintenance or care and that have been subject to use of unauthorized or non-conforming accessories or attachments. This warranty also excludes normal wear and deterioration occasioned by the use of the product.

If part of the product is defective, the entire product must be returned along with the original purchase receipt or other evidence of purchase and a description of the defect to 360 Systems, 3281 Grande Vista Drive, Newbury Park, California 91320. Upon receipt, its condition will be verified, and if the product qualifies for warranty coverage, 360 Systems will, at its option, repair or replace the product without charge. In the case of replacement, if the replacement for a defective product is no longer available, 360 Systems will replace it with a similar product or, if not available, a product of equal value.

### Disclaimer and Limitation of Liability

The liability of 360 Systems under the foregoing warranty is limited solely to the repair or replacement of defective material or workmanship and does not include any expense related to the shipment of the product to or from 360 Systems or compensation for any inconvenience or loss of use of the product while it is being repaired or replaced.

Except as expressly stated herein, 360 Systems makes no representations or warranties, either express or implied, of any kind with respect to the product. **EXCEPT AS EXPRESSLY STATED HEREIN, 360 SYSTEMS EXPRESSLY DISCLAIMS ALL WARRANTIES, EXPRESS OR IMPLIED, OF ANY KIND WITH RESPECT TO THE PRODUCT, INCLUDING WITHOUT LIMITATION WARRANTIES OF MERCHANTABILITY AND FITNESS FOR A PARTICULAR PURPOSE.**

360 SYSTEMS' SOLE LIABILITY UNDER THIS LIMITED WARRANTY SHALL BE THE REPAIR OR REPLACEMENT OF ANY DEFECTIVE PRODUCT OR ITS COMPONENTS DURING THE WARRANTY PERIOD. IN NO EVENT SHALL 360 SYSTEMS, ITS DIRECTORS, OFFICERS, EMPLOYEES OR REPRESENTATIVES BE LIABLE FOR DIRECT, CONSEQUENTIAL, PUNITIVE, SPECIAL OR INDIRECT DAMAGES, LOSS OF PROFITS, INCONVENIENCE OR ANY OTHER LOSSES DUE TO THE PRODUCT OR ITS OPERATION, DUE TO ITS FAILURE TO OPERATE IN ACCORDANCE WITH ITS SPECIFICATIONS.

Some states do not allow the exclusion or limitation of incidental or consequential damages under certain circumstances, so the above limitations and exclusions may not apply to you. This warranty gives you specific legal rights, and you may also have other rights which vary from state to state.



## Index

360 Systems	
Customer Service .....	38
E-mail .....	38
Fax.....	38
Telephone.....	38
Website .....	38
Address, 360 Systems.....	38
Configure Options Dialog .....	18
Connectors.....	14
BNC.....	28
Customer Service .....	38
Delay Hours Select.....	18
Disk Array	
Repair .....	35
Disk Array Management.....	35
Drawing	
Mechanical .....	29
Rear Panel.....	14
Fault Diagnostics.....	31
LEDs .....	13, 31
Front Panel	
Removing .....	32
Front Panel Features .....	13
Front Panel Indicators.....	31
Halt .....	35
Handling Precautions .....	33
Hard Drive	
Replacement.....	36
Horizontal (nsec) adjustment.....	20
I/O Card	
Video .....	34
Indicators .....	13
Installation .....	9
Installing Hard Disk Drives.....	36
Installing/Removing	
I/O Cards .....	34
KVM Switch .....	9
LED Indicators.....	31
Main Screen Title .....	18
Maintenance .....	31
Mechanical Concerns.....	33
Mechanical Drawing.....	29
Motherboard .....	34
Mounting .....	9
Network	
DHCP .....	22
Network Time Protocol .....	23
Notices, General .....	38
NTP .....	23
Output Timing .....	19, 20
Power Conditioning .....	10
Power LED .....	31
Power ON/OFF (Reset) Button.....	13
Program Updates from USB Memory.....	30
Quick Select Presets .....	18
Rack Mounting.....	9
RAID	
Repair.....	35
RAID Array Management .....	35
Rear Panel	
Drawing .....	14
Features .....	14
Indicators.....	32
Recommended UPS Models .....	11
Repair .....	38
Replacing a Hard Drive .....	36
Reset Button.....	13
RFI/EMI interference.....	11
Run/Stop Control.....	17
Service	
Access .....	32
Front Panel .....	32
Top Cover .....	33
Shutdown .....	35
Software Version.....	30
Symbols	
Warning And Information.....	4
System Board Ports.....	28
System Cooling .....	10
System LED .....	31
Time Delay Presets.....	18
Time Delay Setting.....	17
Time to Air .....	17
Timing, Output .....	19, 20
Top Cover	
Removing .....	33
Trouble Shooting.....	See Fault Diagnostics
UPS power conditioning .....	10
USB	
Program Updates .....	30
VANC Line Selection .....	19
Vertical (Lines) timing adjustment.....	20
Video I/O Card.....	34
Video Mode .....	19
Warranty.....	41