



Table of Contents

Usage Notice	2
Safety Information	2
Class B emissions limits.....	2
Important Safety Instruction.....	2
Precautions.....	4
Eye Safety Warnings.....	6
Introduction	7
Product Features	7
Package Overview	8
Product Overview.....	9
Main Unit.....	9
Control Panel.....	10
Rear View.....	11
Remote Control.....	12
Installation	13
Connecting the Projector.....	13
Connect to Computer / Notebook.....	13
Connect to Video Sources.....	14
Powering On / Off the Projector	15
Powering On the Projector	15
Powering Off the Projector	16
Warning Indicator.....	16
Adjusting the Projected Image.....	17
Adjusting the Projector's Height.....	17
Adjusting the Zoom / Focus.....	18
User Controls	19
Control Panel.....	19
Remote Control	20
On-screen Display Menus.....	22
How to operate.....	22
Menu Tree.....	23
Image	24
Display	30
Setup	34
Options	42
Appendices	49
Troubleshooting	49
Image Problems.....	49
Intermission Problems	51
Projector Status Indication.....	52
Remote Control Problems	53
Audio Problems	53
Replacing the Lamp.....	54
Cleaning the Projector	55
Compatibility Modes.....	56
Ceiling Installation.....	59
Optoma Global Offices.....	60
Regulation & Safety notices.....	62
Operation conditions.....	63

Safety Information

	The lightning flash with arrow head within an equilateral triangle is intended to alert the user to the presence of uninsulated "dangerous voltage" within the product's enclosure that may be of sufficient magnitude to constitute a risk of electric shock to persons.
	The exclamation point within an equilateral triangle is intended to alert the user to the presence of important operating and maintenance (servicing) instructions in the literature accompanying the appliance.

WARNING: TO REDUCE THE RISK OF FIRE OR ELECTRIC SHOCK, DO NOT EXPOSE THE PROJECTOR TO RAIN OR MOISTURE. DANGEROUS HIGH VOLTAGES ARE PRESENT INSIDE THE ENCLOSURE. DO NOT OPEN THE CABINET. REFER SERVICING TO QUALIFIED PERSONNEL ONLY.

Class B emissions limits

This Class B digital apparatus meets all requirements of the Canadian Interference-Causing Equipment Regulations.

Important Safety Instruction

1. Read these instructions - before using this projector.
2. Keep these instructions - for future reference.
3. Follow all instructions.
4. Install in accordance with the manufacturer's instructions :
 - A. **Do not block any ventilation openings.** To ensure reliable operation of the projector and to protect it from overheating, put the projector in a position and location that will not interfere with its proper ventilation. For example, do not place the projector on a bed, sofa, carpet, or similar surface that may block the ventilation openings. Do not put it in an enclosure, such as a bookcase or a cabinet that may keep air from flowing through its ventilation openings.
 - B. **Do not use this projector near water or moisture.** To reduce the risk of fire or electric shock, do not expose the projector to rain or moisture.
 - C. **Do not install near any heat sources,** such as radiators, heaters, stoves or other apparatus (including amplifiers) that produce heat.
5. Clean only with a dry cloth.
6. Only use attachments/accessories specified by the manufacturer.
7. Refer all servicing to qualified service personnel. Servicing is required when the projector has been damaged in any way, such as:
 - ❑ Power supply cord or plug is damaged.
 - ❑ Liquids have spilled or objects have fallen into the apparatus.
 - ❑ The projector has been exposed to rain or moisture, does not operate normally, or has been dropped.



Usage Notice

Do not attempt to service this projector yourself. Opening or removing covers may expose you to dangerous voltages or other hazards. Please call Optoma to be referred to an authorized service center near you.

8. Do not let objects or liquids enter the projector as they may touch dangerous voltage points or short-out parts that could result in a fire or electric shock.
9. See projector enclosure for safety related markings.
10. The projector should not be adjusted or repaired by anyone except properly qualified service personnel.

Precautions



Please follow all warnings, precautions and maintenance as recommended in this user's guide.



❖ When the lamp reaches the end of its life, the projector will not turn back on until the lamp module has been replaced. To replace the lamp, follow the procedures listed under “Replacing the Lamp” section on page 54.

- Warning - Do not look into the projector's lens when the lamp is on. The bright light may damage your eyes.
- Warning - To reduce the risk of fire or electric shock, do not expose this projector to rain or moisture.
- Warning - Please do not open or disassemble the projector as this may cause electric shock.
- Warning - When replacing the lamp, please allow unit to cool down, and follow all replacement instructions. See page 54.
- Warning - This projector will detect the life of the lamp itself. Please be sure to change the lamp when it shows warning messages.
- Warning - Use the “Lamp Reset” function from the on-screen display “Options | Lamp Settings” menu after replacing the lamp module (see page 48).
- Warning - When switching the projector off, please ensure the cooling cycle has been completed before disconnecting the power. Allow 90 seconds for the projector to cool down.
- Warning - Do not use the lens cap when projector is in operation.
- Warning - When the lamp is approaching the end of its life, the message “Lamp is approaching the end of its useful life” displays on the screen. Please contact your local reseller or service center to change the lamp as soon as possible.
- Warning - To reduce the risk of injury to the eyes, do not look directly into the laser beam on the remote control and do not point the laser beam into anyone's eyes. This remote control is equipped with a Class II laser that emits radiation.

Do:

- ❖ Turn off the product before cleaning.
- ❖ Use a soft cloth moistened with a mild detergent to clean the display housing.
- ❖ Disconnect the power plug from the AC outlet if the product is not being used for a long period of time.

Don't:

- ❖ Do not block the ventilation slots and openings on the unit.
- ❖ Do not use abrasive cleaners, waxes or solvents to clean the unit.
- ❖ Do not use under the following conditions:
 - In extremely hot, cold or humid environments. Ensure that the ambient room temperature is within 5-40 °C and relative humidity is 10-85% (max.), non-condensing.
 - In areas susceptible to excessive dust and dirt.
 - Near any appliance that generates a strong magnetic field.
 - In direct sunlight.

Eye Safety Warnings



- ■ Avoid staring directly into the projector's beam of light at all times.
- ■ Minimize standing facing into the beam. Keep your back to the beam as much as possible.
- ■ Using a stick or laser pointer is recommended to avoid the need for the presenter to enter the beam.
- ■ Ensure that projectors are located out of the line of sight from the screen to the audience; this ensures that, when presenters look at the audience, they do not also have to stare at the projector lamp. The best way to achieve this is by ceiling-mounting the projector rather than placing it on floor or table top.
- ■ When projector is used in a classroom, adequately supervise students when they are asked to point out something on the screen.
- ■ In order to minimize the lamp power needed, use room blinds to reduce ambient light levels.

Product Features

This product is a single chip 0.55" XGA series and 0.65" WXGA series DLP® projector. Outstanding features include:

- ◆ Texas Instruments Single chip DLP® Technology
- ◆ Computer Compatibility:
Apple Macintosh, iMac, and VESA Standards:
UXGA, SXGA+, SXGA, WXGA, WUXGA, XGA, SVGA, VGA
- ◆ Video Compatibility:
 - NTSC, NTSC4.43
 - PAL/PAL-M/PAL-N/SECAM
 - SDTV and EDTV compatible
 - HDTV compatible (720p, 1080i, 1080p)
- ◆ Auto source detection with user definable settings
- ◆ Fully featured IR remote control with laser pointer and mouse control
- ◆ User friendly multilingual On Screen Menu
- ◆ Advanced digital keystone correction and high quality full screen image re-scaling
- ◆ User friendly control panel
- ◆ One built-in speaker with 1 Watt amplifier
- ◆ Macintosh and PC compatible
- ◆ HDMI compatible
- ◆ Full 3D Support
- ◆ Eco AV Mute
- ◆ Wireless dongle support (via VGA port)

Introduction

Package Overview

This projector comes with all the items shown below. Check to make sure your unit is complete. Contact your dealer immediately if anything is missing.

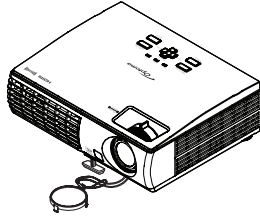

Projector with lens cover

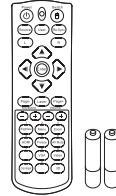

IR Remote Control with Laser Pointer
& Batteries (AAA *2 PCS)

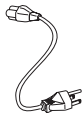

Power Cord



VGA Cable

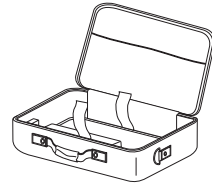

Carrying Case



❖ Due to the difference in applications for each country, some regions may have different accessories.

Documentation:

- User's Manual
- Warranty Card
- Quick Start Card
- WEEE Card (EMEA only)
- Stop Card (US only)

Product Overview

Main Unit

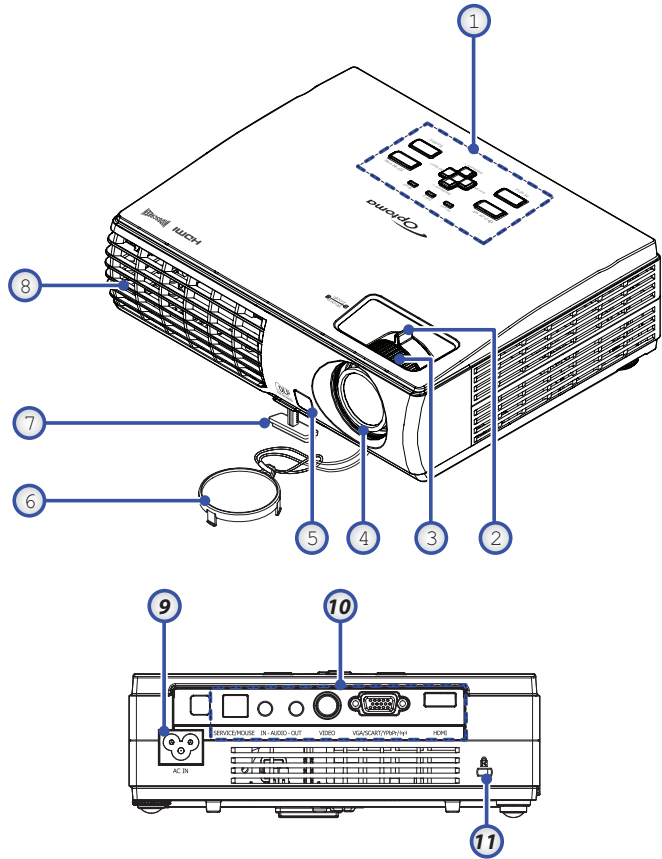

- | | |
|----------------------|----------------------|
| 1. Control Panel | 7. Elevator foot |
| 2. Zoom | 8. Ventilation |
| 3. Focus | 9. Power Socket |
| 4. Lens | 10. Connection Ports |
| 5. Front IR Receiver | 11. Kensington™ Lock |
| 6. Lens Cover | |

Introduction

Control Panel

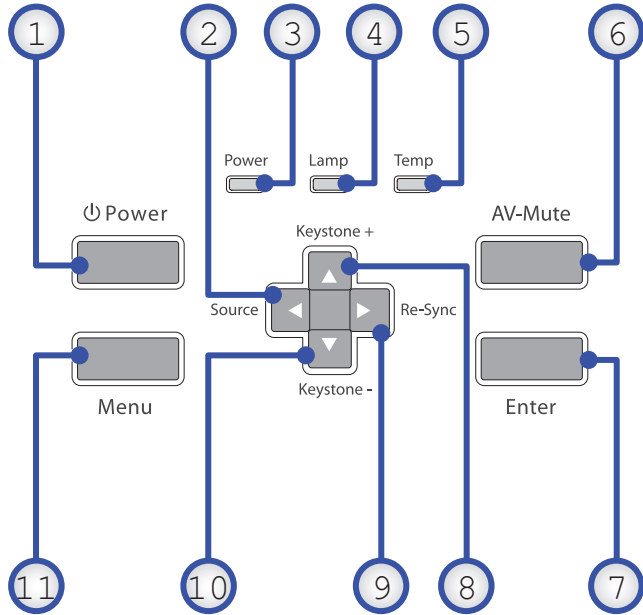

1. Power
2. ◀/Source (Left arrow)
3. Power LED
4. Lamp LED
5. Temp LED
6. AV-Mute
7. Enter
8. ▲/Keystone+ (Up arrow)
9. ▶/Re-Sync (Right arrow)
10. ▼/Keystone - (Down arrow)
11. Menu

Rear View

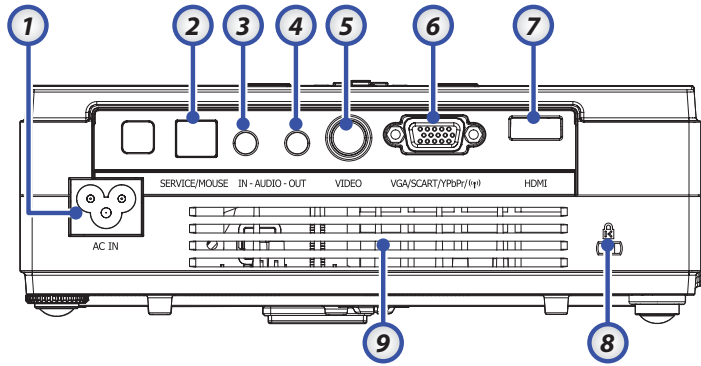

1. AC IN (Power)
2. SERVICE/MOUSE Connector
3. Audio Input Connector
4. Audio Output Connector
5. Video Input Connector
6. VGA/SCART/YPbPr/((Ⓜ)) Wireless Dongle
7. HDMI Connector
8. Kensington™ Lock Port
9. Ventilation Opening



❖ Wireless dongle is an optional accessory.

Introduction

Remote Control

1. User Button
2. Button LED
3. Switch Button
4. Re-Sync
5. Mouse Right Click
6. Laser Button
7. Page Up
8. Volume +/-
9. Zoom
10. Freeze
11. AV mute
12. Video Source
13. 3D Button
14. Number Buttons (for password input)
15. HDMI
16. Brightness
17. Menu
18. Keystone +/-
19. Page Down
20. Four Directional Select Keys (PC / Mouse Control when click Switch button)
21. Mouse Left Click
22. Source
23. Power On/Off

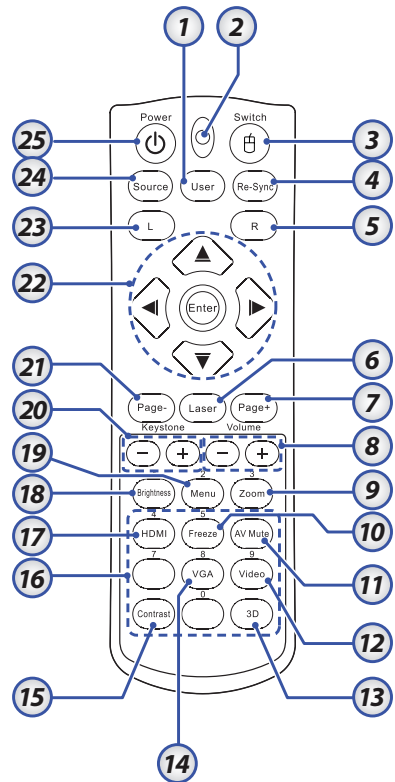

Connecting the Projector

Connect to Computer / Notebook

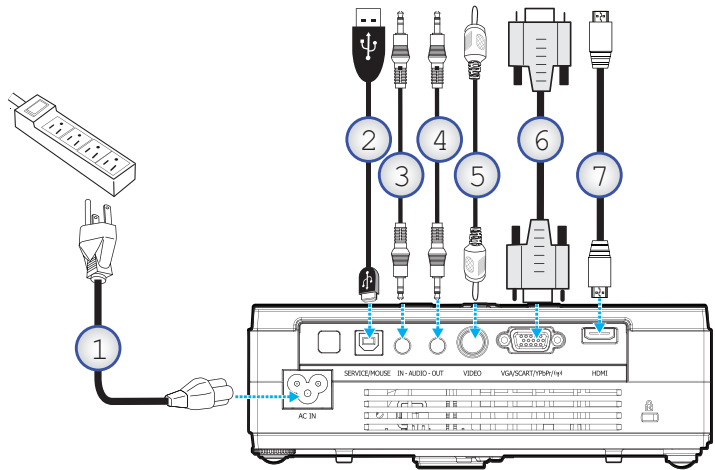

❖ Due to the difference in applications for each country, some regions may have different accessories.

1. Power Cord
2. USB Cable
3. Audio-in (mini jack)
4. Audio-out (mini jack)
5. Video Cable
6. VGA Cable
7. HDMI Cable

Installation

Connect to Video Sources

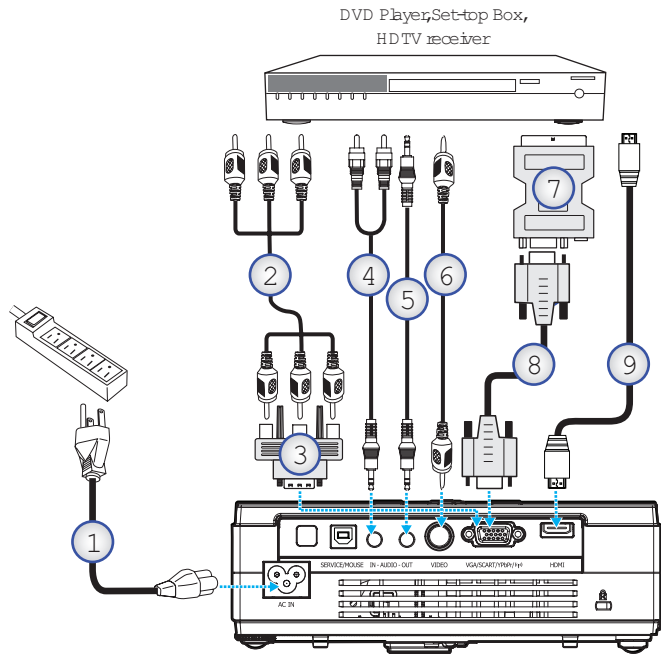

❖ Due to the difference in applications for each country, some regions may have different accessories.

1. Power Cord
2. Component Cable (optional)
3. RGB to Component Adapter (optional)
4. Stereo system cable (optional)
5. Stereo system cable (optional)
6. RCA Video Cable (optional)
7. SCART to RGB & S-Video Adapter (optional)
8. VGA Cable
9. HDMI Cable (optional)

Powering On / Off the Projector

Powering On the Projector

1. Connect the power cord to the projector.
2. Turn On the connected devices.

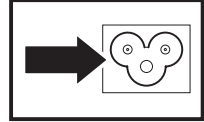

3. Ensure the Power LED is steady (flashing) and then press the Power button to turn On the projector.



- ❖ Turn on the projector first and then select the signal sources.

The projector splash screen displays and connected devices are detected. If the connected device is a PC, press the appropriate keys on the computer keyboard to switch the display output to the projector. (Check the user manual of the PC to determine the appropriate Fn key combination to change display output.)

See Setting an Access Password (Security Lock) on page 39 if security lock is enabled.





4. If more than one input device is connected, press the "Source" button to switch between devices sequentially.
For direct source selection, see page 21.
(DVD and HDTV are supported through the VGA connector)

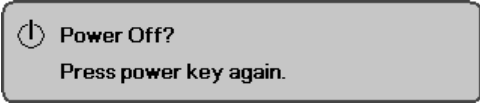

Powering Off the Projector

1. Press **Power** to turn off the projector lamp, a message displays on the projector's screen.



 **Power Off?**
Press power key again.

2. Press **Power** again to confirm, otherwise the message disappears after 15 seconds.
3. The cooling fans continue to operate for about 10 seconds for cooling cycle.
(If you wish to turn the projector back on, you must wait until the projector has completed the cooling cycle and has entered standby mode. Once in standby mode, simply press **Power** to restart the projector.)
4. Turn off the main power switch. Disconnect the power cord from the electrical outlet and the projector.
5. Do not turn on the projector immediately following a power off procedure.

Warning Indicator

- ❖ When the **POWER LED** indicator repeatedly blinks four (4) times, the projector will automatically shut itself down. Please contact your local reseller or service center. See pages 52.
- ❖ When the **TEMP LED** is on a steady (not flashing) red, the projector will automatically shut itself down. Under normal conditions, the projector can be switched on again after it has cooled down. If the problem persists, you should contact your local dealer or our service center. See pages 52.
- ❖ When the **LAMP LED** is on a steady **RED** (not flashing), it indicates the lamp system failed. Please contact your local dealer or our service center. See pages 52.

Adjusting the Projected Image

Adjusting the Projector's Height

Take note of the following when setting up the projector:

- The projector table or stand should be level and sturdy.
- Position the projector so that it is perpendicular to the screen.
- Ensure the cables are in a safe location. You could trip over them.

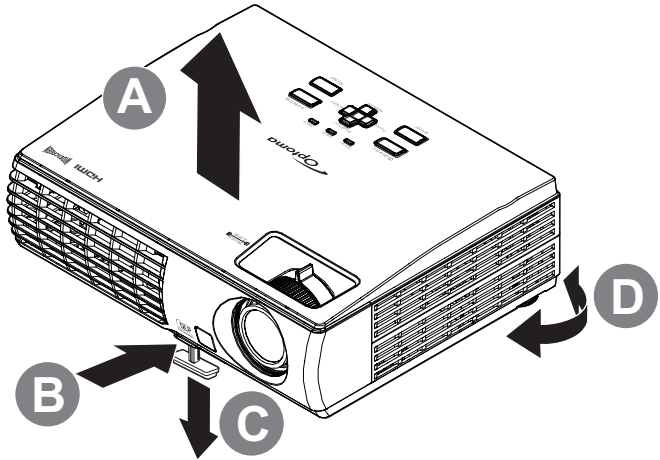

1. To raise the level of the projector, lift the projector [A] and press the height-adjuster button [B].

The height adjuster drops down [C].

2. To lower the level of the projector, press the height-adjuster button and push down on the top of the projector.
3. To adjust the angle of the picture, turn the tilt adjuster [D] right or left until desired angle achieved.

Installation

Adjusting the Zoom / Focus

1. Use the Image-zoom control (on the projector only) to resize the projected image and screen size [B].
2. Use the Image-focus control (on the projector only) to sharpen the projected image [A].
3. Use the keystone buttons to correct image distortion. They can be found on the remote control and on the projector's control panel.

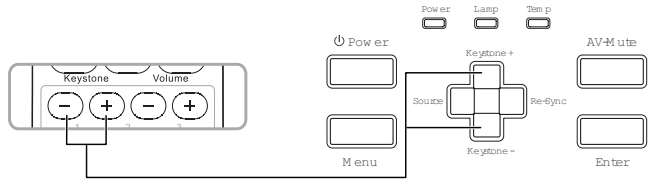
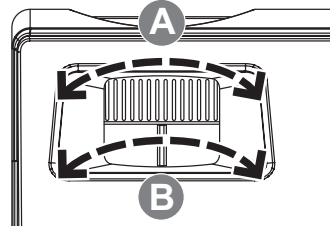

Control Panel

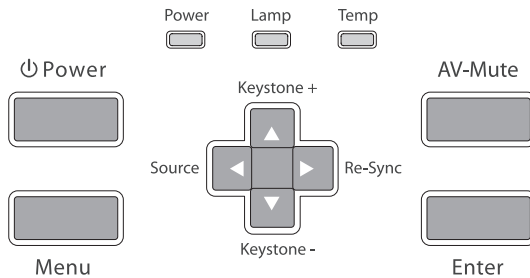

Using the Control Panel

Power	Refer to the “Power On/Off the Projector” section on page 15.	
Menu	Press Menu to launch the on-screen display (OSD) menu. To exit OSD, Press Menu again.	
▲/Keystone+ (Up arrow)	• Adjust the image Keystone positively.	• Navigates and changes settings in the OSD.
►/Re-Sync (Right arrow)	• Automatically synchronizes the projector to the input source.	• Navigates and changes settings in the OSD.
▼/Keystone - (Down arrow)	• Adjust the image Keystone negatively.	• Navigates and changes settings in the OSD.
◄/Source (Left arrow)	• Press Source to select an input signal.	• Navigates and changes settings in the OSD.
AV-Mute	Momentarily turns off / on the audio and video.	
Enter	Confirm your item selection.	
Power LED	Green	Unit is standby or powered on and working correctly.
	Flashing Green	Unit is warming up/cooling down / on Quick Resume (100 sec).
	Off	Unit is powered off.
Lamp LED	On	Lamp not ready – do not press the Power button.
	Off	Lamp is in normal state.
Temp LED	On	System over temperature
	Off	Normal state



❖ AV mute: Save up to 70% of the lamp power when AV mute is applied.

Remote Control

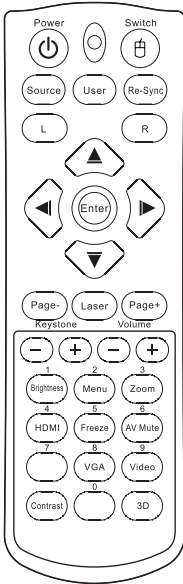

Using the Remote Control

Power		Refer to the "Power On/Off the Projector" section on page 15.
Switch		USB mouse switch.
Source		Press Source to select an input signal.
User		View the Remote Settings directly
Re-Sync		Automatically synchronizes the projector to the input source.
L Button		Mouse left click.
R Button		Mouse right click.
Four Directional Select Keys (PC / Mouse Control)		Use ▲▼◀▶ to select items or make adjustments to your selection. The PC/Mouse control can be used to control mouse movement. The mouse function is enabled using the USB cable to connect your computer and the projector.
Enter		Confirm your item selection.
Page -		Use this button to page down.
Laser		Aim the remote at the viewing screen, press and hold this button to activate the laser pointer.
Page +		Use this button to page up.
Keystone +/-		Adjusts image distortion caused by tilting the projector. (± 30 degrees)
Volume +/-		Adjusts to increase/decrease the volume.

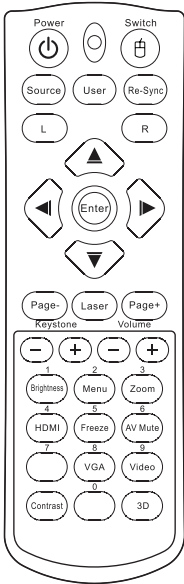

Using the Remote Control

Brightness	Adjust the brightness of the image.
Menu	Press Menu to launch the on-screen display (OSD) menu. To exit OSD, Press Menu again.
Zoom	Press +/- to zoom in of an image.
HDMI	Press HDMI to choose HDMI source.
Freeze	Press Freeze to pause the screen image.
AV Mute	Momentarily turns off/on the audio and video.
VGA	Press VGA to choose source from VGA- IN connector.
Video	Press Video to choose Composite video source.
Contrast	Adjust the contrast of the image.
3D	Press 3D to turn on/off 3D menu.

On-screen Display Menus

The Projector has multilingual On-screen Display menus that allow you to make image adjustments and change a variety of settings. The projector will automatically detect the source.

How to operate

1. To open the OSD menu, press **Menu** on the Remote Control or Projector Keypad.
2. When OSD is displayed, use ◀▶ keys to select any item in the main menu. While making a selection on a particular page, press ▼ or **Enter** to enter sub menu.
3. Use ▲▼ keys to select the desired item and adjust the settings by ◀▶ key.
4. Select the next item to be adjusted in the sub menu and adjust as described above.
5. Press **Enter** to confirm, and the screen will return to the main menu.
6. To exit, press **Menu** again. The OSD menu will close and the projector will automatically save the new settings.

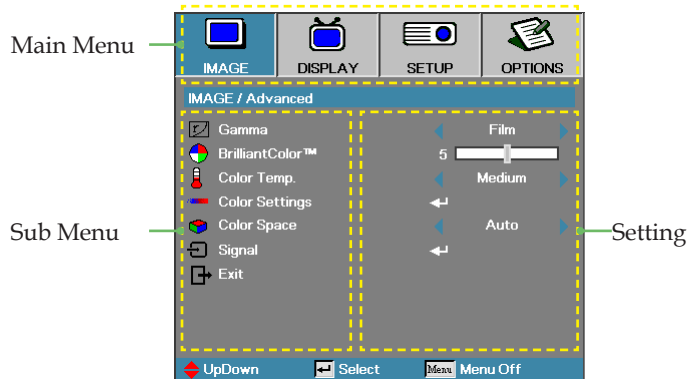

Menu Tree

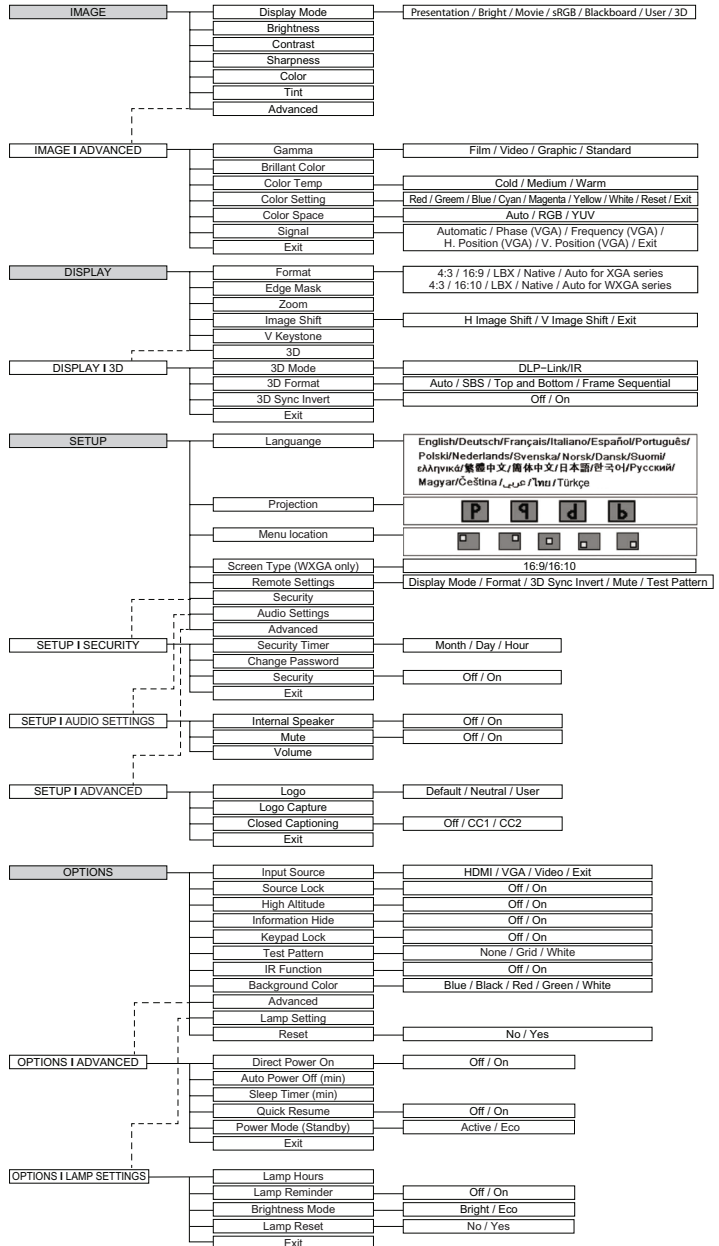

Image

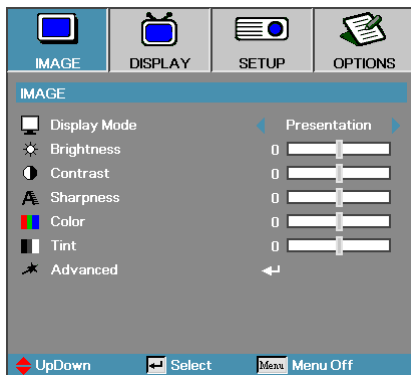

Display Mode

There are many factory presets optimized for various types of images.

- ▶ Presentation: Good color and brightness from PC input.
- ▶ Bright: Maximum brightness from PC input.
- ▶ Movie: For home theater.
- ▶ sRGB: Standardised accurate color.
- ▶ Blackboard: Best for Blackboard colors.
- ▶ User: User's own settings.

The initial default settings of this mode is from Presentation mode. Any further adjustments by the user will be saved in this mode for future use.

- ▶ 3D: User adjustable setting for 3D enable.

Brightness

Adjust the brightness of the image.

- ▶ Press ◀ to darken image.
- ▶ Press ▶ to lighten the image.

Contrast

The contrast controls the degree of difference between the lightest and darkest parts of the picture. Adjusting the contrast changes the amount of black and white in the image.

- ▶ Press ◀ to decrease the contrast.
- ▶ Press ▶ to increase the contrast.

Image

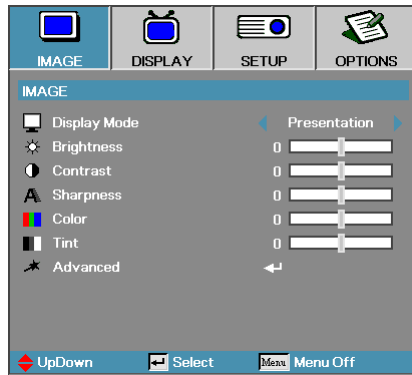

Sharpness

Adjusts the sharpness of the image.

- ▶ Press ◀ to decrease the sharpness.
- ▶ Press ▶ to increase the sharpness.

Color

Adjusts a video image from black and white to full color saturation.

- ▶ Press ◀ to decrease the amount of color in the image.
- ▶ Press ▶ to increase the amount of color in the image.

Tint

Adjusts the color balance of red and green.

- ▶ Press ◀ to increase the amount of green in the image.
- ▶ Press ▶ to increase the amount of red in the image.

Advanced

Enter the Advanced menu. Select advanced display options such as Gamma, Brilliant Color, Color Temp., Color Setting, Color Space, Signal, and Exit. See page 26 for more information.

Image | Advanced

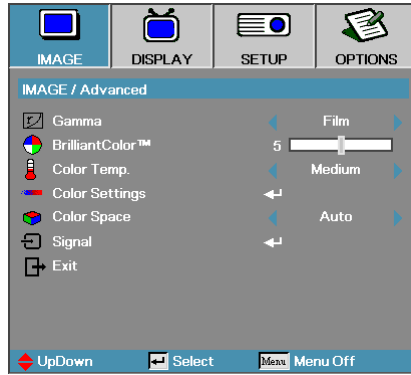

Gamma

This allows you to choose a gamma table that has been fine-tuned to bring out the best image quality for the input.

- ▶ Film – for home theater.
- ▶ Video – for video or TV source.
- ▶ Graphics – for image source.
- ▶ Standard – for PC or computer source.

Brilliant Color

This adjustable item utilizes a new color-processing algorithm and system level enhancements to enable higher brightness while providing true, more vibrant colors in picture. The range is from 0 to 10. If you prefer a stronger enhanced image, adjust toward the maximum setting. For a smoother, more natural image, adjust toward the minimum setting.

Color Temp

Adjust the color temperature. Cold temperature, the screen looks colder; with Warm temperature, the screen looks warmer.

Color Settings

Enter the Color Settings menu. See page 27 for more details.

Color Space

Select an appropriate color matrix type from AUTO, RGB, YUV.

Image | Advanced | Color Setting



Colors (Except White)

Press ▲▼ to select a color and press Enter to adjust the hue, saturation, and gain settings.

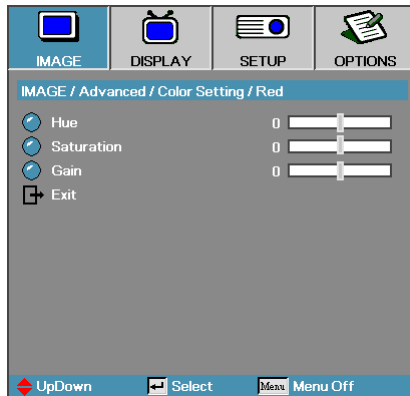

Press ▲▼ to select Hue, Saturation, or Gain and press ◀▶ to adjust the settings.

Image | Advanced | Color Setting



White

Press ▲▼ to select White and press **Enter**.

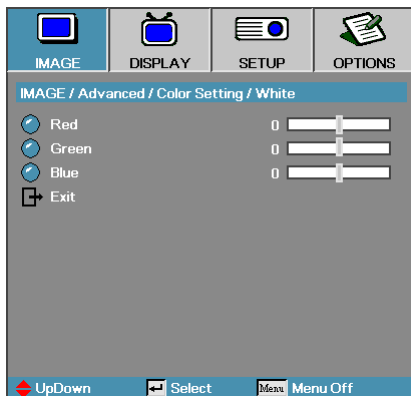

Press ▲▼ to select Red, Green, or Blue and press ◀▶ to adjust the settings.

Reset

Reset all Color Setting values to the factory default.

Image | Advanced | Signal

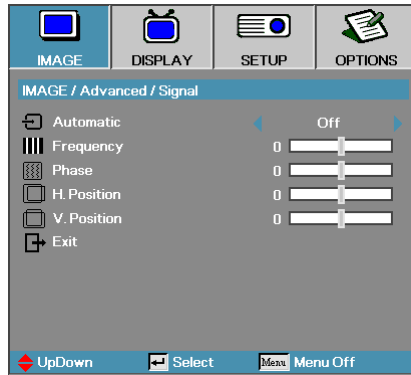

Automatic

Set Automatic to On or Off to lock or unlock the Phase and Frequency features.

- ▶ Off – disable auto lock.
- ▶ On – enable auto lock.

Frequency

Change the display data frequency to match the frequency of your computer's graphics card. If you experience a vertical flickering bar, use this function to make an adjustment.

Phase

Phase synchronizes the signal timing of the display with the graphic card. If you experience an unstable or flickering image, use this function to correct it.

H. Position

- ▶ Press ◀ to move the image left.
- ▶ Press ▶ to move the image right.

V. Position

- ▶ Press ▼ to move the image down.
- ▶ Press ▲ to move the image up.

Display

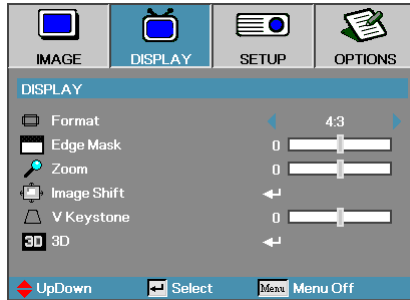

Format

Use this function to choose your desired aspect ratio.

- ▶ 4:3: This format is for 4x3 input sources not enhanced for Wide screen TV.
- ▶ 16:9 (XGA series)/16:10 (WXGA series): This format is for 16x9 input sources, like HDTV and DVD enhanced for Wide screen TV.
- ▶ Letter Box: This format is for non-16x9, letterbox source and for users who use an external 16x9 lens to display 2.35:1 aspect ratio using full resolution.
- ▶ Native: Depends on the resolution of the input source - No scaling is performed.
- ▶ Auto: Automatically selects the appropriate format.

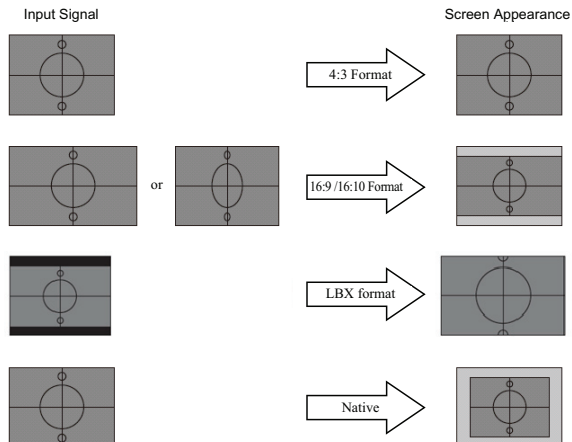

Detail information about LBX mode:

1. Some Letter-Box DVDs are not enhanced for 16x9 TVs. In this situation, the image will not look right when displayed in 16:9 mode.

In this situation, please try to using the 4:3 mode to view the DVD.

If the content is not 4:3, there will be black bars around the image in 16:9 display. For this type of the content, you can use LBX mode to fill the image on the 16:9 display.

2. If you use an external anamorphic lens, this LBX mode allows you to watch 2.35:1 content without black bars at the top and bottom of the screen. By doing so, lamp power and resolution are fully utilized.

Display

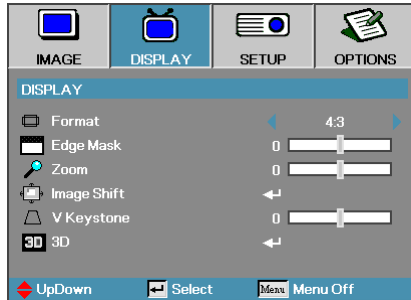

Edge Marsk

Edge Marsk function removes the noise in a video image. Edge Marsk the image to remove video encoding noise on the edge of video source.

Zoom

- ▶ Press ◀ to reduce the size of the image.
- ▶ Press ▶ to magnify an image on the projected screen.

Image Shift

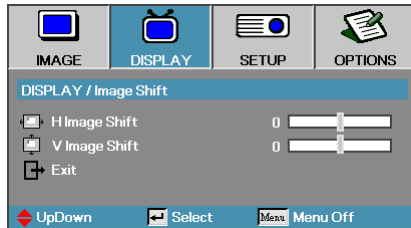

Shifts the projected image position.

- ▶ Press ▲ ▼ to select horizontally or vertically.
- ▶ Press ◀ ▶ to adjust settings.

V Keystone

Press ◀ or ▶ to compensate for vertical image distortion when the projector is positioned at an angle to the screen.

Display | 3D

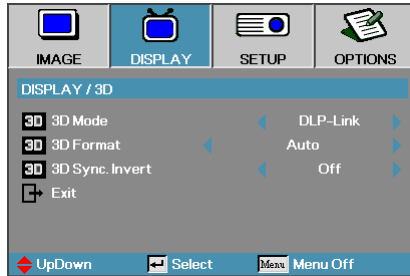

- ❖ IR options may vary according to model.
- ❖ 3D Sync Invert is only available when 3D is enabled and this mode 3D is for DLP link glass only.

3D Mode

- ▶ DLP Link: Select DLP Link to use optimized settings for DLP Link 3D Glasses.
- ▶ IR: Select IR to use optimized settings for IR-based 3D images.

3D Format

- ▶ Auto: When a 3D identification signal is detected, the 3D format is selected automatically.
- ▶ SBS: Display 3D signal in Side-by-Side format.
- ▶ Top and Bottom: Display 3D signal in Top and Bottom format.
- ▶ Frame Sequential: Display 3D signal in Frame Sequential format.

3D Sync. Invert

- ▶ Off – for default frame contents.
- ▶ On – invert left and right frame contents.

Setup

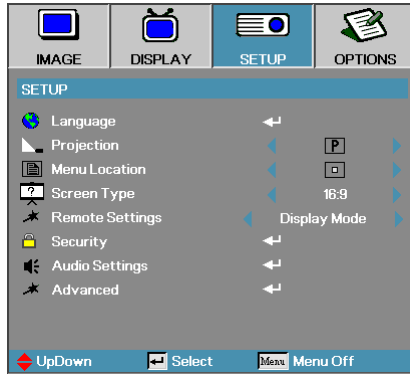

Language

Enter the Language menu. Select the multilingual OSD menu. See page 36 for more information.

Projection

Select projection method:

- ▶ **P** Front Desktop
The factory default setting.
- ▶ **R** Rear Desktop
When you select this function, the projector reverses the image so you can project behind a translucent screen.
- ▶ **d** Front Ceiling
When you select this function, the projector turns the image upside down for ceiling-mounted projection.
- ▶ **b** Rear Ceiling
When you select this function, the projector reverses and turns the image upside down at same time. You can project from behind a translucent screen with ceiling mounted projection.

Menu Location

Choose the menu location on the display screen.

Setup

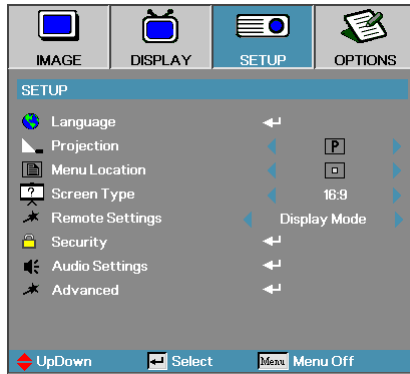

Screen Type

Press ◀▶ to set the aspect ratio to 16:9 or 16:10. This function only supports WXGA.

Remote Settings

Press ◀▶ to set the user key active function on IR.

Security

Enter the Security menu. Access the projector's security features. See page 37 for more information.

Audio Settings

Enter the Audio Settings menu.
See page 40 for more information.

Advanced

Enter the Advanced menu. Select the screen display during startup. See page 41 for more information.



- ❖ No password is required to access Setup | Security unless the Security Timer or Security Setting are enabled.

Setup | Language



Language

Choose the multilingual OSD menu. Press **Enter** into the sub menu and then use the Left (◀) or Right (▶) key to select your preferred language.

Setup | Security

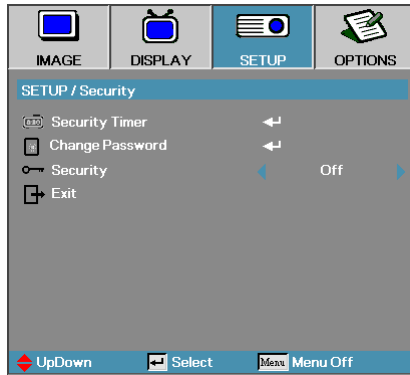

Security Timer

Enter the Security Timer sub menu.

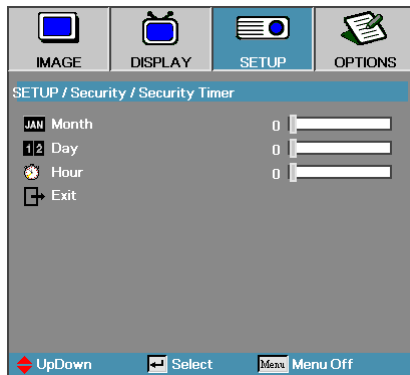

Enter the Months, Days, and hours that the projector can be used without entering the password. Exiting to the Setup menu activates the Security Timer.

Once activated, the projector requires a password on the specified dates and times to allow power on and access to the security menu.

If the projector is in use and the Security Timer is active, the following screen displays 60 seconds before the password is required.

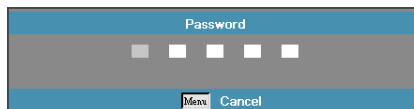

Setup | Security

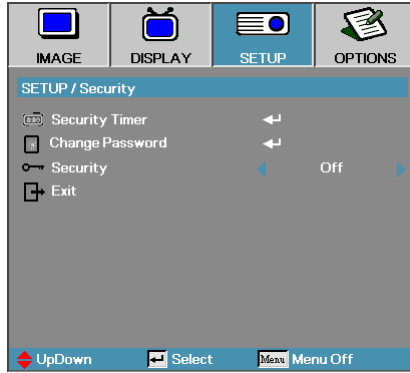

- ❖ If the incorrect password is entered three times, the device auto shutdowns after 10 seconds.

Change Password

Use this submenu to change the security password for the projector.

1. Select Change Password from the Security submenu. The Confirm Change Password dialog box displays.
2. Select **Yes**.

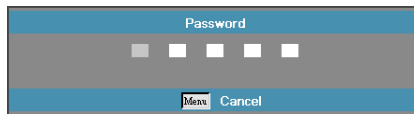

3. Enter the default password <1> <2> <3> <4> <5>. A second password screen displays.

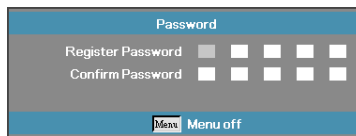

4. Enter the new password twice for verification.



- ❖ If the new passwords do not match, the password screen redisplay.

Setup | Security

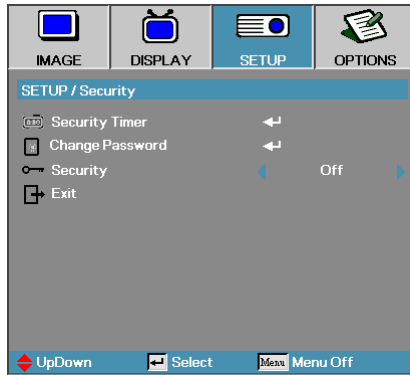

Security Setting

Enable or disable the security password.

- ▶ On – the current password is required to power on the projector and access the Security menu.
- ▶ Off – no password is required for any function.

When security is enabled, the following screen displays at startup and before access to the Security menu is allowed:

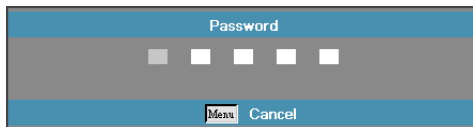

Setup | Audio Settings



Internal Speaker

- ▶ Off – turn off the internal speaker.
- ▶ On – turn on the internal speaker.

Mute

Toggle the audio on or off.

- ▶ Off – the speaker volume is turned on.
- ▶ On – the speaker volume is turned off.

Volume

- ▶ Press ◀ to decrease the volume of voice.
- ▶ Press ▶ to increase the volume of voice.

Setup | Advanced



Logo

Select the screen to display during startup.

- ▶ Default – the supplied default startup screen.
- ▶ Neutral – is Background Color.
- ▶ User – customized screen capture using the Logo Capture function.

Logo Capture

Capture a displayed screen to use as the startup screen.

1. Display the desired screen on the projector.
2. Select Logo Capture from the Advanced menu.

A confirmation screen displays.

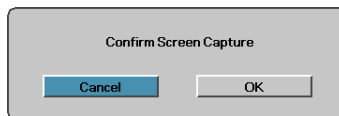

3. Select **OK**. Screen capture in progress.
Screen capture succeeded displays. The captured screen is saved as User in the Logo menu.

Closed Captioning

Select the screen to display closed captioning

- ▶ Off – the supplied default setting.
- ▶ CC1, CC2 – Closed captioning screen choices.



❖ Only one startup screen can be saved at once. Subsequent captures overwrite previous files limited in 3.5MB.

Options

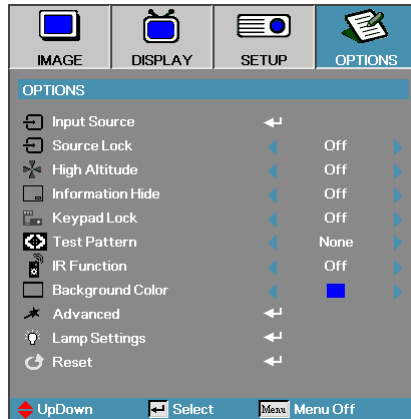

- ❖ If all sources are deselected, the projector cannot display any images. Always leave at least one source selected.

Input Source

Enter the Input Source menu.

See page 45 for more information.

Source Lock

Lock the current source as the only available source, even if the cable is unplugged.

- ▶ On – only the current source is recognized as an input source.
- ▶ Off – all sources selected in Image | Advanced | Input Source are recognized as an input source.

High Altitude

Adjust the fan speed to reflect the environment.

- ▶ On – increases fan speed for high temperature, humidity, or altitude.
- ▶ Off – regular fan speed for normal conditions.

Information Hide

Suppress informational messages on the projected screen.

- ▶ On – no status messages appear on screen during operation.
- ▶ Off – status messages appear as normal on screen during operation.

Options

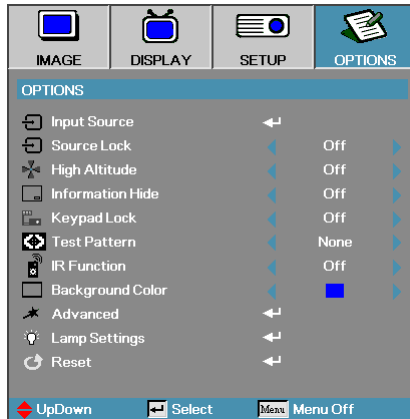

Keypad Lock

In the top left of display, message must over ride "Information Hide."

Every time Keypad is pressed, Keypad Lock logo displays again for 10 sec.

Keypad lock OSD. In the top left of display:



User could unlock keypad by following methods:

1. Press **Enter** on the keypad for 7 sec and the keypad is unlocked.
2. Use remote to access OSD menu to set "off".



In the top left of display, message must over ride "Information Hide."

Test Pattern

Display a test pattern. There are Grid, White and None.

Options

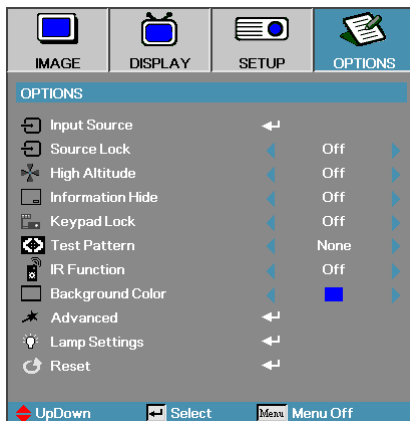

Advanced

Enter the Advanced menu. See page 46 for more information.

Lamp Setting

Enter the Lamp Setting menu.
See page 48 for more information.

Reset

Reset all Options to default factory settings.

Options | Input Source

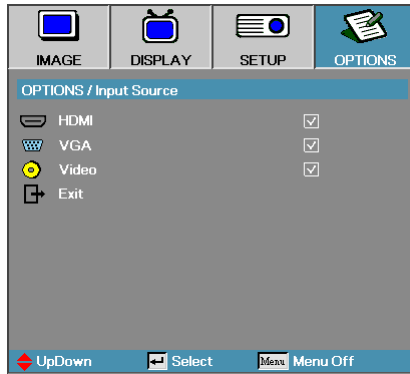

Use this option to enable / disable input sources. Press **Enter** to enter the sub menu and select which sources you require. Press **Enter** to finalize the selection. The projector will not search for inputs that are not selected.

Options | Advanced

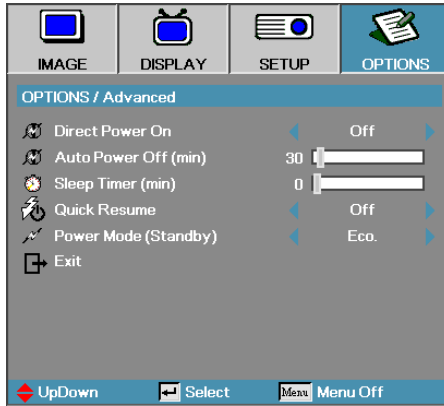

Direct Power On

Enable or disable Direct Power On.

- ▶ On—the projector powers on automatically when AC power is supplied.
- ▶ Off—the projector must be powered on as normal.

Auto Power Off

Set the Auto Power Off interval. The projector powers off the lamp after 30 minutes of no signal by default. The following warning is displayed 60 seconds before power off.

The projector will automatically shutdown after 60 sec.

Sleep Timer

Set the Sleep Timer interval. The projector powers off after the specified time period of inactivity (regardless of signal). The following warning is displayed 60 seconds before power off.

The projector will automatically shutdown after 60 sec.

Options | Advanced

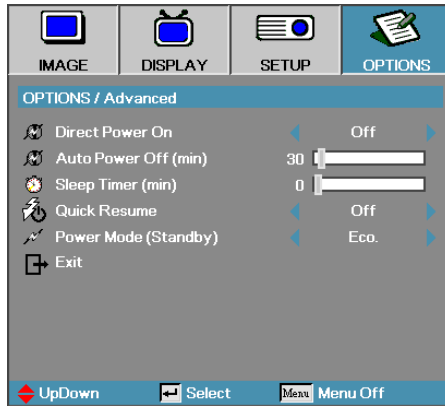

Quick Resume

If Quick Resume is On, the projector can resume operating soon provided the projector is turned back on within 100 seconds of being turned off.

Power Mode (Standby)

Set standby power mode status (upper to 0.5w or lower to 0.5w).

- ▶ Eco.—Choose Eco. to save power dissipation further < 0.5W.
- ▶ Active—Choose Active to return to normal standby and the VGA out port will be enabled.

Options | Lamp Setting

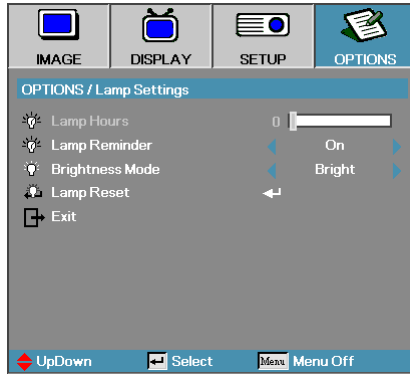

Lamp Hour

Displays the number of hours the lamp has been active. This item is for display only.

Lamp Reminder

Enable or disable the lamp life span reminder.

- ▶ On – a warning message displays when remaining lamp life is less than 30 hours.



- ▶ Off – no warning message displays.

Brightness Mode

Select the lamp brightness mode.

- ▶ Bright – the default setting.
- ▶ Eco – lower brightness setting to conserve lamp life.

Lamp Reset

After replacing the lamp, reset the lamp counter to accurately reflect the new lamp's life span.

1. Select Lamp Reset.
A confirmation screen displays.

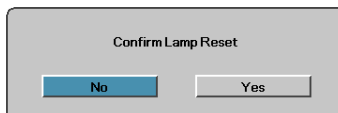

2. Select **Yes** to reset the lamp counter to zero.

Troubleshooting

If you experience a problem with your projector, please refer to the following information. If a problem persists, please contact your local reseller or service center.

Image Problems

No image appears on-screen

- ▶ Ensure all the cables and power connections are correctly and securely connected as described in the “**Installation**” section.
- ▶ Ensure all the pins of connectors are not bent or broken.
- ▶ Check if the projection lamp has been securely installed. Please refer to the “**Replacing the Lamp**” section.
- ▶ Make sure you have removed the lens cap and the projector is switched on.

Partial, scrolling or incorrectly displayed image

- ▶ Press **Re-Sync** on the remote.
- ▶ If you are using a PC:
For Windows 95, 98, 2000, XP:
 1. Open the **My Computer** icon, the **Control Panel** folder, and then double click on the **Display** icon.
 2. Select the **Settings** tab.
 3. Verify that your display resolution setting is lower than or equal to UXGA (1600 x 1200).
 4. Click on the **Advanced Properties** button.
 5. If the projector is still not projecting the whole image, you will also need to change the monitor display you are using. Refer to the following steps.
 6. Verify the resolution setting is lower than or equal to UXGA (1600 x 1200).
 7. Select the **Change** button under the **Monitor** tab.
 8. Click on **Show all devices**. Next, select **Standard monitor types** under the SP box; choose the resolution mode you need under the “Models” box.
 9. Verify that the resolution setting of the monitor display is lower than or equal to UXGA (1600 x 1200). (*)

- ▶ If you are using a Notebook:
 1. First, follow the steps above to adjust resolution of the computer.
 2. Press the toggle output settings. Example: [Fn]+[F4]

Acer ⇨	[Fn]+[F5]	IBM/Lenovo ⇨	[Fn]+[F7]
Asus ⇨	[Fn]+[F8]	HP/Compaq ⇨	[Fn]+[F4]
Dell ⇨	[Fn]+[F8]	NEC ⇨	[Fn]+[F3]
Gateway ⇨	[Fn]+[F4]	Toshiba ⇨	[Fn]+[F5]

Mac Apple:
System Preference ⇨ Display ⇨ Arrangement ⇨ Mirror display

If you experience difficulty changing resolutions or your monitor freezes, restart all equipment including the projector.

The screen of the Notebook or PowerBook computer is not displaying your presentation

- ▶ If you are using a Notebook:

Some Notebooks may deactivate their own screens when a second display device is in use. Each has a different way to be reactivated. Refer to your computer's manual for detailed information.

Image is unstable or flickering

- ▶ Use **Phase** to correct it. See page 29 for more information.
- ▶ Change the monitor color setting on your computer.

Image has vertical flickering bar

- ▶ Use **Frequency** to make an adjustment. See page 29 for more information.
- ▶ Check and reconfigure the display mode of your graphic card to make it compatible with the projector.

Image is out of focus

- ▶ Make sure the lens cap is removed.
- ▶ Adjusts the Focus Ring on the projector lens.
- ▶ Make sure the projection screen is between the required distances from the projector. See pages 17-18 for more information.

The image is stretched when displaying 16:9 DVD title

When you play anamorphic DVD or 16:9 DVD, the projector will show the best image in 16:9 format in OSD. If you play 4:3 format DVD title, please change the format as 4:3 in projector OSD. If the image is still stretched, you will also need to adjust the aspect ratio by referring to the following:

- ▶ Please setup the display format as 16:9 (wide) aspect ratio type on your DVD player.

Image is too small or too large

- ▶ Adjust the Zoom Ring on the top of the projector.
- ▶ Move the projector closer to or further from the screen.
- ▶ Press **Menu** button on the remote control or projector panel, go to **Display | Format** and try the different settings.

Image has slanted sides

- ▶ If possible, reposition the projector so that it is centered on the screen and below the bottom of the screen.
- ▶ Press **Keystone +/-** on the remote control until the sides are vertical.



❖ Use of Keystone is not recommended.

Image is reversed

- ▶ Select **Setup | Projection** from the OSD and adjust the projection direction.

Intermission Problems

The projector stops responding to all controls

- ▶ If possible, turn off the projector, then unplug the power cord and wait at least 60 seconds before reconnecting power.

Lamp burns out or makes a popping sound

- ▶ When the lamp reaches its end of life, it will burn out and may make a loud popping sound. If this happens, the projector will not turn on until the lamp module has been replaced. To replace the lamp, follow the procedures in Replacing the Lamp on page 54.

Projector Status Indication

Error Code Message	Power LED/ Flashes	TEMP LED Flashed	Lamp LED/ Flashes
Warm up or Cooling down	Flashing (0.5 sec)	0	0
Quick Resume (100 sec)	Flashing (0.25 sec)	0	0
T1 temperature over temperature	0	On	0
Thermal break	4	0	0
Lamp error	0	0	On
Lamp door open	7	0	0
DMD error	8	0	0
Color wheel error	9	0	0

Message Reminders

- ▶ Replacing the lamp:

 Lamp is approaching the end of its useful life

- ▶ Out of range: (see the following for more information)



Signal out of range
lower image resolution.

Remote Control Problems

If the remote control does not work

- ▶ Check the operating angle for the remote control is approximately $\pm 15^\circ$.
- ▶ Make sure there are no obstructions between the remote control and the projector. Move to within 7m (23 ft) of the projector.
- ▶ Make sure the batteries are inserted correctly.
- ▶ Replace weak batteries in the remote control.

Audio Problems

There is no sound

- ▶ Adjust the volume on the remote control.
- ▶ Adjust the volume of the audio source.
- ▶ Check the audio cable connection.
- ▶ Test the source audio output with other speakers.
- ▶ Have the projector serviced.

The sound is distorted

- ▶ Check the audio cable connection.
- ▶ Test the source audio output with other speakers.
- ▶ Have the projector serviced.

Replacing the Lamp

The projection lamp should be replaced when it burns out. It should only be replaced with a certified replacement part, which you can order from your local dealer.

Important:

- ▶ The lamp contains a certain amount of mercury and should be disposed of according to local ordinance regulations.
- ▶ Avoid touching the glass surface of the new lamp, doing so may shorten its operation life.



Warning:

- ▶ Be sure to turn off and unplug the projector at least an hour before replacing the lamp. Failure to do so could result in a severe burn.

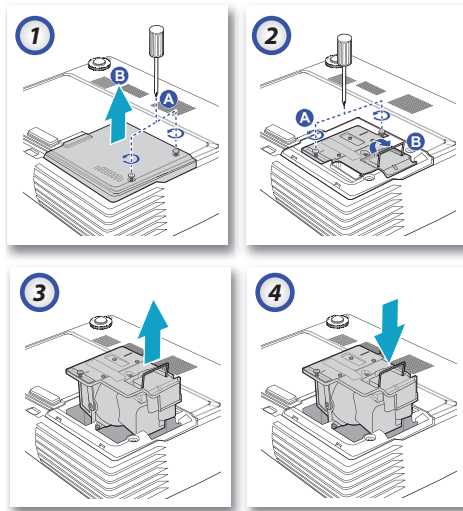

1. Loosen the two captive screws on the lamp compartment cover (A). Remove the lamp compartment cover (B).
2. Remove the two screws from the lamp module (A). Lift the module handle up (B).
3. Pull firmly on the module handle to remove the lamp module.
4. 5 & 6. Insertion is the reverse of removal.

After replacing the lamp, the lamp hours counter must be reset. See page 48 for more information.

Cleaning the Projector

Cleaning the projector to remove dust and grime will help ensure trouble-free operation.

Warning:

- ▶ Be sure to turn off and unplug the projector at least an hour before cleaning. Failure to do so could result in a severe burn.
- ▶ Use only a dampened cloth when cleaning. Do not allow water to enter the ventilation openings on the projector.
- ▶ If a little water gets into the projector interior while cleaning, leave unplugged in a well-ventilated room for several hours before using.
- ▶ If a lot of water gets into the projector interior when cleaning, have the projector serviced.

Cleaning the Lens

You can purchase optic lens cleaner from most camera stores. Refer to the following to clean the projector lens.

1. Apply a little optic lens cleaner to a clean soft cloth.
(Do not apply the cleaner directly to the lens.)
2. Lightly wipe the lens in a circular motion.

Caution:

- ▶ Do not use abrasive cleaners or solvents.
- ▶ To prevent discoloration or fading, avoid getting cleaner on the projector case.

Cleaning the Case

Refer to the following to clean the projector case.

1. Wipe off dust with a clean dampened cloth.
2. Moisten the cloth with warm water and mild detergent (such as used to wash dishes), and then wipe the case.
3. Rinse all detergent from the cloth and wipe the projector again.

Caution:

To prevent discoloration or fading of the case, do not use abrasive alcohol-based cleaners.

Compatibility Modes

Computer Compatibility (Analog RGB Compatible)

Signal	Resolution	Refresh Rate (Hz)	Notes for Mac
NTSC	-	60	
PAL/SECAM	-	50	
VGA	640 x 480	60 / 67 / 72 / 85	Mac 60 / 72 / 85
SVGA	800 x 600	56 / 60** / 72 / 85 / 120**	Mac 60 / 72 / 85
XGA	1024 x 768	60** / 70 / 75 / 85 / 120**	Mac 60 / 70 / 75 / 85
HDTV (720P)	1280 x 720	50 / 60** / 120**	Mac 60
WXGA	1280 x 768	60 / 75 / 85	Mac 60 / 75 / 85
	1280 x 800	60	Mac 60
	1366 x 768	60	Mac 60
SXGA	1280 x 1024	60 / 75 / 85	Mac 60 / 75
SXGA+	1400 x 1050	60	
UXGA	1600 x 1200	60	
HDTV (1080p)	1920 x 1080	24 / 50 / 60	Mac 60
WUXGA	1920 x 1200*	60	Mac 60

* 1920 x 1200 @60hz only support RB (reduced blanking).

** 3D timing for True 3D projector.

Input Signal for HDMI/DVI-D

Signal	Resolution	Refresh Rate (Hz)	Notes for Mac
VGA	640 x 480	60	Mac 60 / 72 / 85
SVGA	800 x 600	60** / 72 / 85 / 120**	Mac 60 / 72 / 85
XGA	1024 x 768	60** / 70 / 75 / 85 / 120**	Mac 60 / 70 / 75 / 85
SDTV (480I)	640 x 480	60	
SDTV (480P)	640 x 480	60	
SDTV (576I)	768 x 576	50	
SDTV (576P)	768 x 576	50	
WSVGA (1024 x 600)	1024 x 600	60	
HDTV (720p)	1280 x 720	50** / 60 / 120**	Mac 60
WXGA	1280 x 768	60 / 75 / 85	Mac 75
	1280 x 800	60	Mac 60
	1366 x 768	60	Mac 60
WXGA+	1440 x 900	60	Mac 60
SXGA	1280 x 1024	60 / 75 / 85	Mac 60 / 75
SXGA+	1400 x 1050	60	
UXGA	1600 x 1200	60	
HDTV (1080I)	1920 x 1080	50 / 60	
HDTV (1080p)	1920 x 1080	24/30/50/60	Mac 60
WUXGA	1920 x 1200*	60	Mac 60

* 1920 x 1200 @60hz only support RB (reduced blanking).

** 3D timing for True 3D projector.

True 3D Video Compatibility table (HDMI 3D Input)

Input Timing		
1280 x 720P @ 50Hz	Top - and - Bottom	
1280 x 720P @ 60Hz	Top - and - Bottom	
1280 x 720P @ 50Hz	Frame packing	
1280 x 720P @ 60Hz	Frame packing	
1920 x 1080i @50 Hz	Side- by-Side (Half)	
1920 x 1080i @60 Hz	Side- by-Side (Half)	
1920 x 1080P @24 Hz	Top - and - Bottom	
1920 x 1080P @24 Hz	Frame packing	
1920 x 1080i @ 50Hz	Side-by-Side(Half)	SBS mode is on
1920 x 1080i @ 60Hz		
1280 x 720P @50Hz		
1280 x 720P @60Hz	Top-and-Bottom	TAB mode is on
1920 x 1080i @ 50Hz		
1920 x 1080i @ 60Hz		
1280 x 720P @50Hz		
1280 x 720P @60Hz		
480i	HQFS	3D format is Frame sequential

- ▶ If 3D input is 1080p@24hz, the DMD should replay with integral multiple with 3D mode.
- ▶ 1080i@50hz and 720p@50hz will run in 100hz; other 3D timing will run in 120hz.

Ceiling Installation

To prevent damage to your projector please use the recommended mounting package for installation.

To ensure compliance, only use a UL Listed ceiling mount and screws that meet the following specifications:

M4 x 3 Ceiling Mounts, Maximum length 6mm

Refer to the following diagram to ceiling mount the projector.



- ❖ Damage to the projector as a result of incorrect installation voids the warranty.



- ❖ Ensure at least 10cm clearance between the ceiling and the underside of the projector.
- ❖ Avoid locating the projector near heat sources such as air conditioning and heaters. Excess heat may cause the projector to power off.

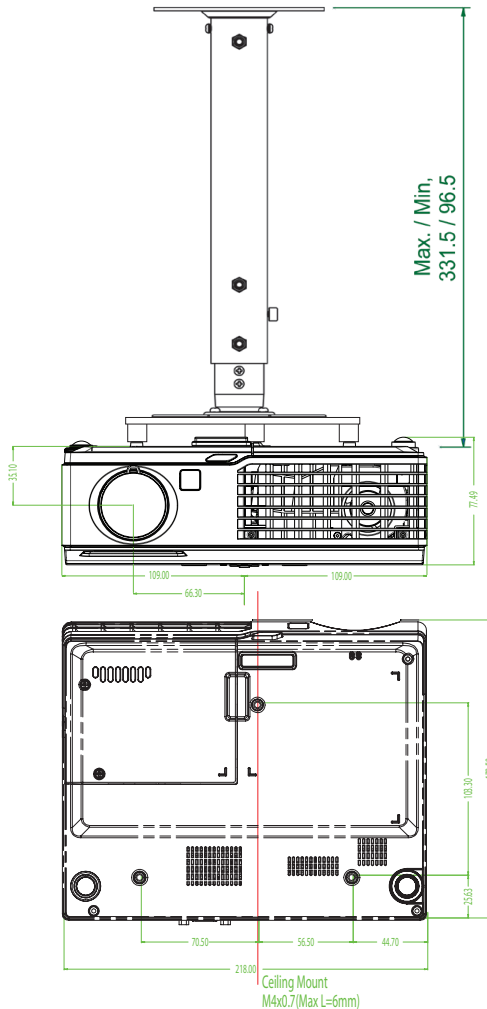

Optoma Global Offices

For service or support please contact your local office.

USA

715 Sycamore Drive
Milpitas, CA 95035, USA
Tel : 408-383-3700
www.optomausa.com

Fax : 408-383-3702
Service : services@optoma.com

Canada

5630 Kennedy Road, Mississauga,
ON, L4Z 2A9, Canada
Tel : 905-361-2582
www.optoma.ca

Fax : 905-361-2581

Europe

42 Caxton Way, The Watford Business Park
Watford, Hertfordshire, WD18 8QZ, UK
Tel : +44 (0) 1923 691 800
www.optoma.eu
Service Tel : +44 (0)1923 691865

Fax : +44 (0) 1923 691 888
Service: service@tsc-europe.com

France

Bâtiment E 81-83 avenue Edouard Vaillant
92100 Boulogne Billancourt, France
Tel.: +33 1 41 46 12 20
Service : savoptoma@optoma.fr

Fax : +33 1 41 46 94 35

Spain

C/ José Hierro, 36 Of, 1C
28529 Rivas Vacia, Madrid, Spain
Tel.: +34 91 499 06 06

Fax : +34 91 670 08 32

Deutschland

Werftstrasse 25 D40549
Düsseldorf, Germany
Tel : +49 (0) 211 506 6670
Service : info@optoma.de

Fax : +49 (0) 211 506 66799

Scandinavia

Grev Wedels Plass 2
3015 Drammen, Norway
Tel : +47 32 26 89 90
Service : info@optoma.no

Fax : +47 32 83 78 98

Latin America

715 Sycamore Drive
Milpitas, CA 95035, USA
Tel : 408-383-3700
www.optoma.com.br

Fax : 408-383-3702
www.optoma.com.mx

Korea

WOOMI TECH.CO.,LTD
4F,Minu Bldg.3.tw3-14, Kangnam-Ku, seoul,135-815, KOREA
Tel : +82+2+34430004
Fax : +82+2+34430005

Japan

東京都足立区綾瀬3-25-18
株式会社オーエスエム
サポートセンター:0120-46-5040
E-mail : info@osscreen.com

www.os-worldwide.com

Taiwan

12F., No.215, Sec. 3, Beixin Rd., Xindian Dist.,
New Taipei City 231, Taiwan (R.O.C.)
Tel: +886 2 8911 8600
www.optoma.com.tw
Service : services@optoma.com.tw

Fax:+886 2 8911 6550
asia.optoma.com

Hong Kong

Unit A, 27/F Dragon Centre, 79 Wing Hong Street,
Cheung Sha Wan, Kowloon, Hong Kong
Tel : +852-2396-8968
www.optoma.com.hk

Fax : +852-2370-1222

China

5F, No. 1205, Kaixuan Rd., Changning District
Shanghai, 200052, China
Tel : +86-21-62947376
www.optoma.com.cn

Fax : +86-21-62947375

Regulation & Safety notices

This appendix lists the general notices of your projector.

FCC notice

This device has been tested and found to comply with the limits for a Class B digital device pursuant to Part 15 of the FCC rules. These limits are designed to provide reasonable protection against harmful interference in a residential installation. This device generates, uses, and can radiate radio frequency energy and, if not installed and used in accordance with the instructions, may cause harmful interference to radio communications.

However, there is no guarantee that interference will not occur in a particular installation. If this device does cause harmful interference to radio or television reception, which can be determined by turning the device off and on, the user is encouraged to try to correct the interference by one or more of the following measures:

- ▶ Reorient or relocate the receiving antenna.
- ▶ Increase the separation between the device and receiver.
- ▶ Connect the device into an outlet on a circuit different from that to which the receiver is connected.
- ▶ Consult the dealer or an experienced radio/television technician for help.

Notice: Shielded cables

All connections to other computing devices must be made using shielded cables to maintain compliance with FCC regulations.

Caution

Changes or modifications not expressly approved by the manufacturer could void the user's authority, which is granted by the Federal Communications Commission, to operate this projector.

Operation conditions

This device complies with Part 15 of the FCC Rules. Operation is subject to the following two conditions:

1. This device may not cause harmful interference, and
2. This device must accept any interference received, including interference that may cause undesired operation.

Notice: Canadian users

This Class B digital apparatus complies with Canadian ICES-003.

Remarque à l'intention des utilisateurs canadiens

Cet appareil numérique de la classe B est conforme à la norme NMB-003 du Canada.

Declaration of Conformity for EU countries

- ▶ EMC Directive 2004/108/EC (including amendments)
- ▶ Low Voltage Directive 2006/95/EC
- ▶ R & TTE Directive 1999/5/EC (if product has RF function)

Disposal instructions



Do not throw this electronic device into the trash when discarding. To minimize pollution and ensure utmost protection of the global environment, please recycle it.