

**dbx**<sup>®</sup>  
PROFESSIONAL PRODUCTS

# 376

Vacuum Tube  
Channel Strip  
w/Digital Out

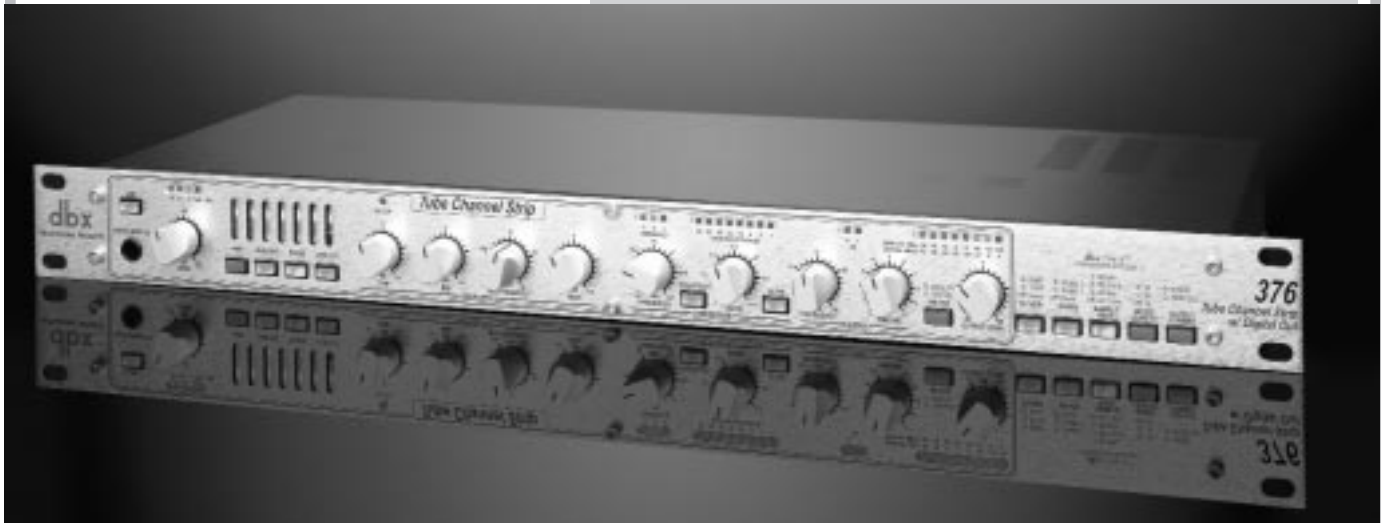

***User Manual***

# IMPORTANT SAFETY INSTRUCTIONS



**CAUTION**

RISK OF ELECTRIC SHOCK  
DO NOT OPEN



**ATTENTION:** RISQUE DE CHOC ELECTRIQUE - NE PAS OUVRIR

**WARNING:** TO REDUCE THE RISK OF FIRE OR ELECTRIC SHOCK DO NOT EXPOSE THIS EQUIPMENT TO RAIN OR MOISTURE

The symbols shown above are internationally accepted symbols that warn of potential hazards with electrical products. The lightning flash with arrowpoint in an equilateral triangle means that there are dangerous voltages present within the unit. The exclamation point in an equilateral triangle indicates that it is necessary for the user to refer to the owner's manual.

These symbols warn that there are no user serviceable parts inside the unit. Do not open the unit. Do not attempt to service the unit yourself. Refer all servicing to qualified personnel. Opening the chassis for any reason will void the manufacturer's warranty. Do not get the unit wet. If liquid is spilled on the unit, shut it off immediately and take it to a dealer for service. Disconnect the unit during storms to prevent damage.

## SAFETY INSTRUCTIONS

NOTICE FOR CUSTOMERS IF YOUR UNIT IS EQUIPPED WITH A POWER CORD.

**WARNING:** THIS APPLIANCE MUST BE EARTHED.

The cores in the mains lead are coloured in accordance with the following code:

GREEN and YELLOW - Earth    BLUE - Neutral    BROWN - Live

As colours of the cores in the mains lead of this appliance may not correspond with the coloured markings identifying the terminals in your plug, proceed as follows:

- The core which is coloured green and yellow must be connected to the terminal in the plug marked with the letter E, or with the earth symbol, or coloured green, or green and yellow.
- The core which is coloured blue must be connected to the terminal marked N or coloured black.
- The core which is coloured brown must be connected to the terminal marked L or coloured red.

This equipment may require the use of a different line cord, attachment plug, or both, depending on the available power source at installation. If the attachment plug needs to be changed, refer servicing to qualified service personnel who should refer to the table below. The green/yellow wire shall be connected directly to the units chassis.

CONDUCTOR		WIRE COLOR	
		Normal	Alt
L	LIVE	BROWN	BLACK
N	NEUTRAL	BLUE	WHITE
E	EARTH GND	GREEN/YEL	GREEN

**WARNING:** If the ground is defeated, certain fault conditions in the unit or in the system to which it is connected can result in full line voltage between chassis and earth ground. Severe injury or death can then result if the chassis and earth ground are touched simultaneously.

## WARNING FOR YOUR PROTECTION PLEASE READ THE FOLLOWING:

KEEP THESE INSTRUCTIONS

HEED ALL WARNINGS

FOLLOW ALL INSTRUCTIONS

CLEAN ONLY WITH A DAMP CLOTH.

DO NOT BLOCK ANY OF THE VENTILATION OPENINGS. INSTALL IN ACCORDANCE WITH THE MANUFACTURERS INSTRUCTIONS.

DO NOT INSTALL NEAR ANY HEAT SOURCES SUCH AS RADIATORS, HEAT REGISTERS, STOVES; OR OTHER APPARATUS (INCLUDING AMPLIFIERS) THAT PRODUCE HEAT.

ONLY USE ATTACHMENTS/ACCESSORIES SPECIFIED BY THE MANUFACTURER.

UNPLUG THIS APPARATUS DURING LIGHTNING STORMS OR WHEN UNUSED FOR LONG PERIODS OF TIME.

**WATER AND MOISTURE:** Appliance should not be used near water (e.g. near a bathtub, washbowl, kitchen sink, laundry tub, in a wet basement, or near a swimming pool, etc). Care should be taken so that objects do not fall and liquids are not spilled into the enclosure through openings.

**POWER SOURCES:** The appliance should be connected to a power supply only of the type described in the operating instructions or as marked on the appliance.

**GROUNDING OR POLARIZATION:** Precautions should be taken so that the grounding or polarization means of an appliance is not defeated.

**POWER CORD PROTECTION:** Power supply cords should be routed so that they are not likely to be walked on or pinched by items placed upon or against them, paying particular attention to cords at plugs, convenience receptacles, and the point where they exit from the appliance.

**SERVICING:** To reduce the risk of fire or electric shock, the user should not attempt to service the appliance beyond that described in the operating instructions. All other servicing should be referred to qualified service personnel.

**FOR UNITS EQUIPPED WITH EXTERNALLY ACCESSIBLE FUSE RECEPTACLE:** Replace fuse with same type and rating only.

**MULTIPLE-INPUT VOLTAGE:** This equipment may require the use of a different line cord, attachment plug, or both, depending on the available power source at installation. Connect this equipment only to the power source indicated on the equipment rear panel. To reduce the risk of fire or electric shock, refer servicing to qualified service personnel or equivalent.

# IMPORTANT SAFETY INSTRUCTIONS

## LITHIUM BATTERY WARNING

### CAUTION!

This product may contain a lithium battery. There is danger of explosion if the battery is incorrectly replaced. Replace only with an Eveready CR 2032 or equivalent. Make sure the battery is installed with the correct polarity. Discard used batteries according to manufacturer's instructions.

### ADVARSEL!

Lithiumbatteri - Eksplosjonsfare. Ved utskifting benyttes kun batteri som anbefalt av apparatfabrikanten. Brukt batteri returneres apparatleverandøren.

### ADVARSEL!

Lithiumbatteri - Eksplosjonsfare ved feilagtig håndtering. Udsiftning må kun ske med batteri av samme fabrikat og type. Levér det brugte batteri tilbage til leverandøren.

### VAROITUS!

Paristo voi räjähtää, jos se on virheellisesti asennettu. Vaihda paristo ainoastaan laitevalmistajan suosittelemaan tyyppiin. Hävitä käytetty paristo valmistajan ohjeiden mukaisesti.

### WARNING!

Explosionsfara vid felaktigt batteribyte. Använd samma batterityp eller en ekvivalent typ som rekommenderas av apparattilverkaren. Kassera använt batteri enligt fabrikantens instruktion.

## ELECTROMAGNETIC COMPATIBILITY

This unit conforms to the Product Specifications noted on the Declaration of Conformity. Operation is subject to the following two conditions:

- this device may not cause harmful interference, and
- this device must accept any interference received, including interference that may cause undesired operation.

Operation of this unit within significant electromagnetic fields should be avoided.

- use only shielded interconnecting cables.

## U.K. MAINS PLUG WARNING

A molded mains plug that has been cut off from the cord is unsafe. Discard the mains plug at a suitable disposal facility. NEVER UNDER ANY CIRCUMSTANCES SHOULD YOU INSERT A DAMAGED OR CUT MAINS PLUG INTO A 13 AMP POWER SOCKET. Do not use the mains plug without the fuse cover in place. Replacement fuse covers can be obtained from your local retailer. Replacement fuses are 13 amps and MUST be ASTA approved to BS1362.

## **DECLARATION OF CONFORMITY**

Manufacturer's Name: dbx Professional Products  
Manufacturer's Address: 8760 S. Sandy Parkway  
Sandy, Utah 84070, USA

declares that the product:

Product name: dbx 376  
Note: Product name may be suffixed by the letters - EU.  
Product option: N/A

conforms to the following Product Specifications:

EMC: EN 55013 (1990)  
EN 55020 (1991)

Supplementary Information:

The product herewith complies with the requirements of the Low Voltage Directive 72/23/EEC and the EMC Directive 89/336/EEC as amended by Directive 93/68/EEC.

dbx Professional Products  
Vice-President of Engineering  
8760 S. Sandy Parkway  
Sandy, Utah 84070, USA  
October 1, 2000

European Contact: Your local dbx Sales and Service Office  
or Harman Music Group  
8760 South Sandy Parkway  
Sandy, Utah 84070 USA  
Tel: (801) 568-7533  
Fax: (801) 568-7583

## Introduction

0.1 Defining the 376.....	i
0.2 Service Contact Info.....	ii
0.3 Warranty.....	ii
0.4 Installation Recommendations.....	iii

## Section 1 - Getting Started

1.1 Rear Panel Connections.....	2
1.2 Front Panel Connections.....	3
1.3 Type IV™ Conversion System Controls.....	4

## Section 2 - Analog Applications

2.1 Basic Connection.....	8
2.2 Connection to a Mixing Console.....	8
2.3 Direct Connection to a Recorder .....	9

## Section 3 - Digital Applications

3.1 Digital Output Front Panel Functions.....	12
3.2 Digital Rear Panel Connections.....	12
3.3 Sync Input Sample Rate Selection.....	13
3.4 Direct Connection to a DAW (CPU) .....	14
3.5 Direct Connection to a Digital Mixer.....	15
3.6 A/D Conversion.....	16
3.7 Multi-Tracking to Digital.....	17
3.8 Analog and Digital Output Applications .....	18

## Appendix

A- Sync Input Info.....	20
B- Block Diagram.....	21
C- dbx Type IV™ Conversion System.....	22
D.1 Noise-Shaping Algorithms.....	27
D.2 Truncation.....	27
D.3 Specifications .....	28

376

INTRODUCTION

INTRO  
CUSTOMER SERVICE INFO  
376 DEFINED  
WARRANTY INFO

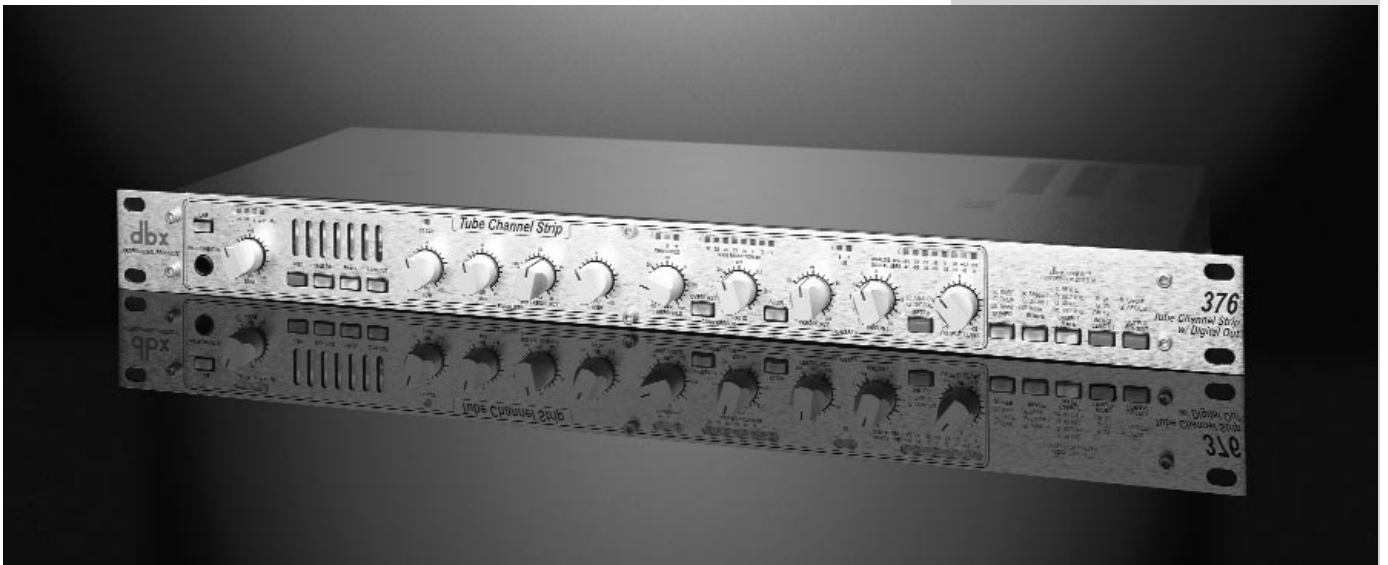

**dbx**<sup>®</sup>  
PROFESSIONAL PRODUCTS

## INTRODUCTION

Congratulations on your purchase of the dbx 376 Vacuum Tube Channel Strip with digital capabilities. For over 25 years, dbx has been the industry leader in dynamics processing. With the introduction of the 376, the standard for channel strip processors has now been completely redefined. Conventional channel strip processors are often limited in their ability to color and control the tonal characteristics of a vocal or mic'd application. The 376 however, offers, a **Vacuum Tube Preamp section**, a **3-Band Parametric EQ** section, built-in **Compressor** and **De-Essing** capabilities. In addition to the impressive list of effects available, the 376 also offers the state-of-the-art proprietary dbx **Type IV™** conversion system to offer the best characteristics of both analog and digital applications all under one roof.

This manual will be your guide to understanding the full functionality of the powerful 376. After you have become familiar with the unit, we encourage you to experiment and find creative ways that the 376 can help you optimize your specific application.

## 0.1 Defining the 376

The dbx 376 Vacuum Tube Preamp/Channel strip provides the user with Vacuum tube microphone preamp capabilities in the analog domain as well as giving you pristine digital output capabilities. Listed below, are some of features available to you in the 376:

- ***Tube microphone pre-amp***
- ***200V tube plate voltage***
- ***4-Segment Drive meter LEDs***
- ***Front panel instrument input***
- ***Selectable mic/line switch***
- ***+48 Volt phantom power***
- ***20 dB pad***
- ***3-Band Parametric EQ***
- ***Compressor***
- ***De-Esser***
- ***Compressor Threshold and Gain Reduction meters***
- ***De-Esser Gain Reduction meter***
- ***8 segment output meter***
- ***Type IV™ conversion system***
- ***AES/EBU and S/PDIF digital outputs***
- ***Word clock sync input and output***
- ***Selectable sampling rates (96, 88.2, 48, 44.1kHz)***
- ***24, 20 and 16 bit wordlengths***
- ***Selectable dither and noise-shaping algorithms***

With the dbx proprietary patent-pending TSE™ Tape Saturation Emulation and TYPE IV™ Conversion System, your signal retains its analog warmth and character, with the pristine clarity demanded by today's digital standards. In addition, the 376 offers 96kHz A/D conversion, which results in improved frequency response.

## 0.2 Service Contact Info

If you require technical support, contact dbx Customer Service. Be prepared to accurately describe the problem. Know the serial number of your unit. This is printed on a sticker attached to the rear panel. If you have not already taken the time to fill out your warranty registration card and send it in, please do so now.

Before you return a product to the factory for service, we recommend you refer to the manual. Make sure you have correctly followed installation steps and operation procedures. If you are still unable to solve a problem, contact our Customer Service Department at (801) 568-7660 for consultation. If you need to return a product to the factory for service, you MUST contact Customer Service to obtain a Return Authorization Number.

No returned products will be accepted at the factory without a Return Authorization Number.

Please refer to the warranty below, which extends to the first end-user. After expiration of the warranty, a reasonable charge will be made for parts, labor, and packing if you choose to use the factory service facility. In all cases, you are responsible for transportation charges to the factory. dbx will pay return shipping if the unit is still under warranty.

Use the original packing material if it is available. Mark the package with the name of the shipper and with these words in red: DELICATE INSTRUMENT, FRAGILE! Insure the package properly. Ship prepaid, not collect. Do not ship parcel post.

## 0.3 Warranty

This warranty is valid only for the original purchaser and only in the United States.

- 1). The warranty registration card that accompanies this product must be mailed within 30 days after purchase date to validate this warranty. Proof-of-purchase is considered to be the burden of the consumer.
- 2). dbx warrants this product, when bought and used solely within the U.S., to be free from defects in materials and workmanship under normal use and service.
- 3). dbx liability under this warranty is limited to repairing or, at our discretion, replacing defective materials that show evidence of defect, provided the product is returned to dbx WITH RETURN AUTHORIZATION from the factory, where all parts and labor will be covered up to a period of two years. A Return Authorization number must be obtained from dbx by telephone. The company shall not be liable for any consequential damage as a result of the product's use in any circuit or assembly.
- 4). dbx reserves the right to make changes in design or make additions to or improvements upon this product without incurring any obligation to install the same additions or improvements on products previously manufactured.
- 5). The foregoing is in lieu of all other warranties, expressed or implied, and dbx neither assumes nor authorizes any person to assume on its behalf any obligation or liability in connection with the sale of this product. In no event shall dbx or its dealers be liable for special or consequential damages or from any delay in the performance of this warranty due to causes beyond their control.

## 0.4 Installation Recommendations

***FOR RACK MOUNT USE ONLY*** - Install the 376 in your rack with the provided rack screws. When installed in a rack, the unit should be positioned with enough room (at least one 1U above the and 1U below the unit) to allow proper ventilation. The 376 should not be mounted above or below anything that generates excessive heat. Ambient temperatures should not exceed 113°F (45°C) when equipment is in use. Although the unit is shielded against radio frequency and electromagnetic interference, extremely high fields of RF and EMI should be avoided where possible.



# Getting Started

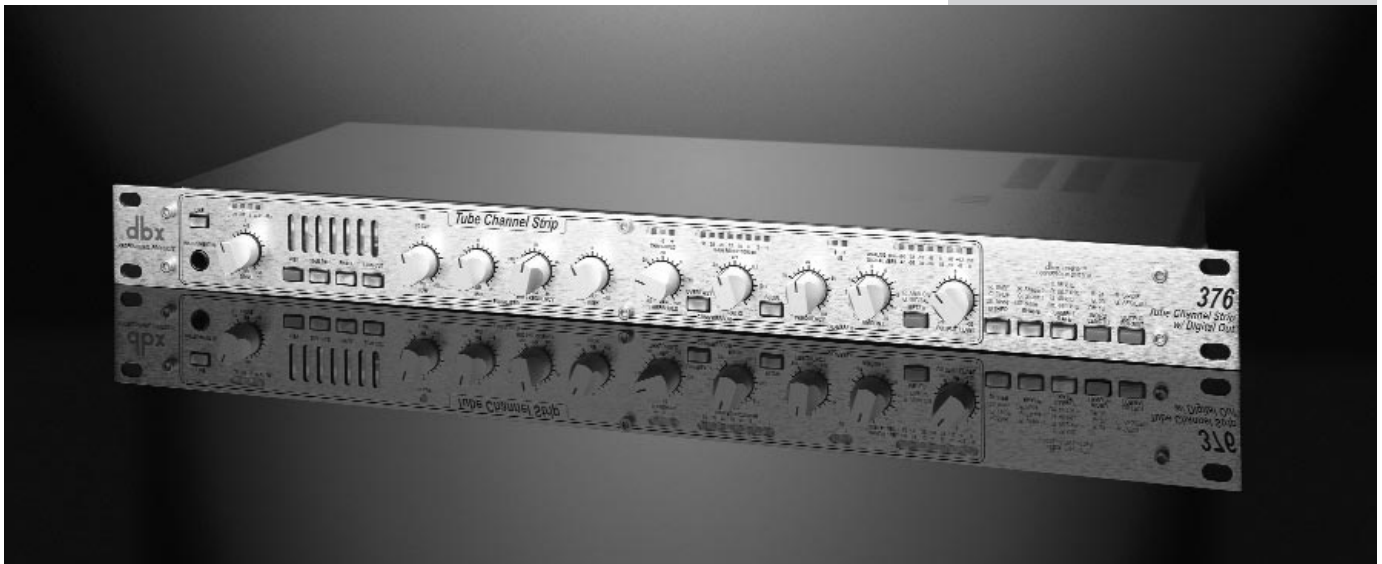

## 1.1 Rear Panel Connections



### Power Switch

Turns the 376 on and off.

### IEC Power Cord Receptacle

This is the power cord receptacle of the 376. An IEC cord is included with the shipped product.

### AES/EBU Digital Connector

The 376 provides AES/EBU digital output formatting through the XLR connector. Be sure to use short lengths of 110  $\Omega$  digital cables rather than standard XLR to XLR cables. Using the correct cables will prevent digital dropouts and other interconnection problems.

### S/PDIF Digital Connector

The 376 provides S/PDIF digital output formatting through the RCA coaxial connector. Be sure to use short lengths of 75  $\Omega$  digital cables or 75  $\Omega$  video cables rather than standard audio RCA to RCA cables. Using the correct cables will prevent digital dropouts and other interconnection problems.

*NOTE: Although digital information is coming out of both XLR and RCA jacks simultaneously, the correct format will only appear at the output for the format type selected. For example, if you have AES/EBU format selected, an AES/EBU formatted signal will appear at the output of both the XLR and the RCA connector. Or, if you have S/PDIF format selected, an S/PDIF formatted signal will appear at the output of both the RCA and XLR connectors.*

### Sync In and Out Connectors

BNC connectors are provided for both clock in and out functions. The 376's clock chips are dbx custom VCXO chips, designed for low-jitter performance. You may use the 376 as a master clock source, having other equipment slave to the 376, or you may slave the 376's clock to any other wordclock source device.

### Line Output Connectors

The analog output section of the 376 offers both XLR and 1/4" TRS electronically balanced connections. The 1/4" connector may be used in a balanced or unbalanced configuration. Using a 1/4" TS connector will unbalance the signal.

### Insert Jack

The 1/4" TRS Insert jack (Tip=SEND and Ring=RETURN), will allow you to add an effects loop directly into the signal path of the 376. This insertion point is located after the tube section and prior to the signal processing section.

### Analog Input Connectors

The analog input section of the 376 offers both XLR (Microphone) and a rear 1/4" TRS (Line) electronically balanced connections. The 1/4" connector may be used in a balanced or unbalanced configuration. Using a 1/4" TS connector will unbalance the signal.

## 1.2 Front Panel Controls



### Instrument Input

This unbalanced high-impedance input connection is used to insert an instrument signal directly into the preamp. Use the LINE switch to make instrument input or the rear panel line input active. Plugging into the instrument jack will override the rear panel 1/4" input jack (line input must be selected).

### Line Select Switch

This switch, when lit, selects the rear line input or front panel instrument input (when something is connected) as the source signal of the 376.

### Drive Control

This control sets the amount of gain at the input of the vacuum tube stage. The range of gain available is +30 to +60 dB (-15 to +15 dB when LINE INPUT is selected).

### Drive meter

This 4-segment LED meter indicates the input drive signal.

### +48 Volt Switch

This switch activates phantom power for condenser microphones on pins 2 and 3 of the XLR mic input. You should connect your microphone before turning on the phantom power to prevent damage to your microphone. Be sure to always lower levels prior to using the +48 Volt Switch.

### 20db Pad Switch

This switch attenuates the microphone input signal by 20dB.

### Phase Switch

This switch inverts the phase of the incoming signal at the Mic input by swapping pins 2 and 3 on the XLR connector.

**Note:** The +48 Volt, **20dB Pad** and **Phase** functions are only available when the microphone input is in use.

### Low Cut Switch

This switch places a 12 dB per octave shelving high pass filter in the signal path. The knee frequency of the Low Cut filter is 75 Hz. This filter is very useful for removing low frequency rumble or handling noise from a microphone input signal.

**Low control**

This control varies the gain of the low frequency equalization; the gain range is -15 to +15 dB. This filter is a low shelving filter at 80 Hz.

**Mid control**

This control varies the gain of the mid frequency equalization; the gain range is -15 to +15 dB. The mid frequency filter is a bandpass configuration with variable frequency.

**Frequency control**

This control selects the center frequency for the mid frequency filter. The frequency range is 100 Hz to 8 kHz.

**High control**

This control varies the gain of the high frequency equalization; the gain range is -15 to +15 dB. This filter is a high shelving filter at 12 kHz.

**EQ Clip LED**

This LED indicates that the signal is clipping within the EQ section of the 376.

**Threshold (Compressor)**

This control is used to set the threshold of compression from -40dBu (7.8Vrms) to +20dBu (7.8Vrms).

**Threshold Meter (Compressor)**

These three LEDs indicate the relationship of the input signal level to the threshold of compression. The green - LED indicates that the signal is below the threshold. The red + LED indicates that the signal is above the threshold. When the 376 is switched to OVEREASY mode, the yellow O LED is on when the signal is in the Overeasy mode of operation.

**Overeasy (Compressor)**

This button is used to engage the Overeasy region.

**Ratio (Compressor)**

This knob is used to set the amount of compression affecting the signal. Range is from 1:1 (no compression) to  $\infty$ :1. At  $\infty$ :1, the output level will not exceed the threshold regardless of the input level.

**Gain Reduction Meter (Compressor)**

This 8-segment meter displays how much the signal is being attenuated by the compressor.

**Slow (Compressor)**

This button is used to select either a slow or fast attack/release time of the compressor.

**Frequency (De-Esser)**

This control is used to set the HIGHPASS frequency of the variable filter used in the De-Esser circuitry. Settings between 4-8kHz will yield the best results for vocal processing, while higher settings can be used for non-vocal applications.

## Output Level

This knob controls the overall level of the output signal, and ranges from -20 to +20dB.

## Meter Select Switch

This switch allows you to select display metering of either the digital or analog output signal. The analog level is scaled in dBu, while the digital level is scaled in dBFS.

## LightPipe™ Meter

This meter displays either the analog or digital output signal.

## 1.3 Front Panel (Type IV™ conversion system controls)

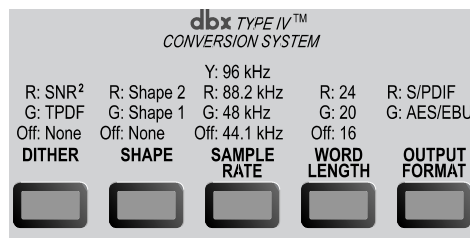

## Dither Switch

This switch is used to select the type of dither algorithm including: TPDF, SNR<sup>2</sup>, or None. Dither is random noise that is added to the audio signal which effectively eliminates the harmonic distortion created by truncation. See the "Truncation" graph in section D.2 of the Appendix. The LED will be lit **RED** for the SNR<sup>2</sup> or **GREEN** for the TPDF dither algorithm. When the LED is off, dithering is not in use.

## Shape Switch

This switch selects either the Shape 1 or Shape 2 psycho-acoustic noise-shaping curve. Shape 1 utilizes a mild psycho-acoustic curve, while the curve used in Shape 2 tends to be more aggressive. Please see the "Noise Shaping" graph in section D.1 of the Appendix. The LED will light **GREEN** for Shape 1 and **RED** for Shape 2. When the LED is off, the noise-shaping effect is not in use.

## Sample Rate Switch

This switch selects the digital output sample rate of either: 44.1, 48, 88.2, or 96 kHz. The LED will not be lit for 44.1 kHz, **GREEN** for 48 kHz, **RED** for 88.2 kHz and **YELLOW** for 96 kHz.

## Word Length Switch

Selects output wordlength of 16, 20, or 24 bits output resolution. The LED will not be lit for 16 bit, **GREEN** for 20 bit, and **RED** for 24 bit.

## Output Format

Selects the AES/EBU or S/PDIF digital output format. The LED will be lit green for AES/EBU and red for S/PDIF.



ANALOG  
APPLICATIONS

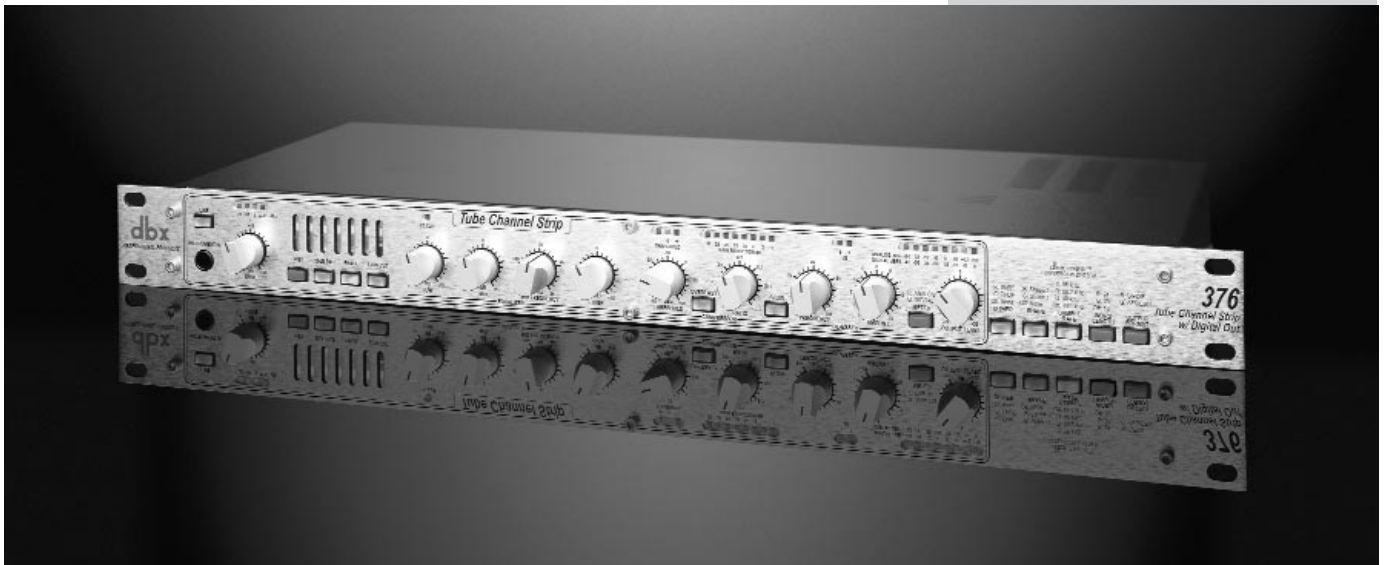

## 2.1 Basic Analog Connection of the 376

- Turn off all equipment before making any connections.
- Install the 376 in your rack with the provided rack screws. It is essential that when the 376 is being mounted in a rack mounting enclosure, the unit should be positioned with enough room (at least 1U of space above the unit and 1U of space at the below the unit) to allow proper ventilation. The 376 should not be mounted above or below anything that generates excessive heat. Ambient temperatures should not exceed 113°F (45°C) when equipment is in use. Although the unit is shielded against radio frequency and electromagnetic interference, extremely high fields of RF and EMI should be avoided where possible.
- Make audio connections via XLR, 1/4" TRS, or 1/4" TS plugs.

With the flexibility of the 376, various connection options are available. For input connection, use the XLR Microphone, 1/4" line or 1/4" instrument (front panel) inputs. For analog output connections, use either XLR or 1/4" Line output. The use of more than one connector at a time for the output section, could unbalance balanced lines, cause phase cancellations, short a conductor to ground, or cause damage to other equipment connected to the 376.
- Apply power to the 376. Connect the AC power cord to the AC power receptacle on the back of the unit. Route the AC power cord to a convenient power outlet away from audio lines. The unit may be turned on and off from the rear panel power switch or from a master equipment power switch.

## 2.2 Connection to a Mixing Console

- 1). Connect your mic cable to the Mic input of the 376

NOTE: If you are using a mic with a separate power supply, such as a tube microphone, make sure that you are not sending two sources of +48V phantom power to the mic. Use the +48V from the mic's power supply. Use the +48V Phantom Power switch on the 376 for all other microphones which require phantom power.

- 2). Set the front panel of the 376 to the desired settings, including phantom power, 20 dB pad, phase, etc. Connect the line output of the 376 to the console's LINE INPUT, and ensure that the console's input selection switch is set to **LINE**, and the console's gain control is set appropriately low.



- 3). Turn the 376's **DRIVE** control to the minimum position. Turn the **OUTPUT LEVEL** control to the 12 o'clock position, and apply power to the 376. Make sure your console's gain fader is at the nominal level and begin to slowly increase the gain of the 376 using the **DRIVE** control. You should increase the gain until the mixing/recording device is operating at nominal signal input level.
- 4). Use the Parametric EQ **LOW**, **MID**, **MID-FREQUENCY** and **HIGH** controls to achieve the desired EQ settings of the 376.
- 5). With signal passing through the unit, make the desired settings to the **THRESHOLD**, **RATIO**, **OVEREASY** and **SLOW** controls of the Compressor section of the 376.
- 6). If you are using the 376 for a Vocal Application, make the desired settings to the **FREQUENCY** and **AMOUNT** controls of the De-Esser section of the 376.



### 2.3 Direct Connection to a Recorder

- 1). Make microphone connections, being careful to keep the **DRIVE** control in the minimum (+30 dB) position.
- 2). Connect the 376's Line outputs directly to the audio inputs of your recorder.

- 3). Enable the record function of the specific track of the recorder and open the specific tape track return in the console which corresponds to the track to which the 376 is connected. As you increase the setting of the **DRIVE** control, you should begin to hear the input of the 376 running through the recorder and returning to your console as a tape return.
- 4). Use the Parametric EQ **LOW**, **MID**, **MID-FREQUENCY** and **HIGH** controls to achieve the desired EQ settings of the 376.
- 5). With signal passing through the unit, make the desired settings to the **THRESHOLD**, **RATIO**, **OVEREASY** and **SLOW** controls of the Compressor section of the 376.
- 6). If you are using the 376 for a Vocal Application, make the desired settings to the **FREQUENCY** and **AMOUNT** controls of the De-Esser section of the 376.



DIGITAL  
APPLICATIONS

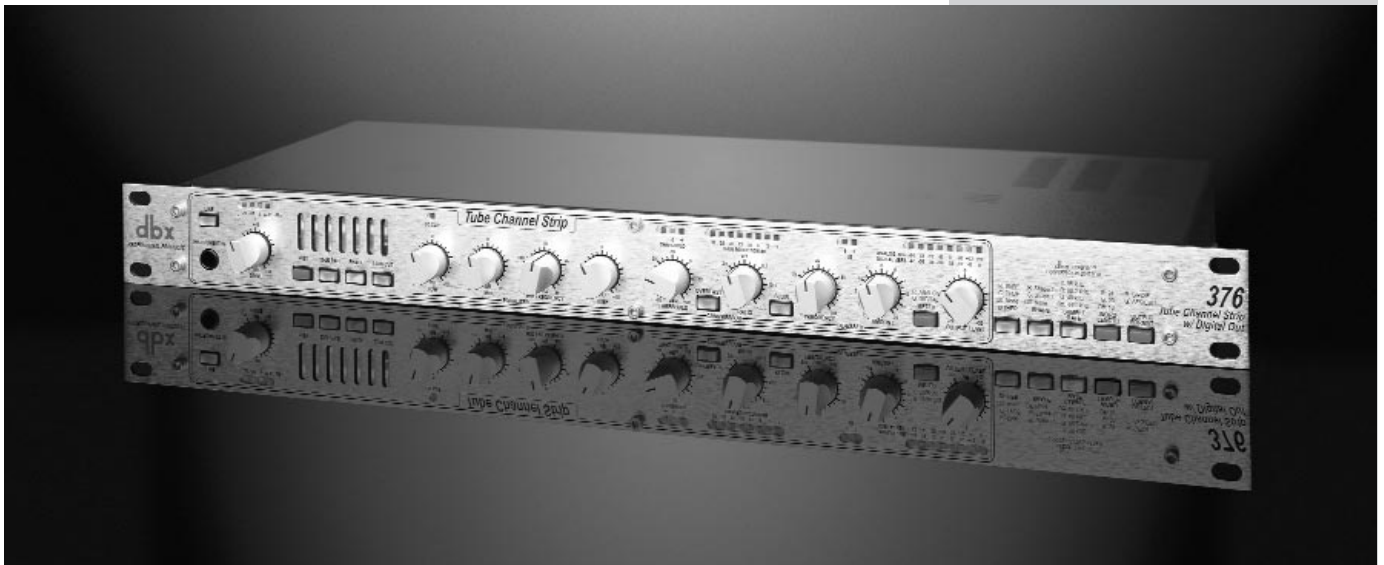

### 3.1 Digital Output Front Functions of the 376

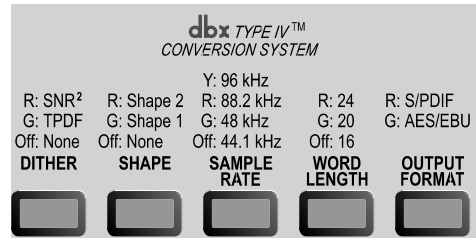

#### Dither Switch

This switch is used to select the dither type algorithms including: TPDF, SNR<sup>2</sup>, or None. Dither is random noise that is added to the audio signal which effectively eliminates the harmonic distortion created by truncation. See the "Truncation" graph in section D.2 of the Appendix. The LED will be lit **RED** for the SNR<sup>2</sup> or **GREEN** for the TPDF dither algorithm. When the LED is off, dithering is not in use.

#### Shape Switch

This switch selects the Shape 1, or Shape 2 psycho-acoustic noise-shaping curve. Shape 1 utilizes a mild psycho-acoustic curve, while the curve used in Shape 2 tends to be more aggressive. Please see the "Noise Shaping" graph in section D.1 of the appendix. The LED will be lit **GREEN** for Shape 1 and **RED** for Shape 2. When the LED is off, the noise-shaping algorithm is not in use.

#### Sample Rate Switch

This switch selects the digital output sample rate of either: 44.1, 48, 88.2, or 96 kHz. The LED will not be lit for 44.1 kHz, **GREEN** for 48 kHz, **RED** for 88.2 kHz and **YELLOW** for 96 kHz.

#### Word Length Switch

Selects output wordlength of 16, 20, or 24 bits output resolution. The LED will not be lit for 16 bit, **GREEN** for 20 bit, and **RED** for 24 bit.

#### Output Format

Selects either the AES/EBU or S/PDIF digital output format. The LED will be green for AES/EBU and red for S/PDIF.

### 3.2 Digital Output Rear Panel Connections



### AES/EBU Digital Connector

The 376 provides AES/EBU digital output formatting through the XLR connector. Be sure to use short lengths of 110  $\Omega$  digital cables rather than standard XLR to XLR cables. Using the correct cables will prevent digital dropouts and other interconnection problems.

### S/PDIF Digital Connector

The 376 provides S/PDIF digital output formatting through the RCA coaxial connector. Be sure to use short lengths of 75  $\Omega$  digital cables or 75  $\Omega$  video cables rather than standard audio RCA to RCA cables. Using the correct cables will prevent digital dropouts and other interconnection problems.

*NOTE: Although digital information is coming out of both XLR and RCA jacks simultaneously, the correct format will only appear at the output for the format type selected. For example, if you have AES/EBU format selected, an AES/EBU formatted signal will appear at the output of both the XLR and the RCA connector. Or, if you have S/PDIF format selected, an S/PDIF formatted signal will appear at the output of both the RCA and XLR connectors.*

### Sync In and Out Connectors

BNC connectors are provided for both word clock in and out functions. The 376's clock chips are dbx custom VCXO chips, designed for low-jitter performance. You may use the 376 as a master clock source, having other equipment slave to the 376, or you may slave the 376's clock to any other word clock source.

## 3.3 Sync Input Sample Rate Selection

When connecting an incoming or master device to the sync input of the 376, the 376 will automatically lock to the sample rate of the master device. The sample rate will then be indicated in the **SAMPLE RATE** select button.

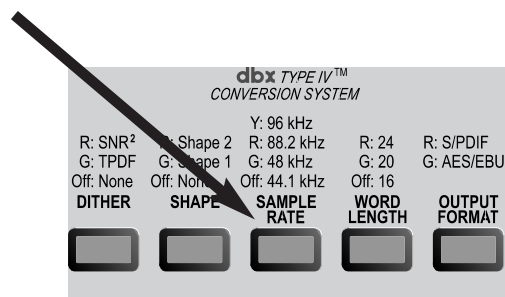

Note that when the master device is disconnected from the Sync Input connection, the **SAMPLE RATE** select button will flash until an internal sample rate is selected.

### 3.4 Direct Connection to a DAW (CPU)

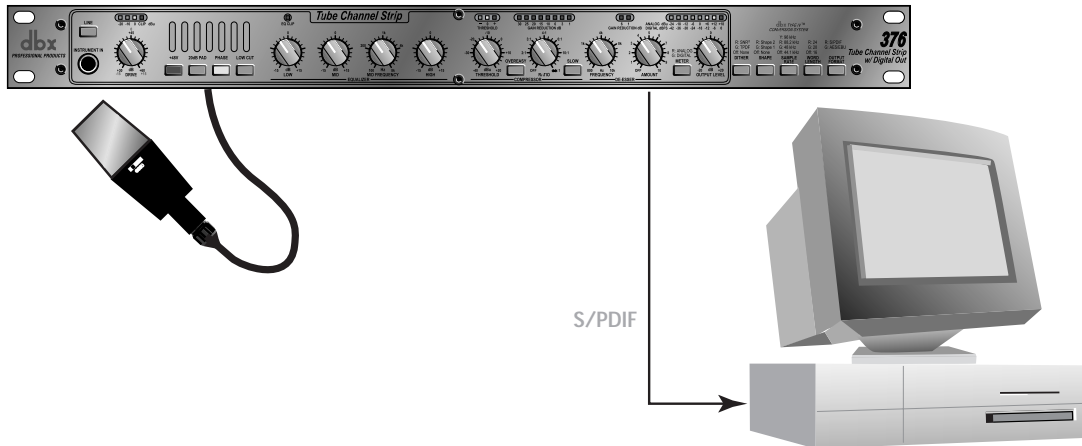

#### Rear Panel Connections

- Connect the source to the desired 1/4" TRS or XLR input.
- Connect the AES/EBU or S/PDIF output of the 376 and run into the AES/EBU or S/PDIF input interface of the DAW (CPU).

#### Front Panel Digital Output Features

- 1). Use the **METER** switch to select digital output metering.
- 2). Use the **DITHER** switch to select the desired dither algorithm.
- 3). Use the **SHAPE** switch to select the desired noise-shaping algorithm.
- 4). Use the **SAMPLE RATE** switch to select the correct sampling rate.
- 5). Use the **WORD LENGTH** switch to select the correct word length.
- 6). Use the **OUTPUT FORMAT** switch to select the appropriate digital output format.

### 3.5 Direct Connection to a Digital Mixer

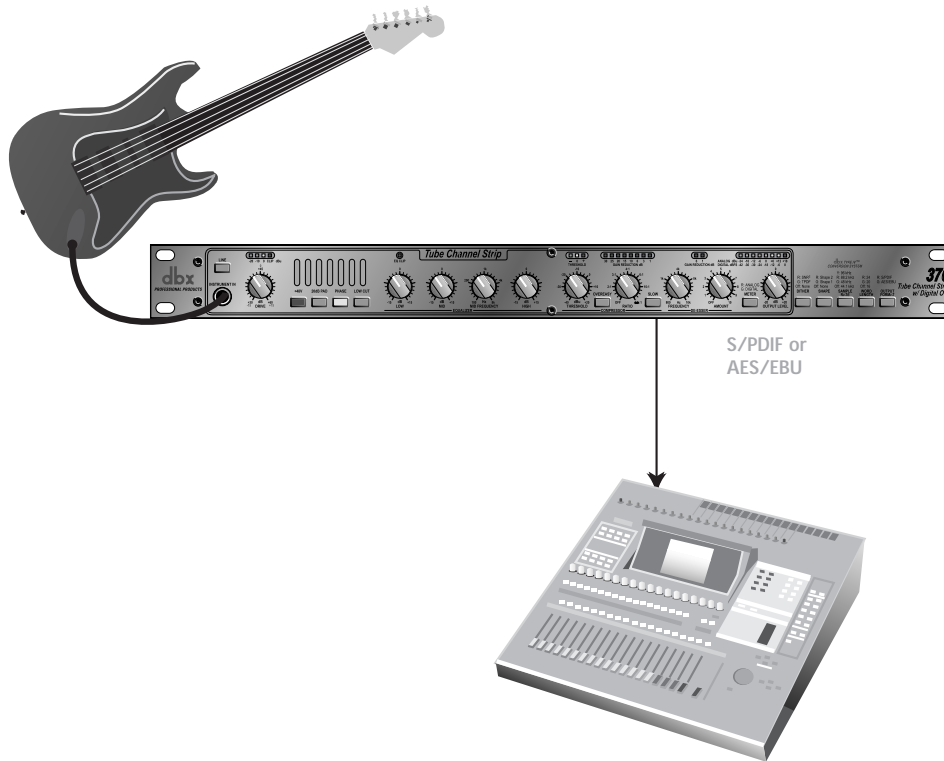

#### Rear Panel Connections

- Connect the source to the desired 1/4" TRS or XLR input jack.
- Connect the AES/EBU or S/PDIF output of the 376 and run into the AES/EBU or S/PDIF input of the digital mixer.

#### Front Panel Digital Output Features

- 1). Use the **METER** switch to select digital output metering.
- 2). Use the **DITHER** switch to select the desired dither algorithm.
- 3). Use the **SHAPE** switch to select the desired noise-shaping algorithm.
- 4). Use the **SAMPLE RATE** switch to select the correct sampling rate.
- 5). Use the **WORD LENGTH** switch to select the correct word length.
- 6). Use the **OUTPUT FORMAT** switch to select the appropriate digital output format.

### 3.6 A/D Conversion

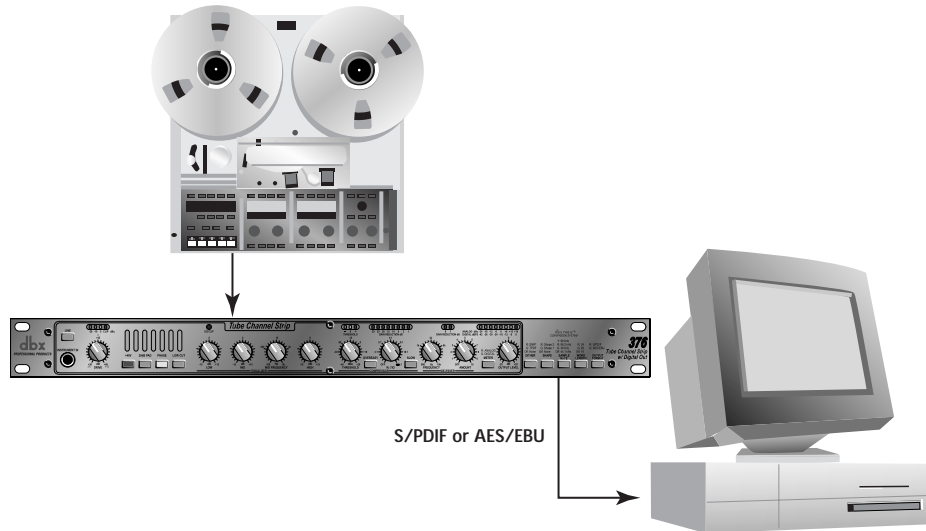

#### Rear Panel Connections

- Connect the source to the desired 1/4" TRS or XLR input.
- Connect the AES/EBU or S/PDIF output of the 376 and run into the AES/EBU or S/PDIF input interface of the DAW (CPU).

#### Front Panel Digital Output Features

- 1). Use the **METER** switch to select digital output metering.
- 2). Use the **DITHER** switch to select the desired dither algorithm.
- 3). Use the **SHAPE** switch to select the desired noise-shaping algorithm.
- 4). Use the **SAMPLE RATE** switch to select the correct sampling rate.
- 5). Use the **WORD LENGTH** switch to select the correct word length.
- 6). Use the **OUTPUT FORMAT** switch to select the appropriate digital output format.



### 3.7 Multi-Tracking to Digital

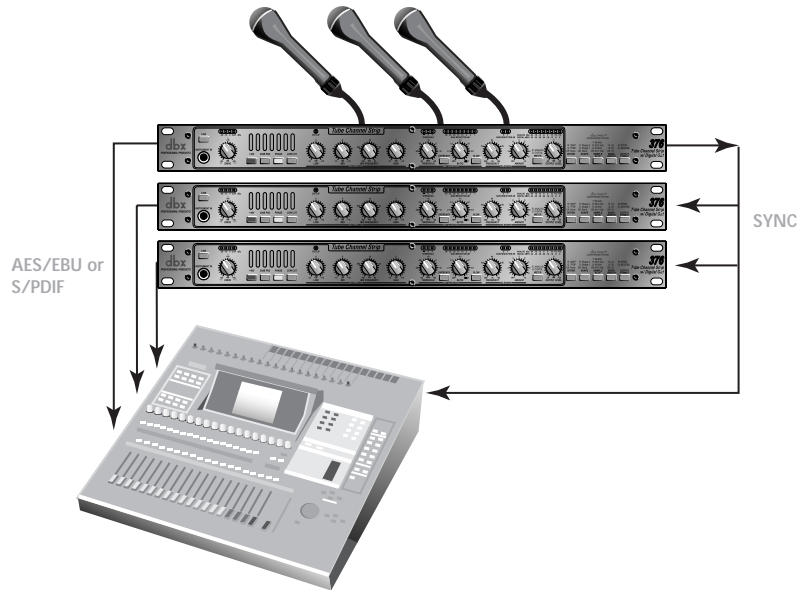

#### Rear Panel Connections

- Connect the source to the desired 1/4" TRS or XLR input jack.
- Connect the AES/EBU or S/PDIF output of the 376 and run into the AES/EBU or S/PDIF input of the digital mixer.

#### Front Panel Digital Output Features

- 1). Use the **METER** switch to select digital output metering.
- 2). Use the **DITHER** switch to select the desired dither algorithm.
- 3). Use the **SHAPE** switch to select the desired noise-shaping algorithm.
- 4). Use the **SAMPLE RATE** switch to select the correct sampling rate.
- 5). Use the **WORD LENGTH** switch to select the correct word length.
- 6). Use the **OUTPUT FORMAT** switch to select the appropriate digital output format.

### 3.8 Analog and Digital Output Application

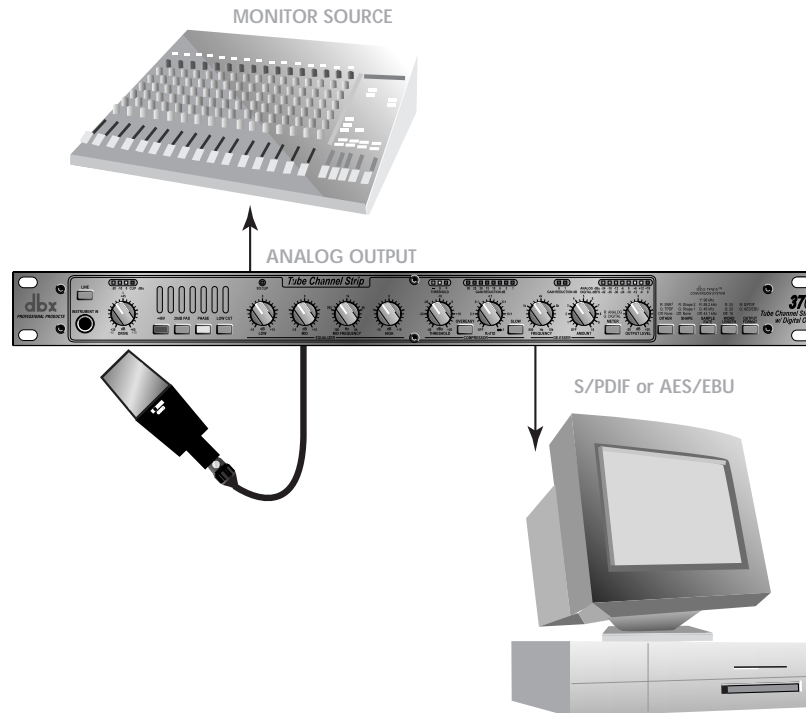

The 376 gives you the unique option of utilizing the analog and digital outputs simultaneously. This option is ideal for using the analog output section as a reference monitoring signal of the digital signal. Both analog and digital outputs offer independent output control, which allows you to send a digital signal to a receiving device (such as a DAW or digital recorder) and route the analog signal to a monitoring device (such as a mixer or headphone amplifier), while controlling both levels independently all at the same time.

#### Rear Panel Connections

- Connect the source to the desired 1/4" TRS or XLR input.
- Connect the AES/EBU or S/PDIF output of the 376 and run into the AES/EBU or S/PDIF input interface of the DAW (CPU).
- Connect the 1/4" TRS or XLR output of the 376 and run into the 1/4" TRS or XLR input of the monitoring device.

#### Front Panel Digital Output Features

- 1). Use the **METER** switch to select digital output metering.
- 2). Use the **DITHER** switch to select the desired dither algorithm.
- 3). Use the **SHAPE** switch to select the desired noise-shaping algorithm.
- 4). Use the **SAMPLE RATE** switch to select the correct sampling rate.
- 5). Use the **WORD LENGTH** switch to select the correct word length.
- 6). Use the **OUTPUT FORMAT** switch to select the appropriate digital output format.

APPENDIX

Sync Input Info  
Block Diagram  
dbx Type IV™ White Paper  
Noise-Shaping Algorithms  
Truncation  
Specifications

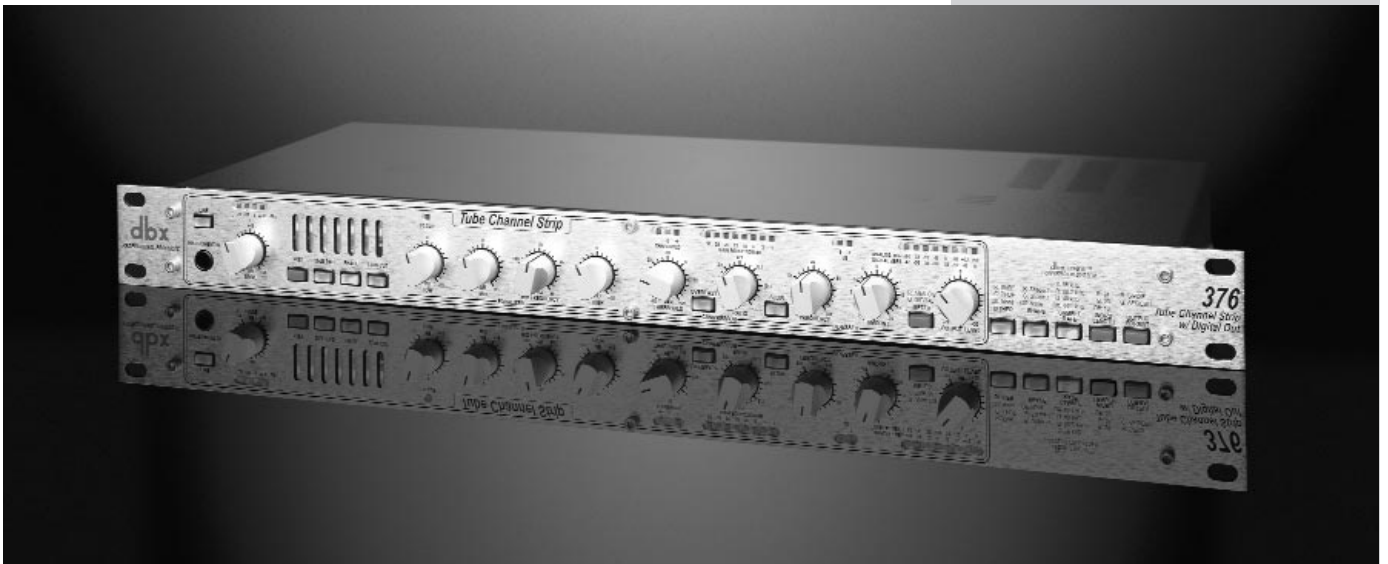

### A- Sync Input Info

#### INSTRUCTIONS FOR QUALIFIED SERVICE PERSONNEL:

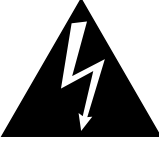

**CAUTION: These servicing instructions are for use by qualified service personnel only. To reduce the risk of electric shock, do not perform any servicing other than that contained in the operating instructions unless you are qualified to do so. Refer all servicing to qualified service personnel. Disconnect mains power before servicing.**



The dbx 376 comes with the word input **75Ω** terminated. For certain configurations, you may wish to have the sync input be unterminated. Certain "house sync" configurations will require you to change the default position of the termination jumper on the main circuit board. For example, if you run your sync to several pieces of equipment using a tapped configuration (using BNC T's) as shown below, only the last box, box C, would be terminated (marked "75 ohm terminated" on the circuit board). Unfortunately, some equipment does not allow the user to change the termination setting. These pieces of equipment are usually provided with a permanent termination. If you use the 376 with another piece of terminated equipment in tapped configuration, you should unterminate (marked "unterminated" on the circuit board) the 376's sync input. The same is true if you wish to use several 376's in a tapped configuration. See Fig. A.1 for the location of termination jumper.

**NOTE-** This termination procedure should be performed ONLY by an authorized service technician.

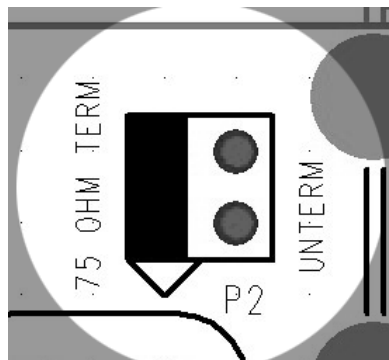
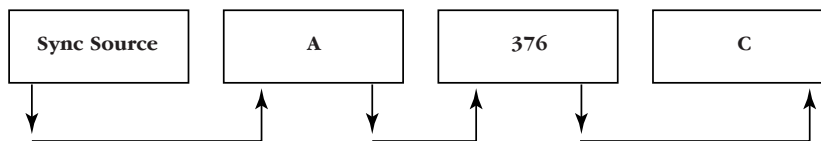

Fig.A.1

Location of sync input termination jumper. "Terminated" selection is shown.

#### Daisy Chain Configuration



#### Tapped Configuration

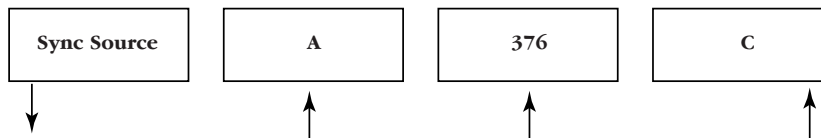

**B- Block Diagram**

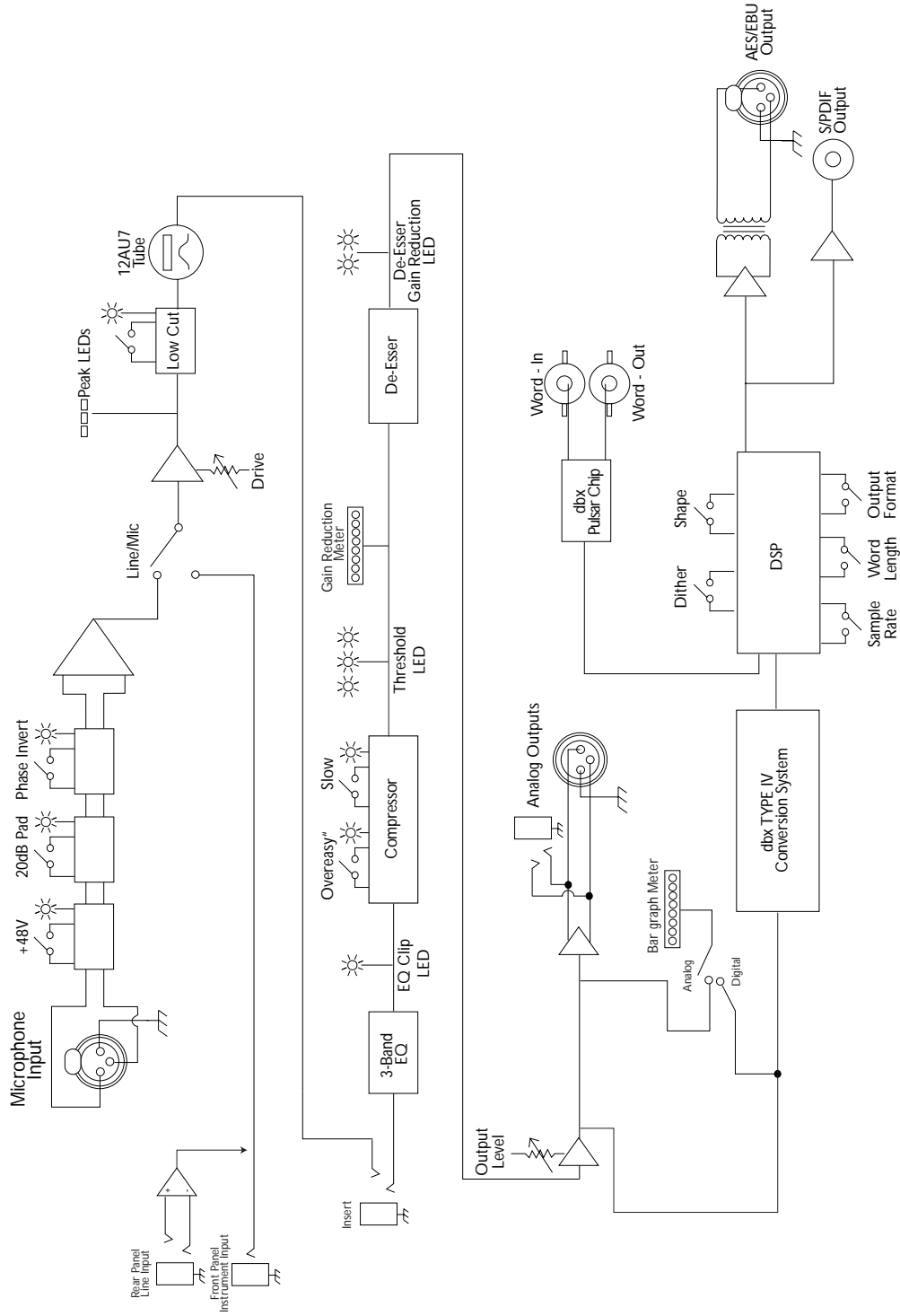

**C- Type IV™ White Paper****dbx Type IV™ Conversion System  
White Paper  
by Roger Johnson**

The dbx Type IV™ Conversion System is a proprietary analog-to-digital (A/D) conversion process that combines the best attributes of digital conversion and analog recording processes to preserve the essence of the analog signal when it is converted to a digital format. dbx Type IV™ not only exploits the wide linear dynamic range of today's A/D converters, but also enhances it and extends the useable dynamic range beyond the linear range. By providing a logarithmic "Type IV™ Over Region" above the linear A/D range, we benefit from the extended high-level headroom that is inherent in analog recording without compromising the noise performance of the A/D conversion process.

Digital conversion and recording processes proliferated in the 1980's primarily due to the "cleaner" sound of digital versus analog, an advantage resulting from the comparatively wider linear dynamic range of digital. Anyone who is familiar with the technical specifications of digital equipment knows that the typical maximum signal-to-noise specifications for 16-bit systems is in the neighborhood of 90-something dB. Compare this to the typical signal-to-noise specifications for professional analog tape of about 55 dB without the aid of noise reduction and around 75 to 85 dB with noise reduction such as dbx Type I™ or Type II™ applied.

This seemingly tremendous signal-to-noise advantage of digital over analog would suggest that digital would become the unanimous choice for recording. For the most part this has occurred, not totally due to its signal-to-noise advantage, but as much due to the benefits of digital storage such as random access and the inherent ability to withstand degradation, unlike that of analog tape or LP's. In spite of the benefits of digital, no one in the audio world can refute the rediscovery of analog recording and tube gear that has occurred in the 90's, attributable to the quest for that "analog character" that is missing from digital recordings. This continued use of analog gear with modern digital systems brings to light a favorable characteristic of analog recording which those who abandoned analog and jumped on the digital bandwagon were either never aware of or simply took for granted.

Anyone who has ever used analog tape knows that you can "hit it hard" without destroying the recording. The printed specifications of analog tape don't take into account the practical headroom available. The max signal-to-noise specification of analog tape is measured by defining the "max" signal as the point where a given signal level and frequency produces a given percent Total Harmonic Distortion (THD)—typically the level at which a 1 kHz signal produces 3% THD. In actual use, the signal can easily exceed this "max" signal level by 5, 10, or even 15 dB on peaks, depending on the type of signal being recorded, without unacceptable artifacts. High signal levels can be tolerated (i.e. more headroom) at the expense of increased THD which, incidentally, is often desirable as an effect, evidenced by the renewed popularity of tube equipment.

The obvious conclusion is that analog recording actually has more useable dynamic range than the specifications seem to indicate. For example, let's say we're recording a kick drum. If analog tape measures 55 dB from the 3% THD point down to the RMS noise floor and the peaks of the kick drum exceed the 3% THD level by, say, 15 dB and it still sounds good, then we have 15 dB of extra useable headroom. Therefore, we end up with 70 dB of useable dynamic range. Throw in noise reduction and we push into the 90-something dB dynamic range territory of 16-bit digital. This explains why well-recorded analog master tapes make good-sounding CD's with no objectionable noise.

One main drawback of digital is that it inherently lacks this forgiving and beneficial characteristic of analog recording. Although digital conversion exhibits wide linear dynamic range, when you run out of headroom for high-level signals, hard clipping or even ugly signal wrap-around occurs, not to mention that A/D converters have their own nasty side effects such as going unstable when their modulator is overdriven with high-level signals.

This shortcoming of digital conversion has drastically affected the way users operate their equipment. Users are paranoid of overdriving the converter input and end up recording at lower levels to ensure that there is ample headroom to allow for the large peaks that would ruin an otherwise perfect recording. This, of course, compromises signal-

to-noise performance since the signal is now closer to the noise floor. Because users of digital equipment have to be extremely careful not to exceed 0 dB FS (full-scale), they must use peak-reading headroom meters. On the other hand, the forgiving nature of analog tape allows users of analog recording equipment the luxury of only needing to monitor the average level using VU meters, often having no peak indicators whatsoever. If only digital were more forgiving like analog, we could really exploit its wide dynamic range and more completely capture the essence of the musical performance.

Enter the dbx Type IV™ Conversion System. Like its related predecessor technologies—Type I™, Type II™, and Type III™—dbx Type IV™ succeeds in preserving the wide dynamic range of the original analog signal within a limited dynamic range medium. Whereas Type I™ and Type II™ expand the dynamic range of analog tape and other limited dynamic range media, and the simultaneous encode/decode process of Type III™ similarly expands the limited dynamic range through minimum-delay devices, Type IV™ breaks new ground by greatly enhancing the useable dynamic range of the analog-to-digital conversion process.

The dbx Type IV™ Conversion System combines proprietary analog and digital processing techniques to capture a much wider dynamic range than the A/D converter could by itself, preserving the maximum amount of information from the analog signal. This information is then encoded within the available bits of whichever A/D converter is used. This means that Type IV™ improves the performance of any A/D converter, from low-cost 16-bit to high-performance 24-bit! And no decoding is necessary beyond the conversion process!

As we have previously mentioned, digital systems have a wide linear region compared to analog tape and the dynamic range of A/D converters has improved significantly in recent years. The dbx Type IV™ Conversion System takes advantage of this and utilizes the top 4 dB of the A/D converter's linear dynamic range to create a logarithmic "overload region." This allows high-level transient signals passing far above the point where the overload region begins to be adequately represented in just 4 dB of the converter's dynamic range, whereas a typical A/D converter would clip. With Type IV™, you can never clip the A/D converter!

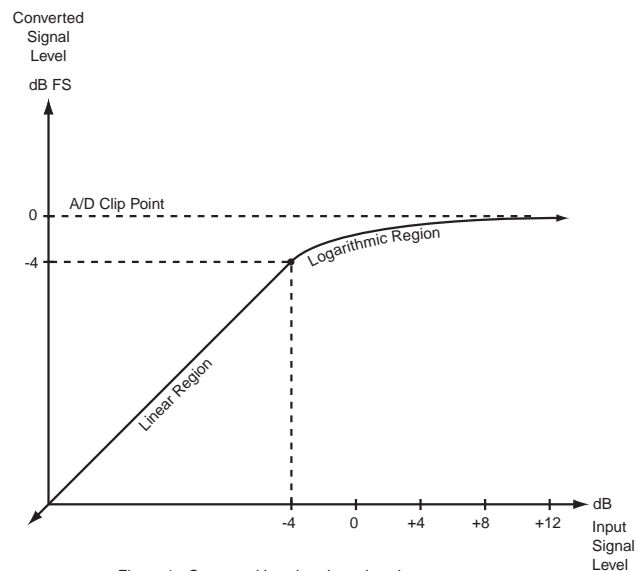

Figure 1 - Converted Level vs. Input Level

Fig. 1 illustrates this concept showing the level of the converted signal below and above the start of the overload region. The converted signal level is plotted along the Y-axis (vertical axis) of the plot vs. the level of the input signal along the X-axis (horizontal axis). The logarithmic mapping of the overload region begins 4 dB below 0 dB FS (full-scale) of the A/D converter. What this shows is that below -4 dB FS, in the linear region, the output signal is the same as the input signal. Above this, in the logarithmic region, high-level input signals get "mapped" into the top 4 dB of the A/D converter. This mapping is analogous to the signal compression effect that occurs when recording high-level signals onto analog tape.

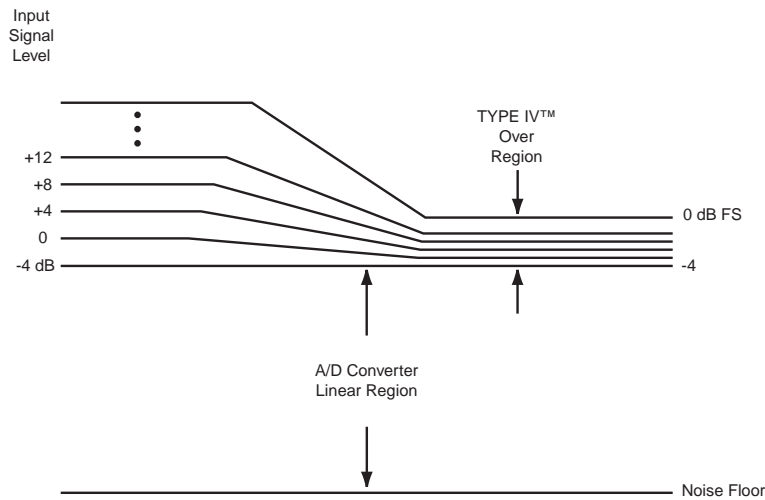

Figure 2 - Input Signal Levels Mapped to Type IV Over Region

Fig. 2 illustrates the mapping function in a different way. Input levels are shown on the left of the graph, while converted levels are shown on the right. Notice the mapping of large signal excursions to the 4 dB “Type IV™ Over Region.”

One might question the validity of such an approach—trying to represent a lot of signal information within a smaller “space.” The reason why this is not only valid but makes a whole lot of sense is that the digital codes in a converter are linear, or evenly-spaced, meaning that each consecutive code represents the same change in voltage of the input signal. This implies that half of the digital codes are used to represent input signals whose voltage level is below 1/2 of the full-scale A/D input voltage, while the other half of the codes are used to represent signals above 1/2 of the full-scale A/D input voltage. This seems reasonable until you realize that 1/2 of the full-scale input is only 6 dB below full-scale! So half of the codes are used to represent only the top 6 dB of signal information, while the other half are used to represent the remaining 80 to 110 dB of signal information, depending on the quality of the converter. It seems not only reasonable, but also desirable, to utilize the increased signal resolution afforded by this density of digital codes to represent more input dynamic range in this region.

Another advantage of the logarithmic mapping of our dbx Type IV™ Conversion System is that it preserves the high-frequency detail of the signal in the overload region. Figs. 3a through 3d illustrate what happens when you overload an A/D converter without Type IV™. Fig. 3a shows an input signal having both low-frequency and high-frequency components. When the signal overloads, or clips, (Fig. 3b) at the A/D converter, a disproportionate amount of high-frequency signal information is lost compared with the low-frequency information. The low and high-frequency components of the signal are separated in Fig. 3c to illustrate this more clearly. As you can see, the low frequency signal simply gets distorted but maintains most of its signal characteristics, while sections of the high-frequency signal are completely lost! With dbx Type IV™, its mapping preserves high-frequency signal information, as illustrated in Fig. 3d, since the signal is confined within the Type IV™ Over Region and never clips. The dashed line indicates the original input signal level. Below the Over Region no mapping occurs, while above this, mapping keeps all peaks of the signal below the A/D clip level, thus preserving the high-frequency content of the signal.



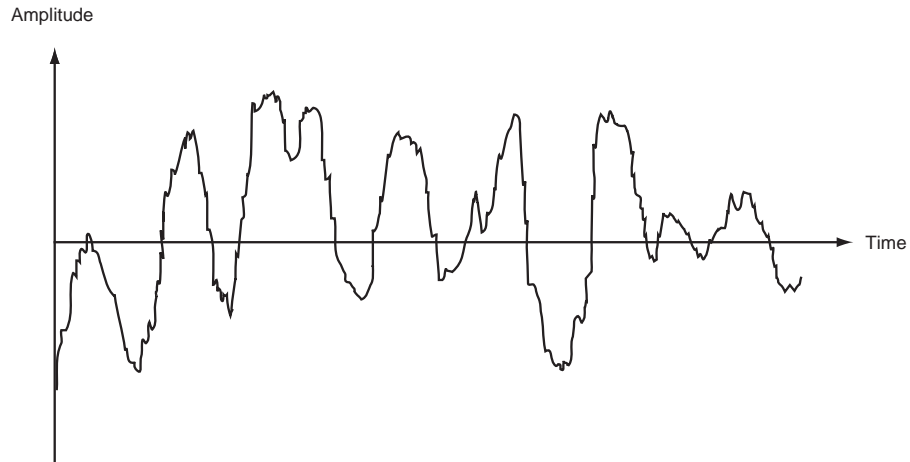

Figure 3a - Signal Having Low and High Frequency Content

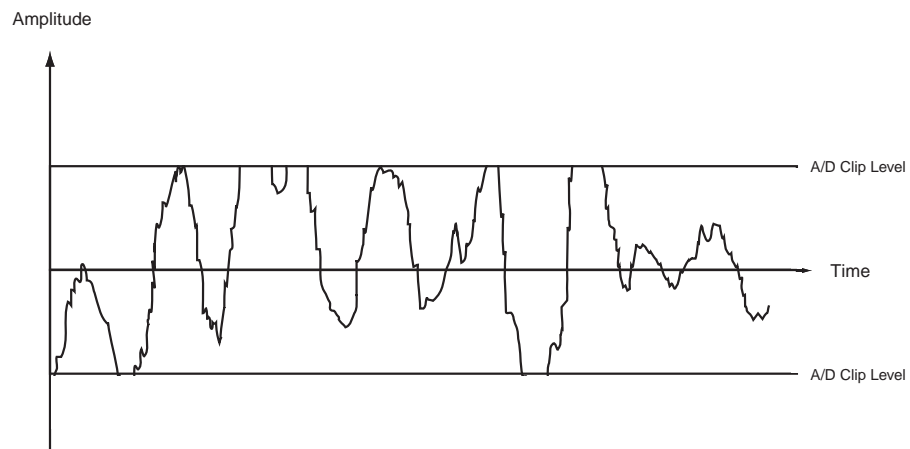

Figure 3b - Signal of Fig. 3a Going Beyond the A/D Clip Level

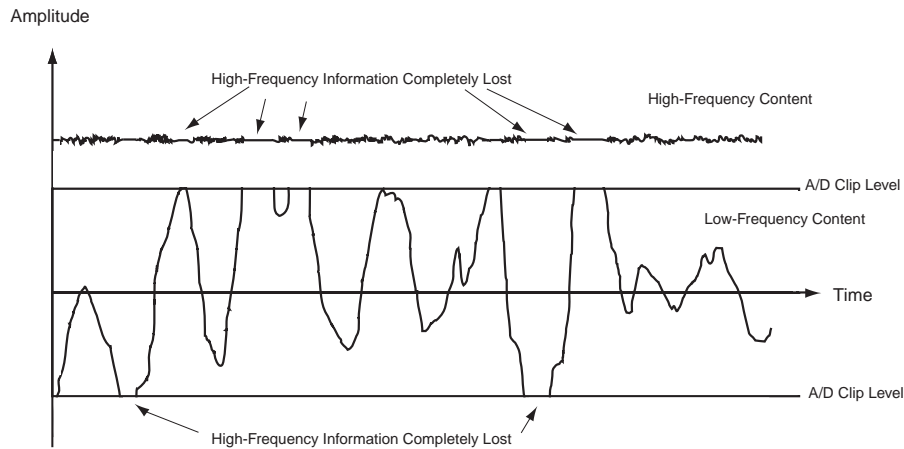

Figure 3c - Disproportionate Loss of High-Frequency Information Due to Clipping

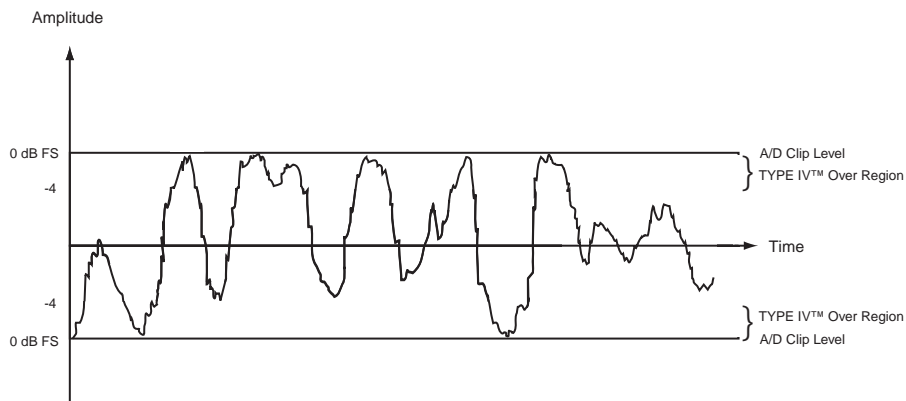

Figure 3d - Type IV Mapping Preserves High-Frequency Information

Now you're probably wondering, "What's the catch? I can't get something for nothing so what did I give up?" You may be worried that your A/D noise floor got 4 dB worse because we borrowed the top 4 dB of your converter. This is certainly a valid concern. Fortunately, we have the answer! Without going into the confidential technical details, by using our proprietary analog and digital Type IV™ processing, we reclaim the original A/D noise level! So what you get is free headroom!

The benefits of the dbx Type IV™ Conversion System can easily be heard by switching it in and out while listening to signals with high-level peaks captured in the Type IV™ Over Region. You will notice an obvious audible difference. With Type IV™ bypassed, you can't help notice the harsh, edgy sound of the A/D converter clipping. With Type IV™ enabled, those nasty artifacts disappear revealing a more open and natural sound. With Type IV™ enabled, you will get a more accurate and pure representation of the original wide-dynamic-range signal. You will absolutely agree that we really do give you "something for nothing." We give you peace of mind knowing that you never have to worry about clipping your A/D again! And when you listen to the noise floor of your A/D, you'll realize that we never compromise your noise performance with Type IV™!

The dbx Type IV™ Conversion System succeeds in combining the best of the analog and digital worlds to capture the truest essence and fullest dynamic range of audio signals. Who else but dbx would bring you this technology!

**D.1 Noise-Shaping Algorithms**

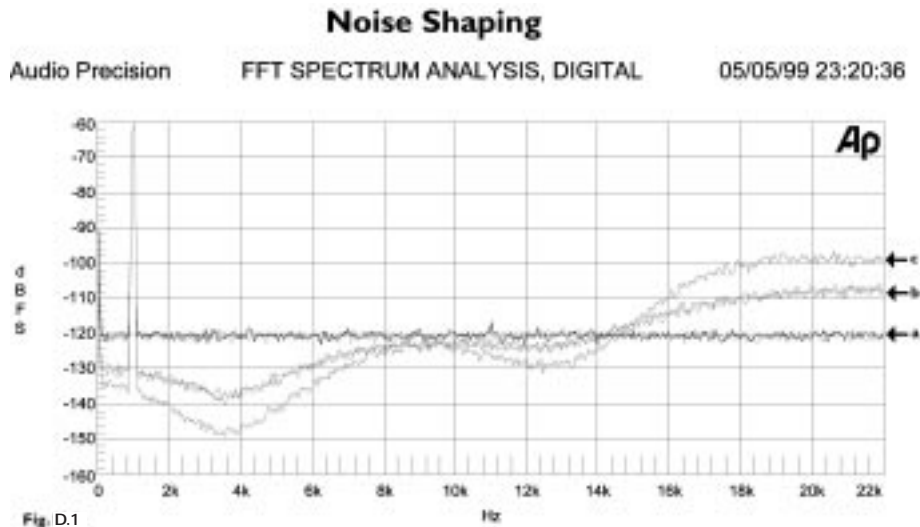

Fig. D.1

16-Bit TPDF dither. (a) Shape "off", (b) with shape set to "S1", (c) with shape set to "S2." Parameters: Input -60dBFS, 1 kHz; FFT Length= 2048, Sample Rate= 48 Khz, Averages= 32; Graph Steps= 1024.

**D.2 Truncation**

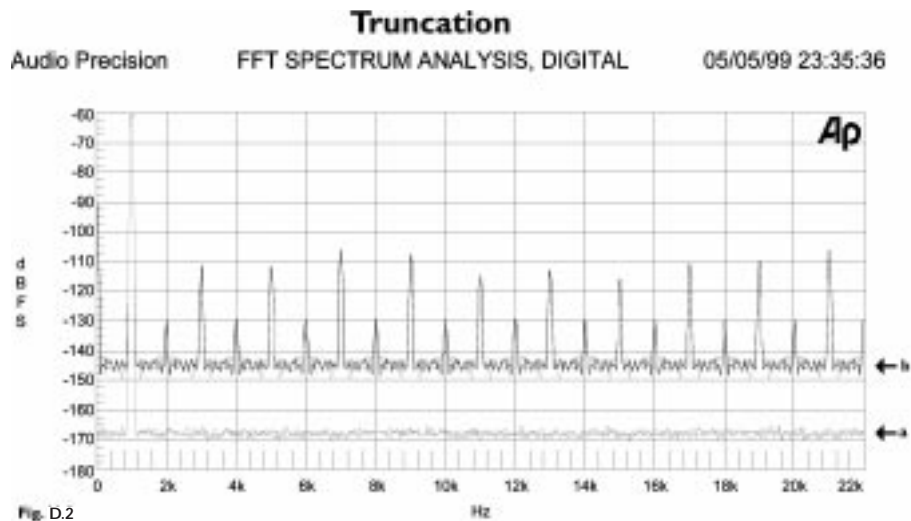

Fig. D.2

(a) 24-Bit word, (b) 16-Bit truncated output, no dither. Parameters: Input -60dBFS, 1 kHz; FFT Length= 2048, Sample Rate= 48 Khz, Averages= 32; Graph Steps= 1024.

## D.3 Specifications

### Microphone Input

Connector:	Female XLR Pin 2 Hot
Type:	Electronically balanced/unbalanced
Impedance:	330 $\Omega$
Maximum Input Level:	-9 dBu or +11 dBu with 20 dB pad engaged
CMRR:	>40dB, Typically 55dB
Equivalent Input Noise:	Typically -120 dBu with a 150 $\Omega$ source load, 20Hz to 20kHz BW

### Line Input (Rear Panel)

Connector:	TRS 1/4" Jack
Type:	Electronically balanced/unbalanced
Impedance:	20k $\Omega$ unbalanced, 40k $\Omega$ balanced
Maximum Input Level:	+21dBu balanced or unbalanced
CMRR:	>40dB, Typically 55dB
Gain (Drive Control)	-15dB to +15dB

### Instrument Input (Front Panel)

Connector:	TS 1/4" Jack
Type:	Unbalanced
Impedance:	470 k $\Omega$
Maximum Input Level:	+21dBu unbalanced

### Analog Outputs

Connector:	Male XLR Pin 2 Hot and TRS 1/4"
Type:	Servo-balanced/unbalanced
Impedance:	Balanced 120 $\Omega$ unbalanced 60 $\Omega$
Maximum Output Level:	>+21 dBu, >+20 dBm (into a 600 $\Omega$ load)

### Insert

Connector:	TRS 1/4"
Type:	Unbalanced
Impedance:	100 $\Omega$ (SEND), 20k $\Omega$ (RETURN)

### Digital Outputs

Connectors:	XLR for AES/EBU RCA for S/PDIF
Impedance:	110 $\Omega$ for AES/EBU 75 $\Omega$ for S/PDIF

### Word Sync Input/Output

Connectors:	BNC
Input Impedance:	75 $\Omega$ terminated by internal jumper
Input:	96, 88.2, 48, or 44.1kHz word clock
Output:	96, 88.2, 48, or 44.1kHz word clock

### System Performance

DRIVE Control Range:	+30dB to +60dB for Mic Input -15dB to +15dB for Line and Instrument Inputs
----------------------	---

### Output Level Control Range

LIN E:	-20dB to +20dB
Phantom Power:	Selects between microphone and line inputs +48V
PAD:	20dB pad
PHASE:	Reverses pins 2 and 3 of the microphone input XLR
LOW CUT:	75Hz, 12dB/octave high pass filter
Analog Frequency Response:	<10Hz to 75kHz
THD+ Noise:	0.35% typical at +4dBu out, 1kHz, 40 dB gain

### Equalizer

LOW Frequency:	80 Hz, shelving filter
HIGH Frequency:	12 kHz, shelving filter
MID Frequency:	Sweepable from 100 Hz to 8 kHz, bandwidth 1.5 octaves
Gain (all bands):	Sweepable from -15 to +15 dB

### Compressor

Threshold Range:	-40 dBu to +20 dBu
Threshold Characteristic:	Selectable OverEasy or Hard Knee
Compression Ratio:	Variable; 1:1 to Infinity:1; 60 dB maximum Compression
Attack Time:	Program-dependent; Typically 5 ms (SLOW disabled), 15 ms (SLOW enabled) for 15 dB Gain Reduction
Release Time:	Program-dependent; Typically 50 dB/sec (SLOW disabled), 8 dB/sec (SLOW enabled)

### De-Esser

Characteristic:	Wideband gain reduction
Frequency Range:	800 Hz to 10 kHz High Pass
Release Time:	12 dB/octave program-dependent; approximately 1 ms/dB

### Analog to Digital Conversion

Type:	dbx Type IV™ A/D Conversion System
Sample Rate:	96, 88.2, 48, or 44.1kHz selectable
Wordlength:	24, 20, or 16 bit selectable
Dither Type:	TPDF, SNR <sup>2</sup> , or none
Noise Shape:	Shape 1, Shape 2, or none
Output Format:	S/PDIF or AES/EBU
Converter Dynamic Range:	107dB typical, A-weighted, 22kHz bandwidth

### Power Supply

Operating Voltage:	120VAC 60Hz, 100VAC 50/60Hz
DO:	120VAC 60Hz, 100VAC 50/60Hz
EU:	230VAC 50/60 Hz

### Power Requirements:

35 Watts



***PROFESSIONAL PRODUCTS***

**H** A Harman International Company

8760 South Sandy Pkwy.

Sandy, Utah 84070

Phone: (801) 568-7660

Fax: (801) 568-7662

Int'l Fax: (603) 672-4246

Questions or comments?

E-mail us at: [customer@dbxpro.com](mailto:customer@dbxpro.com)

or visit our World Wide Web home page at:

[www.dbxpro.com](http://www.dbxpro.com)