

VISUAL PRESENTER

MX-1

取扱説明書

ご使用になる前に本取扱説明書をよくお読みください。

日本語

INSTRUCTION MANUAL

Please read this instruction manual carefully before using this product.

English

MANUEL D'INSTRUCTIONS

Veillez lire attentivement ce manuel d'instructions avant d'utiliser ce produit.

Français

BEDIENUNGSANLEITUNG

Bitte lesen Sie dieses Bedienungshandbuch aufmerksam durch, bevor Sie dieses Produkt benutzen.

Deutsch

■ IMPORTANT SAFEGUARDS

■ Read Instructions

All the safety and operating instructions should be read before the appliance is operated.

■ Retain Instructions

The safety and operating instructions should be retained for future reference.

■ Heed Warnings

All warnings on the product and in the operating instructions should be adhered to.

■ Follow Instructions

All operating and use instructions should be followed.

■ Cleaning

Unplug this product from the wall outlet before cleaning. Do not use liquid cleaners or aerosol cleaners. Use a damp cloth for cleaning.

■ Attachments

Do not use attachments not recommended by the product manufacturer as they may cause hazards.

■ Water and Moisture

Do not use this product near water - for example, near a bath tub, wash bowl, kitchen sink, or laundry tub, in a wet basement, or near a swimming pool, and the like.

■ Placement

Do not place this product on an unstable cart, stand, tripod, bracket, or table. The product may fall, causing serious injury to a child or adult, and serious damage to the product. Use only with a cart, stand, tripod, bracket, or table recommended by the manufacturer, or sold with the product. Any mounting of the product should follow the manufacturer's instructions, and should use a mounting accessory recommended by the manufacturer.

■ Ventilation

Slots and openings in the cabinet are provided for ventilation and to ensure reliable operation of the product and to protect it from overheating, and these openings must not be blocked or covered. The openings should never be blocked by placing the product on a bed, sofa, rug, or other similar surface. This product should not be placed in a built-in installation such as a bookcase or rack unless proper ventilation is provided or the manufacturer's instructions have been adhered to.

■ Power Sources

This product should be operated only from the type of power source indicated on the marking label. If you are not sure of the type of power supply to your home consult your appliance dealer or local power company. For products intended to operate from battery power, or other sources, refer to the operating instructions.

■ Grounding or Polarization

This product may be equipped with either a polarized 2-wire AC line plug (a plug having one

blade wider than the other) or a 3-wire grounding type plug, a plug having a third (grounding) pin. The 2-wire polarized plug will outlet, try reversing the plug. If the plug still fails to fit, contact your electrician to replace your obsolete outlet. Do not defeat the safety purpose of the polarized plug. The 3-wire grounding type plug will fit into a grounding type power outlet. This is a safety feature. If you are unable to insert the plug into the outlet, contact your electrician to replace your obsolete outlet. Do not defeat the safety purpose of the grounding type plug.

■ Power-Cord Protection

Power-supply cords should be routed so that they are not likely to be walked on or pinched by items placed upon or against them, paying particular attention to cords at plugs, convenience receptacles, and the point where they exit from the product.

■ Lightning

For added protection for this product during a lightning storm, or when it is left unattended and unused for long periods of time, unplug it from the wall outlet and disconnect the antenna or cable system. This will prevent damage to the product due to lightning and power-line surges.

■ Overloading

Do not overload wall outlets, extension cords, or integral convenience receptacles as this can result in a risk of fire or electric shock.

■ **A product and cart combination should be moved with care. Quick stops, excessive force, and uneven surfaces may cause the product and cart combination to overturn.**



■ Object and Liquid Entry

Never push objects of any kind into this product through openings as they may touch dangerous voltage points or short-out parts that could result in a fire or electric shock. Never spill liquid of any kind on the product.

■ Servicing

Do not attempt to service this product yourself as opening or removing covers may expose you to dangerous voltage or other hazards. Refer all servicing to qualified service personnel.

■ Damage Requiring Service

Unplug this product from the wall outlet and refer servicing to qualified service personnel under the following conditions:

- When the power-supply cord or plug is damaged.
- If liquid has been spilled, or objects have fallen into the product.
- If the product has been exposed to rain or water.
- If the product does not operate normally by following the operating instructions. Adjust only those controls that are covered by the operating instructions as an improper adjustment of other controls may result in damage and will often require extensive work by a qualified technician to restore the product to its normal operation.
- If the product has been dropped or damaged in any way.

- When the product exhibits a distinct change in performance - this indicates a need for service.

■ Replacement Parts

When replacement parts are required, be sure the service technician has used replacement parts specified by the manufacturer or have the same characteristics as the original part.

Unauthorized substitutions may result in fire, electric shock or other hazards.

■ Safety Check

Upon completion of any service or repairs to this product, ask the service technician to perform safety checks to determine that the product is in proper operating condition.

■ Heat

The product should be situated away from heat sources such as radiators, heat registers, stoves, or other products (including amplifiers) that produce heat.

- This product includes a Fluorescent Lamps component that contains mercury. Please consult your state and local regarding proper disposal or recycling, and do not place in the trash.

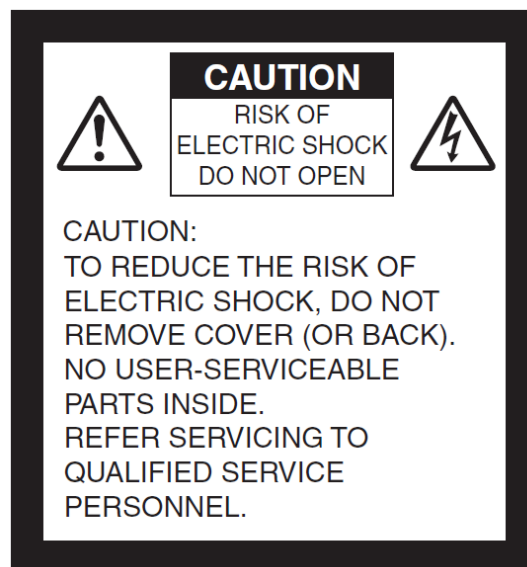

日本語

English

Français

Deutsch



SA 1965

The lightning flash with arrowhead symbol, within an equilateral triangle, is intended to alert the user to the presence of uninsulated “dangerous voltage” within the product’s enclosure that may be of sufficient magnitude to constitute a risk of electric shock to persons.



SA 1966

The exclamation point within an equilateral triangle is intended to alert the user to the presence of important operating and maintenance (servicing) instructions in the literature

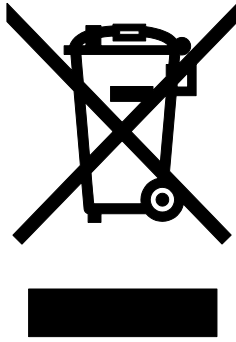

This symbol [crossed-out wheeled bin WEEE Annex IV] indicates separate collection of waste electrical and electronic equipment in the EU countries. Please do not throw the equipment into the domestic refuse. Please use the return and collection systems available in your country for the disposal of this product.

WARNING

TO REDUCE THE RISK OF FIRE OR ELECTRIC SHOCK, DO NOT EXPOSE THIS PRODUCT TO RAIN OR MOISTURE.

The connection of a non-shielded equipment interface cable to this equipment will invalidate the FCC Certification or Declaration of this device and may cause interference levels which exceed the limits established by the FCC for this equipment. It is the responsibility of the user to obtain and use a shielded equipment interface cable with this device. If this equipment has more than one interface connector, do not leave cables connected to unused interfaces. Changes or modifications not expressly approved by the manufacturer could void the user's authority to operate the equipment.

FOR UNITED STATES USERS: INFORMATION

This equipment has been tested and found to comply with the limits for a Class A digital device, pursuant to Part 15 of the FCC Rules. These limits are designed to provide reasonable protection against harmful interference when the equipment is operated in a commercial environment.

This equipment generates, uses, and can radiate radio frequency energy and, if not installed and used in accordance with the instruction manual, may cause harmful interference to radio communications. Operation of this equipment in a residential area is likely to cause harmful interference in which case the user will be required to correct the interference at his own expense.

USER-INSTALLER

CAUTION:

Your authority to operate this FCC verified equipment could be voided if you make changes or modifications not expressly approved by the party responsible for compliance to Part 15 of the FCC rules.

日本語

English

Français

Deutsch

BEFORE YOU USE

- Be sure to use the USB cable supplied with the product.
- The supplied USB cable is designed to be used for the MX-1 only. Do not use it for other products.
- When storing the product, do not leave it under direct sunlight or by heaters. It may be discolored, deformed, or damaged.
- Do not place this product in any humid, dusty, salt bearing wind, or vibrating locations. Use it under the following environmental conditions:
 - Temperature: 0°C - 40°C
 - Humidity: 30% - 85% (No condensation)
- Use a soft, dry cloth for cleaning.
 - Do not use any volatile solvent such as thinner or benzene.
- Luminescent and Black Spots
 - There may be some pixels that do not properly operate due to the use of CMOS Area Image Sensors made-up of many pixels.
 - Though luminescent or black spots may be found on the screen, it is a phenomenon peculiar to the CMOS Area Image Sensors and is not a malfunction.
- Follow the guidelines below to prevent the unit from dropping or overturning.
 - Use the product on a stable base, desk, or table. Do not place the product on an unstable base or slanted location.
 - Place or wire the product to prevent the USB cable from pulling.
- Do not point the lens directly to the sun. It could degrade the imaging capability.
- Do not look directly into the LED light. If you look directly into it at pointblank range, your eyes may be injured.
- If this product is used for longer than the warranty period, its performance and quality may deteriorate due to the lifetime of its parts. For parts replacement (on chargeable basis), consult the dealer from whom you purchased this product or our branch/office near your location.
- Copyright
 - Unless used for personal use, it is prohibited strictly under copyright law to use any photo files without the prior consent of the copyright holder. Even if using for personal use, be careful that there could be a situation where video or audio recording is restricted or illegal.
- The contents of this document are subject to change without notice. The latest version can be obtained from the following MX-1 Official Website:
 - <https://www.elmoussa.com/>
- It is prohibited under copyright law to use or copy any part or the whole of this document without our prior written consent.
- ELMO shall not be liable for any claim for damage or loss of earnings or any claim raised by a third person due to the use, malfunction or repair of this product.

HANDLING PRECAUTIONS

The followings are special precautions against mishandling of the product, which may cause serious damages to the product. Pay close attention to them.

① Installation

Do not place the MX-1 on an unstable place or slanted surface.

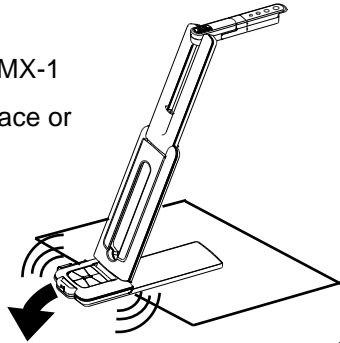

② Magnet in the bottom

A magnet is in the bottom of the MX-1. Keep the bottom of the MX-1 away from devices and objects that could be damaged by strong magnetic fields (such as a computer, monitor, and magnetic card).

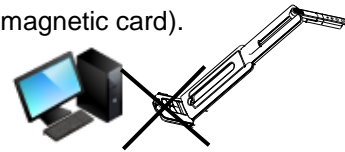

③ Setting up

When setting up the MX-1, hold the body around the Operating panel. Be careful not to pinch your fingers.

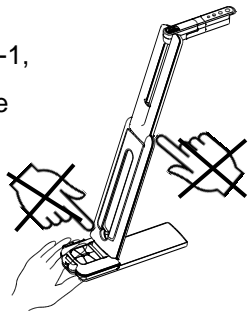

④ Carrying the MX-1

Carry the MX-1 by folding the arm so as not to damage the camera. Do not carry by holding the arm or camera head.

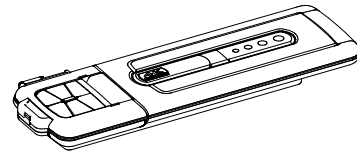

⑤ Stage

There is a magnet inside the bottom of the MX-1. By removing 2 screws in the bottom, you can move the position of the MX-1 within the stage. Do not attach the MX-1 to a metal object such as a steel cabinet. The stage may fall and get broken.

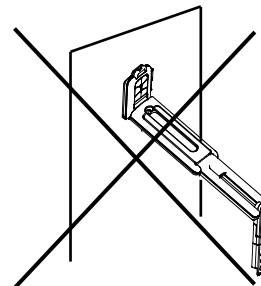

日本語

English

Français

Deutsch

■ TABLE OF CONTENTS

■ IMPORTANT SAFEGUARDS	24
BEFORE YOU USE	28
HANDLING PRECAUTIONS	29
■ TABLE OF CONTENTS	30
① PACKAGE CONTENTS	30
② PART NAMES AND FUNCTIONS	31
■ THE NAME OF EACH PART	31
■ OPERATING PANEL	33
■ SIDE PANEL AND CABLE CONNECTION	35
■ RESOLUTION / FRAME RATE	35
■ ABOUT MX-1 CONNECT BOX	36
■ SIZE OF THE OUTPUT IMAGE	36
③ PREPARATION AND CONNECTION	36
■ SETTING UP THE MX-1	37
■ MOVING PARTS OF THE MX-1	38
■ CONNECTING TO A COMPUTER	39
■ CONNECTING TO A PROJECTOR OR MONITOR	39
④ SHOOTING IMAGES	40
■ ADJUSTING THE SIZE	40
■ ADJUSTING THE BRIGHTNESS	40
■ ADJUSTING THE FOCUS	40
■ PAUSING THE IMAGE	40
■ ROTATING THE IMAGE	40
■ TURNING THE LED LIGHTING ON/OFF	40
⑤ ABOUT IMAGE MATE4	40
■ SYSTEM REQUIREMENTS	41
■ INSTALLING IMAGE MATE 4	41
⑥ TROUBLE SHOOTING	43
■ SYMPTOMS AND CONFIRMATION	43
⑦ SPECIFICATIONS	44
■ MAIN CAMERA	45
■ FUNCTIONAL SPECIFICATION	45
■ ILLUMINATION DEVICE	46
■ TRADEMARKS AND LICENSES	47

1 PACKAGE CONTENTS

The items below are included with this product. If any item is missing, contact the dealer from whom you purchased this product.

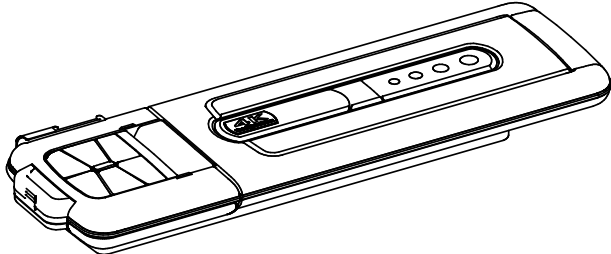
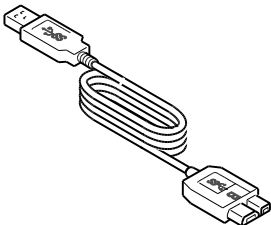
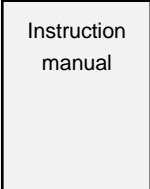
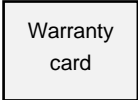
Document Camera (MX-1)		
P. 32 		
		
USB3.0 cable	Instruction manual	Warranty card (Only Japan and North America)
		

日本語

English

Français

Deutsch

② PART NAMES AND FUNCTIONS

THE NAME OF EACH PART

Operation of the main unit: [P. 37](#)

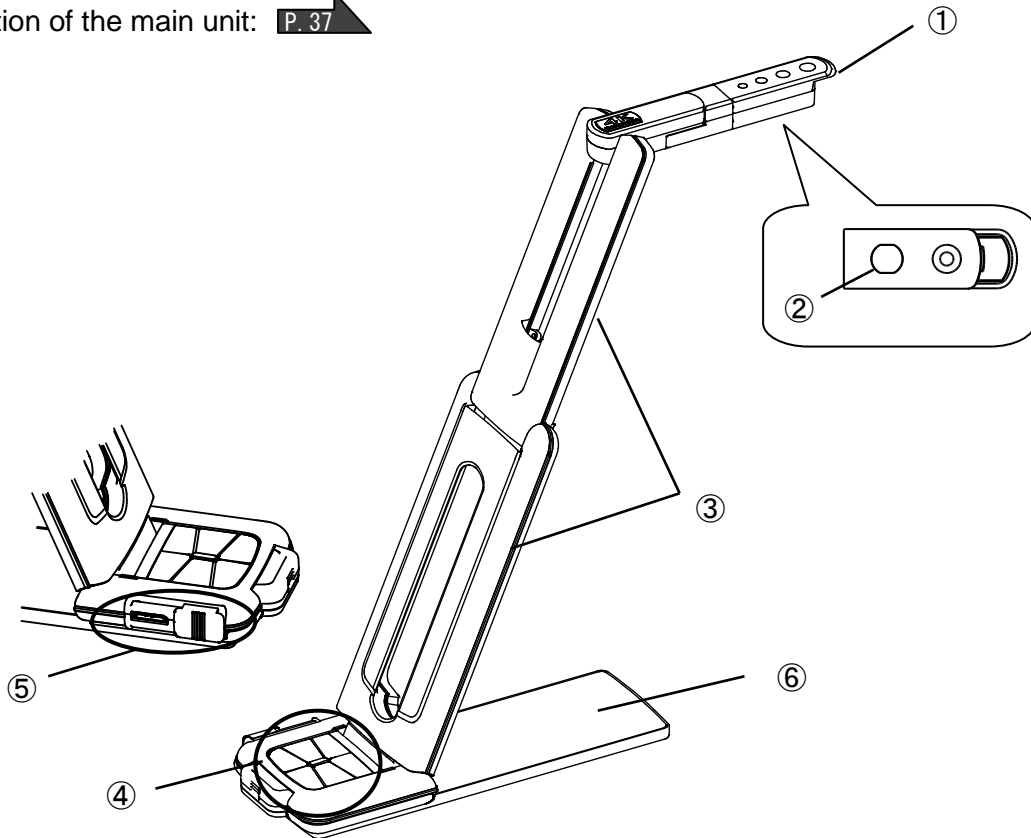

	Name	
①	Camera head	
②	LED lighting	P. 40
③	Arm	
④	Operating panel	P. 33
⑤	Side panel	P. 35
⑥	Stage	

OPERATING PANEL

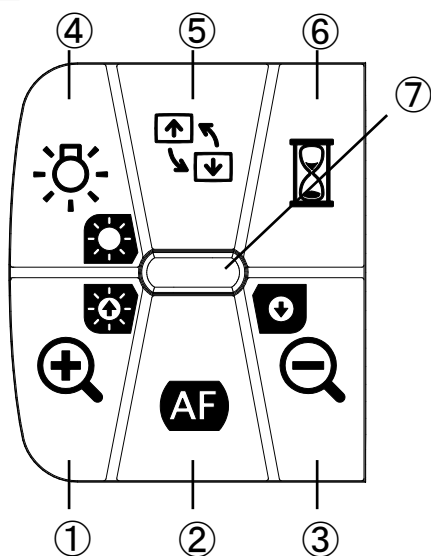



⑦ LED display

LED color		On/Off	Operation status	Connection status
	Off	Off	Power OFF	-
	Blue	On	Zoom mode	USB3.0
	Green	On	Zoom mode	USB2.0
	Purple	On	Brightness adjustment mode	-

※ Select the mode according to the application. (④ long press)

- Zoom mode ... To enlarge or shrink the image, to On or Off the LED lighting.
- Brightness adjustment mode ... To brighten or darken the image.

Mode	Button	Function	Description
 Zoom mode (blue or green)	①	ZOOM-IN	To enlarge the image.
	②	One-Push AF	To focus automatically.
	③	ZOOM-OUT	To shrink the image.
	④ (Short press)	LED lighting	On / Off
	④ (Long press)	Brightness adjustment mode selection	To use ① and ③ buttons to adjust the brightness.
	⑤	Image rotation	To rotate the image. (0°/180°)
	⑥	Freeze	To pause or restart the image.
 Brightness adjustment mode (purple)	①	Brightness +	To brighten the image
	②	One-push AF	To focus automatically.
	③	Brightness -	To darken the image
	④	Zoom mode selection	To use ① and ③ buttons to adjust the zoom.
	⑤	Image rotation	To rotate the image. (0°/180°)
	⑥	Freeze	To pause or restart the image.
	①+③	Initialization of the brightness	To initialize the brightness level.

※The Zoom function and Freeze function may not be used when a commercially available software is used.

■ SIDE PANEL AND CABLE CONNECTION

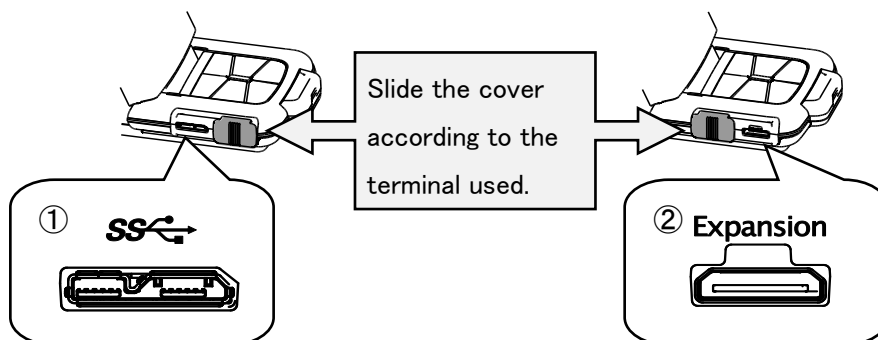

	Mark	Function
①		To connect to a computer to save image data, etc. (USB3.0 cable is included.)
②		To connect the MX-1 CONNECT BOX to display to a monitor or projector without using a computer. (Expansion cable is include to MX-1 CONNECT BOX.) Max. resolution 4:3 UXGA1600x1200 16:9 1980x1080p

Note

Depending on the computer's USB environment or the peripheral equipment, image transfer may be disrupted. We do not guarantee the operation of all types of devices with the MX-1.

■ RESOLUTION / FRAME RATE

There is no difference in resolution between USB3.0 connection and USB2.0 connection.

The frame rate may be lower than the specification in the following conditions:

- A low-spec computer is used.
- YUV is selected.

Resolution	USB3.0		USB2.0	
	MJPEG[fps]	YUV[fps]	MJPEG[fps]	YUV[fps]
4160x3120	21	6	6	1
3840x2160	30	15	6	1
2048x1536	30	20	18	3
1920x1080	60	60	30	5
1280x960	30	30	30	10
1280x720	60	60	60	5
1024x768	30	30	30	20
640x480	30	30	30	30

■ ABOUT MX-1 CONNECT BOX

The MX-1 can be connected to a projector or a monitor through HDMI or RGB using the MX-1 CONNECT BOX.

P. 39

For details of the MX-1 CONNECT BOX, refer to the instruction manual included in the MX-1 CONNECT BOX.

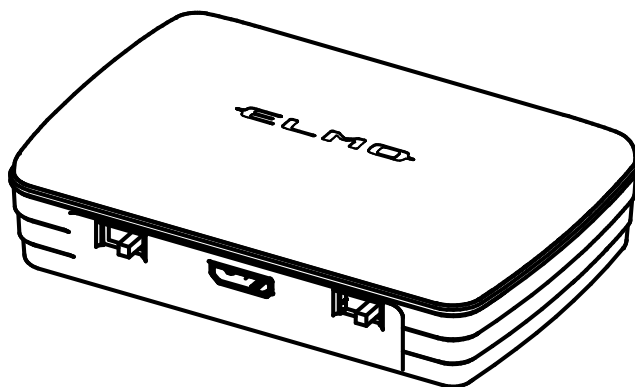

Note

The MX-1 CONNECT BOX is not included when you purchase the MX-1 only.

■ SIZE OF THE OUTPUT IMAGE

The output image varies depending on the setting of the Resolution/Output mode and whether the MX-1 CONNECT BOX is used or not.

For details of the size of the output image, refer to the instruction manual included in the MX-1 CONNECT BOX.

③ PREPARATION AND CONNECTION

■ SETTING UP THE MX-1

① Raise the body while holding the operating panel.

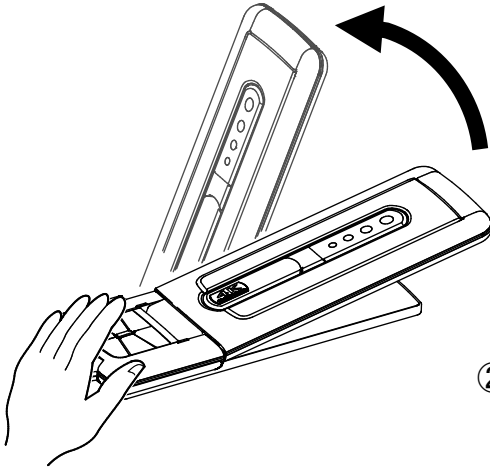

② Raise the arm as indicated by an arrow.

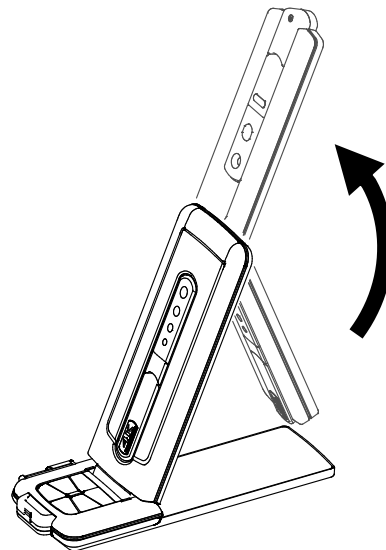

③ Raise the camera head. Set it horizontally.

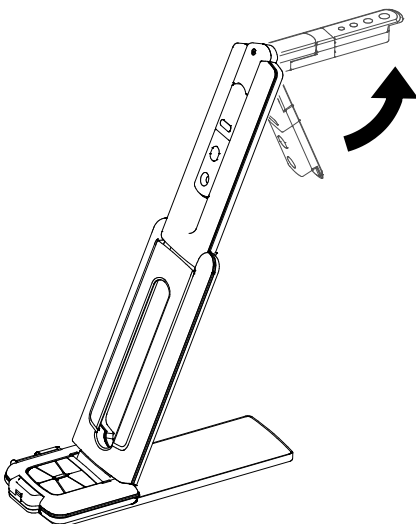

Caution

- Be careful not to pinch your fingers when moving the arm.
- Do not hold the arm or camera head when carrying the MX-1.
- Be careful not to give an impact to the camera head.

MOVING PARTS OF THE MX-1

The MX-1 can be moved as shown below.

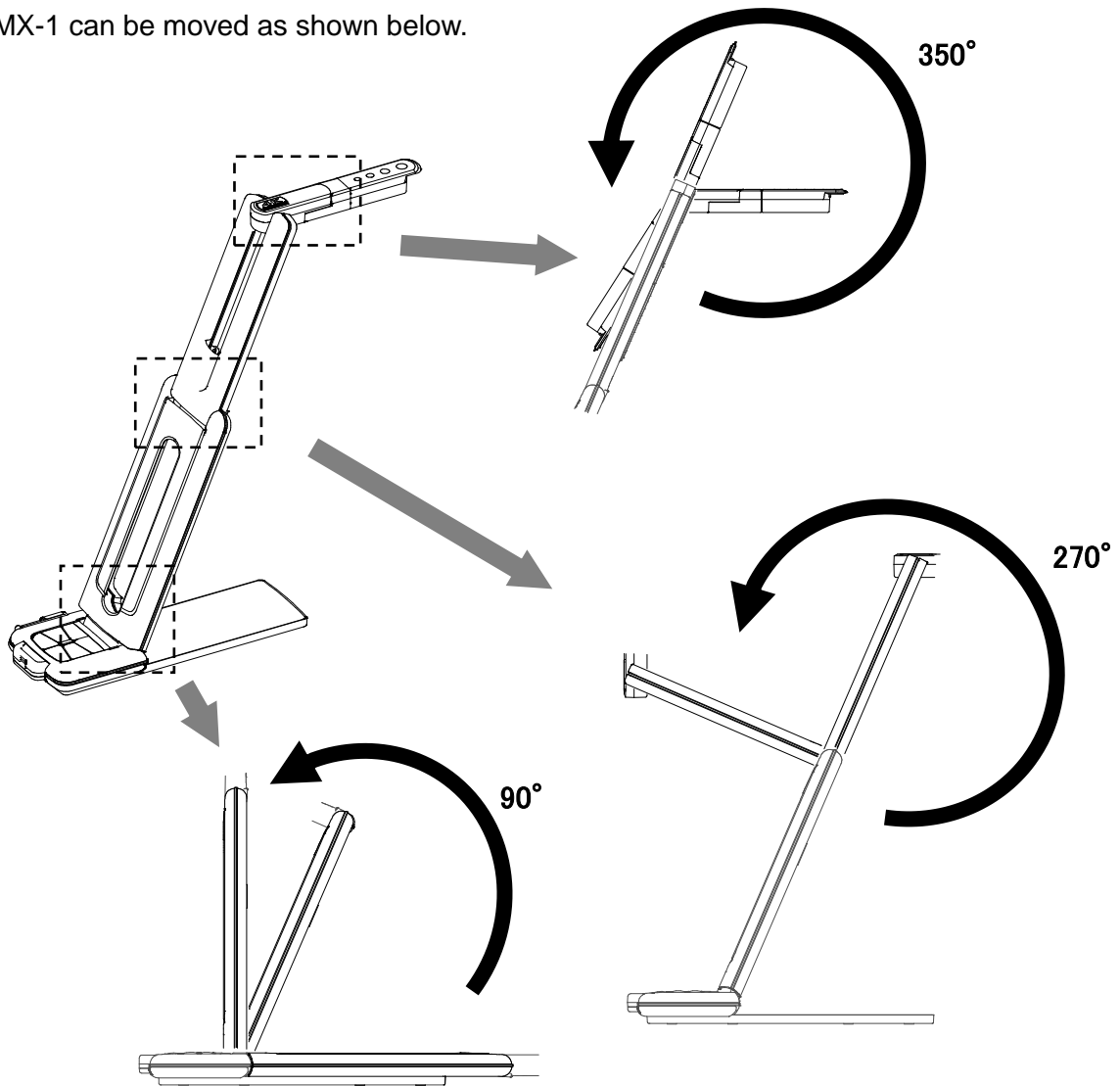

Camera head

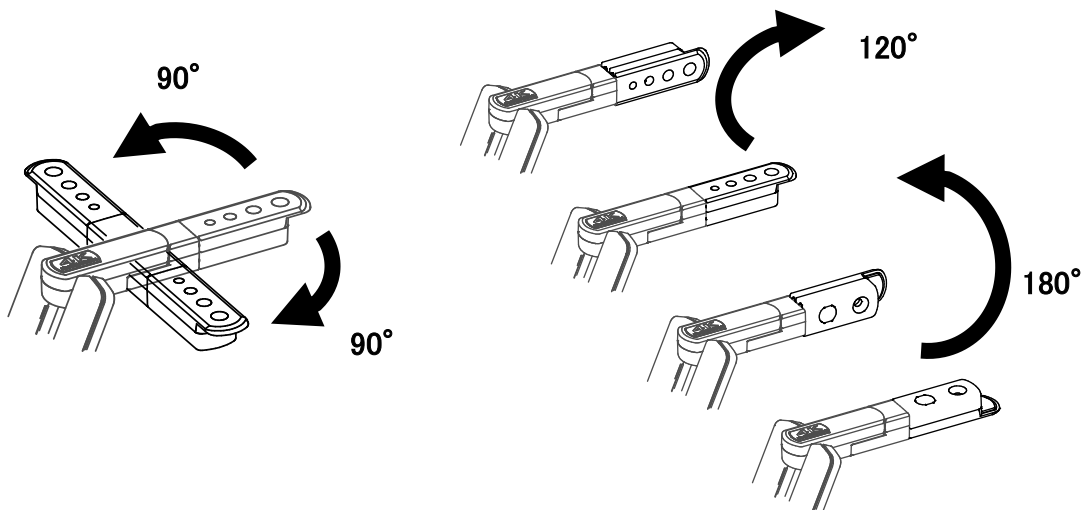

日本語

English

Français

Deutsch

CONNECTING TO A COMPUTER

The MX-1 is compliant to uvc (video class) standard. You can transfer the image via USB by connecting the MX-1 to a computer using the USB3.0 cable (bus power).

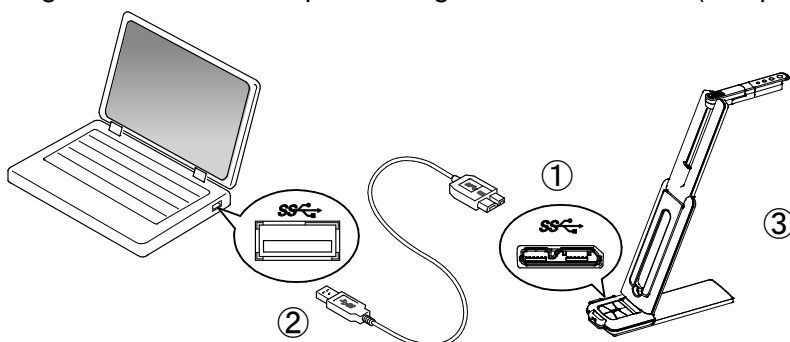

- ① Connect the microB connector terminal of the USB3.0 cable to  connector in the side of the MX-1.
- ② Connect the typeA terminal of the USB3.0 cable to the USB port of your running computer.
- ③ The MX-1 will be turned on after the connection is established.

Caution

- When connecting to the USB2.0 port, the frame rate may be decreased depending on the output resolution.
- The frame rate may be decreased depending on the computer used.

CONNECTING TO A PROJECTOR OR MONITOR

By using the MX-1 CONNECT BOX, you can connect the MX-1 to a projector or monitor without using a computer.

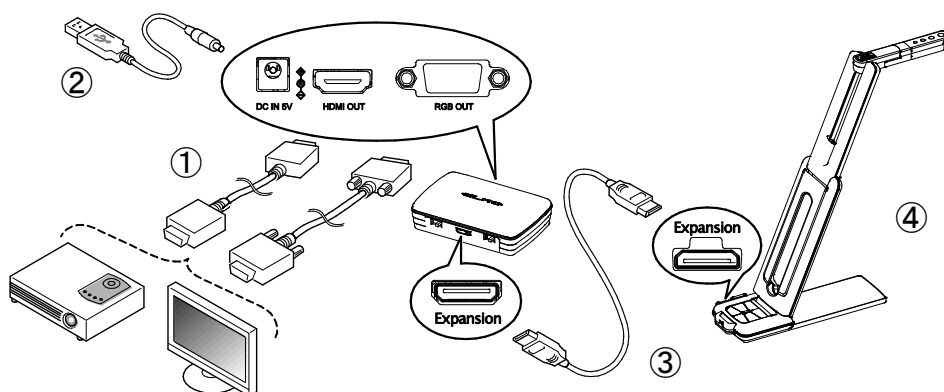

P. 36



- ① Connect a projector or monitor to the MX-1 CONNECT BOX via the HDMI cable or RGB cable.
- ② Connect the supplied DC power cable to . Connect the USB plug to the AC adapter. Then connect it to a wall outlet.
- ③ Connect the MX-1 to the MX-1 CONNECT BOX via the supplied Expansion cable.
- ④ The MX-1 and MX-1 CONNECT BOX will be powered on. (MX-1 of LED: blue)

4 SHOOTING IMAGES

■ ADJUSTING THE SIZE



The image size can be adjusted using [ / ] buttons on the Operating panel in the Zoom mode (LED: blue/green). If the MX-1 is in the Brightness adjustment mode (LED: purple), change the mode to the Zoom mode.

P. 33

Note

The maximum zoom ration is 8x (digital zoom).
The image quality will be degraded when using the digital zoom.

■ ADJUSTING THE BRIGHTNESS

The brightness of the image can be adjusted using [ / ] buttons on the Operating panel in the Brightness adjustment mode (LED: purple). The brightness does not change automatically according to the brightness of the shooting environment. If the MX-1 is in the Zoom mode (LED: blue/green), change the mode to the Brightness adjustment mode.

P. 33

■ ADJUSTING THE FOCUS

Press the  button on the Operating panel to automatically focus on an object.

P. 33

■ PAUSING THE IMAGE

Press the  button to pause the camera image. Press the button again to restart. (This function can be used in both the Zoom mode and Brightness adjustment mode.)

P. 33

■ ROTATING THE IMAGE

The image rotates by 180° by pressing the  button on the Operating panel.

(This function can be used in both the Zoom mode and Brightness adjustment mode.)

P. 33

■ TURNING THE LED LIGHTING ON/OFF

The LED lighting can be turned ON/OFF by pressing  button on the Operating panel in the Zoom mode (LED: blue/green). If the MX-1 is in the Brightness adjustment mode (LED: purple), change the mode to the Zoom mode.

P. 33

Caution

- To take shots of people, turn the LED lighting OFF.
- Make sure that the light from the LED lighting does not shine directly into your eyes.
- This product is equipped with a high-brightness LED. You can safely use it to light up the object. The brightness will gradually decrease with long-term use. This is not a malfunction but a characteristic of the LED.
- Do not touch the LED lighting while it is on as it may become very hot.

5 ABOUT IMAGE MATE4

The following operations can be performed by connecting the MX-1 to a computer with Image Mate 4 installed via the USB cable:

P. 39

- Save live video streaming or still images to a computer
- Operate the MX-1 from a computer, etc.

※If Image Mate 4 is already installed in your computer, update the version of Image Mate 4.
※You can view the camera image with a commercially available software. With Image Mate 4, you can also use other functions such as zoom and freeze.

This instruction manual explains the downloading/installation procedure of Image Mate 4 and its instruction manual.

For further details, refer to the instruction manual of Image Mate 4. You can download the instruction manual of Image Mate 4 from the following website:

<http://www.elmoussa.com>

SYSTEM REQUIREMENTS

The Image Mate 4 can be used in the following computer environments.

OS	Win10 64bit
CPU	Core i7(3840x2160@30fps) Core i5 or higher (1920x1080@60fps)
Memory	16GB(3840x2160@30fps) 4GB or more (1920x1080@60fps)
Screen resolution	3840x2160(3840x2160@30fps) 1920x1080 or higher (1920x1080@60fps)
Graphic board	Should be able to output 3840x2160
USB	USB3.0

Note

If your computer does not meet these requirements or depending on the performance of your computer, the recording frame rate may be decreased.

日本語

English

Français

Deutsch

■ INSTALLING IMAGE MATE 4

Install Image Mate 4 to your computer.

※Image Mate 4 can be downloaded from Elmo official website.

※If Image Mate 4 is already installed in your computer, update the version of Image Mate 4.

1. Access the following Elmo official website.

<http://www.elmousa.com>

2. Choose Image Mate 4.
3. Click “Download” and read the “Precautions on the handling of the downloaded data”.
Click “Agree”.
4. Downloading will start.
5. Run the downloaded file (ImageMate4Setup.msi) after the downloading is completed.
Follow the instructions displayed on the screen to install Image Mate 4.
6. The icon  will be created on the desktop after the installation is completed.

Caution

- Do not connect/disconnect the USB cable while operating the MX-1. It may cause malfunction.
- We recommend using the supplied USB cable.
- It may take some time to display the image after the resolution is changed via UVC (with the USB cable). Do not turn off the power of the MX-1 or disconnect the USB cable before the image is displayed.
- The displayed image may pause for a brief second when the object moves quickly. This is not a malfunction.
- The displayed image may be distorted depending on the object. Reducing the resolution or frame rate may improve the distortion of the image.





Note

- Depending on the computer's USB environment or the peripheral equipment, image transfer may be disrupted.
- We do not guarantee the operation of all types of devices with the MX-1.

⑥ TROUBLE SHOOTING

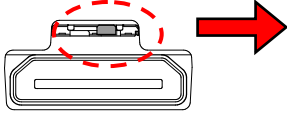
■ SYMPTOMS AND CONFIRMATION

Check the following items. If any abnormality is found, consult the dealer from whom you purchased this product or our nearest branch/office.

Symptom	Possible cause/ remedy
No image is displayed.	<ul style="list-style-type: none"> The cable is not correctly connected. Zoom is set at the TELE side, displaying only the white or black part of the document. If you turn the power ON immediately after turning it OFF, the unit may not start. Wait for several seconds after turning the power OFF, and then turn it back ON. The USB cable is disconnected. The switch in the side panel is set to the left. Make sure that the switch is set to the right. 
No image is displayed.	<ul style="list-style-type: none"> Image Mate 4 is not started correctly. Restart Image Mate 4 and try to connect again. The MX-1 is not selected in the setting of Image Mate 4.
The image is out of focus.	<ul style="list-style-type: none"> The document (object) is too close to the lens. Move the document (object) slightly away from the lens.
The image is too dark.	<ul style="list-style-type: none"> The intensity of the lighting is insufficient. Press the  button on the operating panel to adjust the brightness. Or press the  button to turn on the LED lighting. P. 33
The image does not move.	<ul style="list-style-type: none"> The "Freeze" function is selected by pressing  button on the Operating panel. Cancel the freeze status by pressing  button again. The "Freeze" function is selected by Image Mate 4. Cancel the freeze status to resume the live image feed. P. 33
The image is striped.	<ul style="list-style-type: none"> This may be interference fringes between dots of printed matter and TV scanning lines or CMOS pixels. Changing the shooting range may improve the problem. The image may be distorted when shooting a monitor screen while the live image feed is displayed.

The UVC video stream is upside down.	<ul style="list-style-type: none"> Verify that the graphic driver and other device drivers of your computer are the latest version. You can download the latest version of device drivers from the official website of the manufacturer of your computer.
Other image than the camera image overlaps on the UVC video stream.	<ul style="list-style-type: none"> Depending on your software, OS or the connection status, other images than the camera image may be overlapped on the camera image. This can be solved by reconnecting the MX-1 or restarting the software.
No UVC video stream is displayed. (An error message appears.)	<ul style="list-style-type: none"> The software may recognize it as error when it takes time to prepare the image output. Restart the MX-1 and reconnect it to the computer. Then restart the software.
Fails to output the UVC video stream.	<ul style="list-style-type: none"> Disconnect the USB cable and restart the software. Then connect the USB cable again.
The UVC video stream sometimes freezes.	<ul style="list-style-type: none"> The displayed image may pause for a brief second when the object moves quickly. In that case, adjusting the brightness manually may improve the problem. 
There is a distortion of the image.	<ul style="list-style-type: none"> Use a high-spec computer. Also, reducing the resolution or frame rate may improve the distortion of the image.
4K image cannot be displayed.	<ul style="list-style-type: none"> The system requirements to display 4K image are as follows: <ul style="list-style-type: none"> CPU: Intel® Core™ i7 or higher Memory: 16GB Graphic board: GeForce GTX750 or higher

About the light (LED lighting)

The brightness of the LED lighting will diminish with long-term use. If its brightness has significantly diminished, consult the dealer from whom you purchased this product or our nearest branch/office for replacement (subject to charge).

About long-term usage of this product

Due to the lifetime of its parts, if this product is used for longer than the warranty period, its performance and quality may deteriorate. In this case, we will replace the parts for a charge. Consult the dealer from whom you purchased this product or our nearest branch/office.

About using the MX-1 without the stage

We do not recommend using the MX-1 without the stage. We cannot be held responsible for any damages caused by the use of the MX-1 without the stage even if still within the warranty period.

7 SPECIFICATIONS

MAIN CAMERA

Item	Specifications
Power source	DC5V ※Power supply by the USB bus power
Power consumption	3.2W
Outside dimensions	W 73.2 xD 294.3 xH 298[mm](When setup)
	W 73.2 xD 244 xH 18[mm](When folded)
Weight	Approx. 2.4kg (Main body only)
Ext. control terminal	USB3.0 type microB x 1
	Expansion terminal (Exclusive) x 1 ※The expansion terminal connects with MX-1 CONNECT BOX.
Lens	F=2.0
Frame rate	60fps (in high frame rate mode at 1080P)
Focus working range	From lens surface: 100mm ~ ∞
Focus	Auto (One-push)
Image pick-up element	1/3.1 inch CMOS 13,000,000 pixels
Effective pixels	H: 4160, V: 3120
Sync. signal	Internal
Imaging area	374mmx281mm (Height: 286mm) 4:3

※The MX-1 CONNECT BOX is required to output in RGB and HDMI

FUNCTIONAL SPECIFICATION

Item	Content	Operation panel	IM4	Application
Brightness	Auto (Set value 0~12)		✓	
Image rotation	0°/180° (Camera video)		✓	
LED lighting	ON/OFF	✓		✓
AF	Auto (One-push)		✓	
Zoom	Possible		✓	
Video still	Possible		✓	
Resolution	Manual			✓
Flicker	60Hz / 50Hz			✓
Contrast	Possible (Set value 0~20)			✓
Hue	Possible (Set value -180~180)			✓
Saturation	Possible (Set value 0~31)			✓
Definition	Possible (Set value 5~15)			✓
Gamma	Possible (Set value 100~200)			✓

WhiteBalance	Auto/Manual (Set value 2000 ~ 8000)		✓
Backlight	ON/OFF		✓
Focus	Auto/Manual (Set value 100~3000)		✓
Exposure	Auto/Manual (Set value -10~1)		✓
Low-light	Auto/Manual		✓
Color Mode	Normal/Gray/Negative /Black-and-White		✓
Scene Mode	Normal/Document		✓
Priority Mode	Binned/Resized		✓
NoiseReduction	Auto/Manual (Set value 0~10)		✓
MaxFramerate	Auto/Manual (Set value 3~30)		✓
Factory setting	Possible		✓

■ ILLUMINATION DEVICE

Item	Specifications
Illumination	White LED

■ TRADEMARKS AND LICENSES

ELMO、Image Mate are the registered trademarks of ELMO Co., Ltd. HDMI、**HDMI**™ logo and High-Definition Multimedia interface are trademarks or registered trademarks of HDMI Licensing LLC.

All other company/product names described in this manual are trademarks or registered trademarks of their respective companies. This product is licensed under the AVC Visual Patent Portfolio License (AVC Video) for the personal and non-commercial use of a consumer to (i) play AVC Video that was recorded by a consumer engaged in a personal and a non-commercial activity and/or, (ii) play AVC Video that was obtained from a video provider licensed from MPEG-LA, LLC.

Additional information including that relating to promotional and commercial uses may be obtained from MPEG-LA, LLC

ATTENTION

- Unless used for personal use, it is prohibited by copyright law to record slides, books and photos without the prior consent of copyright holder.
- This product is designed to be used in industrial environment. If it is used in a residential area or in an adjacent area thereto, harmful interference to radio or television reception may occur.
- Repair parts
Repair parts are the items which are needed to maintain product functionality. The holding period of such repair parts is 3 years after the product discontinuation, which is equal to the repair period we will accept.
- Any image, which is obtained by this product, and which can be identified, is considered to be private information. Be forewarned that the person who makes use of such images shall be liable for disclosing of such images.

日本語

English

Français

Deutsch

株式会社エルモ社

〒467-8567
名古屋市瑞穂区明前町 6 番 14 号
Web: <http://www.elmo.co.jp>

製品のお問い合わせは、下記営業部へ
株式会社エルモ社
エルモソリューションカンパニー
Web: <http://www.elmosolution.co.jp>

□北海道営業部

〒001-0021 札幌市北区北 21 条西 8 丁目 3 番 8 号 バックスビル
TEL011-738-5811

□江別オフィス

〒069-0825 江別市野幌東町 17 番地 5
TEL011-391-8800

□東北営業部

〒980-0023 仙台市青葉区北目町 1 番 18 号 ピースビル北目町 4 階
TEL022-266-3255

□首都圏営業部

〒108-0073 東京都港区三田 3 丁目 12 番 16 号 山光ビル 4 階
TEL03-3453-6471

□セキュリティ営業部

〒108-0073 東京都港区三田 3 丁目 12 番 16 号 山光ビル 4 階
TEL03-3453-6471

□中部営業部

〒467-8567 名古屋市瑞穂区明前町 6 番 14 号
TEL052-811-5261

□近畿・四国営業部

〒550-0014 大阪市西区北堀江 3 丁目 12 番 23 号 三木産業ビル 9 階
TEL06-6541-0123

□近畿ソリューション営業部

〒550-0014 大阪市西区北堀江 3 丁目 12 番 23 号 三木産業ビル 9 階
TEL06-6531-2125

□中国営業部

〒730-0041 広島市中区小町 5 番 8 号 ドルチェ 2 階
TEL082-248-4800

□九州営業部

〒812-0039 福岡市博多区冷泉町 2 番 8 号 朝日プラザ祇園 2 階
TEL092-281-4131

□福岡オフィス

〒812-0039 福岡市博多区冷泉町 2 番 8 号 朝日プラザ祇園 2 階
TEL092-281-5658

□熊本オフィス

〒861-2104 熊本市東区秋津 3 丁目 11-7
TEL096-282-8338

OVERSEAS SUBSIDIARY COMPANIES

ELMO USA CORP.

□Headquarters
1478 Old Country Road
Plainview, NY 11803, U.S.A.
Tel. (516) 501-1400
Fax.(516) 501-0429
E-mail: elmo@elmousa.com
Web: <http://www.elmousa.com>

□West Coast Branch
5555 Garden Grove Boulevard.
Suite 375
Westminster, CA 92683
Tel. (714) 828-8457
Fax. (714) 828-8429

ELMO Europe SAS

□Headquarters
12 place de la Défense
Maison de la Défense
92974 Paris la Défense Cedex FRANCE
Tel. 33 (0) 1 73 02 67 06
Fax. 33 (0) 1 73 02 67 10
E-mail: info@elmoeurope.com
Web: <http://www.elmoeurope.com>

□German Branch
Hansaallee 201, Haus 1
40549 Düsseldorf Germany
Tel. 49 (0) 211 544756 40
Fax. 49 (0) 211 544756 60

ELMO CO., LTD.

6-14, Meizen-cho, Mizuho-ku
Nagoya, 467-8567, Japan