

Sx500PI+ 400-Watt Two-Way Weather-Resistant Speaker System

- Ring-Mode Decoupling (RMD™) Technology for increased intelligibility
- Black powder - coated, full-face stainless steel grille with foam backing and a polyester mesh water shield.
- Durable structural-foam enclosure with integral handles, stand mount and molded-in attachment points for secure suspension with optional brackets
- DL15Sx-W 15-inch woofer and DH2T compression driver for great sound and reliable performance
- Asymmetric constant-directivity 75° x 60° high-frequency horn
- Asymmetric horn-loaded woofer section
- 400-watt long-term rms power capacity
- Passive network with biamp capability

Description

The Electro-Voice Sx500PI+ is a weather-resistant version of the popular Sx500+ loudspeaker. It is a 400-watt, 15-inch two-way, biampable, high-efficiency, constant-directivity speaker system featuring a vented-horn woofer section. The weather-resistant features are the specially treated woofer, the DL15Sx-W, and the full-face stainless-steel grille backed with both foam and a polyester mesh water shield. Additionally, two port plugs are included for the customer to install when increased weather resistance is needed. Through extensive use of computer-aided design and modeling, Electro-Voice engineers have developed a state-of-the-art professional loudspeaker system for permanent installations where weather resistance is needed. The high-frequency section of the Sx500PI+ utilizes a molded-in 75° x 60° constant-directivity horn which is aimed downward by 10°. This unique pattern contributes to high intelligibility and aims the speaker's output where it is most useful. Vocals sound natural yet "cut through" in reverberant, noisy rooms. In addition, the coverage pattern is unusually uniform over its range of operation. The horn's unique, VariPath™ throat geometry helps direct driver output to the corners of the room, to points of coverage not described in the usual specifications of horizontal and vertical coverage angles, and to parts of the audience that typically do not receive the strongest coverage.

One of the many other unique features of the Sx500PI+ is the cabinet. Constructed of high-impact polypropylene structural foam, it provides a stiff and extremely durable enclosure. The cabinet includes integral carrying handles and a stand socket for mounting on 1³/₈-inch stands such as the Electro-Voice 100BK. Rubber feet that are attached to the bottom of the cabinet and mating sockets that are molded into the top provide a means of stacking systems. The shaped plastic cabinet, in combination with the uniform, 75° x 60° directivity characteristics, make the Sx500PI+ ideal for use alone or in arrays.

The Sx500PI+'s high-frequency horn is driven by the DH2T one-inch throat, wide-bandwidth, titanium-diaphragm driver. This driver uses a unique, convex-drive Time Path™ phasing plug structure (U.S. Patent #4,525,604) for smooth and extended high-frequency performance. The voice coil is coupled to the diaphragm with EV's exclusive Resonant Drive™ Technology. This increases and smooths the high-frequency response and reduces the amount of internal equalization required for flat frequency response, which extends to 20,000 Hz.

A self-resetting high-frequency protection circuit, EV's PRO™ circuit, is included with the Sx500PI+ to prevent against accidental overdrive and improve system reliability. If the input power to the high-frequency driver exceeds the nominal rating, the protection circuit is activated and reduces the power delivered to the driver by 6 dB. The system will remain in this

mode of operation until the input power is reduced to a safe level.

The bass section of the Sx500+ is a vented-horn design using Thiele-Small parameters for solid performance to 45 Hz. This horn provides directivity control for the woofer section and matches the asymmetry of the high-frequency section. The 381-mm (15-in.) DL15Sx-W weather-resistant woofer used is a specially designed unit featuring an extended-length voice coil and high-temperature construction materials. The system combines professional-quality components, arranged in an unusually durable Thiele-Small-aligned vented enclosure. The result is clear and articulate, high-quality sound.

Ring-Mode Decoupling (RMD™) Technology

The Sx500PI+ controls both acoustical and mechanical ring modes to provide dramatically increased intelligibility, using techniques learned from the development of the Electro-Voice X-Array™ concert speakers. There is much less coloration of the sound from resonating sources, leaving only the intended sound to be heard by the audience. The most obvious implementation of RMD™ in the Sx500PI+ is the foam attached to the back of the woofer grille.

Speaker Protection

The Sx500PI+ like all other vented systems experiences rapidly increasing cone excursion

Sx500PI+ 400-Watt Two-Way Weather-Resistant Speaker System

below the box-tuning frequency, while the acoustic output decreases rapidly. To ensure a long woofer life even when used at high power levels, it is recommended that some form of electronics be used to control unnecessary woofer cone excursion.

Graphic equalizers and active crossovers are two methods that can be used to prevent low-frequency signal below band-pass from going to the loudspeaker. When using an active crossover, a high-pass filter with a cutoff frequency of 32- to 45-Hz will provide the necessary protection. The filter should have a slope of at least 12 dB per octave. Such subpass band filters are found in many crossovers and equalizers manufactured by Electro-Voice, as well as other commercially available equipment.

Enclosure Construction

The Sx500PI+ enclosure is constructed of very durable structural foam that is hard to dent, scratch or break. The structural foam enclosure allows for the high- and low-frequency horns, the stand mount and the suspension points to be molded into the enclosure. It also allows for three handles to be integrated into the enclosure.

Frequency Response

The combination of a 15-inch woofer, wide-bandwidth high-frequency driver and an equalized crossover results in the wide and smooth overall response shown in Figures 1a and 1b. Figure 1a is the response with the ports open while Figure 1b is the response with the two optional port plugs installed. This response was measured at 3.05 meters (10 feet), using a 4-volt swept sine-wave input in an anechoic chamber using the internal passive crossover. No external equalization was used. Figures 1a and 1b have been averaged and corrected for 1 watt at 1 meter.

Port Plugs

The two ports, on either side of the high-frequency horn, may be "sealed" in order to add further weather protection to the system. These optional foam port plugs are included with the system for use in situations where increased weather resistance is needed. This will help prevent any moisture from wicking through the foam-backed grille and accumulating inside the enclosure under extreme weather conditions. The optional port plugs and instructions are supplied with each system. It should be noted, however, that once the port plugs are installed,

the frequency response will change to that shown in Figure 1b.

Connections and Biamping

The Sx500PI+ is equipped with two parallel Neutrik Speakon® NL4MP connectors. In the full-range mode, as supplied by the factory, pins 1+ and 1- are the inputs to the system.

Another system can be connected in parallel by using the other connector. Care must be taken not to abuse the amplifier by connecting impedances which are too low.

The user may put the system in biamp mode by removing the input panel and moving a connector from the full-range mode to biamp mode, as noted on the crossover. In biamp mode, 1+, 1- are the LF inputs and 2+, 2- are the HF inputs.

Constant-Directivity Speaker System

The crossover frequency and speaker- component geometries have been selected so that the directional characteristics of the woofer and constant-directivity high-frequency horn match at the crossover frequency to create a special system type — the constant-directivity system. At higher frequencies, the horizontal coverage pattern remains constant and the vertical pattern smoothly transitions to a 60° angle above 5,000 Hz. Response within the 75° x 60° rated coverage angle is uniform, which means dependable audience coverage without "hot spots" or dead zones at certain frequencies. The 75° x 60° dispersion characteristic also helps avoid early reflections from nearby floor or side-wall surfaces which could degrade performance. The controlled directivity of the high- and low-frequency transducers also eliminates response irregularities caused by diffraction off nearby enclosure edges and, in combination with an essentially flat on-axis frequency response, produces a total acoustic power output that is uniform with frequency.

Directivity

A unique feature of the Sx500PI+ is the constant-directivity dispersion provided by the 75° x 60° horn. The polar response of the system at selected one-third-octave bandwidths is shown in Figure 2. These polar responses were measured in an anechoic environment at 6.1 meters (20 feet) using one-third-octave pink-noise inputs. The frequencies selected are fully representative of the polar response of the system. Beamwidth of the system utilizing the complete one-third-octave polar data is shown

in Figure 3. Directivity factor, R , and directivity index, D_i , are plotted in Figure 4.

Power-Handling Capacity

The Sx500PI+ is shipped in full-range mode using an internal crossover. In biamp mode, the long-term average power-handling capacity is as follows:

Low Frequency: 400 watts

High Frequency: 60 watts

Electro-Voice components and systems are manufactured to exacting standards, ensuring they will hold up, not only through the most rigorous of power tests, but also through continued use in arduous, real-life conditions. The EIA Loudspeaker Power Rating Full Range (ANSI/EIA RS-426-A 1980) uses a noise spectrum which mimics typical music and tests the thermal and mechanical capabilities of the components. Electro-Voice will support relevant additional standards as and when they become available. Extreme, in-house power tests, which push the performance boundaries of the woofers, are also performed and passed to ensure years of trouble-free service.

Specifically, the Sx500PI+ passes ANSI/EIA RS-426-A 1980 with the following values:

$$R = 5.76 \text{ ohms } (1.15 \times (R_E + 1.86))$$

$$R_E = \text{woofer DCR}$$

$$1.86 = \text{horn-load impedance correction}$$

$$P_{E(\text{MAX})} = 400 \text{ watts}$$

$$\text{Test voltage} = 48.00 \text{ volts rms,}$$

$$96.00 \text{ volts peak (+6 dB)}$$

The "peak" power-handling capacity of a woofer is determined by the peak test-voltage amount. For the Sx500PI+, a 96.00-volt peak test-voltage translates into 1,600-watts short-term peak power-handling capacity. This is the equivalent of four times the "average" power-handling capacity, and is a peak that can be sustained for only a few milliseconds. However, this sort of short duration peak is very typical in speech and music. Provided the amplifier can reproduce the signal accurately without clipping, the woofer will also perform accurately and reliably, even at these levels.

Amplifier Power Recommendations

As noted in the Power-Handling Capacity section above, the Sx500PI+ has a random-noise power capacity of 400-watts long term (1,600- watts peak) per ANSI/EIA RS-426-A 1980. The following guidelines will help relate this to an appropriate power amplifier output rating.

Sx500PI+ 400-Watt Two-Way Weather-Resistant Speaker System

1. To use the Sx500PI+ to full capacity, skilled experts in sound-system installation and operation will obtain the best results if the power amplifier is 2.0 to 4.0 times the long-term average noise-power rating of the speaker system. For the Sx500PI+, this is 800 to 1,600 watts.

The caution cannot be made strongly enough, however, that this arrangement is only for experts or those who can discipline themselves against “pushing” the system for ever-higher sound levels and who can avoid “accidents” such as catastrophic feedback or dropped microphones.

2. A more conservative, “normal” amplifier size, which will produce audible results nearly equal to those of the “expert” recommendation, is 1.0 to 1.4 times the long-term average noise-power rating of the speaker. For the Sx500PI+, this is 400 to 640 watts.
3. To be very conservative, one can use an amplifier rated at 0.5 to 0.7 times the long-term average noise-power rating of the speaker. For the Sx500PI+, this is 200 to 280 watts.

Request P.A. Bible Addition No. Two (“Power Handling Capacity”) for more background on these recommendations.

Service

In the unlikely event the Sx500PI+ requires service, the woofer can be removed from the front. The high-frequency driver can be removed from the rear by first removing the input panel. A service data sheet is available from Electro-Voice.

Stand Mounting

When used on a stand, the stand must be placed on a stable surface. The stand must be rated to support systems of 38.6 kg (85 lb) or greater. It must have a base diameter of 1.22 m (4 ft) or greater. The bottom of the speaker should be no higher than 1.52 m (5 ft) from the bottom of the stand. The user must be sure that safe use on a stand is not affected by wind or any other conditions.

The Sx500PI+ can be mounted on the 100BK speaker stand or any other stand with a 1 3/8-inch diameter shaft.

Suspending Sx500PI+ Enclosures

WARNING: Suspending any object is

potentially dangerous and should be attempted only by individuals who have a thorough knowledge of the techniques and regulations of rigging objects overhead. Electro-Voice strongly recommends that the Sx500PI+ be suspended taking into account all current national, federal, state and local regulations. It is the responsibility of the installer to ensure the Sx500PI+ is safely installed in accordance with all such regulations. If the Sx500PI+ is suspended, Electro-Voice strongly recommends that the system be inspected at least once a year. If any sign of weakness or damage is detected, remedial action should be taken immediately.

The Sx500PI+ enclosure contains eight M8 x 1.25 inserts (see Figure 7) which are built into the enclosure for the purpose of suspension. Before the enclosure is suspended, these inserts are used to attach plates that hold the two halves of the enclosure together in addition to providing a way to suspend the enclosure.

The suspension kits that are available for the Sx500PI+ are listed below. Please refer to individual suspension-kit engineering data sheets for full details and safety information.

The first approach is to suspend **individual** Sx500PI+ enclosures. The Mb700 forged eyebolt attachment kit (see Figure 9) is an eyebolt suspension kit. It includes a top and bottom mounting plate to secure the two halves of the enclosure, in addition to the necessary hardware. Typically it will be necessary to attach two cables to the top eyebolts and to “pull-up” on the bottom plate. The Mb500 wall/ceiling mounting bracket (see Figure 8) encompasses the top and bottom of the enclosure with a bracket attached to the two plates to secure the halves of the enclosure. Additionally, it has features to make suspending the Sx500PI+ easier and more flexible. Electro-Voice recommends the use of the Mb500 in all but the simplest situations. The Mb500 has supplementary holes to allow the Sx500PI+ to be attached to a wall or ceiling and aimed at an audience.

The second approach is to suspend **multiple** Sx500PI+ enclosures. The Sx500PI+ enclosure is not designed to suspend multiple enclosures from itself. If an “array” is required, then multiple Mb500’s must be used. Arrays may be constructed vertically by “daisy chaining” two Mb500’s from each other. The Mb600 horizontal array kit allows the easy and secure construction of horizontal arrays, using Mb500’s

to support the enclosure.

Weather-Resistant Mounting

When mounting the Sx500PI+ in a location where a weather-resistant system is required, a minimum of a five-degree down angle is recommended. (See Figure 10.) This will help prevent any moisture from wicking through the foam and mesh-backed grille and accumulating inside the enclosure under extreme weather conditions.

Architects’ and Engineers’ Specifications

The loudspeaker shall be a compact vented-box type. The low frequencies shall be reproduced with one horn-loaded DL15Sx-W 381-mm (15-in.) woofer. The high frequencies shall be reproduced by a DH2T, high-frequency compression driver with a pure-titanium diaphragm, coupled to a 75° x 60° constant-directivity horn molded into the front baffle of the enclosure. The system will use a passive crossover-equalizer network with protection for the high-frequency driver. The loudspeaker shall meet the following performance criteria: frequency response of 66-16,000 Hz, -3 dB; power handling of 400-watts long term and 1,600-watts short term, with a shaped random-noise input per ANSI/EIA RS-426-A 1980; sensitivity of 100-dB SPL at 1 meter with a 1-watt, 300-2,000-Hz pink-noise input; 6dB-down horizontal coverage angle of 75° + 14° / - 20° in the 2,000- to 16,000-Hz range; 6dB-down vertical coverage angle of 60° + 11° / - 8° in the 2,000- to 16,000-Hz range; crossover frequency of 1,600 Hz; nominal impedance of 8 ohms and minimum impedance of 5.2 ohms in full-range mode. Paralleled input and output connectors shall be present, consisting of Neutrik Speakon® NL4MP connectors. The enclosure shall be constructed of polypropylene structural foam and fitted with a powder-coated full-face stainless-steel grille with foam backing and a polyester mesh water shield, three integral handles, a stand socket for mounting on 1 3/8 -inch stands, rubber feet and mating sockets to facilitate stacking. Dimensions shall be 838 mm (33 in.) high x 673 mm (26.5 in.) wide x 448 mm (17.63 in.) deep. Net weight shall be 32.9 kg (72.5 lb).

The system shall be capable of producing average sound levels in excess of 126 dB in the long term, and short-term peaks of 132 dB.

The loudspeaker system shall be the Electro-Voice Sx500PI+.

Sx500PI + 400-Watt Two-Way Weather-Resistant Speaker System

Uniform Limited Warranty

Electro-Voice products are guaranteed against malfunction due to defects in materials or workmanship for a specified period, as noted in the individual product-line statement(s) below, or in the individual product data sheet or owner's manual, beginning with the date of original purchase. If such malfunction occurs during the specified period, the product will be repaired or replaced (at our option) without charge. The product will be returned to the customer prepaid. **Exclusions and Limitations:** The Limited Warranty does not apply to: (a) exterior finish or appearance; (b) certain specific items described in the individual product-line statement(s) below, or in the individual product data sheet or owner's manual; (c) malfunction resulting from use or operation of the product other than as specified in the product data sheet or owner's manual; (d) malfunction resulting from misuse or abuse of the product; or (e) malfunction occurring at any time after repairs have been made to the product by anyone other than Electro-Voice Service or any of its authorized service representatives.

Obtaining Warranty Service: To obtain warranty service, a customer must deliver the product, prepaid, to Electro-Voice Service or any of its authorized service representatives together with proof of purchase of the product in the form of a bill of sale or receipted invoice. A list of authorized service representatives is available from Electro-Voice Service at 600 Cecil Street, Buchanan, MI 49107 (800/234-6831 or FAX 616/695-4743). **Incidental and Consequential Damages Excluded:** Product repair or replacement and return to the customer are the only remedies provided to the customer. Electro-Voice shall not be liable for any incidental or consequential damages including, without limitation, injury to persons or property or loss of use. Some states do not allow the exclusion or limitation of incidental or consequential damages so the above limitation or exclusion may not apply to you. **Other Rights:** This warranty gives you specific legal rights, and you may also have other rights which vary from state to state.

Electro-Voice Speakers and Speaker Systems are guaranteed against malfunction due to defects in materials or workmanship for a

period of five (5) years from the date of original purchase. The Limited Warranty does not apply to burned voice coils or malfunctions such as cone and/or coil damage resulting from improperly designed enclosures. Electro-Voice active electronics associated with the speaker systems are guaranteed for three (3) years from the date of original purchase. Additional details are included in the Uniform Limited Warranty statement.

For warranty repair, service information, or a listing of the repair facilities nearest you, contact the service repair department at: 616/695-6831 or 800/685-2606.

For technical assistance, contact Technical Support at 800/234-6831 or 616/695-6831, M-F, 8:00 a.m. to 5:00 p.m. Eastern Standard time.

Specifications subject to change without notice.

Sx500PI+ 400-Watt Two-Way Weather-Resistant Speaker System

Figure 1a—SX500PI+ Axial Frequency Response, (anechoic environment, 4 volts/3.05 meters (10 feet), normalized to 1 watt/1 meter) (open ports)

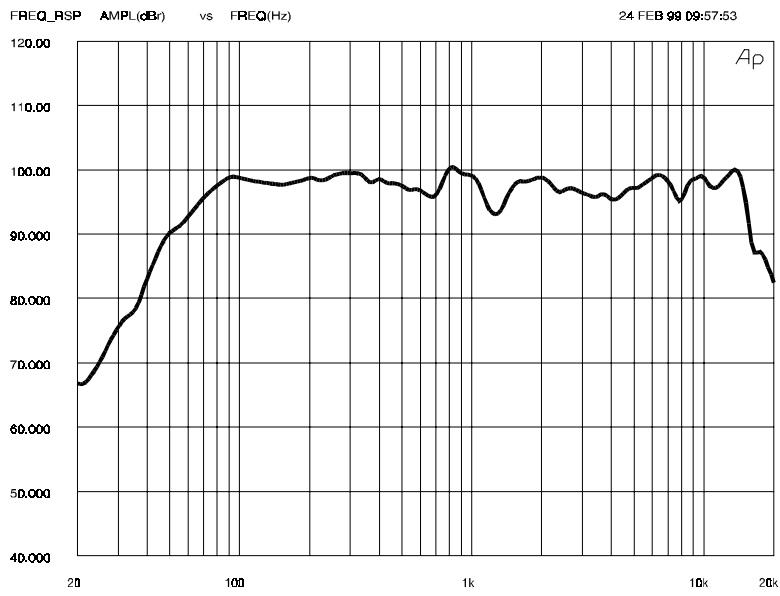
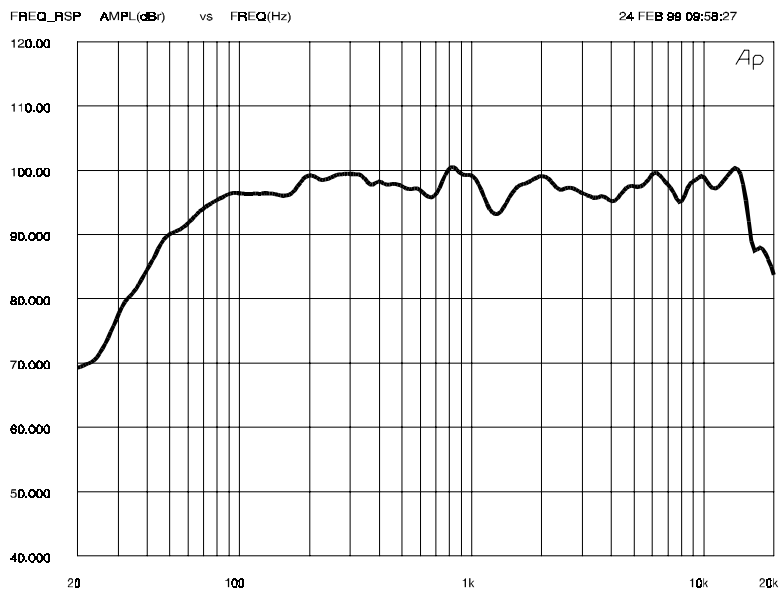

Figure 1b—Sx500PI+ Axial Frequency Response, (anechoic environment, 4 volts/3.05 meters (10 feet), normalized to 1 watt/1 meter) (closed ports)



Sx500PI+ 400-Watt Two-Way Weather-Resistant Speaker System

Sx500PI + 400-Watt Two-Way Weather-Resistant Speaker System

Sx500PI + 400-Watt Two-Way Weather-Resistant Speaker System

Figure 2 — Sx500PI+ One-Third-Octave Polar Responses (anechoic environment, 4 volts/6.10 meters (20 feet))

— HORIZONTAL
 - - - VERTICAL
 5 dB per Division

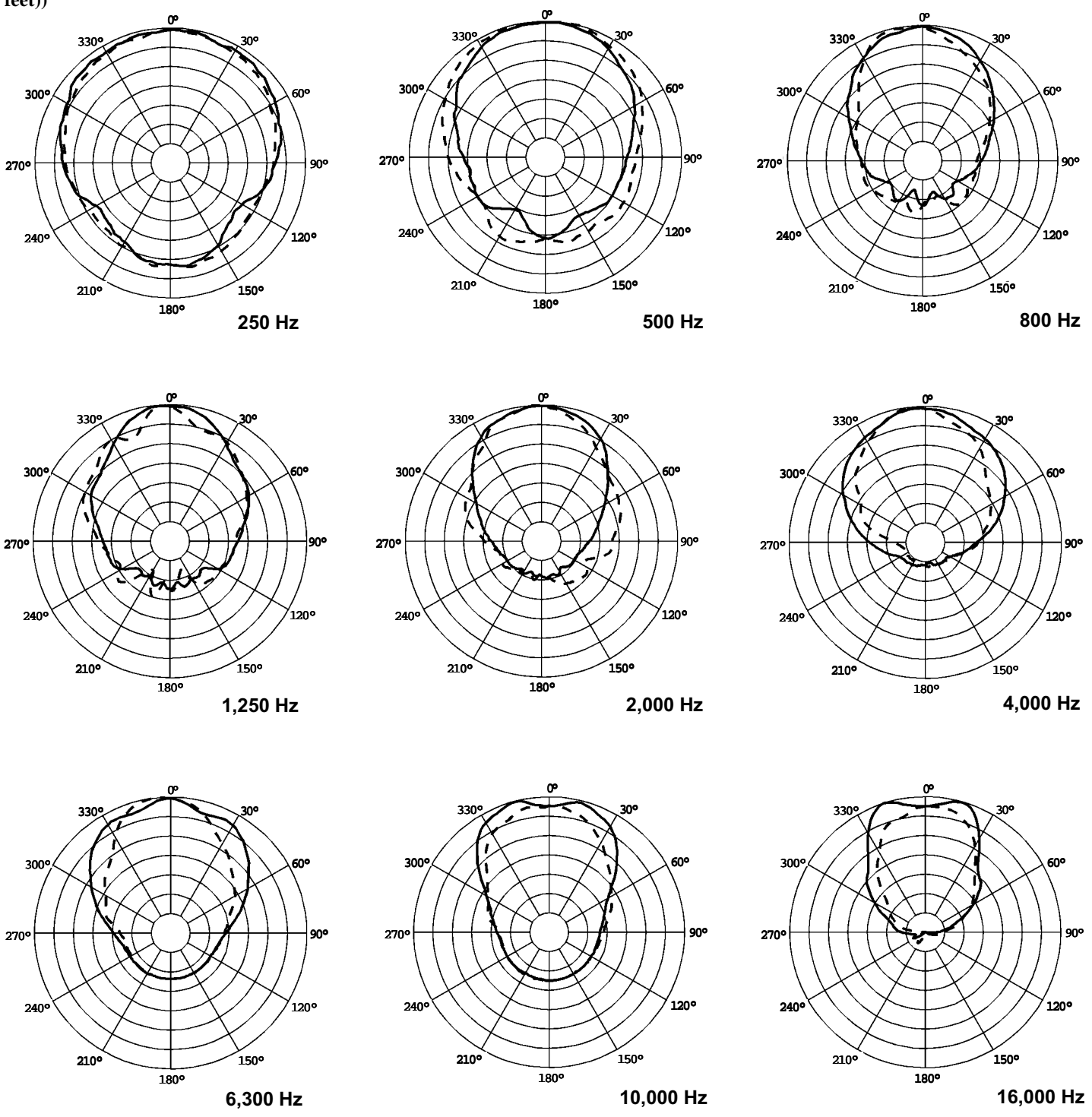

Sx500PI+ 400-Watt Two-Way Weather-Resistant Speaker System

Sx500PI+ 400-Watt Two-Way Weather-Resistant Speaker System

Figure 3 — Sx500PI+ Beamwidth vs. Frequency (anechoic environment)

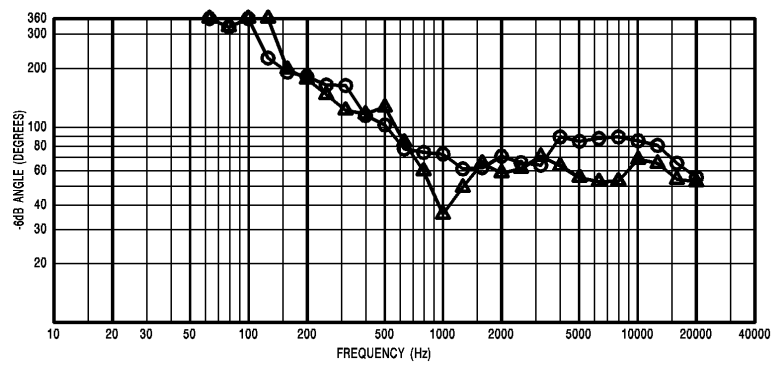

Figure 4 — Sx500PI+ Directivity vs. Frequency (anechoic environment)

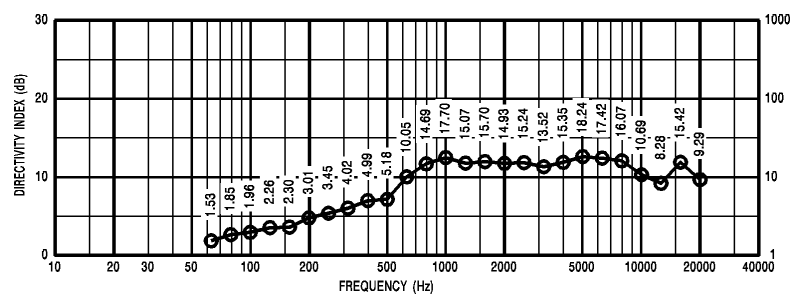
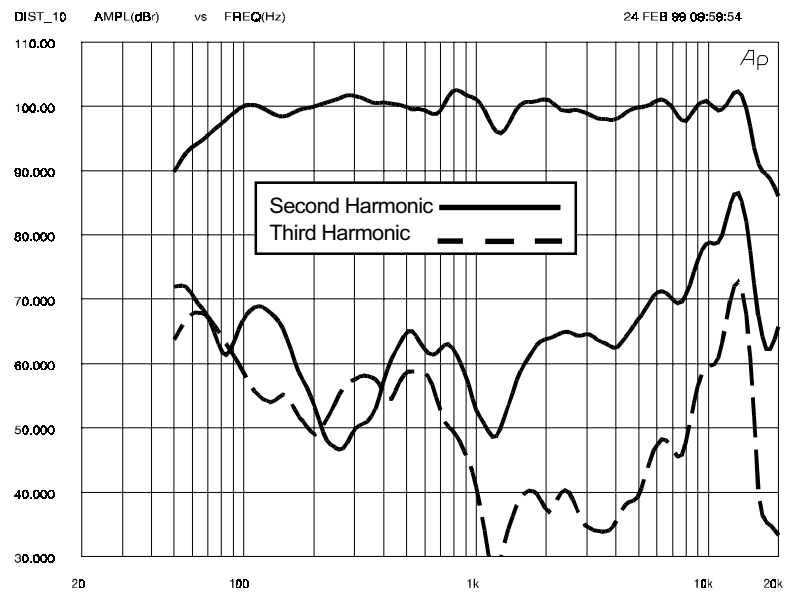

Figure 5 — Sx500PI+ Harmonic Distortion Response 10% Rated Power Input (40 watts), (anechoic environment, 3.05 meters (10 feet), on axis)



Sx500PI + 400-Watt Two-Way Weather-Resistant Speaker System

Sx500PI + 400-Watt Two-Way Weather-Resistant Speaker System

Figure 6a — Sx500PI+ Full-Range Impedance Curve (open ports)

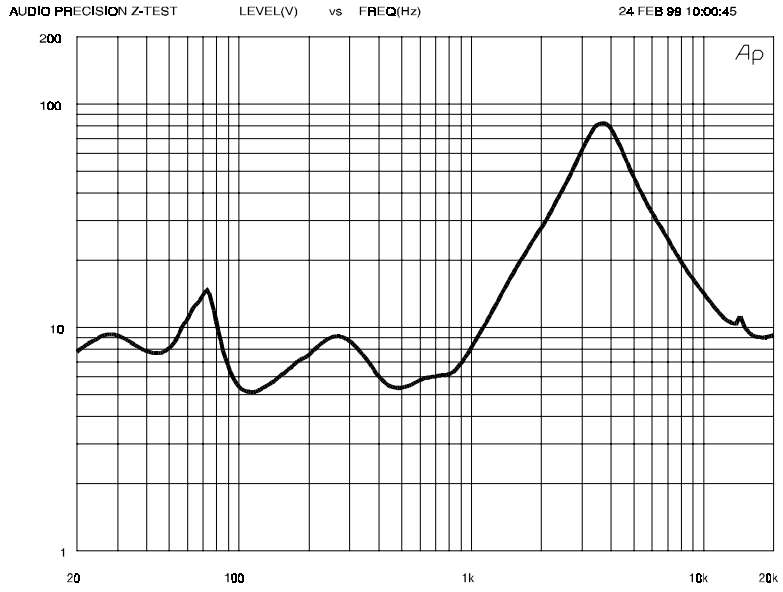
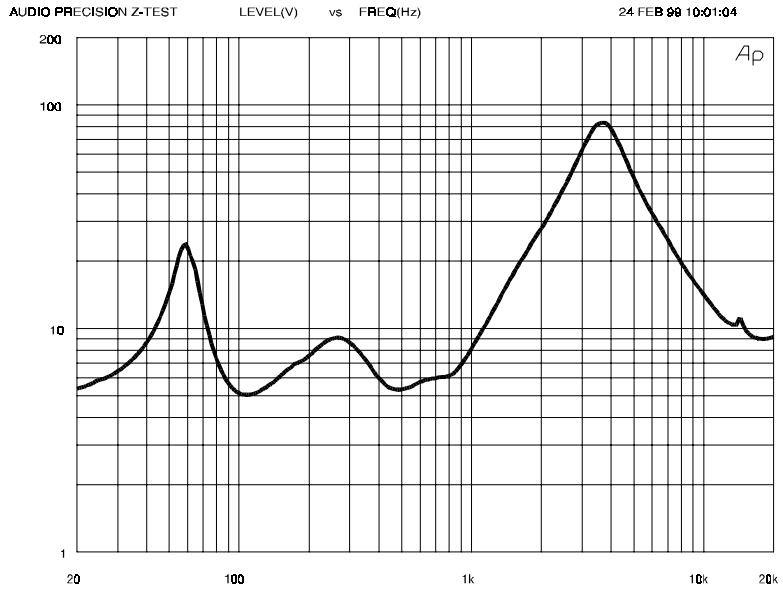
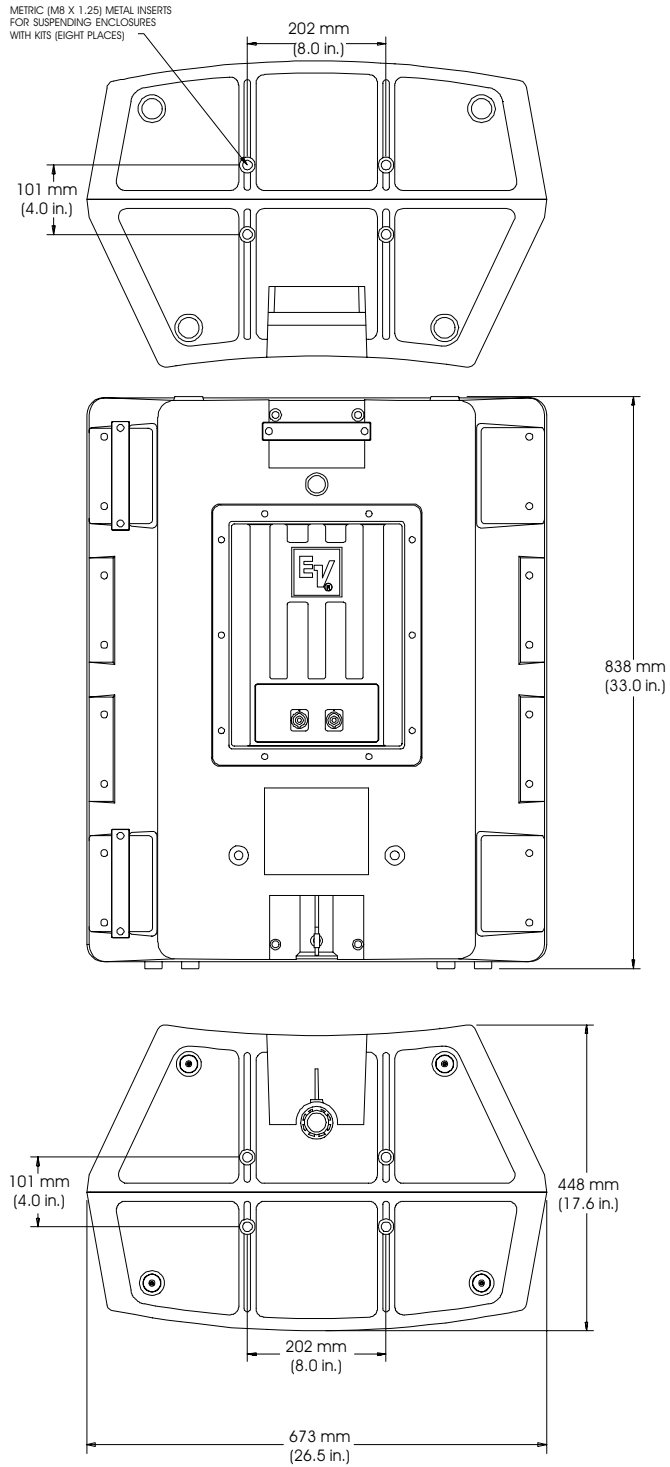

Figure 6b — Sx500PI+ Full-Range Impedance Curve (closed ports)



Sx500PI+ 400-Watt Two-Way Weather-Resistant Speaker System

Figure 7 — Sx500PI+ Dimension Line Drawing



Sx500PI+ 400-Watt Two-Way Weather-Resistant Speaker System

Sx500PI + 400-Watt Two-Way Weather-Resistant Speaker System

Sx500PI + 400-Watt Two-Way Weather-Resistant Speaker System

Figure 8 — Sx500PI+ enclosure with Mb500 kit

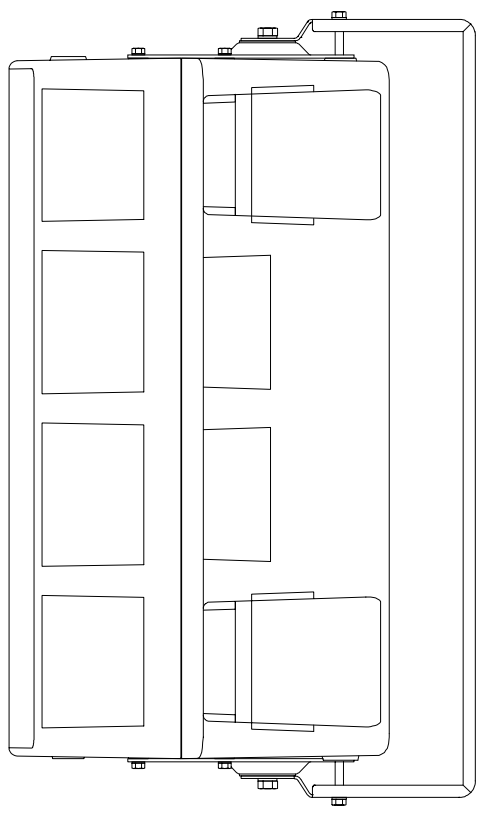

Figure 9 — Sx500PI+ enclosure with Mb700 kit

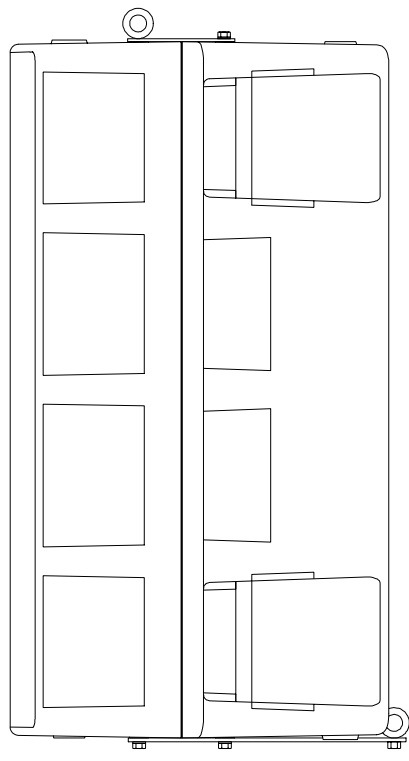
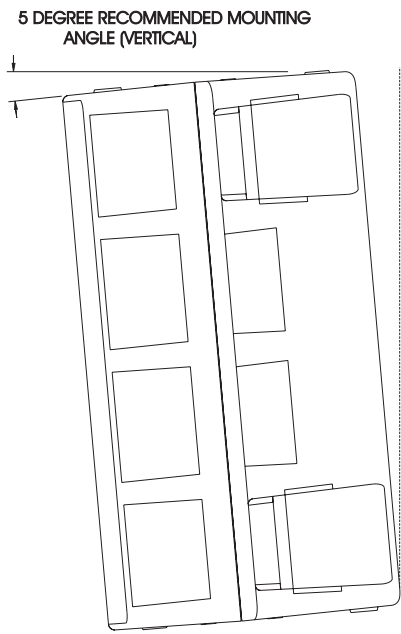
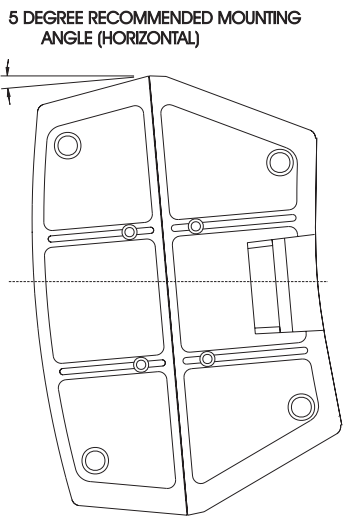

Figure 10 — Sx500PI+ Recommended mounting angle



Sx500PI + 400-Watt Two-Way Weather-Resistant Speaker System

Specifications

Typical Axial Frequency Response, Swept Sine Wave, 4 volts at 3.05 meters (10 feet), (anechoic environment, normalized for 1 watt at 1 meter; see Figure 1a and 1b):

66-16,000 Hz (open port)

73-16,000 Hz (closed port)

Low-Frequency (3-dB-Down Point):

66 Hz (open port)

73 Hz (closed port)

Usable Low-Frequency Limit (10-dB-down point):

45 Hz (open and closed port)

Half Space Reference Efficiency:

4.4%

Long-Term Average Power-Handling Capacity per EIA Standard RS-426-A 1980 (see Power-Handling Capacity section):

400 watts

Maximum Woofer Acoustic Output:

17.6 watts

Sensitivity (SPL at 1 watt, 1 meter input, anechoic environment, swept sine wave):

100 dB

Nominal Coverage Angle,

Horizontal: 75°

Vertical: 60°

Dispersion Angle Included by 6-dB-Down Points on Polar Responses, Indicated One-Third-Octave Bands of Pink Noise (see Figure 3),

2,000-20,000 Hz, Horizontal:

75° (+14°, -20°)

2,000-20,000 Hz, Vertical:

60° (+11°, -8°)

Directivity Factor R_0 (Q), 800- to 16,000-Hz Median (see Figure 4):

11.8 (+0.8, -2.6)

Directivity Index D_1 , 800- to 16,000-Hz Median (see Figure 4):

15.2 dB (+3.0 dB, -6.9 dB)

Distortion, 0.1 Full Power Input (see Figure 5), Second Harmonic,

100 Hz:

-33 dB, 2.2%

1,000 Hz:

-48 dB, .4%

10,000 Hz:

-22 dB, 8.4%

Third Harmonic,

100 Hz:

-41 dB, .9%

1,000 Hz:

-60 dB, .1%

10,000 Hz:

-41 dB, .9%

Transducer Complement,

Low Frequency:

DL15Sx-W weather-resistant woofer

High Frequency:

DH2010A driver

Box Tuning Frequency:

44 Hz (open port)

Crossover specifications, Full-range mode,

Crossover Frequency:

1,600 Hz

Crossover Slope,

Low Pass:

18 dB per octave

High Pass:

12 dB per octave

Biamp Mode,

Recommended Crossover Frequency:

1,600 Hz

Crossover Slopes,

Recommended:

24 dB per octave

Minimum:

18 dB per octave

Impedance, Full-Range Mode,

Nominal:

8 ohms

Minimum:

5.2 ohms

Biamp Mode,

Nominal (low frequency/high frequency):

8 ohms/8 ohms

Minimum (low frequency/high frequency):

4.9 ohms/7.9 ohms

Input Connections,

Two parallel Neutrik Speakon® NL4MP connectors with the following pin arrangements,

Full-Range Mode:

1- = IN (-)

1+ = IN (+)

2- = Not Used

2+ = Not Used

Biamp Mode:

1- = LF (-)

1+ = LF (+)

2- = HF (-)

2+ = HF (+)

Driver Protection, High Frequency:

Solid-state self-resetting circuit (PRO™ circuit) drops output 6 dB; blocking capacitor with 800-Hz corner frequency and 6-dB-per-octave slope

Enclosure Materials and Colors:

Polypropylene structural foam; black Black powder-coated stainless-steel perforated metal grille with foam backing and a polyester water shield

Dimensions (see Figure 7),

Height:

838 mm (33.0 in.)

Width:

673 mm (26.5 in.)

Depth:

448 mm (17.63 in.)

Net Weight:

32.9 kg (72.5 lb)

Shipping Weight:

37.0 kg (81.5 lb)

Included Accessory:

Foam port plugs for increased water-resistance

Optional Accessories:

100BK mounting stand
Mb500 installation kit
Mb600 horizontal array kit
Mb700 eyebolt attachment kit
VPC500 protective cover
PD500 padded protective case

Attachment Points:

Eight metric inserts (M8 x 1.25) (see Figure 7 and Suspending Sx500 Enclosures section)

Sx500PI + 400-Watt Two-Way Weather-Resistant Speaker System

Sx500PI + 400-Watt Two-Way Weather-Resistant Speaker System

Electro-Voice®

600 Cecil Street, Buchanan, MI 49107

616/695-6831, 616/695-1304 Fax