

# Panasonic®

## Operating Instructions Manual de instrucciones

# High Definition Plasma Display Pantalla de Plasma de Alta Definición

Model No. **TH-37PH10UK**  
Número de modelo. **TH-42PH10UK**  
**TH-50PH10UK**  
**TH-58PH10UK**



The illustration shown is an image.  
Before connecting, operating or adjusting this product, please read these instructions completely.  
Please keep this manual for future reference.

La ilustración mostrada es una imagen.  
Antes de conectar, utilizar o ajustar este producto, lea completamente este manual de instrucciones;  
y guárdelo para consultarlo en el futuro en caso de ser necesario.

**English**

**Español**

	<b>CAUTION</b> <b>RISK OF ELECTRIC SHOCK</b> <b>DO NOT OPEN</b>	
<b>WARNING: To reduce the risk of electric shock, do not remove cover or back. No user-serviceable parts inside. Refer servicing to qualified service personnel.</b>		



The lightning flash with arrow-head within a triangle is intended to tell the user that parts inside the product are a risk of electric shock to persons.



The exclamation point within a triangle is intended to tell the user that important operating and servicing instructions are in the papers with the appliance.

**WARNING :** To prevent damage which may result in fire or shock hazard, do not expose this apparatus to rain or moisture.  
**Do not place containers with water (flower vase, cups, cosmetics, etc.) above the set. (including on shelves above, etc.)**

**WARNING :** 1) To prevent electric shock, do not remove cover. No user serviceable parts inside. Refer servicing to qualified service personnel.  
2) Do not remove the grounding pin on the power plug. This apparatus is equipped with a three pin grounding-type power plug. This plug will only fit a grounding-type power outlet. This is a safety feature. If you are unable to insert the plug into the outlet, contact an electrician.  
Do not defeat the purpose of the grounding plug.



# Important Safety Instructions

- 1) Read these instructions.
- 2) Keep these instructions.
- 3) Heed all warnings.
- 4) Follow all instructions.
- 5) Do not use this apparatus near water.
- 6) Clean only with dry cloth.
- 7) Do not block any ventilation openings. Install in accordance with the manufacturer's instructions.
- 8) Do not install near any heat sources such as radiators, heat registers, stoves, or other apparatus (including amplifiers) that produce heat.
- 9) Do not defeat the safety purpose of the polarized or grounding-type plug. A polarized plug has two blades with one wider than the other. A grounding type plug has two blades and a third grounding prong. The wide blade or the third prong are provided for your safety. If the provided plug does not fit into your outlet, consult an electrician for replacement of the obsolete outlet.
- 10) Protect the power cord from being walked on or pinched particularly at plugs, convenience receptacles, and the point where they exit from the apparatus.
- 11) Only use attachments / accessories specified by the manufacturer.
- 12) Use only with the cart, stand, tripod, bracket, or table specified by the manufacturer, or sold with the apparatus. When a cart is used, use caution when moving the cart / apparatus combination to avoid injury from tip-over.
- 13) Unplug this apparatus during lightning storms or when unused for long periods of time.
- 14) Refer all servicing to qualified service personnel. Servicing is required when the apparatus has been damaged in any way, such as power-supply cord or plug is damaged, liquid has been spilled or objects have fallen into the apparatus, the apparatus has been exposed to rain or moisture, does not operate normally, or has been dropped.
- 15) To prevent electric shock, ensure the grounding pin on the AC cord power plug is securely connected.



# Dear Panasonic Customer

Welcome to the Panasonic family of customers. We hope that you will have many years of enjoyment from your new Plasma Display.

To obtain maximum benefit from your set, please read these Instructions before making any adjustments, and retain them for future reference.

Retain your purchase receipt as well, and record the model number and serial number of your set in the space provided on the rear cover of these instructions.

## Table of Contents

<b>Important Safety Instructions</b> .....	<b>3</b>	<b>SCREENSAVER (For preventing image retention) ..</b>	<b>29</b>
<b>FCC STATEMENT</b> .....	<b>5</b>	Setup of SCREENSAVER Time .....	30
<b>Safety Precautions</b> .....	<b>6</b>	Reduces screen image retention.....	30
<b>Maintenance</b> .....	<b>7</b>	SIDE BAR ADJUST .....	31
<b>Accessories</b> .....	<b>8</b>	<b>Reduces power consumption .....</b>	<b>32</b>
Accessories Supplied .....	8	Customizing the Input labels .....	32
Remote Control Batteries .....	8	<b>SET UP for MULTI DISPLAY .....</b>	<b>33</b>
<b>Connections</b> .....	<b>9</b>	How to setup MULTI DISPLAY .....	33
PC Input Terminals connection.....	10	How to set the Display location number	
SERIAL Terminals connection .....	11	for each Plasma Display .....	33
AV & COMPONENT / RGB connection .....	12	SEAM HIDES VIDEO Setting .....	35
RGB signal (R, G, B) .....	12	ID Remote Control Function.....	35
<b>Power ON / OFF</b> .....	<b>13</b>	<b>SET UP for Input Signals .....</b>	<b>36</b>
<b>Basic Controls</b> .....	<b>14</b>	COMPONENT / RGB IN SELECT.....	36
<b>On-Screen Menu Displays</b> .....	<b>16</b>	3D Y/C FILTER.....	36
<b>Initial selections</b> .....	<b>18</b>	COLOR SYSTEM / Panasonic AUTO .....	37
Selecting the input signal .....	18	3:2 PULLDOWN / VIDEO NR.....	37
Selecting the On-Screen Menu Language .....	18	SYNC .....	38
<b>ASPECT Controls</b> .....	<b>19</b>	REFRESH RATE .....	38
<b>Adjusting POS. /SIZE</b> .....	<b>20</b>	H-FREQ. (kHz) / V-FREQ. (Hz).....	38
<b>MULTI PIP</b> .....	<b>21</b>	<b>Options Adjustments .....</b>	<b>39</b>
<b>Advanced PIP</b> .....	<b>22</b>	Weekly Command Timer .....	43
<b>PICTURE Adjustments</b> .....	<b>23</b>	<b>Shipping condition</b> .....	<b>45</b>
ADVANCED SETTINGS.....	24	<b>Troubleshooting</b> .....	<b>46</b>
<b>SOUND Adjustment</b> .....	<b>25</b>	<b>VIDEO/COMPONENT/RGB/PC input signals</b> .....	<b>47</b>
MUTE .....	25	<b>Command list of Weekly Command Timer</b> .....	<b>48</b>
<b>Digital Zoom</b> .....	<b>26</b>	<b>Specifications</b> .....	<b>49</b>
<b>PRESENT TIME SETUP / SET UP TIMER</b> .....	<b>27</b>	<b>PANASONIC PLASMA SCREEN Limited Warranty</b> ...	<b>51</b>
PRESENT TIME SETUP .....	27	<b>LIMITED WARRANTY STATEMENT</b> .....	<b>52</b>
SET UP TIMER .....	28		

# FCC STATEMENT

This equipment has been tested and found to comply with the limits for a Class B digital device, pursuant to Part 15 of the FCC Rules. These limits are designed to provide reasonable protection against harmful interference in a residential installation. This equipment generates, uses and can radiate radio frequency energy and, if not installed and used in accordance with the instructions, may cause harmful interference to radio communications. However, there is no guarantee that interference will not occur in a particular installation. If this equipment does cause harmful interference to radio or television reception, which can be determined by turning the equipment off and on, the user is encouraged to try to correct the interference by one or more of the following measures:

- Reorient or relocate the receiving antenna.
- Increase the separation between the equipment and receiver.
- Connect the equipment into an outlet on a circuit different from that to which the receiver is connected.
- Consult the dealer or an experienced technician for help.

This device complies with Part 15 of the FCC Rules. Operation is subject to the following two conditions: (1) This device may not cause harmful interference, and (2) this device must accept any interference received, including interference that may cause undesired operation.

## **FCC CAUTION:**

**To assure continued compliance, use only shielded interface cables when connecting to computer or peripheral devices. Any changes or modifications not expressly approved by Panasonic Corporation of North America could cause harmful interference and would void the user's authority to operate this device.**

### FCC Declaration of Conformity

Model No. TH-37PH10UK, TH-42PH10UK, TH-50PH10UK, TH-58PH10UK

Responsible Party: Panasonic Corporation of North America  
One Panasonic Way, Secaucus, NJ 07094  
Contact Source: Panasonic Broadcast & Television Systems Company  
1-800-524-1448  
email: [pbtscservice@us.panasonic.com](mailto:pbtscservice@us.panasonic.com)

## **CANADIAN NOTICE:**

This Class B digital apparatus complies with Canadian ICES-003.

## **Note:**

Do not allow a still picture to be displayed for an extended period, as this can cause permanent image retention to remain on the Plasma Display.

Examples of still pictures include logos, video games, computer images, teletext and images displayed in NORMAL mode.

## **Trademark Credits**

- VGA is a trademark of International Business Machines Corporation.
- Macintosh is a registered trademark of Apple Computer, USA.
- S-VGA is a registered trademark of the Video Electronics Standard Association.

Even if no special notation has been made of company or product trademarks, these trademarks have been fully respected.

# Safety Precautions



## CAUTION

**This Plasma Display is for use only with the following optional accessories. Use with any other type of optional accessories may cause instability which could result in the possibility of injury.**

(All of the following accessories are manufactured by Matsushita Electric Industrial Co., Ltd.)

- Speakers ..... TY-SP37P8W-K\*1, TY-SP42P8W-K\*2, TY-SP50P8W-K\*3, TY-SP58P10WK\*4
- Pedestal ..... TY-ST07-K\*5, TY-ST08-K\*5, TY-ST58-K\*4
- Mobile stand ..... TY-ST42PF3\*6, TY-ST58PF10
- Wall-hanging bracket (vertical) ..... TY-WK37PV3\*1, TY-WK42PV7
- Wall-hanging bracket (angled) ..... TY-WK42PR7
- Wall-hanging bracket (drawer type) ..... TY-WK42DR1\*6
- Ceiling-hanging bracket ..... TY-CE42PS7\*5
- BNC Component Video Terminal Board... TY-42TM6A
- BNC Composite Video Terminal Board .... TY-42TM6B
- BNC Dual Video Terminal Board ..... TY-FB9BD
- RCA Component Video Terminal Board ... TY-42TM6Z
- RCA Composite Video Terminal Board .... TY-42TM6V
- RGB (Digital) Terminal Board ..... TY-42TM6D
- RGB Active Through Terminal Board ..... TY-42TM6G
- PC Input Terminal Board ..... TY-42TM6P
- Composite / Component Video Terminal Board .. TY-42TM6Y
- SDI Terminal Board ..... TY-FB7SD
- HD-SDI Terminal Board ..... TY-FB9HD
- HDMI Terminal Board ..... TY-FB8HM
- Touch Panel ..... TY-TP42P8-S\*2, TY-TP42P10S\*2,  
TY-TP50P8-S\*3, TY-TP50P10S\*3, TY-TP58P10S\*4
- Ir Through Terminal Board ..... TY-FB9RT
- Wireless Presentation Board ..... TY-FB10WPU
- AV Terminal Box ..... TY-TB10AV
- Anti glare filter ..... TY-AR50P9W\*3, TY-AR42P9W\*2, TY-AR58P10W\*4

\*1 For TH-37PH10UK

\*2 For TH-42PH10UK

\*3 For TH-50PH10UK

\*4 For TH-58PH10UK

\*5 For TH-37PH10UK, TH-42PH10UK, TH-50PH10UK

\*6 For TH-42PH10UK, TH-50PH10UK

Always be sure to ask a qualified technician to carry out set-up.

Small parts can present choking hazard if accidentally swallowed. Keep small parts away from young children. Discard unneeded small parts and other objects, including packaging materials and plastic bags/sheets to prevent them from being played with by young children, creating the potential risk of suffocation.

### ■ When using the Plasma Display

**Do not bring your hands, face or objects close to the ventilation holes of the Plasma Display.**

- Top of the Plasma Display is usually very hot due to the high temperature of exhaust air being released through the ventilation holes. Burns or personal injuries can happen if any body parts are brought too close. Placing any object near the top of the display could also result in heat damages to the object as well as to the Display if its ventilation holes are blocked.

**Be sure to disconnect all cables before moving the Plasma Display.**

- Moving the Display with its cables attached might damage the cables which, in turn, can cause fire or electric shock.

**Disconnect the power plug from the wall outlet as a safety precaution before carrying out any cleaning.**

- Electric shocks can result if this is not done.

**Clean the power cable regularly to prevent it from becoming dusty.**

- Built-up dust on the power cord plug can increase humidity which might damage the insulation and cause fire. Unplug the cord from the wall outlet and clean it with a dry cloth.

**This Plasma Display radiates infrared rays, therefore it may affect other infrared communication equipment. Install your infrared sensor in a place away from direct or reflected light from your Plasma Display.**

**Note:**

Do not allow a still picture to be displayed for an extended period, as this can cause a permanent image retention to remain on the Plasma Display.

Examples of still pictures include logos, video games, computer images, teletext and images displayed in NORMAL mode.

### WARNING

#### ■ Setup

**Do not place the Plasma Display on sloped or unstable surfaces.**

- The Plasma Display may fall off or tip over.

**Do not place any objects on top of the Plasma Display.**

- If water spills onto the Plasma Display or foreign objects get inside it, a short-circuit may occur which could result in fire or electric shock. If any foreign objects get inside the Plasma Display, please consult an Authorized Service Center.

**Do not cover the ventilation holes.**

- Doing so may cause the Plasma Display to overheat, which can cause fire or damage to the Plasma Display.

**Transport only in upright position!**

- Transporting the unit with its display panel facing upright or downward may cause damage to the internal circuitry.

**If using the pedestal (optional accessory), leave a space of 3 15/16" (10 cm) or more at the top, left and right, 2 3/8" (6 cm) or more at the bottom, and 2 3/4" (7 cm) or more at the rear. If using some other setting-up method, leave a space of 3 15/16" (10 cm) or more at the top, bottom, left and right, and 2 3/4" (7 cm) or more at the rear.**

#### ■ AC Power Supply Cord

**The Plasma Display is designed to operate on 120 V AC, 50/60 Hz.**

**Do not use any power supply cord other than that provided with this unit.**

- Doing so may cause fire or electric shocks.

**Securely insert the power cord plug as far as it will go.**

- If the plug is not fully inserted, heat may be generated which could cause fire. If the plug is damaged or the wall socket plate is loose, they should not be used.

**Do not handle the power cord plug with wet hands.**

- Doing so may cause electric shocks.

**Do not do anything that might damage the power cable. When disconnecting the power cable, hold the plug, not the cable.**

- Do not make any modifications, place heavy objects on, place near hot objects, heat, bend, twist or forcefully pull the power cable. Doing so may cause damage to the power cable which can cause fire or electric shock. If damage to the cable is suspected, have it repaired at an Authorized Service Center.

**If the Plasma Display will not be used for a long period of time, unplug the power cord from the wall outlet.**

#### ■ If problems occur during use

**If a problem occurs (such as no picture or no sound), or if smoke or an abnormal odor is detected from the Plasma Display, unplug the power cord immediately.**

- Continuous use of the Display under these conditions might cause fire or permanent damage to the unit. Have the Display evaluated at an Authorized Service Center. Services to the Display by any unauthorized personnel are strongly discouraged due to its high voltage dangerous nature.

**If water or foreign objects get inside the Plasma Display, if the Plasma Display is dropped, or if the cabinet becomes damaged, disconnect the power cord plug immediately.**

- A short may occur, which could cause fire. Contact an Authorized Service Center for any repairs that need to be made.

## Maintenance

**The front of the display panel has been specially treated. Wipe the panel surface gently using only a cleaning cloth or a soft, lint-free cloth.**

- If the surface is particularly dirty, wipe with a soft, lint-free cloth which has been soaked in pure water or water in which neutral detergent has been diluted 100 times, and then wipe it evenly with a dry cloth of the same type until the surface is dry.
- Do not scratch or hit the surface of the panel with fingernails or other hard objects, otherwise the surface may become damaged. Furthermore, avoid contact with volatile substances such as insect sprays, solvents and thinner, otherwise the quality of the surface may be adversely affected.

**If the cabinet becomes dirty, wipe it with a soft, dry cloth.**

- If the cabinet is particularly dirty, soak the cloth in water to which a small amount of neutral detergent has been added and then wring the cloth dry. Use this cloth to wipe the cabinet, and then wipe it dry with a dry cloth.
- Do not allow any detergent to come into direct contact with the surface of the Plasma Display. If water droplets get inside the unit, operating problems may result.
- Avoid contact with volatile substances such as insect sprays, solvents and thinner, otherwise the quality of the cabinet surface may be adversely affected or the coating may peel off. Furthermore, do not leave it for long periods in contact with articles made from rubber or PVC.

# Accessories

## Accessories Supplied

Check that you have the Accessories and items shown

Operating Instruction book

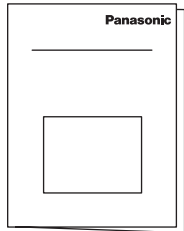

Remote Control Transmitter EUR7636070R



Batteries for the Remote Control Transmitter (2 × AA Size)

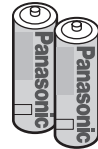

Fixing bands × 2

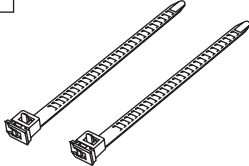

AC cord

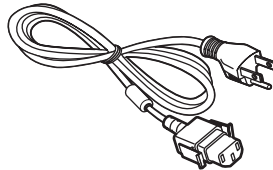

## Remote Control Batteries

Requires two AA batteries.

1. Pull and hold the hook, then open the battery cover.

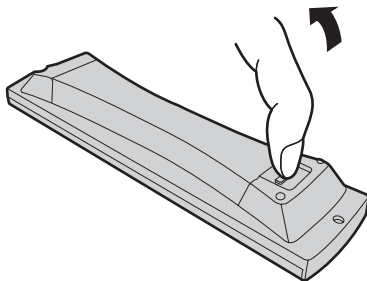

2. Insert batteries - note correct polarity (+ and -).

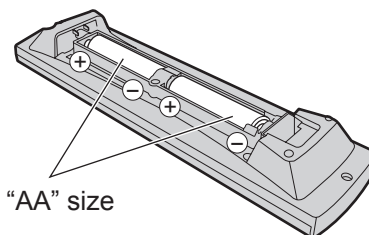

3. Replace the cover.

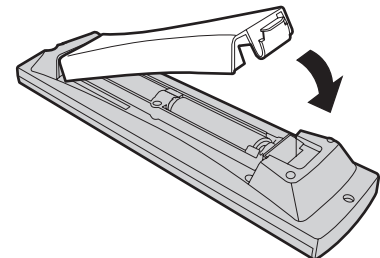

### Helpful Hint:

For frequent remote control users, replace old batteries with Alkaline batteries for longer life.

### Precaution on battery use

Incorrect installation can cause battery leakage and corrosion that will damage the remote control transmitter. Disposal of batteries should be in an environment-friendly manner.

**Observe the following precautions:**

1. Batteries should always be replaced as a pair. Always use new batteries when replacing the old set.
2. Do not combine a used battery with a new one.
3. Do not mix battery types (example: "Zinc Carbon" with "Alkaline").
4. Do not attempt to charge, short-circuit, disassemble, heat or burn used batteries.
5. Battery replacement is necessary when the remote control acts sporadically or stops operating the Plasma Display.



# Connections

When connecting the speakers, be sure to use only the optional accessory speakers. Refer to the speaker's Installation Manual for details on speaker installation. (Example: TH-42PH10UK)

Speakers (Optional accessories)

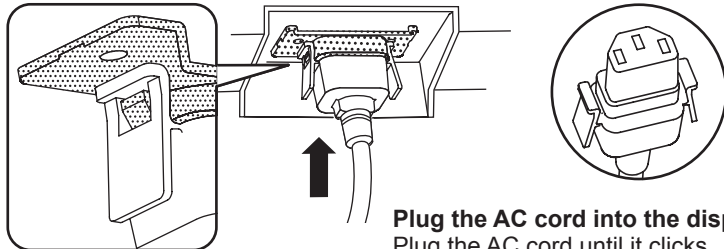
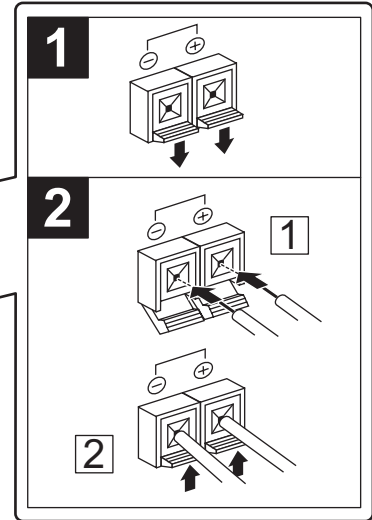
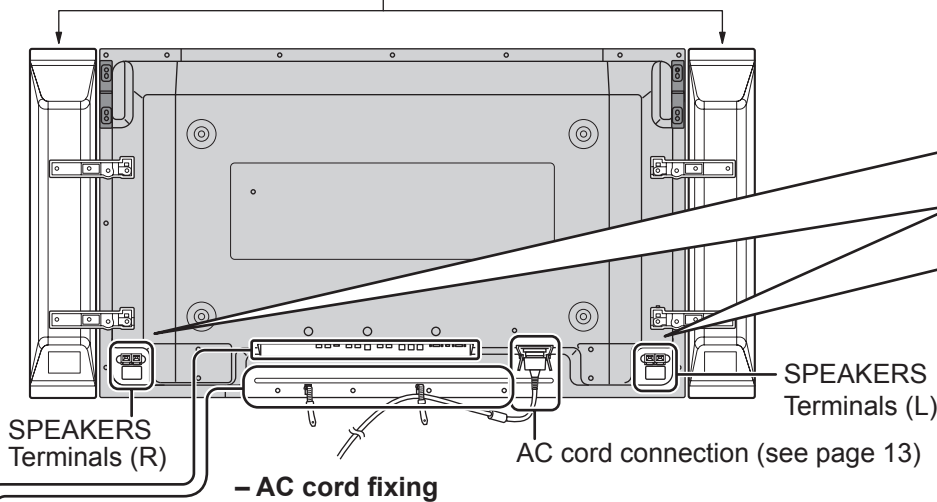

**Plug the AC cord into the display unit.**  
Plug the AC cord until it clicks.

**Note:**  
Make sure that the AC cord is locked on both the left and right sides.

**Unplug the AC cord**

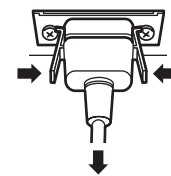

Unplug the AC cord pressing the two knobs.

**Note:**

When disconnecting the AC cord, be absolutely sure to disconnect the AC cord plug at the socket outlet first.

– Cable fixing bands

Secure any excess cables with bands as required.

Pass the attached cable fixing band through the clip as shown in the figure.

To secure cables connected to Terminals, wrap the cable fixing band around them then pass the pointed end through the locking block, as shown in the figure. **While ensuring there is sufficient slack in cables to minimize stress (especially in the power cord), firmly bind all cables with the supplied fixing band.**



1

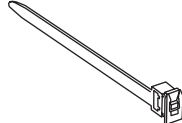

2

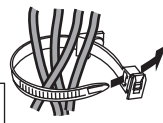

To tighten:

← Pull

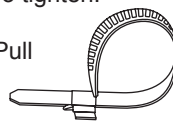

To loosen:

Push the catch

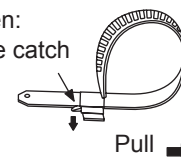

→ Pull

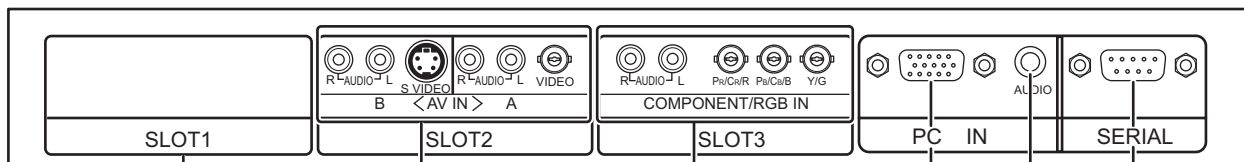

Optional Terminal Board Insert Slot (covered)

Dual Video Terminals (equivalent of BNC Dual Video Terminal Board (TY-FB9BD)) (see page 12)

COMPONENT/RGB IN and Audio IN Terminals (equivalent of BNC Component Video Terminal Board (TY-42TM6A)) (see page 12)

From EXTERNAL monitor terminal on Computer (see page 10)

From SERIAL Terminal on Computer (see page 11)

**Notes:**

- At factory shipment, Terminal boards are installed in SLOT 2 and SLOT 3.
- TH-37PH10UK has two slots only.

## PC Input Terminals connection

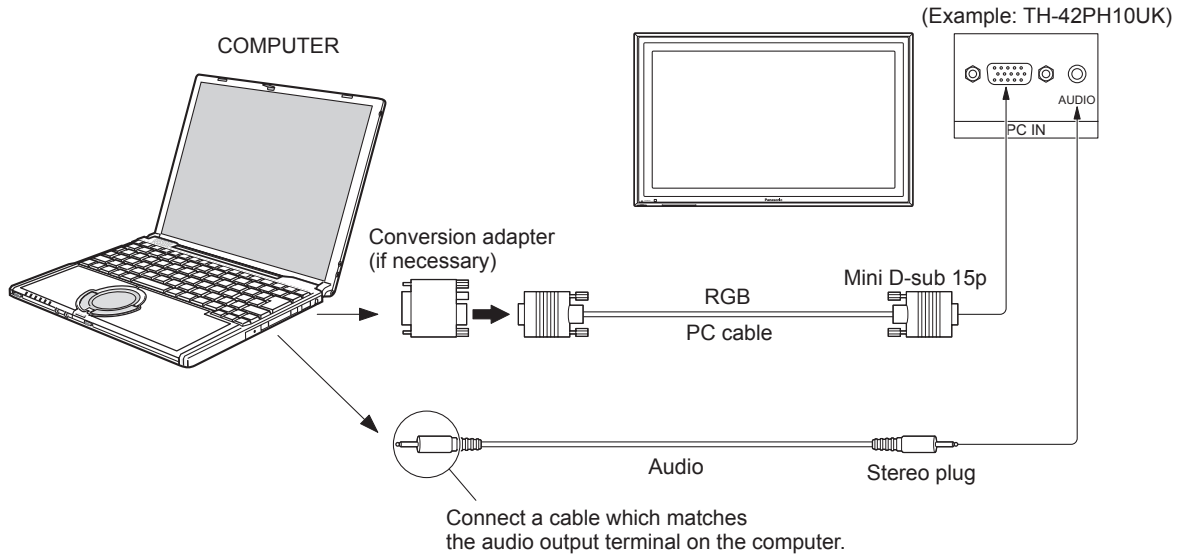

### Notes:

- Due to space limitations, occasionally you may have trouble connecting Mini D-sub 15P cable with ferrite core to PC input Terminal.
- Computer signals which can be input are those with a horizontal scanning frequency of 15 to 110 kHz and vertical scanning frequency of 48 to 120 Hz. (However, the image will not be displayed properly if the signals exceed 1,200 lines.)
- The display resolution is a maximum of 768 × 720 dots (TH-37PH10UK), 768 × 768 dots (TH-42PH10UK), 1,024 × 768 dots (TH-50PH10UK, TH-58PH10UK) when the aspect mode is set to “NORMAL”, and 1,024 × 720 dots (TH-37PH10UK), 1,024 × 768 dots (TH-42PH10UK), 1,366 × 768 dots (TH-50PH10UK, TH-58PH10UK) when the aspect mode is set to “FULL”. If the display resolution exceeds these maximums, it may not be possible to show fine detail with sufficient clarity.
- The PC input terminals are DDC2B-compatible. If the computer being connected is not DDC2B-compatible, you will need to make setting changes to the computer at the time of connection.
- Some PC models cannot be connected to the set.
- There is no need to use an adapter for computers with DOS/V compatible Mini D-sub 15P terminal.
- The computer shown in the illustration is for example purposes only.
- Additional equipment and cables shown are not supplied with this set.
- Do not set the horizontal and vertical scanning frequencies for PC signals which are above or below the specified frequency range.
- Component Input is possible with the pin 1, 2, 3 of the D-sub 15P Connector.
- Change the “COMPONENT/RGB-IN SELECT” setting in the “SET UP” menu to “COMPONENT” (when component connection) or “RGB” (when RGB signal connection). (see page 36)

### Signal Names for Mini D-sub 15P Connector

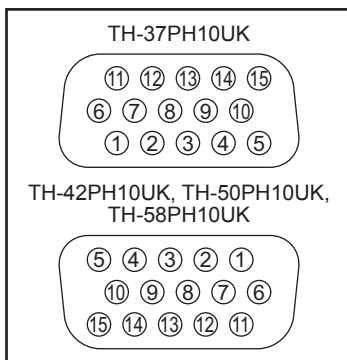

Pin No.	Signal Name	Pin No.	Signal Name	Pin No.	Signal Name
①	R (P <sub>R</sub> /C <sub>R</sub> )	⑥	GND (Ground)	⑪	NC (not connected)
②	G (Y)	⑦	GND (Ground)	⑫	SDA
③	B (P <sub>B</sub> /C <sub>B</sub> )	⑧	GND (Ground)	⑬	HD/SYNC
④	NC (not connected)	⑨	NC (not connected)	⑭	VD
⑤	GND (Ground)	⑩	GND (Ground)	⑮	SCL

Pin Layout for PC Input Terminal

# SERIAL Terminals connection

The SERIAL terminal is used when the Plasma Display is controlled by a computer.

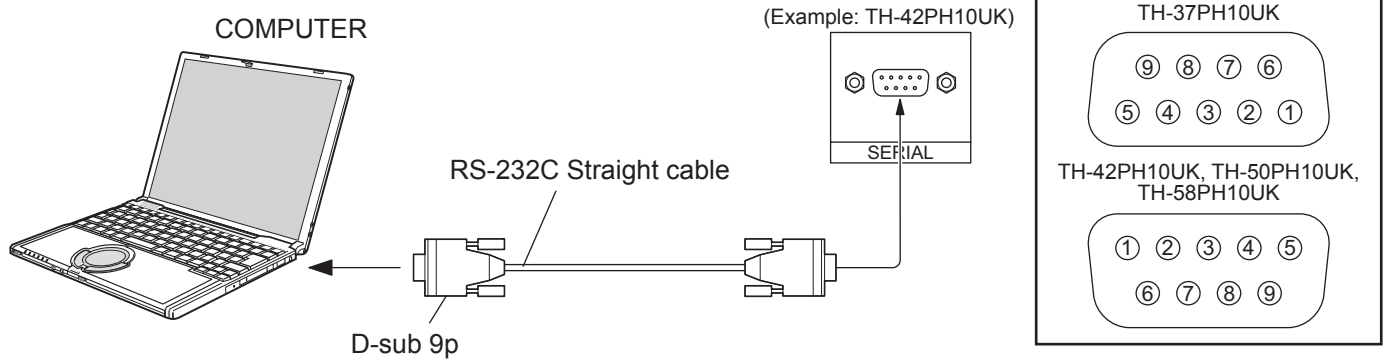

**Notes:**

- Use the RS-232C cable to connect the computer to the Plasma Display.
- The computer shown is for example purposes only.
- Additional equipment and cables shown are not supplied with this set.

The SERIAL terminal conforms to the RS-232C interface specification, so that the Plasma Display can be controlled by a computer which is connected to this terminal.

The computer will require software which allows the sending and receiving of control data which satisfies the conditions given below. Use a computer application such as programming language software. Refer to the documentation for the computer application for details.

**Communication parameters**

Signal level	RS-232C compliant
Synchronization method	Asynchronous
Baud rate	9600 bps
Parity	None
Character length	8 bits
Stop bit	1 bit
Flow control	-

RS-232C Conversion cable	
D-sub 9-pin female	Details
②	R X D
③	T X D
⑤	GND
④ • ⑥	Non use
⑦	Shorted
⑧	
① • ⑨	NC

**Basic format for control data**

The transmission of control data from the computer starts with a STX signal, followed by the command, the parameters, and lastly an ETX signal in that order. If there are no parameters, then the parameter signal does not need to be sent.

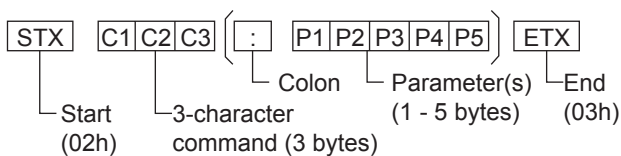

**Notes:**

- If multiple commands are transmitted, be sure to wait for the response for the first command to come from this unit before sending the next command.
- If an incorrect command is sent by mistake, this unit will send an "ER401" command back to the computer.
- SL1A, SL1B, SL2A and SL2B of Command IMS are available only when a dual input terminal board is attached.
- With the power off, this display responds to PON command only.

**Command**

Command	Parameter	Control details
PON	None	Power ON
POF	None	Power OFF
AVL	**	Volume 00 - 63
AMT	0	Audio MUTE OFF
	1	Audio MUTE ON
IMS	None	Input select (toggle)
	SL1	Slot1 input
	SL2	Slot2 input
	SL3	Slot3 input*
	PC1	PC input
	SL1A	Slot1 input (INPUT1A)
	SL1B	Slot1 input (INPUT1B)
DAM	None	Screen mode select (toggle)
	NORM	NORMAL (4 : 3)
	ZOOM	ZOOM
	FULL	FULL
	JUST	JUST
	SELF	Panasonic AUTO

\*SLOT3 cannot be selected on TH-37PH10UK.

## AV & COMPONENT / RGB connection

This unit has terminal boards equivalent to BNC Dual Video Terminal Board (TY-FB9BD) and BNC Component Video Terminal Board (TY-42TM6A) as standard equipment.

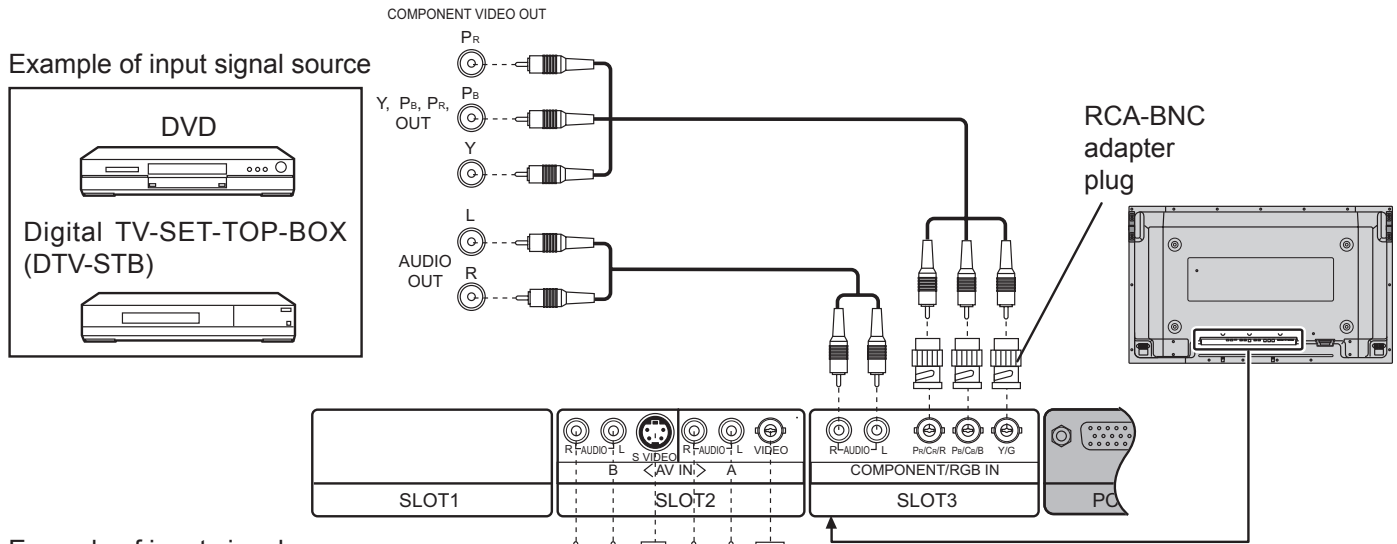

Example of input signal source

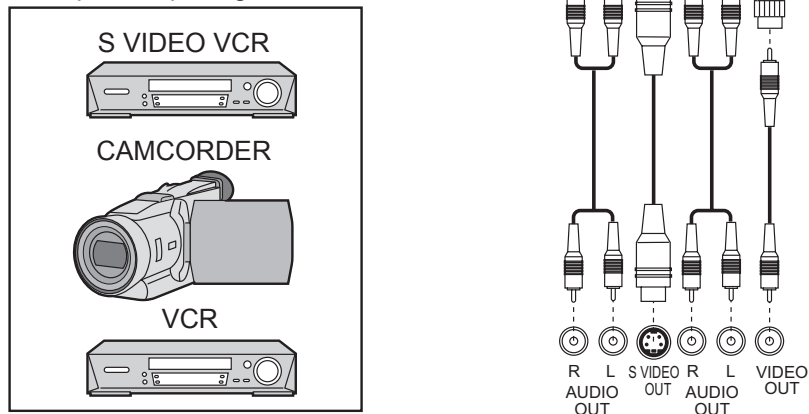

**Notes:**

- TH-37PH10UK has two slots only.
- Change the "COMPONENT/RGB-IN SELECT" setting in the "SET UP" menu to "COMPONENT" (When component connection). (see page 36)
- Additional equipment, cables and adapter plugs shown are not supplied with this set.

## RGB signal (R, G, B)

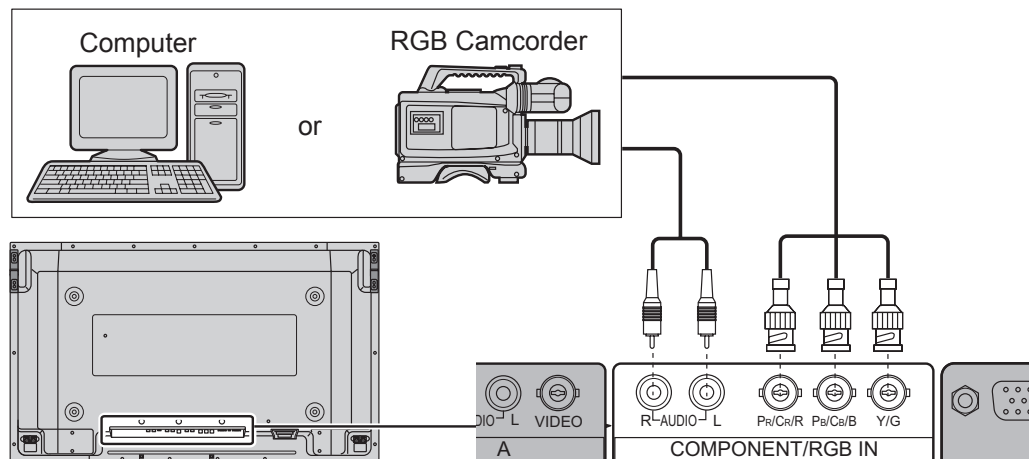

**Notes:**

- Change the "COMPONENT/RGB-IN SELECT" setting in the "SET UP" menu to "RGB". (see page 36)
- Additional equipment, cables and adapter plugs shown are not supplied with this set.

# Power ON / OFF

## Connecting the AC cord plug to the Plasma Display.

Fix the AC cord plug securely to the Plasma Display.  
(see page 9)

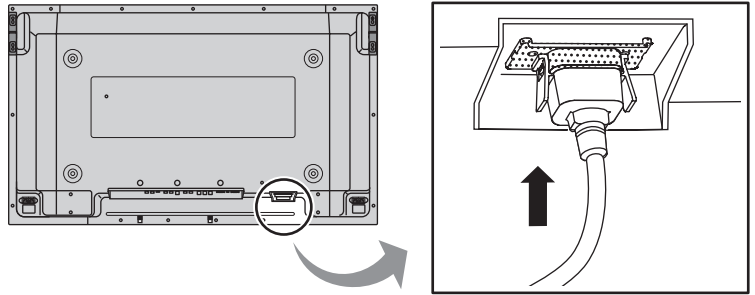

## Connecting the plug to the Wall Outlet

### Note:

When disconnecting the AC cord, be absolutely sure to disconnect the AC cord plug at the socket outlet first.

Press the Power switch on the Plasma Display to turn the set on: Power-On.

Power Indicator: Green

Example: The screen below is displayed for a while after the Plasma Display is turned on. (setting condition is an example.)

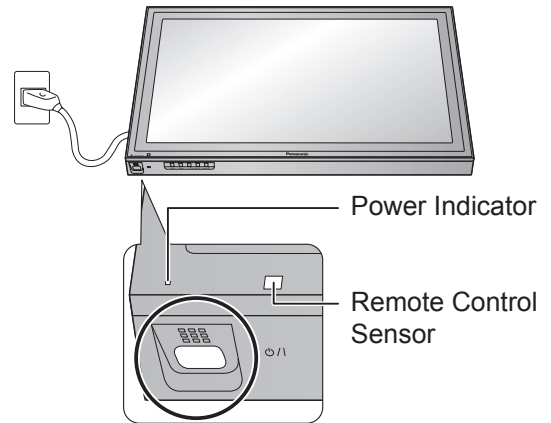

Power Indicator

Remote Control Sensor

When the POWER is turned on for the first time, the LANGUAGE selection screen is displayed.

From the second time on, language selection can be done from the setup menu. (see page 18)

Select the desired language using the ▲ or ▼ button and press the ACTION (■) button.

### Note:

Set with the remote control. Buttons on the main unit are unavailable for this setting.

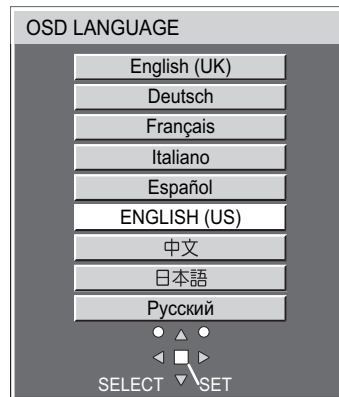

From the second time on, the screen shown below is displayed for a while (setting condition is an example).

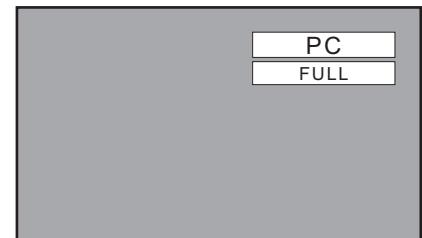

OFF



Press the OFF button on the remote control to turn the Plasma Display off.

Power Indicator: Red (standby)



Press the ON button on the remote control to turn the Plasma Display on.

Power Indicator: Green

Turn the power to the Plasma Display off by pressing the  $\phi$ /I switch on the unit, when the Plasma Display is on or in standby mode.

### Note:

During operation of the power management function, the power indicator turns orange in the power off state.

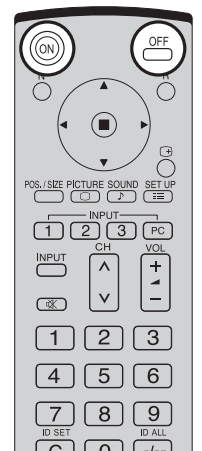

# Basic Controls

## Remote control sensor

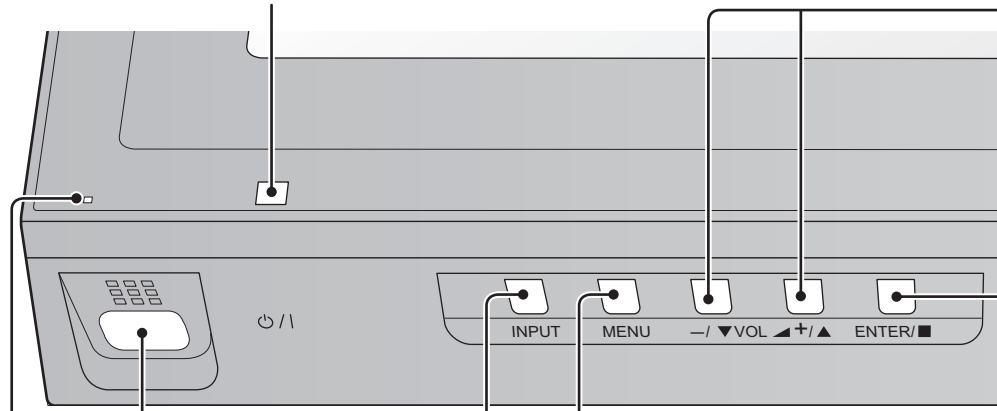

## Volume Adjustment

Volume Up “+” Down “-”  
When the menu screen is displayed:  
“+”: press to move the cursor up  
“-”: press to move the cursor down  
(see page 16)

## Enter / Aspect button

(see page 16, 19)

## Main Power On / Off Switch

### Power Indicator

The Power Indicator will light.

- Power-OFF .... Indicator not illuminated (The unit will still consume some power as long as the power cord is still inserted into the wall outlet.)
- Standby ..... Red
- Power-ON ..... Green
- DPMS..... Orange (With PC input signal and during operation of PC's screensaver.)

## MENU Screen ON / OFF

Each time the MENU button is pressed, the menu screen will switch. (see page 16)

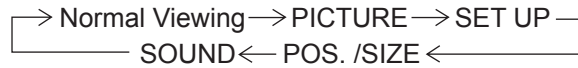

## INPUT button

(INPUT1, INPUT2, INPUT3 and PC selection)

(see page 18)

**N button** (see page 20, 23, 24, 25)

**POS. /SIZE button** (see page 20)

**PICTURE button** (see page 23)

**INPUT button**

(INPUT1, INPUT2, INPUT3 and PC selection)

Press to select INPUT1, INPUT2, INPUT3 and PC input SLOTS sequentially. (see page 18)

**Sound mute On / Off** (see page 25)

**Numeric buttons** (see page 35)

**ASPECT button**

Press to adjust the aspect. (see page 19)

**MULTI Window buttons** (see page 21)

## SURROUND button

The surround setting switches on and off each time the SURROUND button is pressed.

The benefits of surround sound are enormous. You can be completely enveloped in sound; just as if you were at a concert hall or cinema.

### Note:

The surround settings are memorized separately for each AUDIO MENU (STANDARD, DYNAMIC, CLEAR).

ON ← → OFF

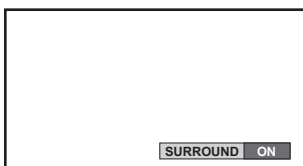

## Standby (ON / OFF) button

The Plasma Display must first be plugged into the wall outlet and turned on at the power switch (see page 13). Press ON to turn the Plasma Display On, from Standby mode. Press OFF to turn the Plasma Display Off to Standby mode.

## POSITION buttons

**ACTION button**  
Press to make selections.

**SOUND button**  
(see page 25)

## R button (see page 17)

Press the R button to return to previous menu screen.

## Status button

Press the "Status" button to display the current system status.

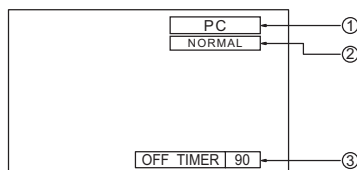

- ① Input label
- ② Aspect mode (see page 19)
- ③ Off timer  
The off timer indicator is displayed only when the off timer has been set.

## SET UP button (see page 16, 17)

## DIRECT INPUT buttons

Press the INPUT "1", "2", "3" or "PC" input mode selection button to select the INPUT mode.

This button is used to switch directly to INPUT mode.

These buttons can only display the slot which is installed. If you press the button whose slot is not installed, it automatically displays the current input signal.

### Notes:

- For TH-37PH10UK, press **1** to switch the input mode between INPUT1A and INPUT1B. The input mode is not switched to INPUT3 even if pressing **3**.
- For TH-42PH10UK, TH-50PH10UK and TH-58PH10UK, press **2** to switch the input mode between INPUT2A and INPUT2B.
- Image retention (image lag) may occur on the plasma display panel when a still picture is kept on the panel for an extended period. The function that darkens the screen slightly is activated to prevent image retention (see page 46), this function is not the perfect solution to image retention.

## Channel Adjustment

This button cannot be used for this model.

## Volume Adjustment

Press the Volume Up "+" or Down "-" button to increase or decrease the sound volume level.

## OFF TIMER button

The Plasma Display can be preset to switch to stand-by after a fixed period. The setting changes to 30 minutes, 60 minutes, 90 minutes and 0 minutes (off timer cancelled) each time the button is pressed.

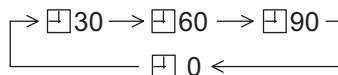

When three minutes remain, "OFF TIMER 3" will flash. The off timer is cancelled if a power interruption occurs.

## Remote ID lock (see page 35)

## Digital Zoom (see page 26)



Press to access Digital Zoom.

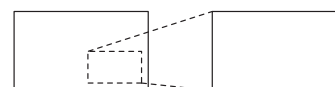

This displays an enlargement of the designated part of the displayed image.

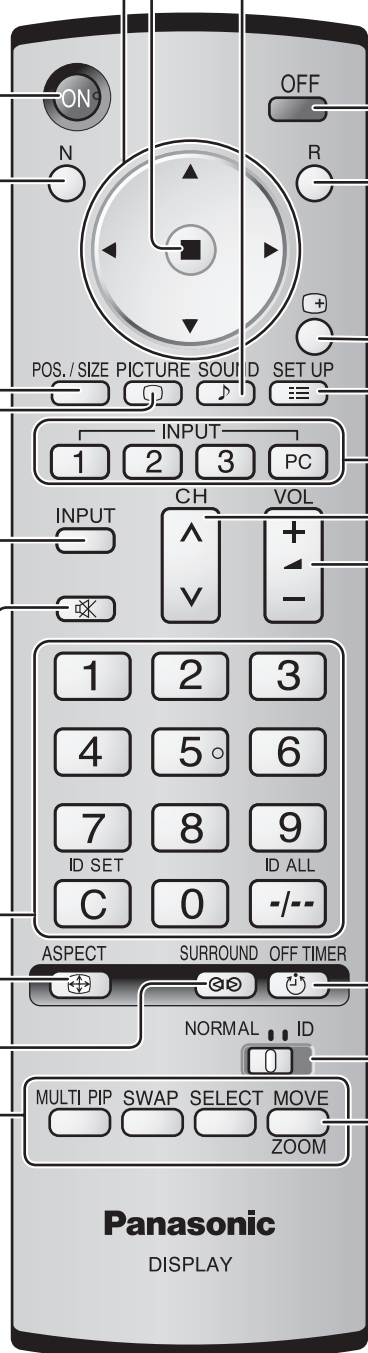

**Panasonic**  
DISPLAY

# On-Screen Menu Displays

To PICTURE adjust menu (see page 23)

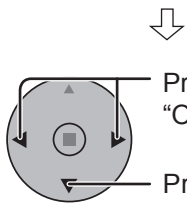
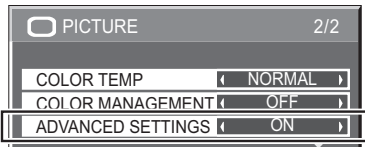
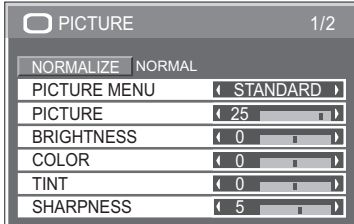

Press to select "ON".

Press to enter ADVANCED SETTINGS.

To ADVANCED SETTINGS (see page 23, 24)

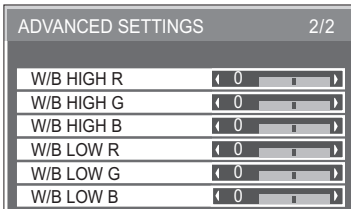
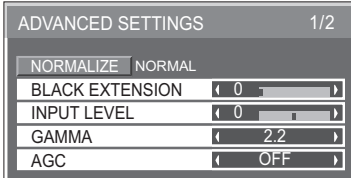

The MENU button on the unit can also be pressed.

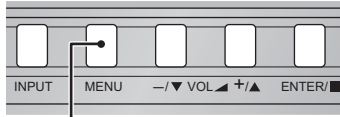

Each time the MENU button is pressed, the menu screen will switch.

→ Normal Viewing → PICTURE → SETUP  
SOUND ← POS. /SIZE ←

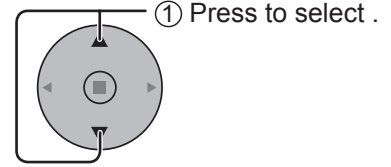
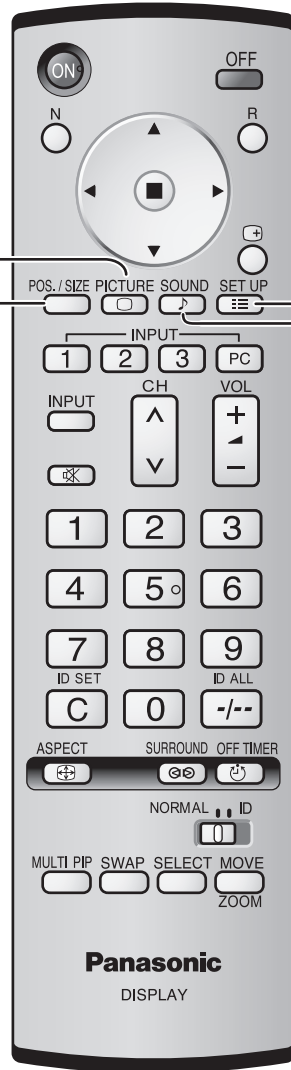

[ from the unit ]

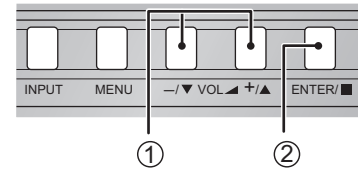

① Press to select.

② Press to access each adjust screen.

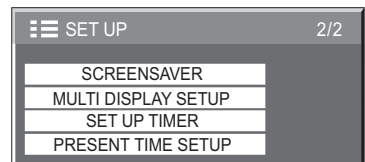
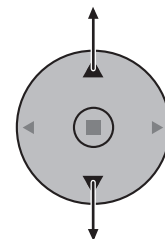
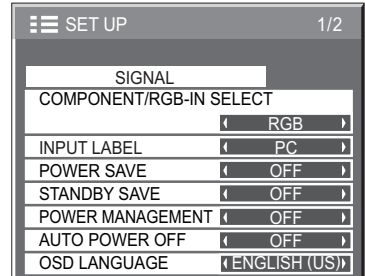

To POS. /SIZE adjust menu (see page 20)

During "VIDEO (S VIDEO)", "COMPONENT" and "Digital" input signal.

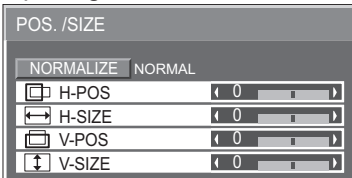

During "RGB/PC" input signal.

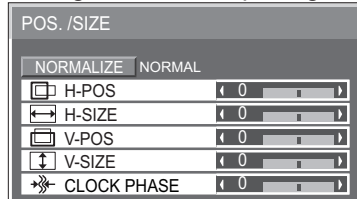

To SOUND adjust menu (see page 25)

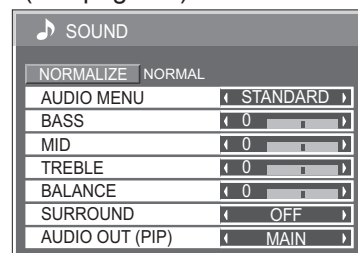



**Note:**

Menu that cannot be adjusted is grayout. Adjustable menu changes depending on signal, input and menu setting.

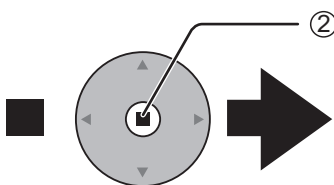

② Press to access each adjust screen.

[ from the unit ]

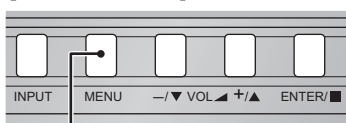

Press to return to next menu screen.

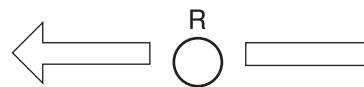

Press the R button to return to previous menu.

To SIGNAL screen for VIDEO (S VIDEO) (see page 36, 37)

SIGNAL [ VIDEO ]	
3D Y/C FILTER (NTSC)	ON
COLOR SYSTEM	AUTO
3 : 2 PULLDOWN	OFF
Panasonic AUTO (4 : 3)	NORMAL
VIDEO NR	OFF

To SIGNAL screen for COMPONENT (see page 37)

SIGNAL [ COMPONENT ]	
3 : 2 PULLDOWN	OFF
VIDEO NR	OFF

To SIGNAL screen for RGB (see page 37, 38)

SIGNAL [ RGB ]	
SYNC	AUTO
3 : 2 PULLDOWN	OFF
VIDEO NR	OFF
H-FREQ.	33.8 kHz
V-FREQ.	60.0 Hz

To SIGNAL screen for Digital (see page 37, 38)

SIGNAL [ Digital ]	
3 : 2 PULLDOWN	OFF
VIDEO NR	OFF
H-FREQ.	33.8 kHz
V-FREQ.	60.0 Hz

**Note:** "SIGNAL" setup menu displays a different setting condition for each input signal. (see page 18)

To setup SCREENSAVER (See page 29-31)

SCREENSAVER	
PRESENT TIME OF DAY	15:00
START	
FUNCTION	WHITE BAR SCROLL
MODE	TIME OF DAY
START TIME	6:15
FINISH TIME	12:30
SIDE BAR ADJUST	BRIGHT
WOBBLING	OFF
PEAK LIMIT	OFF

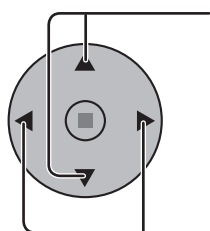

Press to select START TIME/ FINISH TIME (When TIME OF DAY is selected).  
Press to select SHOW DURATION/ SAVER DURATION (When INTERVAL is selected).

Press to set up.

SCREENSAVER	
PRESENT TIME OF DAY	15:00
START	
FUNCTION	WHITE BAR SCROLL
MODE	INTERVAL
SHOW DURATION	12:00
SAVER DURATION	3:00
SIDE BAR ADJUST	BRIGHT
WOBBLING	OFF
PEAK LIMIT	OFF



Press the R button to return to "SET UP" menu.

SCREENSAVER	
PRESENT TIME OF DAY	15:00
START	
FUNCTION	WHITE BAR SCROLL
MODE	TIME OF DAY
START TIME	6:15
FINISH TIME	12:30
SIDE BAR ADJUST	BRIGHT
WOBBLING	OFF
PEAK LIMIT	OFF

SCREENSAVER	
PRESENT TIME OF DAY	15:00
START	
FUNCTION	WHITE BAR SCROLL
MODE	INTERVAL
SHOW DURATION	12:00
SAVER DURATION	3:00
SIDE BAR ADJUST	BRIGHT
WOBBLING	OFF
PEAK LIMIT	OFF

To setup MULTIDISPLAY screen. (See page 33)

MULTI DISPLAY SETUP	
MULTI DISPLAY SETUP	OFF
HORIZONTAL SCALE	x 2
VERTICAL SCALE	x 2
SEAM HIDES VIDEO	OFF
LOCATION	A1
POWER ON SCREEN DELAY	ON

To SET UP TIMER selection screen. (see page 27, 28)

SET UP TIMER	
PRESENT TIME OF DAY	10:00
POWER ON FUNCTION	OFF
POWER ON TIME	0:00
POWER OFF FUNCTION	OFF
POWER OFF TIME	0:00

Press to select POWER ON TIME / POWER OFF TIME.

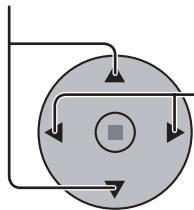

Press to set up POWER ON TIME / POWER OFF TIME.

SET UP TIMER	
PRESENT TIME OF DAY	10:00
POWER ON FUNCTION	OFF
POWER ON TIME	12:00
POWER OFF FUNCTION	OFF
POWER OFF TIME	18:00



SET UP TIMER	
PRESENT TIME OF DAY	10:00
POWER ON FUNCTION	OFF
POWER ON TIME	12:00
POWER OFF FUNCTION	OFF
POWER OFF TIME	18:00

To PRESENT TIME SETUP. (see page 27)

PRESENT TIME SETUP	
PRESENT TIME OF DAY	MON 99:99
SET	
DAY	MON
PRESENT TIME OF DAY	99:99



Press the R button to return to "SET UP" menu.

# Initial selections

## Selecting the input signal

Select the input signals to be connected by installing the optional Terminal Boards.



Press to select the input signal to be played back from the equipment which has been connected to the Plasma Display.

Input signals will change as follows:

- TH-37PH10UK

→ INPUT1A → INPUT1B → INPUT2 → PC

SLOT1 is for dual input so that you can select INPUT1A or INPUT1B for INPUT1.

INPUT1A : VIDEO signal terminal in SLOT1

INPUT1B : S-VIDEO signal terminal in SLOT1

- TH-42PH10UK, TH-50PH10UK, TH-58PH10UK

→ INPUT1 → INPUT2A → INPUT2B → INPUT3 → PC

SLOT2 is for dual input so that you can select INPUT2A or INPUT2B for INPUT2.

INPUT2A : VIDEO signal terminal in SLOT2

INPUT2B : S-VIDEO signal terminal in SLOT2

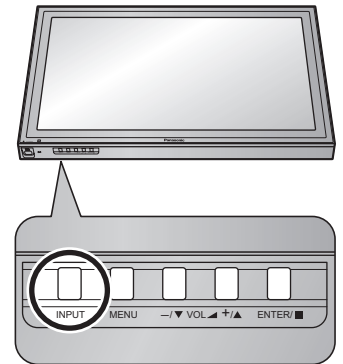
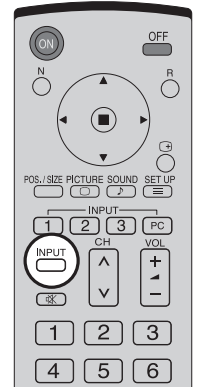

### Notes:

- Selecting is also possible by pressing the INPUT button on the unit.
- Input terminal will not be selected if the terminal board is not installed into the SLOT.
- Select to match the signals from the source connected to the component/RGB input terminals. (see page 36)
- In 2 screen display, the same input mode cannot be selected for the main picture and sub picture.

## Selecting the On-Screen Menu Language



Press to display the SET UP menu.

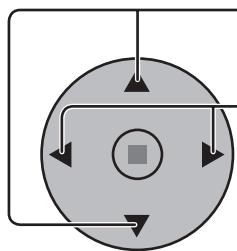

Press to select OSD LANGUAGE.

Press to select your preferred language.

### ■ Selectable languages

English(UK)  
Deutsch  
Français  
Italiano  
Español  
ENGLISH(US)  
中文.....(Chinese)  
日本語.....(Japanese)  
Русский.....(Russian)

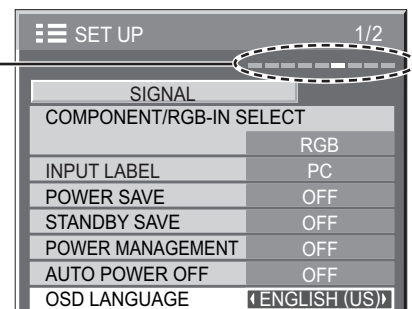
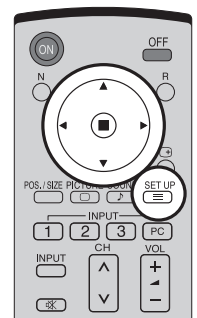

# ASPECT Controls

The Plasma Display will allow you to enjoy viewing the picture at its maximum size, including wide screen cinema format picture.

## ASPECT



Press repeatedly to move through the aspect options:



### Note:

When selecting an input slot that attaches BNC Dual Video Terminal Board (TY-FB9BD), Panasonic AUTO cannot be selected.

[from the unit]



The aspect mode changes each time the ENTER button is pressed.

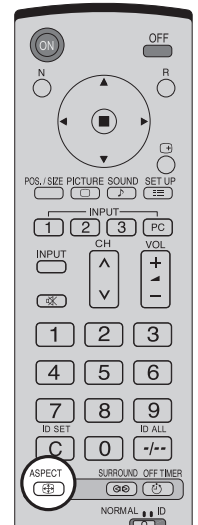

[During MULTI PIP Operations]

- Picture and Picture, Picture in Picture : Aspect switching is possible.
- Others : Aspect switching is not possible.



### Notes:

- For PC signal input, the mode switches between "NORMAL", "ZOOM" and "FULL" only.
- For a 1125 (1080) / 60i · 50i · 24p · 25p · 30p · 24sF, 1250 (1080) / 50i, 750 (720) / 60p · 50p signal input, the mode is set to "FULL" mode, and switching is not possible.
- Panasonic AUTO can be selected only during Video signal input.
- The aspect mode is memorized separately for each input terminal.

Mode	Picture	Explanation
NORMAL		NORMAL will display a 4:3 picture at its standard 4:3 size.
ZOOM		ZOOM mode magnifies the central section of the picture.
FULL		FULL will display the picture at its maximum size but with slight elongation.
JUST		JUST mode will display a 4:3 picture at its maximum size but with aspect correction applied to the center of the screen so that elongation is only apparent at the left and right edges of the screen. The size of the picture will depend on the original signal.
Panasonic AUTO	<p>For an elongated image</p> <p>For a 4:3 image</p> <p>Image is expanded in accordance with the Panasonic AUTO mode setting (see page 37).</p>	<p>The display will automatically become enlarged (depending on the picture source), allowing you to view the picture at its maximum size.</p> <p><b>Notes:</b></p> <ul style="list-style-type: none"> <li>• Panasonic AUTO mode is designed to automatically adjust the aspect ratio to handle a mix of 16:9 and 4:3 program material. Certain 4:3 program material, such as stock market data screens, may occasionally cause the image size to change unexpectedly. When viewing such programs, it is recommended that the ASPECT be set to NORMAL.</li> <li>• If adjusting the PICTURE V-POS/V-SIZE in Panasonic AUTO with FULL mode, the adjustment is not memorized. When exiting the mode, the screen will return to a former adjustment.</li> <li>• Panasonic AUTO can not be selected while equivalent board of BNC Dual Video Terminal Board (TY-FB9BD) is installed.</li> </ul>

**Note:** Do not allow the picture to be displayed in NORMAL mode for an extended period, as this can cause a permanent image retention to remain on the Plasma Display Panel.

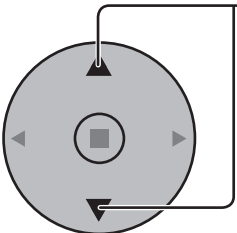
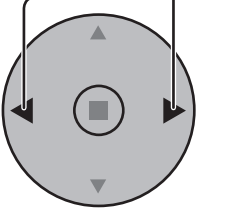
# Adjusting POS. /SIZE

- 1  Press to display the POS. /SIZE menu.
- 2  Press to select H-POS / H-SIZE / V-POS / V-SIZE / CLOCK PHASE.
- 3  Press to adjust POS. /SIZE.
- 4  Press to exit from adjust mode.

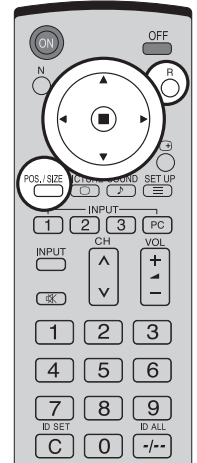

During "VIDEO (S VIDEO)", "COMPONENT" and "Digital" input signal.

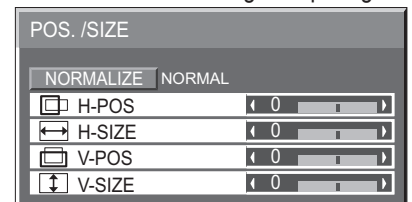

During "RGB / PC" input signal.

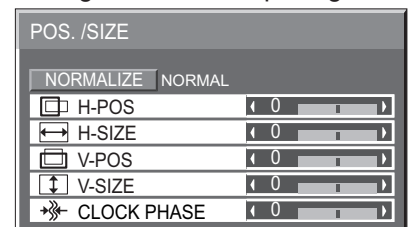

## Notes:

- Adjustment details are memorized separately for different input signal formats (Adjustments for component signals are memorized for 525 (480) / 60i · 60p, 625 (575) / 50i · 50p, 1125 (1080) / 60i · 50i · 24p · 25p · 30p · 24sF, 1250 (1080) / 50i, 750 (720) / 60p · 50p each, and RGB/PC/Digital signals are memorized for each frequency.)
- If a "Cue" or "Rew" signal from a VCR or DVD player is received, the picture position will shift up or down. This picture position movement cannot be controlled by the POS. /SIZE function.
- If adjusting the PICTURE V-POS / V-SIZE in Panasonic AUTO with FULL mode, the adjustment is not memorized. When exiting the mode, the screen will return to a former adjustment.

**H-POS** Adjust the horizontal position.

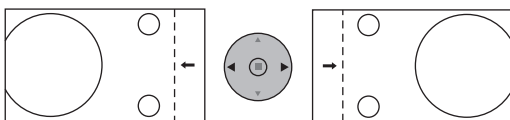

**H-SIZE** Adjust the horizontal size.

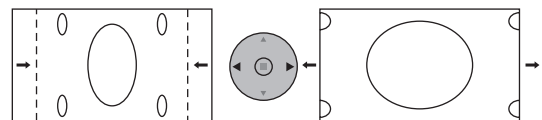

**V-POS** Adjust the vertical position.

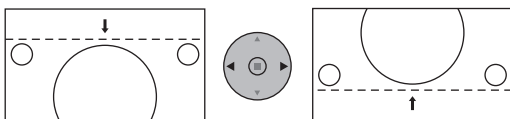

**V-SIZE** Adjust the vertical size.

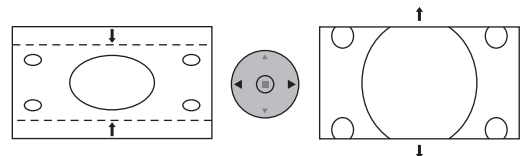

**CLOCK PHASE** (RGB/PC in mode) Eliminate the flickering and distortion.

## Helpful Hint ( / **NORMALIZE** Normalization)

While the POS. /SIZE display is active, if either the N button on the remote control is pressed at any time or the ACTION (  ) button is pressed during "NORMALIZE", then all adjustment values are returned to the factory settings.

# MULTI PIP

## MULTI PIP



Press repeatedly.  
Each time pressing this button main picture and sub picture will be displayed as follows below.

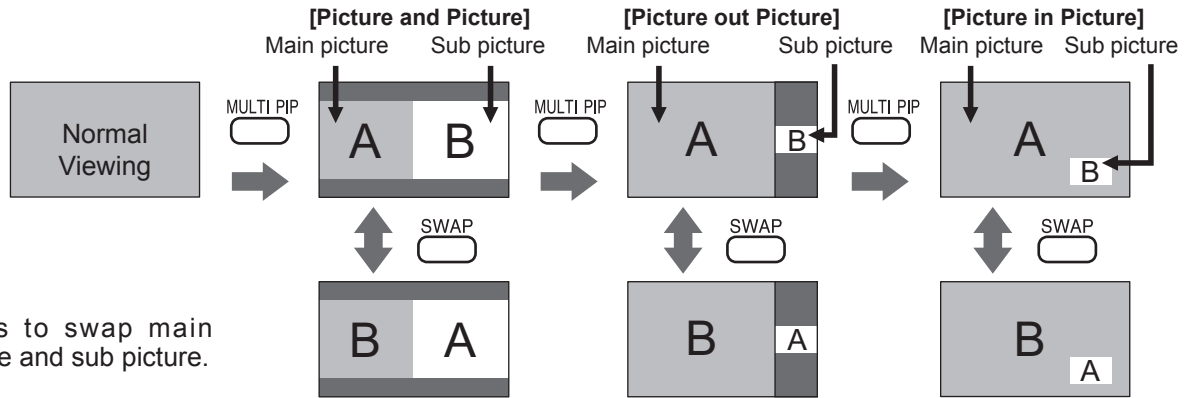

## SWAP



Press to swap main picture and sub picture.

## SELECT



Press to select the input mode.  
Under main Picture and sub picture display, select the picture which you would like to change input modes.

### Notes:

- The sub picture sound is heard while a sub picture operation is underway.
- The sub picture operation automatically returns to the main picture operation if a sub picture operation has not been performed for about 5 seconds or if any of the remote control buttons is pressed (except INPUT button).

## INPUT



Press to change input signal.

## MOVE



Press to move the sub picture.

## ZOOM

Each time the location of the sub picture will be moved.

### Notes:



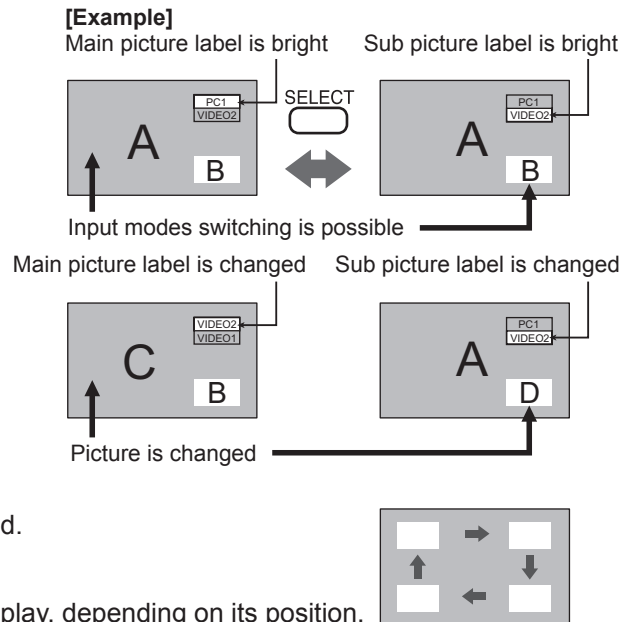

- This button is effective only in the picture in picture.
- The sub picture may be hidden by the on screen display, depending on its position.

## Notes:

- If "Input lock" in Options menu is set to other than "Off", MULTI PIP function isn't available.
- Sound output is from the picture which is selected in Audio OUT(PIP) (See page 25).
- In 2 screen display, the same input mode cannot be selected for the main picture and sub picture.
- The main picture and sub picture are processed by different circuits, resulting in a slight difference in the clarity of the pictures. There may also be a difference in the picture quality of the sub picture depending on the type of signals displayed on the main picture and depending on the 2-picture display mode.
- Due to the small dimensions of the sub pictures, these sub pictures cannot be shown in detail.
- Computer screen picture is displayed in a simplified format, and it may not be possible to discern details on them satisfactorily.
- Following combinations of two analog signals cannot be displayed simultaneously;  
Component - Component, Component - PC (RGB), PC (RGB) - Component, PC (RGB) - PC (RGB)

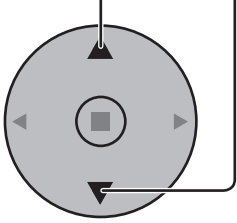

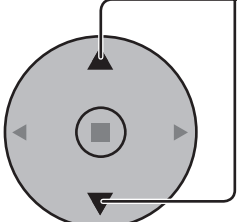
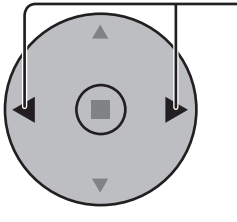

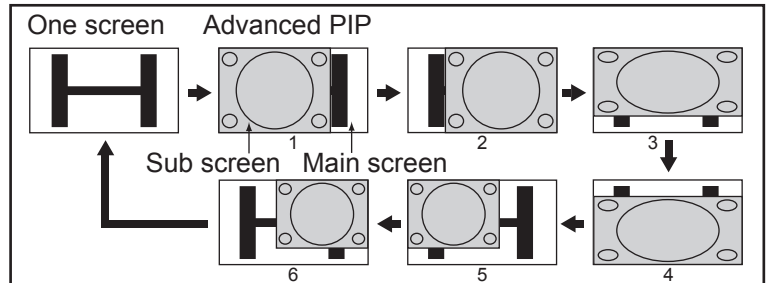
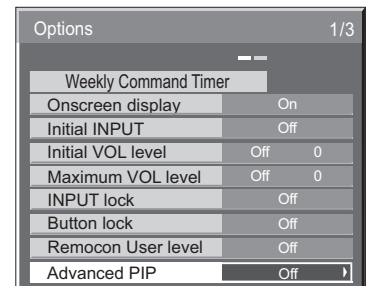
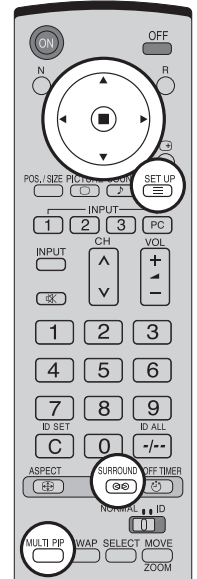

# Advanced PIP

- 1  Press to display the Setup menu.
- 2  Press to select "OSD Language".
- 3  Press and hold until the Options menu is displayed.
- 4  Press to select Advanced PIP.
- 5  Press to adjust the menu.  
Off : Sets normal two screen display mode (see page 21).  
On : Sets Advanced PIP mode.
- 6  Press to exit from Options menu.
- 7  Press repeatedly.  
Each time pressing this button main picture and sub picture will be displayed as above.



**Note:**

To use , , ,  buttons for the screen operations, follow the procedures in the previous page.

**Notes:**

- Advanced PIP corresponding signal

Sub screen	Main screen
NTSC, PAL, SECAM (tuner, video) 525i, 525p, 625i, 625p, 750/60p, 750/50p, 1125/60i, 1125/50i, 1250/50i (Component Video, RGB, DVI, SDI, HDMI)	640x480@60Hz, 852x480@60Hz, 1024x768@60Hz, 1366x768@60Hz (RGB, DVI, HDMI) 1280x768@60Hz (DVI)

- If "Input lock" in Options menu is set to other than "Off", MULTI PIP function isn't available.
- Sound output is from the picture which is selected in Audio OUT (PIP) (See page 25).
- In 2 screen display, the same input mode cannot be selected for the main picture and sub picture.
- The main picture and sub picture are processed by different circuits, resulting in a slight difference in the clarity of the pictures. There may also be a difference in the picture quality of the sub picture depending on the type of signals displayed on the main picture and depending on the 2-picture display mode.
- Due to the small dimensions of the sub pictures, these sub pictures cannot be shown in detail.
- Computer screen picture is displayed in a simplified format, and it may not be possible to discern details on them satisfactorily.
- Following combinations of two analog signals cannot be displayed simultaneously;  
Component - Component, Component - PC (RGB), PC (RGB) - Component, PC (RGB) - PC (RGB)
- Refer to each board's operating instruction for DVI, SDI, HDMI's corresponding signals.

# PICTURE Adjustments

**1**  Press to display the PICTURE menu.

**2** Select to adjust each item.

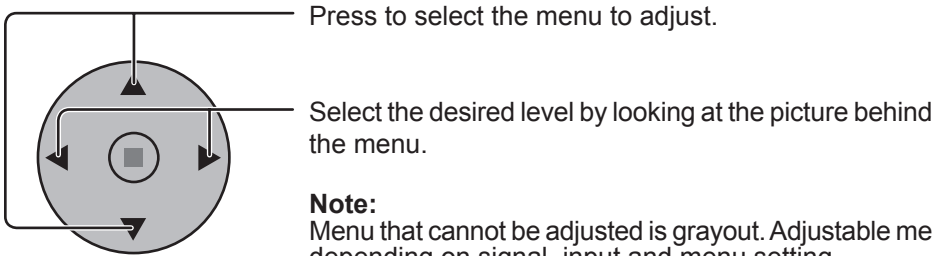

**Note:**  
Menu that cannot be adjusted is grayout. Adjustable menu changes depending on signal, input and menu setting.

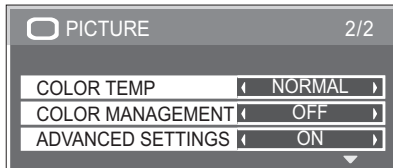
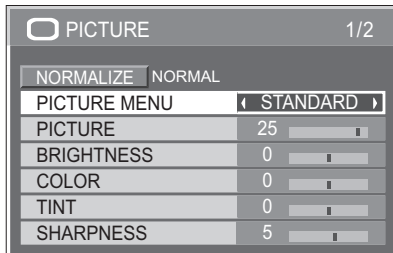
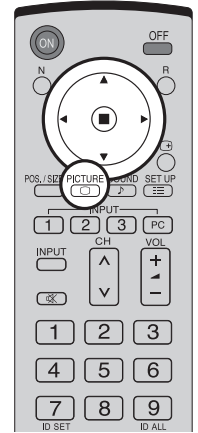

Press the left ◀ or right ▶ button to switch between modes.



## STANDARD

For viewing in standard (evening lighting) environments. This menu selects the normal levels of BRIGHTNESS and PICTURE.

## DYNAMIC

For viewing in brighter environments. This menu selects higher than normal levels of BRIGHTNESS and PICTURE.

## CINEMA

Ideal for movies.

### Note:

If you would like to change the picture and color of the selected PICTURE menu to something else, adjust using the items in the PICTURE menu. (see next page)

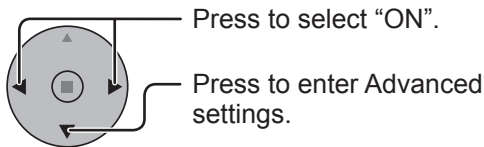

**ADVANCED SETTINGS ON**  
Enables fine picture adjustment at a professional level (see next page).

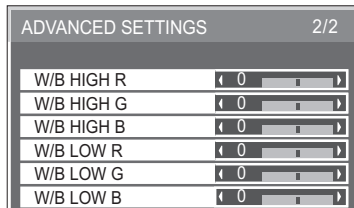
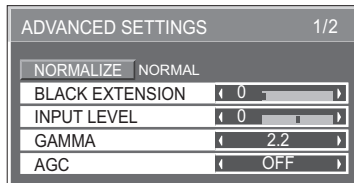

**ADVANCED SETTINGS OFF**  
Displays images with settings of the PICTURE menu.

Press the left ◀ or right ▶ button to switch between modes.



## COLOR MANAGEMENT ON

Enables vivid color adjustment automatically.

## Helpful Hint ( / **NORMALIZE Normalization** )

While the "PICTURE" menu is displayed, if either the N button on the remote control is pressed at any time or the ACTION (■) button is pressed during "NORMALIZE", then all adjustment values are returned to the factory settings.

## PICTURE Adjustments

Item	Effect	Adjustments
PICTURE	◀ Less ▶ More	Adjusts the proper picture contrast.
BRIGHTNESS	◀ Darker ▶ Brighter	Adjusts for easier viewing of dark pictures such as night scenes and black hair.
COLOR	◀ Less ▶ More	Adjusts color saturation.
TINT	◀ Reddish ▶ Greenish	Adjusts for natural flesh tones.
SHARPNESS	◀ Less ▶ More	Adjusts picture sharpness.

### Notes:

- “COLOR” and “TINT” settings cannot be adjusted for “RGB/PC” and “Digital” input signal.
- You can change the level of each function (PICTURE, BRIGHTNESS, COLOR, TINT, SHARPNESS) for each PICTURE MENU.
- The setting details for STANDARD, DYNAMIC and CINEMA respectively are memorized separately for each input terminal.
- The “TINT” setting can be adjusted for NTSC signal only during “VIDEO (S VIDEO)” input signal.
- In PICTURE, there is not a noticeable change even when contrast is increased with a bright picture or reduced with a dark picture.

## ADVANCED SETTINGS

Item	Effect	Details
BLACK EXTENSION	◀ Less ▶ More	Adjusts the dark shades of the image in gradation.
INPUT LEVEL	◀ Less ▶ More	Adjustment of parts which are extremely bright and hard to see. (This cannot be adjusted when the input signal is Digital.)
GAMMA	◀ Down ▶ Up	S CURVE ←→ 2.0 ←→ 2.2 ←→ 2.5
AGC	◀ OFF ▶ ON	Increases the brightness of dark signal automatically.
W/B HIGH R	◀ Less ▶ More	Adjusts the white balance for light red areas.
W/B HIGH G	◀ Less ▶ More	Adjusts the white balance for light green areas.
W/B HIGH B	◀ Less ▶ More	Adjusts the white balance for light blue areas.
W/B LOW R	◀ Less ▶ More	Adjusts the white balance for dark red areas.
W/B LOW G	◀ Less ▶ More	Adjusts the white balance for dark green areas.
W/B LOW B	◀ Less ▶ More	Adjusts the white balance for dark blue areas.

### Notes:

- Carry out “W/B” adjustment as follows.
  1. Adjust the white balance of the bright sections using the “W/B HIGH R”, “W/B HIGH G” and “W/B HIGH B” settings.
  2. Adjust the white balance of the dark sections using the “W/B LOW R”, “W/B LOW G” and “W/B LOW B” settings.
  3. Repeat steps 1 and 2 to adjust.
 Steps 1 and 2 affect each other’s settings, so repeat each step in turn to make the adjustment.
- The adjustment values are memorized separately for each input terminal.
- The adjustment range values should be used as an adjustment reference.

### Helpful Hint ( / **NORMALIZE Normalization** )

On the remote control unit, while the “ADVANCED SETTINGS” menu is displayed, if either the N button is pressed at any time or the ACTION (  ) button is pressed during “NORMALIZE”, then all adjustment values are returned to the factory settings.



# SOUND Adjustment

**1**  Press to display the SOUND menu.

**2** Select to adjust each item.

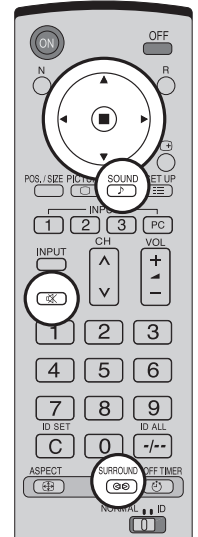
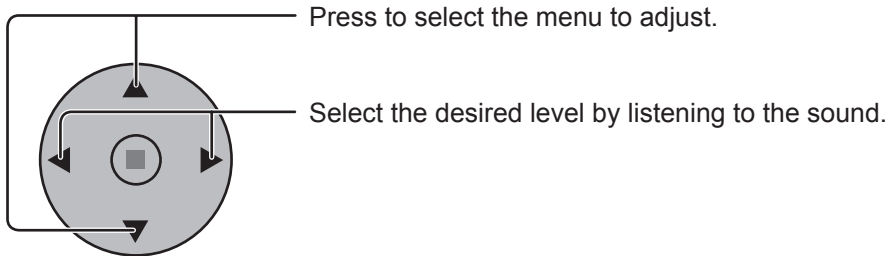

**BASS**  
Adjusts low pitch sounds

**MID**  
Adjusts normal sounds

**TREBLE**  
Adjusts pitch sounds

**BALANCE**  
Adjusts left and right volumes

**SURROUND**  
Select On or Off

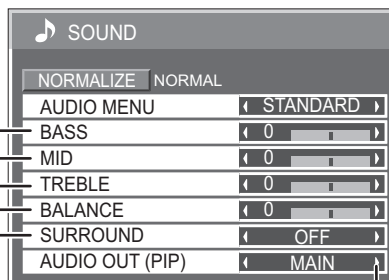

**STANDARD** Emits the original sound.



**DYNAMIC** Accentuates sharp sound.



**CLEAR** Attenuates human voice.

**MAIN** Selects main picture sound.



**SUB** Selects PIP frame sound.

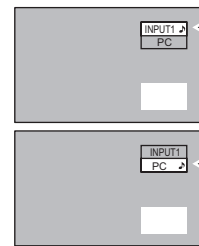

(When main picture sound is chosen.)

(When PIP frame sound is chosen.)

Musical note  is displayed on right side of the audio output screen label.

## Notes:

- Press the SURROUND button to directly turn the surround effect ON and OFF. (see page 14)
- BASS, MID, TREBLE and SURROUND settings are memorized separately for each AUDIO MENU.

## Helpful Hint ( / **NORMALIZE** Normalization)

While the "SOUND" menu is displayed, if either the N button on the remote control is pressed at any time or the ACTION () button is pressed during "NORMALIZE", then all adjustment values are returned to the factory settings.

## MUTE

Useful when answering the phone or receiving unexpected visitors.



Press this button to mute the sound.

Press again to reactivate sound. Sound is also reactivated when power is turned off or volume level is changed.

# Digital Zoom

This displays an enlargement of the designated part of the displayed image.

## 1 Display the operation guide.

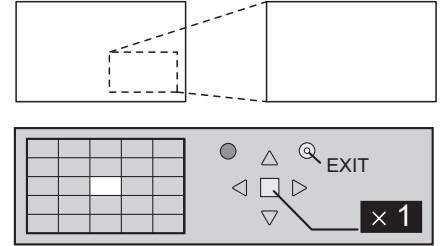
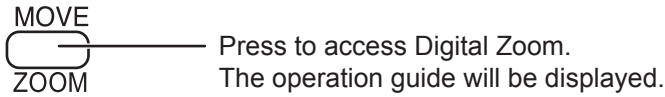

**During Digital Zoom, only the following buttons can be operated.**

[Remote control]

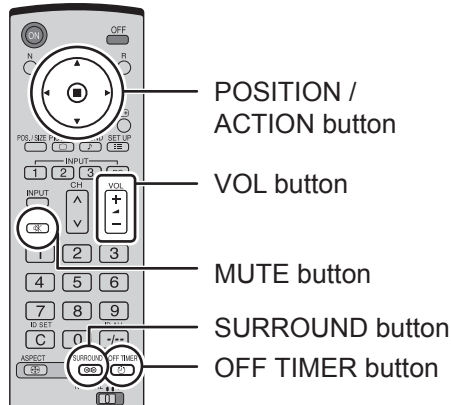

[Unit]

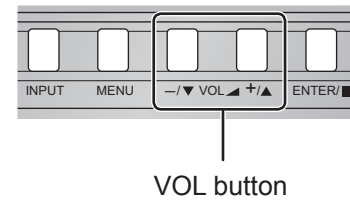

## 2 Select the area of the image to be enlarged.

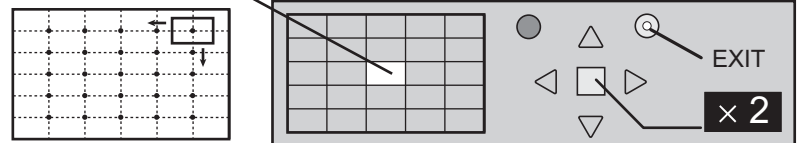
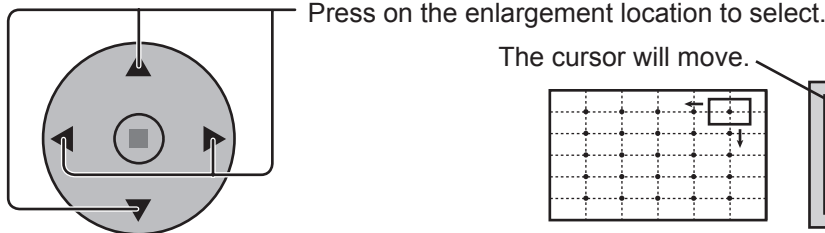

## 3 Select the magnification required for the enlarged display.

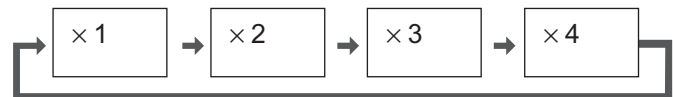
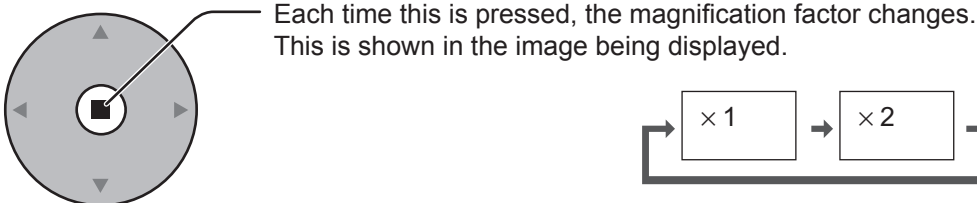

## 4 Return to normal display (quit Digital Zoom).

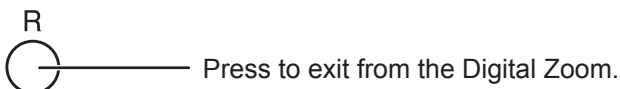

### Notes:

- When power goes OFF (including "Off Timer" operation), Digital Zoom terminates.
- The Digital Zoom function cannot be selected while in the following operation state:  
"Multi-viewer" (Picture in Picture, Picture out Picture, Picture and Picture) operation. (see page 21)
- While Digital Zoom is in operation, "Adjusting POS. /SIZE" cannot be used.

# PRESENT TIME SETUP / SET UP TIMER

The timer can switch the Plasma Display ON or OFF.

Before attempting Timer Set, confirm the PRESENT TIME OF DAY and adjust if necessary. Then set POWER ON TIME / POWER OFF TIME.

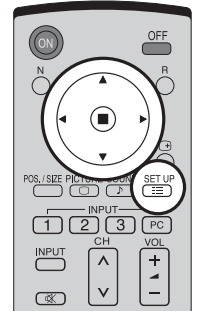

**1**  Press to display the SET UP menu.

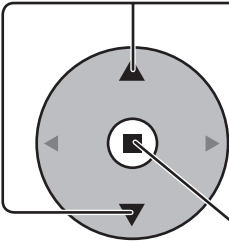
**2**  Press to select SET UP TIMER or PRESENT TIME SETUP.  
Press to display the SET UP TIMER screen or PRESENT TIME SETUP screen.

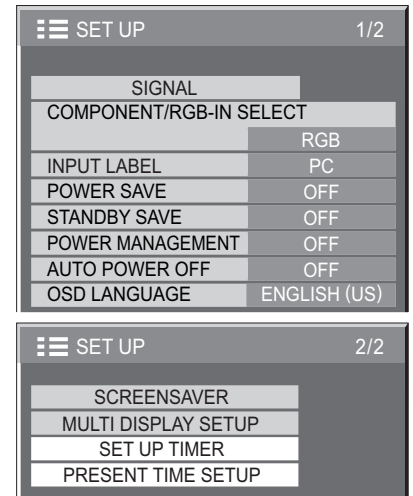

## PRESENT TIME SETUP

Display the PRESENT TIME SETUP screen.

To set up DAY and PRESENT TIME OF DAY, follow the procedure described below.

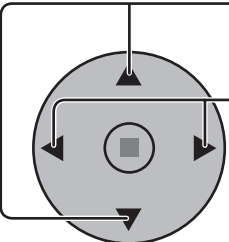
**1**  Press to select DAY or PRESENT TIME OF DAY.  
Press to set up DAY or PRESENT TIME OF DAY.  
▶ button: Forward  
◀ button: Back  
**Notes:**  
• Pressing “◀” or “▶” button once changes PRESENT TIME OF DAY 1minute.  
• Pressing “◀” or “▶” button continuously changes PRESENT TIME OF DAY by 15 minutes.

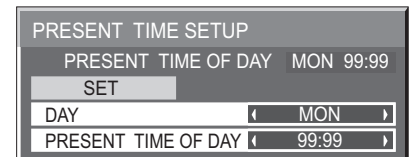

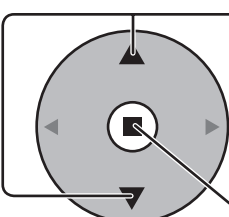
**2**  Press to select SET.  
Press to store PRESENT TIME SETUP.  
**Notes:**  
• SET cannot be selected unless PRESENT TIME OF DAY is set.  
• Unless setting the present time other than “99:99”, DAY setting is invalid.

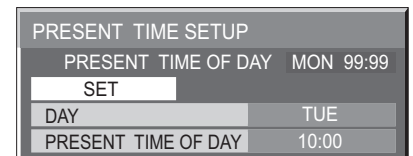

**3**  Press to exit from PRESENT TIME SETUP.

## SET UP TIMER

Display the SET UP TIMER SCREEN.

**1**

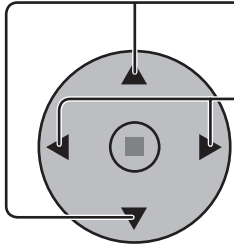

Press to select  
POWER ON TIME / POWER OFF TIME.

Press to set up POWER ON TIME / POWER OFF  
TIME.

▶ button: Forward  
◀ button: Back

SET UP TIMER	
PRESENT TIME OF DAY 10:00	
POWER ON FUNCTION	OFF
POWER ON TIME	◀ 12:00 ▶
POWER OFF FUNCTION	OFF
POWER OFF TIME	◀ 18:00 ▶

**Notes:**

- Pressing “◀” or “▶” button once changes POWER ON TIME / POWER OFF TIME 1minute.
- Pressing “◀” or “▶” button continuously changes POWER ON TIME / POWER OFF TIME by 15 minutes.

**2**

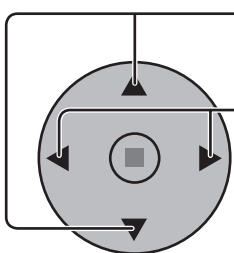

Press to select POWER ON FUNCTION  
/ POWER OFF FUNCTION.

Press to select ON.

SET UP TIMER	
PRESENT TIME OF DAY 10:00	
POWER ON FUNCTION	◀ ON ▶
POWER ON TIME	12:00
POWER OFF FUNCTION	◀ ON ▶
POWER OFF TIME	18:00

**3**



Press twice to exit from SET UP.

**Note:**

Timer function will not work unless “PRESENT TIME OF DAY” is set.

# SCREENSAVER (For preventing image retention)

Do not display a still picture, especially in NORMAL mode, for any length of time.  
If the display must remain on, a SCREENSAVER should be used.

**1**  Press to display the SET UP menu.

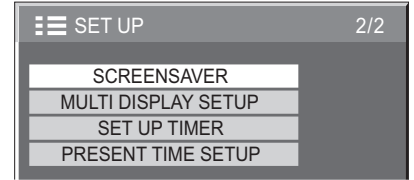

**2**  Press to select the SCREENSAVER.

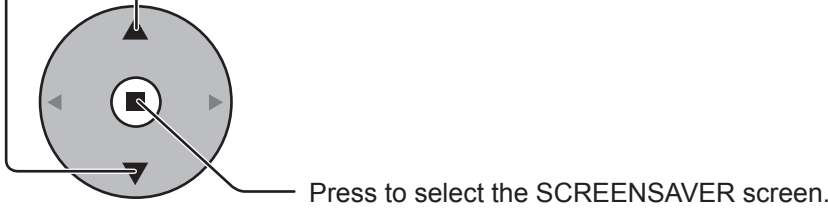

### **3** NEGATIVE / SCROLL selection

 Press to select the FUNCTION.

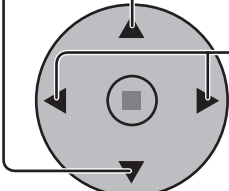
 Press to select the desired function.

WHITE BAR SCROLL ← → NEGATIVE

WHITE BAR SCROLL : A white bar will scroll from left to right.

NEGATIVE : A negative image will be displayed on the screen.

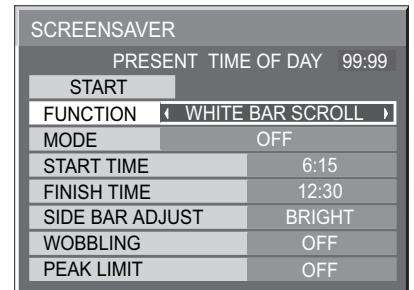

### **4** MODE selection

 Press to select the MODE.

 Press to select each mode items.

- OFF
- ↕
- INTERVAL
- ↕
- TIME OF DAY
- ↕
- ON

- : Operates when SHOW DURATION and SAVER DURATION are set up and those times arrive.
- : Operates when START TIME and FINISH TIME are set up and those times arrive.
- : Operates when START is selected and the ACTION (■) button is pressed.

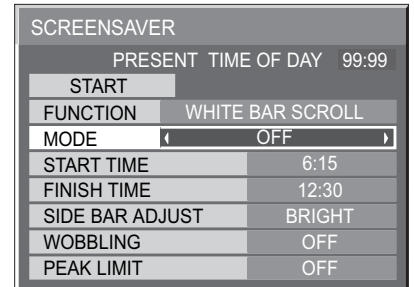

### **5** START setting

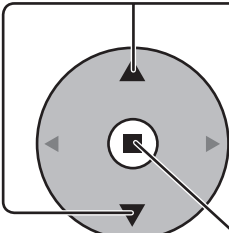
 When the MODE is set to ON, press to select START.

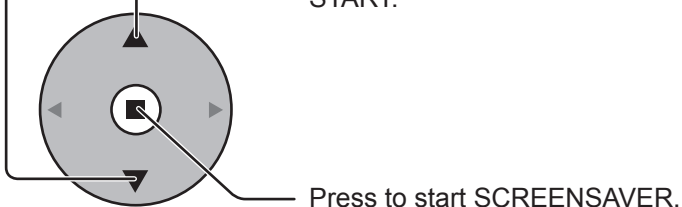

The menu screen will disappear and the SCREENSAVER will be activated. **To stop the SCREENSAVER under ON, press the R button.**

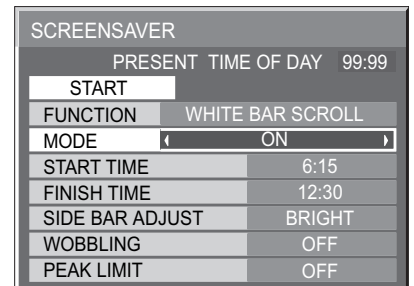

# SCREENSAVER (For preventing image retention)

## Setup of SCREENSAVER Time

After selecting TIME OF DAY or INTERVAL, the relevant Time Setup will become available for selection and the Operating Time may be set. (Time cannot be set when "MODE" is "ON" or "OFF".)

SCREENSAVER	
PRESENT TIME OF DAY 15:10	
START	
FUNCTION	WHITE BAR SCROLL
MODE	TIME OF DAY
START TIME	6:15
FINISH TIME	12:30
SIDE BAR ADJUST	BRIGHT
WOBLING	OFF
PEAK LIMIT	OFF

SCREENSAVER	
PRESENT TIME OF DAY 15:00	
START	
FUNCTION	WHITE BAR SCROLL
MODE	INTERVAL
SHOW DURATION	12:00
SAVER DURATION	3:00
SIDE BAR ADJUST	BRIGHT
WOBLING	OFF
PEAK LIMIT	OFF

SCREENSAVER	
PRESENT TIME OF DAY 99:99	
START	
FUNCTION	WHITE BAR SCROLL
MODE	OFF
START TIME	6:15
FINISH TIME	12:30
SIDE BAR ADJUST	BRIGHT
WOBLING	OFF
PEAK LIMIT	OFF

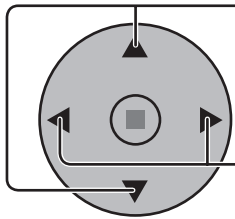

Press to select START TIME / FINISH TIME  
(When TIME OF DAY is selected).  
Press to select SHOW DURATION / SAVER  
DURATION (When INTERVAL is selected).

Press to setup.  
▶ button: Forward  
◀ button: Back

### Notes:

- Pressing "◀" or "▶" button once changes the Time 1minute.  
[However, switching occurs every 15 minutes when Periodic Time is selected.]
- Pressing "◀" or "▶" button continuously changes the Time by 15 minutes.

SCREENSAVER	
PRESENT TIME OF DAY 15:10	
START	
FUNCTION	WHITE BAR SCROLL
MODE	TIME OF DAY
START TIME	◀ 0:00 ▶
FINISH TIME	◀ 0:00 ▶
SIDE BAR ADJUST	BRIGHT
WOBLING	OFF
PEAK LIMIT	OFF

SCREENSAVER	
PRESENT TIME OF DAY 15:00	
START	
FUNCTION	WHITE BAR SCROLL
MODE	INTERVAL
SHOW DURATION	◀ 0:00 ▶
SAVER DURATION	◀ 0:00 ▶
SIDE BAR ADJUST	BRIGHT
WOBLING	OFF
PEAK LIMIT	OFF

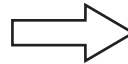

SCREENSAVER	
PRESENT TIME OF DAY 15:00	
START	
FUNCTION	WHITE BAR SCROLL
MODE	TIME OF DAY
START TIME	◀ 6:15 ▶
FINISH TIME	◀ 12:30 ▶
SIDE BAR ADJUST	BRIGHT
WOBLING	OFF
PEAK LIMIT	OFF

SCREENSAVER	
PRESENT TIME OF DAY 15:00	
START	
FUNCTION	WHITE BAR SCROLL
MODE	INTERVAL
SHOW DURATION	◀ 12:00 ▶
SAVER DURATION	◀ 3:00 ▶
SIDE BAR ADJUST	BRIGHT
WOBLING	OFF
PEAK LIMIT	OFF

**Note:** Timer function will not work unless "PRESENT TIME OF DAY" is set.

## Reduces screen image retention

These functions prevent the occurrence of an "image retention" on the display when turned ON.

**WOBLING:** Automatically shifts the display image (therefore unnoticeable to the eye) to prevent image retention of sharper contour of image.

ON1: Shifts the image every 30 seconds.

ON2: Shifts the image at a dot level pitch depending on screen-detection.

**PEAK LIMIT:** Suppresses image contrast (peak brightness).

**Note:** When a still picture is viewed for an extended time, the screen may become slightly darker. (see page 46)

- SET UP  
Press to display the SET UP menu.
- Press to select "SCREENSAVER".
- Press to display SCREENSAVER menu.
- Press to select "WOBLING" or "PEAK LIMIT".
- Press to select "ON1", "ON2" or "OFF" (WOBLING).  
"ON" or "OFF" (PEAK LIMIT).

SET UP		2/2
SCREENSAVER		
MULTI DISPLAY SETUP		
SET UP TIMER		
PRESENT TIME SETUP		

SCREENSAVER	
PRESENT TIME OF DAY 99:99	
START	
FUNCTION	WHITE BAR SCROLL
MODE	OFF
START TIME	6:15
FINISH TIME	12:30
SIDE BAR ADJUST	BRIGHT
WOBLING	◀ OFF ▶
PEAK LIMIT	◀ OFF ▶

## SIDE BAR ADJUST

Do not display a picture in NORMAL mode for an extended period, as this can cause an image retention to remain on the side bars on either side of the display field.

To reduce the risk of such an image retention, change the brightness of the side bars.

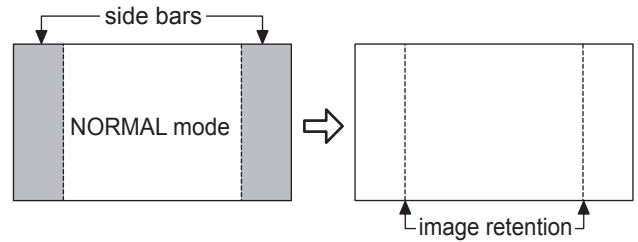

This function may be applicable to the non-picture area.

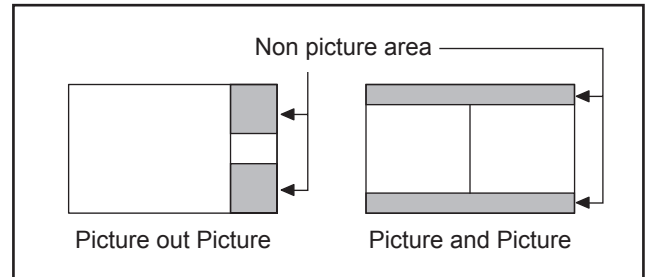

Display the SCREENSAVER screen.

(Refer to the previous page, operation guide steps 1 and 2)

1

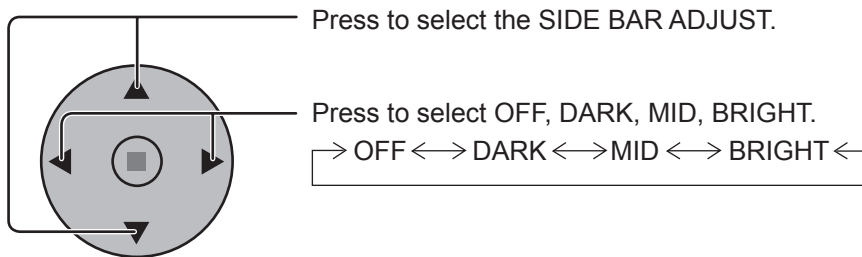

SCREENSAVER	
PRESENT TIME OF DAY	99:99
START	----
FUNCTION	WHITE BAR SCROLL
MODE	OFF
START TIME	6:15
FINISH TIME	12:30
SIDE BAR ADJUST	◀ BRIGHT ▶
WOBBLING	OFF
PEAK LIMIT	OFF

2

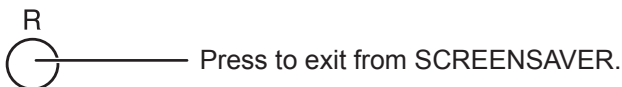

### Notes:

- To reduce the occurrence of image retention, set the SIDE BAR ADJUST to BRIGHT.
- The side bar may flash (alternate black/white) depending on the picture being shown on the screen. Using Cinema mode will reduce such flashing.

# Reduces power consumption

- **POWER SAVE:** When this function is turned ON, luminous level of the Plasma Display is suppressed, so power consumption is reduced.
- **STANDBY SAVE:** When this function is turned ON, power consumption of the microcomputer is reduced during power supply standby (see page 13-15), so standby power of the set is reduced.
- **POWER MANAGEMENT:** The unit power supply is turned ON or OFF depending on whether or not there is a signal during PC input mode. This function is enabled when it is turned ON. (Only during input from PC(Mini D-sub) terminal)
- **AUTO POWER OFF:** Equipment power supply is turned OFF when there is no signal. When this is set to On, the power supply of the unit goes Off 10 minutes after the input signals stop. This function is effective for input signals except input from PC (Mini D-sub) terminal.

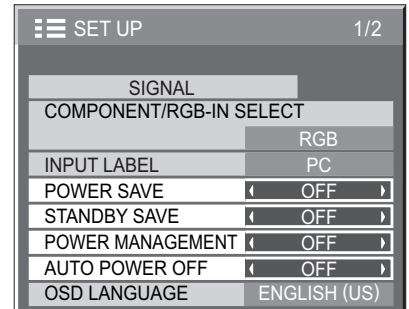
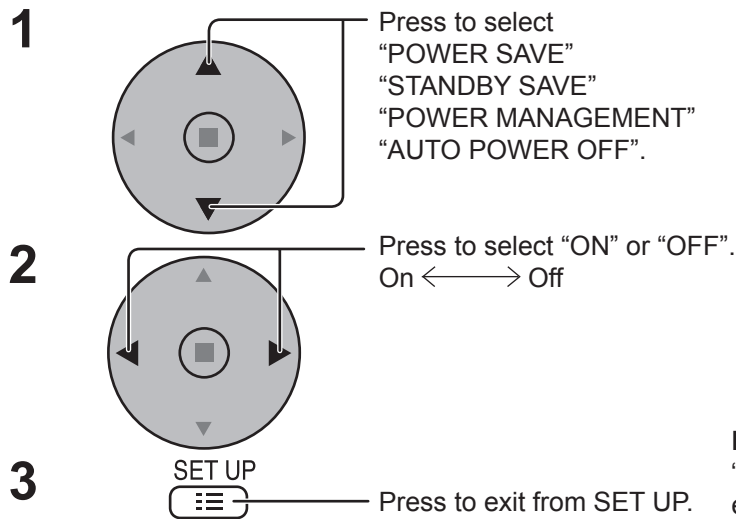

**Note:** "POWER MANAGEMENT" and "AUTO POWER OFF" are effective during normal viewing (one picture screen) only.

## Customizing the Input labels

This function can change the label of the Input signal to be displayed. Select the input signal which you would like to change its label before customizing the Input labels. (see page 15, 18)

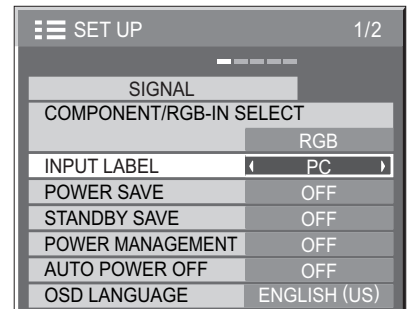
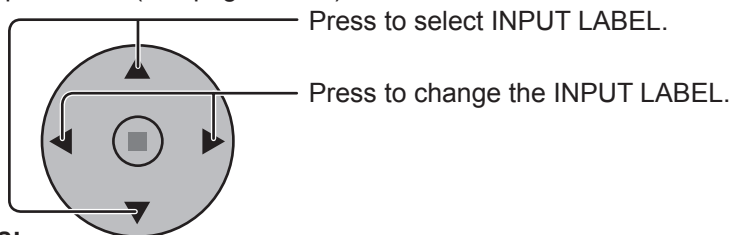

**Notes:**

- While selecting a Input signal through Optional Terminal Board connected to Slot 1, Slot 2 and Slot 3, the Input label will depend on each Optional Terminal Board.
- Setting of SLOT3 is not available on TH-37PH10UK.

INPUT LABELS for Slot 1, Slot 2, Slot 3 and Mini D-sub:

[Slot1 Input]	INPUT1/VIDEO1/COMPONENT1/RGB1/DIGITAL1/PC1/DVD1/CATV1/VCR1/STB1
[Slot2 Input]	INPUT2/VIDEO2/COMPONENT2/RGB2/DIGITAL2/PC2/DVD2/CATV2/VCR2/STB2
[Slot3 Input]	INPUT3/VIDEO3/COMPONENT3/RGB3/PC3/DVD3/CATV3/VCR3/STB3
[PC (Mini D-sub) input]	PC/COMPONENT/RGB/DVD/STB

When BNC Dual Video Terminal Board (TY-FB9BD) is used, an "A" or "B" is added at the end of each input label, depending on the input selected (see below).

<b>Addition sign</b>	"A"	"B"
<b>Selected Input</b>	Composite	S VIDEO



# SET UP for MULTI DISPLAY

By lining up Plasma Displays in groups, for example, as illustrated below, an enlarged picture may be displayed across all screens.

For this mode of operation, each plasma display has to be set up with a Display number to determine its location.  
(Example)

group of 4 (2 × 2)



group of 9 (3 × 3)



group of 16 (4 × 4)



(see page 34 for more displays lineups.)

## How to setup MULTI DISPLAY

1



Press to display the SET UP menu.

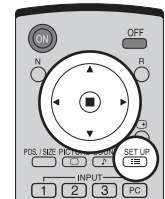

2

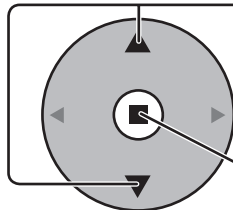

Press to select the MULTI DISPLAY SETUP.

Press to display the "MULTI DISPLAY SETUP" menu.

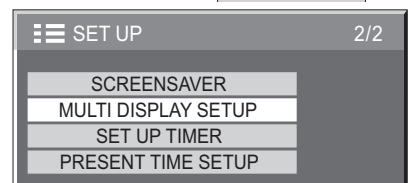

3

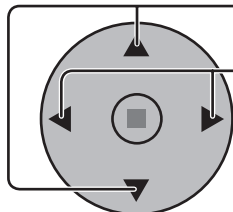

Press to select the MULTI DISPLAY SETUP.

Press to select "ON" or "OFF".

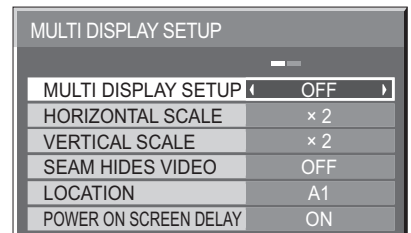

## How to set the Display location number for each Plasma Display

4

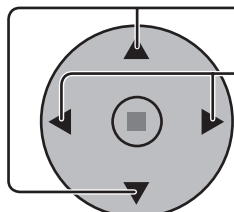

Press to select HORIZONTAL SCALE.

Press to select "× 1", "× 2", "× 3", "× 4".

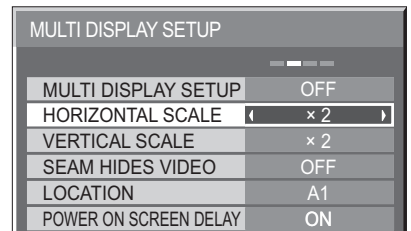

5

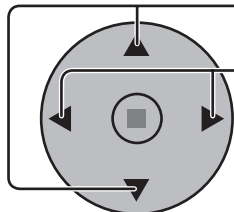

Press to select VERTICAL SCALE.

Press to select "× 1", "× 2", "× 3", "× 4".

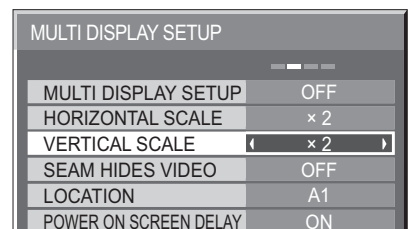

# SET UP for MULTI DISPLAY

**6**

Press to select SEAM HIDES VIDEO.

Press to select "OFF", "ON".

MULTI DISPLAY SETUP	
MULTI DISPLAY SETUP	OFF
HORIZONTAL SCALE	× 2
VERTICAL SCALE	× 2
SEAM HIDES VIDEO	OFF
LOCATION	A1
POWER ON SCREEN DELAY	ON

**7**

Press to select LOCATION.

Press to select the required arrangement number. (A1-D4 : Refer to the following)

MULTI DISPLAY SETUP	
MULTI DISPLAY SETUP	ON
HORIZONTAL SCALE	× 2
VERTICAL SCALE	× 2
SEAM HIDES VIDEO	OFF
LOCATION	A1
POWER ON SCREEN DELAY	ON

**Display Number locations for each arrangement.**  
(Examples)

( 2 × 1 )		( 2 × 3 )		( 4 × 2 )				( 4 × 4 )			
A1	A2	A1	A2	A1	A2	A3	A4	A1	A2	A3	A4
		B1	B2	B1	B2	B3	B4	B1	B2	B3	B4
		C1	C2					C1	C2	C3	C4
								D1	D2	D3	D4

## 8 POWER ON SCREEN DELAY

Turning the power on for the multiple displays system, each display is turned on with a time lag to reduce the power load.

Press to select POWER ON SCREEN DELAY.

Press to select OFF or ON.

OFF: All the display turns on simultaneously.  
ON: Each display turns on in the order of LOCATION.  
Delay time=LOCATION (difference from A1) × 1 sec.  
Example) Case of B2 in 4 × 2 → A1, A2, A3, A4, B1, B2 → 5 sec.

MULTI DISPLAY SETUP	
MULTI DISPLAY SETUP	ON
HORIZONTAL SCALE	× 2
VERTICAL SCALE	× 2
SEAM HIDES VIDEO	OFF
LOCATION	A1
POWER ON SCREEN DELAY	ON



### Notes:

- This setting is valid when MULTI DISPLAY SETUP is ON.
  - During this function is working, the power indicator is blinking green.
  - This function also works when the power recovers from failure or after plugging off and in again the power cord.
- If unplugging and plugging the power cord while the unit is in standby mode and the power is being supplied to the board, each unit has time delay to start supplying the power to the attached board according to LOCATION, and the power indicator lights up red first and it turns orange when the power starts being supplied to the board.

**9**









Press twice to exit from SET UP.

## SEAM HIDES VIDEO Setting

<b>Reference</b>	To hide joints between displays.	To show joints between displays.
	 Suitable for moving image display.	 Suitable for still image display.
Step 6, Page 34	ON	OFF

## ID Remote Control Function

You can set the remote control ID when you want to use this remote control on one of several different displays.

- 1 Switch  to  on the right side.
- 2 Press the  button on the remote control.
- 3 Press one of  - ,  for the tens digit setting.
- 4 Press one of  - ,  for the units digit setting.

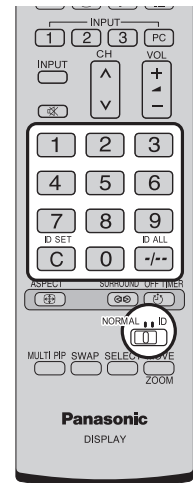

### Notes:

- The numbers in 2, 3 and 4 should be set up quickly.
- Adjustable ID number range is 0 - 99.
- If a number button is pressed more than two times, the first two numbers become the ID number for the remote control.

### ID remote control button operation

The operation is the same as normal remote control except for the  button.

### ID Cancellation

Press  button on remote control. (This has the same effect as pressing the , ,  buttons at the same time.)

### Notes:

- Set the Remote ID "On" to operate the ID remote control.  
If Remote ID is set to "On", you can use the remote control without identical ID number during option menu display. (see page 41)
- The ID remote control cannot be used when ID select is set to anything other than 0, and the remote control ID is not the same as the ID select number (see page 41).

# SET UP for Input Signals

## COMPONENT / RGB IN SELECT

Select to match the signals from the source connected to the COMPONENT / RGB input terminals.

Y, P<sub>B</sub>, P<sub>R</sub> signals ⇒ "COMPONENT"

R, G, B, HD, VD signals ⇒ "RGB"

1



Press to display the SET UP menu.

2

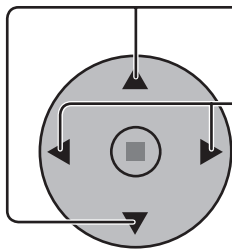

Press to select the "COMPONENT / RGB-IN SELECT".

Press to select the desired mode.  
COMPONENT ← → RGB

3



Press to exit from adjust mode.

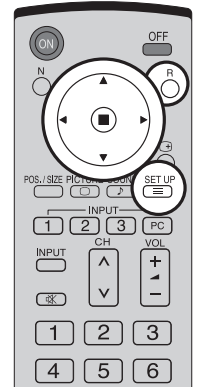

SET UP 1/2	
SIGNAL	
COMPONENT/RGB-IN SELECT	RGB
INPUT LABEL	PC
POWER SAVE	OFF
STANDBY SAVE	OFF
POWER MANAGEMENT	OFF
AUTO POWER OFF	OFF
OSD LANGUAGE	ENGLISH (US)

### Notes:

- Selection may not be possible, depending on which optional board is installed.
- Make setting of the selected input terminal (SLOT1, SLOT2, SLOT3 or PC IN). (Setting of SLOT3 is not available on TH-37PH10UK.)

## 3D Y/C FILTER – For NTSC AV images

Select "SIGNAL" from the "SET UP" menu during VIDEO (S VIDEO) input signal mode.

("SIGNAL [VIDEO]" menu is displayed.)

1

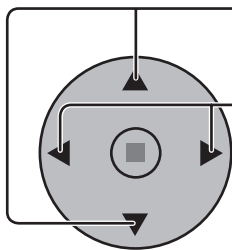

Press to select the "3D Y/C FILTER (NTSC)".

Press to set ON / OFF.

2



Press to exit from adjust mode.

SET UP 1/2	
SIGNAL	
COMPONENT/RGB-IN SELECT	RGB
INPUT LABEL	PC
POWER SAVE	OFF
STANDBY SAVE	OFF
POWER MANAGEMENT	OFF
AUTO POWER OFF	OFF
OSD LANGUAGE	ENGLISH (US)

↓ Press ACTION (■) button

SIGNAL [ VIDEO ]	
3D Y/C FILTER (NTSC)	ON
COLOR SYSTEM	AUTO
3 : 2 PULLDOWN	OFF
Panasonic AUTO (4 : 3)	NORMAL
VIDEO NR	OFF

### Note:

When ON, this setting only affects NTSC input signals.

# COLOR SYSTEM / Panasonic AUTO

Select SIGNAL from the “SET UP” menu during VIDEO (S VIDEO) input signal mode. (“SIGNAL [VIDEO]” menu is displayed.)

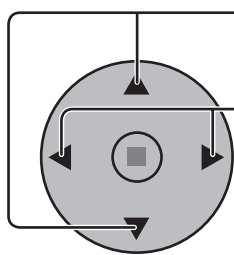

Press to select the “COLOR SYSTEM” or “Panasonic AUTO”.

Press to select each function.

**If the image becomes unstable:**

With the system set on Auto, under conditions of low level or noisy input signals the image may in rare cases become unstable. Should this occur, set the system to match the format of the input signal.

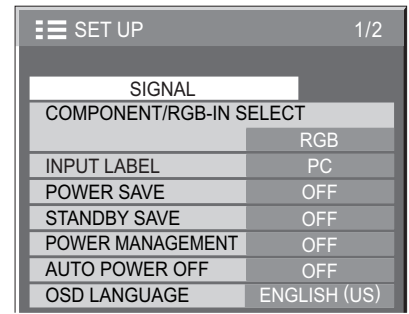

Press ACTION (■) button

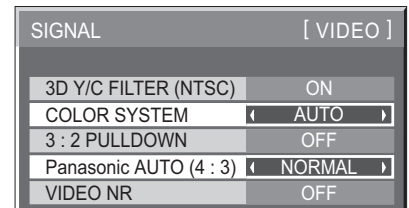

Mode	Function
<b>COLOR SYSTEM</b>	Set the color system to match the input signal. When selecting “AUTO”, the color system is automatically selected from NTSC/PAL/SECAM, however, M.NTSC signal is not displayed properly depending on the attached terminal board. To display M.NTSC signal, select “M.NTSC” in COLOR SYSTEM. <div style="text-align: center;"> <span style="border: 1px solid black; padding: 2px;">→ AUTO ↔ PAL ↔ SECAM ↔ M.NTSC ↔ NTSC ←</span> </div>
<b>Panasonic AUTO (4 : 3)</b>	Set to “NORMAL” to view 4:3 images in an unchanged format when Panasonic AUTO is selected. If you would like to view 4:3 images in Just format, set to “JUST”.

**Note:**

Panasonic AUTO does not function when BNC Dual Video Terminal Board (TY-FB9BD) is used.

# 3:2 PULLDOWN / VIDEO NR

**3:2 PULLDOWN:** When ON, the display attempts to reproduce a more natural interpretation of sources such as movie pictures, which are recorded at 24 frames per second. If the picture is not stable, turn the setting to OFF.

**Notes:**

When ON, this setting only affects the following signal input:

- NTSC / PAL signal input during “VIDEO (S VIDEO)” input signal.
- 525i(480i), 625i(575i), 1125(1080)/60i signal input during “COMPONENT” input signal.

**VIDEO NR:** Automatically reduces unwanted picture noise.

**Note:**

VIDEO NR cannot be adjusted while a PC signal is being applied.

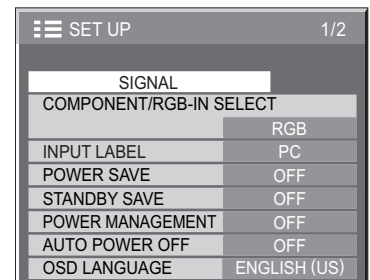

Press ACTION (■) button

**1** Press to select 3:2 PULLDOWN or VIDEO NR. Press to set ON/OFF.

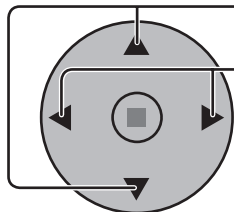

R

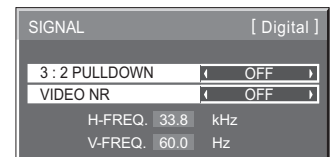
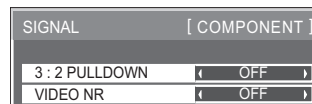
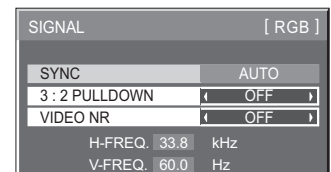
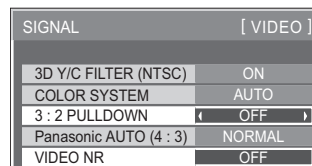

**2** Press to exit from adjust mode.



# SET UP for Input Signals

## SYNC

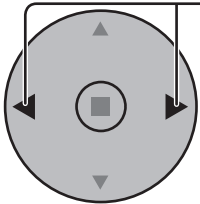
Select SIGNAL from the "SET UP" menu during RGB input signal.

- 1  Press to adjust.
- 2  Press to exit from adjust mode.

### Setting RGB sync signal

Confirm that the input is set to RGB INPUT (this setting is valid only for RGB INPUT signal).

- AUTO: The H and V sync or synchronized signal are automatically selected. If both input, it is selected the H and V sync.
- ON G: Uses a synchronized signal on the Video G signal, which is input from the G connector.
- VBS: Uses a synchronized signal of Composite Sync input, which is input from the HD connector.

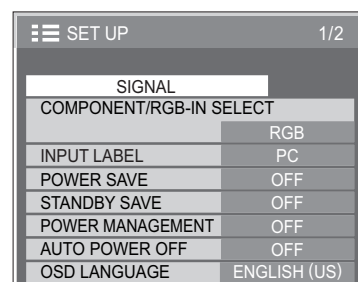

Press ACTION (■) button

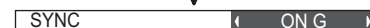
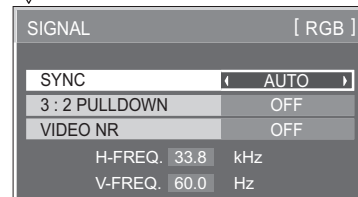

## REFRESH RATE

This function sets the refresh rate of the display.



This menu is displayed when the input signal is 50 Hz system (50i, 50p, 25p, 24p, 24sF) of vertical scan rate.

100 Hz: Reduce screen flicker.

50 Hz: Enhance the resolution of moving images.

### Note:

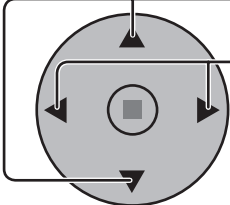
It is recommended to set to 100 Hz normally.

- 1  Press to select REFRESH RATE.  
Press to adjust.
- 2  Press to exit from adjust mode.

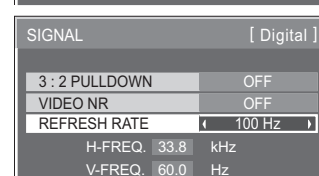
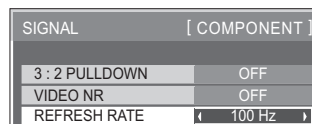
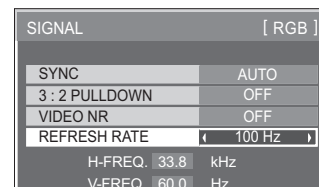
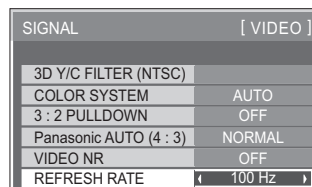

## H-FREQ. (kHz) / V-FREQ. (Hz)

Displays the H (Horizontal) / V (Vertical) frequencies.





This display is valid only for RGB/PC and Digital input signal.

Display range:

- Horizontal 15 - 110 kHz
- Vertical 48 - 120 Hz

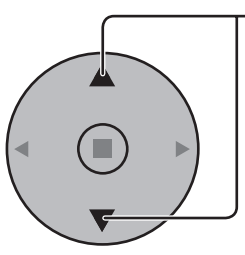
H-FREQ.	33.8	kHz
V-FREQ.	60.0	Hz

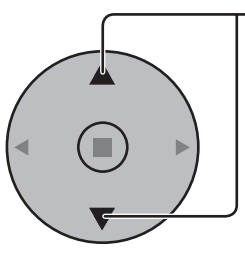
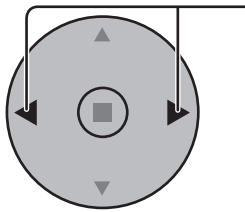
# Options Adjustments



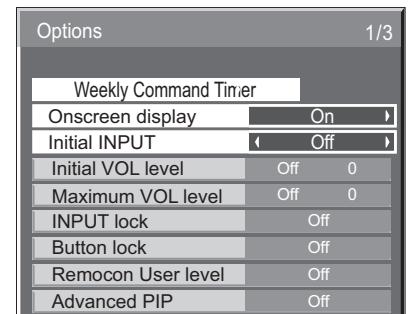
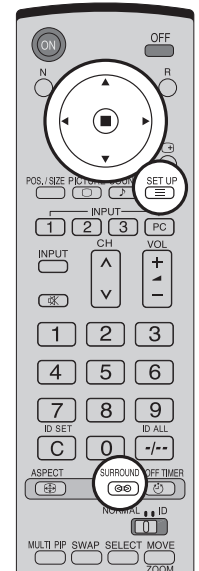





























- 1  Press to display the Setup menu.
- 2  Press to select "OSD Language".
- 3  Press and hold until the Options menu is displayed.
- 4  Press to select your preferred menu.
- 5  Press to adjust the menu.
- 6  Press to exit from Options menu.



Item	Effect	Adjustments
Weekly Command Timer	—	Sets Weekly Command Timer. (see page 43)
Onscreen display	◀ On ▶ Off	<p><b>On:</b> Displays all the following on screen.</p> <ul style="list-style-type: none"> <li>• Power on display</li> <li>• Input signal switch display</li> <li>• No signal display</li> <li>• Mute and the remaining time of off-timer after  was pressed.</li> </ul> <p><b>Off:</b> Hides all the items above from view.</p>
Initial INPUT	◀ ▶	<p><b>Off &lt;=&gt; PC &lt;=&gt; INPUT1 &lt;=&gt; INPUT2 &lt;=&gt; INPUT3</b></p> <p>Adjusts the input signal when the unit is turned on.</p> <p><b>Notes:</b></p> <ul style="list-style-type: none"> <li>• Only the adjusted signal is displayed. (see page 18).</li> <li>• Signal can be displayed when the Terminal board is installed.</li> <li>• This menu is available only when "INPUT lock" is "Off".</li> <li>• When a dual input terminal board is attached, A or B is displayed depending on the selected input signal. (Ex. INPUT1A, INPUT1B)</li> <li>• Setting of SLOT3 is not available on TH-37PH10UK.</li> </ul>



# Options Adjustments

Options		1/3
Weekly Command Timer		
Onscreen display	On	
Initial INPUT	Off	
Initial VOL level	Off	0
Maximum VOL level	Off	0
INPUT lock	Off	
Button lock	Off	
Remocon User level	Off	
Advanced PIP	Off	

Item	Effect	Adjustments
Initial VOL level	◀ Off ▶ On	<p>Press  button to adjust the volume when the unit is turned on.</p> <p><b>Off</b> ↔ <b>On</b>  <b>Off:</b> Sets normal volume.  <b>On:</b> Sets your preferred volume.</p> <p><b>Notes:</b></p> <ul style="list-style-type: none"> <li>• When "Maximum VOL level" is "On", the volume can only be adjusted between 0 and your maximum range.</li> <li>• You can hear the changed volume regardless of your volume setting before opening the options menu if you adjust the volume when "Initial VOL level" is "On" and cursor is on the menu.</li> </ul>
Maximum VOL level	◀ Off ▶ On	<p>Press  button to adjust the maximum volume.</p> <p><b>Off</b> ↔ <b>On</b>  <b>Off:</b> Sets auto maximum volume.  <b>On:</b> Sets your preferred maximum volume.</p> <p><b>Notes:</b></p> <ul style="list-style-type: none"> <li>• If the "Maximum VOL level" is set lower than the "Initial VOL level", the "Initial VOL level" automatically becomes the same as the "Maximum VOL level".</li> <li>• The volume display can go up to 63 regardless of the settings.</li> <li>• You can hear the changed volume regardless of your volume setting before opening the options menu if you adjust the volume when "Maximum VOL level" is "On" and cursor is on the menu.</li> </ul>
INPUT lock	◀ ▶	<p><b>Off</b> ↔ <b>PC</b> ↔ <b>INPUT1</b> ↔ <b>INPUT2</b> ↔ <b>INPUT3</b>  Locks the input switch operation.</p> <p><b>Notes:</b></p> <ul style="list-style-type: none"> <li>• Only the adjusted signal is displayed (see page 18).</li> <li>• Signal can be displayed when the Terminal board is installed.</li> <li>• Input switch can be used when this is set to "Off".</li> <li>• In two screen display mode, if anything other than "Off" is set, the value will be fixed as the value input in the single screen display mode.</li> <li>• When a dual input terminal board is attached, A or B is displayed depending on the selected input signal. (Ex. INPUT1A, INPUT1B)</li> <li>• Setting of SLOT3 is not available on TH-37PH10UK.</li> </ul>
Button lock	◀ ▶	<p><b>Off</b> ↔ <b>MENU&amp;ENTER</b> ↔ <b>On</b>  <b>Off:</b> All the buttons at the bottom of the main unit can be used.</p> <p><b>MENU &amp; ENTER:</b> Locks  and  buttons on bottom face of main unit.</p> <p><b>On:</b> Locks all the button on bottom face of main unit.  Sets Button lock with the unit buttons in the following procedure.</p> <p><b>Off:</b> Press  four times → Press  four times → Press  four times → Press  four times</p> <p><b>MENU &amp; ENTER:</b> Press  four times → Press  four times → Press  four times → Press  four times</p> <p><b>On:</b> Press  four times → Press  four times → Press  four times → Press  four times</p>
Remocon User level	◀ ▶	<p><b>Off</b> ↔ <b>User1</b> ↔ <b>User2</b> ↔ <b>User3</b>  <b>Off:</b> You can use all of the buttons on the remote control.</p> <p><b>User1:</b> You can only use , , , , , , , , , ,  buttons on the remote control.</p> <p><b>User2:</b> You can only use , , buttons on the remote control.</p> <p><b>User3:</b> Locks all the buttons on remote control.</p>
Advanced PIP	◀ Off ▶ On	<p><b>Off:</b> Sets normal two screen display mode (see page 21).  <b>On:</b> Sets Advanced PIP mode (see page 22).</p> <p><b>Notes:</b></p> <ul style="list-style-type: none"> <li>• When "INPUT lock" is "On", you cannot use all the two screen display functions.</li> <li>• , ,  buttons are unavailable during Advanced PIP mode operation.</li> </ul>



Options		2/3
Off-timer function	Enable	▶
Initial Power Mode	Normal	▶
ID select	0	▶
Remote ID	Off	▶
Serial ID	Off	▶
Display size	Off	▶
Studio W/B	Off	▶
Studio Gain	Off	▶

Item	Effect	Adjustments
<b>Off-timer function</b>	◀ ▶ Enable Disable	<p><b>Enable:</b> Enables the “Off-timer function”.</p> <p><b>Disable:</b> Disables the “Off-timer function”.</p> <p><b>Note:</b> When “Disable” is set, the Off-timer is cancelled.</p>
<b>Initial Power Mode</b>	◀ ▶	<p><b>Normal</b> ↔ <b>Standby</b> ↔ <b>On</b></p> <p>Sets the power mode of the unit for when the power recovers from failure or after plugging off and in again.</p> <p><b>Normal:</b> Power returns in as the same state as before the power interruption.</p> <p><b>Standby:</b> Power returns in standby mode. (Power Indicator : red/orange)</p> <p><b>On:</b> Power returns in power On. (Power Indicator : green)</p> <p><b>Note:</b> When using multiple displays, “Standby” is preferred to be set in order to reduce a power load.</p>
<b>ID select</b>	◀ ▶	<p>Sets panel ID number when panel is used in “Remote ID” or “Serial ID”.</p> <p>Set value range: 0 - 100</p> <p>(Standard value: 0)</p>
<b>Remote ID</b>	◀ ▶ Off On	<p><b>Off:</b> Disables ID remote control functions. You can use normal remote control operations.</p> <p><b>On:</b> Enable ID remote control functions.</p>
<b>Serial ID</b>	◀ ▶ Off On	<p>Sets the panel ID Control.</p> <p><b>Off:</b> Disables external control by the ID.</p> <p><b>On:</b> Enables the external control by the ID.</p>
<b>Display size</b>	◀ ▶ Off On	<p>Adjusts the image display size on screen.</p> <p><b>Off:</b> Sets the normal image display size on screen.</p> <p><b>On:</b> Sets the image display size approximately 95 % of the normal image display.</p> <div style="display: flex; justify-content: space-around; align-items: center;"> <div style="text-align: center;"> <p><b>Off</b></p>  </div> <div style="text-align: center;"> <p><b>On</b></p>  </div> </div> <p><b>Notes:</b></p> <ul style="list-style-type: none"> <li>• This setting is valid only when the input signals are as follows; NTSC, PAL, SECAM, M.NTSC, PAL60, PAL-M, PAL-N (BNC Dual Video Terminal Board (TY-FB9BD)) 525i, 525p, 625i, 625p, 750/60p, 750/50p, 1125/60i, 1125/50i, 1125/24sF, 1125/25p, 1125/24p, 1125/30p, 1250/50i (Component Video, RGB, DVI, SDI, HDMI)</li> <li>• This setting is invalid when two screen display, digital zoom or Multi screen is selected.</li> <li>• When “Display size” is set to “On”, “POS. /SIZE” adjustment cannot be used.</li> <li>• Refer to each board’s operating instruction for DVI, SDI, HDMI’s corresponding signals.</li> </ul>
<b>Studio W/B</b>	◀ ▶ Off On	<p><b>Off:</b> Nullify all the settings adjusted.</p> <p><b>On:</b> Sets the color temperature for TV studio.</p> <p><b>Note:</b> Valid only when the low is set as color temperature on screen adjustment.</p>
<b>Studio Gain</b>	◀ ▶ Off On	<p>Sharpens the contrast for a better view when a part of the image is too light to see.</p> <p><b>Off:</b> Disables “Studio Gain”.</p> <p><b>On:</b> Enables “Studio Gain”.</p> <p><b>Note:</b> This setting is valid only when the input signals are as follows: Component Video, RGB (analog), SDI, HDMI</p>



# Options Adjustments

Options		3/3
Slot power	◀ Off ▶	
V. Installation	Off ▶	
Rotate	Off ▶	
Serial Slot Select	◀ Slot1 ▶	

Item	Effect	Adjustments
Slot Power	◀ ▶	<b>Off ↔ Auto ↔ On</b> <b>Off:</b> Power is not transmitted to the slot power. <b>Auto:</b> Power is transmitted to the slot power only when main power is on. <b>On:</b> Power is transmitted to the slot power when main power is on or in the standby state. <b>Note:</b> In some cases, power is transmitted to the slot power when main power is on or in the standby state regardless of the slot power setting.
V.Installation	◀ Off ▶ On	<b>Off:</b> Sets fan to the horizontal installation mode. <b>On:</b> Sets fan to the vertical installation mode. <b>Notes:</b> <ul style="list-style-type: none"> <li>• This functions when display is turned on.</li> <li>• This mode is available for TH-42PH10UK, TH-50PH10UK and TH-58PH10UK.</li> <li>• Turn up the power switch for the upward direction when you set Display vertically.</li> </ul>
Rotate	◀ Off ▶ On	<b>Off:</b> Does not rotate the image. <b>On:</b> Rotates the image 180 degrees.
Serial Slot Select	◀ ▶	<b>Slot1 ↔ Slot2 ↔ Slot3</b> Selects the slot which communicates serial. <b>Notes:</b> <ul style="list-style-type: none"> <li>• The setting of an external command can be set only from the fixed serial terminal (see page 11)</li> <li>• Slot3 cannot be selected on TH-37PH10UK.</li> </ul>

## Normalization

When both main unit buttons and remote control are disabled due to the "Button lock", "Remocon User level" or "Remote ID" adjustments, set all the values "Off" so that all the buttons are enabled again.

Press the  button on main unit together with  button on the remote control and hold for more than 5 seconds. The "SHIPPING" menu is displayed and the lock is released when it disappears.

# Weekly Command Timer

You can set 7-day timer programming by setting time and command.

**Note:**

Before setting Weekly Command Timer, set PRESENT TIME SETUP. (see page 27)

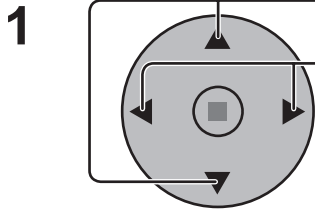

Press to select Function.  
 Press to select "On".

**Note:**  
 • When Function is set to On, SET UP TIMER (see page 28) is unavailable and INTERVAL / TIME OF DAY in MODE of SCREENSAVER (see page 29) cannot be selected.



↓ Press ACTION (■) button

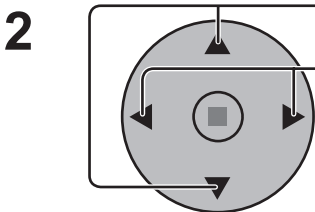
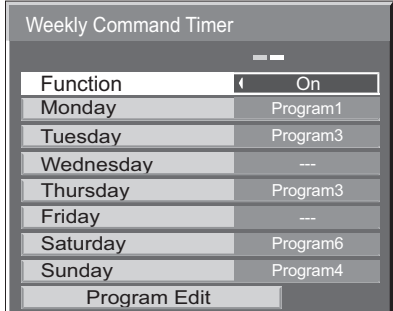

Press to select a day.  
 Press to select a program number.

**Note:**  
 • You can set the program from 1 to 7. --- indicates unset.

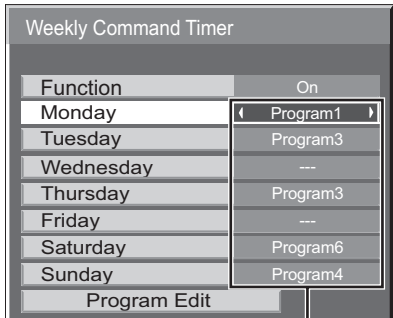

Program number

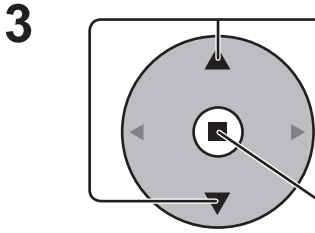

Press to select Program Edit.  
 Press to show the Program Edit screen.

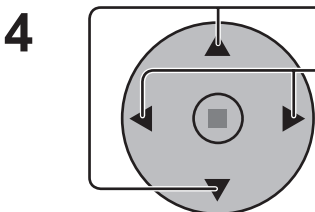
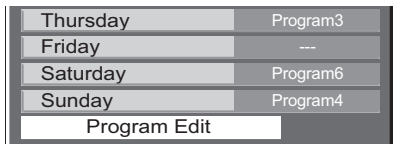

Press to select Program.  
 Press to change the program numbers (1-7).

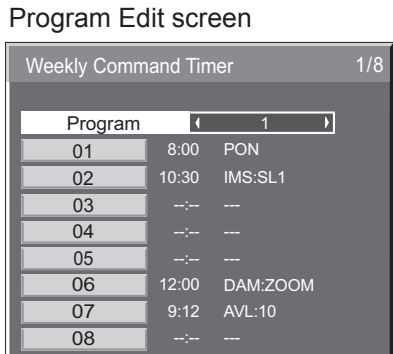

# Options Adjustments

5

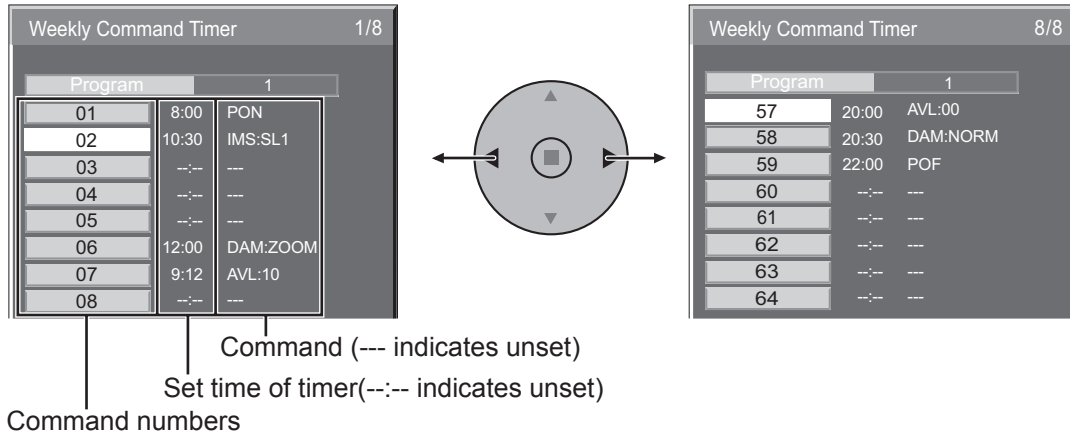
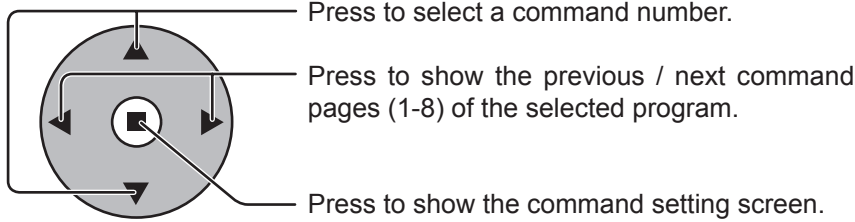

6

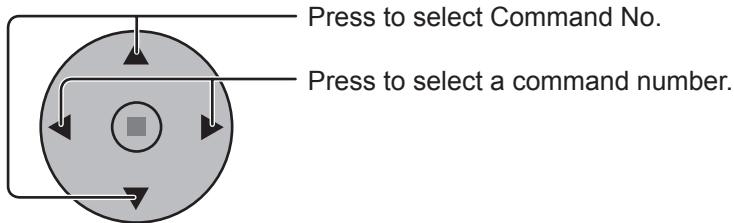

Command setting screen

Program		1
Command No	◀	02 ▶
Time		10:30
Command		IMS:SL1

7

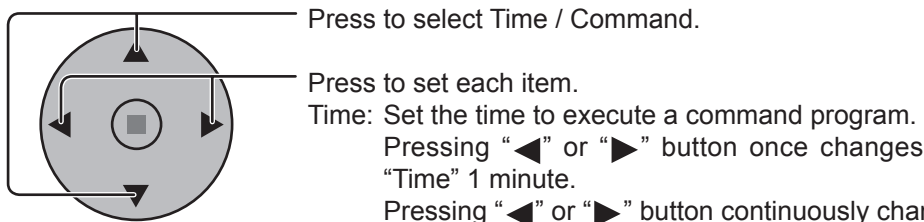

Program		1
Command No		02
Time	◀	10:30 ▶
Command	◀	IMS:SL1 ▶

Time: Set the time to execute a command program.  
Pressing “◀” or “▶” button once changes “Time” 1 minute.  
Pressing “◀” or “▶” button continuously changes “Time” by 15 minutes.  
Command: Select a command to execute at the set time. This unit has 64 commands to set. (see page 48)

**Notes:**

- Command is performed in order of execution time, regardless of the command number.
- If a command execution time overlaps with that of other commands, these commands are performed in number order.
- Pressing  $\bigcirc^N$ , Time becomes --:-- and Command becomes ---.

**Note:**

- Press  $\bigcirc^R$  to return to the previous screen.

# Shipping condition

This function allows you to reset the unit to the factory setting.

1

 Press to display the SET UP menu.

2

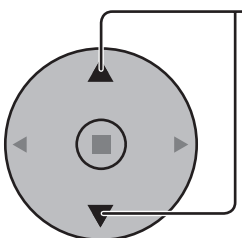
 Press to select "OSD LANGUAGE".

3

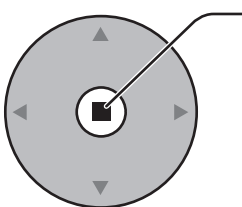
 Press and hold till the SHIPPING menu is displayed.

4

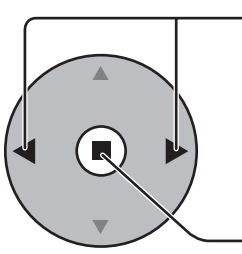
 Press to select "YES".

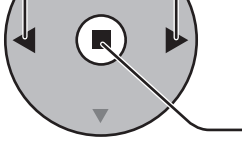
 Press to confirm.

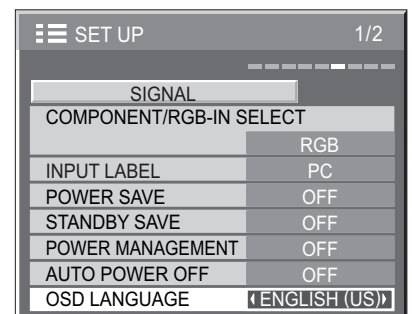
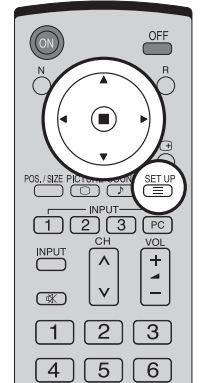

SHIPPING	YES
----------	-----

[from the unit]











- 1 Press the MENU button till the Setup menu is displayed.
- 2 Press the Volume Up "+" or Down "-" button to select "OSD LANGUAGE".
- 3 Press and hold the ENTER button till the SHIPPING menu is displayed.
- 4 Press the Volume Up "+" or Down "-" button to select "YES".
- 5 Press the ENTER button and wait for 10 sec.

**Note:**

Press the R button to return to SET UP menu when SHIPPING menu is displayed.

# Troubleshooting

Before you call for service, determine the symptoms and make a few simple checks as shown below.

Symptoms		Checks
Picture	Sound	
 Interference	 Noisy Sound	Electrical Appliances Cars / Motorcycles Fluorescent light
 Normal Picture	 No Sound	Volume (Check whether the mute function has been activated on the remote control.)
 No Picture	 No Sound	Not plugged into AC outlet Not switched on PICTURE and BRIGHTNESS/Volume setting (Check by pressing the power switch or stand-by button on the remote control.)
 No Picture	 Normal Sound	If a signal with a non-applicable color system format, or frequency is input, only the input terminal indication is displayed.
 No Color	 Normal Sound	Color controls set at minimum level. (see page 23, 24) COLOR SYSTEM (see page 37)
No remote control operations can be performed.		Check whether the batteries have discharged completely and, if they have not, whether they were inserted properly. Check whether the remote control sensor is exposed to an outdoor light or a strong fluorescent light. Check whether the remote control designed specifically for use with the unit is being used. (The unit cannot be operated by any other remote control.)
A cracking sound is sometimes heard from the unit.		If there is nothing wrong with the picture or sound, this is the sound of the cabinet undergoing very slight contractions in response to changes in the room temperature. There are no adverse effects on the performance or other aspects.
The top or bottom of the picture on the screen is cut off when I use the zoom function.		Adjust the position of the picture on the screen.
Areas at the top and bottom of the screen where the image is missing appear when I use the zoom function.		When using a video software program (such as a cinema size program) with a screen wider than one in the 16:9 mode, blank areas separate from the images are formed at the top and bottom of the screen.
I can hear sounds coming from inside the unit.		When the power is turned on, a sound of the display panel being driven may be heard: This is normal and not indicative of malfunctioning.
This Plasma Display uses special image processing. Hence a slight time lag may occur between image and audio, depending on the type of input signal. However, this is not a malfunction.		

## Plasma Display panel

Symptoms	Check
The screen darkens slightly when bright pictures with minimal movements are shown.	The screen will darken slightly when photos, still images of a computer or other pictures with minimal movements are shown for an extended period. This is done to reduce image retention on the screen and the shortening of the screen's service life: It is normal and not indicative of malfunctioning.
It takes a while for the picture to appear.	The unit digitally processes the various signals in order to reproduce esthetically pleasing images. As such, it sometimes takes a few moments for the picture to appear when the power has been turned on, when the input has been switched or when the images for the main picture and sub picture on the two screens are swapped.
The edges of the images flicker.	Due to the characteristics of the system used to drive the panel, the edges may appear to flicker in the fast-moving parts of the images: This is normal and not indicative of malfunctioning.
The brightness on both sides of images in NORMAL mode changes.	When viewing the side panels at the "BRIGHT" or "MID" setting, the brightness on both sides may change depending on the kind of program shown: This is normal and not indicative of malfunctioning.
Some parts of the screen do not light up.	The plasma display panel is manufactured using an extremely high level of precision technology, however, sometimes some parts of the screen may be missing picture elements or have luminous spots. This is not a malfunction.
 <p>Image retention appears</p>	Do not allow a still picture to be displayed for an extended period, as this can cause a permanent image retention to remain on the Plasma Display. Examples of still pictures include logos, video games, computer images, teletext and images displayed in NORMAL mode. <b>Note:</b> The permanent image retention on the Plasma Display resulting from fixed image use is not an operating defect and as such is not covered by the Warranty. This product is not designed to display fixed images for extended periods of time.
[For TH-42PH10UK, TH-50PH10UK, TH-58PH10UK] Whirring sounds can be heard from the display unit.	The display unit is fitted with a cooling fan to dissipate heat generated during normal use. The whirring sound is caused by rotation of the fan and is not a malfunction.

# VIDEO/COMPONENT/RGB/PC input signals

## VIDEO input

	Signal name	Horizontal frequency(kHz)	Vertical frequency(Hz)
1	NTSC	15.73	59.94
2	PAL	15.63	50.00
3	PAL60	15.73	59.94
4	SECAM	15.63	50.00
5	Modified NTSC	15.73	59.94

## Applicable input signals for Component / Mini D-sub 15P (Component) / RGB / Mini D-sub 15P (RGB) (\* Mark)

	Signal name	Horizontal frequency (kHz)	Vertical frequency (Hz)	Dot clock frequency (MHz)	Component / Mini D-sub 15P (Component)	RGB / Mini D-sub 15P (RGB)
1	525 (480) / 60i	15.73	59.94	13.5	*	*
2	525 (480) / 60p	31.47	59.94	27.0	*	* *1
3	625 (575) / 50i	15.63	50.00	13.5	*	*
4	625 (575) / 50p	31.25	50.00	27.0	*	*
5	750 (720) / 60p	45.00	60.00	74.25	*	*
6	750 (720) / 50p	37.50	50.00	74.25	*	*
7	1,125 (1,080) / 60i	33.75	60.00	74.25	*	*
8	1,125 (1,080) / 50i	28.13	50.00	74.25	*	*
9	1,125 (1,080) / 24sF	27.00	47.92	74.25	*	*
10	1,125 (1,080) / 30p	33.75	30.00	74.25	*	*
11	1,125 (1,080) / 25p	28.13	25.00	74.25	*	*
12	1,125 (1,080) / 24p	27.00	24.00	74.25	*	*
13	1,250 (1,080) / 50i	31.25	50.00	74.25	*	*
14	640 × 400 @70 Hz	31.46	70.07	25.17		*
15	640 × 480 @60 Hz	31.47	59.94	25.18		* *2
16	640 × 480 @72 Hz	37.86	72.81	31.5		*
17	640 × 480 @75 Hz	37.50	75.00	31.5		*
18	640 × 480 @85 Hz	43.27	85.01	36.0		*
19	852 × 480 @60 Hz	31.47	59.94	33.54		* *2
20	800 × 600 @56 Hz	35.16	56.25	36.0		*
21	800 × 600 @60 Hz	37.88	60.32	40.0		*
22	800 × 600 @72 Hz	48.08	72.19	50.0		*
23	800 × 600 @75 Hz	46.88	75.00	49.5		*
24	800 × 600 @85 Hz	53.67	85.06	56.25		*
25	1,024 × 768 @60 Hz	48.36	60.00	65.0		*
26	1,024 × 768 @70 Hz	56.48	70.07	75.0		*
27	1,024 × 768 @75 Hz	60.02	75.03	78.75		*
28	1,024 × 768 @85 Hz	68.68	85.00	94.5		*
29	1,152 × 864 @75 Hz	67.50	75.00	108.0		*
30	1,280 × 960 @60 Hz	60.00	60.00	108.0		*
31	1,280 × 960 @85 Hz	85.94	85.00	148.5		*
32	1,280 × 1,024 @60 Hz	63.98	60.02	108.0		*
33	1,280 × 1,024 @75 Hz	79.98	75.03	135.0		*
34	1,280 × 1,024 @85 Hz	91.15	85.02	157.5		*
35	1,600 × 1,200 @60 Hz	75.00	60.00	162.0		*
36	1,600 × 1,200 @65 Hz	81.25	65.00	175.5		*
37	1,066 × 600 @60 Hz	37.64	59.94	53.0		*
38	1,366 × 768 @60 Hz	48.36	60.00	86.71		*
39	Macintosh13" (640 × 480)	35.00	66.67	30.24		*
40	Macintosh16" (832 × 624)	49.72	74.54	57.28		*
41	Macintosh21" (1,152 × 870)	68.68	75.06	100.0		*

\*1: When selected the RGB format and 525p signal input to the Mini D-sub 15P terminal, it is recognized as VGA 60Hz signal.

\*2: When inputted VGA 60Hz format signal from the other than Mini D-sub 15P terminal, it is recognized as 525p signal.

**Note:** Signals without above specification may not be displayed properly.

# Command list of Weekly Command Timer

No.	Command	Control details
1	AAC:MENCLR	Audio Menu (Clear)
2	AAC:MENDYN	Audio Menu (Dynamic)
3	AAC:MENSTD	Audio Menu (Standard)
4	AAC:SURMON	Surround (ON)
5	AAC:SUROFF	Surround (OFF)
6	AMT:0	Audio Mute (OFF)
7	AMT:1	Audio Mute (ON)
8	ASO:M	Audio out when PIP mode (Main Picture)
9	ASO:S	Audio out when PIP mode (Sub Picture)
10	AVL:00	Audio Volume (00)
11	AVL:10	Audio Volume (10)
12	AVL:20	Audio Volume (20)
13	AVL:30	Audio Volume (30)
14	AVL:40	Audio Volume (40)
15	AVL:50	Audio Volume (50)
16	AVL:60	Audio Volume (60)
17	DAM:FULL	Aspect (FULL)
18	DAM:JUST	Aspect (JUST)
19	DAM:NORM	Aspect (NORMAL)
20	DAM:SELF	Aspect (Panasonic Auto)
21	DAM:ZOOM	Aspect (ZOOM)
22	DWA:OFF	Dual Picture mode (OFF)
23	DWA:OVL1	Advanced PIP mode (1) (see page 22)
24	DWA:OVL2	Advanced PIP mode (2) (see page 22)
25	DWA:OVL3	Advanced PIP mode (3) (see page 22)
26	DWA:OVL4	Advanced PIP mode (4) (see page 22)
27	DWA:OVL5	Advanced PIP mode (5) (see page 22)
28	DWA:OVL6	Advanced PIP mode (6) (see page 22)
29	DWA:OVLOF	Advanced PIP mode (OFF) (normal two screen display mode)
30	DWA:OVLON	Advanced PIP mode (ON)
31	DWA:PIN0	The location of the sub picture (lower right)
32	DWA:PIN1	The location of the sub picture (lower left)
33	DWA:PIN2	The location of the sub picture (upper left)
34	DWA:PIN3	The location of the sub picture (upper right)
35	DWA:PIP	Dual Picture mode (Picture in Picture)
36	DWA:POP	Dual Picture mode (Picture out Picture)
37	DWA:SWP	Swap main picture and sub picture when PIP mode
38	DWA:TWN	Dual Picture mode (Picture and Picture)
39	IMS:PC1	Input select (PC1) (Main Picture when PIP mode)
40	IMS:SL1	Input select (SLOT1) (Main Picture when PIP mode)
41	IMS:SL1A	Input select (SLOT1A) (Main Picture when PIP mode)
42	IMS:SL1B	Input select (SLOT1B) (Main Picture when PIP mode)
43	IMS:SL2	Input select (SLOT2) (Main Picture when PIP mode)
44	IMS:SL2A	Input select (SLOT2A) (Main Picture when PIP mode)
45	IMS:SL2B	Input select (SLOT2B) (Main Picture when PIP mode)
46	IMS:SL3*1	Input select (SLOT3) (Main Picture when PIP mode)
47	ISS:PC1	Sub Picture Input Select (PC1)
48	ISS:SL1	Sub Picture Input Select (SLOT1)
49	ISS:SL1A	Sub Picture Input Select (SLOT1A)
50	ISS:SL1B	Sub Picture Input Select (SLOT1B)
51	ISS:SL2	Sub Picture Input Select (SLOT2)
52	ISS:SL2A	Sub Picture Input Select (SLOT2A)
53	ISS:SL2B	Sub Picture Input Select (SLOT2B)
54	ISS:SL3*1	Sub Picture Input Select (SLOT3)
55	OSP:SCR0	Screen Saver WHITE BAR SCROLL (OFF)
56	OSP:SCR1	Screen Saver WHITE BAR SCROLL (ON)
57	POF	Power OFF
58	PON	Power ON
59	SSC:FNC0	Screen Saver function (WHITE BAR SCROLL)
60	SSC:FNC1	Screen Saver function (NEGATIVE)
61	SSC:MOD0	ScreenSaver (Mode (OFF))
62	SSC:MOD3	ScreenSaver (Mode (ON))
63	VMT:0*2	Picture Mute (OFF)
64	VMT:1*2	Picture Mute (ON)

\*1 These commands are unavailable on TH-37PH10UK because the model is not equipped with SLOT3.

\*2 Picture Mute cannot be unlocked by powering off/on with the remote control. Turn off and on again with the button on the unit or enter the command VMT:0 to unlock Picture Mute.



# Specifications

	TH-37PH10UK	TH-42PH10UK
<b>Power Source</b>	120 V AC, 50/60 Hz	
<b>Power Consumption</b>		
Power on	340 W	380 W
Stand-by condition	Save OFF 0.7 W, Save ON 0.5 W	Save OFF 0.7 W, Save ON 0.5 W
Power off condition	0.2 W	0.2 W
<b>Plasma Display panel</b>	Drive method : AC type 37-inch, 16:9 aspect ratio	Drive method : AC type 42-inch, 16:9 aspect ratio
<b>Screen size</b>	32.2" (819 mm) (W) × 18.0" (457 mm) (H) × 36.9" (938 mm) (diagonal)	36.3" (922 mm) (W) × 20.4" (518 mm) (H) × 41.6" (1,057 mm) (diagonal)
(No.of pixels)	737,280 (1,024 (W) × 720 (H)) [3,072 × 720 dots]	786,432 (1,024 (W) × 768 (H)) [3,072 × 768 dots]
<b>Operating condition</b>		
Temperature	32 °F - 104 °F (0 °C - 40 °C)	
Humidity	20 % - 80 %	
<b>Applicable signals</b>		
Color System	NTSC, PAL, PAL60, SECAM, Modified NTSC	
Scanning format	525 (480) / 60i · 60p, 625 (575) / 50i · 50p, 750 (720) / 60p · 50p, 1125 (1080) / 60i · 50i · 24p · 25p · 30p · 24sF ... SMPTE274M, 1250 (1080) / 50i	
PC signals	VGA, SVGA XGA, SXGA, UXGA ... (compressed) Horizontal scanning frequency 15 - 110 kHz Vertical scanning frequency 48 - 120 Hz	VGA, SVGA, XGA SXGA, UXGA ... (compressed) Horizontal scanning frequency 15 - 110 kHz Vertical scanning frequency 48 - 120 Hz
<b>Connection terminals</b>		
AV IN	VIDEO IN (BNC) S VIDEO IN (MINI DIN 4PIN) AUDIO IN (RCA PIN JACK × 4)	1.0 Vp-p (75 Ω) Y: 1.0 Vp-p (75 Ω), C: 0.286 Vp-p (75 Ω) 0.5 Vrms (high impedance)
COMPONENT/RGB IN	Y/G (BNC) P <sub>B</sub> /B (BNC), P <sub>R</sub> /R (BNC) AUDIO IN (RCA PIN JACK × 2)	with/sync 1.0 Vp-p (75 Ω) 0.7 Vp-p (75 Ω) 0.5 Vrms (high impedance)
PC IN	(HIGH-DENSITY MINI D-SUB 15PIN)  B/P <sub>B</sub> /C <sub>B</sub> : R/P <sub>R</sub> /C <sub>R</sub> : HD/VD: AUDIO IN (M3 JACK)	Y or G with/sync 1.0 Vp-p (75 Ω) Y or G without/sync 0.7 Vp-p (75 Ω) 0.7 Vp-p (75 Ω) 0.7 Vp-p (75 Ω) 1.0 - 5.0 Vp-p (high impedance) 0.5 Vrms (high impedance)
SERIAL	EXTERNAL CONTROL TERMINAL (D-SUB 9PIN) RS-232C COMPATIBLE	
SPEAKERS (6 Ω)	16W [8 W + 8 W] (10 % THD)	
<b>Accessories Supplied</b>		
Remote Control Transmitter	EUR7636070R	
Batteries	2 × AA Size	
Fixing bands	TMME203 × 2	
<b>Dimensions (W × H × D)</b>	36.2" (920 mm) × 21.7" (550 mm) × 3.5" (89 mm)	40.2" (1,020 mm) × 24" (610 mm) × 3.5" (89 mm)
<b>Mass (weight)</b>		
main unit only	approx. 48.5 lbs	approx. 57.3 lbs
with speakers	approx. 57.3 lbs	approx. 66.1 lbs

**Note:**

Design and specifications are subject to change without notice. Mass and dimensions shown are approximate.

# Specifications

	TH-50PH10UK	TH-58PH10UK
<b>Power Source</b>	120 V AC, 50/60 Hz	
<b>Power Consumption</b>		
Power on	505 W	660 W
Stand-by condition	Save OFF 0.6 W, Save ON 0.4 W	Save OFF 0.6 W, Save ON 0.4 W
Power off condition	0.1 W	0.1 W
<b>Plasma Display panel</b>	Drive method : AC type 50-inch, 16:9 aspect ratio	Drive method : AC type 58-inch, 16:9 aspect ratio
<b>Screen size</b>	43.5" (1,106 mm) (W) × 24.5" (622 mm) (H) × 50.0" (1,269 mm) (diagonal)	50.7" (1,287 mm) (W) × 28.5" (723 mm) (H) × 58.0" (1,476 mm) (diagonal)
(No. of pixels)	1,049,088 (1,366 (W) × 768 (H)) [4,098 × 768 dots]	1,049,088 (1,366 (W) × 768 (H)) [4,098 × 768 dots]
<b>Operating condition</b>		
Temperature	32 °F - 104 °F (0 °C - 40 °C)	
Humidity	20 % - 80 %	
<b>Applicable signals</b>		
Color System	NTSC, PAL, PAL60, SECAM, Modified NTSC	
Scanning format	525 (480) / 60i · 60p, 625 (575) / 50i · 50p, 750 (720) / 60p · 50p, 1125 (1080) / 60i · 50i · 24p · 25p · 30p · 24sF ··· SMPTE274M, 1250 (1080) / 50i	
PC signals	VGA, SVGA, XGA SXGA, UXGA ··· (compressed) Horizontal scanning frequency 15 - 110 kHz Vertical scanning frequency 48 - 120 Hz	
<b>Connection terminals</b>		
AV IN	VIDEO IN (BNC) S VIDEO IN (MINI DIN 4PIN) AUDIO IN (RCA PIN JACK × 4)	1.0 Vp-p (75 Ω) Y: 1.0 Vp-p (75 Ω), C: 0.286 Vp-p (75 Ω) 0.5 Vrms (high impedance)
COMPONENT/RGB IN	Y/G (BNC) P <sub>B</sub> /B (BNC), P <sub>R</sub> /R (BNC) AUDIO IN (RCA PIN JACK × 2)	with/sync 1.0 Vp-p (75 Ω) 0.7 Vp-p (75 Ω) 0.5 Vrms (high impedance)
PC IN	(HIGH-DENSITY MINI D-SUB 15PIN)  B/P <sub>B</sub> /C <sub>B</sub> : R/P <sub>R</sub> /C <sub>R</sub> : HD/VD: AUDIO IN (M3 JACK)	Y or G with/sync 1.0 Vp-p (75 Ω) Y or G without/sync 0.7 Vp-p (75 Ω) 0.7 Vp-p (75 Ω) 0.7 Vp-p (75 Ω) 1.0 - 5.0 Vp-p (high impedance) 0.5 Vrms (high impedance)
SERIAL	EXTERNAL CONTROL TERMINAL (D-SUB 9PIN) RS-232C COMPATIBLE	
SPEAKERS (6 Ω)	16W [8 W + 8 W] (10 % THD)	
<b>Accessories Supplied</b>		
Remote Control Transmitter	EUR7636070R	
Batteries	2 × AA Size	
Fixing bands	TMME203 × 2	
<b>Dimensions (W × H × D)</b>	47.6" (1,210 mm) × 28.5" (724 mm) × 3.7" (95 mm)	55.1" (1,399 mm) × 33.2" (843 mm) × 3.9" (99 mm)
<b>Mass (weight)</b>		
main unit only	approx. 79.4 lbs	approx. 119 lbs
with speakers	approx. 88.2 lbs	approx. 130.1 lbs

## Note:

Design and specifications are subject to change without notice. Mass and dimensions shown are approximate.

Panasonic Broadcast & Television Systems Company, Unit of Panasonic Corporation of North America  
 One Panasonic Way 2A-4  
 Secaucus, NJ 07094

Panasonic Puerto Rico, Inc.  
 Ave. 65de Infanteria, Km.9.5  
 San Gabriel Industrial Park  
 Carolina, Puerto Rico 00985

**PANASONIC PLASMA SCREEN  
 Limited Warranty**

Panasonic Broadcast & Television Systems Company or Panasonic Puerto Rico, Inc. (collectively referred to as "the Warrantor") will repair this product and all included accessories with new or refurbished parts, free of charge in the USA or Puerto Rico, of the original purchase in the event of a defect in materials or workmanship as follow:

inadequate signal pickup, maladjustment of consumer controls, improper operation, power line surge, improper voltage supply, lighting damage, or service by anyone other than an authorized repair facility, or damaged this attributable to acts of God.

Models or Parts	Part Warranty	Labor Warranty
Plasma Screen	1 Year	1 Year

**LIMITS AND EXCLUSIONS**

There are no express warranties except as listed above.

Carry-in or mail-in service in the **USA** may be obtained during the warranty period by contacting Panasonic Broadcast & Television Systems Company Factory Servicenter listed in the Service Directory or call toll free **1-800-526-6610** to locate an authorized Servicenter.

THE WARRANTOR SHALL NOT BE LIABLE FOR INCIDENTAL OR CONSEQUENTIAL DAMAGES (INCLUDING, WITHOUT LIMITATION, DAMAGE TO DISCS) RESULTING FROM THE USE OF THIS PRODUCT, OR ARISING OUT OF ANY BREACH OF THE WARRANTY. ALL EXPRESS AND IMPLIED WARRANTIES, INCLUDING THE WARRANTIES OF MERCHANTABILITY AND FITNESS FOR PARTICULAR PURPOSE, ARE LIMITED TO THE APPLICABLE WARRANTY PERIOD SET FORTH ABOVE.

Carry-in or mail-in service in **Puerto Rico** can be obtained during the warranty period by **787-750-5135**

This warranty is extended only to the original purchaser and is non transferable. A purchase receipt or other proof of date of original purchase will be required before warranty service is rendered.

Some states do not allow the exclusion or limitation of incidental or consequential damages, or limitations on how long an implied warranty lasts, so the above exclusions or limitations may not apply to you. This warranty gives you specific legal rights and you may other rights, which vary from state to state.

This warranty only covers failures due to defects in materials or workmanship, which occur during normal use. The warranty does not cover damage which occur in shipment, or failures which are caused by products not supplied by the warrantor, or failures which result installation, set-up adjustments, improper antenna,

If you have a problem with this product that is not handled to your satisfaction, then write the Consumer Affairs Department at the Company address indicated above.

In the USA FOR THE NEAREST SERVICE CENTER 1-800-526-6610 Regional Offices			
New Jersey	Illinois	Georgia	California
50 Meadowlands Pkwy – 2A4 Secaucus, NJ 07094 201-348-7975	1713 N. Randall – E1-E1 Elgin, IL 60123 847-468-5270	1225 Northbrook Pkwy Suwanee, GA 30093 770-338-6855	3330 Cahuenga Blvd West Los Angeles, CA 90068 323-436-3505
In Puerto Rico For service call 787-750-5135			

**Panasonic Canada Inc.**  
**Broadcast & Television Systems Division**  
 5770 Ambler Drive, Mississauga, Ontario L4W 2T3  
**LIMITED WARRANTY STATEMENT**

Panasonic Canada Inc. (also known as PCI) warrants this product to be free of defects in material and workmanship under normal use during the applicable warranty coverage period described below. PCI agrees to repair, or at its option, exchange, any part that becomes defective. However, the product must be purchased and serviced in Canada. The product or part that shows evidence of defect must be delivered prepaid or carried in to an authorized Panasonic Broadcast Service Center. This warranty does not cover shipping costs.

The warranty coverage period is one year for both parts and labour beginning with the date of original end user purchase, subject to the exceptions as stated below. Repaired or replacement parts supplied during the warranty coverage period carry the unexpired portion of the original warranty coverage period. Proof of product purchase is a condition of warranty service. The owner must produce the product purchase receipt or other satisfactory evidence of date of original purchase.

This warranty does not apply to external appearance items, such as handles, knobs, safety windows, etc. This warranty does not apply to any part, or parts, of the product, installed, altered, repaired or misused in any way that, in the opinion of PCI, affects the reliability of or detracts from the performance of the product.

For products requiring routine preventive maintenance, that maintenance must be performed in order to maintain warranty coverage.

Serial numbers that have been altered, defaced or removed void this warranty. This warranty does not cover replacements or repairs necessitated by loss or damage resulting from any cause beyond the control of PCI.

Marking or retained images (sometimes called "burn-in") resulting from the display of fixed images on video display products are not defects and are not covered under this warranty.

**THIS EXPRESS, LIMITED WARRANTY IS IN LIEU OF ALL OTHER WARRANTIES, EXPRESS OR IMPLIED, INCLUDING ANY IMPLIED WARRANTIES OF MERCHANTABILITY AND FITNESS FOR A PARTICULAR PURPOSE. IN NO EVENT WILL PANASONIC CANADA INC. BE LIABLE FOR ANY SPECIAL, INDIRECT OR CONSEQUENTIAL DAMAGES.**

In certain instances, some jurisdictions do not allow the exclusion or limitation of incidental or consequential damages, or the exclusion of implied warranties, so the above limitations and exclusions may not be applicable.

**WARRANTY COVERAGE PERIOD EXCEPTIONS**

Item	Parts	Labour
Video Tape	30 days—Replacement only (content not covered)	N/A
P2 Cards	(Content not covered)	N/A
Video Heads	1 year or 2,000 hrs. (prorated) Whichever comes first	1 year or 2,000 hrs. Whichever comes first
D5 Video heads	1 year or 500 hrs. Whichever comes first	1 year or 500 hrs. Whichever comes first
Maintenance Items	90 days	90 days
Colour Camera CCD Imaging Block	2 years	1 year
LCD/CRT Monitors	2 years	1 year
* DLP™ Projectors	3 years or 5,000 hrs. Whichever comes first	3 years or 5,000 hrs. Whichever comes first
* LCD Projectors above 2,500 ANSI Lumens	3 years or 2,500 hrs. Whichever comes first	3 years or 2,500 hrs. Whichever comes first.
* LCD Projectors below 2,500 ANSI Lumens	3 years or 1,500 hrs. Whichever comes first	3 years or 1,500 hrs. Whichever comes first
Projector Lamps	90 Days or 500 hrs. Whichever comes first	90 Days or 500 hrs. Whichever comes first.
Plasma Displays	1 year (burn-in not covered)	1 year (burn-in not covered)
Hard Drive Disk Unit	1 year plus balance (if any) of any original Manufacturer's Limited Warranty. (Content not covered)	1 year

•Dust, smoke, rental/staging environment and twenty-four/seven operation, dramatically decreases the interval between performances of routine preventive maintenance required to maintain this warranty coverage.

**Warranty Service**

If the product needs to be shipped for service, carefully pack (preferably in the original carton) and enclose a letter, detailing the complaint. Send prepaid and adequately insured to the local authorized Panasonic Broadcast Service Centre in your area or to Panasonic Broadcast & Security Systems Service Department, 5770 Ambler Drive, Mississauga, Ontario, L4W 2T3. Shipping to the latter location requires a return authorization before shipment. No liability is assumed for loss or damage to the product while in transit.

**Customer's Record**

The model number and serial number of this product can be found on its back cover. You should note this serial number in the space provided below and retain this book, plus your purchase receipt, as a permanent record of your purchase to aid in identification in the event of theft or loss, and for Warranty Service purposes.

Model Number \_\_\_\_\_

Serial Number \_\_\_\_\_

© 2007 Matsushita Electric Industrial Co., Ltd. All Rights Reserved.

---

**Panasonic Broadcast & Television Systems Company**

Unit of Panasonic Corporation of North America

**Executive Office :**

One Panasonic Way 4E-7, Secaucus, NJ 07094 (201) 348-7000

**EASTERN ZONE :** One Panasonic Way 4E-7 Secaucus, NJ 07094 (201) 348-7621

Mid-Atlantic/New England : One Panasonic Way 4E-7 Secaucus, NJ 07094 (201) 348-7621

Southeast Region : 1225 Northbrook Parkway, Ste 1-160 Suwanee GA 30024 (770)338-6835

Central Region : 1707 N Randall Road E1-C-1, Elgin, IL 60123 (847)468-5200

**WESTERN ZONE :** 3330 Cahuenga Blvd W., Los Angeles, CA 90068 (323) 436-3500

Dallas Region : 6226 Abington Way, Houston, TX 77008 (713) 802-2726

No. CA/Northwest Region : 5870 Stone Ridge, #3, Pleasanton, CA (925) 416-5108

**Government Marketing Department :** 52 West Gude Drive, Rockville, MD 20850 (301) 738-3840**Panasonic Canada Inc.**

5770 Ambler Drive

Mississauga, Ontario

L4W 2T3