

SONY[®]

4-487-947-12(1)

Interchangeable Lens
Digital Camera

α
5000

Instruction Manual

E-mount

ILCE-5000

Learning more about the camera (“Help Guide”)



“Help Guide” is an on-line manual. Refer to it for in-depth instructions on the many functions of the camera.

- ① Access the Sony support page.
<http://www.sony.net/SonyInfo/Support/>
- ② Select your country or region.
- ③ Search for the model name of your camera on the support page.
 - Check the model name on the bottom of your camera.

Viewing the Guide

This camera is equipped with a built-in instruction guide.

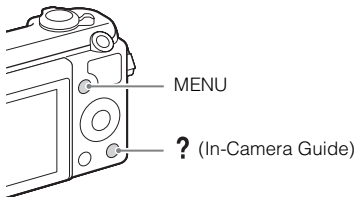

In-Camera Guide

The camera displays explanations for MENU items and the setting values.

- ① Press the MENU button.
- ② Select the desired item, then press the ? (In-Camera Guide) button.

Shooting Tip

The camera displays shooting tips for the shooting mode selected.

- ① Press the ? (In-Camera Guide) button in shooting mode.
- ② Select the desired shooting tip, then press ● on the control wheel.

The shooting tip is displayed.

- You can scroll the screen using ▲/▼ and change shooting tips using ◀/▶.

Owner's Record

The model and serial numbers are located on the bottom. Record the serial number in the space provided below. Refer to these numbers whenever you call your Sony dealer regarding this product.

Model No. ILCE-5000

Serial No. _____

Model No. AC-UB10C/AC-UB10D

Serial No. _____

WARNING

To reduce fire or shock hazard, do not expose the unit to rain or moisture.

IMPORTANT SAFETY INSTRUCTIONS -SAVE THESE INSTRUCTIONS DANGER TO REDUCE THE RISK OF FIRE OR ELECTRIC SHOCK, CAREFULLY FOLLOW THESE INSTRUCTIONS

If the shape of the plug does not fit the power outlet, use an attachment plug adaptor of the proper configuration for the power outlet.

CAUTION

Battery pack

If the battery pack is mishandled, the battery pack can burst, cause a fire or even chemical burns. Observe the following cautions.

- Do not disassemble.
- Do not crush and do not expose the battery pack to any shock or force such as hammering, dropping or stepping on it.
- Do not short circuit and do not allow metal objects to come into contact with the battery terminals.
- Do not expose to high temperature above 60°C (140°F) such as in direct sunlight or in a car parked in the sun.
- Do not incinerate or dispose of in fire.
- Do not handle damaged or leaking lithium ion batteries.
- Be sure to charge the battery pack using a genuine Sony battery charger or a device that can charge the battery pack.

- Keep the battery pack out of the reach of small children.
- Keep the battery pack dry.
- Replace only with the same or equivalent type recommended by Sony.
- Dispose of used battery packs promptly as described in the instructions.

AC Adaptor

Use the nearby wall outlet (wall socket) when using the AC Adaptor. Disconnect the AC Adaptor from the wall outlet (wall socket) immediately if any malfunction occurs while using the apparatus.

The power cord (mains lead), if supplied, is designed specifically for use with this camera only, and should not be used with other electrical equipment.

For Customers in the U.S.A. and Canada

RECYCLING LITHIUM-ION BATTERIES

Lithium-Ion batteries are recyclable.

You can help preserve our environment by returning your used rechargeable batteries to the collection and recycling location nearest you.



For more information regarding recycling of rechargeable batteries, call toll free

1-800-822-8837, or visit <http://www.call2recycle.org/>

Caution: Do not handle damaged or leaking Lithium-Ion batteries.

Battery pack and lens (If lens supplied)

This device complies with Part 15 of the FCC Rules. Operation is subject to the following two conditions:

(1) This device may not cause harmful interference, and (2) this device must accept any interference received, including interference that may cause undesired operation.

CAN ICES-3 B/NMB-3 B

This equipment complies with FCC/IC radiation exposure limits set forth for an uncontrolled environment and meets the FCC radio frequency (RF) Exposure Guidelines in Supplement C to OET65 and RSS-102 of the IC radio frequency (RF) Exposure rules. This equipment has very low levels of RF energy that are deemed to comply without testing of specific absorption ratio (SAR).

For Customers in the U.S.A.

If you have any questions about this product, you may call:

Sony Customer Information Center
1-800-222-SONY (7669)

The number below is for the FCC related matters only.

Regulatory Information

Declaration of Conformity

Trade Name: SONY
Model No.: ILCE-5000
Responsible Party: Sony Electronics Inc.
Address: 16530 Via Esprillo,
San Diego, CA 92127 U.S.A.
Telephone No.: 858-942-2230

This device complies with Part 15 of the FCC Rules. Operation is subject to the following two conditions: (1) This device may not cause harmful interference, and (2) this device must accept any interference received, including interference that may cause undesired operation.

This equipment must not be co-located or operated in conjunction with any other antenna or transmitter.

CAUTION

You are cautioned that any changes or modifications not expressly approved in this manual could void your authority to operate this equipment.

Note:

This equipment has been tested and found to comply with the limits for a Class B digital device, pursuant to Part 15 of the FCC Rules.

These limits are designed to provide reasonable protection against harmful interference in a residential installation. This equipment generates, uses, and can radiate radio frequency energy and, if not installed and used in accordance with the instructions, may cause harmful interference to radio communications. However, there is no guarantee that interference will not occur in a particular installation. If this equipment does cause harmful interference to radio or television reception, which can be determined by turning the equipment off and on, the user is encouraged to try to correct the interference by one or more of the following measures:

- Reorient or relocate the receiving antenna.
- Increase the separation between the equipment and receiver.
- Connect the equipment into an outlet on a circuit different from that to which the receiver is connected.
- Consult the dealer or an experienced radio/TV technician for help.

The supplied interface cable must be used with the equipment in order to comply with the limits for a digital device pursuant to Subpart B of Part 15 of FCC Rules.

For Customers in Canada

This device complies with Industry Canada licence-exempt RSS standard(s). Operation is subject to the following two conditions: (1) this device may not cause interference, and (2) this device must accept any interference, including interference that may cause undesired operation of the device.

For Customers in Europe

| Notice for the customers in the countries applying EU Directives

Manufacturer: Sony Corporation, 1-7-1 Konan Minato-ku Tokyo, 108-0075 Japan
For EU product compliance: Sony Deutschland GmbH, Hedelfinger Strasse 61, 70327 Stuttgart, Germany



Hereby, Sony Corporation, declares that this equipment is in compliance with the essential requirements and other relevant provisions of Directive 1999/5/EC. For details, please access the following URL:

<http://www.compliance.sony.de/>

| Notice

If static electricity or electromagnetism causes data transfer to discontinue midway (fail), restart the application or disconnect and connect the communication cable (USB, etc.) again.

This product has been tested and found compliant with the limits set out in the EMC regulation for using connection cables shorter than 3 meters (9.8 feet).

The electromagnetic fields at the specific frequencies may influence the picture and sound of this unit.

| Disposal of waste batteries and electrical and electronic equipment (applicable in the European Union and other European countries with separate collection systems)



This symbol on the product, the battery or on the packaging indicates that the product and the battery shall not be treated as household waste. On certain batteries this symbol might be used in combination with a chemical symbol. The chemical symbols for mercury (Hg) or lead (Pb) are added if the battery contains more than 0.0005% mercury or 0.004% lead.

By ensuring these products and batteries are disposed of correctly, you will help prevent potentially negative consequences for the environment and human health which could otherwise be caused by inappropriate waste handling. The recycling of the materials will help to conserve natural resources.

In case of products that for safety, performance or data integrity reasons require a permanent connection with an incorporated battery, this battery should be replaced by qualified service staff only. To ensure that the battery and the electrical and electronic equipment will be treated properly, hand over these products at end-of-life to the applicable collection point for the recycling of electrical and electronic equipment. For all other batteries, please view the section on how to remove the battery from the product safely. Hand the battery over to the applicable collection point for the recycling of waste batteries. For more detailed information about recycling of this product or battery, please contact your local Civic Office, your household waste disposal service or the shop where you purchased the product or battery.

For Customers in Singapore

Complies with
IDA Standards
DB00353

For customers who purchased their camera from a store in Japan that caters to tourists

| Note

Some certification marks for standards supported by the camera can be confirmed on the screen of the camera.

Select MENU →  (Setup) 5 → [Certification Logo].

If display is not possible due to problems such as camera failure, contact your Sony dealer or local authorized Sony service facility.

Table of contents

Preparing the camera	Step 1	P. 9
<ul style="list-style-type: none">– Checking the supplied items– Identifying parts– Inserting the battery pack– Charging the battery pack– Attaching/removing the lens– Inserting a memory card (sold separately)– Setting the clock		
Basic operation	Step 2	P. 21
<ul style="list-style-type: none">– Shooting still images/movies		
Playback function	Step 3	P. 22
<ul style="list-style-type: none">– Viewing images		
Recording function	Step 4	P. 23
<ul style="list-style-type: none">– Introduction of other functions		
Importing images to the computer		P. 29
<ul style="list-style-type: none">– Features of PlayMemories Home		
Adding functions to the camera		P. 30
<ul style="list-style-type: none">– Adding functions to the camera		
Others		P. 31
<ul style="list-style-type: none">– Number of still images and recordable time of movies– Notes on using the camera– Specifications		

This manual covers several models supplied with different lenses.

The model name varies depending on the supplied lens. The available model varies depending on the countries/regions.

Model name	Lens
ILCE-5000L	E16 – 50 mm
ILCE-5000Y	E55 – 210 mm and E16 – 50 mm

Checking the supplied items

First check the model name of your camera (page 8). The accessories supplied differ depending on the model.

The number in parentheses indicates the quantity.

■ Supplied with all models

- Camera (1)
- Power cord (mains lead) (1)* (not supplied in the U.S.A. and Canada)



- * Multiple power cords may be supplied with your camera. Use the appropriate one that matches your country/region.
- Rechargeable battery pack NP-FW50 (1)



- Micro USB cable (1)

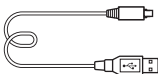

- AC adaptor AC-UB10C/UB10D (1)

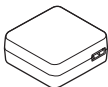

- Shoulder strap (1)

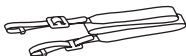

- Instruction Manual (this manual) (1)

- Wi-Fi Connection/One-touch (NFC) Guide

This guide explains the functions that require a Wi-Fi connection.

■ ILCE-5000L

- E16 – 50 mm zoom lens (1) (attached to the camera)/Front lens cap (1) (attached to the lens)

■ ILCE-5000Y

- E16 – 50 mm zoom lens (1) (attached to the camera)/Front lens cap (1) (attached to the lens)
- E55 – 210 mm zoom lens (1)/Front lens cap (1)/Rear lens cap (1)/Lens hood (1)

Identifying parts

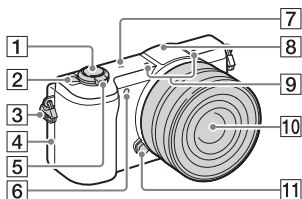

When the lens is removed

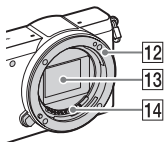

1 Shutter button

2 ON/OFF (Power) switch

3 Hook for shoulder strap

4 **N** (N Mark)

- Touch the mark when you connect the camera to a smartphone equipped with the NFC function.
- NFC (Near Field Communication) is an international standard of the short-range wireless communication technology.

5 For shooting: W/T (zoom) lever

For viewing:  (Index)/

 (Playback zoom) lever

6 AF illuminator/Self-timer lamp

7  Image sensor position mark

8 Flash

9 Microphone¹⁾

10 Lens

11 Lens release button

12 Mount

13 Image sensor²⁾

14 Lens contacts²⁾

¹⁾ Do not cover this part during movie recording.

²⁾ Do not touch this part directly.

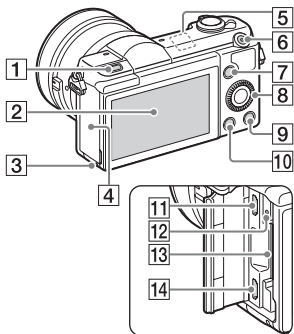

- 1** ⚡ (Flash pop-up) button
- 2** LCD screen
- You can adjust the LCD screen to an easily viewable angle and shoot from any position.

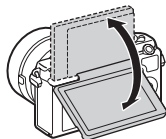

- 3** Access lamp
- 4** Memory card/terminal cover
- 5** Wi-Fi sensor (built-in)
- 6** MOVIE (Movie) button
- 7** MENU button
- 8** Control wheel
- 9** ? (In-Camera Guide) /  (Delete) button
- 10** ▶ (Playback) button
- 11** Multi/Micro USB Terminal
- Supports Micro USB compatible device.
- 12** Charge lamp
- 13** Memory card slot
- 14** HDMI micro jack

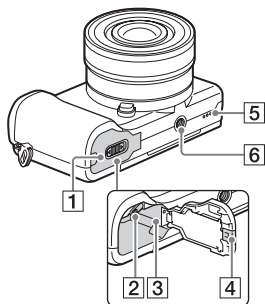

- 1** Battery cover
- 2** Battery eject lever
- 3** Battery insertion slot
- 4** Connection plate cover
- Use this when using an AC-PW20 AC Adaptor (sold separately). Insert the connection plate into the battery compartment, and then pass the cord through the connection plate cover as shown below.

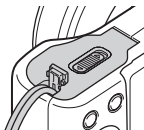

- Make sure that the cord is not pinched when you close the cover.
- 5** Speaker
- 6** Tripod socket hole
- Use a tripod with a screw less than 5.5 mm (7/32 inches) long. Otherwise, you cannot firmly secure the camera, and damage to the camera may occur.

■ Lens

See page 37 on the specifications of the lenses.

E PZ 16 – 50 mm F3.5 – 5.6 OSS (supplied with ILCE-5000L/ILCE-5000Y)

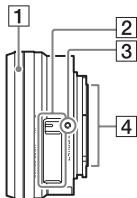

- 1 Zooming/Focusing ring
- 2 Zooming lever
- 3 Mounting index
- 4 Lens contacts¹⁾

¹⁾ Do not touch this part directly.

E55 – 210 mm F4.5 – 6.3 OSS (supplied with ILCE-5000Y)

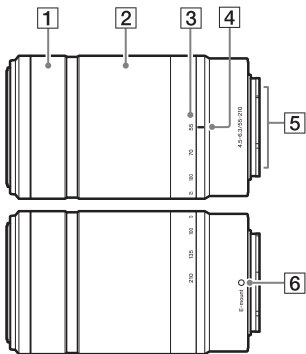

- 1 Focusing ring
- 2 Zooming ring
- 3 Focal-length scale
- 4 Focal-length index
- 5 Lens contacts¹⁾
- 6 Mounting index

¹⁾ Do not touch this part directly.

Inserting the battery pack

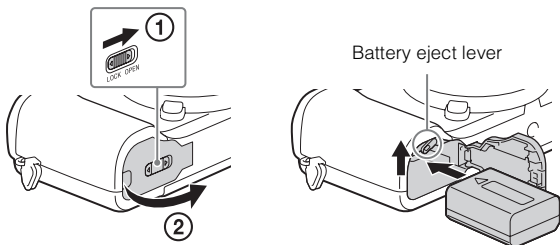

1 Open the cover.

2 Insert the battery pack.

- While pressing the battery eject lever, insert the battery pack as illustrated. Make sure that the battery eject lever locks after insertion.
 - Closing the cover with the battery inserted incorrectly may damage the camera.
-

Charging the battery pack

For customers in the USA and Canada

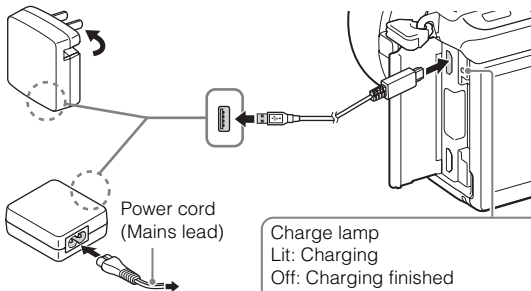

For customers in countries/
regions other than the USA
and Canada

- 1 Connect the camera to the AC Adaptor (supplied), using the micro USB cable (supplied).
- 2 Connect the AC Adaptor to the wall outlet (wall socket).
The charge lamp lights orange, and charging starts.
 - Turn off the camera while charging the battery.
 - You can charge the battery pack even when it is partially charged.
 - When the charge lamp flashes and charging is not finished, remove and re-insert the battery pack.

Notes

- If the charge lamp on the camera flashes when the AC Adaptor is connected to the wall outlet (wall socket), this indicates that charging is temporarily stopped because the temperature is outside the recommended range. When the temperature gets back within the appropriate range, the charging resumes. We recommend charging the battery pack in an ambient temperature of between 10°C to 30°C (50°F to 86°F).

- The battery pack may not be effectively charged if the terminal section of the battery is dirty. In this case, wipe any dust off lightly using a soft cloth or a cotton swab to clean the terminal section of the battery.
- Connect the AC Adaptor (supplied) to the nearest wall outlet (wall socket). If malfunctions occur while using the AC Adaptor, disconnect the plug from the wall outlet (wall socket) immediately to disconnect from the power source.
- When charging is finished, disconnect the AC Adaptor from the wall outlet (wall socket).
- Be sure to use only genuine Sony brand battery packs, micro USB cable (supplied) and AC Adaptor (supplied).
- Power is not supplied during shooting/playback if the camera is connected to a wall outlet with the supplied AC adaptor. To supply power to the camera during shooting/playback, use the AC-PW20 AC adaptor (sold separately).

■ Charging time (Full charge)

The charging time is approximately 310 minutes using the AC Adaptor (supplied).

Notes

- The above charging time applies when charging a fully depleted battery pack at a temperature of 25°C (77°F). Charging may take longer depending on conditions of use and circumstances.

■ Charging by connecting to a computer

The battery pack can be charged by connecting the camera to a computer using a micro USB cable.

Notes

- Note the following points when charging via a computer:
 - If the camera is connected to a laptop computer that is not connected to a power source, the laptop battery level decreases. Do not charge for an extended period of time.
 - Do not turn on/off or restart the computer, or wake the computer to resume from sleep mode when a USB connection has been established between the computer and the camera. That may cause the camera to malfunction. Before turning on/off, or restarting the computer or waking the computer from sleep mode, disconnect the camera and the computer.
 - No guarantees are made for charging using a custom-built computer or a modified computer.

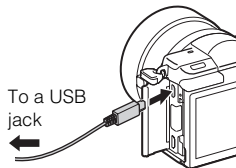

Battery life and number of images that can be recorded and played back

	Battery life	Number of images
Shooting (still images)	Approx. 210 min.	Approx. 420 images
Typical movie shooting	Approx. 95 min.	—
Continuous movie shooting	Approx. 150 min.	—
Viewing (still images)	Approx. 470 min.	Approx. 9400 images

Notes

- The above number of images applies when the battery pack is fully charged. The number of images may decrease depending on the conditions of use.
- The number of images that can be recorded is for shooting under the following conditions:
 - Using a Sony Memory Stick PRO Duo™ (Mark2) media (sold separately).
 - When an E PZ 16 – 50 mm F3.5 – 5.6 OSS lens is attached.
 - The battery pack is used at an ambient temperature of 25°C (77°F).
- The number for “Shooting (still images)” is based on the CIPA standard, and is for shooting under the following conditions:
(CIPA: Camera & Imaging Products Association)
 - DISP is set to [Display All Info.].
 - Shooting once every 30 seconds.
 - The zoom is switched alternately between the W and T ends.
 - The flash is used once every two times.
 - The power is turned on and off once every ten times.
- The number of minutes for movie shooting is based on the CIPA standard, and is for shooting under the following conditions:
 -  Record Setting: 60i 17M(FH)/50i 17M(FH).
 - Typical movie shooting: Battery life based on repeatedly starting/stopping shooting, zooming, turning on/off, etc.
 - Continuous movie shooting: Battery life based on non-stop shooting until the limit (29 minutes) has been reached, and then continued by pressing the MOVIE button again. Other functions, such as zooming, are not operated.

Attaching/removing the lens

Set the power switch of the camera to OFF before you attach or remove the lens.

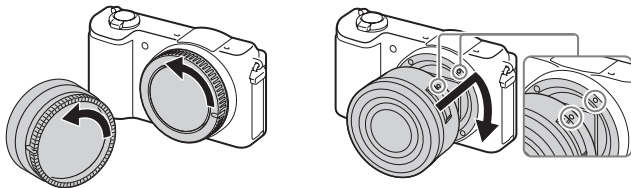

- 1** If the cap or the packaging lid is attached, remove it from the camera or the lens.
 - Quickly change the lens somewhere away from dusty locations to keep dust or debris from getting inside the camera.
- 2** Mount the lens by aligning the white index marks on the lens and the camera.
 - Hold the camera facing down to prevent dust from entering into the camera.
- 3** While pushing the lens lightly toward the camera, turn the lens clockwise until it clicks into the locked position.
 - Be sure to put the lens on straight.

Notes

- When attaching a lens, do not press the lens release button.
- Do not use excessive force when attaching a lens.
- The Mount Adaptor (sold separately) is required to use an A-mount lens (sold separately). For details, refer to the operating manual supplied with the Mount Adaptor.
- When using a lens equipped with a tripod socket, attach the socket on the lens side to the tripod to maintain balance.

■ Removing the lens

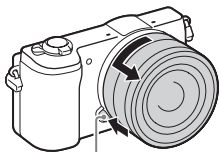

Lens release button

-
- 1 Press the lens release button all the way in and turn the lens counterclockwise until it stops.
-

Notes

- If dust or debris gets inside the camera while you are changing the lens and adheres to the surface of the image sensor (the part that converts the light source to a digital signal), it may appear as dark spots on the image, depending on the shooting environment. The camera vibrates slightly when it is turned off, due to the anti-dust function, to prevent dust from adhering to the image sensor. However, attach or remove the lens quickly somewhere away from dusty locations.
- If foreign material attaches to the image sensor, dust it off using a blower.
- Do not leave the camera with the lens removed.
- When you want to use body caps or rear lens caps, please purchase ALC-B1EM (Body cap) or ALC-R1EM (Rear lens cap) (sold separately).
- When you use a lens with a power zoom, set the power switch of the camera to OFF and confirm that the lens is completely retracted before switching lenses. If the lens has not retracted, do not press the lens in by force.
- When attaching the camera to a tripod, be sure not to touch the zooming/focusing ring by mistake.

Inserting a memory card (sold separately)

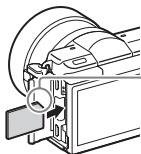

Ensure that the notched corner is faced correctly.

1 Open the cover.

2 Insert the memory card (sold separately).

- With the notched corner facing as illustrated, insert the memory card until it clicks into place.

3 Close the cover.

Memory cards that can be used

	Memory card	For still images	For movies
A	Memory Stick XC-HG Duo™	✓	✓
	Memory Stick PRO Duo™	✓	✓ (Mark2 only)
	Memory Stick PRO-HG Duo™	✓	✓
B	SD memory card	✓	✓ (Class 4 or faster)
	SDHC memory card	✓	✓ (Class 4 or faster)
	SDXC memory card	✓	✓ (Class 4 or faster)

• In this manual, the products in the table are collectively referred to as follows:

A: Memory Stick PRO Duo media

B: SD card

To remove the memory card/battery pack

Memory card: Push the memory card in once to eject the memory card.

Battery pack: Slide the battery eject lever. Be sure not to drop the battery pack.

Notes

- Never remove the memory card/battery pack when the access lamp (page 11) is lit. This may cause damage to data in the memory card.

Setting the clock

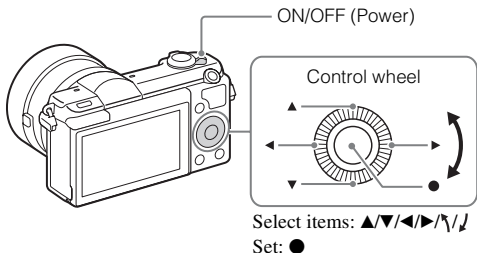

- 1** Set the ON/OFF (Power) switch to ON.
The Date & Time setting is displayed when you turn on the camera for the first time.
 - It may take some time for the power to turn on and allow operation.
- 2** Check that [Enter] is selected on the screen, then press ● on the control wheel.
- 3** Select a desired geographic location by following the on-screen instructions, then press ●.
- 4** Set [Daylight Savings], [Date/Time] and [Date Format], then press ●.
 - When setting [Date/Time], midnight is 12:00 AM, and noon is 12:00 PM.
- 5** Check that [Enter] is selected, then press ●.

Shooting still images/movies

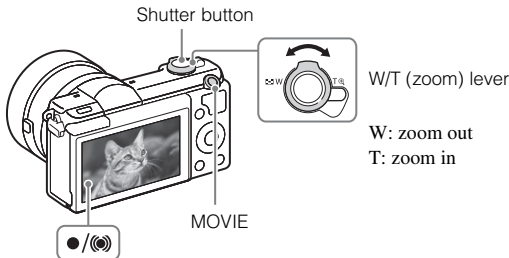

Shooting still images

- 1 Press the shutter button halfway down to focus.
When the image is in focus, a beep sounds and the ● or (●) indicator lights.
- 2 Press the shutter button fully down to shoot an image.

Shooting movies

- 1 Press the MOVIE (Movie) button to start recording.
 - Use the W/T (zoom) to change the zoom ratio.
- 2 Press the MOVIE button again to stop recording.

Notes

- Do not pull up the flash manually. This may cause a malfunction.
- When using the zoom function while shooting a movie, the sound of the camera operating will be recorded. The sound of the MOVIE button operating may also be recorded when movie recording is finished.
- Continuous movie shooting is possible for approximately 29 minutes at one time with the camera's default settings and when the ambient temperature is approximately 25°C (77°F). When movie recording is finished, you can restart recording by pressing the MOVIE button again. Recording may stop to protect the camera depending on the ambient temperature.

Viewing images

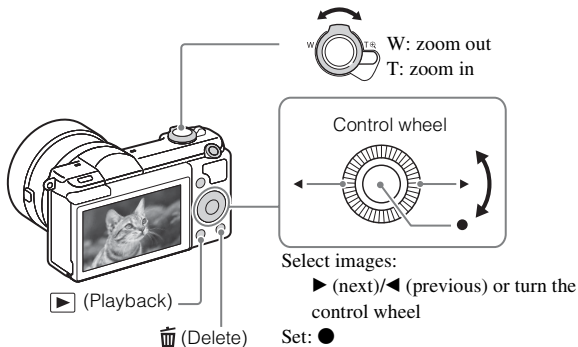

1 Press the ► (Playback) button.

■ Selecting next/previous image

Select an image by pressing ► (next)/◄ (previous) on the control wheel or by turning the control wheel. Press ● in the center of the control wheel to view movies.

■ Deleting an image

- 1 Press the 🗑️ (Delete) button.
- 2 Select [Delete] with ▲ on the control wheel, then press ●.

■ Returning to shooting images

Press the shutter button halfway down.

Introduction of other functions

Other functions can be operated using the control wheel, MENU button, etc.

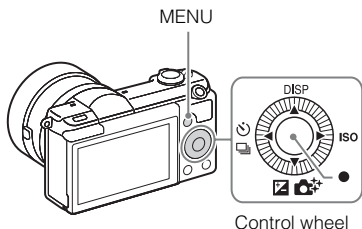



■ Control wheel

DISP (Display Contents): Allows you to change the screen display.

ISO (ISO): Allows you to set the sensitivity based on the brightness.

 (Exposure Comp.): Allows you to compensate the exposure and brightness for the entire image.





 (Photo Creativity): Allows you to operate the camera intuitively and shoot creative images easily.





 /  (Drive Mode): Allows you to switch between shooting methods, such as single shooting, continuous shooting or bracket shooting.

 (Shoot Mode): Allows you to change the shooting mode.

■ Menu Items



(Camera Settings)

Shoot Mode	Selects the shooting mode.
 Image Size	Selects the size of still images.
 Aspect Ratio	Selects the aspect ratio for still images.
 Quality	Sets the image quality for still images.
Panorama: Size	Selects the size of panoramic images.
Panorama: Direction	Sets the shooting direction for panoramic images.
 File Format	Selects the movie file format.
 Record Setting	Selects the size of the recorded movie frame.
Drive Mode	Sets the drive mode, such as for continuous shooting.

Flash Mode	Sets the flash settings.
Flash Comp.	Adjusts the intensity of flash output.
Red Eye Reduction	Reduces the red-eye phenomenon when using flash.
Focus Mode	Selects the focus method.
Focus Area	Selects the area of focus.
 AF Illuminator	Sets the AF illuminator, which provides light for a dark scene to aid focusing.
Exposure Comp.	Compensates the brightness of the entire image.
ISO	Adjusts the luminous sensitivity.
Metering Mode	Selects the metering mode that sets which part of the subject to measure to determine the exposure.
White Balance	Adjusts the color tones of an image.
DRO/Auto HDR	Compensates automatically for brightness and contrast.
Creative Style	Selects the desired image processing.
Picture Effect	Selects the desired effect filter to achieve a more impressive and artistic expression.
Focus Magnifier	Enlarges the image before shooting so that you can check the focus in detail.
 High ISO NR	Sets noise reduction processing for high-sensitivity shooting.
Lock-on AF	Sets the function to track a subject and continue focusing.
Smile/Face Detect.	Selects to detect faces and adjust various settings automatically. Sets to automatically release the shutter when a smile is detected.
 Soft Skin Effect	Sets the Soft Skin Effect and the effect level.
 Auto Obj. Framing	Analyzes the scene when capturing faces, close-ups, or subjects tracked by the Lock-on AF function, and automatically trims and saves another copy of the image with a more impressive composition.
SteadyShot	Sets SteadyShot for shooting still images and movies. Reduces blur from camera shake when shooting while holding the camera with your hands.
 Color Space	Changes the range of reproducible colors.

 Auto Slow Shut.	Sets the function that automatically adjusts the shutter speed following the brightness of the environment.
Audio Recording	Sets whether to record audio when shooting a movie.
Wind Noise Reduct.	Reduces wind noise during movie recording.
Shooting Tip List	Displays the shooting tip list.

(Custom Settings)

Zebra	Displays stripes to adjust brightness.
 MF Assist	Displays an enlarged image when focusing manually.
Focus Magnif. Time	Sets the length of time the image will be shown in an enlarged form.
Grid Line	Sets a grid line display to enable alignment to a structural outline.
Auto Review	Sets auto review to display the captured image after shooting.
DISP Button	Sets the screen display modes that can be selected by pressing DISP on the control wheel.
Peaking Level	Enhances the outline of in-focus ranges with a specific color when focusing manually.
Peaking Color	Sets the color used for the peaking function.
Exposure Set. Guide	Sets the guide to be displayed when you change the exposure setting on the shooting screen.
Live View Display	Sets whether or not to reflect settings such as exposure compensation in screen display.
 Pre-AF	Sets whether or not to perform auto focus before the shutter button is half pressed.
Zoom Setting	Sets whether to use the Clear Image Zoom and Digital Zoom when zooming.
Release w/o Lens	Sets whether or not to release the shutter when there is no lens.
 AEL w/ shutter	Sets whether to perform AEL when the shutter button is half pressed.
Self-portrait/ -timer	Sets whether to use a 3-second delay self-timer when the screen is tilted upward about 180 degrees.

S. Auto Img. Extract.	When the shooting mode is set to [Superior Auto] and the camera recognizes the scene to be shot with multiple images, this sets whether to extract an image automatically and save it.
Face Registration	Registers or changes the person to be given priority in the focus.
Custom Key Settings	Assigns a desired function to the button.
MOVIE Button	Sets whether to always activate the MOVIE button.
AF Micro Adj.	Finely adjusts the autofocused position, when using the LA-EA2 or LA-EA4 Mount Adaptor (sold separately).
Lens Comp.	Selects the type of the lens compensation.

(Wireless)

Send to Smartphone	Transfers images to display on a smartphone.
Send to Computer	Backs up images by transferring them to a computer connected to a network.
View on TV	You can view images on a network-enabled TV.
One-touch(NFC)	Assigns an application to One-touch (NFC). You can call up the application when shooting by touching an NFC-enabled smartphone to the camera.
Airplane Mode	You can set this device to not perform wireless communications.
WPS Push	You can register the access point to the camera easily by pushing the WPS button.
Access Point Set.	You can register your access point manually.
Edit Device Name	You can change the device name under Wi-Fi Direct, etc.
Disp MAC Address	Displays the MAC address of the camera.
SSID/PW Reset	Resets the SSID and password for the smartphone connection.
Reset Network Set.	Resets all network settings.

(Application)

Application List	Displays the application list. You can select the application you want to use.
Introduction	Displays instructions on using the application.

(Playback)

Delete	Deletes an image.
View Mode	Sets the way in which images are grouped for playback.
Image Index	Displays multiple images at the same time.
Display Rotation	Sets the playback direction of the recorded image.
Slide Show	Shows a slide show.
Rotate	Rotates the image.
 Enlarge Image	Enlarges the playback images.
4K Still Image PB	Outputs still images in 4K resolution to an HDMI-connected TV that supports 4K.
Protect	Protects the images.
Specify Printing	Adds a print order mark to a still image.

(Setup)

Monitor Brightness	Sets the screen brightness.
Volume Settings	Sets the volume for movie playback.
Audio signals	Sets the operating sound on/off for when the image is in focus or when the self-timer is started.
Upload Settings	Sets the upload function of the camera when using an Eye-Fi card.
Tile Menu	Sets whether to display the tile menu every time you press the MENU button.
Delete confirm.	Sets whether Delete or Cancel is preselected in the Delete confirmation screen.
Pwr Save Start Time	Sets the length of time until the camera turns off automatically.
PAL/NTSC Selector (only for 1080 50i compatible models)	By changing the TV format of the device, shooting in a different movie format is possible.

Demo Mode	Sets demonstration movie playback to on or off.
HDMI Resolution	Sets the resolution when the camera is connected to an HDMI TV.
CTRL FOR HDMI	Operates the camera from a TV that supports BRAVIA™ Sync.
USB Connection	Sets the USB connection method.
USB LUN Setting	Enhances compatibility by limiting the functions of the USB connection.
 Language	Selects the language.
Date/Time Setup	Sets the date and time, and daylight savings.
Area Setting	Sets the location of use.
Format	Formats the memory card.
File Number	Sets the method used to assign file numbers to still images and movies.
Select REC Folder	Changes the selected folder for storing images.
New Folder	Creates a new folder for storing still images and movies (MP4).
Folder Name	Sets the folder name for still images.
Recover Image DB	Recovers the image database file and enables recording and playback.
Display Media Info.	Displays the remaining recording time of movies and the recordable number of still images on the memory card.
Version	Displays the camera software version.
Certification Logo*	The certification can be displayed on the camera.
Setting Reset	Restores settings to their defaults.

* Overseas model only

Features of PlayMemories Home

The software PlayMemories Home allows you to import still images and movies to your computer and use them. PlayMemories Home is required for importing AVCHD movies to your computer.



Importing images from your camera



Playing back imported images



For Windows, the following functions are also available:



Viewing images on a calendar



Creating movie discs



Uploading images to network services

Sharing images on PlayMemories Online™



- You can download Image Data Converter (RAW image editing software) or Remote Camera Control, etc. by performing the following procedure:
Connect the camera to your computer → launch PlayMemories Home → click [Notifications].



Notes

- An Internet connection is required to install PlayMemories Home.
- An Internet connection is required to use PlayMemories Online or other network services. PlayMemories Online or other network services may not be available in some countries or regions.
- Use the following URL for Mac applications:
<http://www.sony.co.jp/imsoft/Mac/>
- If the software PMB (Picture Motion Browser), supplied with models released before 2011, has already been installed on your computer, PlayMemories Home will overwrite it during the installation. Use PlayMemories Home, the successor software of PMB.

■ Installing PlayMemories Home on a computer

- 1 Using the Internet browser on your computer, go to the following URL, and then click [Install] → [Run].
www.sony.net/pm/
 - 2 Follow the instructions on the screen to complete the installation.
 - For details on PlayMemories Home, refer to the following PlayMemories Home support page (English only):
<http://www.sony.co.jp/pmh-se/>
 - When installation is complete, PlayMemories Home starts.
 - 3 Connect the camera to your computer using the micro USB cable (supplied).
 - New functions may be installed in PlayMemories Home. Connect the camera to your computer even if PlayMemories Home is already installed on your computer.
-

Notes

- Do not disconnect the micro USB cable (supplied) from the camera while the operating screen or the accessing screen is displayed. Doing so may damage the data.
- To disconnect the camera from the computer, click  on the tasktray, then click  (disconnect icon). For Windows Vista, click  on the tasktray.

Adding functions to the camera

You can add the desired functions to your camera by connecting to the application download website  (PlayMemories Camera Apps™) via the Internet.

<http://www.sony.net/pmca>

- After installing an application, you can call up the application by touching an NFC-enabled Android smartphone to the N mark on the camera, using the [One-touch(NFC)] function.

Number of still images and recordable time of movies

The number of still images and recordable time may vary depending on the shooting conditions and the memory card.

Still images

[Image Size]: L: 20M

When [Aspect Ratio] is set to [3:2]*

Quality \ Capacity	2 GB
Standard	385 images
Fine	240 images
RAW & JPEG	65 images
RAW	89 images

* When the [Aspect Ratio] is set to other than [3:2], you can record more pictures than shown above. (Except when [Quality] is set to [RAW].)

Movies

The table below shows the approximate maximum recording times. These are the total times for all movie files. Continuous shooting is possible for approximately 29 minutes (a product specification limit). The maximum continuous recording time of an MP4 (12M) format movie is about 20 minutes (limited by the 2 GB file size restriction).

(h (hour), m (minute))

Record Setting \ Capacity	2 GB
60i 24M(FX)/50i 24M(FX)	10 m
60i 17M(FH)/50i 17M(FH)	10 m
24p 24M(FX)/25p 24M(FX)	10 m
24p 17M(FH)/25p 17M(FH)	10 m
1440×1080 12M	20 m
VGA 3M	1 h 10 m

- The recordable time of movies varies because the camera is equipped with VBR (Variable Bit-Rate), which automatically adjusts the image quality depending on the shooting scene. When you record a fast-moving subject, the image is clearer but the recordable time is shorter because more memory is required for recording. The recordable time also varies depending on the shooting conditions, the subject or the image quality/size settings.

Notes on using the camera

Functions built into this camera

- This manual describes 1080 60i-compatible devices and 1080 50i-compatible devices.

To check whether your camera is a 1080 60i-compatible device or 1080 50i-compatible device, check for the following marks on the bottom of the camera.

1080 60i-compatible device: 60i

1080 50i-compatible device: 50i

On use and care

Avoid rough handling, disassembling, modifying, physical shock, or impact such as hammering, dropping, or stepping on the product. Be particularly careful of the lens.

Notes on recording/playback

- Before you start recording, make a trial recording to make sure that the camera is working correctly.
- This camera is neither dust-proof, nor splash-proof, nor water-proof.
- Do not aim the camera at the sun or other bright light. It may cause a malfunction of the camera.
- Do not look at the sun or a strong light through a removed lens. This may cause irrecoverable damage to your eyes. Or it may cause a malfunction of the lens.
- If moisture condensation occurs, remove it before using the camera.
- Do not shake or strike the camera. It may cause a malfunction and you may not be able to record images. Furthermore, the recording media may become unusable or image data may be damaged.

Do not use/store the camera in the following places

- In an extremely hot, cold or humid place
In places such as in a car parked in the sun, the camera body may become deformed and this may cause a malfunction.
- Under direct sunlight or near a heater
The camera body may become discolored or deformed, and this may cause a malfunction.
- In a location subject to shaking or vibration
- Near a location that generates strong radio waves, emits radiation or is strongly magnetic
In such locations, the camera may not properly record or play back images.

- In sandy or dusty places

Be careful not to let sand or dust get into the camera. This may cause the camera to malfunction, and in some cases this malfunction cannot be repaired.

About the grip

The grip is applied with a special coating. The grip may be discolored if it is rubbed with a dark colored cloth, leather, etc.

On storing

Be sure to attach the front lens cap when not using the camera.

Notes on the screen and lens

- The screen is manufactured using extremely high-precision technology, and over 99.99% of the pixels are operational for effective use. However, some tiny black and/or bright dots (white, red, blue or green) may appear on the screen. These dots are a normal result of the manufacturing process, and do not affect the recording.
- There are magnets attached to the back of the screen and in the area around the flash. Do not put objects that are affected by magnetic fields, such as a floppy disk or a credit card to the screen or the camera body.
- When the lens is operating, be careful not to let your finger be caught by the lens.

On using the lenses and accessories

It is recommended that you use Sony lenses/accessories designed to suit the characteristics of this camera.

Using the products of other manufacturers may cause the camera not to operate to its capability, or result in accidents and malfunctions of the camera.

Notes on the flash

- Do not carry the camera by the flash unit, or use excessive force on it.
- If water, dust or sand get into the open flash unit, it may cause a malfunction.
- Be sure to keep your fingers out of the way when you press the flash down.

On camera's temperature

Your camera and battery may get hot due to continuous use, but it is not a malfunction.

On the overheat protection

Depending on the camera and battery temperature, you may be unable to record movies or the power may turn off automatically to protect the camera.

A message will be displayed on the screen before the power turns off or you can no longer record movies. In this case, leave the power off and wait until the camera and battery temperature goes down. If you turn on the power without letting the camera and battery cool down enough, the power may turn off again or you may be unable to record movies.

On charging the battery

If you charge a battery that has not been used for a long time, you may be unable to charge it to the proper capacity.

This is due to the battery characteristics. Charge the battery again.

Warning on copyright

Television programs, films, videotapes, and other materials may be copyrighted. Unauthorized recording of such materials may be contrary to the provisions of the copyright laws.

No guarantee in the case of damaged content or recording failures

Sony cannot provide a guarantee in the case of failure to record or loss or damage of recorded content due to a malfunction of the camera or recording media, etc.

Cleaning the camera surface

Clean the camera surface with a soft cloth slightly moistened with water, then wipe the surface with a dry cloth. To prevent damage to the finish or casing:

- Do not expose the camera to chemical products such as thinner, benzine, alcohol, disposable cloths, insect repellent, sunscreen or insecticide.

Maintaining the screen

- Hand cream or moisturizer left on the screen may dissolve its coating. If you get any on the screen, wipe it off immediately.
- Wiping forcefully with tissue paper or other materials can damage the coating.
- If fingerprints or debris are stuck to the screen, we recommend that you gently remove any debris and then wipe the screen clean with a soft cloth.

Notes on wireless LAN

We assume no responsibility whatsoever for any damage caused by unauthorized access to, or unauthorized use of, destinations loaded on the camera, resulting from loss or theft.

Notes on disposal/transfer of the camera

To protect personal data, perform the following when disposing of or transferring the camera.

- Reset all camera settings by performing [Setting Reset] (page 28).

Specifications

Camera

[System]

Camera type: Interchangeable lens digital camera
Lens: E-mount lens

[Image sensor]

Image sensor: APS-C format (23.2 mm × 15.4 mm) CMOS image sensor
Total pixel number of image sensor: Approx. 20 400 000 pixels
Effective pixel number of camera: Approx. 20 100 000 pixels

[Auto focus system]

System: Contrast detection system
Sensitivity range: EV0 to EV20 (at ISO 100 equivalent, with F2.8 lens)

[Exposure control]

Metering method: 1 200-segment metering by the image sensor
Metering range: EV0 to EV20 (at ISO 100 equivalent, with F2.8 lens)
ISO sensitivity (Recommended exposure index):
Still images: AUTO, ISO 100 – ISO 16 000
Movies: AUTO, ISO 100 – ISO 6 400 equivalent
Exposure compensation: ±3.0 EV (1/3 EV step)

[Shutter]

Type: Electronically-controlled, vertical-traverse, focal-plane type

Speed range:

Still images: 1/4 000 second to 30 seconds, BULB

Movies: 1/4 000 second to 1/4 second (1/3 EV step), 1080 60i-compatible device up to 1/60 second in AUTO mode (up to 1/30 second in [Auto Slow Shut.] mode)

1080 50i-compatible device up to 1/50 second in AUTO mode (up to 1/25 second in [Auto Slow Shut.] mode)

Flash sync speed: 1/160 second

[Recording media]

Memory Stick PRO Duo media, SD card

[LCD screen]

LCD panel: Wide, 7.5 cm (3.0 type) TFT drive

Total number of dots: 460 800 dots

[Input/output terminals]

Multi/Micro USB Terminal*:
USB communication

HDMI: HDMI type D micro jack

* Supports Micro USB compatible device.

[Power]

Battery type: Rechargeable battery pack NP-FW50

[Power consumption]

When using an E PZ 16 – 50 mm F3.5
– 5.6 OSS lens*
Approx. 2.2 W
* supplied with ILCE-5000L/
ILCE-5000Y

[Others]

Exif Print: Compatible
PRINT Image Matching III:
Compatible
DPOF: Compatible
Dimensions (CIPA compliant)
(Approx.):
109.6 mm × 62.8 mm × 35.7 mm
(4 3/8 inches × 2 1/2 inches ×
1 7/16 inches) (W/H/D)
Mass (CIPA compliant) (Approx.):
269 g (9.5 oz)
(including battery and Memory
Stick PRO Duo media)
210 g (7.4 oz) (camera only)
Operating temperature: 0 °C to 40 °C
(32 °F to 104 °F)
File format:
Still image: JPEG compliant (DCF
Ver. 2.0, Exif Ver. 2.3, MPF
Baseline), RAW (Sony ARW 2.3
Format)
Movie (AVCHD format): AVCHD
format Ver. 2.0 compatible
Video: MPEG-4 AVC/H.264
Audio: Dolby Digital 2ch
Dolby Digital Stereo Creator

- Manufactured under license from
Dolby Laboratories.
Movie (MP4 format):
Video: MPEG-4 AVC/H.264
Audio: MPEG-4 AAC-LC 2ch

USB communication: Hi-Speed USB
(USB 2.0)

[Flash]

Flash guide number: 4 (in meters at
ISO 100)
Recycling time: Approx. 3 seconds
Flash coverage: Covering 16 mm lens
(focal length that the lens indicates)
Flash compensation: ±2.0 EV (1/3 EV
step)

[Wireless LAN]

Supported format: IEEE 802.11 b/g/n
Frequency band: 2.4 GHz
Supported security protocols: WEP/
WPA-PSK/WPA2-PSK
Configuration method: WPS (Wi-Fi
Protected Setup)/Manual
Access method: Infrastructure mode
NFC: NFC Forum Type 3 Tag-
compliant

AC Adaptor AC-UB10C/UB10D

Power requirements: AC 100 V to
240 V, 50 Hz/60 Hz, 70 mA
Output voltage: DC 5 V, 0.5 A
Operating temperature: 0 °C to 40 °C
(32 °F to 104 °F)
Storage temperature: –20 °C to +60 °C
(–4 °F to +140 °F)
Dimensions (Approx.):
50 mm × 22 mm × 54 mm
(2 inches × 7/8 inches ×
2 1/4 inches) (W/H/D)

**Rechargeable battery pack
NP-FW50**

Battery type: Lithium-ion battery
Maximum voltage: DC 8.4 V
Nominal voltage: DC 7.2 V
Maximum charge voltage: DC 8.4 V
Maximum charge current: 1.02 A
Capacity: Typical 7.7 Wh (1 080 mAh)
Minimum 7.3 Wh (1 020 mAh)

Lens

Lens	E16 – 50 mm zoom lens ¹⁾	E55 – 210 mm zoom lens
Camera	ILCE-5000L/ ILCE-5000Y	ILCE-5000Y
Equivalent 35 mm-format focal length ²⁾ (mm)	24 – 75	82.5 – 315
Lens groups/elements	8 – 9	9 – 13
Angle of view ²⁾	83° – 32°	28.2° – 7.8°
Minimum focus ³⁾ (m (feet))	0.25 – 0.3 (0.82 – 1)	1.0 (3.28)
Maximum magnification (×)	0.215	0.225
Minimum aperture	f/22 – f/36	f/22 – f/32
Filter diameter (mm)	40.5	49
Dimensions (max. diameter × height) (Approx. mm (in.))	64.7 × 29.9 (2 5/8 × 1 3/16)	63.8 × 108 (2 5/8 × 4 3/8)
Mass (Approx. g (oz.))	116 (4.1)	345 (12.2)
SteadyShot	Available	Available

1) Power zoom.

2) The values for equivalent 35 mm-format focal length and angle of view are based on digital cameras equipped with an APS-C sized image sensor.

3) Minimum focus is the shortest distance from the image sensor to the subject.

Design and specifications are subject to change without notice.

On focal length

The picture angle of this camera is narrower than that of a 35 mm-format camera. You can find the approximate equivalent of the focal length of a 35 mm-format camera, and shoot with the same picture angle, by increasing the focal length of your lens by half.

For example, by using a 50 mm lens, you can get the approximate equivalent of a 75 mm lens of a 35 mm-format camera.

Trademarks

- Memory Stick and  are trademarks or registered trademarks of Sony Corporation.
- “AVCHD” and the “AVCHD” logotype are trademarks of Panasonic Corporation and Sony Corporation.
- Dolby and the double-D symbol are trademarks of Dolby Laboratories.
- The terms HDMI and HDMI High-Definition Multimedia Interface, and the HDMI Logo are trademarks or registered trademarks of HDMI Licensing LLC in the United States and other countries.
- Windows is a registered trademark of Microsoft Corporation in the United States and/or other countries.
- Mac is a registered trademark of Apple Inc. in the United States and other countries.
- iOS is a registered trademark or trademark of Cisco Systems, Inc.
- iPhone and iPad are registered trademarks of Apple Inc. in the United States and other countries.
- SDXC logo is a trademark of SD-3C, LLC.
- Android, Google Play are trademarks of Google Inc.
- Wi-Fi, the Wi-Fi logo and Wi-Fi PROTECTED SET-UP are registered trademarks of the Wi-Fi Alliance.
- The N Mark is a trademark or registered trademark of NFC Forum, Inc. in the United States and in other countries.
- DLNA and DLNA CERTIFIED are trademarks of Digital Living Network Alliance.
- Facebook and the “f” logo are trademarks or registered trademarks of Facebook, Inc.
- YouTube and the YouTube logo are trademarks or registered trademarks of Google Inc.
- Eye-Fi is a trademark of Eye-Fi, Inc.
- In addition, system and product names used in this manual are, in general, trademarks or registered trademarks of their respective developers or manufacturers. However, the TM or [®] marks may not be used in all cases in this manual.





<http://www.sony.net/SonyInfo/Support/>

Additional information on this product and answers to frequently asked questions can be found at our Customer Support Website.

<http://www.sony.net/>

© 2014 Sony Corporation Printed in Thailand



4487947120