



DLP® Projector

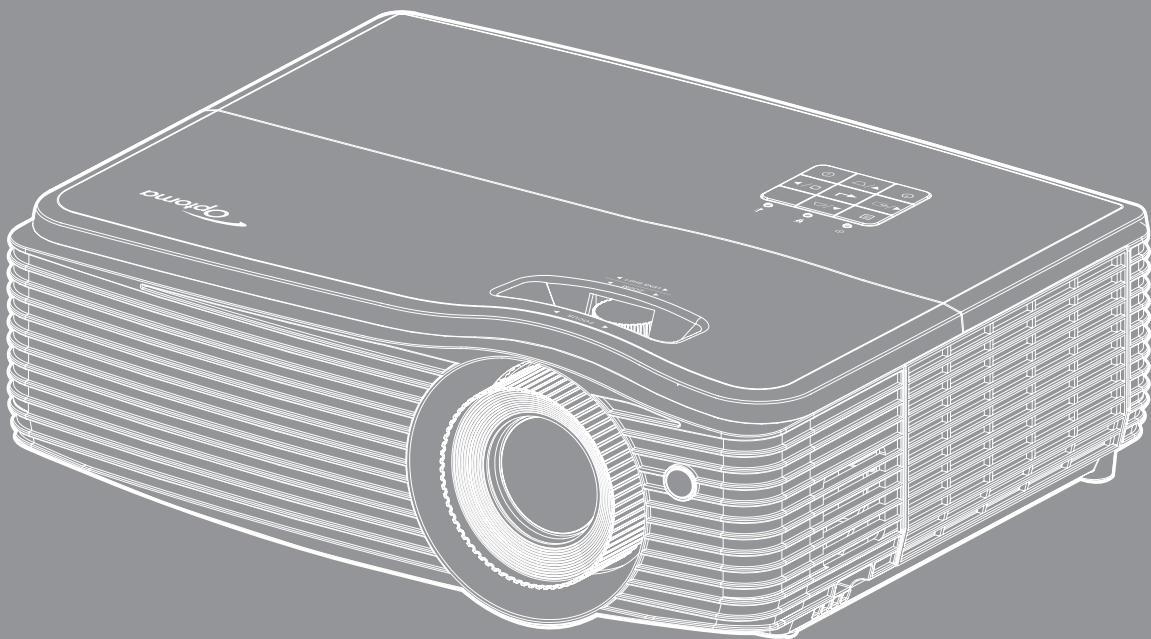

TABLE OF CONTENTS

SAFETY	4
<i>Important Safety Instruction.....</i>	<i>4</i>
<i>3D Safety Information.....</i>	<i>5</i>
<i>Copyright.....</i>	<i>6</i>
<i>Disclaimer.....</i>	<i>6</i>
<i>Trademark Recognition</i>	<i>6</i>
<i>FCC</i>	<i>7</i>
<i>Declaration of Conformity for EU countries</i>	<i>7</i>
<i>WEEE.....</i>	<i>7</i>
INTRODUCTION.....	8
<i>Package Overview.....</i>	<i>8</i>
<i>Standard accessories.....</i>	<i>8</i>
<i>Optional accessories.....</i>	<i>8</i>
<i>Product Overview</i>	<i>9</i>
<i>Connections (1080P / WXGA).....</i>	<i>10</i>
<i>Connections (XGA).....</i>	<i>11</i>
<i>Keypad</i>	<i>12</i>
<i>Remote Control</i>	<i>13</i>
SETUP AND INSTALLATION.....	14
<i>Installing the projector</i>	<i>14</i>
<i>Connecting sources to the projector (1080P / WXGA).....</i>	<i>15</i>
<i>Connecting sources to the projector (XGA).....</i>	<i>16</i>
<i>Adjusting the projector image.....</i>	<i>17</i>
<i>Remote setup</i>	<i>18</i>
USING THE PROJECTOR.....	20
<i>Powering on / off the projector.....</i>	<i>20</i>
<i>Selecting an input source</i>	<i>21</i>
<i>Menu navigation and features</i>	<i>22</i>
<i>OSD Menu tree.....</i>	<i>23</i>
<i>Image menu.....</i>	<i>31</i>
<i>Image Advanced menu.....</i>	<i>33</i>
<i>Image advanced signal (RGB) menu</i>	<i>35</i>
<i>Image advanced signal (video) menu.....</i>	<i>36</i>
<i>Display menu.....</i>	<i>37</i>
<i>Display geometric correction menu</i>	<i>40</i>
<i>Display 3D menu</i>	<i>41</i>
<i>Setup menu</i>	<i>42</i>

Setup audio settings menu	44
Setup audio settings volume menu	45
Setup Security menu	45
Setup network LAN settings menu	47
Setup network control settings menu	49
Setup network control settings menu	50
Setup advanced menu.....	55
Options menu	56
Options menu	57
Options menu	58
Options lamp settings menu	59
Options remote settings menu.....	60
Options advanced menu.....	61
Options optional filter settings menu	63
3D Setup.....	64

MAINTENANCE 65

Replacing the lamp.....	65
Replacing the lamp (continued).....	66
Installing and cleaning the dust filter	67

ADDITIONAL INFORMATION 68

Compatible resolutions	68
Image size and projection distance	69
Determining the lens shift center position.....	73
Projector dimensions and ceiling mount installation.....	74
RS232 protocol function list.....	75
IR remote codes	83
Using the Information button	85
Troubleshooting	86
Warning indicators.....	87
Specifications	89
Optoma global offices.....	92

SAFETY

	The lightning flash with arrow head within an equilateral triangle is intended to alert the user to the presence of uninsulated "dangerous voltage" within the product's enclosure that may be of sufficient magnitude to constitute a risk of electric shock to persons.
	The exclamation point within an equilateral triangle is intended to alert the user to the presence of important operating and maintenance (servicing) instructions in the literature accompanying the appliance.

Please follow all warnings, precautions and maintenance as recommended in this user's guide.

Important Safety Instruction

- Do not block any ventilation openings. To ensure reliable operation of the projector and to protect from over heating, it is recommended to install the projector in a location that does not block ventilation. As an example, do not place the projector on a crowded coffee table, sofa, bed, etc. Do not put the projector in an enclosure such as a book case or a cabinet that restricts air flow.
- To reduce the risk of fire and/or electric shock, do not expose the projector to rain or moisture. Do not install near heat sources such as radiators, heaters, stoves or any other apparatus such as amplifiers that emits heat.
- Do not let objects or liquids enter the projector. They may touch dangerous voltage points and short out parts that could result in fire or electric shock.
- Do not use under the following conditions:
 - In extremely hot, cold or humid environments.
 - (i) Ensure that the ambient room temperature is within 5°C ~ 40°C
 - (ii) Relative humidity is 10% ~ 85%
 - In areas susceptible to excessive dust and dirt.
 - Near any appliance generating a strong magnetic field.
 - In direct sunlight.
- Do not use the projector in places where flammable gases or explosives gases may be present in the atmosphere. The lamp inside the projector becomes very hot during operation and the gases may ignite and result in a fire.
- Do not use lens cap when projector is in operation.
- Do not use the unit if it has been physically damaged or abused. Physical damage/abuse would be (but not limited to):
 - Unit has been dropped.
 - Power supply cord or plug has been damaged.
 - Liquid has been spilled on to the projector.
 - Projector has been exposed to rain or moisture.
 - Something has fallen in the projector or something is loose inside.
- Do not place the projector on an unstable surface. The projector may fall over resulting in injury or the projector may become damaged.
- Do not block the light coming out of the projector lens when in operation. The light will heat the object and may melt, cause burns or start a fire.
- Please do not open or disassemble the projector as this may cause electric shock.
- Do not attempt to service the unit yourself. Opening or removing covers may expose you to dangerous voltages or other hazards. Please call Optoma before you send the unit for repair.
- See projector enclosure for safety related markings.

- The unit should only be repaired by appropriate service personnel.
- Only use attachments/accessories specified by the manufacturer.
- Do not look into straight into the projector lens during operation. The bright light may harm your eyes.
- When replacing the lamp, please allow the unit to cool down. Follow instructions as described on pages 65-66.
- This projector will detect the life of the lamp itself. Please be sure to change the lamp when it shows warning messages.
- Reset the "Lamp Reset" function from the on-screen display "Options lamp settings" menu after replacing the lamp module (refer to page 59).
- When switching the projector off, please ensure the cooling cycle has been completed before disconnecting power. Allow 90 seconds for the projector to cool down.
- When the lamp is approaching to the end of its life time, the message "Lamp life exceeded." will show on the screen. Please contact your local reseller or service center to change the lamp as soon as possible.
- Turn off and unplug the power plug from the AC outlet before cleaning the product.
- Use a soft dry cloth with mild detergent to clean the display housing. Do not use abrasive cleaners, waxes or solvents to clean the unit.
- Disconnect the power plug from AC outlet if the product is not being used for a long period of time.

Note: *When the lamp reaches the end of its life, the projector will not turn back on until the lamp module has been replaced. To replace the lamp, follow the procedures listed under "Replacing the Lamp" section on pages 65-66.*

- *Do not setup the projector in places where it might be subjected to vibration or shock.*
- *Do not touch the lens with bare hands*
- *Remove battery/batteries from remote control before storage. If the battery/batteries are left in the remote for long periods, they may leak.*
- *Do not use or store the projector in places where smoke from oil or cigarettes may be present, as it can adversely affect the quality of the projector performance.*
- *Please follow the correct projector orientation installation as non standard installation may affect the projector performance.*

3D Safety Information

Please follow all warnings and precautions as recommended before you or your child use the 3D function.

Warning

Children and teenagers may be more susceptible to health issues associated with viewing in 3D and should be closely supervised when viewing these images.

Photosensitive Seizure Warning and Other Health Risks

- Some viewers may experience an epileptic seizure or stroke when exposed to certain flashing images or lights contained in certain Projector pictures or video games. If you suffer from, or have a family history of epilepsy or strokes, please consult with a medical specialist before using the 3D function.
- Even those without a personal or family history of epilepsy or stroke may have an undiagnosed condition that can cause photosensitive epileptic seizures.
- Pregnant women, the elderly, sufferers of serious medical conditions, those who are sleep deprived or under the influence of alcohol should avoid utilizing the unit's 3D functionality.
- If you experience any of the following symptoms, stop viewing 3D pictures immediately and consult a medical specialist: (1) altered vision; (2) light-headedness; (3) dizziness; (4) involuntary movements such as eye or muscle twitching; (5) confusion; (6) nausea; (7) loss of awareness; (8) convulsions; (9) cramps; and/ or (10) disorientation. Children and teenagers may be more likely than adults to experience these symptoms. Parents should monitor their children and ask whether they are experiencing these symptoms.

- Watching 3D projection may also cause motion sickness, perceptual after effects, disorientation, eye strain and decreased postural stability. It is recommended that users take frequent breaks to lessen the potential of these effects. If your eyes show signs of fatigue or dryness or if you have any of the above symptoms, immediately discontinue use of this device and do not resume using it for at least thirty minutes after the symptoms have subsided.
- Watching 3D projection while sitting too close to the screen for an extended period of time may damage your eyesight. The ideal viewing distance should be at least three times the screen height. It is recommended that the viewer's eyes are level with the screen.
- Watching 3D projection while wearing 3D glasses for an extended period of time may cause a headache or fatigue. If you experience a headache, fatigue or dizziness, stop viewing the 3D projection and rest.
- Do not use the 3D glasses for any other purpose than for watching 3D projection.
- Wearing the 3D glasses for any other purpose (as general spectacles, sunglasses, protective goggles, etc.) may be physically harmful to you and may weaken your eyesight.
- Viewing in 3D projection may cause disorientation for some viewers. Accordingly, DO NOT place your 3D PROJECTOR near open stairwells, cables, balconies, or other objects that can be tripped over, run into, knocked down, broken or fallen over.

Copyright

This publication, including all photographs, illustrations and software, is protected under international copyright laws, with all rights reserved. Neither this manual, nor any of the material contained herein, may be reproduced without written consent of the author.

© Copyright 2015

Disclaimer

The information in this document is subject to change without notice. The manufacturer makes no representations or warranties with respect to the contents hereof and specifically disclaims any implied warranties of merchantability or fitness for any particular purpose. The manufacturer reserves the right to revise this publication and to make changes from time to time in the content hereof without obligation of the manufacturer to notify any person of such revision or changes.

Trademark Recognition

Kensington is a U.S. registered trademark of ACCO Brand Corporation with issued registrations and pending applications in other countries throughout the world.

HDMI, the HDMI Logo, and High-Definition Multimedia Interface are trademarks or registered trademarks of HDMI Licensing LLC in the United States and other countries.

IBM is a trademark or registered trademark of International Business Machines, Inc. Microsoft, PowerPoint, and Windows are trademarks or registered trademarks of Microsoft Corporation.

Adobe and Acrobat are trademarks or registered trademarks of Adobe Systems Incorporated.

DLP®, DLP Link and the DLP logo are registered trademarks of Texas Instruments and BrilliantColor™ is a trademark of Texas Instruments.

All other product names used in this manual are the properties of their respective owners and are Acknowledged.

MHL, Mobile High-Definition Link and the MHL Logo are trademarks or registered trademarks of MHL Licensing, LLC.

FCC

This device has been tested and found to comply with the limits for a Class B digital device pursuant to Part 15 of the FCC rules. These limits are designed to provide reasonable protection against harmful interference in a residential installation. This device generates, uses and can radiate radio frequency energy and, if not installed and used in accordance with the instructions, may cause harmful interference to radio communications.

However, there is no guarantee that interference will not occur in a particular installation. If this device does cause harmful interference to radio or television reception, which can be determined by turning the device off and on is encouraged to try to correct the interference by one or more of the following measures:

- Reorient or relocate the receiving antenna.
- Increase the separation between the device and receiver.
- Connect the device into an outlet on a circuit different from that to which the receiver is connected.
- Consult the dealer or an experienced radio/television technician for help.

Notice: Shielded cables

All connections to other computing devices must be made using shielded cables to maintain compliance with FCC regulations.

Caution

Changes or modifications not expressly approved by the manufacturer could void the user's authority, which is granted by the Federal Communications Commission, to operate this projector.

Operation Conditions

This device complies with Part 15 of the FCC Rules. Operation is subject to the following two conditions:

1. This device may not cause harmful interference and
2. This device must accept any interference received, including interference that may cause undesired operation.

Notice: Canadian users

This Class B digital apparatus complies with Canadian ICES-003.

Remarque à l'intention des utilisateurs canadiens

Cet appareil numérique de la classe B est conforme à la norme NMB-003 du Canada.

Declaration of Conformity for EU countries

- EMC Directive 2004/108/EC (including amendments)
- Low Voltage Directive 2006/95/EC
- R & TTE Directive 1999/5/EC (if product has RF function)

WEEE



Disposal instructions

Do not throw this electronic device into the trash when discarding. To minimize pollution and ensure utmost protection of the global environment, please recycle it.

INTRODUCTION

Package Overview

Carefully unpack and verify that you have the items listed below under standard accessories. Some of the items under optional accessories may not be available depending on the model, specification and your region of purchase. Please check with your place of purchase. Some accessories may vary from region to region.

The warranty card is only supplied in some specific regions. Please consult your dealer for detailed information.

Standard accessories

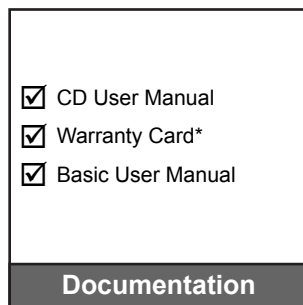
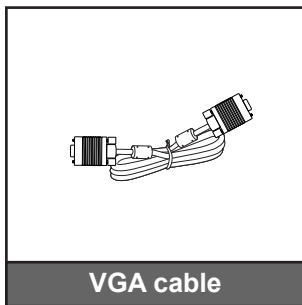
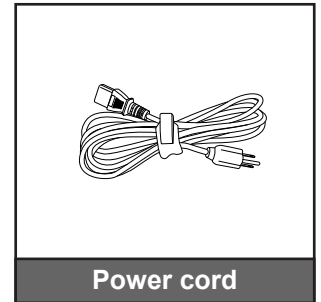
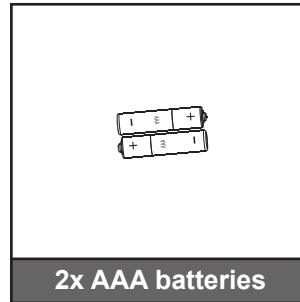
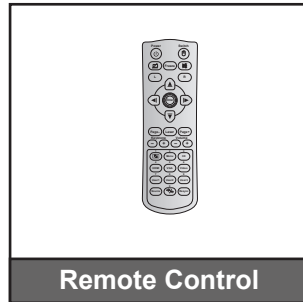
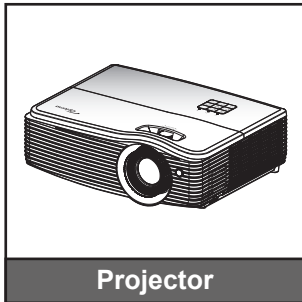

Note: * For European warranty Information, please visit www.optomaeurope.com.

Optional accessories

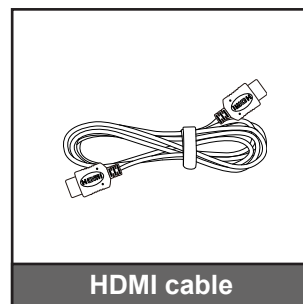

Note: Optional accessories vary depending on model, specification, and region.

INTRODUCTION

Product Overview

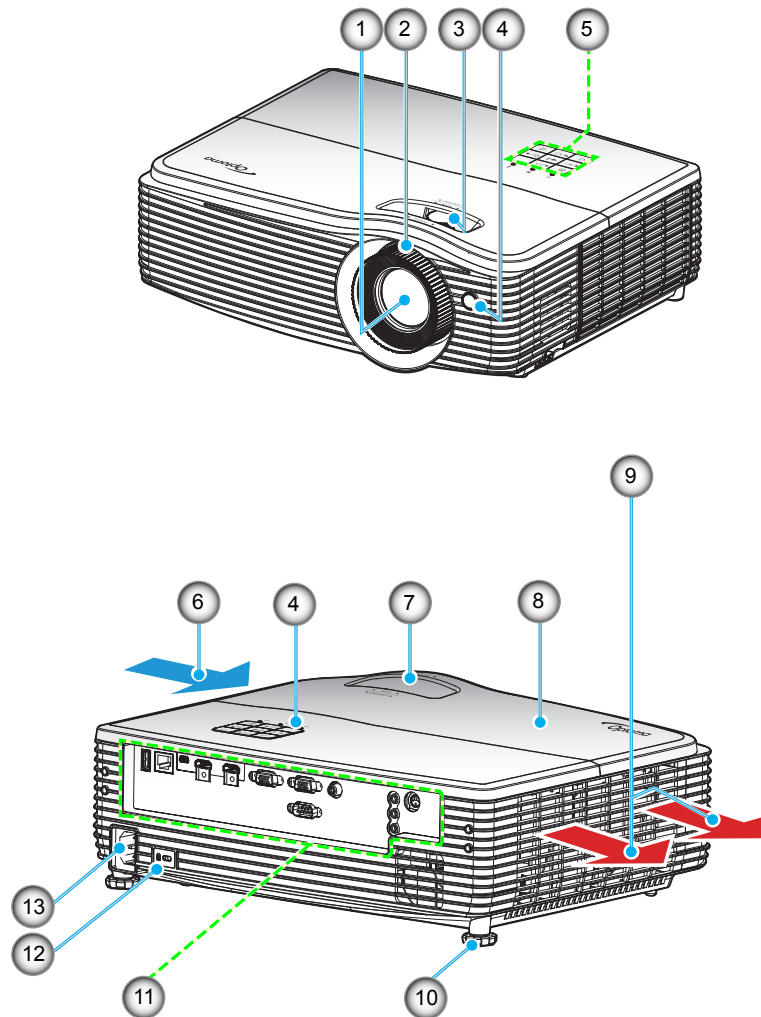

Note: Do not block projector inlet or outlet air vents.

No	Item	No	Item
1.	Lens	8.	Lamp Cover
2.	Focus Ring	9.	Ventilation (outlet)
3.	Lens Shift (vertical)	10.	Tilt-Adjustment Foot
4.	IR Receiver	11.	Input/Output Connectors
5.	Keypad	12.	Kensington™ Lock
6.	Ventilation (inlet)	13.	Power Socket
7.	Zoom Lever		

INTRODUCTION

Connections (1080P / WXGA)

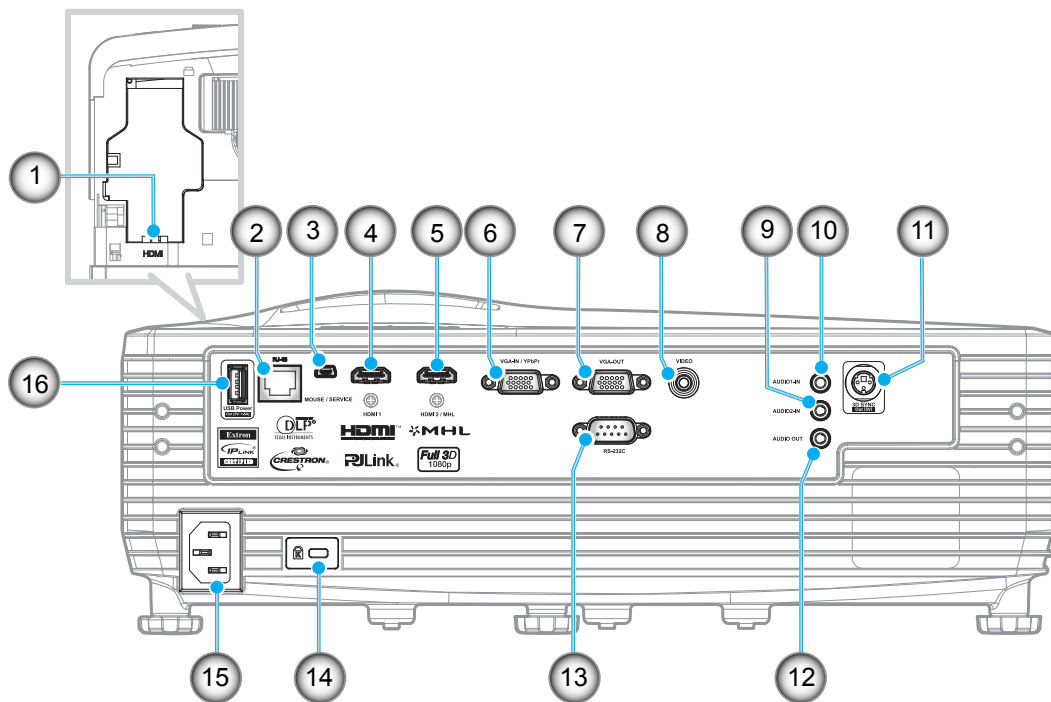

Note: Remote mouse requires special remote.

No	Item	No	Item
1.	HDMI3 / MHL connector	9.	Audio2-In connector
2.	RJ-45 connector	10.	Audio1-In connector
3.	MOUSE / SERVICE connector	11.	3D Sync out (5V) connector
4.	HDMI1 connector	12.	Audio-Out connector
5.	HDMI2 / MHL connector	13.	RS-232C connector
6.	VGA-In / YPbPr connector	14.	Kensington Lock
7.	VGA-Out connector	15.	Power socket
8.	Video connector	16.	USB Power Out (5V/1A) connector

INTRODUCTION

Connections (XGA)

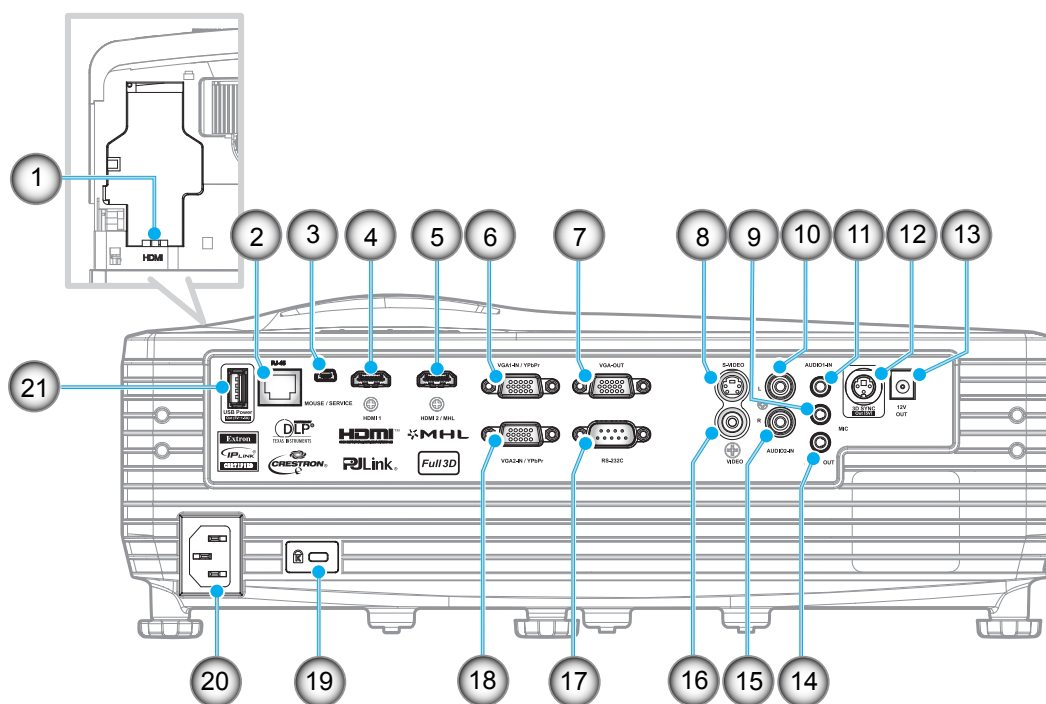

Note: Remote mouse requires special remote.

No	Item	No	Item
1.	HDMI3 / MHL connector	12.	3D Sync out (5V) connector
2.	RJ-45 connector	13.	12V Out connector
3.	MOUSE / SERVICE connector	14.	Audio-Out connector
4.	HDMI1 connector	15.	Audio2-In connector (right)
5.	HDMI2 / MHL connector	16.	Video connector
6.	VGA1-In / YPbPr connector	17.	RS-232C connector
7.	VGA-Out connector	18.	VGA2-In / YPbPr connector
8.	S-Video connector	19.	Kensington Lock
9.	MIC connector	20.	Power socket
10.	Audio2-In connector (left)	21.	USB Power Out (5V---1A) connector
11.	Audio1-In connector		

INTRODUCTION

Keypad

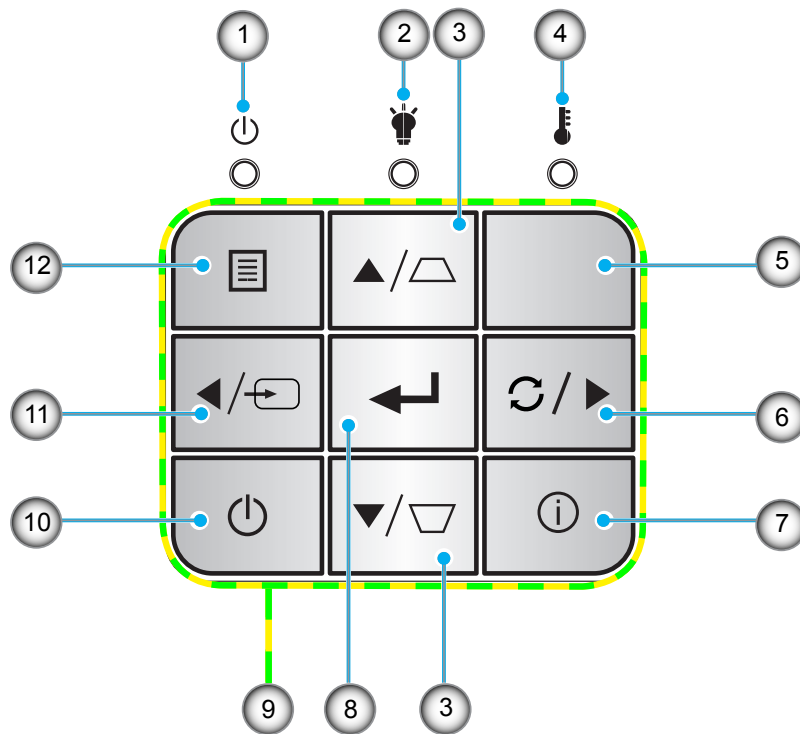

No	Item	No	Item
1.	On / Standby LED	7.	Information
2.	Lamp LED	8.	Enter
3.	Keystone Correction (vertical)	9.	Four Directional Select Keys (▲, ►, ▼, ◄)
4.	Temp LED	10.	Power
5.	IR Receiver	11.	Source
6.	Re-Sync	12.	Menu

INTRODUCTION

Remote Control

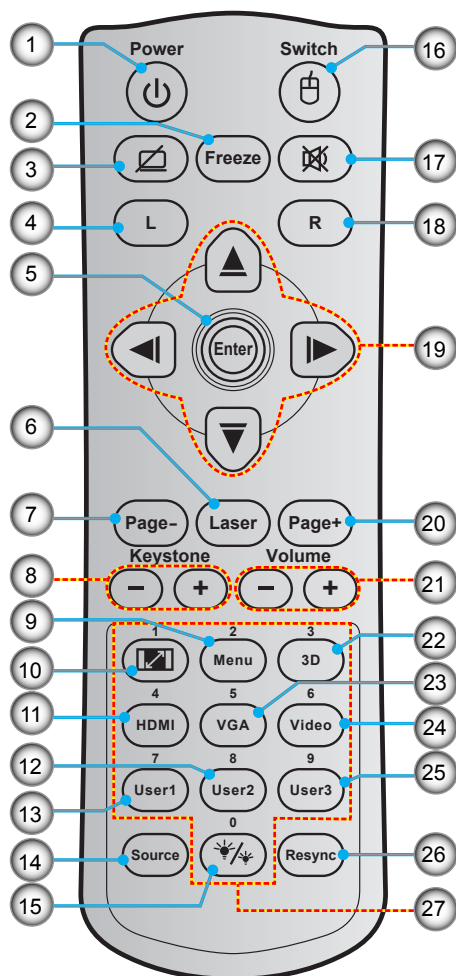

No	Item	No	Item
1.	Power On / Off	15.	Brightness Mode
2.	Freeze	16.	Mouse On / Off
3.	Display Blank / Audio Mute	17.	Mute
4.	Mouse Left Click	18.	Mouse Right Click
5.	Enter	19.	Four Directional Select Keys
6.	Laser	20.	Page +
7.	Page -	21.	Volume - / +
8.	Keystone	22.	3D Menu On / Off
9.	Menu	23.	VGA
10.	Aspect Ratio	24.	Video
11.	HDMI	25.	User 3
12.	User 2	26.	Resync
13.	User 1	27.	Numeric Keypad (0-9)
14.	Source		

Note: Some keys may have no function for models that do not support these features.

SETUP AND INSTALLATION

Installing the projector

Your projector is designed to be installed in one of four possible positions.

Your room layout or personal preference will dictate which installation location you select. Take into consideration the size and position of your screen, the location of a suitable power outlet, as well as the location and distance between the projector and the rest of your equipment.

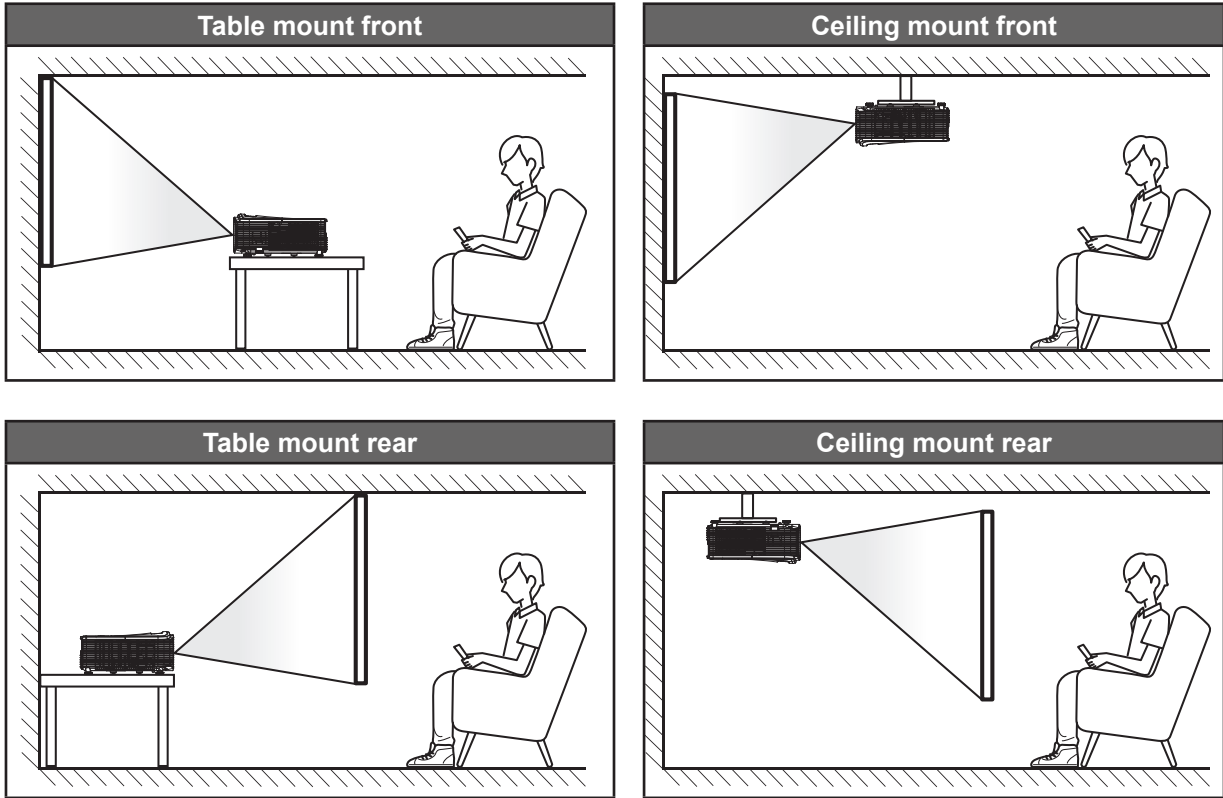

Projector should be placed flat on a surface and 90 degrees / perpendicular to the to the screen.

- How to determine projector location for a given screen size, please refer to the distance table on pages 69-72.
- How to determine screen size for a given distance, please refer to the distance table on pages 69-72.

Note: *The further away the projector is placed from the screen the projected image size increases and vertical offset also increases proportionally.*

Important!

Do not operate the projector in any orientation other than table top or ceiling mount. The projector should be horizontal and not tilted either forwards/backwards or left/right. Any other orientation will invalidate the warranty and may shorten the lifetime of the projector lamp or the projector itself. For none standard installation advise please contact Optoma.

SETUP AND INSTALLATION

Connecting sources to the projector (1080P / WXGA)

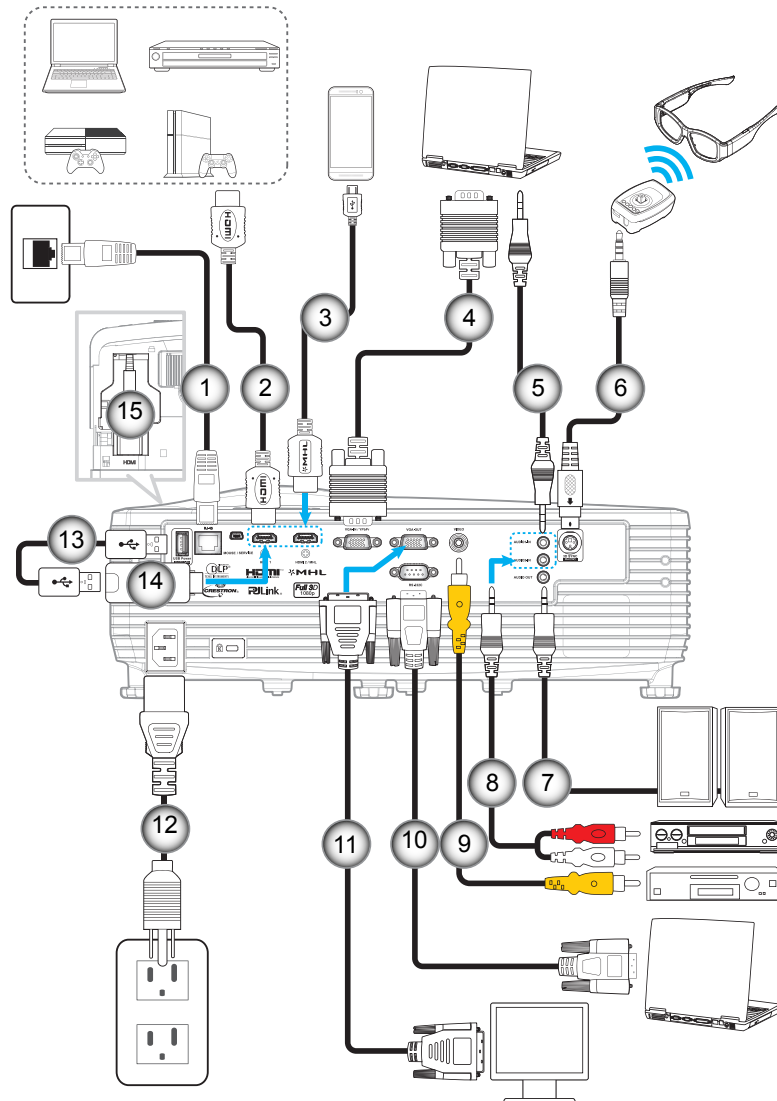

No	Item	No	Item
1.	RJ-45 cable	9.	Video cable
2.	HDMI cable	10.	RS-232C cable
3.	MHL cable	11.	VGA-Out cable
4.	VGA-In cable	12.	Power cord
5.	Audio-In cable	13.	USB Power Charger
6.	3D emitter cable	14.	USB dongle
7.	Audio Out cable	15.	HDMI Dongle
8.	Audio-In cable		

Note:

- The projector needs to be powered off prior performing the connection to the HDMI3 / MHL connector. If not powered off manually, the projector will automatically power off as soon as the top cover is opened.
- Due to size limit, we recommend using MHL powered HDMI dongles that are equal to or smaller than 85 x 31 x 15mm. For HDMI dongles that require USB power, please ensure they are smaller than 65 x 31 x 15mm.
- Alternatively, if your MHL powered dongle is larger than the dimensions suggested, use the extra HDMI port found on the back panel along with the USB port to power the dongle.

SETUP AND INSTALLATION

Connecting sources to the projector (XGA)

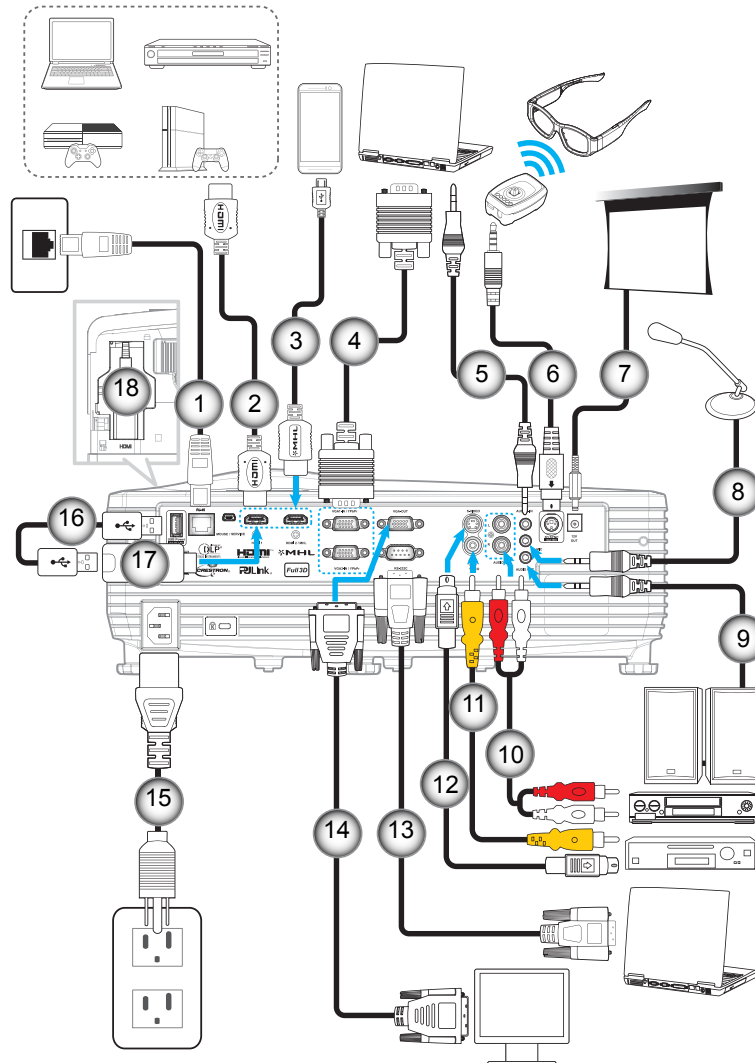

No	Item	No	Item
1.	RJ-45 cable	10.	Audio-In cable
2.	HDMI cable	11.	Video cable
3.	MHL cable	12.	S-Video cable
4.	VGA-In cable	13.	RS-232C cable
5.	Audio-In cable	14.	VGA-Out cable
6.	3D emitter cable	15.	Power cord
7.	12V DC Jack	16.	USB Power Charger
8.	Microphone cable	17.	USB dongle
9.	Audio Out cable	18.	HDMI dangle

Note:

- The projector needs to be powered off prior performing the connection to the HDMI3 / MHL connector. If not powered off manually, the projector will automatically power off as soon as the top cover is opened.
- Due to size limit, we recommend using MHL powered HDMI dongles that are equal to or smaller than 85 x 31 x 15mm. For HDMI dongles that require USB power, please ensure they are smaller than 65 x 31 x 15mm.
- Alternatively, if your MHL powered dongle is larger than the dimensions suggested, use the extra HDMI port found on the back panel along with the USB port to power the dongle.

SETUP AND INSTALLATION

Adjusting the projector image

Image height

The projector is equipped with elevator feet for adjusting the image height.

1. Locate the adjustable foot you wish to adjust on the underside of the projector.
2. Rotate the adjustable foot clockwise or counter-clockwise to raise or lower the projector.

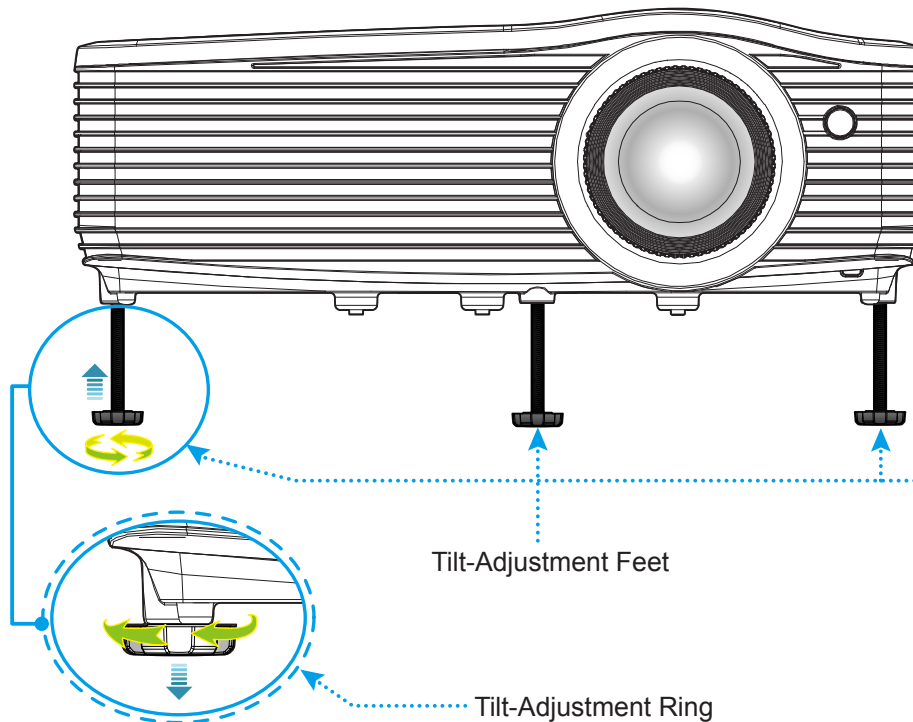

Zoom and focus

- To adjust the image size, turn the zoom lever clockwise or counter-clockwise to increase or decrease the projected image size.
- To adjust the focus, turn the focus ring clockwise or counter-clockwise until the image is sharp and legible.

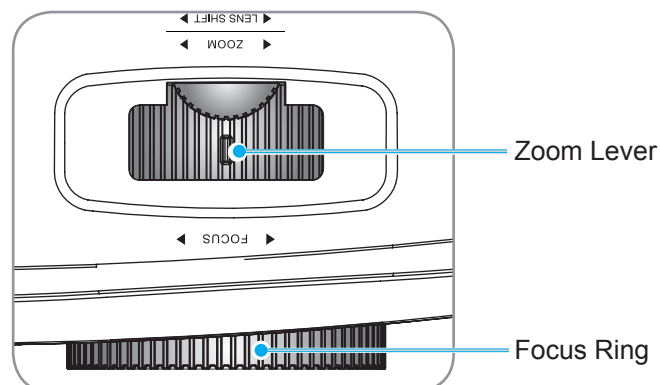

SETUP AND INSTALLATION

Remote setup

Installing / replacing the batteries

Two AAA size batteries are supplied for the remote control.

1. Remove the battery cover on the back of the remote control.
2. Insert AAA batteries into the battery compartment as illustrated.
3. Replace back cover on remote control.

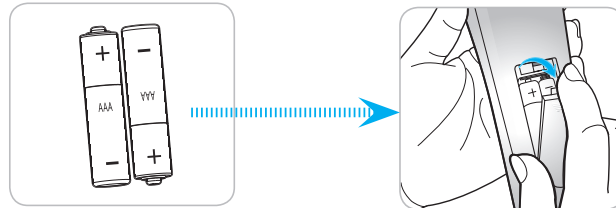

Note: Replace only with the same or equivalent type batteries.

CAUTION

Improper use of batteries can result in chemical leakage or explosion. Be sure to follow the instructions below.

- Do not mix batteries of different types. Different types of batteries have different characteristics.
- Do not mix old and new batteries. Mixing old and new batteries can shorten the life of new batteries or cause chemical leakage in old batteries.
- Remove batteries as soon as they are depleted. Chemicals that leak from batteries that come in contact with skin can cause a rash. If you find any chemical leakage, wipe thoroughly with a cloth.
- The batteries supplied with this product may have a shorter life expectancy due to storage conditions.
- If you will not be using the remote control for an extended period of time, remove the batteries.
- When you dispose of the batteries, you must obey the law in the relative area or country.

Effective range

Infra-Red (IR) remote control sensor is located on the rear side of the projector. Ensure to hold the remote control at an angle within 30 degrees perpendicular to the projector's IR remote control sensor to function correctly. The distance between the remote control and the sensor should not be longer than 8 meters (~ 26 feet).

- Make sure that there are no obstacles between the remote control and the IR sensor on the projector that might obstruct the infra-red beam.
- Make sure the IR transmitter of the remote control is not being shined by sunlight or fluorescent lamps directly.
- Please keep the remote controller away from fluorescent lamps for over 2m or the remote controller might become malfunction.
- If the remote control is too close to Inverter-Type fluorescent lamps, it might become ineffective from time to time.
- If the remote control and the projector are within a very short distance, the remote control might become ineffective.
- When you aim at the screen, the effective distance is less than 5m from the remote control to the screen and reflecting the IR beams back to the projector. However, the effective range might change according to screens.

SETUP AND INSTALLATION

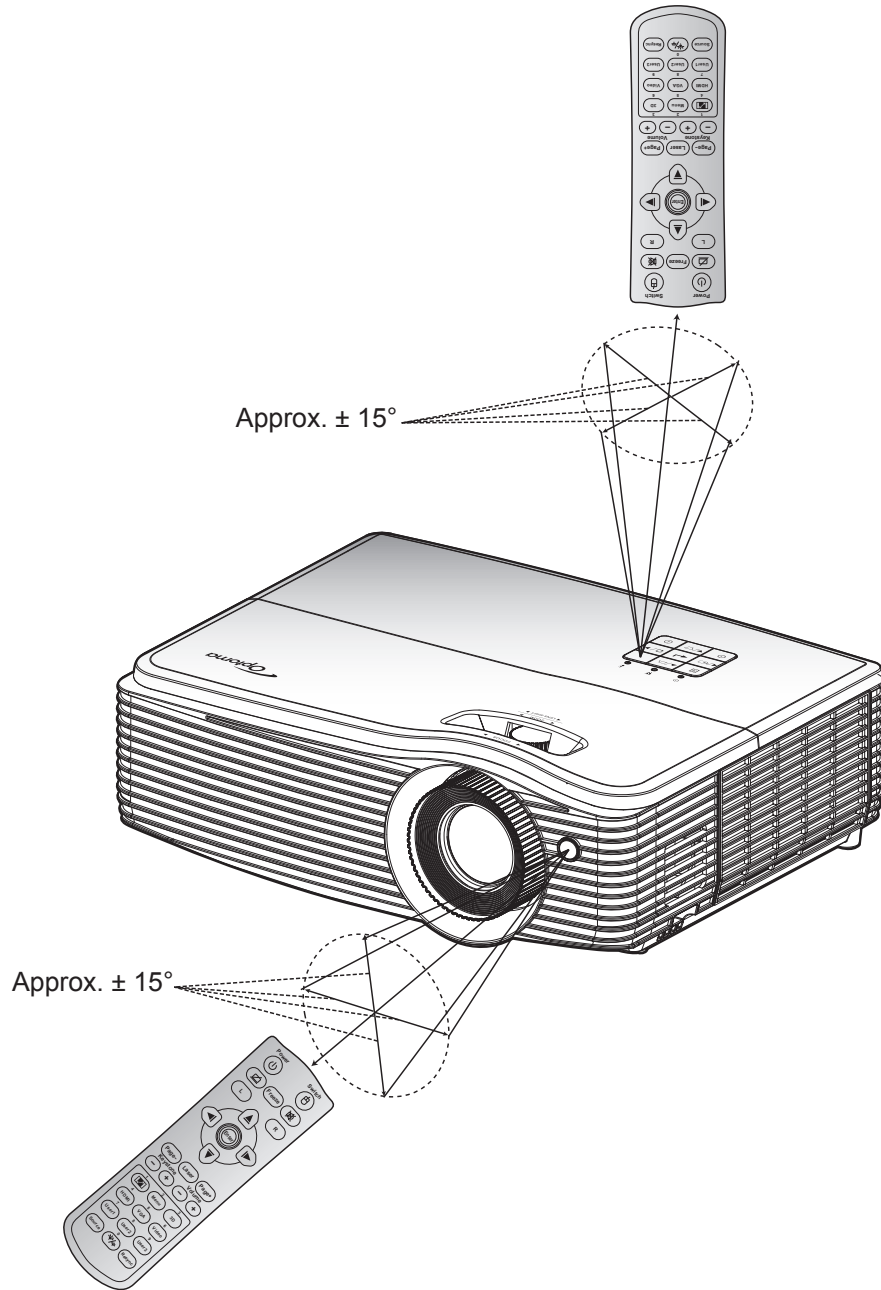

USING THE PROJECTOR

Powering on / off the projector

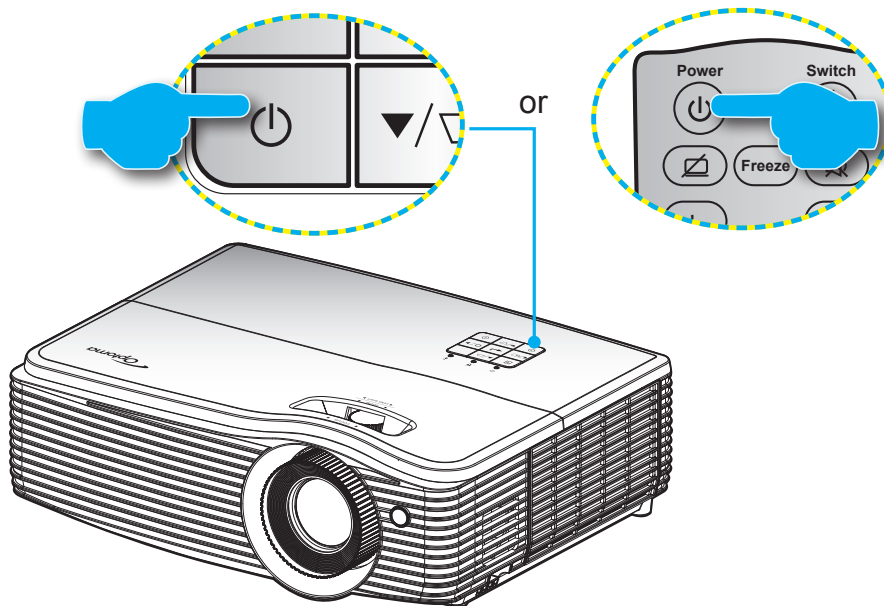

Powering on

1. Securely connect the power cord and signal / source cable. When connected, the On / Standby LED will turn red.
2. Turn on the projector by pressing the "⏻" either on the projector keypad or the remote control.
3. A start up screen will display in approximately 10 seconds and the On / Standby LED will be solid blue.

Note: The first time the projector is turned on, you will be prompted to select the preferred language, and other settings.

Powering off

1. Turn off the projector by pressing the "⏻" either on the projector keypad or the remote control.
2. The following message will be displayed:

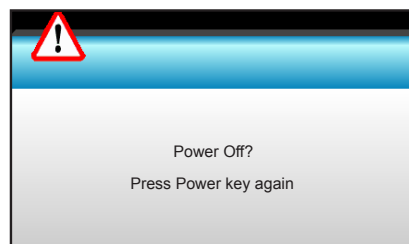

3. Press the "⏻" again to confirm, otherwise the message will disappear after 15 seconds. When you press the "⏻" button for the second time, the projector will shut down.
4. The cooling fans will continue to operate for about 10 seconds for the cooling cycle and the On/ Standby LED will flash blue. When the On / Standby LED turns solid red, this indicates the projector has entered standby mode. If you wish to turn the projector back on, you must wait until the cooling cycle has finished and the projector has entered standby mode. When the projector is in standby mode, simply press the "⏻" button again to turn on the projector.
5. Disconnect the power cord from the electrical outlet and the projector.

Note: It is not recommended that the projector is turned on immediately right after a power off procedure.

USING THE PROJECTOR

Selecting an input source

Turn on the connected source that you want to display on the screen such as computer, notebook, video player, etc. The projector will automatically detect the source. If multiple sources are connected, push the source button on the projector keypad or the remote control to select the desired input.

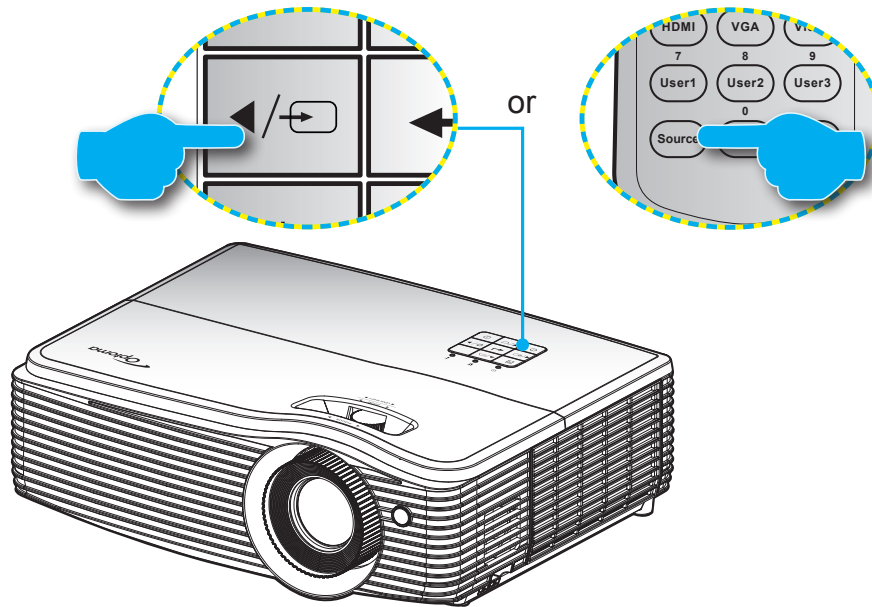

USING THE PROJECTOR

Menu navigation and features

The projector has multilingual on-screen display menus that allow you to make image adjustments and change a variety of settings. The projector will automatically detect the source.

1. To open the OSD menu, press "Menu" on the projector keypad or the remote control.
2. When OSD is displayed, use ◀▶ keys to select any item in the main menu. While making a selection on a particular page, press ▼ or "Enter" key to enter sub menu.
3. Use ▲▼ keys to select the desired item in the sub menu and then press ▶ or "Enter" key to view further settings. Adjust the settings by using ◀▶ keys.
4. Select the next item to be adjusted in the sub menu and adjust as described above.
5. Press "Enter" or "Menu" to confirm, and the screen will return to the main menu.
6. To exit, press "Menu" again. The OSD menu will close and the projector will automatically save the new settings.

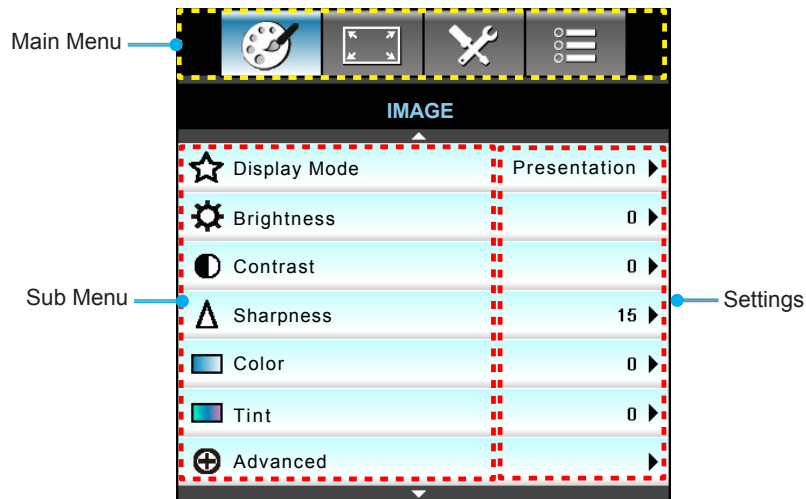







USING THE PROJECTOR

OSD Menu tree

Main menu	Sub menu	Advanced menu	Single-item menu	Value		
Image	Display Mode		Presentation	[Default: Presentation] PS. Each mode can adjust and save in each mode		
			Bright			
			Movie			
			sRGB			
			Blackboard			
			DICOM SIM.			
			User			
			3D			
		Brightness			-50~50	
		Contrast			-50~50	
		Sharpness			1 ~15	
		Color			-50~50	
		Tint			-50~50	
		Advanced	Noise Reduction		0~10	
			BrilliantColor™		1~10	
			Dynamic Black	On	Note: End-user can choose lamp mode between Bright and Eco while DynamicBlack is Off; between Dynamic and Eco+ while DynamicBlack is On.	
				Off		
			Gamma		Film	
					Graphics	
					1.8	
					2.0	
					2.2	
					2.6	
					Blackboard	
				DICOM		
			Color Temp.		Warm	
					Standard	
					Cool	
					Cold	
			Color Space		Not HDMI Input: Auto / RGB / YUV	
				HDMI Input: Auto/ RGB(0~255) / RGB(16~235) / YUV		
	RGB Gain / Bias		Red Gain	-50~50		
			Green Gain	-50~50		
			Blue Gain	-50~50		
			Red Bias	-50~50		
			Green Bias	-50~50		
			Blue Bias	-50~50		
			Reset	Yes		
				No		
		Exit				









USING THE PROJECTOR

Main menu	Sub menu	Advanced menu	Single-item menu	Value
Image	Advanced	Color Matching	Red	Hue / Saturation / Gain [-50~50]
			Green	Hue / Saturation / Gain [-50~50]
			Blue	Hue / Saturation / Gain [-50~50]
			Cyan	Hue / Saturation / Gain [-50~50]
			Magenta	Hue / Saturation / Gain [-50~50]
			Yellow	Hue / Saturation / Gain [-50~50]
			White	Red/Green/Blue [-50~50]
			Reset	Yes
		No		
		Exit		
		Signal (RGB)	Automatic	On Off
			Phase	0~31
			Frequency	-5~5
	H. Position		-5~5 Note: Depends on input signal.	
	V. Position		-5~5 Note: Depends on input signal.	
	Exit			
	Signal (Video)	White Level	0~31	
		Black Level	-5~5	
		IRE	0 / 7.5	
		Exit		
Exit				
Reset		Yes		
		No		
Display	Format		WXGA: 4:3, 16:9 or 16:10, LBX , Native, Auto	
			XGA: 4:3, 16:9, Native, Auto	
			1080p: 4:3, 16:9, LBX, Native, Auto	
	Zoom			-5~25
	Edge Mask			0~10
	Image Shift	H: 0; V: -100		-100~+100 Note: Depends on input signal.
		H: -100; V: 0		
		H: 0; V: 100		
		H: 0; V: 100		
		H: -100; V: 0		
		H: 0; V: -100		
H: 100; V: 0				
Geometric Correction	H. Keystone		-30 ~ +30	
	V. Keystone		-30 ~ +30	

USING THE PROJECTOR

Main menu	Sub menu	Advanced menu	Single-item menu	Value		
Display	Geometric Correction	Auto V. Keystone	On	Default [Off]		
			Off			
		Four Corner	Top-Left 			
			Top-Right 			
			Bottom-Left 			
			Bottom-Right 			
		Reset	Yes			
			No			
		Setup	3D	3D Mode	DLP-Link	
					VESA 3D	
Off						
3D->2D	3D					
	L					
	R					
3D Format	Auto					
	SBS					
	Top and Bottom					
	Frame Sequential					
3D Sync Invert	On					
	Off					
Exit						
Language			English			
			Deutsch			
			Français			
			Italiano			
			Español			
			Português			
			Svenska			
		Nederlands				
		Norsk				
		Dansk				
		Polski				
		Русский				
		Suomi				
		ελληνικά				
		Magyar				
		Čeština				
		العبرية				
		繁體中文				
	簡體中文					
	日本語					
	한국어					
	ไทย					
	Türkçe					
	یسرائیلی					

USING THE PROJECTOR

Main menu	Sub menu	Advanced menu	Single-item menu	Value	
Setup	Language		Vietnamese		
			Romanian		
			Indonesian		
	Projection			Front 	
				Rear 	
				Front-Ceiling 	
				Rear-Ceiling 	
	Screen Type			16:10 (WXGA)	
				16:9 (WXGA)	
	Menu Location			Top-Left 	
				Top-Right 	
				Center 	
				Bottom-Left 	
				Bottom-Right 	
	Security	Security		On	
				Off	
		Security Timer		Month	
				Day	
				Hour	
		Change Password			
		Exit			
	Projector ID				00~99
	Audio Settings	Internal Speaker		On	
				Off	
		Mute		On	
				Off	
		Volume		Audio	0-10
				Mic (XGA only)	0-10
		Audio Input		Default	For WXGA and 1080p:
				Audio1	VGA->Audio1
			Audio2	Video->Audio2 For XGA: VGA1 / VGA2 -> Audio1 Video / S-Video -> Audio2	

USING THE PROJECTOR

Main menu	Sub menu	Advanced menu	Single-item menu	Value		
Setup	Audio Settings	Audio Out(Standby)	On	Default[Off]		
			Off	<p>Note:</p> <ul style="list-style-type: none"> - Considering power consumption in active mode, AudioOut(Standby) supports only analog audio input (HDMI audio is out from AudioInput1). - End-user can enable / disable AudioOut(Standby) while PowerMode(Standby) is Active, not operate this function while PowerMode(Standby) is Eco. 		
		Exit				
	Advanced	Logo		Default		
				Neutral		
				User		
		Logo Capture		<p>Note:</p> <ul style="list-style-type: none"> - Because of flash size limitation, logo captured by end-user must be smaller than 2MB. - Logo Capture function is invalid while 3D is On. 3D image consists of two frame images, it may cause logo capture to fail. - Logo Capture feature should be used solely for capturing logos, not complicated pictures. 		
		Closed Captioning		Off		
				CC1		
				CC2		
	Exit					
	Network	LAN Settings	Network Status	Connect (Read-Only)		
				Disconnect (Read-Only)		
			DHCP	On		
				Off [Default]		
			IP Address	Default [192.168.0.100]		
			Subnet Mask	Default [255.255.255.0]		
			Gateway	Default [192.168.0.254]		
			DNS	Default [192.168.0.1]		
		MAC Address	Read-Only			
		Exit				
		Control Settings		Crestron	On / Off (port:41794)	
				Extron	On / Off (port: 2023)	
PJLink				On / Off (port: 4352)		
AMX Device Discovery				On / Off (port: 9131)		
Telnet	On / Off (port: 23)					
HTTP	On / Off (port: 80)					
Exit						

USING THE PROJECTOR

Main menu	Sub menu	Advanced menu	Single-item menu	Value	
Options	Input Source		VGA1		
			VGA2 (XGA only)		
			Video		
			S-Video (XGA only)		
			HDMI1		
			HDMI2		
			HDMI3		
			Exit		
	Source Lock		On	[Default On]	
			Off		
	High Altitude		On	[Default Off]	
			Off		
	Information Hide		On	[Default Off]	
			Off	PS. Warning message & Power off not hide	
	Keypad Lock		On	[Default Off]	
			Off		
	Display Mode Lock		On		
			Off		
	Test Pattern			None	
				Grid	
				White Pattern	
	Background Color			Black	[Default Blue]
				Red	
				Blue	
				Green	
				White	
	Wall Color			Off	[Default Off]
				Light Yellow	
				Light Green	
				Light Blue	
				Pink	
				Gray	
Remote Settings	User1		HDMI2	[Default "Test Pattern"]	
			VGA2 (XGA only)		
			S-Video (XGA only)		
			Test Pattern		
			Zoom		
		Info.			
	User2		HDMI2	[Default "Zoom"]	
			VGA2 (XGA only)		
			S-Video (XGA only)		
			Test Pattern		
		Zoom			
	Info.				

USING THE PROJECTOR

Main menu	Sub menu	Advanced menu	Single-item menu	Value
Options	Remote Settings	User3	HDMI2	[Default "Info"]
			VGA2 (XGA only)	
			S-Video (XGA only)	
			Test Pattern	
			Zoom	
			Info.	
		IR Function	On	
			Front	
			Top	
			Off	
	Exit			
	12V Trigger (XGA only)		On	[Default On]
			Off	
	Beep		On	[Default On]
			Off	
	Advanced	Direct Power On	On	[Default Off]
			Off	
		Signal Power On	On	[Default Off] Note: - End-user can enable / disable SignalPowerOn while PowerMode(Standby) is Active. - SignalPowerOn can support all sources (VGA / Video / S-Video (for XGA) / HDMI).
			Off	
		Auto Power Off (min.)		[Default: 20 mins] 0-180 (one step: 5 mins)
		Sleep Timer (min.)		0-990 (one step: 10 mins) Note: Always On [check box style, default is unchecked.]
		Quick Resume	On	[Default Off]
			Off	
		Power Mode (Standby)	Active	[Default Eco.]
			Eco.	
		Exit		
		Lamp Settings	Lamp Hour	
	Lamp Reminder		On	[Default Off]
			Off	
	Lamp Mode		Bright	Note: End-user can choose lamp mode between Bright and Eco while DynamicBlack is Off; between Dyanmic and Eco+ while DynamicBlack is On.
			Eco	
			Dynamic	
			Eco+	
Lamp Reset	Yes			
	No			
Exit				

USING THE PROJECTOR

Main menu	Sub menu	Advanced menu	Single-item menu	Value	
Options	Optional Filter Settings	Optional Filter Installed		Yes	
				No [Default]	
		Filter Usage Hours		Read-Only [Range 0~ 9999]	
		Filter Reminder	Off		
			300 hr		
			500 hr [Default]		
			800 hr		
			1000 hr		
		Filter Reset			Yes
					No
	Exit				
	Information			Please see page 58.	
	Reset		Yes		
		No			

Note:

- *If the Signal setting is set to Automatic, the Phase, frequency items are grayed out. If the “Signal” setting is set to a specific input source, the phase, frequency items will appear for user to manually tune and saved in settings.*
- *The “LAMP RESET” in OSD will only reset both Lamp Hours in OSD and Lamp Hours in service mode. The Projection Hours in service mode will not be reset.*
- *If the end-user changes the Audio setting from “Default” to “Audio in 1” then all sources, including HDMI should follow this setting.*
- *If you made modifications to the “IR Function”, “Projection”, or “Keypad Lock” function, a confirmation message will appear on the screen. Select “Yes” to save the settings.*
- *Eco+ mode is using Philips (Dynamic Eco) technology, lamp power can be dynamically adjusted from 100% to 70%.*
- *The projector supports Quick Resume function which means that within a 100-second time period the projector can be switched on immediately in the situation when the projector was switched off unintentionally.*
If the Quick Resume function is off then 10-seconds after switching off the projector the cooling fans will start to cool down the projector and switching on the system immediately is strongly not recommended.
- *Each display mode can be adjusted and saved the value.*

USING THE PROJECTOR

Image menu

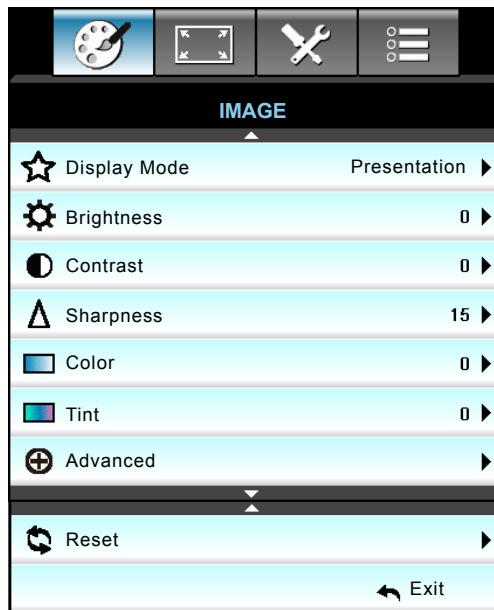

Display Mode

There are many factory presets optimized for various types of images.

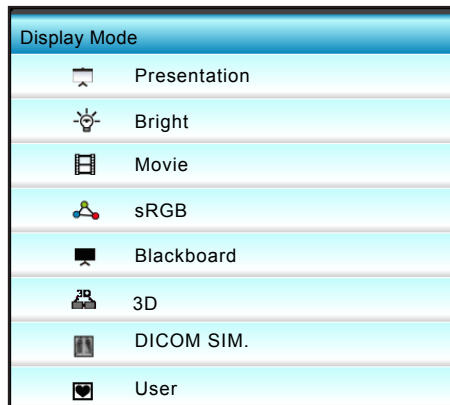

- **Presentation:** This mode is suitable for showing PowerPoint presentations when the project is connected to the PC.
- **Bright:** Maximum brightness from PC input.
- **Movie:** This mode is suitable for watching video.
- **sRGB:** Standardized accurate color.
- **Blackboard:** This mode should be selected to achieve optimum color settings when projecting onto a blackboard (green).
- **3D:** To experience the 3D effect, you need to have 3D glasses. Make sure your PC / portable device has a 120 Hz signal output quad buffered graphics card and a 3D Player installed.
- **DICOM SIM.:** This mode can project a monochrome medical image such as an X ray radiography, MRI, etc.
- **User:** Memorize user's settings.

USING THE PROJECTOR

Brightness

Adjust the brightness of the image.

- Press the ◀ to darken image.
- Press the ▶ to lighten the image.

Contrast

The contrast controls the degree of difference between the lightest and darkest parts of the picture.

- Press the ◀ to decrease the contrast.
- Press the ▶ to increase the contrast.

Sharpness

Adjust the sharpness of the image.

- Press the ◀ to decrease the sharpness.
- Press the ▶ to increase the sharpness.

Color

Adjust a video image from black and white to fully saturated color.

- Press the ◀ to decrease the amount of saturation in the image.
- Press the ▶ to increase the amount of saturation in the image.

Tint

Adjust the color balance of red and green.

- Press the ◀ to increase the amount of green in the image.
- Press the ▶ to increase the amount of red in the image.

Reset

Choose "Yes" to return the factory default settings for "IMAGE".

Exit

Choose "Exit" to exit the menu.

USING THE PROJECTOR

Image Advanced menu

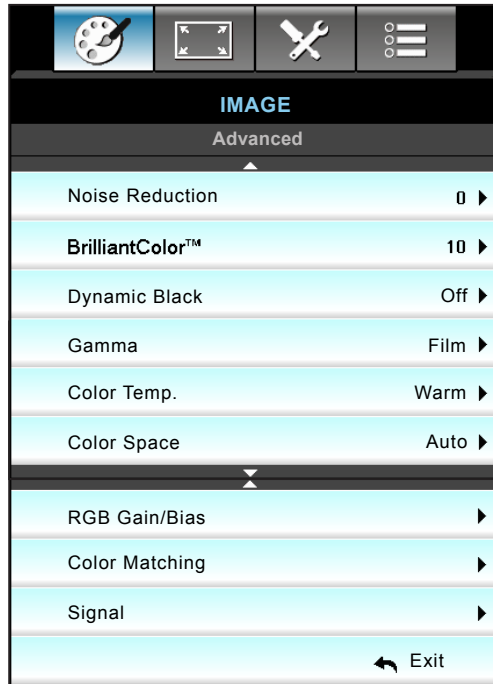

Noise Reduction

Select a filter sensitivity to be applied on noise. A higher value may improve noisy sources, but it will soften the image.

- Press the ► to decrease the noise in the image.
- Press the ◀ to increase the noise in the image.

BrilliantColor™

This adjustable item utilizes a new color-processing algorithm and enhancements to enable higher brightness while providing true, more vibrant colors in picture.

- Press the ► to stronger enhance the image.
- Press the ◀ to less enhance the image.

Dynamic Black

Dynamic Black enables the projector to automatically optimize the brightness of the display during dark / light movie scenes to be shown in incredible detail.

Gamma

This allows you to set up gamma curve type. After the initial setup and fine tuning is completed, utilize the Gamma Adjustment steps to optimize your image output. Press the ◀ or ► to select the mode.

- Film: for home theater.
- Graphics: for PC / Photo source.
- 1.8 / 2.0 / 2.2 / 2.6: for specific PC / Photo source.
- Blackboard: This mode should be selected to achieve optimum color settings when projecting onto a blackboard (green).
- DICOM: This mode can project a monochrome medical image such as an X ray radiography, MRI, etc.

Color Temp.

Press the ◀ or ► to select a color temperature from Warm, Standard, Cool, or Cold.

USING THE PROJECTOR

Color Space

Press the ◀ or ▶ to select an appropriate color matrix type from the following:

- Not-HDMI Input: Auto, RGB or YUV
- HDMI Input: Auto, RGB(0~255), RGB(16~235) or YUV.

RGB Gain / Bias

This settings allows to configure the brightness (gain) and contrast (bias) of an image.

- Press the ◀ to decrease a chosen color gain and bias.
- Press the ▶ to increase a chosen color gain and bias.

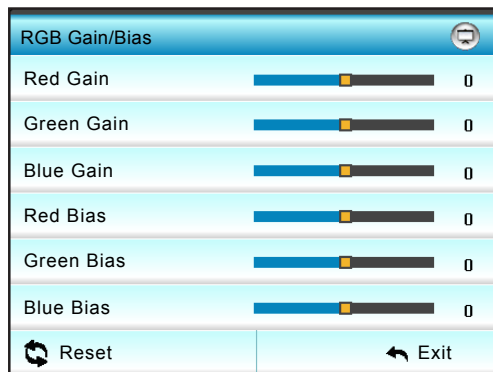

Color Matching

Press the ▶ into the next menu and then use ▲, ▼, ◀, or ▶ to select the item.



- Red / Green / Blue / Cyan / Magenta / Yellow: Use ◀ or ▶ to adjust Hue, Saturation and Gain Colors.

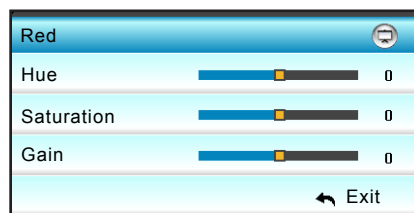

- White: Use ◀ or ▶ to adjust Red, Green, and Blue Colors.

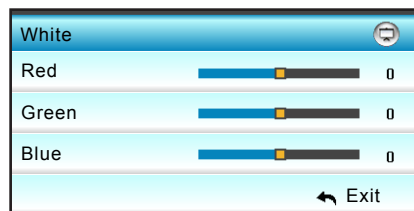

- Reset: Choose "↻ Reset" to return the factory default settings for color adjustments.

Exit

Choose "Exit" to exit the menu.

USING THE PROJECTOR

Image advanced signal (RGB) menu

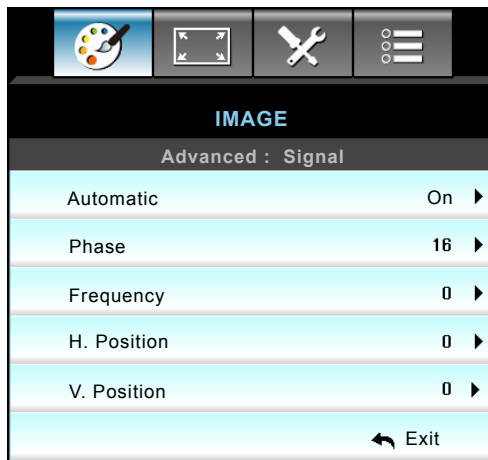

Note:

- "Signal" is only supported in Analog VGA (RGB) signal.
- If the "Signal" setting is set to automatic, the phase, frequency items are grayed out. If the "Signal" setting is set to a specific input source, the phase, frequency items will appear for the user to manually tune and are saved in the settings after the next time projector is turned off and on again.

Automatic

Automatically selects the signal. If this function is enabled, the Phase, frequency items are grayed out. If this function is disabled, the phase, frequency items will appear for user to manually tune and saved in settings after the next time projector turns off and on again.

Phase

Synchronize the signal timing of the display with the graphic card. If the image appears to be unstable or flickers, use this function to correct it.

Frequency

Change the display data frequency to match the frequency of your computer's graphic card. Use this function only if the image appears flickering vertical lines.

H. Position

- Press the ◀ to move the image left.
- Press the ▶ to move the image right.

V. Position

- Press the ◀ to move the image down.
- Press the ▶ to move the image up.

Exit

Choose "Exit" to exit the menu.

USING THE PROJECTOR

Image advanced signal (video) menu

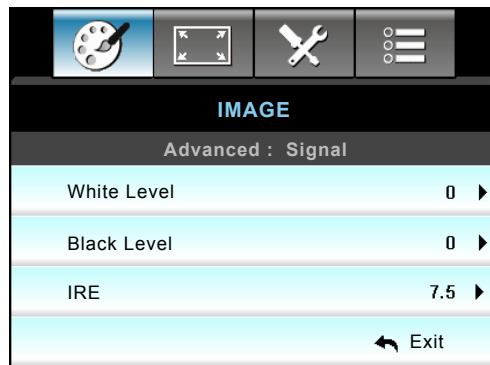

White Level

Allow user to adjust White Level when inputting Video signals.

Black Level

Allow user to adjust Black Level when inputting Video signals.

IRE

Allow user to adjust IRE value when inputting Video signals.

Note: IRE is only available with NTSC video format.

- Press the ◀ to decrease the amount of color in the image.
- Press the ▶ to increase the amount of color in the image.

Exit

Choose "Exit" to exit the menu.

USING THE PROJECTOR

Display menu

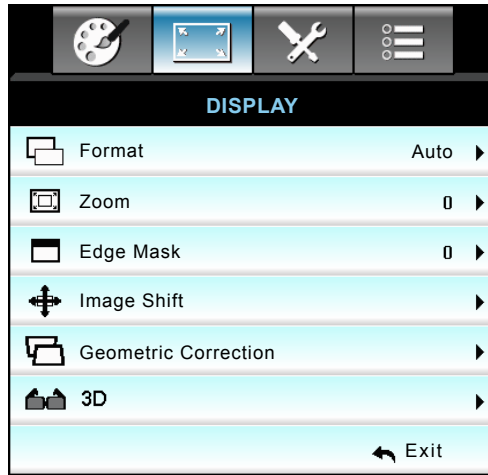

Format

Press the ◀ or ▶ to choose your desired aspect ratio between 4:3, 16:9 / 16:10, LBX, Native, Auto (WXGA), 4:3, 16:9, Native, Auto (XGA), or 4:3, 16:9, LBX, Native, Auto (1080p).

1080P:

- 4:3: This format is for 4:3 input sources.
- 16:9: This format is for 16:9 input sources, like widescreen laptops.
- LBX: This format is for non-16 x 9, letterbox source and for users who use external 16 x 9 lens to display 2.35:1 aspect ratio using full resolution.
- Native: This format displays the original image without any scaling.
- AUTO: Automatically selects the appropriate display format.

1080P scaling table:

16 : 9 screen	480i/p	576i/p	1080i/p	720p	PC
4x3	Scale to 1440 x 1080.				
16x9	Scale to 1920 x 1080.				
LBX	Scale to 1920 x 1440, then get the central 1920 x 1080 image to display.				
Native mode	1:1 mapping centered. No scaling will be made; the resolution is dependent on which input source and is then displayed.				
Auto	If this format is selected, the screen type will automatically become 16:9 (1920 x 1080). -If source is 4:3, the screen type will automatically resize to 1440 x 1080. -If source is 16:9, the screen type will automatically resize to 1920 x 1080. -If source is 16:10, the screen type will automatically resize to 1920 x 1200 and cut 1920 x 1080 area to display.				

USING THE PROJECTOR

WXGA:

- 4:3: This format is for 4:3 input sources.
- 16:9: This format is for 16:9 input sources, like HDTV and DVD enhanced for Wide screen TV.
- 16:10: This format is for 16:10 input sources, like widescreen laptops.
- LBX: This format is for non-16x9, letterbox source and for users who use external 16x9 lens to display 2.35:1 aspect ratio using full resolution.
- Native: This format displays the original image without any scaling.
- AUTO: Automatically selects the appropriate display format.

Note: Detailed informations about LBX mode:

- Some Letter-Box Format DVDs are not enhanced for 16x9 TVs. In this situation, the image will not look right when displaying image in 16:9 mode. In this situation, please try to use the 4:3 mode to view the DVD. If the content is not 4:3, there will be black bars around the image in 16:9 display. For this type of content, you can use LBX mode to fill the image on the 16:9 display.
- If you use an external anamorphic lens, this LBX mode also allows you to watch a 2.35:1 content (include Anamorphic DVD and HDTV film source) that supports anamorphic wide is enhanced for 16x9 Display in a wide 2.35:1 image. In this case, there are no black bars. Lamp power and vertical resolution are fully utilized.

WXGA scaling table (screen type 16x10):

16 : 10 screen	480i/p	576i/p	1080i/p	720p	PC
4x3	Scale to 1066 x 800.				
16x10	Scale to 1280 x 800.				
LBX	Scale to 1280 x 960, then get the central 1280 x 800 image to display.				
Native mode	1:1 mapping centered.	1:1 mapping display 1280 x 800.		1280 x 720 centered.	1:1 mapping centered.
Auto	Input source will be fit into 1280 x 800 display area and be kept its original aspect ratio. - If source is 4:3, the screen type will automatically resize to 1066 x 800. - If source is 16:9, the screen type will automatically resize to 1280 x 720. - If source is 15:9, the screen type will automatically resize to 1280 x 768. - If source is 16:10, the screen type will automatically resize to 1280 x 800.				

WXGA scaling table (screen type 16x9):

16 : 9 screen	480i/p	576i/p	1080i/p	720p	PC
4x3	Scale to 960 x 720.				
16x9	Scale to 1280 x 720.				
LBX	Scale to 1280 x 960, then get the central 1280 x 720 image to display.				
Native mode	1:1 mapping centered.	1:1 mapping display 1280 x 720.		1280x720 centered.	1:1 mapping centered.
Auto	If this format is selected, the screen type will automatically become 16:9 (1280 x 720). -If source is 4:3, the screen type will automatically resize to 960 x 720. -If source is 16:9, the screen type will automatically resize to 1280 x 720. -If source is 15:9, the screen type will automatically resize to 1200 x 720. -If source is 16:10, the screen type will automatically resize to 1152 x 720.				

USING THE PROJECTOR

XGA:

- 4:3: This format is for 4:3 input sources.
- 16:9: This format is for 16:9 input sources, like widescreen laptops.
- Native: This format displays the original image without any scaling.
- AUTO: Automatically selects the appropriate display format.

XGA scaling table:

Source	480i/p	576i/p	1080i/p	720p
4x3	Scale to 1024 x 768.			
16x9	Scale to 1024 x 576.			
Native mode	No scaling will be made; the resolution is dependent on which input source and is then displayed.			
Auto	-If source is 4:3, the screen type will automatically resize to 1024 x 768. -If source is 16:9, the screen type will automatically resize to 1024 x 576. -If source is 16:9, the screen type will automatically resize to 1024 x 576. -If source is 16:10, the screen type will automatically resize to 1024 x 576			

Zoom

- Press the ◀ to reduce the size of an image.
- Press the ▶ to magnify an image on the projection screen.

Edge Mask

Use this function to remove video the encoding noise on the edge of video source.

Note:

- Each I / O has different setting of "Edge Mask".
- "Edge Mask" and "Zoom" cannot work at the same time.

Image Shift

Press ▶ into the next menu as below and then use ▲, ▼, ◀, ▶ to select item.

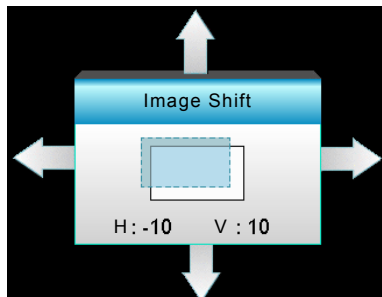

- H: Press the ◀▶ to shift the projected image position horizontally.
- V: Press the ▲▼ to shift the projected image position vertically.

USING THE PROJECTOR

Display geometric correction menu

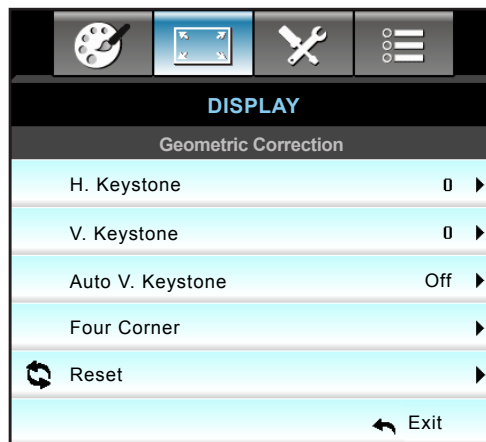

Geometric correction

- H. Keystone (Horizontal Keystone): Press the ◀▶ to correct horizontal keystone distortion.
- V. Keystone (Vertical Keystone): Press the ▲▼ to correct vertical keystone distortion.
- Auto V. Keystone: Automatically corrects vertical keystone error.
- Four Corner: Compensate for image distortion by adjusting one corner at a time.
- Reset: Choose "Yes" to return the factory default settings for "Geometric correction".

The sequence of screenshots shows the "Four Corner" menu in action:

1. Use "Menu" to start.
2. Use "Four Corner" menu to choose one corner and press "Enter" to confirm.
3. Use the ▲, ▼, ◀, or ▶ to move the angle and press "Enter" to confirm.

The screenshots show a cyan trapezoidal shape being adjusted at its corners. A green square highlights the bottom-right corner in the first screenshot, and a green crosshair with a blue circle in the center is used to move that corner in the subsequent four screenshots.

USING THE PROJECTOR

Display 3D menu

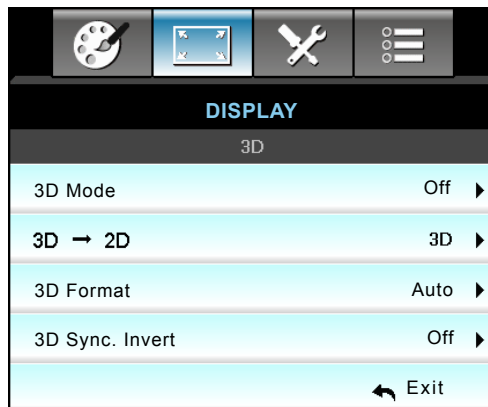

3D Mode

Use this function to disable the 3D function or select the appropriate the 3D function.

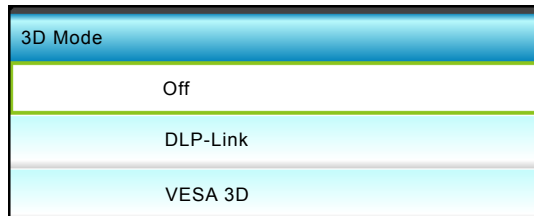

- Off: Select "Off" to turn off 3D mode.
- DLP-Link: Select "DLP-Link" to use optimized settings for DLP Link 3D Glasses.
- VESA 3D: Select "VESA 3D" to use optimized setting for VESA 3D Glasses.

3D -> 2D

Use this option to specify how the 3D content should appear on the screen.

- 3D: Display 3D signal.
- L (Left): Display the left frame of 3D content.
- R (Right): Display the right frame of 3D content.

3D Format

Use this option to select the appropriate 3D format content.

- Auto: When a 3D identification signal is detected, the 3D format is selected automatically.
- SBS: Display 3D signal in "Side-by-Side" format.
- Top and Bottom: Display 3D signal in "Top and Bottom" format.
- Frame Sequential: Display 3D signal in "Frame Sequential" format.

Note:

- "3D Format" is only supported on 3D Timing on page 69.
- "3D Format" is only supported on non-HDMI 1.4a 3D timing.

3D Sync. Invert

Use this option to enable / disable the 3D sync invert function.

- Press the "On" to invert left and right frame contents.
- Press the "Off" for default frame contents.

Exit

Choose "Exit" to exit the menu.

USING THE PROJECTOR

Setup menu

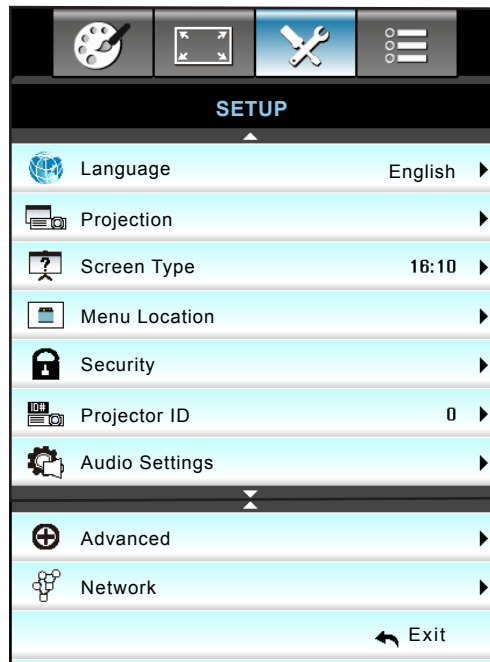





Language

Choose the multilingual OSD menu. Press ► into the sub menu and then use the ▲, ▼, ◀ or ▶ key to select your preferred language. Press "Enter" to finalize the selection.

Language			
English	Nederlands	Čeština	Türkçe
Deutsch	Norsk/Dansk	عربي	فارسی
Français	Polski	繁體中文	Vietnamese
Italiano	Русский	简体中文	Romanian
Español	Suomi	日本語	Indonesian
Português	ελληνικά	한국어	
Svenska	Magyar	ไทย	◀ Exit

Projection

-  Front
This is the default selection. The image is projected straight on the screen.
-  Rear
When selected, the image will appear reversed.
-  Front-Ceiling
When selected, the image will turn upside down.
-  Rear-Ceiling
When selected, the image will appear reversed in upside down position.

Note: Rear-Desktop and Rear-Ceiling are to be used with a translucent screen.

USING THE PROJECTOR

Screen Type

Choose the screen type from 16:10 or 16:9 (WXGA).

Note: "Screen Type" is for WXGA only.

Menu Location

Choose the menu location on the display screen.

Projector ID

ID definition can be set up by menu (range 0-99), and allow user control an individual projector by RS232.

Exit

Choose "Exit" to exit the menu.

USING THE PROJECTOR

Setup audio settings menu

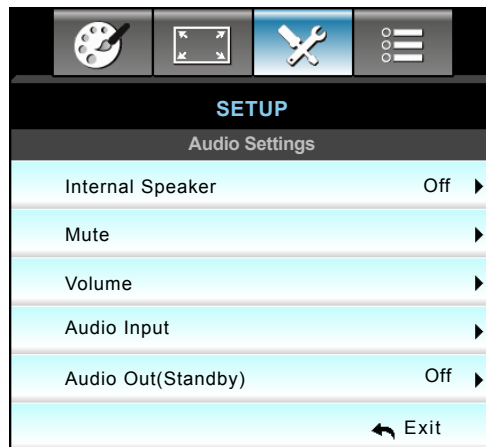

Internal Speaker

Choose the "On" or "Off" to turn on or off the internal speaker.

Mute

Use this option to temporarily turn off the sound.

- Choose the "On" to turn mute on.
- Choose the "Off" to turn mute off.

Note: "Mute" function affects both internal and external speaker volume.

Audio Input

The default audio settings are on the back panel of the projector. Use this option to reassign any of the Audio Inputs (1 or 2) to the current image source. Each Audio input can be assigned to more than one video source.

- Default: VGA1 / VGA2->Audio1, Video / S-Video->Audio2.
- 1080p / WXGA: Audio1 / 2: Mini jack connection.
- XGA: Audio1: Mini jack connection; Audio2: L / R.

Audio Out(Standby)

Choose the "On" or "Off" to turn on or off the audio out.

Note: If the "Audio Out (Standby)" option is turned "On", the power consumption of the projector in standby mode will be over 3W.

Exit

Choose "Exit" to exit the menu.

USING THE PROJECTOR

Setup audio settings volume menu

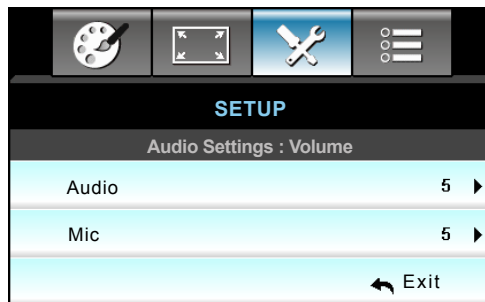

Audio

Adjust the volume level.

- Press the ◀ to decrease the volume.
- Press the ▶ to increase the volume.

Mic (XGA only)

Adjust the microphone input sound level.

- Press the ◀ to decrease the microphone input sound level.
- Press the ▶ to increase the microphone input sound level.

Setup Security menu



Security

Enable this function to prompt for a password before using the projector.

- On: Choose "On" to use security verification when the turning on the projector.
- Off: Choose "Off" to be able to switch on the projector without password verification.

USING THE PROJECTOR

Security Timer

Can be select the time (Month / Day / Hour) function to set the number of hours the projector can be used. Once this time has elapsed you will be requested to enter your password again.

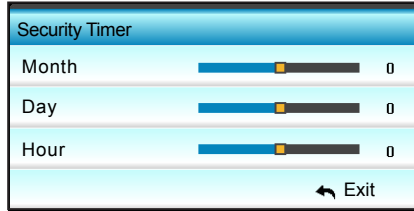

Change the Password

- ***First time:***
 1. Press the “Enter” key to set the password.
 2. The password has to be 4 digits.
 3. Use number button on the remote control or on-screen numeric keypad to enter your new password and then press the “Enter” key to confirm your password.

- ***Change Password:***

(If your remote does not have a number keypad, please use the ▲ ▼ arrows to change each digit of the password, then press the “Enter” key to confirm).

 1. Press the “Enter” key to input old password.
 2. Use the number button or on-screen numeric keypad to enter the current password and then press the “Enter” key to confirm.
 3. Enter the new password (4 digits in length) using the number buttons on the remote control, then press the “Enter” key to confirm.
 4. Enter the new password again and press the “Enter” key to confirm.

If the incorrect password is entered 3 times, the projector will automatically shut down.

If you have forgotten your password, please contact your local office for support.

Note: The password default value is "1234" (first time).



Exit

Choose "Exit" to exit the menu.

USING THE PROJECTOR

Setup network LAN settings menu

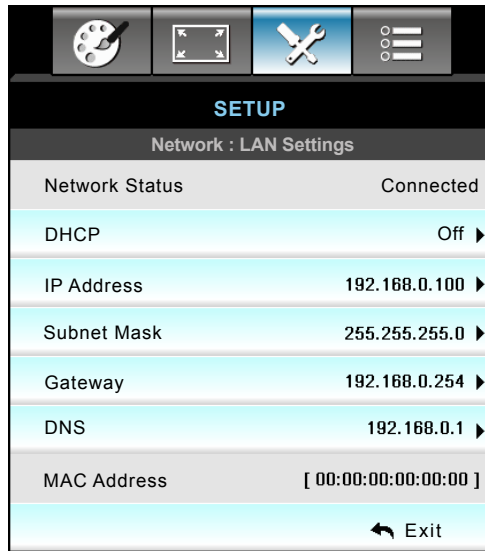

Network Status

Display the network connection status (read-only).

DHCP

Use this option to enable or disable the DHCP function.

- On: Projector will obtain an IP address automatically from your network.
- Off: To assign IP, Subnet Mask, Gateway and DNS configuration manually.

Note: Exiting OSD will automatically apply the entered values.

IP Address

Display the IP address.

Subnet Mask

Display subnet mask number.

Gateway

Display the default gateway of the network connected to the projector.

DNS

Display DNS number.

MAC Address

Display the MAC address (read-only).

Exit

Choose "Exit" to exit the menu.

How to use web browser to control your projector

1. Turn "On" the DHCP option on projector to allow a DHCP server to automatically assign an IP address.
2. Open the web browser in your PC and type in the projector's IP address ("Network: LAN Settings > IP Address").
3. Enter the user name and password, and click "Login".
The projector's configuration web interface opens.

USING THE PROJECTOR

Note:

- The default user name and password is "admin".
- The steps in this section is based on Windows 7 operating system.

Making a direct connection from your computer to the projector*

1. Turn "Off" the DHCP option on the projector.
2. Configure the IP address, Subnet Mask, Gateway, and DNS on projector ("Network: LAN Settings").

IP Address	192.168.0.100 ▶
Subnet Mask	255.255.255.0 ▶
Gateway	192.168.0.254 ▶
DNS	192.168.0.1 ▶

3. Open **Network and Sharing Center** page on your PC, and assign the identical network parameters to your PC as set on projector. Click "OK" to save the parameters.

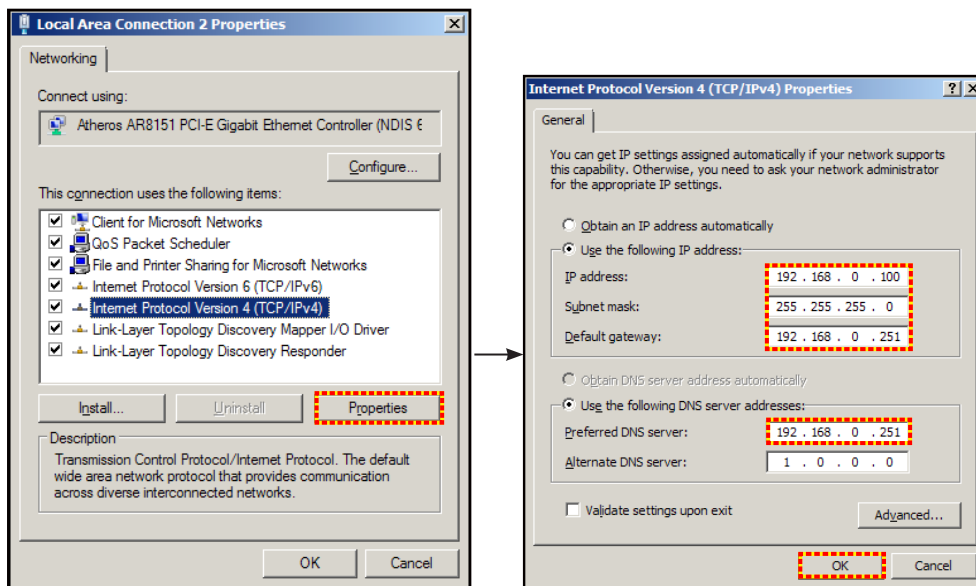

4. Open the web browser on your PC and type in to the URL field the IP address, assigned in step 3. Then press "Enter" key.

USING THE PROJECTOR

Setup network control settings menu

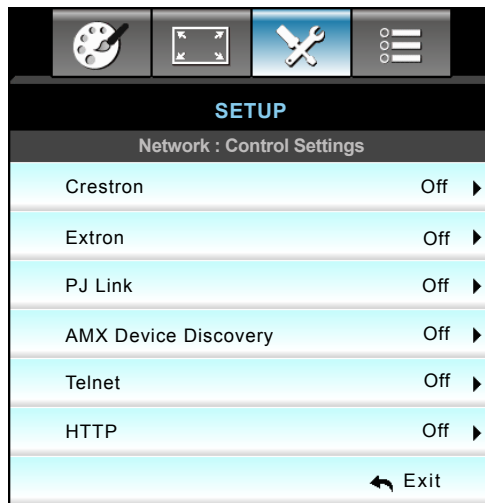

Crestron

Use this function to select the network function (port: 41794).

For more information, please visit <http://www.crestron.com> and www.crestron.com/getroomview.

Extron

Use this function to select the network function (port: 2023).

PJ Link

Use this function to select the network function (port: 4352).

AMX Device Discovery

Use this function to select the network function (port: 9131).

Telnet

Use this function to select the network function (port: 23).

HTTP

Use this function to select the network function (port: 80).

Exit

Choose "Exit" to exit the menu.

USING THE PROJECTOR

Setup network control settings menu

LAN_RJ45 function

For simplicity and ease of operation, the projector provides diverse networking and remote management features. The LAN / RJ45 function of the projector through a network, such as remotely manage: Power On / Off, Brightness and Contrast settings. Also you can view the projector status information, such as: Video- Source, Sound-Mute, etc.

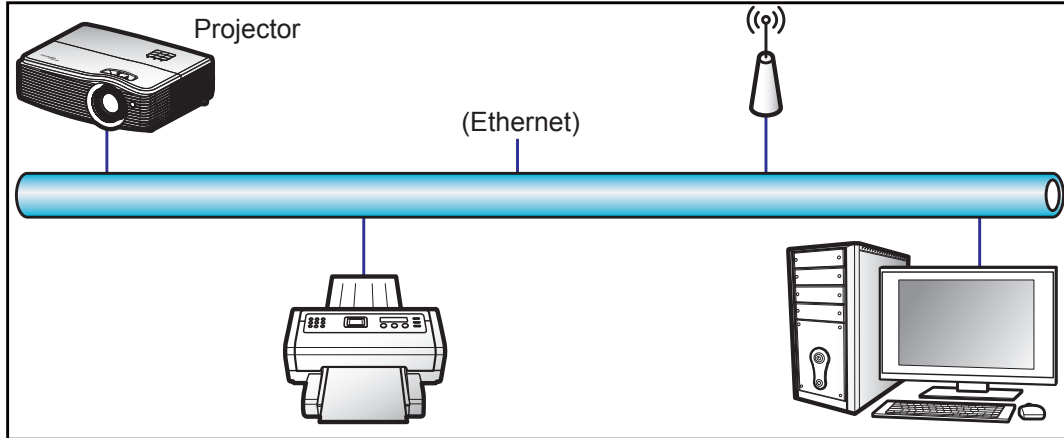

Wired LAN terminal functionalities

This projector can be controlled by using a PC (laptop) or other external device via LAN / RJ45 port and compatible with Crestron / Extron / AMX (Device Discovery) / PJLink.

- Crestron is a registered trademark of Crestron Electronics, Inc. of the United States.
- Extron is a registered trademark of Extron Electronics, Inc. of the United States.
- AMX is a registered trademark of AMX LLC of the United States.
- PJLink applied for trademark and logo registration in Japan, the United States of America, and other countries by JBMIA.

The projector is supported by the specified commands of the Crestron Electronics controller and related software, for example RoomView®.

<http://www.crestron.com/>

This projector is compliant to support Extron device(s) for reference.

<http://www.extron.com/>

This projector is supported by AMX (Device Discovery).

<http://www.amx.com/>

This projector supports all commands of PJLink Class1 (Version 1.00).

<http://pjlink.jbmia.or.jp/english/>

For more detailed information about the various types of external devices which can be connected to the LAN / RJ45 port and remote control the projector, as well as the supported commands for these external devices, please contact the Support-Service directly.

USING THE PROJECTOR

LAN RJ45

1. Connect an RJ45 cable to RJ45 ports on the projector and the PC (laptop).

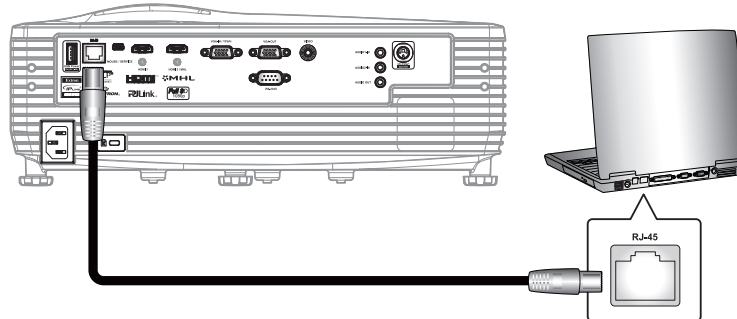

2. On the PC (Laptop), select **Start > Control Panel > Network Connections**.

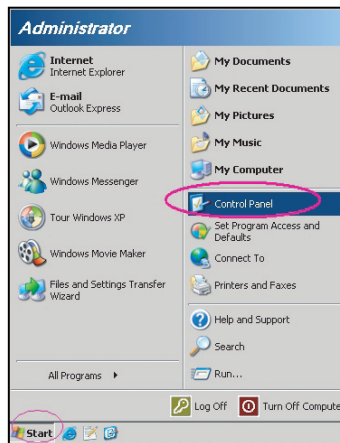

3. Right-click on the **Local Area Connection**, and select **Property**.

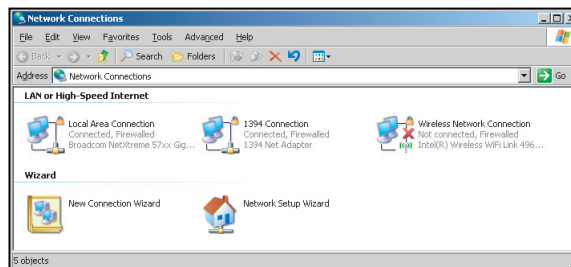

4. In the **Properties** window, select the **General tab**, and select **Internet Protocol (TCP / IP)**.

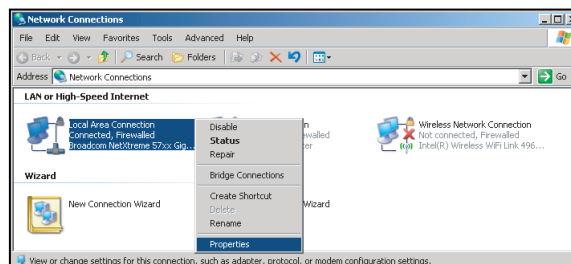

USING THE PROJECTOR

5. Click “Properties”.

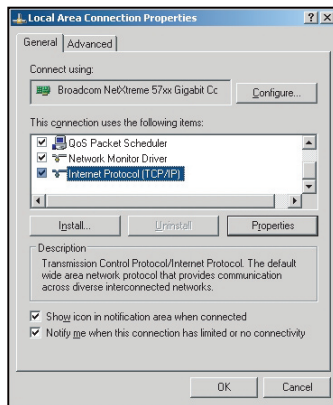

6. Type in the IP address and Subnet mask, then press “OK”.

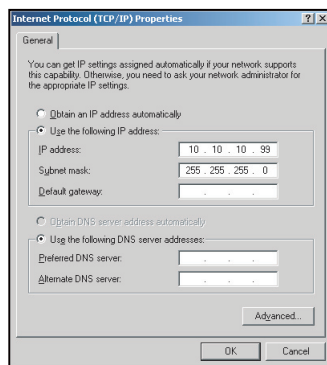

7. Press the “Menu” button on the projector.
8. Use the ◀▶ keys to select **SETUP > Network > LAN Settings**.
9. Enter the following connection parameters:
 - DHCP: Off
 - IP Address: 10.10.10.10
 - Subnet Mask: 255.255.255.255
 - Gateway: 0.0.0.0
 - DNS: 0.0.0.0
10. Press “Enter” to confirm settings.
11. Open a web browser, for example Microsoft Internet Explorer with Adobe Flash Player 9.0 or higher installed.
12. In the Address bar, input the projector’s IP address: 10.10.10.10.

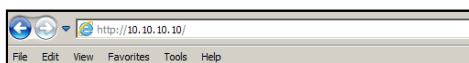

13. Press “Enter”.

USING THE PROJECTOR

The projector is setup for remote management. The LAN / RJ45 function displays as follows:

Information page

The screenshot shows the 'Information' page of the Optoma remote management interface. At the top, there is a navigation bar with 'Logout', 'Tools', 'Info', and 'Help'. The main content area is divided into two columns: 'Projector Information' and 'Projector Status'. The 'Projector Information' column contains fields for Projector Name (EX610STi), Location (Room), Firmware (B02 2011-09-21), Mac Address (00:50:41:77:31:24), Resolution (0 x 0 0Hz), Lamp Hours (10), and Assigned To (Sir). The 'Projector Status' column contains fields for Power Status (On), Source (HDMI), Preset Mode (Presentation), Projector Position (Front Table), Lamp Mode (STD), and Error Status. An 'exit' button is located at the bottom center.

Main page

The screenshot shows the 'Main' page of the Optoma remote management interface. At the top, there is a navigation bar with 'Tools', 'Info', and 'Help'. The main content area features a 'SourceList' section with a list of sources: VGA1 (selected), VGA2, Video, HDMI, and Flash Drive. To the right of the source list are control buttons: Menu, Auto, AV Mute, and Source. Below the source list are buttons for Freeze, Contrast, Brightness, and Color. An 'exit' button is located at the bottom center.

Tool page

The screenshot shows the 'Tool' page of the Optoma remote management interface. At the top, there is a navigation bar with 'Logout', 'Tools', 'Info', and 'Help'. The main content area is divided into three sections: 'Crestron Control', 'Projector', and 'User Password'. The 'Crestron Control' section has fields for IP Address (192.168.0.2), IP ID (5), and Port (41794), with a 'Send' button. The 'Projector' section has fields for Projector Name (EX610STi), Location (Room), Name (Sir), and a 'Send' button. Below these are DHCP settings: a checkbox for 'DHCP Enabled', IP Address (192.168.0.100), Subnet Mask (255.255.255.0), Default Gateway (192.168.0.254), DNS Server (192.168.0.1), and Host Name, with a 'Send' button. The 'User Password' section has a checkbox for 'Enabled', 'New Password', and 'Confirm' fields, with a 'Send' button. Below this is an 'Admin Password' section with a checkbox for 'Enabled', 'New Password', and 'Confirm' fields, with a 'Send' button. An 'exit' button is located at the bottom center.

Contact IT helpdesk

The screenshot shows a small 'HELP DESK' window. It has a title bar with 'HELP DESK' and a close button (X). Below the title bar is a text input field and a 'Send' button.

USING THE PROJECTOR

RS232 by Telnet Function

There is alternative RS232 command control way, in projector so called “RS232 by TELNET” for LAN / RJ45 interface.

Quick Start-Guide for “RS232 by Telnet”

- Check and get the IP address on OSD of the projector.
- Make sure that the PC / laptop can access the web-page of the projector.
- Make sure that “Windows Firewall” setting is set disabled in case of “TELNET” function filtering out by PC / laptop.

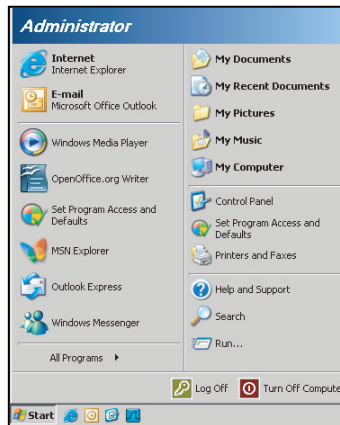

1. Select **Start > All Programs > Accessories > Command Prompt**.

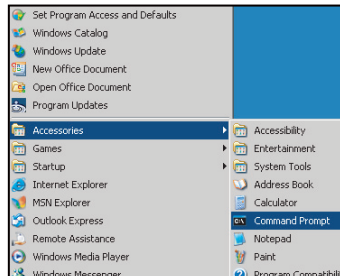

2. Input the command format as follows:
 - telnet ttt.xxx.yyy.zzz 23 (“Enter” key pressed)
 - (ttt.xxx.yyy.zzz: IP-Address of the projector)
3. If Telnet-Connection ready, and user can have RS232 command input, then “Enter” key pressed, the RS232 command will be workable.

Specification for “RS232 by TELNET”:

1. Telnet: TCP.
2. Telnet port: 23 (for more detail, kindly please get contact with the service agent or team).
3. Telnet utility: Windows “TELNET.exe” (console mode).
4. Disconnection for RS232-by-Telnet control normally: Close
5. Windows Telnet utility directly after TELNET connection ready.
 - Limitation 1 for Telnet-Control: there is less than 50 bytes for successive network payload for Telnet-Control application.
 - Limitation 2 for Telnet-Control: there is less than 26 bytes for one complete RS232 command for Telnet-Control.
 - Limitation 3 for Telnet-Control: Minimum delay for next RS232 command must be more than 200 (ms).

USING THE PROJECTOR

Setup advanced menu

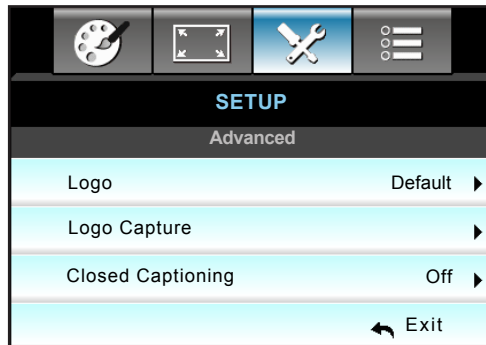

Logo

Use this function to set the desired startup screen. If changes are made, they will take effect the next time the projector is powered on.

- Default: The default startup screen.
- Neutral: Logo is not displayed on startup screen.
- User: Use stored picture from “Logo Capture” function.

Logo Capture

Press ► to capture an image of the picture currently displayed on the screen.

Note:

- *For a successful logo capture, ensure that the image does not exceed the projector's native resolution. If logo capture is still unsuccessful please try using a less detailed image.*
- *This feature is exclusively for capturing logos and not for capturing large-scale images.*

Closed Captioning

Closed Captioning is a text version of the program sound or other information displayed on the screen. If the input signal contains closed captions, you can turn on the feature and watch the channels. Press ◀ or ▶ to select Off, CC1, or CC2.

Exit

Choose "Exit" to exit the menu.

USING THE PROJECTOR

Options menu

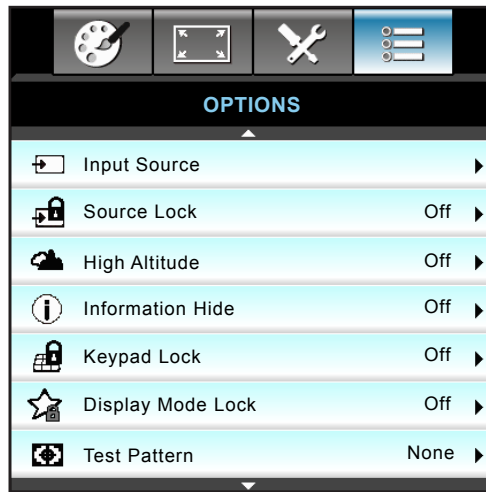

Input Source

Use this option to enable / disable input sources. Press ► to enter the sub menu and select which sources you require. Press "Enter" to finalize the selection. The projector will only search for inputs that are enabled.

1080P / WXGA

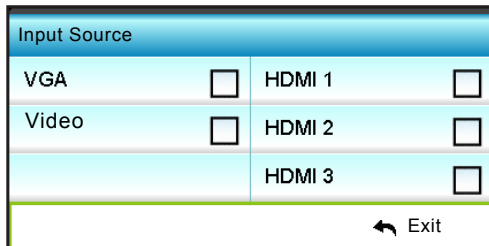

XGA

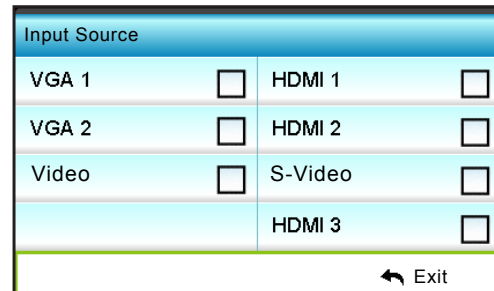

Source Lock

Use this function to let the projector to search for current input only or any input signals.

- On: The projector will only search current input connection.
- Off: The projector will search for other signals if the current input signal is lost.

High Altitude

When "On" is selected, the fans will spin faster. This feature is useful in high altitude areas where the air is thin.

Information Hide

Enable this function to hide the information message.

- On: Choose "On" to hide the info message.
- Off: Choose "Off" to show the "searching" message.

Keypad Lock

When the keypad lock function is "On", the Keypad will be locked. However, the projector can be operated by the remote control. By selecting "Off", you will be able to reuse the Keypad.

Display Mode Lock

Choose "On" or "Off" to lock or unlock adjusting display mode settings.

Test Pattern

Display a test pattern. The available options are Grid, White Pattern, and None.

USING THE PROJECTOR

Options menu

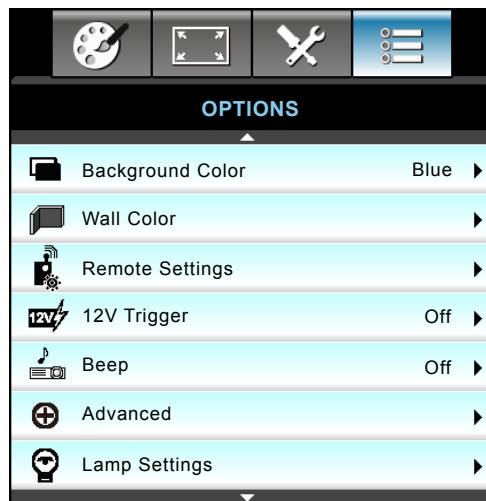

Background Color

Use this feature to display a "Black", "Red", "Blue", "Green", or "White", screen when no signal is available.

Wall Color

Use this function to obtain an optimized screen image according to the wall color. The available options: "Off", "Light Yellow", "Light Green", "Light Blue", "Pink", and "Gray".

12V Trigger

Use this function to enable or disable the trigger.

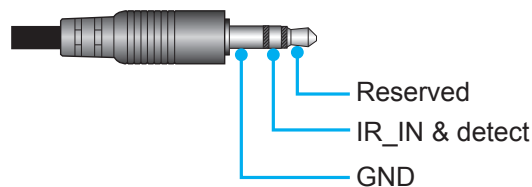

- Off: Choose "Off" to disable the trigger.
- On: Choose "On" to enable the trigger.

Beep

Use this function to enable or disable the beep sound.

- Off: No beep sound is audible when power on / off the projector or in an error event.
- On: Beep sound is audible when power on / off the projector or in an error event.

USING THE PROJECTOR

Options menu

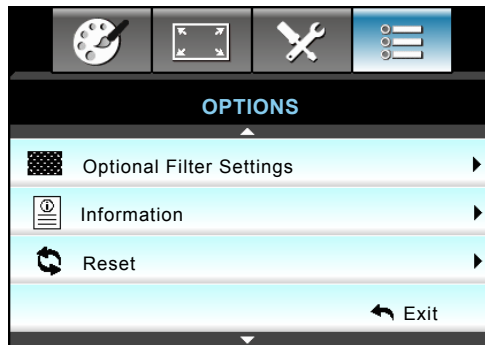

Information

Display the projector information.

Information	
S/N Number	XXXXXXXXXXXX
F/W Version	DDP C01
	MCU M01
	LAN L01
Current Input Source	VGA 1
Resolution	1920x1080
Refresh Rate	59.97 Hz
Lamp Hours	
Bright	0000 H
Eco	0000 H
Dynamic	0000 H
Eco+	0000 H
Filter Hour	0000 H
Projector ID	00
IP Address	192.168.0.100
Network Status	Connected

Exit

Exit

Choose "Exit" to exit the menu.

Reset

Choose "Yes" to return the factory default settings for "OPTIONAL FILTER".

USING THE PROJECTOR

Options lamp settings menu

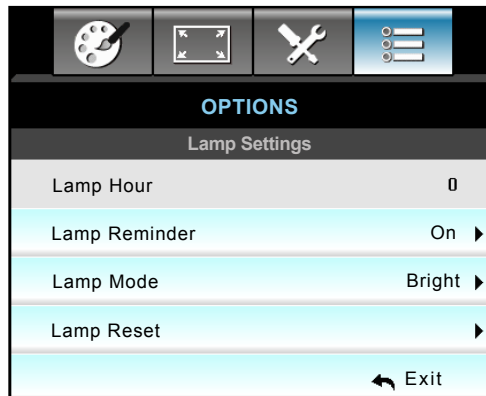

Lamp Hour

Display the projection time.

Lamp Reminder

Choose this function to show or to hide the warning message when the changing lamp message is displayed. The message will appear 30 hours before suggested replacement of lamp.

Lamp Mode

Set the lamp mode setting.

- Bright: Choose "Bright" to increase the brightness.
- Eco: Choose "Eco" to dim the projector lamp which will lower power consumption and extend the lamp life.
- Dynamic: Choose "Dynamic" to dim the lamp power which will be based on brightness level of the content and adjust lamp power consumption between 100% and 30% dynamically. The lamp life will be extended.
- Eco+: When Eco+ mode is activated, the brightness level of the content is automatically detected to significantly reduced lamp power consumption (up to 70%) during periods of inactivity.

Note:

- *When ambient temperature is over 40°C during operation, the projector will switch to Eco mode automatically.*
- *The "Lamp Mode" can be independently set for 2D and 3D.*

Lamp Reset

Resets the lamp hour counter after replacing the lamp.

Exit

Choose "Exit" to exit the menu.

USING THE PROJECTOR

Options remote settings menu

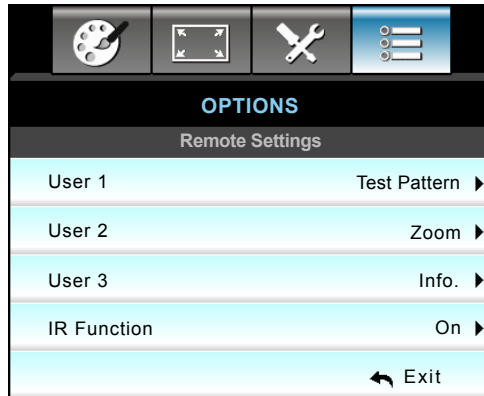

USER 1

Assign the default function for USER1. The default value is "Test Pattern".

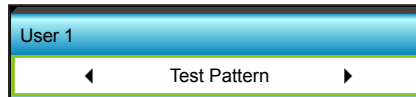

- Press ► into the next menu and then use ◀ or ▶ to select "HDMI2", "VGA2" (XGA only), "S-Video (XGA only)", "Test Pattern", "Zoom", or "Info" item.

USER 2

Assign the default function for USER 2. The default value is "Zoom".

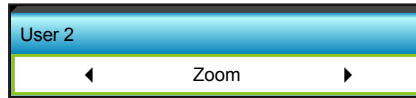

- Press ► into the next menu and then use ◀ or ▶ to select "HDMI2", "VGA2" (XGA only), "S-Video (XGA only)", "Test Pattern", "Zoom", or "Info" item.

USER 3

Assign the default function for USER 3. The default value is "Info.".

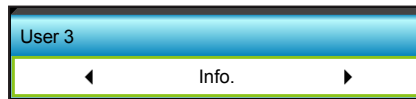

- Press ► into the next menu and then use ◀ or ▶ to select "HDMI2", "VGA2" (XGA only), "S-Video (XGA only)", "Test Pattern", "Zoom", or "Info" item.

IR Function

Set the IR function setting.

- On: Choose "On", the projector can be operated by the remote control from front or top IR receiver.
- Front: Choose "Front", the projector can be operated by the remote control from front IR receiver.
- Top: Choose "Top", the projector can be operated by the remote control from top IR receiver.
- Off: Choose "Off", the projector can't be operated by the remote control from front or top IR receiver. By selecting "Off", you will be able to use the Keypad keys.

Note:

- "Front" and "Top" cannot be selected in standby mode.
- IR mode can be switched to "NVIDIA 3D Vision" once implemented and verified by NVIDIA.

USING THE PROJECTOR

Options advanced menu

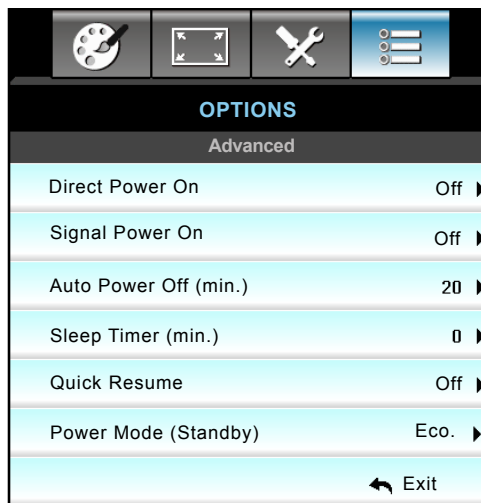

Direct Power On

Choose "On" to activate Direct Power mode. The projector will automatically power on when AC power is supplied, without pressing the "⏻" key on the projector Keypad or on the remote control.

Signal Power On

Choose "On" to activate Signal Power mode. The projector will automatically power on when a signal is detected, without pressing the "⏻" key on the projector Keypad or on the remote control.

Note: If the "Signal Power On" option is turned "On", the power consumption of the projector in standby mode will be over 3W.

Auto Power Off (min)

Sets the countdown timer interval. The countdown timer will start, when there is no signal being sent to the projector. The projector will automatically power off when the countdown has finished (in minutes).

- Press the ◀ to decrease the timer interval.
- Press the ▶ to increase the timer interval.

Note: The projector will automatically power off when the countdown has finished. The default setting is 20 minutes.

Sleep Timer (min)

Sets the countdown timer interval. The countdown timer will start, with or without a signal being sent to the projector. The projector will automatically power off when the countdown has finished (in minutes).

- Press the ◀ to decrease the timer interval.
- Press the ▶ to increase the timer interval.

Note: The Sleep Timer is reset every time when the projector is powered off.

Quick Resume

Set the quick resume setting.

- On: If the projector is accidentally turned off, this feature allows the projector to be instantly powered on again, if selected within a period of 100 seconds.
- Off: The fan will start cooling the system after 10 seconds when user turns off the projector.

USING THE PROJECTOR

Power Mode (Standby)

Set the power mode setting.

- Active: Choose “Active” to return to normal standby.
- Eco.: Choose “Eco.” to save power dissipation further < 0.5W.

Note:

- *If the “Signal Power On” option is turned “On” or the “Audio Out (Standby)” option is turned “On”, the power consumption of the projector in standby mode will be over 3W.*
- *The fans will still run in active standby if audio loop through / signal power on is enabled.*

Exit

Choose “Exit” to exit the menu.

USING THE PROJECTOR

Options optional filter settings menu

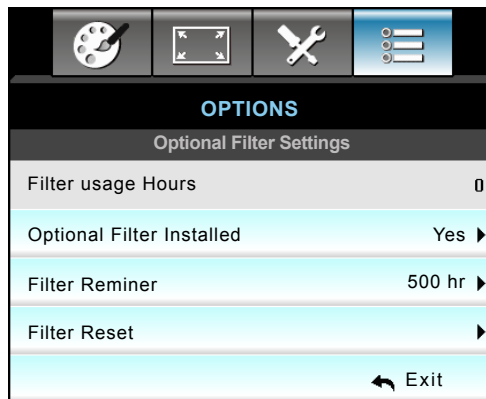

Filter Usage Hours

Display the filter time.

Optional Filter Installed

Choose this function to show or hide the warning message after 500 hours of use.

- Yes: Display warning message after 500 hours of use.
- No: Turn off warning message.

Note: "Filter Usage Hours / Filter Reminder / Filter Reset" will only appear when "Optional Filter Installed" is "Yes".

Filter Reminder

Choose this function to show or hide the warning message when the changing filter message is displayed. (Factory default setting: 500 hours).

Filter Reset

Reset the dust filter counter after replacing or cleaning the dust filter.

Exit

Choose "Exit" to exit the menu.

USING THE PROJECTOR

3D Setup

1. Turn on your projector.
2. Connect your 3D source. For example, 3D Blu ray, Games console, PC, Set top box, etc.
3. Ensure you have inserted 3D content or selected the 3D channel.
4. Turn on your 3D glasses. Please refer to the 3D glasses user manual on how to operate the 3D glasses.
5. Your projector will automatically display 3D from a 3D Blu-ray. For 3D via a set top box or PC, you will be required to adjust the settings in the 3D menu.

For 3D via Blu ray

3D will automatically be displayed. Depending on the 3D glasses you have you will either need to select DLP Link or VESA in the menu. VESA glasses come with an emitter that must be connected to the 3D Sync port of the projector. Please refer to pages 15-16.

- Menu > "Display" > "3D" > "3D Mode" > "DLP Link"
- Menu > "Display" > "3D" > "3D Mode" > "VESA"

For 3D via a PC or Set top box

3D will not be displayed automatically. Depending on the 3D content the image will either be displayed side by side or top and bottom. Please refer to the following table.

SBS	SBS	Top and bottom
		Top and bottom

- For side by side images, select "SBS" in the menu. Menu > "Display" > "3D" > "3D Format" > "SBS".
 - For top and bottom images, select "top and bottom" in the menu. Menu > "Display" > "3D" > "3D Format" > "Top and bottom".
- If the 3D image does not look correct, you may also be required to adjust the 3D sync invert. Turn this on if the image looks odd. Menu > "Display" > "3D" > "3D Sync Invert" > "On".

Note: If input video is normal 2D, please press "3D" and switch to "Auto". If "SBS" mode is active, 2D video content will not be displayed correctly. Please change back to "Auto" when 3D via a PC only works with certain resolutions. Please check the compatibility on page 69.

MAINTENANCE

Replacing the lamp

The projector automatically detects the lamp life. When the lamp life is nearing the end of use, a warning message will appear on the screen.

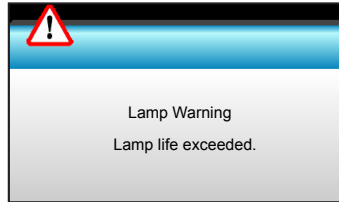

When you see this message, please contact your local reseller or service center to change the lamp as soon as possible. Make sure the projector has been cooled down for at least 30 minutes before changing the lamp.



Warning: If ceiling mounted, please use caution when opening the lamp access panel. It is recommended to wear safety glasses if changing the bulb when ceiling mounted. Caution must be used to prevent any loose parts from falling out of projector.



Warning: Lamp compartment is hot! Allow it to cool down before changing lamp!



Warning: To reduce the risk of personal injury, do not drop the lamp module or touch the lamp bulb. The bulb may shatter and cause injury if it is dropped.

MAINTENANCE

Replacing the lamp (continued)

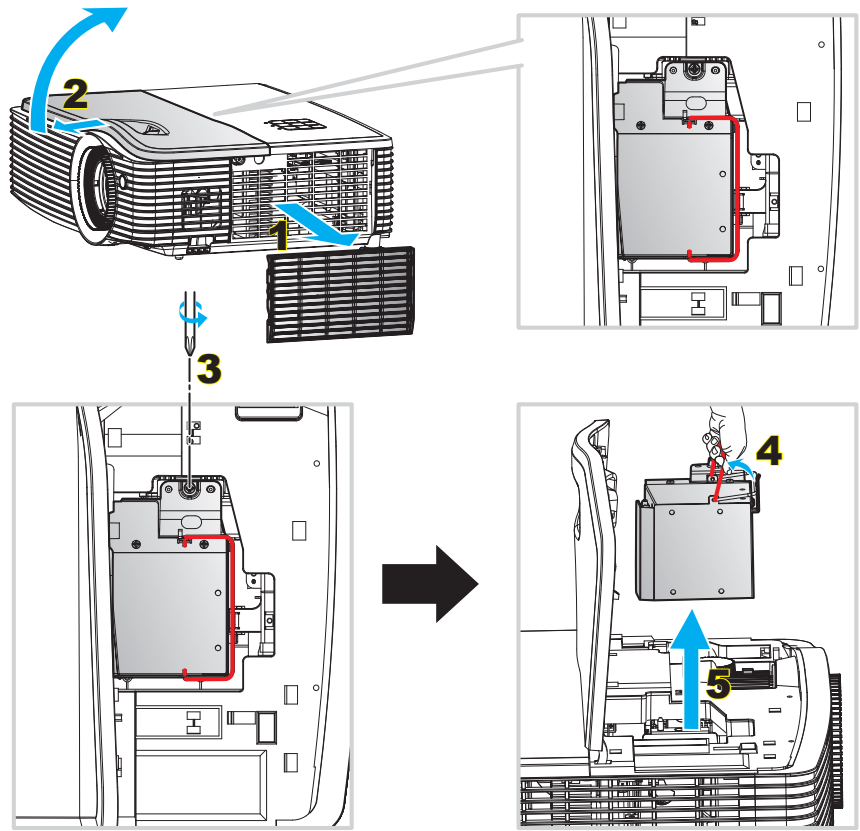

Procedure:

1. Switch off the power to the projector by pressing the "⏻" button on the remote control or the projector Keypad.
2. Allow the projector to cool down for at least 30 minutes.
3. Disconnect the power cord.
4. Remove the dust filter. **1**
5. First slide and then lift the top cover. **2**
6. Unscrew the screw on the side panel. **3**
7. Lift up the lamp handle. **4**
8. Remove the lamp module carefully. **5**
9. To replace the lamp module, reverse the previous steps.
10. Turn on the projector and reset the lamp timer.
11. Lamp Reset: (i) Press "Menu" → (ii) Select "OPTIONS" → (iii) Select "Lamp Settings" → (iv) Select "Lamp Reset" → (v) Select "Yes".

Note:

- *The projector cannot be turned on if the lamp cover has not been placed back on the projector.*
- *Do not touch the glass area of the lamp. Hand oil can cause the lamp shatter. Use a dry cloth to clean the lamp module if it was accidentally touched.*

MAINTENANCE

Installing and cleaning the dust filter

Installing the dust filter

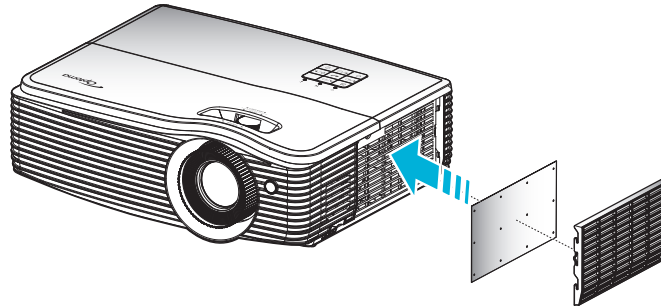

Note: Dust filters are only required / supplied in the selected regions with excessive dust.

Cleaning the dust filter

We recommend you to clean the dust filter every three months. Clean it more often if the projector is used in a dusty environment.

Procedure:

1. Switch off the power to the projector by pressing the "⏻" button on the remote control or the projector Keypad.
2. Disconnect the power cord.
3. Remove the dust filter carefully. **1**
4. Clean or replace the dust filter. **2**
5. To install the dust filter, reverse the previous steps.

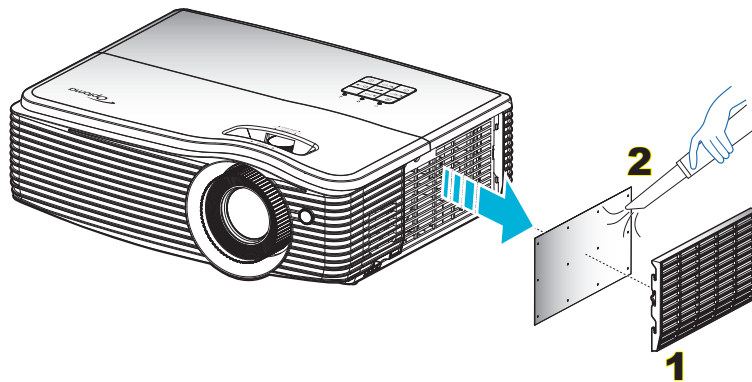

ADDITIONAL INFORMATION

Compatible resolutions

Digital compatibility

B0/Established Timing	B0/Standard Timing	B0/Detail Timing	B1/Video Mode	B1/Detail Timing
720 x 400 @ 70Hz	XGA / WXGA:	Native timing:	640 x 480p @ 60Hz	720 x 480p @ 60Hz
640 x 480 @ 60Hz	1440 x 900 @ 60Hz	XGA: 1024 x 768 @ 60Hz	720 x 480p @ 60Hz	1280 x 720p @ 60Hz
640 x 480 @ 67Hz	1024 x 768 @ 120Hz	WXGA: 1280 x 800 @ 60Hz	1280 x 720p @ 60Hz	1366 x 768 @ 60Hz
640 x 480 @ 72Hz	1280 x 800 @ 60Hz	1080P: 1920 x 1080 @ 60Hz	1920 x 1080i @ 60Hz	1920 x 1080i @ 50Hz
640 x 480 @ 75Hz	1280 x 1024 @ 60Hz	WUXGA: 1920 x 1200 @ 60Hz	720(1440) x 480i @ 60Hz	1920 x 1080p @ 60Hz
800 x 600 @ 56Hz	1680 x 1050 @ 60Hz		1920 x 1080p @ 60Hz	
800 x 600 @ 60Hz	1280 x 720 @ 60Hz		720 x 576p @ 50Hz	
800 x 600 @ 72Hz	1280 x 720 @ 120Hz		1280 x 720p @ 50Hz	
800 x 600 @ 75Hz	1600 x 1200 @ 60Hz		1920 x 1080i @ 50Hz	
832 x 624 @ 75Hz			720(1440) x 576i @ 50Hz	
1024 x 768 @ 60Hz	1080P / WUXGA:		1920 x 1080p @ 50Hz	
1024 x 768 @ 70Hz	1280 x 720 @ 60Hz		1920 x 1080p @ 24Hz	
1024 x 768 @ 75Hz	1280 x 800 @ 60Hz		1920 x 1080p @ 30Hz	
1280 x 1024 @ 75Hz	1280 x 1024 @ 60Hz			
1152 x 870 @ 75Hz	1400 x 1050 @ 60Hz			
	1600 x 1200 @ 60Hz			
	1440 x 900 @ 60Hz			
	1280 x 720 @ 120Hz			
	1024 x 768 @ 120Hz			

VGA analog compatibility

B0/Established Timing	B0/Standard Timing	B0/Detail Timing	B1/Video Mode	B1/Detail Timing
720 x 400 @ 70Hz	XGA / WXGA:	Native timing:		1366 x 768 @ 60Hz
640 x 480 @ 60Hz	1440 x 900 @ 60Hz	XGA: 1024 x 768 @ 60Hz		
640 x 480 @ 67Hz	1024 x 768 @ 120Hz	WXGA: 1280 x 800 @ 60Hz		
640 x 480 @ 72Hz	1280 x 800 @ 60Hz	1080P: 1920 x 1080 @ 60Hz		
640 x 480 @ 75Hz	1280 x 1024 @ 60Hz	WUXGA: 1920 x 1200 @ 60Hz		
800 x 600 @ 56Hz	1680 x 1050 @ 60Hz			
800 x 600 @ 60Hz	1280 x 720 @ 60Hz			
800 x 600 @ 72Hz	1280 x 720 @ 120Hz			
800 x 600 @ 75Hz	1600 x 1200 @ 60Hz			
832 x 624 @ 75Hz				
1024 x 768 @ 60Hz	1080P / WUXGA:			
1024 x 768 @ 70Hz	1280 x 720 @ 60Hz			
1024 x 768 @ 75Hz	1280 x 800 @ 60Hz			
1280 x 1024 @ 75Hz	1280 x 1024 @ 60Hz			
1152 x 870 @ 75Hz	1400 x 1050 @ 60Hz			
	1600 x 1200 @ 60Hz			
	1440 x 900 @ 60Hz			
	1280 x 720 @ 120Hz			
	1024 x 768 @ 120Hz			

ADDITIONAL INFORMATION

True 3D video compatibility

Input resolution	HDMI 1.4a 3D Input	Input timing		
		1280 x 720P @ 50Hz	Top - and - Bottom	
		1280 x 720P @ 60Hz	Top - and - Bottom	
		1280 x 720P @ 50Hz	Frame packing	
		1280 x 720P @ 60Hz	Frame packing	
		1920 x 1080i @ 50 Hz	Side- by-Side (Half)	
		1920 x 1080i @ 60 Hz	Side- by-Side (Half)	
		1920 x 1080P @ 24 Hz	Top - and- Bottom	
		1920 x 1080P @ 24 Hz	Frame packing	
	HDMI 1.3	1920 x 1080i @ 50Hz	Side-by-Side(Half)	SBS mode is on
		1920 x1080i @ 60Hz		
		1280 x 720P @ 50Hz		
		1280 x 720P @ 60Hz		
		1920 x 1080i @ 50Hz	Top-and-Bottom	TAB mode is on
		1920 x1080i @ 60Hz		
		1280 x 720P @ 50Hz		
		1280 x 720P @ 60Hz		
		480i	HQFS	3D format is Frame sequential

Image size and projection distance

(XGA)

Desired Image Size						Projection Distance (C)			
Diagonal		Width		Height		Wide		Tele	
m	inch	m	inch	m	inch	m	feet	m	feet
0.76	30	0.61	24	0.46	18	/	/	1.8	5.91
1.02	40	0.81	32	0.61	24	1.5	4.92	2.4	7.87
1.27	50	1.02	40	0.76	30	1.9	6.23	3.0	9.84
1.52	60	1.22	48	0.91	36	2.3	7.55	3.6	11.81
1.78	70	1.42	56	1.07	42	2.6	8.53	4.2	13.78
2.03	80	1.63	64	1.22	48	3.0	9.84	4.8	15.75
2.29	90	1.83	72	1.37	54	3.4	11.15	5.4	17.72
2.54	100	2.03	80	1.52	60	3.8	12.47	6.0	19.69
3.05	120	2.44	96	1.83	72	4.5	14.76	7.2	23.62
3.81	150	3.05	120	2.29	90	5.6	18.37	9.0	29.53
4.57	180	3.66	144	2.74	108	6.8	22.31	10.8	35.43
5.08	200	4.06	160	3.05	120	7.5	24.61	12.0	39.37
6.35	250	5.08	200	3.81	150	9.4	30.84	15.0	49.21
7.62	300	6.10	240	4.57	180	11.3	37.07	18.0	59.06

ADDITIONAL INFORMATION

Lens Shift Range					
PJ lens Center to top of image				Image Shift Range	
Vertical + (Max) (A)	Vertical - (Min) (B)	(D) = (A) - (B)	Vertical range at any Horizontal position	Horizontal + (Right)	Horizontal - (Left)
cm	cm	cm	cm	cm	cm
52.6	44.9	7.7	N/A	0.0	0.0
70.1	59.8	10.3	N/A	0.0	0.0
87.6	74.8	12.9	N/A	0.0	0.0
105.2	89.7	15.5	N/A	0.0	0.0
122.7	104.7	18.0	N/A	0.0	0.0
140.2	119.6	20.6	N/A	0.0	0.0
157.7	134.6	23.2	N/A	0.0	0.0
175.3	149.5	25.8	N/A	0.0	0.0
210.3	179.4	30.9	N/A	0.0	0.0
262.9	224.3	38.6	N/A	0.0	0.0
315.5	269.1	46.4	N/A	0.0	0.0
350.5	299.0	51.5	N/A	0.0	0.0
438.2	373.8	64.4	N/A	0.0	0.0
525.8	448.5	77.3	N/A	0.0	0.0

Note:

- Vertical Lens Shift values are always calculated from the Center of Projection Lens. Therefore the distance 6.8 cm (2.68 inch) from the Base to the Center of Projection Lens needs to be added to each Vertical Lens Shift value.
- Zoom ratio is 1.6x.

(1080P)

Diagonal Length Size of (16:9) Screen	Screen Size W x H				Projection Distance (D)			
	(m)		(inch)		(m)		(feet)	
	Width	Height	Width	Height	Wide	Tele	Wide	Tele
36	0.80	0.45	31.38	17.65	1.1	1.8	3.61	5.91
40	0.89	0.5	34.86	19.6	1.2	2.0	3.94	6.56
50	1.11	0.62	43.58	24.5	1.5	2.5	4.92	8.20
60	1.33	0.75	52.29	29.4	1.9	3.0	6.23	9.84
70	1.55	0.87	61.01	34.3	2.2	3.5	7.22	11.48
80	1.77	1	69.73	39.2	2.5	4.0	8.20	13.12
90	1.99	1.12	78.44	44.1	2.8	4.5	9.19	14.76
100	2.21	1.25	87.16	49	3.1	5.0	10.17	16.40
120	2.66	1.49	104.59	58.8	3.7	6.0	12.14	19.69
150	3.32	1.87	130.74	73.5	4.6	7.4	15.09	24.28
180	3.98	2.24	156.88	88.2	5.6	8.9	18.37	29.20
200	4.43	2.49	174.32	98.1	6.2	9.9	20.34	32.48
250	5.53	3.11	217.89	122.6	7.7	12.4	25.26	40.68
300	6.64	3.74	261.47	147.1	9.3	14.9	30.51	48.88

ADDITIONAL INFORMATION

Lens Shift Range						Offset (Hd)	
PJ lens Center to top of image			Image Shift Range				
Vertical + (Max) (A)	Vertical - (Min) (B)	(D) = (A) - (B)	Vertical range at any Horizontal position	Horizontal + (Right)	Horizontal - (Left)		
cm	cm	cm	cm	cm	cm	m	inch
52.0	44.3	7.7	N/A	0.0	0.0	0.07	2.76
57.8	49.3	8.5	N/A	0.0	0.0	0.08	3.15
72.2	61.6	10.7	N/A	0.0	0.0	0.10	3.94
86.7	73.9	12.8	N/A	0.0	0.0	0.12	4.72
101.1	86.2	14.9	N/A	0.0	0.0	0.14	5.51
115.6	98.5	17.0	N/A	0.0	0.0	0.16	6.30
130.0	110.8	19.2	N/A	0.0	0.0	0.18	7.09
144.5	123.2	21.3	N/A	0.0	0.0	0.19	7.48
173.3	147.8	25.6	N/A	0.0	0.0	0.24	9.45
216.7	184.7	32.0	N/A	0.0	0.0	0.30	11.81
260.0	221.7	38.3	N/A	0.0	0.0	0.36	14.17
288.9	246.3	42.6	N/A	0.0	0.0	0.40	15.75
361.1	307.9	53.2	N/A	0.0	0.0	0.50	19.69
433.4	369.5	63.9	N/A	0.0	0.0	0.59	23.23

Note:

- Vertical Lens Shift values are always calculated from the Center of Projection Lens. Therefore the distance 6.8 cm (2.68 inch) from the Base to the Center of Projection Lens needs to be added to each Vertical Lens Shift value.
- Zoom ratio is 1.6x.

(WXGA)

Desired Image Size						Projection Distance (C)			
Diagonal		Width		Height		Wide		Tele	
m	inch	m	inch	m	inch	m	feet	m	feet
0.91	36	0.78	30.53	0.48	19.08	1.1	3.61	1.8	5.91
1.02	40	0.86	33.92	0.54	21.2	1.3	4.27	2.0	6.56
1.27	50	1.08	42.4	0.67	26.5	1.6	5.25	2.6	8.53
1.52	60	1.29	50.88	0.81	31.8	1.9	6.23	3.1	10.17
1.78	70	1.51	59.36	0.94	37.1	2.2	7.22	3.6	11.81
2.03	80	1.72	67.84	1.08	42.4	2.6	8.53	4.1	13.45
2.29	90	1.94	76.32	1.21	47.7	2.9	9.51	4.6	15.09
2.54	100	2.15	84.8	1.35	53	3.2	10.50	5.1	16.73
3.05	120	2.58	101.76	1.62	63.6	3.8	12.47	6.1	20.01
3.81	150	3.23	127.2	2.02	79.5	4.8	15.75	7.7	25.26
4.57	180	3.88	152.64	2.42	95.4	5.7	18.70	9.2	30.18
5.08	200	4.31	169.6	2.69	106	6.4	21.00	10.2	33.46
6.35	250	5.38	212	3.37	132.5	8.0	26.25	/	/
7.62	300	6.46	254.4	4.04	159	9.6	31.50	/	/

ADDITIONAL INFORMATION

Lens Shift Range					
PJ lens Center to top of image				Image Shift Range	
Vertical + (Max) (A)	Vertical - (Min) (B)	Vertical Shift Range	Vertical range at any Horizontal position	Horizontal + (Right)	Horizontal - (Left)
cm	cm	cm	cm	cm	cm
54.5	46.6	7.9	N/A	0.0	0.0
60.5	51.8	8.7	N/A	0.0	0.0
75.7	64.8	10.9	N/A	0.0	0.0
90.8	77.7	13.1	N/A	0.0	0.0
105.9	90.7	15.3	N/A	0.0	0.0
121.1	103.6	17.5	N/A	0.0	0.0
136.2	116.6	19.6	N/A	0.0	0.0
151.3	129.5	21.8	N/A	0.0	0.0
181.6	155.4	26.2	N/A	0.0	0.0
227.0	194.3	32.7	N/A	0.0	0.0
272.4	233.1	39.3	N/A	0.0	0.0
302.6	259.0	43.6	N/A	0.0	0.0
378.3	323.8	54.5	N/A	0.0	0.0
453.9	388.5	65.4	N/A	0.0	0.0

Note:

- Vertical Lens Shift values are always calculated from the Center of Projection Lens. Therefore the distance 6.8 cm (2.68 inch) from the Base to the Center of Projection Lens needs to be added to each Vertical Lens Shift value.
- Zoom ratio is 1.6x.

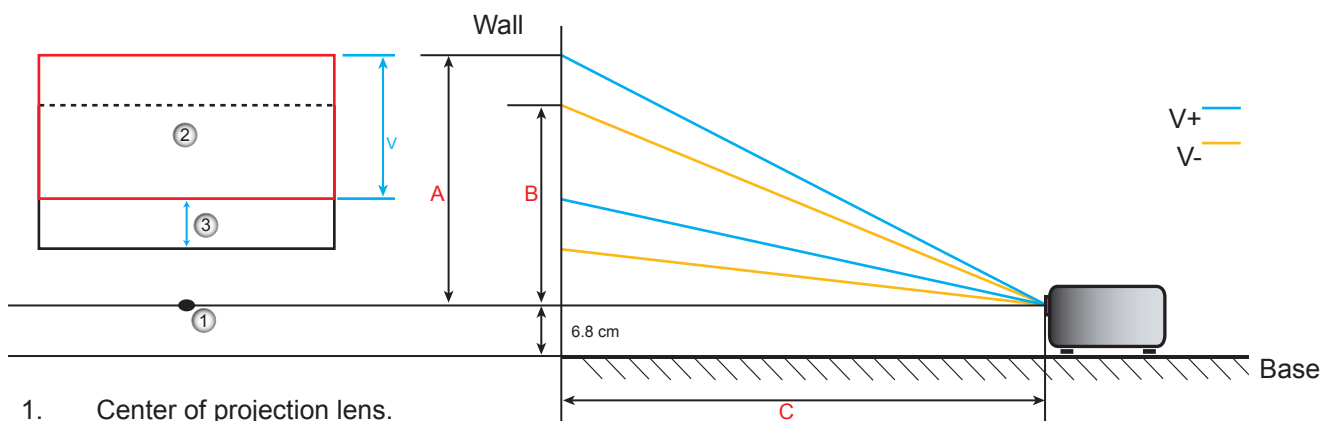

1. Center of projection lens.
2. Projection image while lens shift at the highest position.
3. Vertical shift range: 10% V.

ADDITIONAL INFORMATION

Determining the lens shift center position

Vertical Lens Shift Center

1. Image must be at the center of its Horizontal shift before adjusting the image to the center of its Vertical shift.



2. Adjust the V. Shift until the image reaches the maximum shift range towards the bottom.

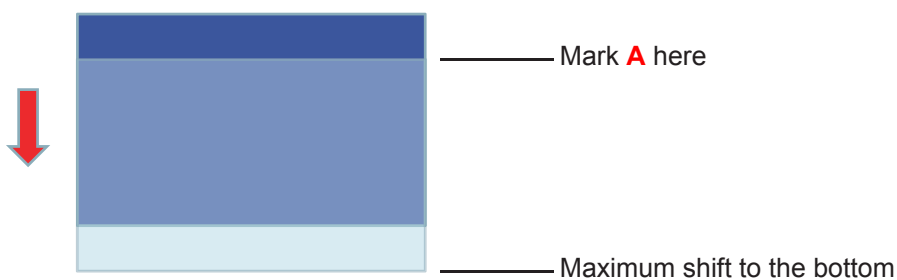

3. Adjust the V. Shift until the image reaches the maximum shift range to the top.

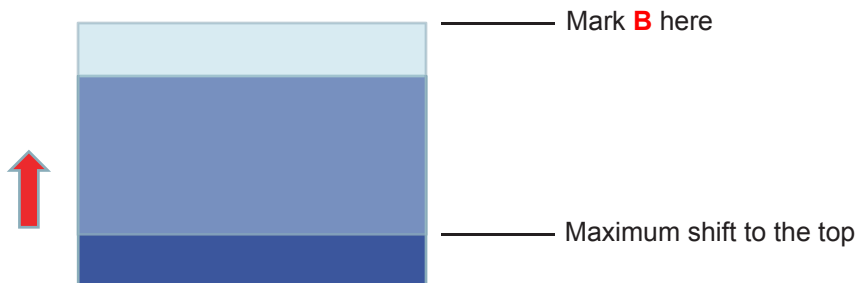

4. Measure the distance between Mark **A** and Mark **B**, then divide it by 2 and position the image back to Mark **A / B** to the bottom. The image will be at the center of its Vertical shift.

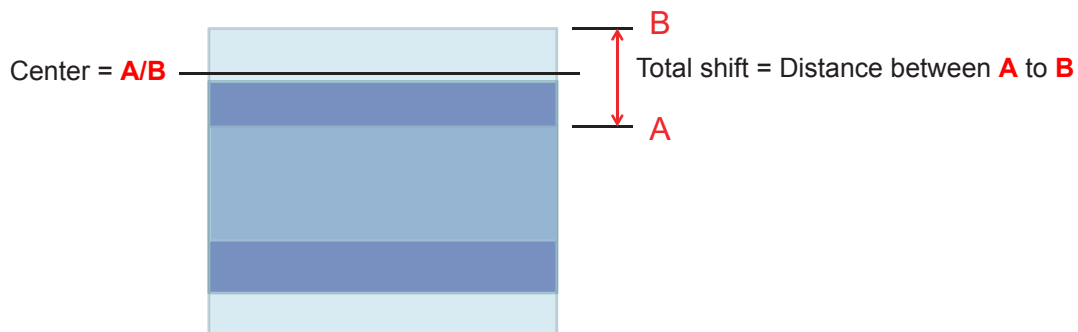

ADDITIONAL INFORMATION

Projector dimensions and ceiling mount installation

1. To prevent damage to your projector, please use the Optoma ceiling mount.
2. If you wish to use a third party ceiling mount kit, please ensure the screws used to attach a mount to the projector meet the following specifications:
 - Screw type: M4*3
 - Minimum screw length: 10mm

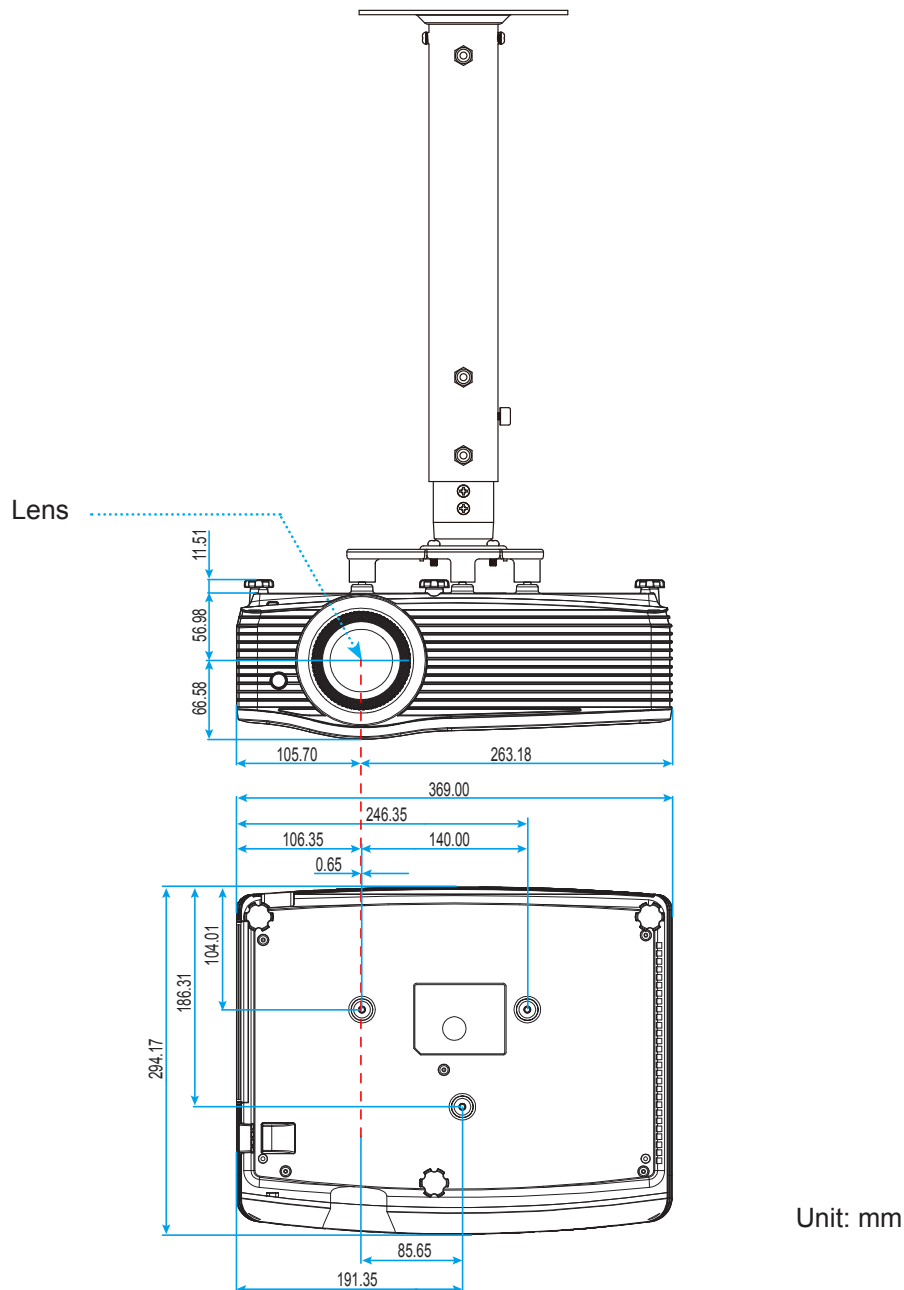

Note: Please note that damage resulting from incorrect installation will void the warranty.



Warning:

- If you buy a ceiling mount from another company, please be sure to use the correct screw size. Screw size will vary depending on the thickness of the mounting plate.
- Be sure to keep at least 10 cm gap between the ceiling and the bottom of the projector.
- Avoid installing the projector near a heat source.

ADDITIONAL INFORMATION

RS232 protocol function list

Baud Rate : 9600

Data Bits: 8

Parity: None

Stop Bits: 1

Flow Control : None

UART16550 FIFO: Disable

Projector Return (Pass): P

Projector Return (Fail): F

XX=01-99, projector's ID, XX=00 is for all projectors

Note: There is a <CR> after all ASCII commands 0D is the HEX code for <CR> in ASCII code.

SEND to projector			
232 ASCII Code	HEX Code	Function	Description
~XX00 1	7E 30 30 30 30 20 31 0D	Power ON	
~XX00 0	7E 30 30 30 30 20 30 0D	Power OFF	(0/2 for backward compatible)
~XX00 1 ~nnnn	7E 30 30 30 30 20 31 20 a 0D	Power ON with Password	~nnnn = ~0000 (a=7E 30 30 30 30) ~9999 (a=7E 39 39 39 39)
~XX01 1	7E 30 30 30 31 20 31 0D	Resync	
~XX02 1	7E 30 30 30 32 20 31 0D	AV Mute	On
~XX02 0	7E 30 30 30 32 20 30 0D		Off (0/2 for backward compatible)
~XX03 1	7E 30 30 30 33 20 31 0D	Mute	On
~XX03 0	7E 30 30 30 33 20 30 0D		Off (0/2 for backward compatible)
~XX04 1	7E 30 30 30 34 20 31 0D	Freeze	
~XX04 0	7E 30 30 30 34 20 30 0D	Unfreeze	(0/2 for backward compatible)
~XX05 1	7E 30 30 30 35 20 31 0D	Zoom Plus	
~XX06 1	7E 30 30 30 36 20 31 0D	Zoom Minus	
~XX12 1	7E 30 30 31 32 20 31 0D	Direct Source Commands	HDMI1
~XX12 15	7E 30 30 31 32 20 31 35 0D		HDMI2
~XX12 16	7E 30 30 31 32 20 31 36 0D		HDMI3
~XX12 5	7E 30 30 31 32 20 35 0D		VGA1
~XX12 8	7E 30 30 31 32 20 38 0D		VGA1 Component
~XX12 6	7E 30 30 31 32 20 36 0D		VGA 2 (XGA only)
~XX12 13	7E 30 30 31 32 20 31 33 0D		VGA2 Component (XGA only)
~XX12 9	7E 30 30 31 32 20 39 0D		S-Video (XGA only)
~XX12 10	7E 30 30 31 32 20 31 30 0D		Video
~XX20 1	7E 30 30 32 30 20 31 0D	Display Mode	Presentation
~XX20 2	7E 30 30 32 30 20 32 0D		Bright
~XX20 3	7E 30 30 32 30 20 33 0D		Movie
~XX20 4	7E 30 30 32 30 20 34 0D		sRGB
~XX20 5	7E 30 30 32 30 20 35 0D		User
~XX20 7	7E 30 30 32 30 20 37 0D		Blackboard
~XX20 13	7E 30 30 32 30 21 33 0D		DICOM SIM.
~XX20 9	7E 30 30 32 30 20 39 0D		3D
~XX21 n	7E 30 30 32 31 20 a 0D	Brightness	n = -50 (a=2D 35 30) ~ 50 (a=35 30)
~XX22 n	7E 30 30 32 32 20 a 0D	Contrast	n = -50 (a=2D 35 30) ~ 50 (a=35 30)
~XX23 n	7E 30 30 32 33 20 a 0D	Sharpness	n = 1 (a=31) ~ 15 (a=31 35)
~XX45 n	7E 30 30 34 34 20 a 0D	Color (Saturation)	n = -50 (a=2D 35 30) ~ 50 (a=35 30)
~XX44 n	7E 30 30 34 35 20 a 0D	Tint	n = -50 (a=2D 35 30) ~ 50 (a=35 30)
~XX196 n	7E 30 30 31 39 36 20 a 0D	Noise Reduction	n = 1 (a=31) ~ 10 (a=31 30)
~XX34 n	7E 30 30 33 34 20 a 0D	BrilliantColor™	n = 1 (a=31) ~ 10 (a=31 30)
~XX191 1	7E 30 30 31 39 31 20 31 0D	DynamicBlack	On
~XX191 0	7E 30 30 31 39 31 20 30 0D		Off(0/2 for backward compatible)
~XX35 1	7E 30 30 33 35 20 31 0D	Gamma	Film
~XX35 3	7E 30 30 33 35 20 33 0D		Graphics
~XX35 7	7E 30 30 33 35 20 37 0D		2.2
~XX35 5	7E 30 30 33 35 20 35 0D		1.8
~XX35 6	7E 30 30 33 35 20 36 0D		2.0

ADDITIONAL INFORMATION

232 ASCII Code	HEX Code	Function	Description	
~XX35 8	7E 30 30 33 35 20 38 0D		2.6	
~XX35 10	7E 30 30 33 35 20 31 30 0D		Blackboard	
~XX35 11	7E 30 30 33 35 20 31 31 0D		DICOM	
~XX36 4	7E 30 30 33 36 20 34 0D	Color Temp.	Warm	
~XX36 1	7E 30 30 33 36 20 31 0D		Standard	
~XX36 2	7E 30 30 33 36 20 32 0D		Cool	
~XX36 3	7E 30 30 33 36 20 33 0D		Cold	
~XX37 1	7E 30 30 33 37 20 31 0D	Color Space	Auto	
~XX37 2	7E 30 30 33 37 20 32 0D		RGB\ RGB(0-255)	
~XX37 3	7E 30 30 33 37 20 33 0D		YUV	
~XX37 4	7E 30 30 33 37 20 34 0D		RGB(16 - 235)	
~XX24 n	7E 30 30 32 34 20 a 0D	RGB Gain/Bias	Red Gain n = -50 (a=2D 35 30) ~ 50 (a=35 30)	
~XX25 n	7E 30 30 32 35 20 a 0D		Green Gain n = -50 (a=2D 35 30) ~ 50 (a=35 30)	
~XX26 n	7E 30 30 32 36 20 a 0D		Blue Gain n = -50 (a=2D 35 30) ~ 50 (a=35 30)	
~XX27 n	7E 30 30 32 37 20 a 0D		Red Bias n = -50 (a=2D 35 30) ~ 50 (a=35 30)	
~XX28 n	7E 30 30 32 38 20 a 0D		Green Bias n = -50 (a=2D 35 30) ~ 50 (a=35 30)	
~XX29 n	7E 30 30 32 39 20 a 0D		Blue Bias n = -50 (a=2D 35 30) ~ 50 (a=35 30)	
~XX517 1	7E 30 30 35 31 37 20 31 0D		RGB Gain/Bias Reset	Reset
~XX509	7E 30 30 35 30 39 20 0D		Image Settings Reset	Rese
~XX327 n	7E 30 30 33 32 37 20 a 0D		Color Matching	Red Hue n = -50 (a=2D 35 30) ~ 50 (a=35 30)
~XX333 n	7E 30 30 33 33 33 20 a 0D	Red Saturation n = -50 (a=2D 35 30) ~ 50 (a=35 30)		
~XX339 n	7E 30 30 33 33 39 20 a 0D	Red Gain n = -50 (a=2D 35 30) ~ 50 (a=35 30)		
~XX328 n	7E 30 30 33 32 38 20 a 0D	Green Hue n = -50 (a=2D 35 30) ~ 50 (a=35 30)		
~XX334 n	7E 30 30 33 33 34 20 a 0D	Green Saturation n = -50 (a=2D 35 30) ~ 50 (a=35 30)		
~XX340 n	7E 30 30 33 34 30 20 a 0D	Green Gain n = -50 (a=2D 35 30) ~ 50 (a=35 30)		
~XX329 n	7E 30 30 33 32 39 20 a 0D	Blue Hue n = -50 (a=2D 35 30) ~ 50 (a=35 30)		
~XX335 n	7E 30 30 33 33 35 20 a 0D	Blue Saturation n = -50 (a=2D 35 30) ~ 50 (a=35 30)		
~XX341 n	7E 30 30 33 34 31 20 a 0D	Blue Gain n = -50 (a=2D 35 30) ~ 50 (a=35 30)		
~XX330 n	7E 30 30 33 33 30 20 a 0D	Cyan Hue n = -50 (a=2D 35 30) ~ 50 (a=35 30)		
~XX336 n	7E 30 30 33 33 36 20 a 0D	Cyan Saturation n = -50 (a=2D 35 30) ~ 50 (a=35 30)		
~XX342 n	7E 30 30 33 34 32 20 a 0D	Cyan Gain n = -50 (a=2D 35 30) ~ 50 (a=35 30)		
~XX331 n	7E 30 30 33 33 31 20 a 0D	Yellow Hue n = -50 (a=2D 35 30) ~ 50 (a=35 30)		
~XX337 n	7E 30 30 33 33 37 20 a 0D	Yellow Saturation n = -50 (a=2D 35 30) ~ 50 (a=35 30)		
~XX343 n	7E 30 30 33 34 33 20 a 0D	Yellow Gain n = -50 (a=2D 35 30) ~ 50 (a=35 30)		
~XX332 n	7E 30 30 33 33 32 20 a 0D	Magenta Hue n = -50 (a=2D 35 30) ~ 50 (a=35 30)		
~XX338 n	7E 30 30 33 33 38 20 a 0D	Magenta Saturation n = -50 (a=2D 35 30) ~ 50 (a=35 30)		
~XX344 n	7E 30 30 33 34 34 20 a 0D	Magenta Gain n = -50 (a=2D 35 30) ~ 50 (a=35 30)		
~XX345 n	7E 30 30 33 34 35 20 a 0D	White	Red n = -50 (a=2D 35 30) ~ 50 (a=35 30)	
~XX346 n	7E 30 30 33 34 36 20 a 0D		Green n = -50 (a=2D 35 30) ~ 50 (a=35 30)	
~XX347 n	7E 30 30 33 34 37 20 a 0D		Blue n = -50 (a=2D 35 30) ~ 50 (a=35 30)	
~XX215 1	7E 30 30 32 31 35 20 31 0D		Reset	
~XX73 n	7E 30 30 37 33 20 a 0D	Signal (RGB)	Frequency n = -5 (a=2D 35) ~ 5 (a=35) By signal	
~XX91 1	7E 30 30 39 31 20 31 0D		Automatic On	
~XX91 0	7E 30 30 39 31 20 30 0D		Off	
~XX74 n	7E 30 30 37 34 20 a 0D	Signal(Video)	Phase n = 0 (a=30) ~ 31 (a=33 31) By signal	
~XX75 n	7E 30 30 37 35 20 a 0D		H. Position n = -5 (a=2D 35) ~ 5 (a=35) By timing	
~XX76 n	7E 30 30 37 36 20 a 0D		V. Position n = -5 (a=2D 35) ~ 5 (a=35) By timing	
~XX200 n	7E 30 30 32 30 30 20 a 0D	White Level	n = 0 (a=30) ~ 31 (a=33 31)	
~XX201 n	7E 30 30 32 30 31 20 a 0D	Black Level	n = -5 (a=2D 35) ~ 5 (a=35)	
~XX204 1	7E 30 30 32 30 30 24 20 31 0D		0 IRE	
~XX204 0	7E 30 30 32 30 30 24 20 30 0D		7.5 IRE	
~XX60 1	7E 30 30 36 30 20 31 0D	Format	4:3	
~XX60 2	7E 30 30 36 30 20 32 0D		16:9	

ADDITIONAL INFORMATION

232 ASCII Code	HEX Code	Function	Description
~XX60 3	7E 30 30 36 30 20 33 0D		16:10(WXGA only)
~XX60 5	7E 30 30 36 30 20 35 0D		LBX (WXGA and 1080p only)
~XX60 6	7E 30 30 36 30 20 36 0D		Native
~XX60 7	7E 30 30 36 30 20 37 0D		Auto
~XX61 n	7E 30 30 36 31 20 a 0D	Edge mask	n = 0 (a=30) ~ 10 (a=31 30)
~XX62 n	7E 30 30 36 32 20 a 0D	Zoom	n = -5 (a=2D 35) ~ 25 (a=32 35)
~XX63 n	7E 30 30 36 33 20 a 0D	H Image Shift	n = -100 (a=2D 31 30 30) ~ 100 (a=31 30 30)
~XX64 n	7E 30 30 36 34 20 a 0D	V Image Shift	n = -100 (a=2D 31 30 30) ~ 100 (a=31 30 30)
~XX65 n	7E 30 30 36 35 20 a 0D	H Keystone	n = -30 (a=2D 33 30) ~ 30 (a=33 30)
~XX66 n	7E 30 30 36 36 20 a 0D	V Keystone	n = -30 (a=2D 33 30) ~ 30 (a=33 30)
~XX69 1	7E 30 30 36 39 20 31 0D	Auto V.Keystone	On
~XX69 0	7E 30 30 36 39 20 30 0D	Auto V. Keystone	Off
~XX59 1	7E 30 30 35 39 20 31 0D	Four corner (Top-Left)	Right+
~XX59 2	7E 30 30 35 39 20 32 0D		Left+
~XX59 3	7E 30 30 35 39 20 33 0D		Up+
~XX59 4	7E 30 30 35 39 20 34 0D		Down+
~XX59 5	7E 30 30 35 39 20 35 0D	(Top-Right)	Right+
~XX59 6	7E 30 30 35 39 20 36 0D		Left+
~XX59 7	7E 30 30 35 39 20 37 0D		Up+
~XX59 8	7E 30 30 35 39 20 38 0D		Down+
~XX59 9	7E 30 30 35 39 20 39 0D	(Bottom-Left)	Right+
~XX59 10	7E 30 30 35 39 20 31 30 0D		Left+
~XX59 11	7E 30 30 35 39 20 31 31 0D		Up+
~XX59 12	7E 30 30 35 39 20 31 32 0D		Down+
~XX59 13	7E 30 30 35 39 20 31 33 0D	(Bottom-Right)	Right+
~XX59 14	7E 30 30 35 39 20 31 34 0D		Left+
~XX59 15	7E 30 30 35 39 20 31 35 0D		Up+
~XX59 16	7E 30 30 35 39 20 31 36 0D		Down+
~XX516	7E 30 30 35 31 36 20 0D	Four corners reset	Reset
~XX506 0	7E 30 30 35 30 36 20 30 0D	Wall Color	Off
~XX506 2	7E 30 30 35 30 36 20 32 0D	Wall Color	Light Yellow
~XX506 3	7E 30 30 35 30 36 20 33 0D	Wall Color	Light Green
~XX506 4	7E 30 30 35 30 36 20 34 0D	Wall Color	Light Blue
~XX506 5	7E 30 30 35 30 36 20 35 0D	Wall Color	Pink
~XX506 6	7E 30 30 35 30 36 20 36 0D	Wall Color	Gray
~XX230 1	7E 30 30 32 33 30 20 31 0D	3D Mode	DLP-Link
~XX230 3	7E 30 30 32 33 30 20 31 0D		VESA 3D
~XX230 0	7E 30 30 32 33 30 20 30 0D		Off (0/2 for backward compatible)
~XX400 0	7E 30 30 34 30 30 20 30 0D	3D->2D	3D
~XX400 1	7E 30 30 34 30 30 20 31 0D		L
~XX400 2	7E 30 30 34 30 30 20 32 0D		R
~XX405 0	7E 30 30 34 30 35 20 30 0D	3D Format	Auto
~XX405 1	7E 30 30 34 30 35 20 31 0D		SBS
~XX405 2	7E 30 30 34 30 35 20 32 0D		Top and Bottom
~XX405 3	7E 30 30 34 30 35 20 33 0D		Frame sequential
~XX231 0	7E 30 30 32 33 31 20 30 0D	3D Sync Invert	On
~XX231 1	7E 30 30 32 33 31 20 31 0D	3D Sync Invert	Off
~XX70 1	7E 30 30 37 30 20 31 0D	Language	English
~XX70 2	7E 30 30 37 30 20 32 0D		German
~XX70 3	7E 30 30 37 30 20 33 0D		French
~XX70 4	7E 30 30 37 30 20 34 0D		Italian
~XX70 5	7E 30 30 37 30 20 35 0D		Spanish
~XX70 6	7E 30 30 37 30 20 36 0D		Portuguese
~XX70 7	7E 30 30 37 30 20 37 0D		Polish
~XX70 8	7E 30 30 37 30 20 38 0D		Dutch
~XX70 9	7E 30 30 37 30 20 39 0D		Swedish

ADDITIONAL INFORMATION

232 ASCII Code	HEX Code	Function	Description
~XX70 10	7E 30 30 37 30 20 31 30 0D		Norwegian/Danish
~XX70 11	7E 30 30 37 30 20 31 31 0D		Finnish
~XX70 12	7E 30 30 37 30 20 31 32 0D		Greek
~XX70 13	7E 30 30 37 30 20 31 33 0D		Traditional Chinese
~XX70 14	7E 30 30 37 30 20 31 34 0D		Simplified Chinese
~XX70 15	7E 30 30 37 30 20 31 35 0D		Japanese
~XX70 16	7E 30 30 37 30 20 31 36 0D		Korean
~XX70 17	7E 30 30 37 30 20 31 37 0D		Russian
~XX70 18	7E 30 30 37 30 20 31 38 0D		Hungarian
~XX70 19	7E 30 30 37 30 20 31 39 0D		Czechoslovak
~XX70 20	7E 30 30 37 30 20 32 30 0D		Arabic
~XX70 21	7E 30 30 37 30 20 32 31 0D		Thai
~XX70 22	7E 30 30 37 30 20 32 32 0D		Turkish
~XX70 23	7E 30 30 37 30 20 32 33 0D		Farsi
~XX70 25	7E 30 30 37 30 20 32 33 0D		Vietnamese
~XX70 26	7E 30 30 37 30 20 32 33 0D		Indonesian
~XX70 27	7E 30 30 37 30 20 32 33 0D		Romanian
~XX71 1	7E 30 30 37 31 20 31 0D	Projection	Front-Desktop
~XX71 2	7E 30 30 37 31 20 32 0D		Rear-Desktop
~XX71 3	7E 30 30 37 31 20 33 0D		Front-Ceiling
~XX71 4	7E 30 30 37 31 20 34 0D		Rear-Ceiling
~XX90 1	7E 30 30 39 30 20 31 0D	Screen Type (WXGA/WUXGA)	16:10
~XX90 0	7E 30 30 39 30 20 30 0D		16:9
~XX72 1	7E 30 30 37 32 20 31 0D	Menu Location	Top Left
~XX72 2	7E 30 30 37 32 20 32 0D		Top Right
~XX72 3	7E 30 30 37 32 20 33 0D		Centre
~XX72 4	7E 30 30 37 32 20 34 0D		Bottom Left
~XX72 5	7E 30 30 37 32 20 35 0D		Bottom Right
~XX77 n	7E 30 30 37 37 20 aabbcc 0D	Security	Security Timer Month/Day/Hour n = mm/dd/hh mm= 00 (aa=30 30) ~ 12 (aa=31 32) dd = 00 (bb=30 30) ~ 30 (bb=33 30) hh= 00 (cc=30 30) ~ 24 (cc=32 34)
~XX78 1	7E 30 30 37 38 20 31 0D	Security	On
~XX78 0 ~nnnn	7E 30 30 37 38 20 30 20 a 0D		Off (0/2 for backward compatible) ~nnnn = ~0000 (a=7E 30 30 30 30) ~9999 (a=7E 39 39 39 39)
~XX79 n	7E 30 30 37 39 20 a 0D	Projector ID	n = 00 (a=30 30) ~ 99 (a=39 39)
~XX310 0	7E 30 30 33 31 30 20 30 0D	Internal Speaker	Off
~XX310 1	7E 30 30 33 31 30 20 31 0D		On
~XX80 1	7E 30 30 38 30 20 31 0D	Mute	On
~XX80 0	7E 30 30 38 30 20 30 0D		Off (0/2 for backward compatible)
~XX81 n	7E 30 30 38 31 20 a 0D	Volume(Audio)	n = 0 (a=30) ~ 10 (a=31 30)
~XX93 n	7E 30 30 39 33 20 a 0D	Volume(Mic)	n = 0 (a=30) ~ 10 (a=31 30)
~XX89 0	7E 30 30 38 39 20 30 0D	Audio Input	Default
~XX89 1	7E 30 30 38 39 20 31 0D		Audio1
~XX89 3	7E 30 30 38 39 20 33 0D		Audio2
~XX82 1	7E 30 30 38 32 20 31 0D	Logo	Default
~XX82 2	7E 30 30 38 32 20 32 0D		User
~XX82 3	7E 30 30 38 32 20 33 0D		Neutral
~XX83 1	7E 30 30 38 33 20 31 0D	Logo Capture	
~XX88 0	7E 30 30 38 38 20 30 0D	Closed Captioning	Off
~XX88 1	7E 30 30 38 38 20 31 0D		cc1
~XX88 2	7E 30 30 38 38 20 32 0D		cc2
~XX454 0	7E 30 30 34 35 34 20 30 0D	Crestron	Off
~XX454 1	7E 30 30 34 35 34 20 31 0D		On
~XX455 0	7E 30 30 34 35 35 20 30 0D	Extron	Off
~XX455 1	7E 30 30 34 35 35 20 31 0D		On
~XX456 0	7E 30 30 34 35 36 20 30 0D	PJLink	Off
~XX456 1	7E 30 30 34 35 36 20 31 0D		On
~XX457 0	7E 30 30 34 35 37 20 30 0D	AMX Device Discovery	Off

ADDITIONAL INFORMATION

232 ASCII Code	HEX Code	Function	Description
~XX457 1	7E 30 30 34 35 37 20 31 0D		On
~XX458 0	7E 30 30 34 35 38 20 30 0D	Telnet	Off
~XX458 1	7E 30 30 34 35 38 20 31 0D		On
~XX459 0	7E 30 30 34 35 38 20 30 0D	HTTP	Off
~XX459 1	7E 30 30 34 35 38 20 31 0D		On
~XX39 1	7E 30 30 33 39 20 31 0D	Input Source	HDMI1
~XX39 7	7E 30 30 33 39 20 37 0D		HDMI2
~XX39 16	7E 30 30 33 39 20 31 36 0D		HDMI3
~XX39 5	7E 30 30 33 39 20 35 0D		VGA1
~XX39 6	7E 30 30 33 39 20 36 0D		VGA2 (XGA only)
~XX39 9	7E 30 30 33 39 20 39 0D		S-Video (XGA only)
~XX39 10	7E 30 30 33 39 20 31 30 0D		Video
~XX100 1	7E 30 30 31 30 30 20 31 0D	Source Lock	On
~XX100 0	7E 30 30 31 30 30 20 30 0D		Off (0/2 for backward compatible)
~XX101 1	7E 30 30 31 30 31 20 31 0D	High Altitude	On
~XX101 0	7E 30 30 31 30 31 20 30 0D		Off (0/2 for backward compatible)
~XX102 1	7E 30 30 31 30 32 20 31 0D	Information Hide	On
~XX102 0	7E 30 30 31 30 32 20 30 0D		Off (0/2 for backward compatible)
~XX103 1	7E 30 30 31 30 33 20 31 0D	Keypad Lock	On
~XX103 0	7E 30 30 31 30 33 20 30 0D		Off (0/2 for backward compatible)
~XX195 0	7E 30 30 31 39 35 20 30 0D	Test Pattern	None
~XX195 1	7E 30 30 31 39 35 20 31 0D		Grid
~XX195 2	7E 30 30 31 39 35 20 32 0D		White Pattern
~XX104 1	7E 30 30 31 30 34 20 31 0D	Background Color	Blue
~XX104 2	7E 30 30 31 30 34 20 32 0D		Black
~XX104 3	7E 30 30 31 30 34 20 33 0D		Red
~XX104 4	7E 30 30 31 30 34 20 34 0D		Green
~XX104 5	7E 30 30 31 30 34 20 35 0D		White
~XX11 0	7E 30 30 31 31 20 30 0D	IR Function	Off
~XX11 1	7E 30 30 31 31 20 31 0D		On
~XX11 2	7E 30 30 31 31 20 32 0D		Front
~XX11 3	7E 30 30 31 31 20 33 0D		Top
~XX192 0	7E 30 30 31 39 32 20 30 0D	12V Trigger	Off (XGA only)
~XX192 1	7E 30 30 31 39 32 20 31 0D		On (XGA only)
~XX503 0	7E 30 30 35 30 33 20 30 0D	Beep	Off
~XX503 1	7E 30 30 35 30 33 20 31 0D	Beep	On
~XX105 1	7E 30 30 31 30 35 20 31 0D	Advanced	Direct Power On On
~XX105 0	7E 30 30 31 30 35 20 30 0D		Off (0/2 for backward compatible)
~XX113 0	7E 30 30 31 31 33 20 30 0D		Signal Power On Off
~XX113 1	7E 30 30 31 31 33 20 31 0D		On
~XX106 n	7E 30 30 31 30 36 20 a 0D		Auto Power Off n = 0 (a=30) ~ 180 (a=31 38 30) (min) (5 minutes for each step).
~XX107 n	7E 30 30 31 30 37 20 a 0D		Sleep Timer n = 0 (a=30) ~ 990 (a=39 39 30) (min) (10 minutes for each step).
~XX507 1	7E 30 30 35 30 37 20 31 0D	Sleep Timer	On
~XX507 0	7E 30 30 35 30 37 20 30 0D	Repeat	Off
~XX115 1	7E 30 30 31 31 35 20 31 0D	Quick Resume	On
~XX115 0	7E 30 30 31 31 35 20 30 0D		Off (0/2 for backward compatible)
~XX114 1	7E 30 30 31 31 34 20 31 0D	Power Mode(Standby)	Eco.(≤0.5W)
~XX114 0	7E 30 30 31 31 34 20 30 0D		Active (0/2 for backward compatible)
~XX109 1	7E 30 30 31 30 39 20 31 0D	Lamp Reminder	On
~XX109 0	7E 30 30 31 30 39 20 30 0D		Off (0/2 for backward compatible)
~XX110 1	7E 30 30 31 31 30 20 31 0D	Lamp Mode	Bright
~XX110 2	7E 30 30 31 31 30 20 32 0D		Eco
~XX110 3	7E 30 30 31 31 30 20 33 0D		Eco+
~XX110 4	7E 30 30 31 31 30 20 34 0D		Dynamic

ADDITIONAL INFORMATION

232 ASCII Code	HEX Code	Function	Description
~XX111 1	7E 30 30 31 31 31 20 31 0D	Lamp Reset	Yes
~XX320 1	7E 30 30 33 32 30 20 31 0D	Optional Filter Installed	Yes
~XX320 0	7E 30 30 33 32 30 20 30 0D		No (0/2 for backward compatible)
~XX322 0	7E 30 30 33 32 32 20 30 0D	Filter Reminder	Off
~XX322 1	7E 30 30 33 32 32 20 31 0D		300 hrs
~XX322 2	7E 30 30 33 32 32 20 32 0D		500 hrs
~XX322 3	7E 30 30 33 32 32 20 33 0D		800 hrs
~XX322 4	7E 30 30 33 32 32 20 34 0D		1000 hrs
~XX323 1	7E 30 30 33 32 33 20 31 0D	Filter Reset	Yes
~XX323 0	7E 30 30 33 32 33 20 30 0D		No (0/2 for backward compatible)
~XX313 1	7E 30 30 33 31 33 20 31 0D	Information menu	On
~XX313 0	7E 30 30 33 31 33 20 30 0D		Off(0/2 for backward compatible)
~XX112 1	7E 30 30 31 31 32 20 31 0D	Reset	Yes
~XX210 n	7E 30 30 32 30 30 20 n 0D	Display message on the OSD	n: 1-30 characters
SEND to emulate Remote			
~XX140 10	7E 30 30 31 34 30 20 31 30 0D		Up
~XX140 11	7E 30 30 31 34 30 20 31 31 0D		Left
~XX140 12	7E 30 30 31 34 30 20 31 32 0D		Enter (for projection MENU)
~XX140 13	7E 30 30 31 34 30 20 31 33 0D		Right
~XX140 14	7E 30 30 31 34 30 20 31 34 0D		Down
~XX140 15	7E 30 30 31 34 30 20 31 35 0D		V Keystone +
~XX140 16	7E 30 30 31 34 30 20 31 36 0D		V Keystone -
~XX140 17	7E 30 30 31 34 30 20 31 37 0D		Volume -
~XX140 18	7E 30 30 31 34 30 20 31 38 0D		Volume +
~XX140 20	7E 30 30 31 34 30 20 32 30 0D		Menu
~XX140 47	7E 30 30 31 34 30 20 34 37 0D		Source
SEND from projector automatically			
232 ASCII Code	HEX Code	Function	Projector Return Description
when Standby/Warming/Cooling/Out of Range/Lamp fail/Fan Lock/Over Temperature/Lamp Hours Running Out/Cover Open			INFO n : 0/1/2/3/4/6/7/8/9 = Standby/Warming/Cooling/Out of Range/Lamp fail/Fan Lock/Over Temperature/Lamp Hours Running Out/Cover Open
READ from projector			
232 ASCII Code	HEX Code	Function	Projector Return Description
~XX121 1	7E 30 30 31 32 31 20 31 0D	Input Source Commands	Okn n = 0 None n = 7 HDMI1 n = 8 HDMI2 n = 9 HDMI3 n = 2 VGA1 n = 3 VGA2 (XGA only) n = 5 Video n = 4 S-Video (XGA only)

ADDITIONAL INFORMATION

232 ASCII Code	HEX Code	Function	Projector Return	Description
~XX122 1	7E 30 30 31 32 32 20 31 0D	Software Version	OKdddd	dddd: FW version
~XX357 1	7E 30 30 33 35 34 20 31 0D	LAN FW version	Okeeeee	eeee: LAN FW version
~XX123 1	7E 30 30 31 32 33 20 31 0D	Display Mode	Okn	n = 0 None n = 1 Presentation n = 2 Bright n = 3 Movie n = 4 sRGB n = 5 User n = 7 Blackboard n = 12 DICOM SIM. n = 9 3D
~XX124 1	7E 30 30 31 32 34 20 31 0D	Power State	OKn	n : 0/1 = Off/On
~XX125 1	7E 30 30 31 32 35 20 31 0D	Brightness	OKn	
~XX126 1	7E 30 30 31 32 36 20 31 0D	Contrast	OKn	
~XX127 1	7E 30 30 31 32 37 20 31 0D	Format	OKn	n = 1 4:3 n = 2 16:9 n = 3 16:10 n = 5 LBX n = 6 Native n = 7 Auto
*16:9 or 16:10 depend on Screen Type setting				
~XX128 1	7E 30 30 31 32 38 20 31 0D	Color Temperature	Okn	n = 3 Warm n = 0 Standard n = 1 Cool n = 2 Cold
~XX129 1	7E 30 30 31 32 39 20 31 0D	Projection Mode	OKn	n = 0 Front-Desktop n = 1 Rear-Desktop n = 2 Front-Ceiling n = 3 Rear-Ceiling
~XX150 1	7E 30 30 31 35 30 20 31 1D	Information	Okabbbbccddde	a = 0 Off a = 1 On bbbb: Lamp Hour cc = Source cc = 00 None cc = 02 VGA1 cc = 03 VGA2 (XGA only) cc = 04 S-Video (XGA only) cc = 05 Video cc = 07 HDMI1 cc = 08 HDMI2 cc = 14 HDMI3 dddd: Firmware Version e = Display mode ee=0 None ee=1 Presentation ee=2 Bright ee=3 Movie ee=4 sRGB ee=5 User ee=7 Blackboard ee=9 3D ee=12 DICOM SIM.

ADDITIONAL INFORMATION

232 ASCII Code	HEX Code	Function	Projector Return	Description
~XX151 1	7E 30 30 31 35 31 20 31 0D	Model name	OKn	n = 2 XGA n = 3 WXGA n = 4 1080p
~XX108 1	7E 30 30 31 30 38 20 31 0D	Lamp Hours	OKbbbb	bbbb: LampHour
~XX108 2	7E 30 30 31 30 38 20 31 0D	Cumulative Lamp Hours	OKbbbbbb	bbbbbb: (5 digits) Total Lamp Hours
~XX321 1	7E 30 30 33 32 31 20 31 0D	Filter Usage Hours	OKbbbb	bbbb: Filter Usage Hours
~XX87 1	7E 30 30 38 37 20 31 0D	Network Status	OKn	n=0/1 Disconnected/Connected
~XX87 3	7E 30 30 38 37 20 33 0D	IP Address	Okaaa_bbb_ccc_ddd	
~XX351 0	7E 30 30 33 35 31 20 30 0D	Fan1 Speed(blower)	Okaaaa	a=0000~9999
~XX351 1	7E 30 30 33 35 31 20 31 0D	Fan2 Speed (blower)	Okaaaa	a=0000~9999
~XX351 2	7E 30 30 33 35 31 20 32 0D	Fan3 Speed	Okaaaa	a=0000~9999
~XX351 3	7E 30 30 33 35 31 20 33 0D	Fan4 Speed	Okaaaa	a=0000~9999
~XX352 1	7E 30 30 33 35 32 20 31 0D	System temperature	Okaaa	a=000~999
~XX353 1	7E 30 30 33 35 33 20 31 0D	Serial number	Okaaaaaaaa aaaaaaaa	a=serial number string
~XX354 1	7E 30 30 33 35 34 20 31 0D	Closed Captioning	Oka	a: 0/1/2 = off/cc1/cc2
~XX355 1	7E 30 30 33 35 35 20 31 0D	AV Mute	Oka	a : 0/1 = Off/On
~XX356 1	7E 30 30 33 35 36 20 31 0D	Mute	Oka	a : 0/1 = Off/On
~XX358 1	7E 30 30 33 35 38 20 31 0D	Current Lamp Watt	Okaaaa	aaaa=0000~9999



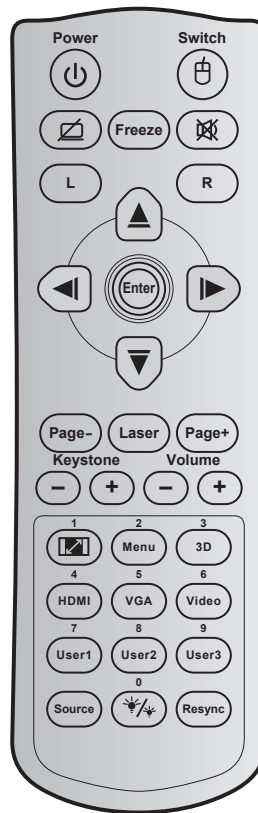

ADDITIONAL INFORMATION

IR remote codes



Key	Key code	Printing-key definition	Description
Power	81	Power on / off	Press to turn on / off the projector.
Switch	3E	Switch	Press to switch the USB mouse on / off.
Display blank / audio mute	8A		Press to hide / unhide the screen picture and turn off / on audio.
Freeze	8B	Freeze	Press to freeze the projector image.
Mute	92		Press to momentarily turn off / on the audio.
Mouse left click	CB	L	Use as mouse left click.
Mouse right click	CC	R	Use as mouse right click.
Four directional select keys	C6	Up arrow	Use ▲ ▼ ◀ ▶ to select items or make adjustments to your selection.
	C8	Left arrow	
	C9	Right arrow	
	C7	Down arrow	
Enter	C5	Enter	Confirm your item selection.
	CA	Enter	
Page -	C2	Page-	Press to page down.
Laser	N/A	Laser	Use as laser pointer.
Page +	C1	Page+	Press to page up.
Keystone	85	Keystone+	Press to adjust image distortion caused by tilting the projector.
	84	Keystone-	

ADDITIONAL INFORMATION

Key		Key code	Printing-key definition	Description
Volume		8C	Volume +	Press to adjust to increase / decrease the volume.
		8F	Volume -	
Aspect ratio / 1		98	 / 1	<ul style="list-style-type: none"> Press to change aspect ratio of a displayed image. Use as numeric keypad number "1".
Menu / 2		88	Menu / 2	<ul style="list-style-type: none"> Press to display or exit the on-screen display menus for projector. Use as numeric keypad number "2".
3D / 3		93	3D/3	<ul style="list-style-type: none"> Press to manually select a 3D mode that matches your 3D content. Use as numeric keypad number "3".
HDMI / 4		86	HDMI/4	<ul style="list-style-type: none"> Press to choose HDMI source. Use as numeric keypad number "4".
VGA / 5		D0	VGA/5	<ul style="list-style-type: none"> Press to choose VGA source. Use as numeric keypad number "5".
Video / 6		D1	Video/6	<ul style="list-style-type: none"> Press to choose composite video source. Use as numeric keypad number "6".
User1 / 7; User2 / 8; User3 / 9		D2	User 1/7	<ul style="list-style-type: none"> User defined keys. Please see page 60 to setup. Use as numeric keypad numbers "7", "8", and "9" accordingly.
		D3	User 2/8	
		D4	User 3/9	
Source		C3	Source	Press to select an input signal.
Brightness mode / 0		96	 / 0	<ul style="list-style-type: none"> Press to automatically adjust the picture brightness to give an optimum contrast performance. Use as numeric keypad number "0".
Re-sync		C4	Re-Sync	Press to automatically synchronize the projector to the input source.

Note:

- If the projector supports Dynamic Eco / Image Care features and AV Mute is pressed, the power consumption of the lamp becomes 30%.

Remote mouse feature simulation specification

- The remote mouse feature is supported only when a computer source is selected, for example VGA or HDMI.
- If you press the "Switch" key on the remote control, you will see the cursor being displayed on the right top corner of the screen for 15 seconds.
- In remote mouse mode the cursor should move smoothly and continuously on the screen.

ADDITIONAL INFORMATION

Using the Information button

The Information function ensures easy setup and operation. Press the “i” button on the keypad to open the Information menu.

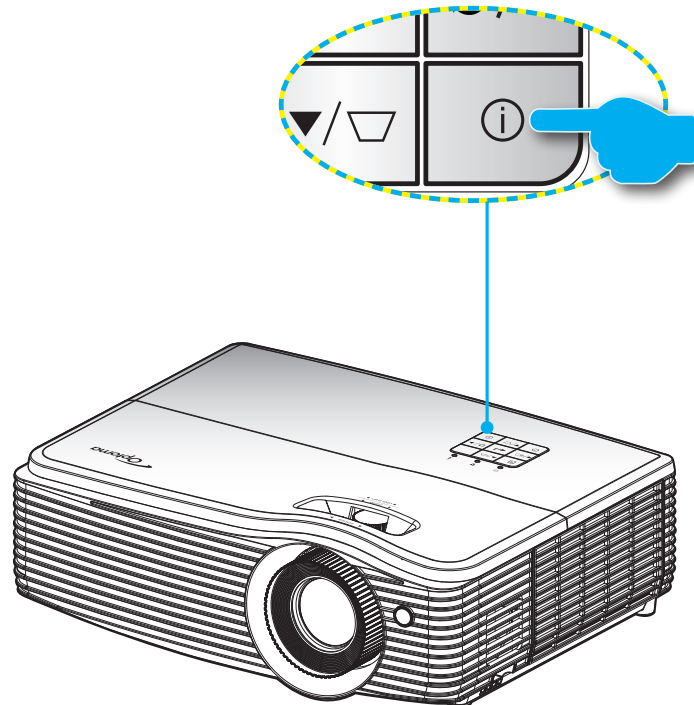

- **Information** button functions only when no input source is detected.







Information	
S/N Number	XXXXXXXXXXXX
F/W Version	DDP C01
	MCU M01
	LAN L01
Current Input Source	VGA 1
Resolution	1920x1080
Refresh Rate	59.97 Hz
Lamp Hours	
Bright	0000 H
Eco	0000 H
Dynamic	0000 H
Eco+	0000 H
Filter Hour	0000 H
Projector ID	00
IP Address	192.168.0.100
Network Status	Connected
	↩ Exit

ADDITIONAL INFORMATION

Troubleshooting

If you experience a problem with your projector, please refer to the following information. If a problem persists, please contact your local reseller or service center.

Image problems

-  *No image appears on-screen*
- Ensure all the cables and power connections are correctly and securely connected as described in the "Installation" section.
 - Ensure the pins of connectors are not crooked or broken.
 - Check if the projection lamp has been securely installed. Please refer to the "Replacing the Lamp" section.
 - Make sure the projector is switched on.
 - Ensure that the "AV Mute" feature is not turned on.
-  *Image is out of focus*
- Make sure the Lens cap is removed.
 - Adjust the Focus Ring on the projector lens.
 - Make sure the projection screen is between the required distance from the projector. (Please refer to pages 69-72).
-  *The image is stretched when displaying 16:9 DVD title*
- When you play anamorphic DVD or 16:9 DVD, the projector will show the best image in 16: 9 format on projector side.
 - If you play the LBX format DVD title, please change the format as LBX in projector OSD.
 - If you play 4:3 format DVD title, please change the format as 4:3 in projector OSD.
 - Please setup the display format as 16:9 (wide) aspect ratio type on your DVD player.
-  *Image is too small or too large*
- Adjust the zoom lever on the top of the projector.
 - Move the projector closer to or further from the screen.
 - Press "Menu" on the projector panel, go to "Display-->Format". Try the different settings.
-  *Image has slanted sides:*
- If possible, reposition the projector so that it is centered on the screen and below the bottom of the screen.
 - Use "Display-->V Keystone" from the OSD to make an adjustment.
-  *Image is reversed*
- Select "Setup-->Projection" from the OSD and adjust the projection direction.

ADDITIONAL INFORMATION

- ❓ *Blurry double image*
 - Press "3D" button and switch to "Off" to avoid normal 2D image is blurry double image.
- ❓ *Two images, side-by-side format*
 - Press "3D" button and switch to "SBS" for input signal is HDMI 1.3 2D 1080i side-by-side.
- ❓ *Image does not display in 3D*
 - Check if the battery of 3D glasses is drained.
 - Check if the 3D glasses is turned on.
 - When the input signal is HDMI 1.3 2D (1080i side-by-side half), press "3D" button and switch to "SBS".

Other problems

- ❓ *The projector stops responding to all controls*
 - If possible, turn off the projector, then unplug the power cord and wait at least 20 seconds before reconnecting power.
- ❓ *Lamp burns out or makes a popping sound*
 - When the lamp reaches its end of life, it will burn out and may make a loud popping sound. If this happens, the projector will not turn on until the lamp module has been replaced. To replace the lamp, follow the procedures in the "Replacing the Lamp" section on pages 65-66.

Remote control problems

- ❓ *If the remote control does not work*
 - Check the operating angle of the remote control is pointed within $\pm 15^\circ$ both horizontally and vertically to the IR receivers on the projector.
 - Make sure there are not any obstructions between the remote control and the projector. Move to within 5 m (16 ft) of the projector.
 - Make sure batteries are inserted correctly.
 - Replace batteries if they are exhausted.

ADDITIONAL INFORMATION

















Warning indicators

When the warning indicators (see below) light up or flash, the projector will automatically shutdown:

- "LAMP" LED indicator is lit red and if "On / Standby" indicator flashes red.
- "TEMP" LED indicator is lit red and if "On / Standby" indicator flashes red. This indicates the projector has overheated. Under normal conditions, the project can be switched back on.
- "TEMP" LED indicator flashes red and if "On / Standby" indicator flashes red.

Unplug the power cord from the projector, wait for 30 seconds and try again. If the warning indicator lights up again, please contact your nearest service center for assistance.

LED lightning messages

Message	 Power LED	 Power LED	 Temp-LED	 Lamp-LED
	(Red)	(Blue)	(Red)	(Red)
Standby state (Input power cord)	Steady light			
Power on (Warming)		Flashing (0.5 sec off / 0.5 sec on)		
Power on and Lamp lighting		Steady light		
Power off (Cooling)		Flashing (0.5 sec off / 0.5 sec light). Back to red steady light when cooling fan turns off.		
Quick Resume (100 secs)		Flashing (0.25 sec off / 0.25 sec light)		
Error (Over temp.)	Flashing			
Error (Fan failure)	Flashing		Flashing	
Error (Lamp failure)	Flashing			

- Power off:

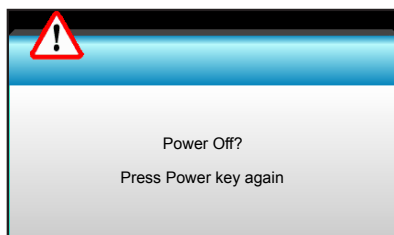

- Lamp warning:

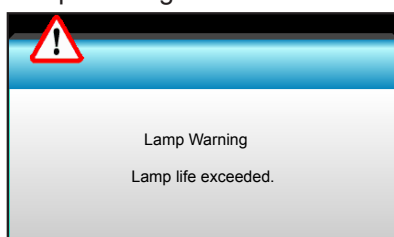

ADDITIONAL INFORMATION

- Temperature warning:

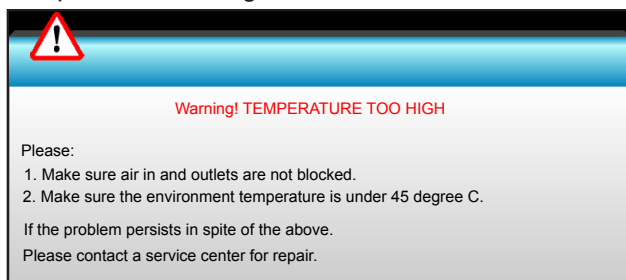

- Fan failed:

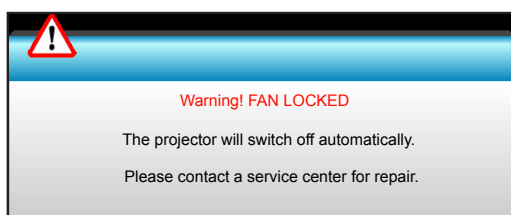

- Power down timer active:

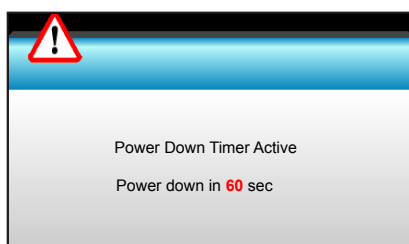

- Security timer alarm:

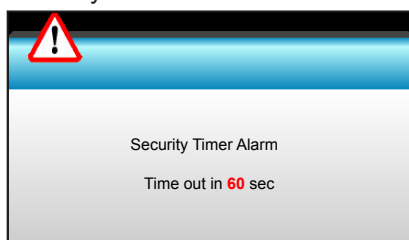

ADDITIONAL INFORMATION

Specifications

Optical	Description
Native resolution	XGA / WXGA / 1080p
Maximum resolution	1080p / 75Hz (max bandwidth: 225MHz) for HDMI
Lens	2.5(wide)~3.26(tele)@ 60"
Image size (diagonal)	- XGA: 21.76"~300.6" - WXGA: 25.66"~301.15" - 1080P: 26.2"~301.1"
Projection distance	- XGA: 1.85~2.94 (D / W)@60" - WXGA: 1.48~2.352 (D / W)@60" - 1080p: 1.41~2.24 (D / W)@60"

Electrical	Description
Inputs	- HDMI 1.4a - HDMI 1.4a + MHL (v2.2) - VGA (YPbPr / RGB) - VGA (YPbPr / RGB / wireless) - S-Video (XGA only) - Composite video - Audio 3.5mm - Audio RCA L & R (XGA only) - Mic 3.5mm (XGA only)
Outputs	- VGA - Audio 3.5mm - USB-A power - 12V trigger (XGA only)
Control	- RS232 - RJ45 - 3D Sync VESA - USB mouse / service
Color reproduction	1073.4 Million color
Scan rate	- Horizontal Scan rate: 15.375 ~ 91.146 KHz - Vertical Scan rate: 24~ 85 Hz (120Hz for 3D feature)
Sync compatibility	Separate Sync
Built-in speaker	Yes, 16W
Power requirement	100 - 240V AC 50 / 60Hz
Input current	4.5 A
Power consumption (typical value)	
ECO mode off	- Typical 383W MAX 421W @ 110VAC - Typical 365W MAX 402W @ 220VAC
ECO mode	- Typical 299W MAX 329W @ 110VAC - Typical 287W MAX 316W @ 220VAC

ADDITIONAL INFORMATION

Mechanical	Description
Installation orientation	Front, Rear, Front-Ceiling, Rear-Ceiling
Dimensions	369 mm (W) x 294.5 mm (D) x 123.26 mm (H)
Weight	4.6 Kg
Environmental conditions	Operating: 5 ~ 40°C in Bright mode (normal mode) 10% to 85% humidity (non-condensing)
	Operating: 5 ~ 45° C in ECO mode 10% to 85% humidity (non-condensing)

Note: All specifications are subject to change without notice.



ADDITIONAL INFORMATION

Optoma global offices

For service or support, please contact your local office.



USA

3178 Laurelview Ct.
Fremont, CA 94538, USA
www.optomausa.com

 888-289-6786
 510-897-8601
 services@optoma.com



Canada

3178 Laurelview Ct.
Fremont, CA 94538, USA
www.optomausa.com

 888-289-6786
 510-897-8601
 services@optoma.com

Latin America

3178 Laurelview Ct.
Fremont, CA 94538, USA
www.optomausa.com

 888-289-6786
 510-897-8601
 services@optoma.com



Europe

42 Caxton Way, The Watford Business Park
Watford, Hertfordshire,
WD18 8QZ, UK
www.optoma.eu
Service Tel : +44 (0)1923 691865

 +44 (0) 1923 691 800
 +44 (0) 1923 691 888
 service@tsc-europe.com



Benelux BV

Randstad 22-123
1316 BW Almere
The Netherlands
www.optoma.nl

 +31 (0) 36 820 0252
 +31 (0) 36 548 9052



France

Bâtiment E
81-83 avenue Edouard Vaillant
92100 Boulogne Billancourt, France

 +33 1 41 46 12 20
 +33 1 41 46 94 35
 savoptoma@optoma.fr



Spain

C/ José Hierro,36 Of. 1C
28522 Rivas VaciaMadrid,
Spain

 +34 91 499 06 06
 +34 91 670 08 32



Deutschland

Wiesenstrasse 21 W
D40549 Düsseldorf,
Germany

 +49 (0) 211 506 6670
 +49 (0) 211 506 66799
 info@optoma.de

Scandinavia



Lerpeveien 25
3040 Drammen
Norway

 +47 32 98 89 90
 +47 32 98 89 99
 info@optoma.no

PO.BOX 9515
3038 Drammen
Norway

Korea

WOOMI TECH.CO.,LTD.
4F, Minu Bldg.33-14, Kangnam-Ku,
Seoul,135-815, KOREA
korea.optoma.com

 +82+2+34430004
 +82+2+34430005



Japan

東京都足立区綾瀬3-25-18
株式会社オーエス
コンタクトセンター:0120-380-495

 info@os-worldwide.com
www.os-worldwide.com



Taiwan

12F., No.213, Sec. 3, Beixin Rd.,
Xindian Dist., New Taipei City 231,
Taiwan, R.O.C.
www.optoma.com.tw

 +886-2-8911-8600
 +886-2-8911-6550
 services@optoma.com.tw
asia.optoma.com



Hong Kong

Unit A, 27/F Dragon Centre,
79 Wing Hong Street,
Cheung Sha Wan,
Kowloon, Hong Kong

 +852-2396-8968
 +852-2370-1222
www.optoma.com.hk

China

5F, No. 1205, Kaixuan Rd.,
Changning District
Shanghai, 200052, China

 +86-21-62947376
 +86-21-62947375
www.optoma.com.cn

