

**SONY**<sup>®</sup>

PROFESSIONAL DISC RECORDER

# PDW-HD1550



OPERATION MANUAL

English

1st Edition

---

# Table of Contents

---

## Chapter 1 Overview

<b>Features</b> .....	<b>6</b>
Features of this unit .....	6
<b>System Configurations</b> .....	<b>9</b>

---

## Chapter 2 Names and Functions of Parts

<b>Front Panel</b> .....	<b>10</b>
Display screen .....	15
<b>Rear Panel</b> .....	<b>20</b>

---

## Chapter 3 Preparations

<b>Preparing Power Sources</b> .....	<b>23</b>
Supplying power.....	23
Attaching a battery pack.....	23
<b>Initial Setup</b> .....	<b>25</b>
<b>Front Panel Tilt Mechanism</b> .....	<b>26</b>
<b>Connections and Settings</b> .....	<b>27</b>
Connections for Content Browser and non-Sony nonlinear editors ....	27
Connections for cut editing .....	28
Using the editing functions of the recorder (controlling through REMOTE (9P) connector) .....	31
Connections for pool coverage.....	32
<b>Synchronization Reference Signals</b> .....	<b>33</b>
<b>Setting the System Frequency</b> .....	<b>34</b>
<b>Setting the Timecode</b> .....	<b>34</b>
<b>Superimposed Text Information</b> .....	<b>36</b>
<b>Basic Operations of the Function Menu</b> .....	<b>39</b>
Function menu operations .....	39
Function menu settings.....	39
<b>Handling Discs</b> .....	<b>42</b>
Discs used for recording and playback.....	42
Notes on handling.....	43
Write-protecting discs .....	43

Loading and unloading a disc .....	43
Formatting a disc .....	43
<b>Handling External Storage.....</b>	<b>44</b>
Using external storage .....	44
Removing external storage .....	45

---

## Chapter 4 Recording, Playback and Copy

<b>Recording.....</b>	<b>47</b>
Preparations for recording .....	47
Carrying out recording.....	47
Recording with the HDSDI remote control function.....	48
Continuing recording while exchanging discs (disc exchange cache function) .....	49
Handling of discs when recording does not end normally (salvage functions).....	49
<b>Playback.....</b>	<b>51</b>
Playback operation.....	52
Playback operations using thumbnails.....	54
<b>Copying .....</b>	<b>55</b>
Overview.....	55
Copy operations .....	55

---

## Chapter 5 Operations on Clip List Screens

<b>Overview.....</b>	<b>58</b>
Switching between display screens .....	58
Information and controls on clip list screens .....	59
Clip Menu .....	62
Clip F Menu.....	63
<b>Clip Operations.....</b>	<b>64</b>
Selecting clips.....	64
Searching with thumbnails .....	64
Playing a clip by thumbnail search.....	65
Setting clip flags .....	66
Locking (write-protecting) clips .....	66
Deleting clips .....	66
Copying clips .....	67
Setting the index picture frame.....	67
<b>EDL Editing .....</b>	<b>68</b>
What is EDL editing? .....	68

Creating and editing EDLs .....	68
<b>Disc Operations .....</b>	<b>71</b>
Checking the disc information .....	71
Formatting (initializing) discs .....	71
Finalizing discs .....	72
Repairing discs .....	72

---

## Chapter 6 File Operations

<b>Overview .....</b>	<b>73</b>
Directory structure .....	73
FTPS protocol support .....	73
File operation restrictions .....	74
<b>FTP File Operations .....</b>	<b>77</b>
Making FTP connections .....	77
Command list .....	78
<b>CIFS File Operations .....</b>	<b>81</b>
Making CIFS connections .....	81

---

## Chapter 7 Menus

<b>Menu System Configuration .....</b>	<b>82</b>
<b>Setup Menu .....</b>	<b>82</b>
Items in the basic menu .....	83
Basic menu operations .....	86
Menu bank operations (menu items B01 to B13) .....	88
Items in the extended menu .....	89

---

## Appendix

<b>Important Notes on Operation .....</b>	<b>101</b>
About the LCD panel .....	101
Condensation .....	102
<b>Periodic Maintenance .....</b>	<b>102</b>
Operating hours meter .....	102
<b>Troubleshooting .....</b>	<b>104</b>
Alarms .....	104
Error messages .....	111
<b>Specifications .....</b>	<b>112</b>

<b>Using UMID Data.....</b>	<b>116</b>
<b>Ancillary Data.....</b>	<b>118</b>
Ancillary data in HDSDI/SDSDI signals .....	118
Ancillary data in MXF files .....	118
Closed caption data.....	119
<b>Trademarks and Licenses .....</b>	<b>120</b>
Trademarks .....	120
MPEG-4 visual patent portfolio license .....	120
MPEG-2 video patent portfolio license .....	120
About IJG (Independent JPEG Group).....	120
Character display software “iType”.....	120
Open software licenses .....	120
Obtaining GPL/LGPL/GPL V3 licensed software .....	121
<b>Index .....</b>	<b>122</b>

## Features

The PDW-HD1550 (hereinafter, the “unit”) is a Professional Disc recorder that supports Full HD (1920 × 1080) recording on Professional Disc media.

It features enhanced networking and other IT functions, and is highly compatible with nonlinear editing systems and network production systems, enabling efficient file-based operation.

The unit can be used as a player for video editing and program output, and as a recorder for nonlinear editing. For these applications, the unit can be connected via its SDI I/O connectors to earlier nonlinear editors, monitors, and video equipment with SDI interfaces.

It has a compact, lightweight body for easy portability outdoors, and can be powered from any of three power sources: AC, DC, or battery <sup>1)</sup> power.

1) BKP-L551 Battery Adaptor is required.

## Features of this unit

The principal features of this unit are as follows.

### Multiple codecs

#### MPEG HD422 codec

The MPEG HD422 codec provides video compression complied with the MPEG-2 422P@HL standard. It enables HD 4:2:2 (50 Mbps) digital component file recording in the 1080i (1080 effective scanning lines, interlaced) format currently in use by many broadcast facilities. Uncompressed PCM recording of 24-bit 48 kHz audio enables 8-channel audio recording at high sound quality.

#### MPEG-4 AVC/H.264 codec <sup>1)</sup>

This unit supports the XAVC™ format that complies with the MPEG-4 AVC/H.264 codec as a recording format and enables HD 4:2:2 digital component file recording

(CLASS 100) in 1080i (1080 effective scanning lines) format.

Uncompressed PCM recording of 24-bit 48 kHz audio enables 8-channel audio recording at high sound quality.

1) Installation of the optional XDBK-106 is required.  
Recording to PFD23 Professional Discs is not supported.

## Recording and playback functions

### Support for MPEG/XAVC/SD with multiple codecs

In addition to the MPEG HD422 codec and XAVC MPEG-4 AVC/H.264 codec (CLASS 100), this unit supports the MPEG HD420 codec, allowing HD operation across a wide range of recording times and application objectives.

The unit also supports file recording using the DVCAM codec, and IMX (30/40/50 Mbps) recording and playback. <sup>1)</sup>

1) Playback only for IMX 40 Mbps.

### Support for multiple frame frequencies

This unit can record and play MPEG HD422 format video at frame frequencies of 1080/59.94i, 50i, 29.97P, 25P, 23.98P or 720/59.94P, 50P.

It can record and play XAVC format video at frame frequencies of 1080/59.94i, 50i, 29.97P, 25P, 23.98P.

### SD up-convert function

The unit can output HD signals while playing Professional Discs recorded as SD, allowing SD material to be utilized in an HD environment.

### HD down-convert function

The unit is provided with a downconvert function. HD playback signals can be downconverted to SD signals and then output as S-SDI or composite signals. This allows you to use SD nonlinear editors and monitors for editing and program output.

### HDS-SDI remote recording

HDS-SDI connections can be made to camcorders with remote HDS-SDI support (PDW-700 XDCAM HD422 camcorder, HDW-730/730S/750/790/F900R HDCAM

camcorders) to enable recording synchronized to REC and STOP operations on the camcorder.

### 1080/720 cross-conversion

This unit supports cross-conversion output. It can output 720 while playing discs recorded as 1080, and output 1080 while playing discs recorded as 720.

### Recording of proxy AV data

Proxy AV data is low-resolution data (1.5 Mbps video, 64 kbps per audio channel) recorded using MPEG-4. When the unit records high-resolution data in MPEG HD422, proxy AV data is generated and recorded simultaneously. Because of its small size, proxy AV data can be transferred over a network at high speed, and significantly reduces the storage capacity required for recording. Various applications can readily take advantage of these characteristics, such as editing on laptop computers or managing content on inexpensive, small-scale servers.

### High-speed searches with the jog and shuttle dials

The jog and shuttle dials can be used to find scenes inside clips, in the same way as the jog and shuttle dials on conventional VTRs.

In jog and variable modes, frame advance search in field units is supported at up to  $-2$  to  $+2$  times normal speed. In shuttle mode, you can perform high-speed searches at up to  $\pm 20$  times normal speed. High-speed F.FWD and F.REV searching is possible at  $\pm 35$  times normal speed.

### Convenient playback and searching

Like previous products in the XDCAM series, this unit supports a number of convenient search functions, including, thumbnail searches, essence marks searches, and expand searches.

**Thumbnail searches:** The unit creates thumbnails from the first frame of each generated clip, and displays them in thumbnail lists on the color LCD or an external monitor. You can cue up clips very easily simply by selecting them from thumbnail lists.

**Essence mark searches:** Essence marks can be added to any scene during or after recording. A list of frames with essence marks can be displayed on the color LCD or an external monitor.

**Expand searches:** This function allows you to look inside the clip selected on a thumbnail screen, or inside the segment from a selected essence mark to the next essence mark. The selection range is divided into 12 equal blocks, and the first frames of those blocks are displayed as thumbnails. By checking the thumbnails, you can easily find the scene you want.

## Usability features

### AC, DC, and battery <sup>1)</sup> power support

The unit can be used even where AC power is not available, for example outdoors or in cars or helicopters. <sup>2)</sup>

1) BKP-L551 Battery Adaptor is required.

2) When installing the unit, check that the unit can record and play back normally before use.

When recording/playing XAVC, use the unit under stable conditions with no vibration.

### Color LCD display

The unit is equipped with a 16:9, 4.3-inch color LCD which allows you to check the contents of the disc and use the menu system without connecting an external monitor.

### Built-in speakers

The unit features built-in speakers, allowing you to monitor recorded audio. You can check your clips and editing results using the color LCD and speakers even when no monitors or separate speakers are available.

### Tiltable front panel

The front panel is tiltable for easy rack-mount and desktop operation. You can adjust the panel to the angle that makes the buttons easiest to use.

### Cache recording for seamless disc exchanges

About 50 seconds (this duration may differ depending on the state of a disc) of video and audio data can be recorded to the unit's internal memory cache during a disc exchange, and then written back to the newly loaded disc. This allows seamless recording across extended recording sessions, including recording of video feeds, with no important scenes lost while discs are being exchanged.

## IT friendly

### Equipped with network connector

The unit features a Gigabit Ethernet connector as standard equipment. Via this connector, you can connect the unit to computers and networks to enable listing of the video, audio, and metadata files recorded on the Professional Disc, and rapid file transfers. Support for FTP commands makes it easy to carry out network file transfers from remote locations.

### Supports SNMP for maintenance and service

This unit supports Sony's SNMP-based remote maintenance and monitoring software. This software allows you to monitor the status of the hardware via a TCP/IP network in real time, and to record the results in a status log.

### Supports a variety of interfaces

This unit supports the following input/output signals.

- HDSDI video, 8-channel audio input and output
- SDDSI video, 8-channel audio input and output (the SD/HDSDI INPUT connector doubles as an SDDSI/HDSDI input connector)
- HDMI output

- SD composite output
- Analog audio 4-channel input
- Analog audio 2-channel output
- AES/EBU digital audio 4-channel input and output
- Remote
  - RS-422A (D-sub 9-pin × 1)

## Copying files between USB external storage and a Professional Disc

The unit is provided with a USB 3.0 interface on the front panel, allowing you to connect a USB mass storage class (3 GB to 2 TB) device and use it as external storage. You can copy clips and clip lists between this external storage and a disc.

You can also copy clips from SxS memory cards by connecting the optional SBAC-US20 SxS Memory Card USB Reader/Writer.

## Software Downloads

When the unit is used with a PC connection, download device drivers, plug-ins, and application software, where applicable, from the Sony Professional products web site.

Sony Professional products web site homepage:

U.S.A.	<a href="http://pro.sony.com">http://pro.sony.com</a>
Canada	<a href="http://www.sonybiz.ca">http://www.sonybiz.ca</a>
Latin America	<a href="http://sonypro-latin.com">http://sonypro-latin.com</a>
Europe, Middle East and Africa	<a href="http://www.pro.sony.eu">http://www.pro.sony.eu</a>
Japan	<a href="http://www.sonybsc.com">http://www.sonybsc.com</a>
Asia Pacific	<a href="http://pro.sony-asia.com">http://pro.sony-asia.com</a>
Korea	<a href="http://bp.sony.co.kr">http://bp.sony.co.kr</a>
China	<a href="http://pro.sony.com.cn">http://pro.sony.com.cn</a>



# System Configurations

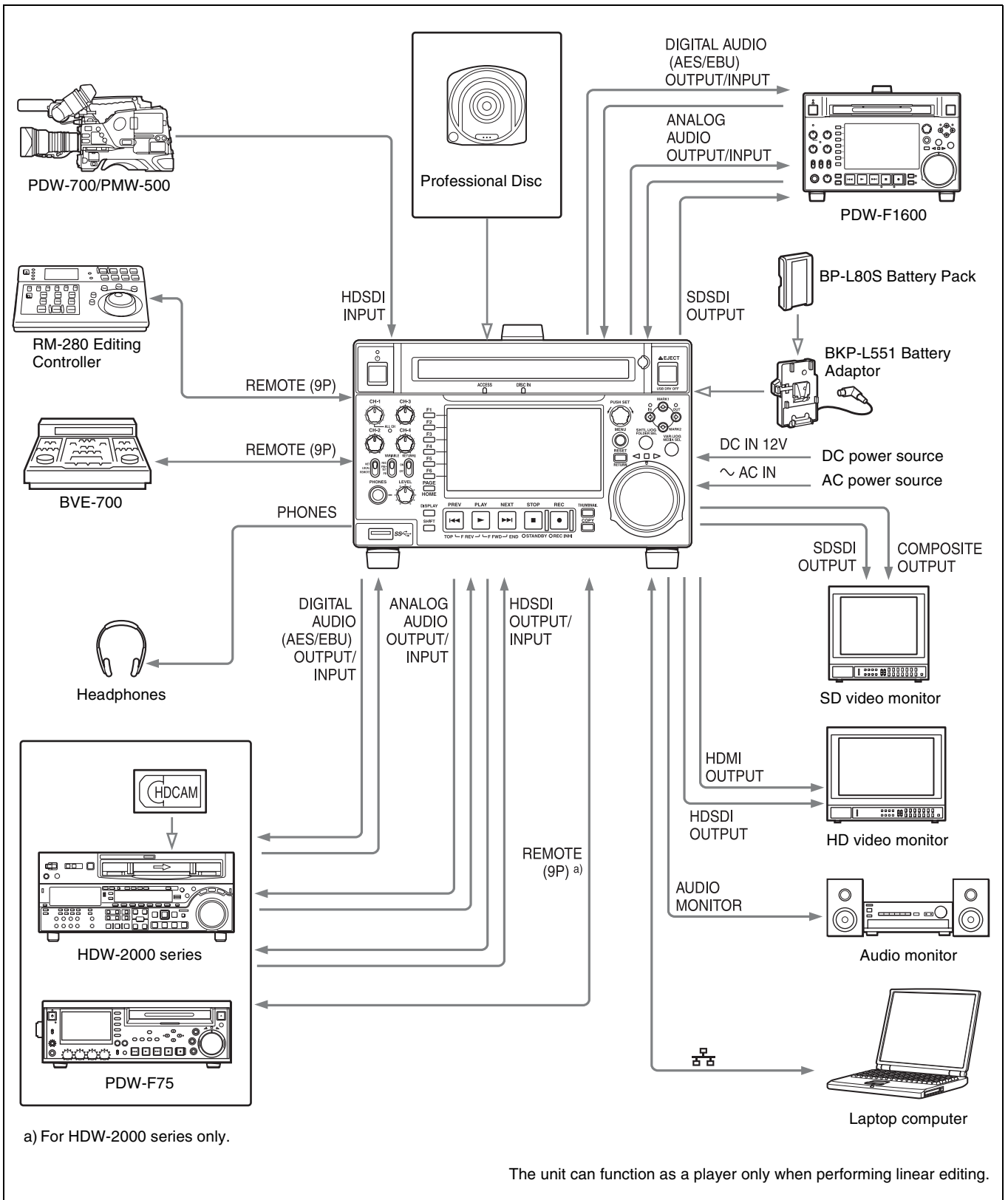

# Names and Functions of Parts

## Chapter

# 2

## Front Panel

The names and symbols of buttons and knobs on the front panel are color coded according to function.

**White:** Function when the button or knob is operated independently.

**Orange:** Function when the button is operated with the SHIFT button held down.

**Blue:** Function related to thumbnail operations.

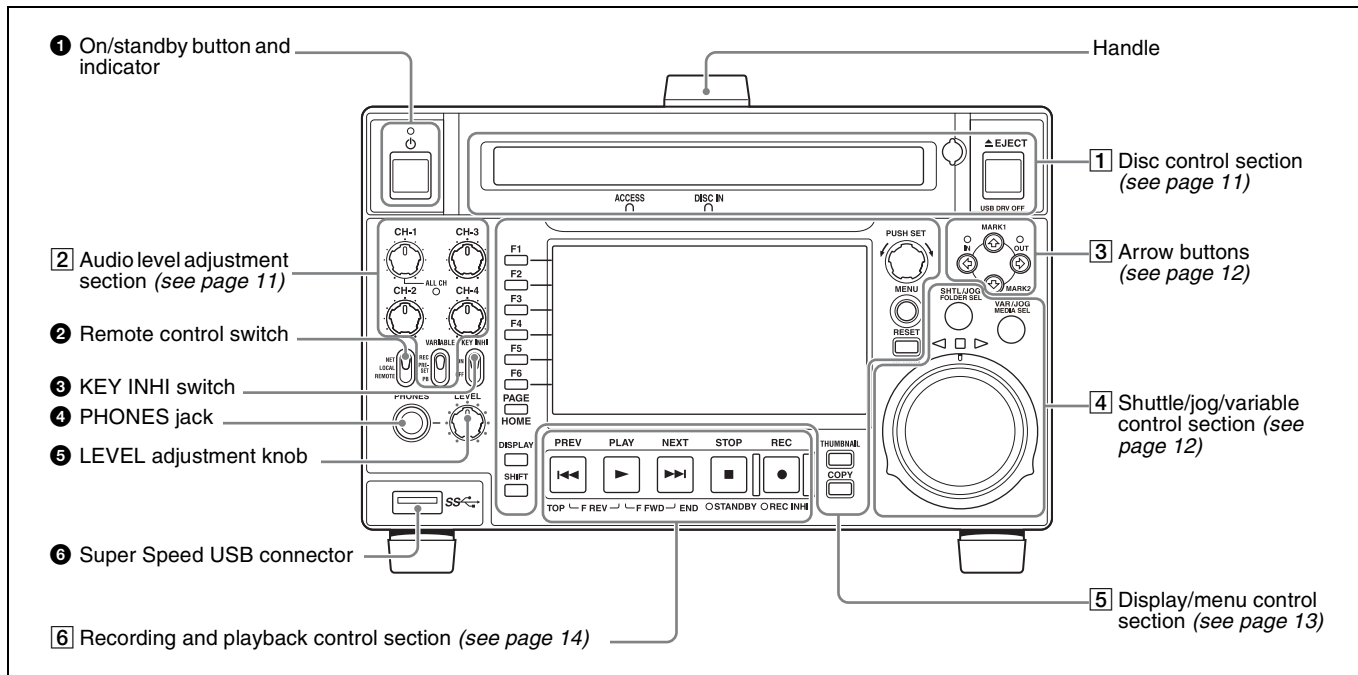

### 1 On/standby (⏻) button and indicator

When the POWER switch on the rear panel is in the **I** (on) position, or when DC power is connected to the DC IN 12V connector on the rear panel, this switches the unit between the operating state (the indicator is lit green) and the standby state (the indicator is lit red).

When you press this button with the indicator lit red and hold it down for a short time (0.25 seconds or longer), the indicator changes to lit green, and the unit enters the operating state.

When you press this button with the indicator lit green and hold it down for a longer time (1 second or longer), the indicator changes to flashing green and then lit red, and the unit enters the standby state.

When using this unit, normally leave the rear panel POWER switch in the **I** position, and use this button to switch the unit between the operating state and standby state.

## 2 Remote control switch

Different positions of the switch allow different operations as follows.

**NET:** Enables access to the network. When an external network device is being accessed, operations of the buttons and dials related to recording and playback are disabled.

**LOCAL:** Enables operation from the front panel.

With this unit accessing a network device, setting the remote control switch to “LOCAL” displays a dialog asking for your confirmation about network disconnection. To disconnect, press the PUSH SET knob. To not disconnect, set the remote control switch to “NET”.

**REMOTE:** Enables remote control of this unit from the following devices:

- Devices connected to the REMOTE (9P) connector
  - Devices connected to the SD/HDSI INPUT connector with SDI remote control functions
- Use setup menu item 214 REMOTE INTERFACE to select which of the connectors is used for remote control.

When operating the unit by remote control, you can use setup menu item 006 LOCAL FUNCTION ENABLE to enable or disable the buttons and switches in the recording and playback control section of the unit.

## 3 KEY INHI switch

This turns key operation inhibit mode on or off.

**ON:** Turns key operation inhibit mode on.

**OFF:** Turns key operation inhibit mode off.

## 4 PHONES jack

The jack is a standard stereo jack. Connect stereo headphones to monitor the audio during recording, playback, and editing. (Non-audio signals are muted.) The monitored channel is selected with MONITR L and MONITR R on the HOME page of the function menu (see page 39).

## 5 LEVEL (volume) adjustment knob

Adjust the volume of headphones or speakers with the knob. You can also cause this to simultaneously adjust the output volume from the AUDIO MONITOR R, L connectors on the rear panel. To do this, set setup menu item 114 AUDIO MONITOR OUTPUT LEVEL to “variable”.

## 6 Super Speed USB (SS) connector (USB 3.0)

Connect the USB connector of the external storage device.

## 1 Disc control section

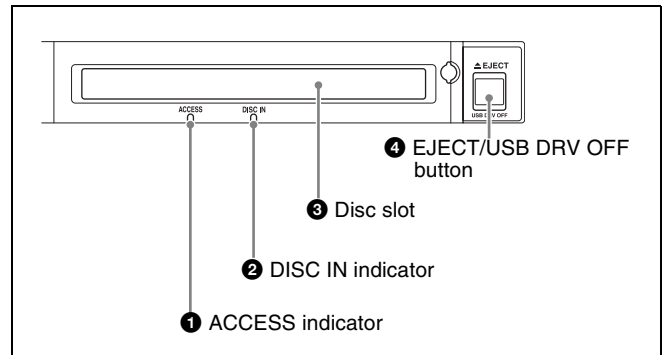

### 1 ACCESS indicator

This lights when the Professional Disc is accessed.

### Note

While the ACCESS indicator is lit, do not turn off the POWER switch on the rear panel or disconnect the power cord.

This could lead to a loss of data from the disc.

### 2 DISC IN indicator

This lights when a Professional Disc is inserted.

### 3 Disc slot

Insert a Professional Disc in this slot.

### 4 EJECT/USB DRV OFF (USB drive off) button

Functions as the EJECT button or the USB DRV OFF button.

**EJECT button:** To remove the Professional Disc, press this button.

**USB DRV OFF button:** To unmount the USB drive, press this button.

See “Handling Discs” (page 42) for more information about disc operations.

See “Handling External Storage” (page 44) for more information about USB drive operations.

## 2 Audio level adjustment section

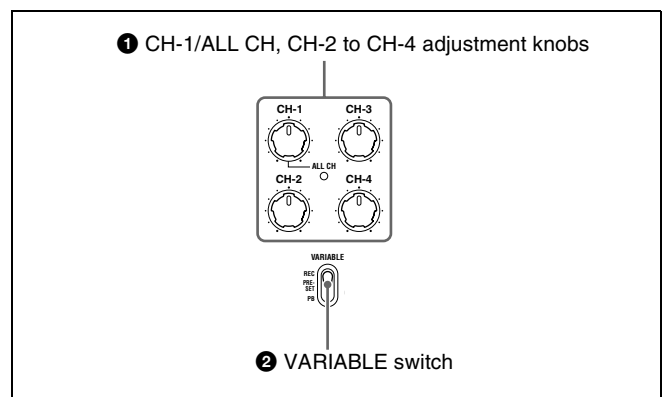

### ❶ CH-1/ALL CH, CH-2 to CH-4 (audio level) adjustment knobs

Depending on the setting of the VARIABLE switch, these adjust the input audio or playback audio levels of channels 1 to 4.

You can adjust levels of channels 5 to 8 using the function menu.

For details, see page 41.

By setting setup menu item 131 AUDIO VOLUME, you can enable the CH-1/ALL CH adjustment knob to simultaneously adjust all eight channels. When this simultaneous adjustment is enabled, the ALL CH indicator lights.

### ❷ VARIABLE (audio level adjustment selector) switch

This selects whether the input audio level or playback audio level is adjusted when using the CH-1/ALL CH and CH-2 to CH-4 adjustment knobs to adjust channels 1 to 4, and when using the function menu to adjust channels 5 to 8.

**REC:** Adjust the input audio levels. The playback audio levels are fixed at their preset values.

**PRESET:** The audio levels are fixed at their preset values.

**PB:** Adjust the playback audio levels. The input audio levels are fixed at their preset values.

### ❸ Arrow buttons

The four arrow buttons can also be used as the MARK1 button, MARK2 button, IN button, and OUT button. The correspondence with these buttons is as follows.

▲ **button:** MARK1 button

▼ **button:** MARK2 button

◀ **button:** IN button

▶ **button:** OUT button

You can use these buttons for thumbnail selection, menu setting operations, setting IN/OUT points, and so on.

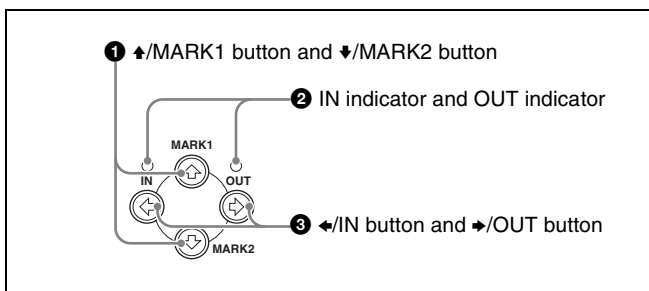

### ❶ ▲/MARK1 button and ▼/MARK2 button

When the clip list screen is shown on the display, you can use these for thumbnail selection.

During recording or playback, a shot mark 1 or shot mark 2 is recorded as an essence mark when you press the PUSH SET knob with the ▲/MARK1 or ▼/MARK2 button held down.

You can delete essence marks on the chapter thumbnail screen (see page 65).

### ❷ IN indicator and OUT indicator

Lights or flashes as follows when you set IN and OUT points in the clip to copy only the part defined by the IN and OUT points (see page 56).

**IN indicator:** When an IN point is set, this lights. If an attempt is made to set the IN point after a recorded OUT point, this flashes.

**OUT indicator:** When an OUT point is set, this lights. If an attempt is made to set the OUT point before a recorded IN point, this flashes.

### ❸ ◀/IN button and ▶/OUT button

When the clip list screen is shown on the display, you can use these for thumbnail selection.

An IN or OUT point is set when you press the PUSH SET knob with the ◀/IN or ▶/OUT button held down. The IN or OUT point setting is deleted when you press the RESET/RETURN button with the ◀/IN or ▶/OUT button held down.

### ❹ Shuttle/jog/variable control section

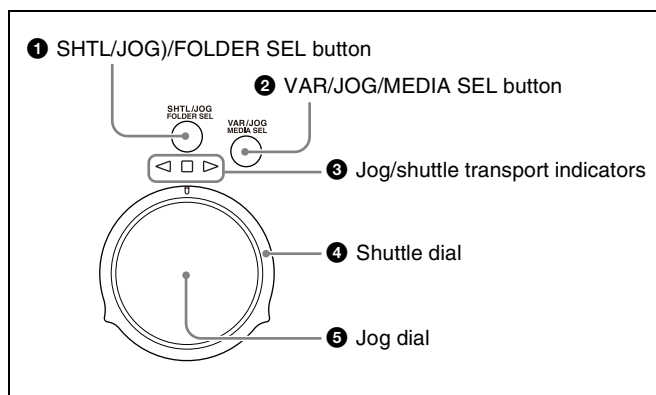

#### ❶ SHTL/JOG (shuttle/jog)/FOLDER SEL (folder select) button

Functions as the SHTL/JOG button or the FOLDER SEL button.

**SHTL/JOG button:** Press this button, turning it on, to perform shuttle or jog playback.

**FOLDER SEL button:** When a USB drive is connected, press this button to display a list of the folders on the USB drive.

#### ❷ VAR/JOG (variable/jog)/MEDIA SEL (media select) button

Functions as the VAR/JOG button or the MEDIA SEL button.

**VAR/JOG button:** Press this button, turning it on, to perform variable or jog playback.

**MEDIA SEL button:** When a USB drive is connected, press this button to select the target media (disc or USB drive).

### 3 Jog/shuttle transport indicators

These show the playback direction in jog, shuttle, or variable mode.

### 4 Shuttle dial

Turn this dial for shuttle or variable playback.

### 5 Jog dial

Turn this dial for jog playback.

For details of playback operations in jog, shuttle, or variable mode, see “Playback operation” (page 52).

For details of USB drive operations with the **FOLDER SEL** and **MEDIA SEL** buttons, see “Handling External Storage” (page 44).

## 5 Display/menu control section

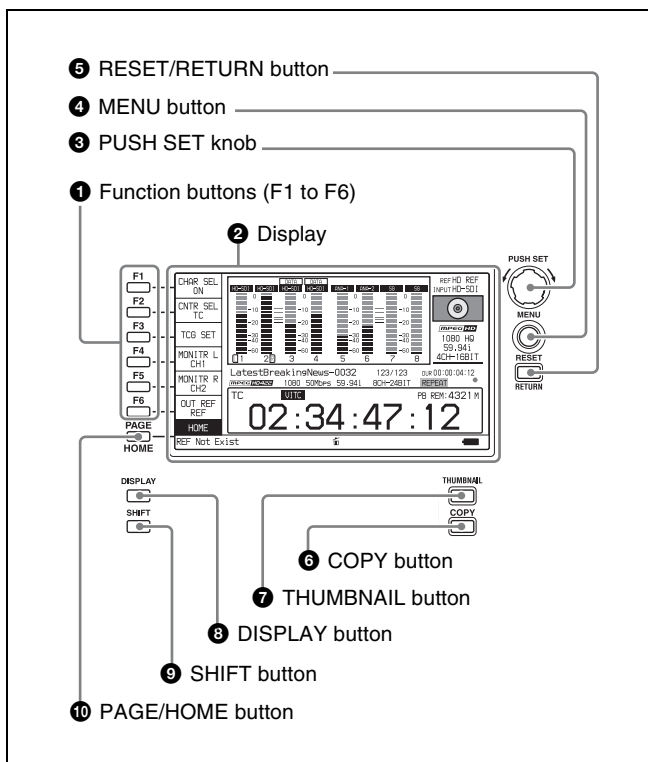

### 1 Function buttons (F1 to F6)

These buttons are enabled when the function menu (see page 39) is visible. Each press of a button changes the setting of the corresponding item in the menu. For convenience, this manual refers to these buttons as buttons F1 to F6, in order from the top.

### 2 Display

Displays menus, audio level meters, and data, such as time data or clip information. The **DISPLAY** button lets you switch to the video monitor display.

For details, see “Display screen” (page 15).

### 3 PUSH SET knob

Use for setting menu items and for operations using thumbnails on clip list screens. Turn the knob to select items, and press it to confirm the selection. This button is also used to set numerical values, such as timecodes.

See “Clip Operations” (page 64) for more information about how to use the thumbnail screens.

### 4 MENU button

Displays the setup menu or the clip list screen menu. The setup menu appears when no clip list screen is visible. The same information is also superimposed on the display on a monitor connected to the HDMI OUT connector of the unit. Press once more to return to the original display.

See “Clip Operations” (page 64) for more information about how to use the thumbnail screens.

### 5 RESET/RETURN button

Functions as the **RESET** button or the **RETURN** button. **RESET button:** Resets counters or the setting values of the timecode generator. This button is also used to abort or cancel setup menu and thumbnail search operations.

**RETURN button:** On setup menu and clip list screens, returns to the previous procedure.

### 6 COPY button

Displays the Clip Copy screen (see page 55) when pressed while the clip list screen is shown on the display.

### 7 THUMBNAIL button

When this button is pressed when the basic operation screen or video monitor screen is displayed, a list of clips or EDLs saved on the currently selected media is displayed. (That is, the current screen is switched to a clip list screen.) When pressed again, returns to the basic operation screen or the video monitor screen.

See “Clip Operations” (page 64) for more information about how to use the thumbnail screens.

### 8 DISPLAY button

Each press of this button switches the display screen between the basic operation screen and video monitor screen (see page 15).

When the clip list screen is shown on the display, this button switches the display screen between thumbnails view and details view.

### 9 SHIFT button

Switches between functions for any button with two functions.

## 10 PAGE/HOME button

When pressed alone, this functions as the PAGE (page switching) button. When pressed together with the SHIFT button, functions as the HOME button.

**PAGE button:** Displays the function menu, if it is not already visible. (The most recently displayed page of the function menu appears.)

**HOME button:** When pressed with the function menu visible, returns to the HOME page of the function menu.

## 6 Recording and playback control section

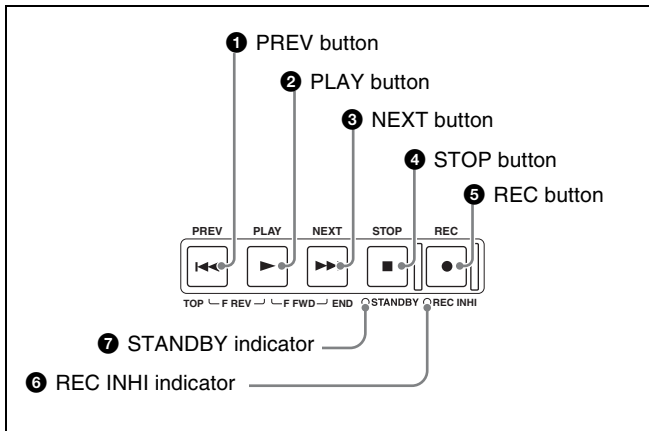

### 1 PREV (previous) button

Press this button, turning it on, to show the first frame of the current clip. When the first frame of a clip is shown, pressing this button jumps to the beginning of the previous clip. <sup>1)</sup> This button is also used together with other buttons for the following operations.

**Reverse direction high-speed search:** Hold down the PLAY button, and press this button. A high-speed search in the reverse direction is carried out.

**Displaying the first frame of the first clip:** Hold down the SHIFT button, and press this button.

1) When setup menu item 153 FIND MODE is set to “clip & rec start mark”, this button jumps to the frame where the previous Rec Start essence mark is set and displays the video of that frame.

### 2 PLAY button

To start playback, press this button, turning it on.

When this button is pressed during recording, recording stops and the unit enters stop mode. If you do not want to stop recording when this button is pressed, set setup menu item 145 MODE KEY ENABLE DURING RECORDING to “stop”.

### 3 NEXT button

Press this button, turning it on, to jump to the next clip, and show the first frame. <sup>2)</sup> This button is also used together with other buttons for the following operations.

**Forward direction high-speed search:** Hold down the PLAY button, and press this button. A high-speed search in the forward direction is carried out.

**Displaying the last frame of the last clip:** Hold down the SHIFT button, and press this button.

2) When setup menu item 153 FIND MODE is set to “clip & rec start mark”, this button jumps to the frame where the next Rec Start essence mark is set and displays the video of that frame.

### 4 STOP button

To stop recording or playback, press this button, turning it on. The frame at the stop point is displayed.

#### Note

This button flashes when setup menu item 105 REFERENCE SYSTEM ALARM is set to “on” and the correct reference video input signal (as specified by OUT REF on the HOME page of the function menu) is not being input.

### 5 REC (record) button

To start recording, hold down this button, and press the PLAY button. The recording takes place on an unrecorded part of the disc.

To stop recording, press the STOP button.

#### To monitor in EE mode

You can press this button when in stop mode to monitor input signals in EE mode. The button lights when pressed. Press the STOP button to return to the original video. You can also press this button during playback and searches to view EE mode for as long as the button is held down.

### 6 REC INHI (recording inhibit) indicator

This lights in the following cases.

- When a disc with recording inhibited is loaded.
- When the format of the recorded part of the disc does not match the system frequency settings of the unit.

### 7 STANDBY indicator

Lights when the unit is put into disc stop mode. After a certain time passes in a disc stop mode, the unit automatically enters standby state and the indicator goes off.

You can specify the time until the unit enters standby state with setup menu item 501 STILL TIMER.



# Display screen

## Basic operation screen

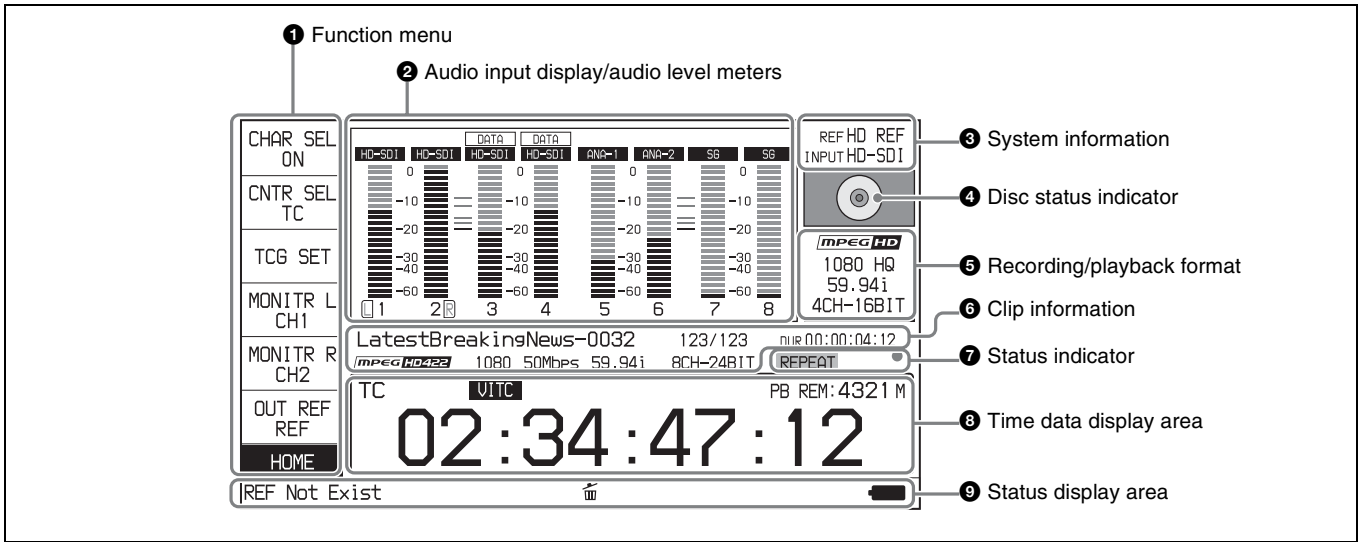

### 1 Function menu

Use the PAGE/HOME button to display this menu, and to switch between the pages (HOME, P1 to P6) of the menu. Each page has one to six setting items. Press the corresponding function button to change a setting.

### 2 Audio input display/audio level meters

Displays information about audio. There are two display modes for the audio level meter: FULL mode and FINE mode, which can be switched using AU METER on page P3 AUDIO of the function menu.

For details, see “Basic Operations of the Function Menu” (page 39).

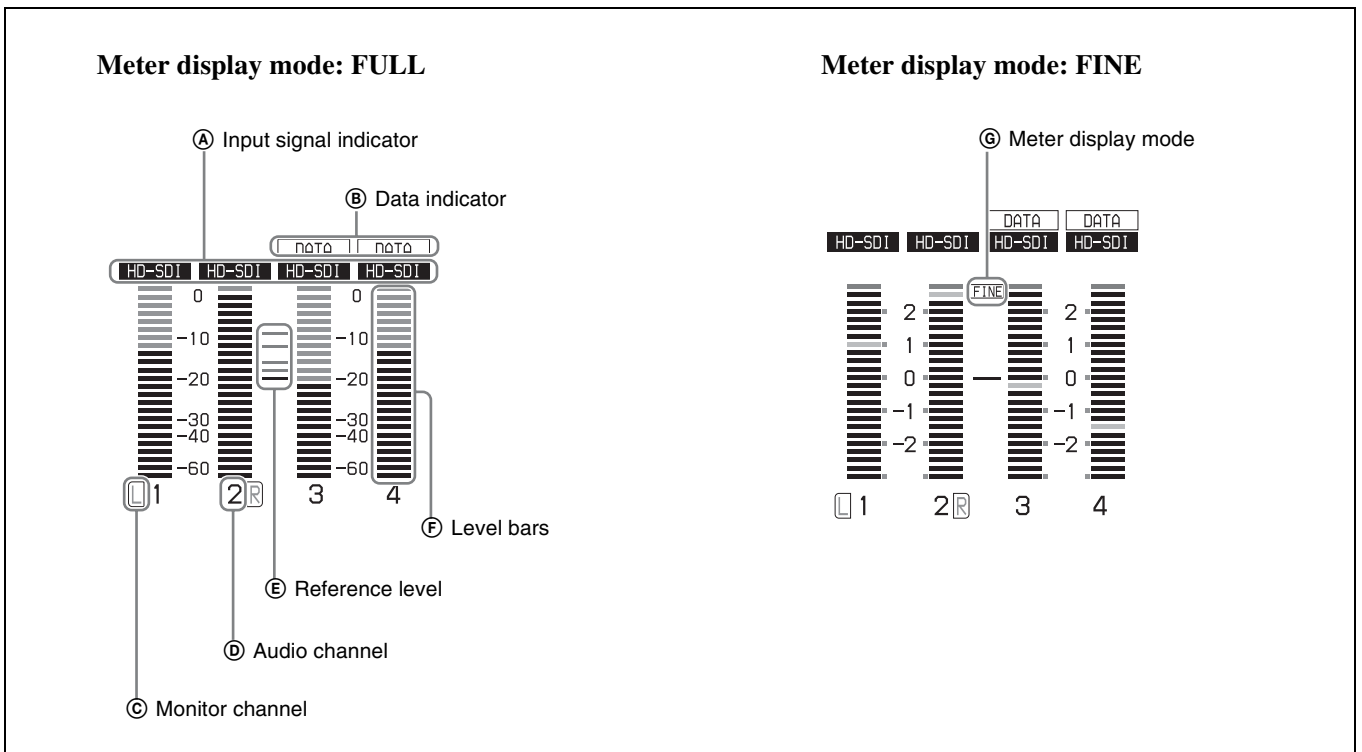

- Ⓐ **Input signal indicator:** Displays the audio input signal.

Display	Input signal	
ANA-1 (MIC-1)	Analog audio signal	Channel 1, 3, 5, 7 or Channel 1, 5 <sup>a)</sup>
ANA-2 (MIC-2)		Channel 2, 4, 6, 8 or Channel 2, 6 <sup>a)</sup>
ANA-3		Channel 3, 7 <sup>a)</sup>
ANA-4		Channel 4, 8 <sup>a)</sup>
HD-SDI	HDSDI audio signal (flashes when there is no input signal)	
SD-SDI	SDSDI audio signal (flashes when there is no input signal)	
AES/EBU	AES/EBU audio signal (flashes when there is no input signal)	
SG	Test signal from the internal signal generator	

a) When maintenance menu item M374 ANALOG I/O is set to "4ch" only.

- Ⓑ **Data indicator:** Appears when the input signals are non-audio signals.
- Ⓒ **Monitor channel:** Displays the audio monitoring channels set with MONITR L and MONITR R on the HOME page of the function menu (*see page 39*).
- Ⓓ **Audio channel:** Displays the audio channels. Also indicates preset or variable-speed mode by its color (*see page 12*).  
**White:** Preset mode  
**Green:** Variable-speed mode
- Ⓔ **Reference level:** Displays the reference level for recording as set with maintenance menu item M370 HEAD ROOM.  
*For details about the reference level setting, refer to the Service Manual.*
- Ⓕ **Level bars:** Displays the audio recording or playback levels of channels 1 to 8. The OVER indicators light when the audio level exceeds 0 dB.
- Ⓖ **Meter display mode:** Displays the audio level meter display mode selected with AU METER on page P3 AUDIO of the function menu (*see page 41*).

### 3 System information

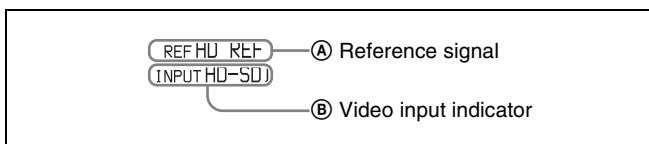

- Ⓐ **Reference signal:** Displays the type of reference signal to which this unit is synchronizing. When there is no display, the unit is synchronizing to the internal reference signal.  
**INPUT:** Input video  
**HD REF:** HD-format reference signal

**SD REF:** SD-format reference signal

- Ⓑ **Video input indicator:** Displays the selected video input signal.

**HD-SDI:** HDSDI video input

**SD-SDI:** SDSDI video input

**SG:** Test video signal from the internal signal generator

The video signal input is selected with V INPUT on page P1 INPUT of the function menu (*see page 40*).

#### Note

The display blinks when there is no video input signal, and when the video input signal does not match the system frequency of this unit.



### 4 Disc status indicator

Displays an icon indicating the status of the disc or external storage.

Icon			Status
Professional Disc		External storage	
PFD23A/ PFD50DLA/ PFD100TLA	PFD128QLW	External storage	Not loaded
		—	Mounting Displays a mounting progress bar.
			Normal status
			Warning level error has occurred. (Finalizing is not possible.)
			Error has occurred. (Restoring is not possible.)
—		—	Finalized
		—	Ejecting

The PFD128QLW disc status indicator changes with the remaining capacity of the recordable resource space (for writing the disc management data, etc.).



Icon	Status
	The available recordable resource space is running out.
	There is no available recordable resource space on the disc.

### Note

The remaining capacity of recordable resource space is not the same as the remaining recording capacity. When there is no available recording resource space left on the disc, file writing may be disabled even with sufficient available storage remaining.

### 5 Recording/playback format

This displays the recording format during recording and the playback clip format during playback.

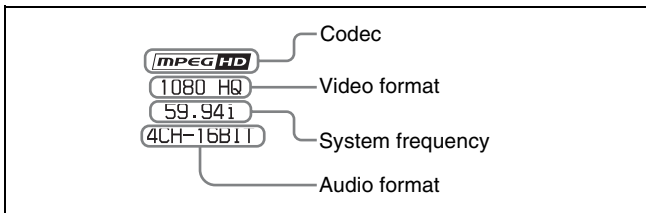

### 6 Clip information

Displays clip information.

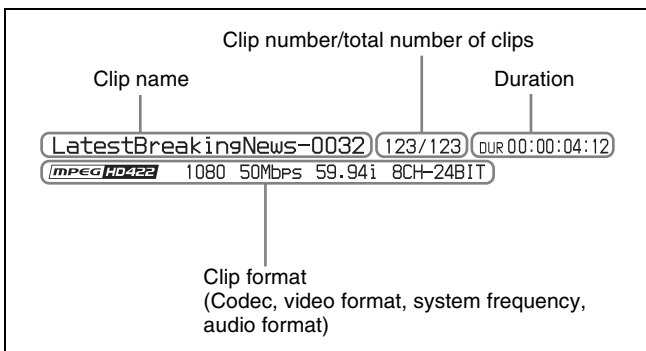

### 7 Status indicator

Displays icons indicating the status of this unit.

Icon	Description
REPEAT	Currently set to repeat playback mode
SINGLE	Currently set to single clip playback mode
SNGL RPT	Currently set to single clip playback mode with repeat playback mode
FC	1080/720 cross-convert output
●	Recording

### 8 Time data display area

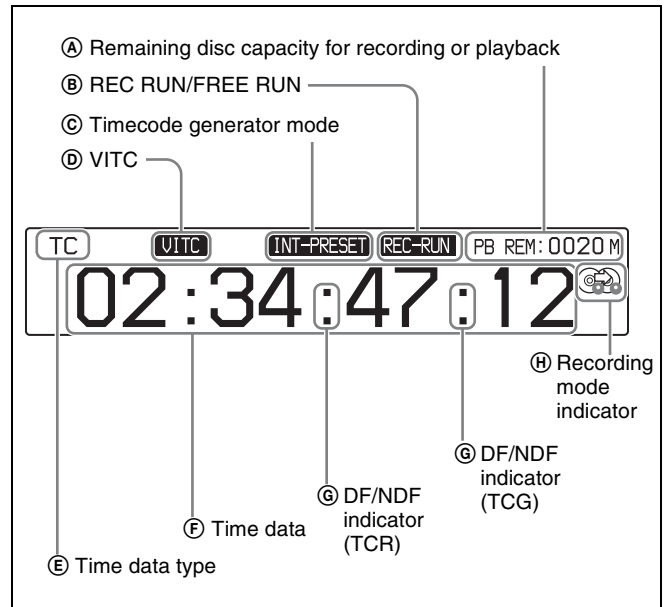

- (A) **Remaining disc capacity for recording or playback:** Displays the amount of remaining capacity for recording or playback on the disc.
- (B) **REC RUN/FREE RUN:** Displays the timecode run mode. The run mode is set with RUN MODE on page P4 TC of the function menu (*see page 41*).
- (C) **Timecode generator mode:** Displays the timecode source and generation method (preset or regenerate). These are set with TCG and PRST/RGN on page P4 TC of the function menu (*see page 41*).
- (D) **VITC:** Lights in the following cases.
- When VITC is read in playback mode. (This has no relation to the display in the time data display area.)
  - When VITC recording is possible.
- (E) **Time data type:** Displays the type of time data displayed in the time data display area. The type of time data is selected with CNTR SEL on the HOME page of the function menu (*see page 39*).

Display	Type of time data
TC	Timecode
COUNTER	Elapsed recording/playback time
UB	User bits
VITC	VITC
VIUB	VIUB
TCG	Timecode generator value
UBG	User bits generator value

- (F) **Time data:** Normally displays timecode or VITC, according to the selection made with TCR on page P4 TC of the function menu.
- (G) **DF/NDF indicator:** Displays the frame count mode for the internal timecode reader (TCR) and internal timecode generator (TCG). The frame count mode is

set with DF/NDF on page P4 TC of the function menu (see page 41).

Display	Frame count mode
.	DF (drop-frame mode)
:	NDF (non-drop-frame mode)

**H Recording mode indicator:** This appears when setup menu item 150 REC MODE is set to “disc exchange cache”.

**9 Status display area**

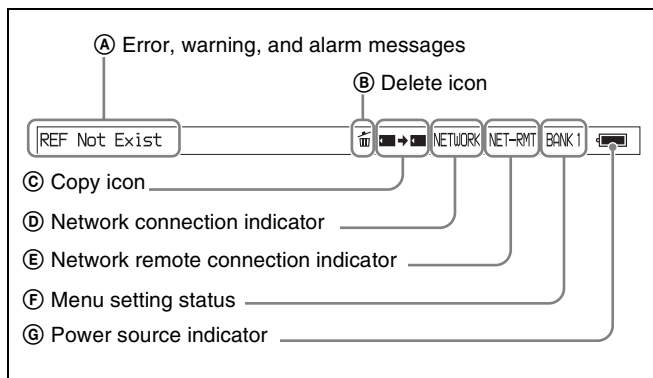

**A Error, warning, and alarm messages:** Messages about operations and the status of the unit appear here. The seriousness of the message is indicated by the color, as follows.

**Red:** Error message (flashing)

**Orange:** Warning message

**White:** Alarm message

**B Delete icon:** Flashes while a clip deletion is being executed.

**C Copy icon:** During a clip copy operation, displays an icon indicating the copy source/copy destination media.

Icon	Copy source/copy destination media
	External storage/disc
	Disc/external storage

**D Network connection indicator:** Lights while data is being exchanged with a network connected external device.

**E Network remote connection indicator:** “NET-RMT” or “RM-SDI” is displayed during a network remote control connection to an external device (see page 48).

**F Menu setting status:** Displays the current setup menu settings.

Display	Current setup menu settings
BANK1	Same as those in menu bank 1.
BANK2	Same as those in menu bank 2.
BANK3	Same as those in menu bank 3.

Display	Current setup menu settings
DEFAULT	Same as the factory default settings.
Nothing displayed	Different from any of the above.

**G Power source indicator:** Displays the icon for the power source being used.

Icon	Power source being used
	AC power source
	Battery

When the remaining battery power drops below a certain level, the battery icon starts flashing (this is the battery near end alarm).

**Note**

With the battery near end alarm displayed, when the battery voltage drops below the shutdown voltage set with setup menu item 033 BATTERY END VOLTAGE, the unit is automatically shut down.

**Video monitor screen**

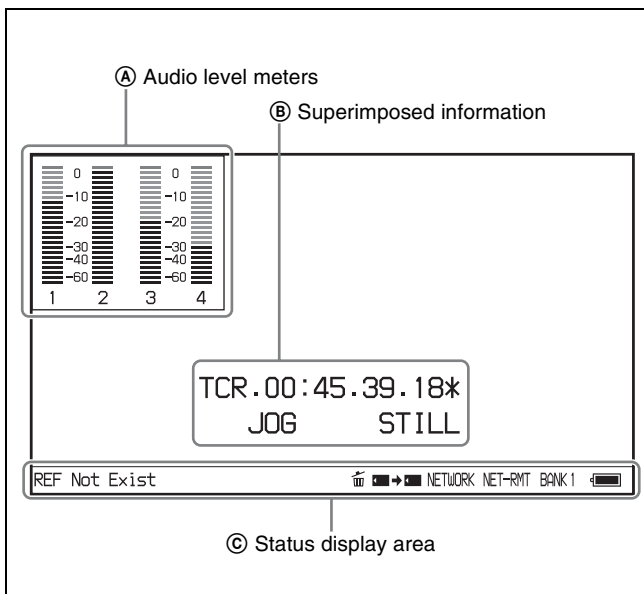

**A Audio level meters:** LEVEL MT on page P3 AUDIO of the function menu determines whether the meter is to be displayed and on which side, left or right, in the display window.

**B Superimposed information:** Appears when CHAR SEL on the HOME page of the function menu is set to “ON”.

**C Status display area:** Displays messages and icons about the status of the unit (see page 18). You can disable the status display area with the DISPLAY button. However, it is automatically enabled when:

- Display of error/warning/alarm message becomes necessary.
- During battery-driven operation, the power source indicator starts flashing (the battery near end alarm is given).



# Rear Panel

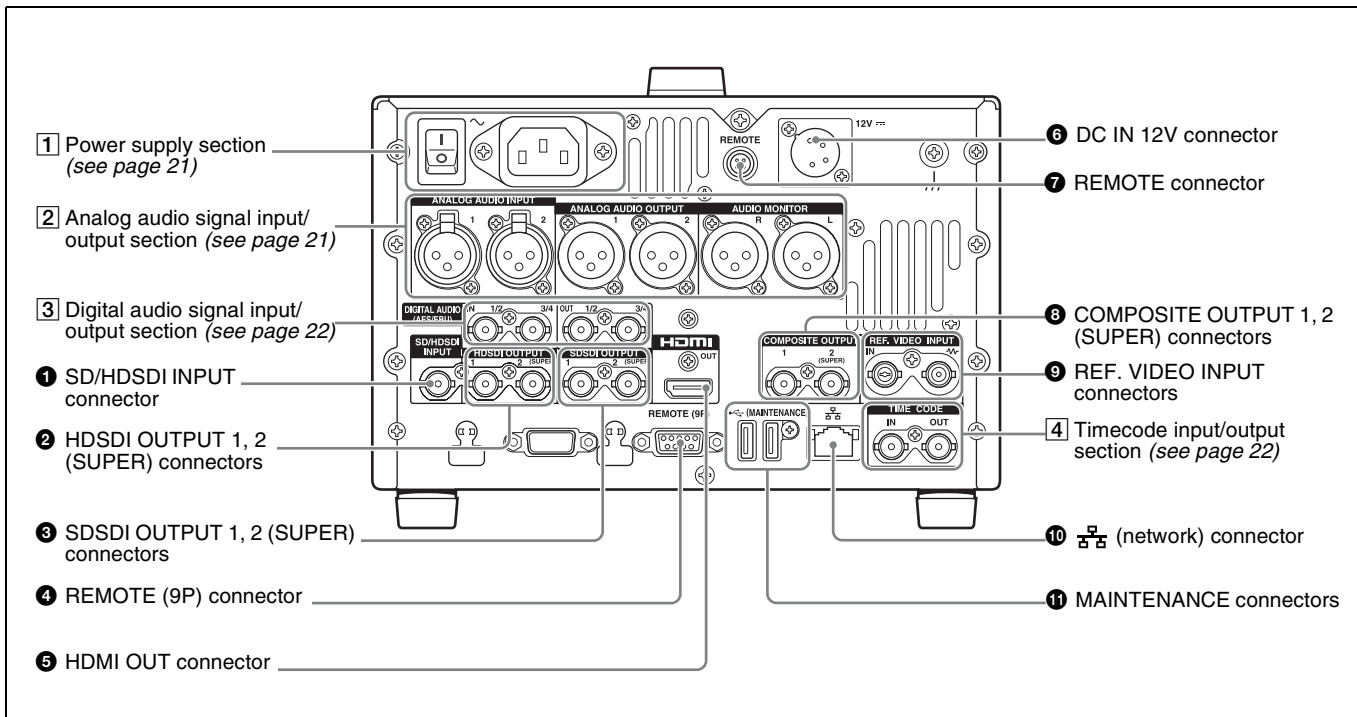

## 1 SD/HDSDI INPUT (SDDS I/HDSDI signal input) connector (BNC type)

This inputs an SDDS I or HDSDI format video/audio signal.

## 2 HDSDI OUTPUT 1, 2 (SUPER) (HDSDI signal output 1, 2 (superimpose)) connectors (BNC type)

These output HDSDI format video/audio signals. You can superimpose timecodes or other information on the output of the HDSDI OUTPUT 2 (SUPER) connector using the CHAR SEL setting on the HOME page of the function menu or the setting for setup menu item 028 HD CHARACTER. You can always disable the superimposition of data independently of the setting for CHAR SEL using the setting for setup menu item 028.

See “Basic Operations of the Function Menu” (page 39) for more information about the CHAR SEL setting.

See page 85 for more information about the setup menu item 028 HD CHARACTER.

To treat the input and output signals of these connectors as non-audio signals, set maintenance menu item M372 NON-AUDIO INPUT.

For details, refer to the Service Manual.

## 3 SDDS I OUTPUT 1, 2 (SUPER) (SDI signal outputs 1, 2 (superimpose)) connectors (BNC type)

These output SDDS I format video/audio signals. When the unit is shipped from the factory, audio signal output is eight channels with no switching, and RP188 timecode output is set to on. You can change these settings with setup menu item 828 SDI AUDIO OUTPUT SELECT and setup menu item 920 SD-SDI H-ANC CONTROL.

The output from the 2 (SUPER) connector can have timecode and other text information superimposed. To turn superimposition off, set CHAR SEL on the HOME page of the function menu to “OFF”.

See “Items in the extended menu” (page 89) for more information about setup menu settings.

See “Basic Operations of the Function Menu” (page 39) for more information about the CHAR SEL setting.

## 4 REMOTE (9P) (remote control 9-pin) connector (D-sub 9-pin)

Connect a controller that supports the RS-422A Sony 9-pin VTR control protocol.

## 5 HDMI OUT connector

Connects to an HD projector, HD television, or other HD consumer device, and outputs digital signals (video, audio, and control signals).

The audio signals of the channels selected with MONITR L and MONITR R on the HOME page of the function menu are output.

You can superimpose timecodes, menu settings, and error messages on the HDMI output using the CHAR SEL setting on the HOME page of the function menu.

See “Basic Operations of the Function Menu” (page 39) for more information about the MONITR L and MONITR R settings.

### 6 DC IN 12V connector (XLR 4-pin, male)

Connect to a 12 V DC power source.

When using the BKP-L551 Battery Adaptor to mount a battery pack, connect the power cable of the BKP-L551.

For details, see “Supplying power” (page 23).

### 7 REMOTE connector (4-pin)

Supplies power to the RM-280 Remote Edit Controller.

### 8 COMPOSITE OUTPUT 1, 2 (SUPER) (analog composite video output 1, 2 (superimpose)) connectors (BNC type)

These output analog composite video signals. You can superimpose timecodes on the output of the 2 (SUPER) connector when CHAR SEL on the HOME page of the function menu is set to ON.

See “Basic Operations of the Function Menu” (page 39) for more information about the CHAR SEL setting.

### 9 REF. VIDEO INPUT (reference video signal input) connectors (BNC type)

The two connectors form a loop-through connection; when a reference video signal is input to the left connector, the same signal is input from the right connector (  ) (IN) to a connected device. When no connection is made to the right connector, the left connector is automatically terminated with an impedance of 75 ohms.

### 10 (network) connector (RJ-45 type)

This is a 10BASE-T/100BASE-TX/1000BASE-T connector for network connection.

#### CAUTION

- For safety, do not connect the connector for peripheral device wiring that might have excessive voltage to this port. Follow the instructions for this port.
- When you connect the network cable of the unit to peripheral device, use a shielded-type cable to prevent malfunction due to radiation noise.

### 11 MAINTENANCE connectors

These are High Speed USB (USB2.0) connectors for maintenance.

Do not use for applications other than maintenance.

## 1 Power supply section

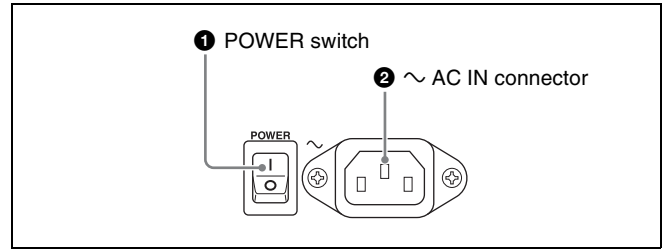

### 1 POWER (main power) switch

Press the I side to power on the unit. Press the O side to power off.

When using the unit, normally leave the POWER switch in the I (on) position, and use the on/standby button on the front panel to switch the unit between the operating state and standby state.

#### Note

Before turning the main power off, always check to be sure that the unit is in the standby state, and then press the main power switch to the O side.

### 2 ~AC IN connector

Connect to an AC power source using a power cord (not supplied).

## 2 Analog audio signal input/output section

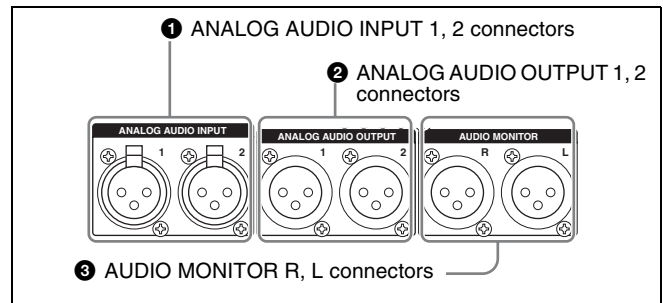

### 1 ANALOG AUDIO INPUT 1, 2 connectors (XLR 3-pin, female)

These input analog audio signals.

With A1 INPUT, A2 INPUT, A3 INPUT, and A4 INPUT on page P1 INPUT of the function menu (see page 40), you can assign the input signal on connector 1 to audio channel 1 or 3, and assign the input signal on connector 2 to audio channel 2 or 4.

With A5 INPUT, A6 INPUT, A7 INPUT, and A8 INPUT on page P2 INPUT of the function menu (see page 40), you can assign the input signal on connector 1 to audio channel 5 or 7, and assign the input signal on connector 2 to audio channel 6 or 8.

You can set the reference input level with maintenance menu item M373 IN LEVEL. (Factory default setting: +4dB)

For details, refer to the Service Manual.

## Microphone settings

If you have connected a microphone to this unit, you can set input level, AGC, and limiter values for the microphone with setup menu items 834, 839, 840, and 841.

### Note

An unpleasant sound may be output if you have connected a microphone to the ANALOG AUDIO INPUT 1 or 2 connector and power the microphone on with the input level too high. Check the input level setting before connecting a microphone.

## 2 ANALOG AUDIO OUTPUT 1, 2 connectors (XLR 3-pin, male)

These output analog audio signals.

When the unit is shipped from the factory, connector 1 is set to audio channel 1, and connector 2 is set to audio channel 2. You can change these settings with setup menu item 824 ANALOG LINE OUTPUT SELECT (see page 97).

You can set the output level with maintenance menu item M377 OUT LEVEL. (Factory default setting: +4dB)

Non-audio signals are muted.

*For details, refer to the Service Manual.*

The function of the ANALOG AUDIO OUTPUT 1, 2 connectors can be switched to ANALOG AUDIO INPUT 3, 4 connectors with maintenance menu item M374 ANALOG I/O.

With A1 INPUT, A2 INPUT, A3 INPUT, and A4 INPUT on page P1 INPUT of the function menu (see page 40), you can assign the input signal on connector 1 to audio channel 1, the input signal on connector 2 to audio channel 2, the input signal on connector 3 to audio channel 3, and the input signal on connector 4 to audio channel 4.

With A5 INPUT, A6 INPUT, A7 INPUT, and A8 INPUT on page P2 INPUT of the function menu (see page 40), you can assign the input signal on connector 1 to audio channel 5, the input signal on connector 2 to audio channel 6, the input signal on connector 3 to audio channel 7, and the input signal on connector 4 to audio channel 8.

To use ANALOG AUDIO OUTPUT connectors as ANALOG AUDIO INPUT connectors, XLR male-to-female adaptors are required.

### Note

The ANALOG AUDIO INPUT 3, 4 connectors do not support microphone connection.

## 3 AUDIO MONITOR R, L connectors (XLR 3-pin, male)

This outputs an audio signal for monitoring.

The monitored channel is selected with MONITR L and MONITR R on the HOME page of the function menu.

See “Basic Operations of the Function Menu” (page 39) for more information about the MONITR L and MONITR R settings.

## 3 Digital audio signal input/output section

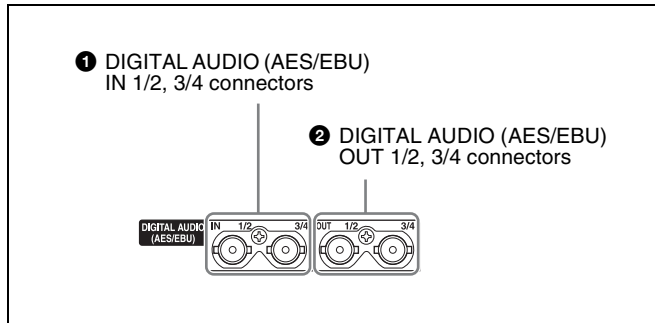

### 1 DIGITAL AUDIO (AES/EBU) IN (digital audio input) 1/2, 3/4 connectors (BNC type)

These input AES/EBU format digital audio signals.

### 2 DIGITAL AUDIO (AES/EBU) OUT (digital audio output) 1/2, 3/4 connectors (BNC type)

These output AES/EBU format digital audio signals.

To treat the input and output signals of these connectors as non-audio signals, set maintenance menu item M372 NON-AUDIO INPUT.

*For details, refer to the Service Manual.*

## 4 Timecode input/output section

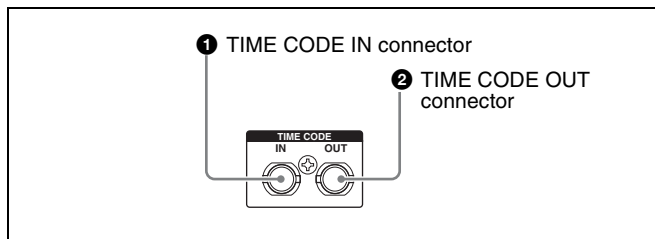

### 1 TIME CODE IN connector (BNC type)

This inputs an SMPTE timecode generated by an external device.

### 2 TIME CODE OUT connector (BNC type)

This outputs the following timecode, depending on the operating state of this unit.

**During playback:** Playback timecode

**During recording:** The timecode from the internal timecode generator or the timecode input to the TIME CODE IN connector

## Preparing Power Sources

This unit can be powered by AC power, DC power, or a battery pack.

For safety, use only the Sony battery packs listed below.  
Lithium-ion battery pack: BP-L80S

### Note

If you load or remove a battery pack incorrectly, it may fall and cause bodily injury. Follow the procedures described below to load or remove them.

## Supplying power

### AC power supply

Connect the AC IN connector to an AC power source using the specified AC power cord. To supply AC power to the unit, set the POWER switch on the rear panel to **I** (on), then press the on/standby button (⏻) on the front panel and hold it down for a short time (0.25 seconds or longer).

### DC power supply

Connect the DC IN 12V connector to a DC power source. To supply DC power to the unit, turn off the POWER switch on the rear panel, then press the on/standby button (⏻) on the front panel and hold it down for a short time (0.25 seconds or longer). If the POWER switch on the rear panel is set to **I** (on), AC power is supplied.

### Battery power supply

You can use the BP-L80S Battery Pack with this unit. To use the battery pack, a BKP-L551 Battery Adaptor and a dedicated battery charger are also required.

### Continuous recording time at room temperature

BP-L80S lithium-ion battery pack: Approx. 60 minutes (MPEG HD422 format)

*For details on charging battery packs, refer to the operation manual for the battery charger.*

### Notes about battery usage

- As long as a battery is connected to the unit, electric current flows in the unit to keep the CPU in the standby state, when the unit is not turned on. If the unit is not used for an extended period, remove the battery.
- Before using the batteries, be sure to charge them fully with the special battery charger. Refer to the operating instructions for your battery charger for more information about how to charge the batteries.
- Batteries may not be completely charged if you charge them immediately after use when they are still warm. You should wait until the batteries cool before charging them.

## Attaching a battery pack

Use the BKP-L551 in the following way to attach and remove the BP-L80S Battery Pack.

*For details on attaching the BKP-L551, refer to the installation manual for the BKP-L551.*

### WARNING

Batteries shall not be exposed to excessive heat such as sunshine, fire or the like.

### CAUTION

Danger of explosion if battery is incorrectly replaced. Replace only with the same or equivalent type recommended by the manufacturer. When you dispose of the battery, you must obey the law in the relative area or country.



- 1 Attach the BKP-L551 to the side panel.

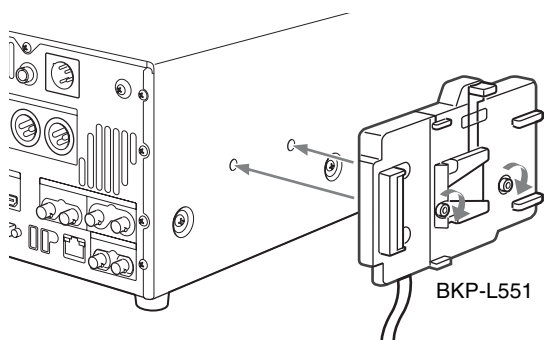

- 2 Align the grooves on the BP-L80S with the projections on the BKP-L551.

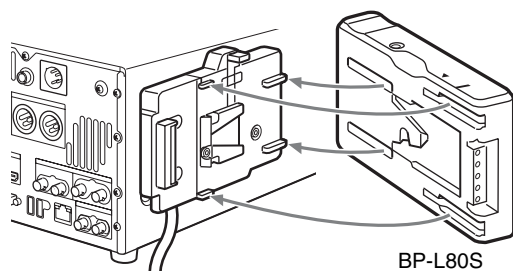

- 3 Slide the BP-L80S as shown below so that the connectors on the BP-L80S and the BKP-L551 are connected.

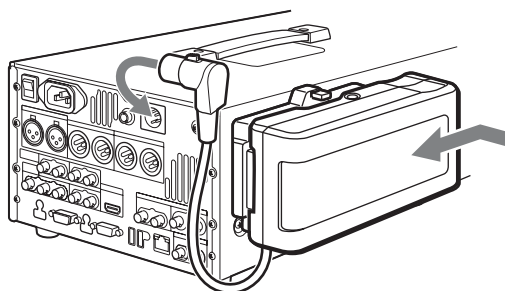

- 4 Connect the DC cable of the BKP-L551 to the DC IN 12V connector.

## Removing the battery pack

With the lever pushed in, slide the BP-L80S out as shown below.

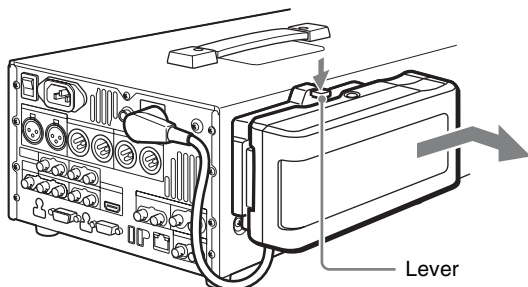

## Checking the remaining battery power

You can use the LEDs on the side panel of the battery to check the remaining power of the battery.

When the remaining battery power decreases substantially and the voltage approaches the set shutdown voltage, the power source icon starts flashing in the status display area of the display screen (the battery near end alarm is given).



# Initial Setup

This unit is shipped with the system frequency, and current date and time still unset.

Therefore, you need to make initial setup settings before using the unit. (You cannot use the unit without setting it up.)

Once the unit has been set up, the settings are retained even when the unit is powered off.

Use the following procedures.

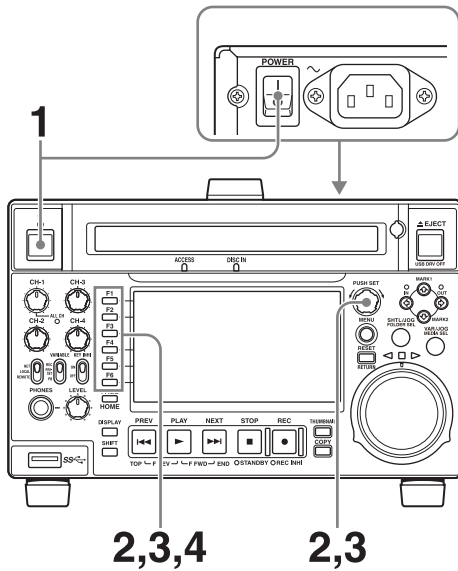

- 1** Power the unit on.  
The INITIAL SETUP screen appears on the display.
- 2** Turn the PUSH SET knob to select the area of use.

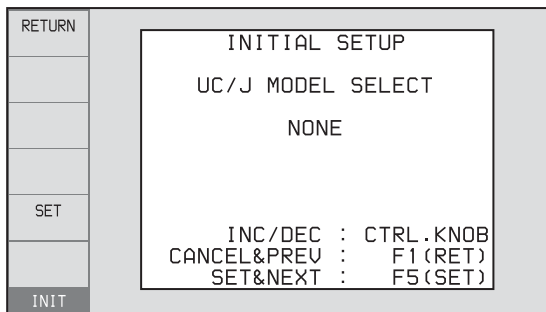

Display UC (for regions outside Japan) or J (for Japan), and then press the SET function button (F5). The system frequency screen appears.

- 3** Turn the PUSH SET knob to select the system frequency.

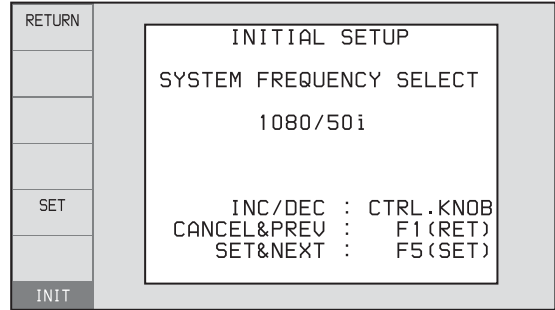

Display the system frequency that you want to use, and then press the SET function button (F5).

- 4** If you want to save the settings made up to this point, press the SET function button (F5) again.

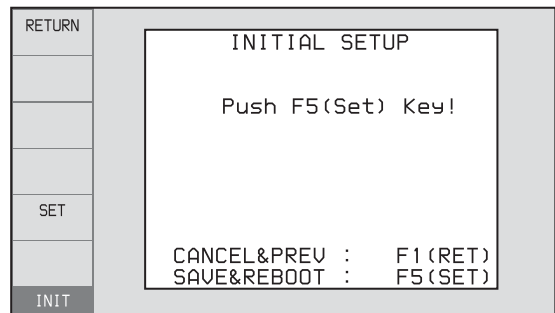

The message “NOW SAVING...” appears, and the setting screen disappears. Then the unit powers itself off and on again.

## To return to the original screen without saving settings

Press the RETURN function button (F1).

## To set the date and time

Set maintenance menu item M3D DATE/TIME PRESET.

*For details, refer to the Service Manual.*

## Front Panel Tilt Mechanism

The front panel of this unit has a tilt mechanism that allows you to pull the front panel out and adjust it to a convenient angle.

### To pull the front panel out

Grasp the holds (small protrusions) on both sides of the front panel and pull out as indicated by the arrow.

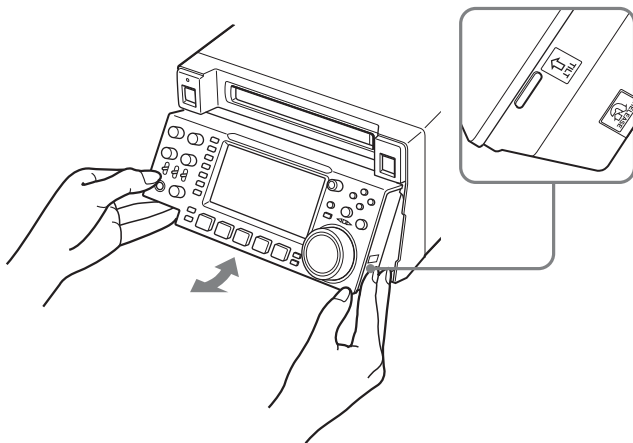

You can fix the angle of the front panel in position 1 (15 degrees) or position 2 (40 degrees).

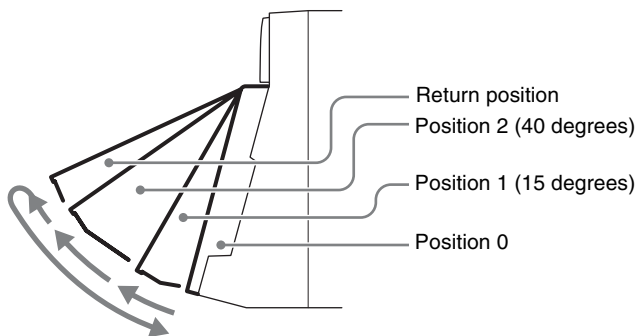

#### Note

The angle cannot be fixed if you pull the front panel past position 2 all the way out to the return position. To fix the front panel, return it to position 0 and then pull it out to position 1 or position 2.

### To return the front panel to its original position

Unlock the front panel by pulling it out to the return position. You can then return it to position 0.

### To change the angle of the front panel

To change the angle to position 2 from position 1, pull the front panel out to position 2.

To change the angle to position 1 from position 2, first unlock the front panel by pulling it all the way out to the return position. Then return it to position 0, and pull out again to position 1.

# Connections and Settings

## Note

Production of some of the peripherals and related devices described in this chapter may have been discontinued. For advice about choosing devices, please contact your Sony dealer or a Sony representative.

## Connections for Content Browser and non-Sony nonlinear editors

When using Content Browser, you can gain remote access to this unit from a network connected computer. You can also access this unit from a nonlinear editor that is not a Sony product via FTP/CIFS, and use this unit as a material server.

*For an overview and installation of Content Browser, access the Sony website closest to your area.*

## Using the (network) connector (FTP connection)

The following shows an example of an FTP (File Transfer Protocol) connection.

## Note

The PDW-HD1550 IP address and other network-related settings are required for connection.

*For details of the network-related settings, refer to the Service Manual.*

## Connecting a PDW-HD1550 unit directly to a laptop computer

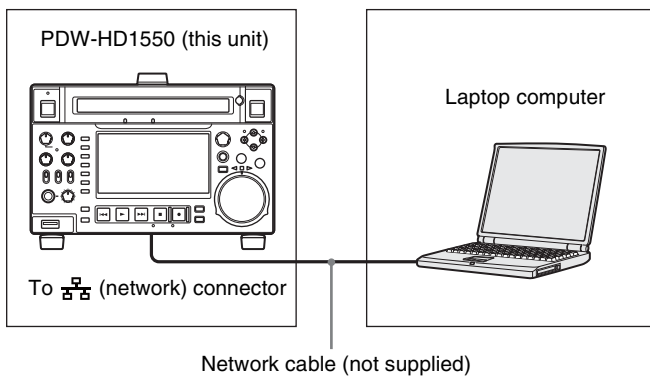

### Settings on this unit

Remote control switch: NET (see page 11)

Setup menu item 257 NETWORK ENABLE: network

## Connecting three PDW-HD1550 units to a laptop computer via a LAN

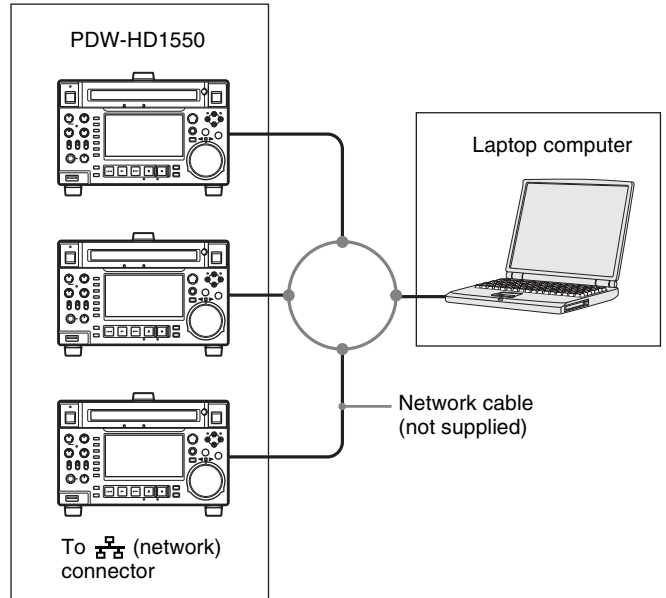

## CAUTION

When you connect the network cable of the unit to peripheral device, use a shielded-type cable to prevent malfunction due to radiation noise.

### Settings on all PDW-HD1550 units

Remote control switch: NET (see page 11)

Setup menu item 257 NETWORK ENABLE: network

# Connections for cut editing

The following figure shows a cut editing system comprising this unit as a player.

When making the connections, also refer to the manuals provided with the equipment to be connected.

See page 29 for more information about editing control unit settings.

## When using an editing control unit

### Using BVE-700/700A

The following figure shows a cut editing system comprising this unit as a player, an HDW-M2000/M2000P unit as a recorder, and a BVE-700/700A as an editing control unit.

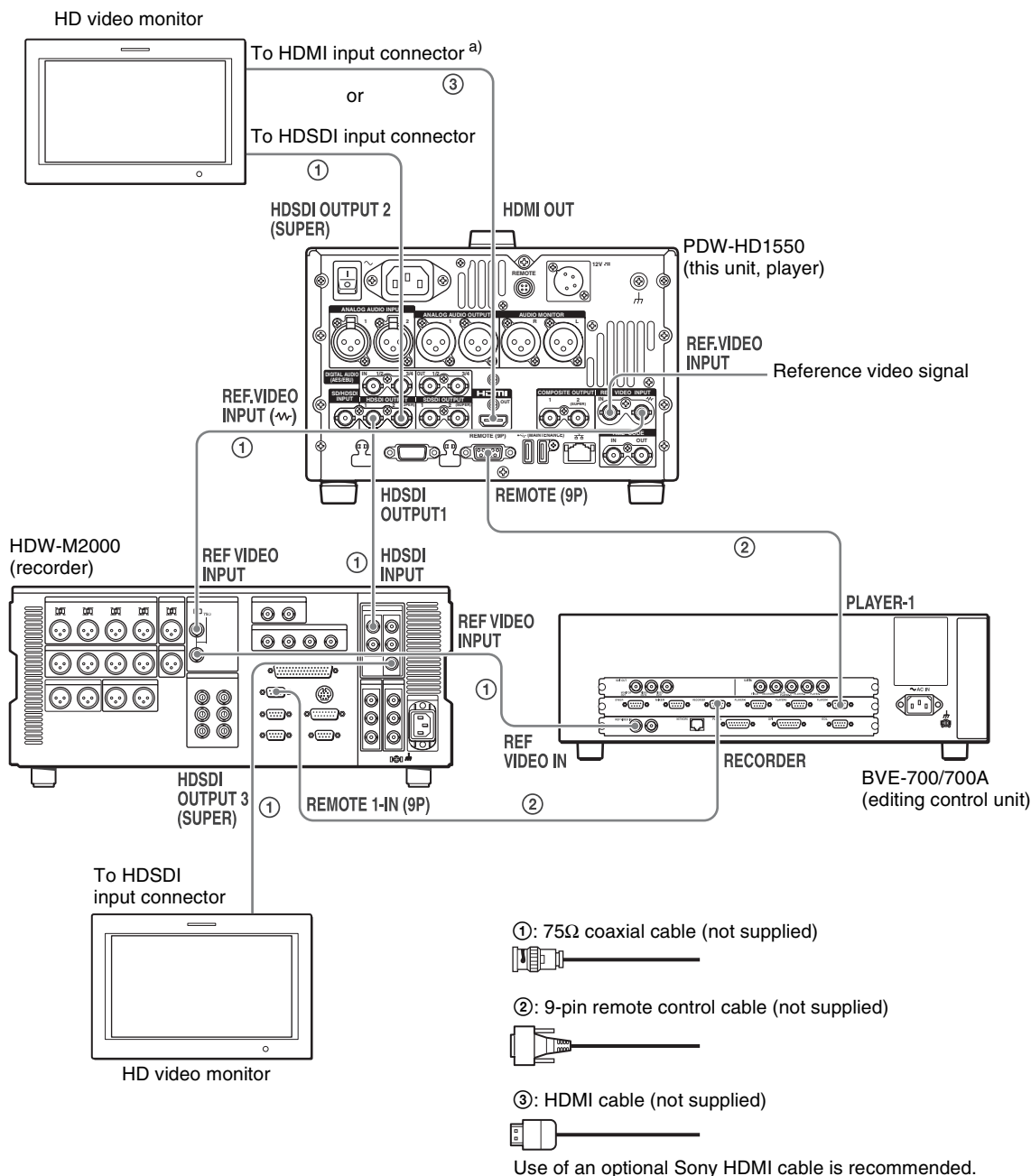

a) You can use setup menu item 161 (see page 90) to set which signal to output from the HDMI OUT connector: the same signal as the HDSDI OUTPUT 2 (SUPER) connector output, or the HDSDI signal and thumbnails view signal by automatically switching between them.

HDW-M2000 (recorder) settings	BVE-700/700A (editing control unit) setting	Settings on this unit
REMOTE 1 (9P) button: Lit	SYNCHRONIZE menu: OFF	Remote control switch: REMOTE (see page 11)
REF.VIDEO INPUT connector 75 Ω termination switch: OFF		Setup menu item 214 REMOTE INTERFACE: 9PIN
Audio selection function switching button INPUT button: HDSDI		
Function menu HOME >F1 (VID. IN): SDI		
Function menu page 1 >F1 (TCG): INT		
Function menu page 1 >F2 (PR/RGN): PRESET		
Function menu page 1 >F3 (RUN): FREE		

### Editing control unit settings

When connecting an editing control unit (BVE-700/700A/2000) to use with this unit, set VTR constants as follows.

System frequency	VTR constant															
	1	2	3	4	5	6	7	8	9	10	11	12	13	14	15	16
59.94i/59.94P/29.97P	A0	9C	00	96	07	07	03	80	0A	07	FE	00	80	5A	FF	5A
50i/50P/25P	A1	9C	00	7D	07	07	03	80	0A	07	FE	00	80	4C	FF	4B
23.98P	A2	9C	00	78	07	07	03	80	0A	07	FE	00	80	48	FF	48

## Using RM-280

The following figure shows a cut editing system comprising this unit as a player, a PDW-F1600 unit as a recorder, and an RM-280 as an editing controller.

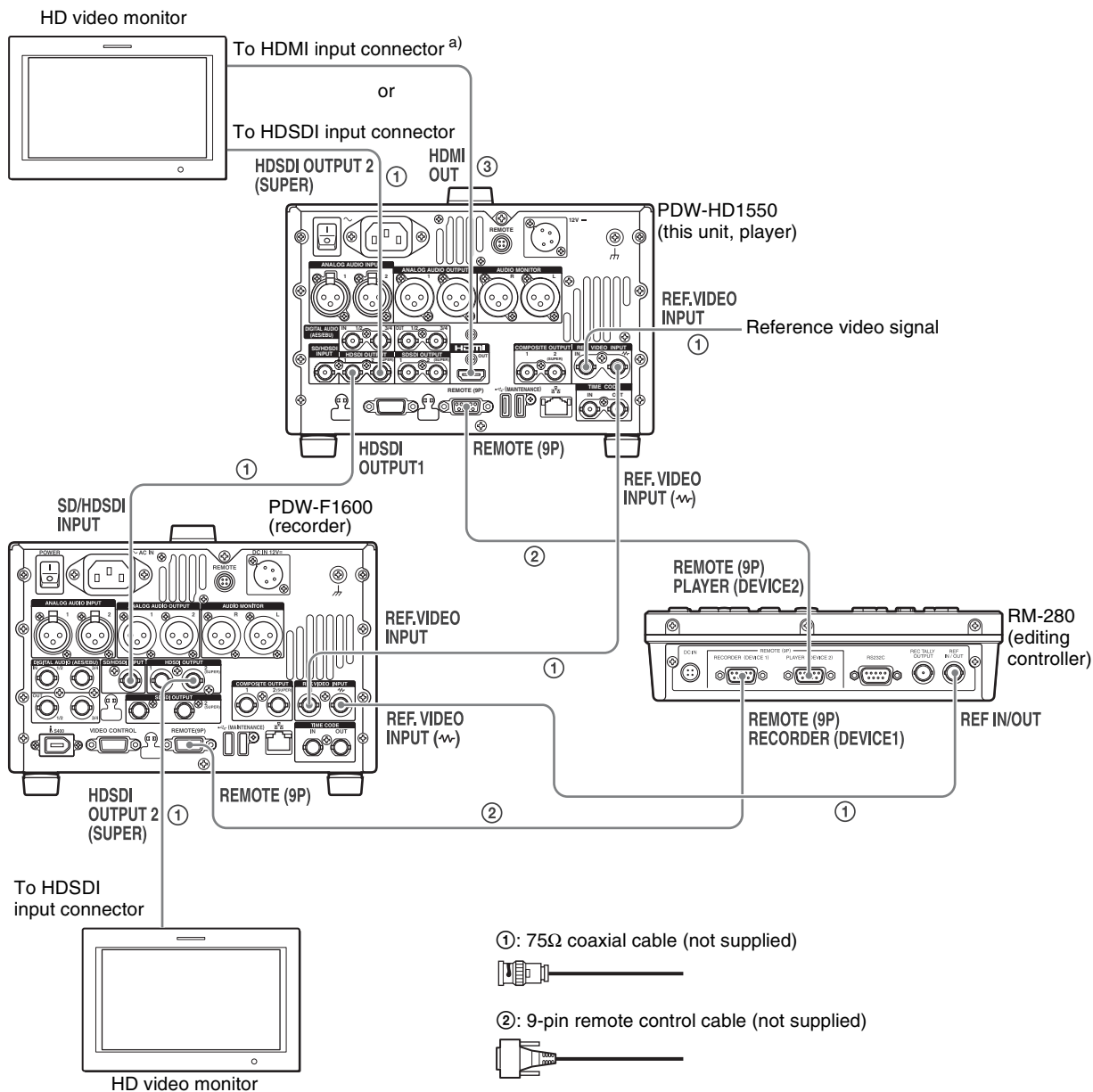

①: 75Ω coaxial cable (not supplied)



②: 9-pin remote control cable (not supplied)



③: HDMI cable (not supplied)



Use of an optional Sony HDMI cable is recommended.

a) You can use setup menu item 161 (see page 90) to set which signal to output from the HDMI OUT connector: the same signal as the HDSDI OUTPUT 2 (SUPER) connector output, or the HDSDI signal and thumbnails view signal by automatically switching between them.

PDW-F1600 (recorder) settings	RM-280 (editing controller) settings	Settings on this unit
Remote control switch: REMOTE	EDITOR/REMOTE CONTROL selector switch: EDITOR	Remote control switch: REMOTE (see page 11)
Setup menu item 214 REMOTE INTERFACE: 9PIN	Setup menu 01 PREROLL: 5s	Setup menu item 214 REMOTE INTERFACE: 9PIN
Function menu page P1 VIDEO >V INPUT: HD SDI	Setup menu 05 SYNC SEL: ON	
Function menu pages P2 and P3 AUDIO >A1 to A8 INPUT: SDI	Setup menu 06 SYNC VTR: RECORDER	
Function menu page P4 TC >TCG: INT	Setup menu 09 EDIT DLY: -7	
Function menu page P4 TC >PRST/RGN: PRESET	Setup menu 10 R ST DLY: AUTO	
Function menu page P4 TC >RUN MODE: FREE RUN	Setup menu 11 P ST DLY: AUTO	

## Using the editing functions of the recorder (controlling through REMOTE (9P) connector)

The following figure shows a cut editing system comprising this unit as a player, and an HDW-M2000/M2000P unit as a recorder. In this example, video and

audio signals are connected by HDSDI, and control signals are transferred via the REMOTE (9P) connector.

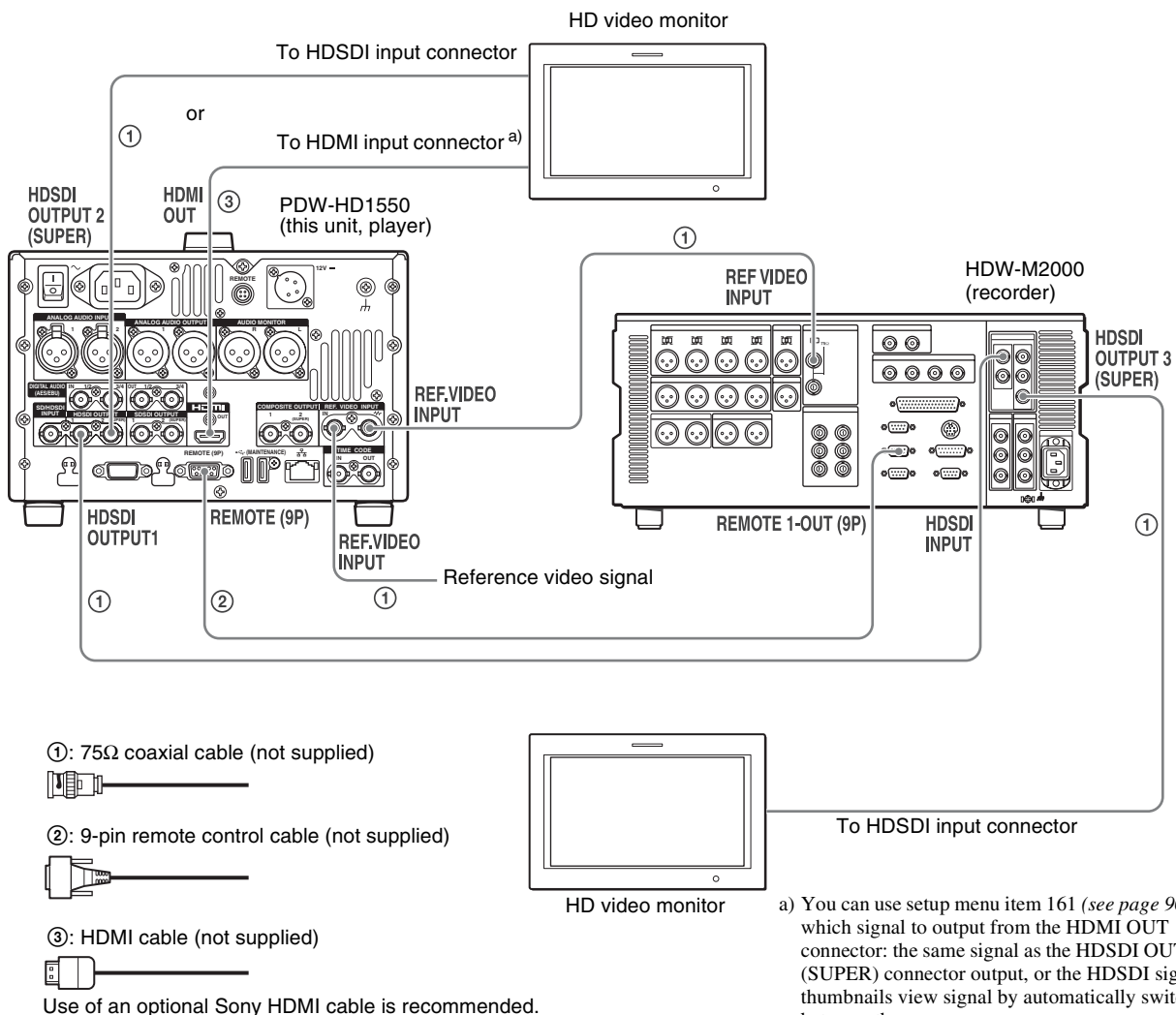

HDW-M2000 (recorder) setting	Settings on this unit
REMOTE 1 (9P) button: Unlit	Remote control switch: REMOTE (see page 11)
	Setup menu item 214 REMOTE INTERFACE: 9PIN

For details of HDW-M2000/M2000P settings, refer to the HDW-M2000/M2000P Operation Manual.

## Connections for pool coverage

The following figure shows an example of connections for pool coverage, with the PDW-700 Professional Disc Camcorder connected.

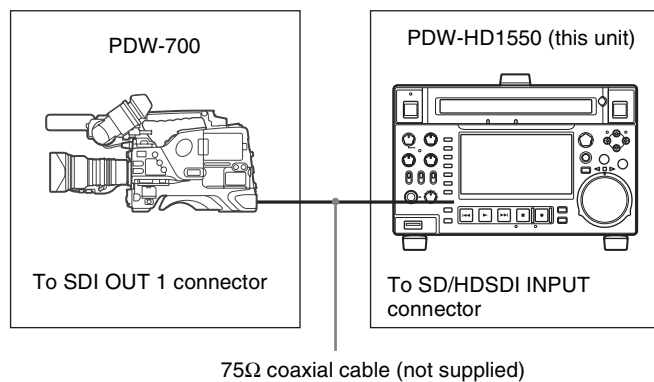

PDW-700 (camcorder) setting	Settings on this unit
HDSI REMOTE I/F on page CAM CONFIG 1 of the MAINTENANCE menu: other than OFF	Remote control switch: REMOTE (see page 11)
	Setup menu item 214 REMOTE INTERFACE: SDI



# Synchronization Reference Signals

The synchronization reference signal generator of this unit synchronizes to a reference signal input to the REF. VIDEO INPUT connector or to a video input signal. External synchronization is as follows, depending on the

setting of OUT REF on the HOME page of the function menu, and on the type of the selected input signal. Video output signals are always synchronized to the internal synchronization signal.

Input to SD/HDSDI INPUT connector <sup>a)</sup>	Input to REF. VIDEO INPUT connector	Setting of OUT REF on the HOME page <sup>b)</sup>	
		REF	INPUT
Yes	Yes	Synchronize to the signal input to the REF. VIDEO INPUT connector	Synchronize to the signal input to the SD/HDSDI INPUT connector
Yes	No	Synchronize to the signal input to the SD/HDSDI INPUT connector	
No	Yes	Synchronize to the signal input to the REF. VIDEO INPUT connector	
No	No	No external synchronization is made	

a) Same as when INT SG on page P1 INPUT of the function menu is set to "ON".

b) FTP connection always synchronizes to the internal synchronization reference signal, regardless of the setting of OUT REF.

## Synchronization reference signals when you are recording, playing, or editing 720P signals

When you are recording, playing, or editing 720P signals, set OUT REF on the HOME page of the function menu to "REF", and synchronize the synchronization reference signal generator of this unit to a reference signal input to the REF. VIDEO INPUT connector. The following reference signals can be used.

**720/59.94P system:** 1080/59.94i tri-level sync signal, 525 black burst signal

**720/50P system:** 1080/50i tri-level sync signal, 625 black burst signal

When you directly interconnect video I/O connectors between two of these units or between this unit and the XDS-1000 or PDW-F1600/HD1500/F800/700, you can record and dub 720P signals even if you set OUT REF on the HOME page of the function menu to "INPUT".

## Setting the System Frequency

This unit can record and play back video at the system frequencies of 1080/59.94i, 50i, 29.97P, 25P, 23.98P or 720/59.94P, 50P.

### Selecting the system frequency

- 1 Set setup menu item 013 SYSTEM FREQUENCY SELECT MENU to “on” and press the PUSH SET knob.

The system frequency selection screen appears.

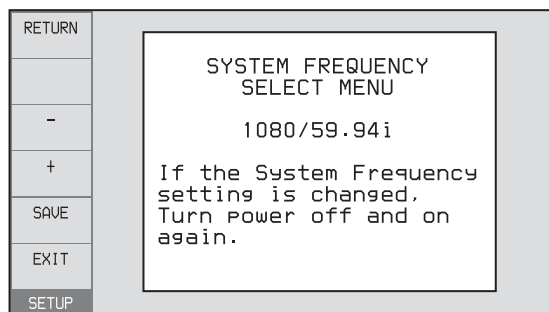

- 2 Turn the PUSH SET knob to select the system frequency to be used.

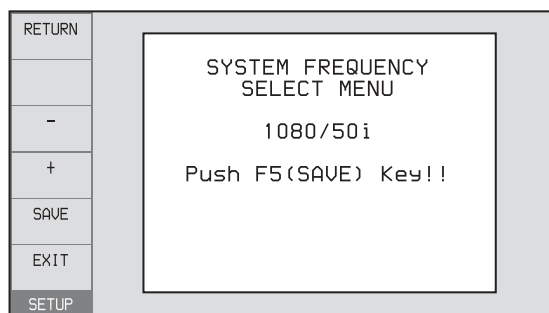

- 3 Press the SAVE function button (F5).

The message “Turn off/on POWER!!” appears.

- 4 Press the on/standby button and hold it down for one second or longer to switch the unit to standby state, then power it on again.

## Setting the Timecode

There are the following four ways of recording timecode:

**Internal Preset mode:** This records the output of the internal timecode generator, set beforehand to an initial value. The following run modes can be selected.

- Free Run: Timecode advances continuously.
- Rec Run: Timecode advances only during recording.

**Internal Regen (regenerate) mode:** This records the output of the internal timecode generator, initialized to the timecode following sequentially from the timecode of the last frame of the last clip on the disc.

**External Regen (regenerate) mode:** This records the output of the internal timecode generator, synchronized to an external timecode generator. The timecode input to any of the following connectors can be selected as the external input.

- TIME CODE IN connector: LTC
- SD/HDSDI INPUT connector: VITC and LTC

**External Preset mode:** This directly records the input of an external timecode generator. The timecode input to the TIME CODE IN connector can be selected as the external input.

### To record the timecode after setting an initial value (Internal Preset)

Proceed as follows with the function menu. To set the timecode, set TCG on page P4 TC of the function menu to “INT” and PRST/RGN to “PRESET”.

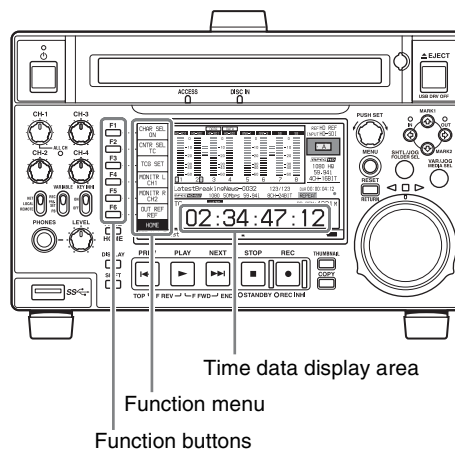

### Setting an initial timecode value

- 1 Press the CNTR SEL function button (F2) on the HOME page of the function menu, and select TC.
- 2 Press the TCG SET function button (F3).

The first digit of the time data display starts flashing.

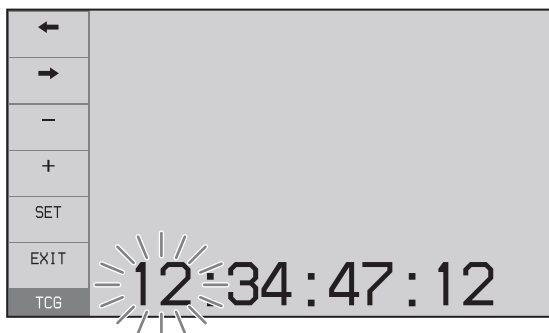

- 3 Press the ← or → function button (F1 or F2) to select a digit to be set.

The selected digit starts flashing.

- 4 Turn the PUSH SET knob or press the – or + function button (F3 or F4) to set the value for the selected digit.

#### To set the next-most significant digit (10s digit)

Turn the PUSH SET knob while holding down the SHIFT button.

Repeat steps 3 and 4 to set all digits that should be set.

#### To set to 00:00:00:00

Press the RESET/RETURN button.

- 5 Press the SET function button (F5).

If RUN MODE on page P4 TC is set to “FREE RUN”, the timecode starts running.

#### To cancel a setting

Press the EXIT function button (F6). Any new settings to that point are canceled, and the setting operation is terminated.

#### Setting the timecode to the current time

- 1 Set RUN MODE on page P4 TC to “FREE RUN” and DF/NDF to “DF” (in 59.94i/59.94P/29.97P mode only).
- 2 Perform steps 1 to 4 of “Setting an initial timecode value” (page 34) to set the timecode to a time slightly ahead of the current time.
- 3 Press the SET function button (F5) at the instant when the current time matches the displayed timecode.

## Setting user bits

You can record up to eight hexadecimal digits of information (date, time, event number, etc.) on the timecode track.

Select UB by pressing the CNTR SEL function button (F2) in step 1 of “Setting an initial timecode value” (page 34) and carry out steps 2 to 5. Settings are made in hexadecimal (0-9, A-F).

You can record ID codes in user bits.

## To record the timecode that follows sequentially from the last recorded timecode (Internal Regen)

You can record the timecode so that it is continuous from one clip to the next on the disc.

Set TCG on page P4 TC of the function menu to INT, and PRST/RGN to TC or VITC. When this setting is in force, the unit reads the timecode of the last frame of the last recorded clip on the disc before starting to record, and internally generates the timecode that follows the recorded timecode.

The frame count mode (for system frequency 59.94i/59.94P/29.97P only) is set to the same mode as the last recorded timecode on the disc (drop-frame or non-drop-frame).

## To record with the internal timecode generator synchronized to external timecode (External Regen)

Use this method to synchronize the timecode generators of a number of recorders, to record the playback timecode of external VTRs, or to record while maintaining synchronization between the source video and timecode. Use either of the following procedures according to the type of external timecode.

### Synchronizing with the timecode input to the TIME CODE IN connector

- 1 Connect the timecode output of an external device to the TIME CODE IN connector, and input a reference video signal to the REF. VIDEO INPUT connector.
- 2 Make the following settings on page P4 TC of the function menu.
  - Set TCG to “EXT”.
  - Set PRST/RGN to “TC”.

### Synchronizing with the embedded LTC input to the SD/HDSDI INPUT connector

- 1 Input an SDI signal containing embedded LTC to the SD/HDSDI INPUT connector, and a reference video signal to the REF. VIDEO INPUT connector.

**2** Make the following settings on page P4 TC of the function menu.

- Set TCG to “SDI”.
- Set PRST/RGN to “TC”.

Executing either of these procedures starts the internal timecode generator running in synchronization with the external timecode generator.

Once the internal timecode generator is synchronized with the external timecode generator, the internal timecode generator continues to run even if the external timecode generator connection is removed.

The timecode advance mode is set automatically to Free Run. The frame count mode (for system frequency 59.94i/59.94P/29.97P only) is set to the same mode as the external timecode signal (drop-frame or non-drop-frame).

### To check the synchronization to the external signal

Press the STOP button to stop this unit, then press the REC button.

Check that the timecode value shown in the time data display coincides with the external timecode value.

### To record an external timecode directly (External Preset)

When you use this method, the internal timecode generator advances without being affected by the external timecode.

### To directly record the timecode input to the TIME CODE IN connector

Input the timecode output of an external device to the TIME CODE IN connector, and make the following settings on page P4 TC of the function menu.

- Set TCG to “EXT”.
- Set PRST/RGN to “PRESET”.

## Superimposed Text Information

The video signal output from the COMPOSITE OUTPUT 2 (SUPER) connector, SDDS DI OUTPUT 2 (SUPER) connector, HDS DI OUTPUT 2 (SUPER) connector, and HDMI OUT connector contains superimposed text information, including the timecode.

### Adjusting the text display

You can adjust the position, size and type of the superimposed text using setup menu items 002, 003, 005, 009, 011, and 012.

For details, see “Items in the basic menu” (page 83).

### Information displayed

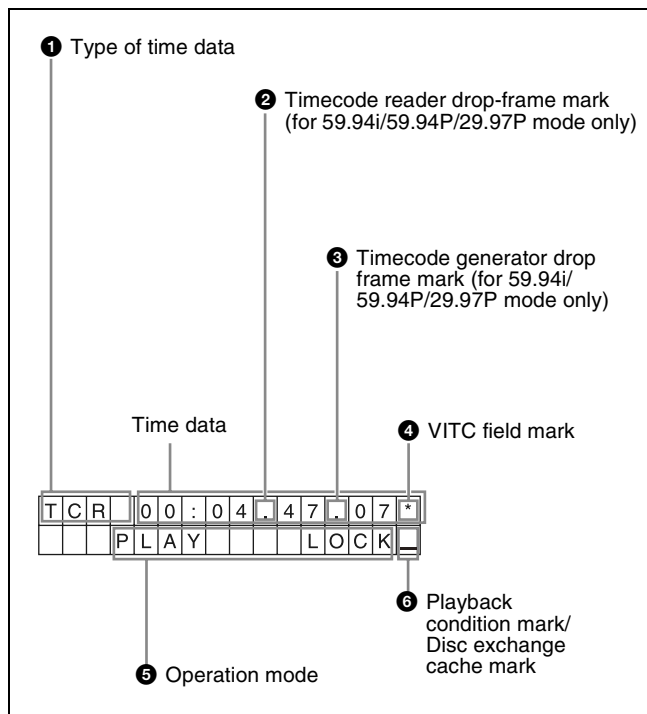

### Note

The display shown above corresponds to the factory default settings of the unit. You can change the type of information to be displayed in the lower line of the display by changing the setting of setup menu item 005 DISPLAY INFORMATION SELECT.

For details, see “Items in the basic menu” (page 83).

**1 Type of time data**

Display	Meaning
CNT	Counter data
TCR	TC reader timecode
UBR	TC reader user bits data
TCR.	VITC reader timecode
UBR.	VITC reader user bits data
TCG	TC generator timecode
UBG	TC generator user bits data

**Note**

If the time data or user bits data cannot be read correctly, they will be displayed with an asterisk. For example, “T\*R”, “U\*R”, “T\*R.” or “U\*R.”.

**2 Timecode reader drop-frame mark (for 59.94i/59.94P/29.97P mode only)**

“.”: Indicates drop-frame mode.

“.”: Indicates non-drop-frame mode.

**3 Timecode generator drop-frame mark (for 59.94i/59.94P/29.97P mode only)**

“.”: Indicates drop-frame mode (factory default setting).

“.”: Indicates non-drop-frame mode.

**4 VITC field mark**

“ ” (blank): Fields 1 and 3 (for 59.94i/59.94P/29.97P/23.98P mode) or fields 1, 3, 5 and 7 (for 50i/50P/25P mode)

“\*”: Fields 2 and 4 (for 59.94i/59.94P/29.97P/23.98P mode) or fields 2, 4, 6 and 8 (for 50i/50P/25P mode)

**5 Operation mode**

The field is divided into two blocks as shown below.

- Block A displays the operation mode.
- Block B displays the servo lock status or playback speed.

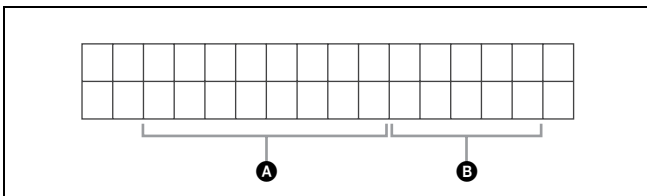

Display		Operation mode
Block A	Block B	
STOP		Stop mode
NEXT xxx		Cuing up the first frame of the next clip.
PREV xxx		Cuing up the first frame of the current clip.
F.FWD		Fast forward search
F.REV		Fast reverse search

Display		Operation mode
Block A	Block B	
PLAY		Playback mode (servo unlocked)
PLAY	LOCK	Playback mode (servo locked)
REC		Record mode (servo unlocked)
REC	LOCK	Record mode (servo locked)
JOG	STILL	A still picture in jog mode
JOG	FWD	Jog mode in forward direction
JOG	REV	Jog mode in reverse direction
SHUTTLE	STILL	A still picture in shuttle mode
SHUTTLE	(Speed)	Shuttle mode
VAR	STILL	A still picture in variable mode
VAR	(Speed)	Variable mode
TOP 0001/xxxx		Cuing up the first frame of the first clip.
END xxxx/xxxx		Cuing up the last frame of the last clip.
PREROLL		Cuing up during thumbnail search
COPY		Transcode copy is executing.
CLOSE		A clip is not selected.
MEDIA OUT		No disc is loaded.
LOADING		Disc is loading.
UNLOADING		Disc is unloading.
STANDBY OFF		Standby state

**6 Playback condition mark/Disc exchange cache mark**

One of three channel condition marks is displayed when the ACCESS indicator is lit during any mode except recording. The “C” indicator appears here when the disc exchange cache function is operating.

Display	Name	Description
—	Green condition	There is no problem with the playback condition. This unit and the disc can be used just as they are. This corresponds to the “green” channel condition indicator of a VTR.
=	Yellow condition	The playback condition has deteriorated to some degree. There are no read errors, but you should take the action described in the next section. This corresponds to the “yellow” channel condition indicator of a VTR.
≡	Red condition	The playback condition has deteriorated. There are no read errors, <sup>a)</sup> but you should take the action described in the next section. This corresponds to the “red” channel condition indicator of a VTR.

Display	Name	Description
C	Disc exchange cache	This appears during cache recording. <i>For details, see page 49.</i>

a) Read errors will occur if the playback condition continues to deteriorate. If a read error occurs, a “Disc Error!” alarm appears in the time data display, the picture freezes, and audio is muted.

To display playback condition marks, set setup menu item 012 CONDITION DISPLAY ON VIDEO MONITOR to “enable”, and set setup menu item 005 DISPLAY INFORMATION SELECT to “time data & status”.

*For details about operation, see “Basic menu operations” (page 86).*

## Playback condition display functions

You can be alerted in advance to deteriorating playback conditions and to error correction rates which are approaching their limits.

Deteriorating playback may be due to the following causes.

- Scratches and dust on the disc surface  
This includes fingerprints, dust from the air, tar from cigarette smoke, and so on.  
Scratches and soiling which occur before recording are not a problem because they are registered in advance as defects, and recording avoids them. However, scratches and soiling which occur after recording can lead to deteriorating playback conditions.
- Aging of disc recording layers  
Over several decades, the recording layers of optical discs can age and cause deteriorating playback conditions.  
You can use this function to check archival discs and other discs which have been stored for extended periods, so that you can take action before the deterioration progresses further.
- Deteriorating laser diode performance  
The performance of the laser diodes used in optical heads can worsen with age, leading to deteriorating playback conditions.

*For details, see “Operating hours meter” (page 102) about this setting.*

*Refer to the Service Manual for an approximate guide to when it is time to replace optical heads.*

## To prevent playback conditions from deteriorating

Pay attention to the following points when handling discs.

- Do not open disc cartridges and touch discs directly with your hands.
- Do not store for long periods in locations which are dusty or exposed to air circulated by fans.

- Do not store for long periods under high temperatures or in locations exposed to direct sunlight.

## If playback conditions have deteriorated

If a yellow or red playback condition mark appears, the condition is recorded as an error log. Check the following points.

**Whether the disc displays the same playback condition on other XDCAM devices:** If so, the surface of the disc may be dirty or scratched, or the performance of the recording layers on the disc may have worsened due to age. Do not use discs with these symptoms.

**Whether every disc inserted into an XDCAM device displays the same playback conditions:** If so, the performance of the laser diodes may have deteriorated. Check the total optical output time.

*For details, refer to the Service Manual.*

# Basic Operations of the Function Menu

The function menu provides access to frequently used settings, such as input video signal selection and timecode settings.

Menu settings are stored in nonvolatile memory and are preserved even after the unit is powered off.

## Function menu operations

The function menu appears on the display of this unit. The following figure shows the buttons (F1 to F6 beginning at the top) used in function menu operations.

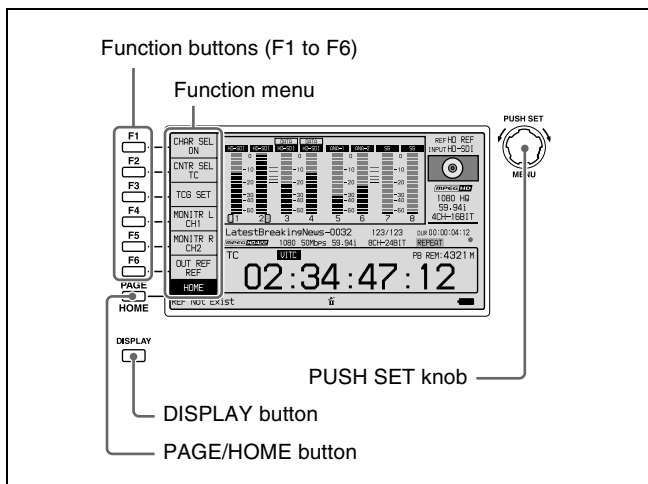

### To display the function menu

The function menu is made up of the HOME page and pages P1 to P6.

If the function menu is not already visible, press the PAGE/HOME button to display it. (The most recently accessed function menu page appears.)

### To display a different page

Each press of the PAGE/HOME button displays the next function menu page in the order: HOME → P1 → P2 → P3 → P4 → P5 → P6 → HOME...

- Turning the PUSH SET knob while holding down the PAGE/HOME button changes the page forward or backward.
- Pressing F1 to F6 buttons while holding down the PAGE/HOME button switches the page directly to pages P1 to P6.

### To clear the function menu from the screen

Press the DISPLAY button to switch to the video monitor display.

## To change the setting of a function menu item

Use the function buttons.

### To select the value of the setting item

Press the button to the left of each setting item to change the value of the item. Keep pressing the button until the value you want appears.

### To set the value of the setting item

- Press the button to the left of each setting item so that the setting value flashes to enable adjustment of the value and then turn the PUSH SET knob to increase or decrease the value.
- Turning the PUSH SET knob while holding down the SHIFT button increases the increment of adjustment.
- Pressing the button to the left of each setting item while the setting value is flashing causes the value to stop flashing and completes the adjustment.

## Function menu settings

The following tables list the setting items on each page and describe their setting values. Underlined values are the factory defaults.

### HOME page

Item	Setting
F1: CHAR SEL	Turns the display of character information on the video monitor screen and on an external monitor on and off. <b>ON</b> : Character information on <b>OFF</b> : Character information off
F2: CNTR SEL	Selects the type of time data to display in the time data display area. <b>TC</b> : Timecode <b>COUNTER</b> : Elapsed recording or playback time <b>UB</b> : User bits
F3: TCG SET/UBG SET	<ul style="list-style-type: none"> <li>• When CNTR SEL is set to "TC" or "COUNTER", the "TCG SET" indicator appears, and pressing the button displays a screen where you can set the initial value of timecode generated by the internal timecode generator <sup>a)</sup> (see page 34).</li> <li>• When CNTR SEL is set to "UB", the "UBG SET" indicator appears, and pressing the button displays a screen where you can set the user bits of timecode <sup>a)</sup> (see page 35).</li> </ul>
F4: MONITR L	Selects the channel to monitor as the left monitor channel. <b>CH1, CH2, CH3, CH4, CH5, CH6, CH7, CH8</b> <b>CH1/2, CH3/4, CH5/6, CH7/8 (MIX)</b>

Item	Setting
F5: MONITR R	Selects the channel to monitor as the right monitor channel. <b>CH1, CH2, CH3, CH4, CH5, CH6, CH7, CH8</b> <b>CH1/2, CH3/4, CH5/6, CH7/8 (MIX)</b>
F6: OUT REF	Selects the reference signal for the output signals of this unit. <b>REF:</b> Use the signal input to the REF. VIDEO INPUT connector as the output reference signal. <b>INPUT:</b> Use the input video signal as the output reference signal.

a) This is displayed only when TCG on page P4 TC of the function menu is set to "INT", and PRST/RGN is set to "PRESET".

## P1 INPUT page

Item	Setting
F1: INT SG	Sets whether to select test signal from internal signal generator. <b>OFF:</b> Do not select. <b>ON:</b> Select.
F2: V INPUT	Selects the video input signal. <b>HSDSI:</b> HSDSI signal <b>SDSDI:</b> SDSDI signal <b>Notes</b> <ul style="list-style-type: none"> <li>• Test signal is input when INT SG on this page is set to "ON" and setup menu item 710 is set to anything other than "Off".</li> <li>• When the system frequency is 23.98P, the setting is fixed "HSDSI".</li> </ul>
F3: A1 INPUT	Selects the audio input signal to assign to audio channel 1. <b>SDI:</b> Audio signal embedded in the SDI signal <b>ANALOG1(MIC1):</b> Input signal to the ANALOG AUDIO INPUT 1 connector <b>AES/EBU1:</b> Input signal to the DIGITAL AUDIO (AES/EBU) IN 1/2 connectors <b>Note</b> Test signals are input to all audio channels 1 to 8 when INT SG on this page is set to "ON" and setup menu item 808 is set to anything other than "off".
F4: A2 INPUT	Selects the audio input signal to assign to audio channel 2. <b>SDI:</b> Audio signal embedded in the SDI signal <b>ANALOG2(MIC2):</b> Input signal to the ANALOG AUDIO INPUT 2 connector <b>AES/EBU2:</b> Input signal to the DIGITAL AUDIO (AES/EBU) IN 1/2 connectors
F5: A3 INPUT	Selects the audio input signal to assign to audio channel 3. <b>SDI:</b> Audio signal embedded in the SDI signal <b>ANALOG1(MIC1):</b> Input signal to the ANALOG AUDIO INPUT 1 connector <b>ANALOG3:</b> Input signal to the ANALOG AUDIO INPUT 3 connector <sup>a)</sup> <b>AES/EBU3:</b> Input signal to the DIGITAL AUDIO (AES/EBU) IN 3/4 connectors

Item	Setting
F6: A4 INPUT	Selects the audio input signal to assign to audio channel 4. <b>SDI:</b> Audio signal embedded in the SDI signal <b>ANALOG2(MIC2):</b> Input signal to the ANALOG AUDIO INPUT 2 connector <b>ANALOG4:</b> Input signal to the ANALOG AUDIO INPUT 4 connector <sup>a)</sup> <b>AES/EBU4:</b> Input signal to the DIGITAL AUDIO (AES/EBU) IN 3/4 connectors

a) Selectable when maintenance menu item M374 ANALOG I/O is set to "4ch" only.

## P2 INPUT page

Item	Setting
F1: A5 INPUT	Selects the audio input signal to assign to audio channel 5. <b>SDI:</b> Audio signal embedded in the SDI signal <b>ANALOG1(MIC1):</b> Input signal to the ANALOG AUDIO INPUT 1 connector <b>AES/EBU1:</b> Input signal to the DIGITAL AUDIO (AES/EBU) IN 1/2 connectors
F2: A6 INPUT	Selects the audio input signal to assign to audio channel 6. <b>SDI:</b> Audio signal embedded in the SDI signal <b>ANALOG2(MIC2):</b> Input signal to the ANALOG AUDIO INPUT 2 connector <b>AES/EBU2:</b> Signal input to the DIGITAL AUDIO (AES/EBU) IN 1/2 connectors
F3: A7 INPUT	Selects the audio input signal to assign to audio channel 7. <b>SDI:</b> Audio signal embedded in the SDI signal <b>ANALOG1(MIC1):</b> Input signal to the ANALOG AUDIO INPUT 1 connector <b>ANALOG3:</b> Input signal to the ANALOG AUDIO INPUT 3 connector <sup>a)</sup> <b>AES/EBU3:</b> Input signal to the DIGITAL AUDIO (AES/EBU) IN 3/4 connectors
F4: A8 INPUT	Selects the audio input signal to assign to audio channel 8. <b>SDI:</b> Audio signal embedded in the SDI signal <b>ANALOG2(MIC2):</b> Input signal to the ANALOG AUDIO INPUT 2 connector <b>ANALOG4:</b> Input signal to the ANALOG AUDIO INPUT 4 connector <sup>a)</sup> <b>AES/EBU4:</b> Input signal to the DIGITAL AUDIO (AES/EBU) IN 3/4 connectors
F5: SPEAKER	Sets whether or not the built-in speakers produce output. <b>OFF:</b> Not produce output. <b>ON:</b> Produce output.
F6: –	(Unassigned function button)

a) Selectable when maintenance menu item M374 ANALOG I/O is set to "4ch" only.



### P3 AUDIO page

Item	Setting
F1: A5 VOL	Sets the volume of audio channel 5. <sup>a)</sup> The volume can be adjusted within the range from <b>-200 to 0 to +200</b> ( <b>-∞ to +12 dB</b> ) by turning the PUSH SET knob. The volume changes in steps of ±10 if you hold the SHIFT button down while you turn the knob.
F2: A6 VOL	Sets the volume of audio channel 6. <sup>a)</sup> The volume can be adjusted within the range from <b>-200 to 0 to +200</b> ( <b>-∞ to +12 dB</b> ) by turning the PUSH SET knob. The volume changes in steps of ±10 if you hold the SHIFT button down while you turn the knob.
F3: A7 VOL	Sets the volume of audio channel 7. <sup>a)</sup> The volume can be adjusted within the range from <b>-200 to 0 to +200</b> ( <b>-∞ to +12 dB</b> ) by turning the PUSH SET knob. The volume changes in steps of ±10 if you hold the SHIFT button down while you turn the knob.
F4: A8 VOL	Sets the volume of audio channel 8. <sup>a)</sup> The volume can be adjusted within the range from <b>-200 to 0 to +200</b> ( <b>-∞ to +12 dB</b> ) by turning the PUSH SET knob. The volume changes in steps of ±10 if you hold the SHIFT button down while you turn the knob.
F5: AU METER	Selects the display mode of the audio level meters. <b>FULL</b> : Display the range from -60 dB to 0 dB. <b>FINE</b> : Display a magnified section with 0.25 dB step marks.
F6: LEVEL MT	Specifies the position at which to superimpose audio level meters in the video monitor screen (in full-screen display mode). <b>OFF</b> : Do not superimpose. <b>LEFT</b> : Superimpose the audio level meters of 2 channels on the left side. <b>RIGHT</b> : Superimpose the audio level meters of 2 channels on the right side. <b>LEFT(4)</b> : Superimpose the audio level meters of 4 channels on the left side. <b>RIGHT(4)</b> : Superimpose the audio level meters of 4 channels on the right side. <b>LEFT(8)</b> : Superimpose the audio level meters of 8 channels on the left side. <b>RIGHT(8)</b> : Superimpose the audio level meters of 8 channels on the right side.

a) To enable this setting, the following settings are also required, in the same way as for volume operations for channels 1 to 4.

- Set the VARIABLE switch of the front panel to “REC” or “PB”.
- Set setup menu item 131 AUDIO VOLUME to “each”.

### P4 TC page

Item	Setting
F1: TCG	Selects the timecode signal to which the internal timecode generator synchronizes. <b>INT</b> : Follow the initial value set from the front panel or remotely from the device connected to the REMOTE (9P) connector. <b>EXT</b> : Synchronize to external timecode signal input to the TIME CODE IN connector. <b>SDI</b> : Synchronize to timecode embedded in the HDSDI or SDSDI signal input to the SD/HDSDI INPUT connector.
F2: PRST/RGN	Selects the following for the internal timecode generator. <b>PRESET</b> : Presets an initial value for the timecode generated by the internal timecode generator, as specified from the front panel or remotely from the device connected to the REMOTE (9P) connector. <b>TC</b> : Generate timecode synchronized to timecode read by the internal timecode reader. <b>VITC</b> : Generate timecode synchronized to VITC read by the internal timecode reader.
F3: RUN MODE	Selects the timecode run mode. <b>FREE RUN</b> : Timecode advances as long as the unit is powered on, regardless of the unit’s operating state. <b>REC RUN</b> : Timecode advances only during recording. When you select this item, also set F1: TCG on this page to “INT” and set F2: PRST/RGN to “PRESET”.
F4: DF/NDF	Selects the frame count mode for the internal timecode generator and the counter in 59.94i/59.94P/29.97P mode. <b>DF</b> : Drop-frame mode <b>NDF</b> : Non-drop-frame mode
F5: PDPSET	When the system frequency is set to 1080/59.94i, 1080/29.97P, or 720/59.94P, presets the timecode of the A frame of the pulldown sequence. <b>24F TC</b> : Reference timecode for A frame <b>30F TC</b> : Timecode after pulldown conversion from 24-frame timecode
F6: TCR	Selects the type of timecode to display in the time data display area. <b>TC</b> : Display TC. <b>VITC</b> : Display VITC.

### P5 OTHER page

Item	Setting
F1: INDEX	Sets the index picture (thumbnail) of a clip being played back ( <i>see page 67</i> ).
F2: ERR LOG	Displays the error log screen.
F3: CREATE NEW EDL	Creates a new EDL ( <i>see page 68</i> ).

Item	Setting
F4: ADD TO CURT.EDL	Adds a sub clip to the current EDL (see page 69).
F5: PB/EE	Selects the video and audio signals that are output in stop, forward direction high-speed search, and reverse direction high-speed search modes. <sup>a)</sup> <b>PB:</b> Playback signal <b>EE:</b> EE mode signal
F6: –	(Unassigned function button)

a) The target operation mode is set using setup menu item 108 AUTO EE SELECT.

## P6 OTHER page

Item	Setting
F1: REC FRMT	Setup menu item 031 RECORDING FORMAT (see page 85).
F2: REC MODE	Setup menu item 150 REC MODE (see page 90).
F3: WIDE I/O	Setup menu item 731 WIDE MODE (see page 96).
F4: DC MODE	Setup menu item 930 DOWN CONVERTER MODE (see page 98).
F5: UC MODE	Setup menu item 950 UP CONVERTER MODE (see page 99).
F6: LOCAL FN	Setup menu item 006 LOCAL FUNCTION ENABLE (see page 84).

# Handling Discs

## Discs used for recording and playback

This unit can record and play back the following Professional Disc formats.

- PFD23A (capacity 23.3 GB)
- PFD50DLA (capacity 50.0 GB)
- PFD100TLA (capacity 100 GB)
- PFD128QLW (capacity 128 GB)

### Notes

- It is not possible to use the following discs for recording or playback:
  - Blu-ray Disc
  - Professional Disc for Data
- PFD128QLW is a quad-layer Write-Once Professional Disc (hereinafter referred to as “quad-layer WO disc”). Pay due attention to the following points.
  - Even if you delete any files written to the disc, no available storage space will be increased.
  - Reformatting the disc will not increase the available storage space.
  - Repetitive file writing will consume the recordable resource space (for writing the disc management data, etc.) on the disc. If no available recordable resource space is left on the disc, file writing may be disabled even with sufficient available storage space remaining.
  - No file can be written after the disc is finalized.
- PFD100TLA and PFD128QLW discs can be used only by XDCAM devices with the XL-QD mark (see the following illustration). They cannot be used by XDCAM devices without this mark.



Professional Disc

**XL-QD** — XL-QD mark

- Management data and other information are also included in the capacity for each disc. For information about the actual usable capacity, see “Recording/playback times” (page 113) in “Specifications”.

## Notes on handling

### Handling

The Professional Disc is housed in a cartridge, and is designed to allow handling free of risk from dust or fingerprints. However, if the cartridge is subjected to a severe shock, for example by dropping it, this can result in damage or scratching of the disc. If the disc is scratched, it may be impossible to record video/audio, or to play back the content recorded on the disc. The discs should be handled and stored carefully.

- Do not touch the surface of the disc itself within the cartridge.
- Deliberately opening the shutter may cause damage.
- Do not disassemble the cartridge.
- The supplied adhesive labels are recommended for indexing discs. Apply the label in the correct position.

### Storage

- Do not store discs where they may be subjected to direct sunlight, or in other places where the temperature or humidity is high.
- Do not leave cartridges where dust may get inside.
- Store cartridges in their cases.

### Care of the discs

- Remove dust and dirt on the outside of a cartridge using a soft dry cloth.
- If condensation forms, allow ample time to dry before use.

## Write-protecting discs

To protect the content recorded on the disc from accidental erasure, move the Write Inhibit tab near the bottom (opposite side to the label surface) of the disc in the direction of the arrow, as shown in the following figure.

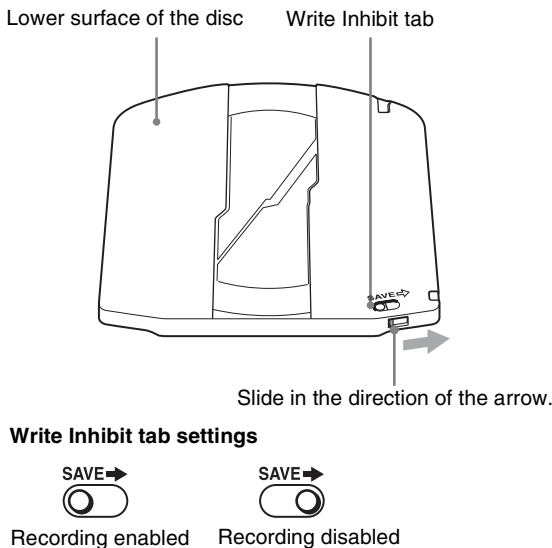

You can also write protect individual clips.

For details, see “Locking (write-protecting) clips” (page 66).

## Loading and unloading a disc

When the on/standby button indicator is lit green, you can load and unload a disc as shown in the following figure.

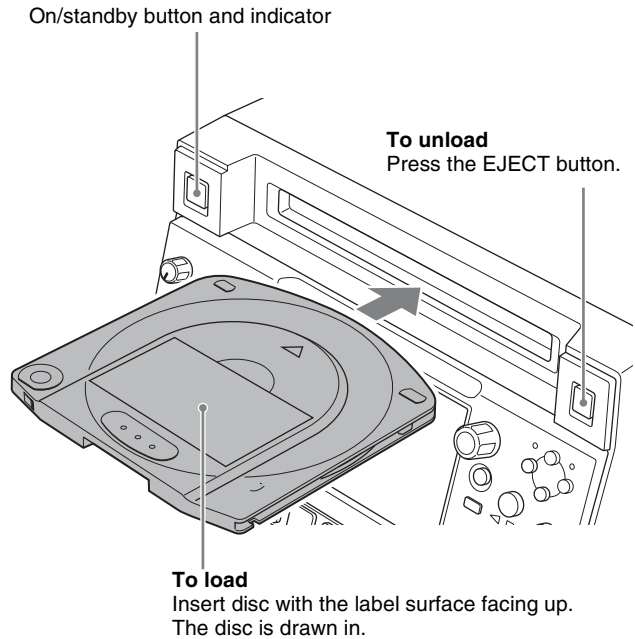

When the EJECT button is pressed during recording, recording stops and the disc is ejected. If you do not want to stop recording when the EJECT button is pressed during recording, set setup menu item 145 MODE KEY ENABLE DURING RECORDING to “stop”. The DISC IN indicator flashes while the disc is being unloaded.

## Formatting a disc

Unused discs are formatted automatically when they are loaded into this unit.

To format a recorded disc, use the Clip Menu.

For details, see “Formatting (initializing) discs” (page 71).

# Handling External Storage

You can connect a USB mass storage class device (a hard disk drive for example) to the Super Speed USB (SS ) connector (USB 3.0 compatible) on the front panel and use it as external storage for storing clips and other materials (capacity: 3 GB to 2 TB).

You can copy material on SxS memory cards to a disc by connecting the optional SBAC-US20 SxS Memory Card USB Reader/Writer.

## Note

The operation of all hard disk drives is not guaranteed. For information about recommended devices, consult your Sony dealer.

It is possible to create up to 99 folders in external storage. Each folder can contain up to 1,200 clips (not exceeding the total material length of 24 hours) and up to 99 EDLs. The file system that external storage supports is exFAT only.

## Notes on use of external storage

- Only one external storage device can be recognized. Use a direct connection, without using a hub.
- Use external storage with sector size of 512 bytes. External storage with other sector sizes may not be recognized by this unit.
- When using external storage, the USB drive must be mounted in order to be recognized by this unit. If mounting fails, a message appears prompting you to format external storage on this unit (*see page 44*).
- When removing external storage, first unmount the USB drive (*see page 46*).
- If external storage needs formatting, make sure to format it on this unit. If external storage is formatted on a different device, it may not be recognized or it is treated as write protected on this unit.
- When the total number of files recorded on external storage exceeds 12,000, further data writing on the same external storage device by this unit is not possible. When the total number of files recorded on external storage exceeds 20,000, this unit cannot read data from that external storage device. To use this unit with external storage, keep in mind these limitations on number of files.
- It is not possible to play back clips stored on external storage directly as they are. First copy the clips you want to play back to a disc, and then you can play back those copied clips from the disc (*see page 45*).

- If you copy clips to a folder on a USB drive and then delete or rename clips in that folder, you may not be able to perform additional copying.
- If data is written to external storage from a device other than this unit, writing from the unit may become disabled.
- Deleting files on a USB drive using a computer moves the files to the Trash folder but may not delete them. Delete the files from the Trash folder.

## Using external storage

When using external storage, mount the USB drive so that it can be recognized by this unit, and then mount a target folder.

### To mount a USB drive

- 1 Connect external storage to the Super Speed USB (SS ) connector (USB 3.0 compatible) on the front panel.
- 2 Press the THUMBNAIL button to display the thumbnail view.
- 3 Press the MEDIA SEL button.

Mounting of the USB drive starts automatically. When the USB drive is mounted, the F1: USB DRV indicator changes to “ON” and the USB DRIVE ON icon () appears in the status display area of the display screen. If there are folders in the USB drive, they are also displayed on the display screen.

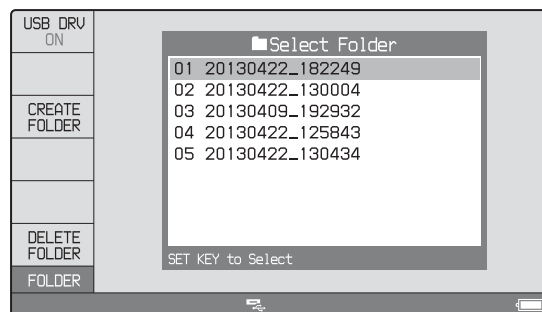

### If you failed to mount the USB drive

A message appears prompting you to format external storage.

To execute formatting, select “OK”, and then press the PUSH SET knob. To cancel formatting, select “CANCEL”, and then press the PUSH SET knob.

When the formatting is completed, the message “Format was successful.” appears.

## Note

If formatting is executed, all existing partitions (including multipartitions) are deleted and initialized into one single partition.

## To mount a target folder

Select the folder, and press the PUSH SET knob. The processing for folder mounting starts.

When mounting is successful, the thumbnails or a list of stored clips in that folder are displayed.

## To create a new folder

Press F3: CREATE FOLDER.

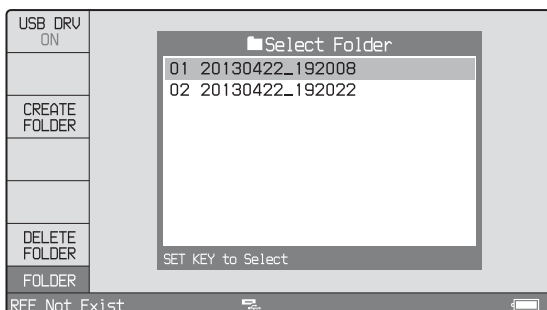

You can use F4: CREATE USB FLDR in the Clip F Menu (see page 63) to create a copy destination folder before executing a copy operation.

The newly created folder is automatically mounted.

## To change the target folder

- 1 Press the FOLDER SEL button.

A list of the folders on the USB drive appears.

- 2 Select a folder, then press the PUSH SET knob.

Mounting of the folder starts.

When the folder is mounted, a list view or thumbnail view of the clips stored in the folder appears.

## To switch to disc thumbnail view

In thumbnail view, press the MEDIA SEL button. The thumbnail view toggles between disc and USB drive thumbnail view each time you press the MEDIA SEL button.

## To delete a folder in the USB drive

- 1 With the folders in the USB drive displayed in a list view, select the folder you want to delete.

- 2 Press F6: DELETE FOLDER.

A message appears asking you whether to delete the folder.

- 3 To execute deleting, select “OK” and then press the PUSH SET knob. To cancel deleting, select “CANCEL” and then press the PUSH SET knob.

## To unmount the target folder

Press the FOLDER SEL button.

The target folder is unmounted, and the folders in the USB drive are displayed in list view.

## To use external storage to copy clips

For more information about copy operations, see “Copying” (page 55).

## To copy clips stored on external storage

- 1 Mount the USB drive.
- 2 Mount the folder containing clips you want to copy.
- 3 Perform the procedure described in “Copying clips” (page 55).

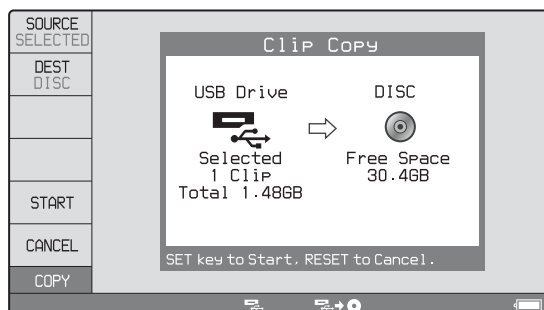

## To copy clips to external storage

- 1 Mount the USB drive.
- 2 Mount the copy destination folder, or create a new folder after selecting the clip to copy (see page 45).
- 3 Perform the procedure described in “Copying clips” (page 55).

## Removing external storage

First unmount the USB drive, and then remove external storage.

## Note

The USB drive does not need to be unmounted to remove SxS memory cards or the SBAC-US20 SxS Memory Card USB Reader/Writer.

## To unmount the USB drive

- 1 In disc thumbnail view, press the MEDIA SEL button.

The display switches to USB drive thumbnail view.

- 2 Press the USB DRV OFF button.

Unmounting of the USB drive starts.

You can also press the FOLDER SEL button to display a list of folders on the USB drive, and then press F1: USB DRV to unmount the USB drive.

When the USB drive is unmounted, the disc thumbnail view appears on the display screen and the USB DRIVE ON icon (  ) in the status display area disappears.

## Recording

This section describes video and audio recording on the unit.

See page 39 for more information about function menu operations.

See page 86 for more information about setup menu operations.

## Preparations for recording

Make the following settings and adjustments before starting to record.

**Video input signal selection:** Select with V INPUT on page P1 INPUT of the function menu.

**Audio input signal selection:** Select with A1 INPUT to A4 INPUT on page P1 INPUT, and A5 INPUT to A8 INPUT on page P2 INPUT of the function menu.

**Timecode and user bits settings:** See “Setting the Timecode” (page 34).

**Selection of time data to display:** Select with CNTR SEL on the HOME page of the function menu.

**Selection of audio channels to monitor:** Select with MONTR R and MONTR L on the HOME page of the function menu.

**Volume adjustment of the monitor audio:** Adjust with the LEVEL knob.

**Remote/local setting:** Set the remote control switch. If you set it to REMOTE, also set setup menu item 214 REMOTE INTERFACE (“RM-” and the connector used appear on the system information of the display) (see page 91).

## SD up-convert function

You can input SD signals to the SD/HDSDI INPUT connector and record them as HD signals.

## Carrying out recording

One recording segment (from the start to the end of recording) is called a “clip”.

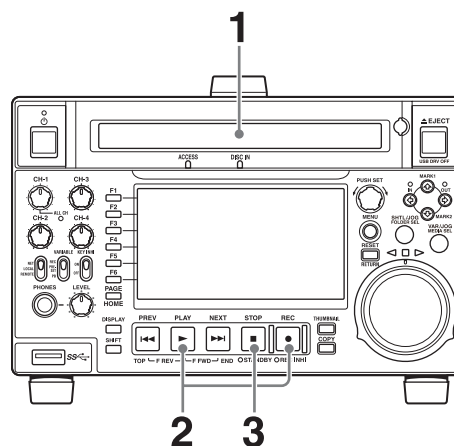

- 1 Insert a disc.
- 2 Hold down the REC button, and press the PLAY button.  
Recording starts.
- 3 To stop recording, press the STOP button.

### If the disc becomes full

Recording stops and the message “ALARM MEDIA END.” appears on the monitor.

### Notes

- Clips recorded in XAVC format and clips in other recording formats cannot be mixed. Use another disc, or delete the clips recorded in XAVC format.
- The shortest clip that can be recorded is 2 seconds long. Even if recording start and stop operations are performed within 2 seconds, a 2-second clip is recorded.

- The maximum number of clips that can be recorded is 1,200. If the disc already contains 1,200 clips, recording operation is not possible. (The message “MAX # Clips” appears in the time data display area.)
- This unit can record video input signals that are not synchronized to a reference signal. However, in that case, video breakup and audio noise may occur during EE playback.
- During recording, do not turn off the POWER switch on the rear panel or disconnect the power cord. This could cause the clip being recorded to be lost.

For details, see “Handling of discs when recording does not end normally (salvage functions)” (page 49).

## To adjust the audio recording levels

### When carrying out audio recording at a reference level

Set the VARIABLE switch to “PRESET”.

The audio signals will be recorded at a preset reference level.

You can change the reference level and the input levels with maintenance menu items M370 HEAD ROOM and M373 IN LEVEL.

For details, refer to the Service Manual.

### Manually adjusting the audio recording levels

Set the VARIABLE switch to “REC” and use the CH-1/ALL CH and CH-2 to CH-4 knobs to adjust CH-1 to CH-4, and use A5 VOL to A8 VOL on page P3 AUDIO of the function menu to adjust CH-5 to CH-8 so that the audio level indicators on the audio level meters do not exceed 0 dB for a maximum volume.

See setup menu item 108 AUTO EE SELECT (see page 89) for more information about the signal output settings in EE mode.

## To set shot marks

A Shot Mark1 essence mark or Shot Mark2 essence mark is set if you hold down the  $\blacktriangle$ /MARK1 or  $\blacktriangledown$ /MARK2 button and press the PUSH SET knob during recording. If the unit is set up to display superimposed text information (see page 36), “SHOTMARK\*” (\*: 0 to 9) appears every time you set an essence mark. When Shot Mark0 to Shot Mark9 is set, you can search for the shot marks by displaying thumbnails of the frames at those positions (see page 64).

You can also set shot marks during playback.

See page 52 for the procedure.

## Recording with the HDSDI remote control function

This section describes the settings required for recording in HDSDI remote control mode, and how the unit operates in this mode.

### Note

The unit (camcorder) that controls this unit must also support HDSDI remote output.

## Settings

Set setup menu item 214 REMOTE INTERFACE to “SDI”, and set the remote control switch on the front panel to “REMOTE”.

This unit enters HDSDI remote control mode, in which it is controlled by command packets received via the SD/HDSDI INPUT connector.

### Note

Commands received via the REMOTE (9P) connector are ignored in HDSDI remote control mode.

### Monitor display in HDSDI remote control mode

The “RM-SDI” network remote connection indicator (see page 18) appears in the status display area of the display screen. The indicator lights if command packets are embedded in the HDSDI signals, and flashes if they are not. However, “RM-SDI” continues to flash until the time the controlling camcorder is powered on and the time that the REC button is pressed on the camcorder.

## Recording operation

When a recordable disc is inserted, recording (or stop) is executed according to the REC (or STOP) command embedded in the HDSDI signals.

Recording stops automatically when the end of the disc is reached.

### When HDSDI signals are interrupted during recording

Recording stops if HDSDI signals are interrupted during recording, for example because the HDSDI cable is disconnected or the controlling camcorder is powered off. When HDSDI signal input is restored, the unit resumes operation according to the embedded REC or STOP command.

### Exchanging discs

Press the EJECT button, even if recording is in progress, to eject the disc.

After a disc is exchanged, the unit resumes operation according to the REC or STOP command embedded in the HDSDI signal.



**Note**

This unit begins recording operation about one second after the camcorder.

## Continuing recording while exchanging discs (disc exchange cache function)

About 50 seconds (this duration may differ depending on the state of a disc) of video and audio data can be recorded to the unit's internal memory cache during a disc exchange, and then written back to the newly loaded disc.

- 1 Check that setup menu item 150 REC MODE is set to "disc exchange cache".

If the disc exchange cache indicator (  ) is lit in the time data display area (see page 17) of the basic operation display, setup menu item 150 REC MODE is set to "disc exchange cache".





- 2 If none of the indicators of step 1 appear, set setup menu item 150 REC MODE to "disc exchange cache".

The setting of 150 REC MODE can be changed even during recording.

- 3 Exchange the disc.

During the period from the time when recording ends on the current disc and the disc is ejected until the time when the next disc is inserted, the unit records to its internal cache memory. Then, after the new disc is inserted, it copies the data from the cache to the disc and resumes normal recording.

### Disc exchange cache indicator

Display	Meaning
 and  flash alternately once per second	Recording to the cache
 and  flash alternately twice per second	Remaining memory capacity: Low
 flashes four times per second	Remaining memory capacity: None (disc full)

### "C" indicator for superimposed text information

Display	Meaning
"C" flashes once per second	Recording to the cache

Display	Meaning
"C" flashes twice per second	Remaining memory capacity: Low
An alarm message appears instead of "C".	Remaining memory capacity: None (disc full)

### To stop disc exchange cache recording

Do any of the following during cache recording.

- Press the STOP button.
- Set setup menu item 150 REC MODE to "normal".

### Notes

- If the disc becomes full while setup menu item 150 REC MODE is set to "disc exchange cache", the disc is ejected and the unit continues to record to its internal memory (for about 50 seconds depending on the state of a disc).
- Recording and playback operations by all buttons and dials other than the STOP button are disabled during cache recording.
- If the amount of cache data exceeds the capacity of the unit's internal memory during a disc exchange, an alarm message appears and the data in cache memory is overwritten. The latest data continues to be recorded to internal memory after a disc is inserted, and is appended to the cache data recorded during the disc exchange so that there are no breaks or interruptions in the data recorded to the new disc.
- If you insert a disc that cannot be recorded, it is ejected automatically. Insert a disc that can be recorded.
- If a disc with insufficient remaining recording time is used, the unit may be unable to re-record to the disc. Use a recently formatted disc that does not contain any clips as the exchange disc.
- For XAVC recording, the recording of cache data takes a certain amount of time. In this case, wait until recording has reached the end of the recording capacity before exchanging discs. If recording is stopped mid disc, the disc cannot be ejected until the recording operation finishes.

## Handling of discs when recording does not end normally (salvage functions)

Recording processing does not end normally if, for example, the POWER switch on the rear panel is turned off during recording, or if the power cord is disconnected during recording. Because the file system is not updated, video and audio data recorded in real time is not recognized as files, and clip contents recorded up to that point are lost.

However, this unit has salvage functions which can hold losses to the minimum by reconstructing clips on such discs. There is a quick salvage function which executes automatically and a full salvage function which you can execute as required.

**Quick salvage:** Clips are reconstructed on the basis of backup data stored in nonvolatile memory and markers recorded on the disc. Processing time is about 5 seconds.

Quick salvage executes automatically if the unit is powered on with a disc still loaded after recording was interrupted by power off.

**Full salvage:** Clips are reconstructed on the basis of markers recorded on the disc. Nonvolatile memory cannot be used, so processing takes longer than for a quick salvage (about 30 seconds, although it depends on the state of the disc).

You are prompted to execute a full salvage whenever you insert a disc that was removed manually from a powered off device after interruption of recording by power off.

Note that no recorded clip contents are lost when the on/standby button on the front panel is set to standby during recording, because the unit does not enter standby mode until after the end of recording processing.

#### Notes

- Even after recording finishes, do not set the POWER switch on the rear panel to off until the ACCESS indicator has gone out.
- These functions salvage as much recorded material as possible after an unforeseen accident, but 100% restoration cannot be guaranteed.
- Even when these functions are used, it is not possible to recover data from immediately before the interruption of recording. The amount of data lost is as follows.

**Quick salvage:** From 2 to 4 seconds of data before the interruption of recording.

**Full salvage:** From 4 to 6 seconds of data before the interruption of recording.

(More data may be lost when the unit is subject to vibrations, and when you switch frequently between recording and paused.)

- You are prompted to execute a full salvage every time you insert a disc that has not been salvaged or power the unit on with such a disc loaded.
- No recording is possible on discs containing clips that have not been salvaged, although it is possible to play back the normally recorded sections. Recording becomes possible if you format the disc, but this erases all of the original recorded content.
- If a “DISC Error!” alarm (*see page 105*) appears, recording may not have been completed successfully when recording on the following devices. In this case, restore the disc using the device last used to record to the disc.

PDW-U1, PDW-U2,  
PDW-1500, PDW-530, PDW-510, PDW-R1,  
PDW-F70, PDW-F350, PDW-F330,  
PDW-F75, PDW-F355, PDW-F335,  
PDW-HD1500, PDW-HR1, PDW-700,  
PDW-F1600, PDW-F800, PDW-HD1200, PDW-680

## To restore clips with a full salvage

- 1 Insert the disc on which recording did not end normally.

The message “Salvage?” appears.

#### To cancel the clip salvage

Press the RESET/RETURN button.

#### Notes

- The message “EJECT?” appears when “REC INHI” is displayed. If the disc is write protected, eject the disc, set the Write Inhibit tab to enable recording, and then insert the disc again..
- This operation cannot be cancelled once it begins.

- 2 Press the PUSH SET knob.

Processing begins and the message “Executing.” appears.

When processing finishes, a message appears, displaying the results.

If the message reads “Incomplete!”, the clips that failed were lost.

# Playback

This section describes playback of video and audio on the unit.

Before starting playback, make the following settings and adjustments.

**Selection of time data to display:** Select with CNTR SEL on the HOME page of the function menu.

**Selection of audio channels to monitor:** Select with MONITR L and MONITR R on the HOME page of the function menu.

**Volume adjustment of the monitor audio:** Adjust with the LEVEL knob.

**Remote/local setting:** Set the remote control switch. If you set it to REMOTE, also set setup menu item 214 REMOTE INTERFACE (“RM-” and the connector used appear on the display) (*see page 91*).

## Clip playback modes

You can set the clip playback mode to either of the following.

**Continuous playback mode:** The playback target is all of the clips on the disc (factory default setting).

**Single clip playback mode:** The playback target is the currently selected clip only.

### To select single clip playback mode

Set setup menu item 154 SINGLE CLIP PLAY MODE to “on”.

### Playback in single clip playback mode

The available playback types include normal playback, high-speed playback in the forward or reverse directions, and jog, shuttle, and variable playback. Playback stops when it reaches the start or end of the clip. The next and preceding clips are not played, even if they exist on the disc.

When this unit is set to repeat playback mode, the selected clip only is played repeatedly.

To move to another clip, press the PREV, NEXT, SHIFT + PREV, or SHIFT + NEXT button, or perform a thumbnail search.

## Playback start position of discs

Although this unit uses discs, it is designed to offer the most convenient features of tape playback on VTRs. The playback start position of content on discs varies, as described below.

### After playback stop

The unit stops at the position where the STOP button was pressed.

Press the PLAY button to resume playback at the stop position.

### After recording

The unit stops at the position where recording ended. To play back a clip, press the PREV button to move to the start frame of any clip or press the PREV button with the PLAY button held down to move to any position.

### Saving the playback position

The disc remembers the current playback position when it is ejected. Inserting the disc and pressing the PLAY button will start playback from that position.

Playback will resume from that start position even when the disc is inserted into another XDCAM device.

### Notes

- This function is not available if a disc is inserted with its Write Inhibit tab set to disable recording.
- The playback position is not saved on PFD128QLW Professional Discs.

## SD up-convert function

The content of discs recorded in SD can be output as HD.

## HD down-convert function

You can always output SD while playing discs recorded as HD.

## 1080/720 cross-convert function

You can output 720 while playing clips recorded as 1080, and output 1080 while playing clips recorded as 720. When the system frequency of clips (59.94i/59.94P/29.97P, 23.98P, or 50i/50P/25P) matches the system frequency of the unit, but the number of system line settings (1080 or 720) do not match, then clip playback is cross-converted automatically.

## Pulldown playback

When this unit’s system frequency is set to 1080/59.94i, 1080/29.97P, or 720/59.94P, clips recorded as 1080/23.98P are converted by 2-3 pulldown before playback (pulldown playback).

### Note

When the unit is in continuous playback mode and some clips are selected for pulldown playback, continuous playback of the selected clips is performed in the specified format of pulldown playback (1080/23.98P).

### Timecode in pulldown playback

During pulldown playback, timecode is also converted to 30-frame timecode to match the output video signals.

The upper row of the time data display area displays the original 24-frame timecode, and the lower row displays the 30-frame timecode.

```
TC          UTC
00:59:59:23
PDT 00:59:59:29
```

You can superimpose the 30-frame timecode after pulldown on an external monitor. To do so, set setup menu item 005 DISPLAY INFORMATION SELECT to “time data only”.

```
TCR 00:59:59:23
PDT 00:59:59:29
```

## Playback operation

This section describes the following types of playback:

**Normal playback:** Playback at normal speed

**Playback in jog mode:** Variable-speed playback, with the speed determined by the speed of turning the jog dial

**Playback in shuttle mode:** Variable-speed playback, with the speed determined by the angular position of the shuttle dial

**Playback in variable mode:** Variable-speed playback, with the speed finely determined by the angular position of the shuttle dial

### Normal playback

First insert a disc.

For details of how to insert a disc, see “Loading and unloading a disc” (page 43).

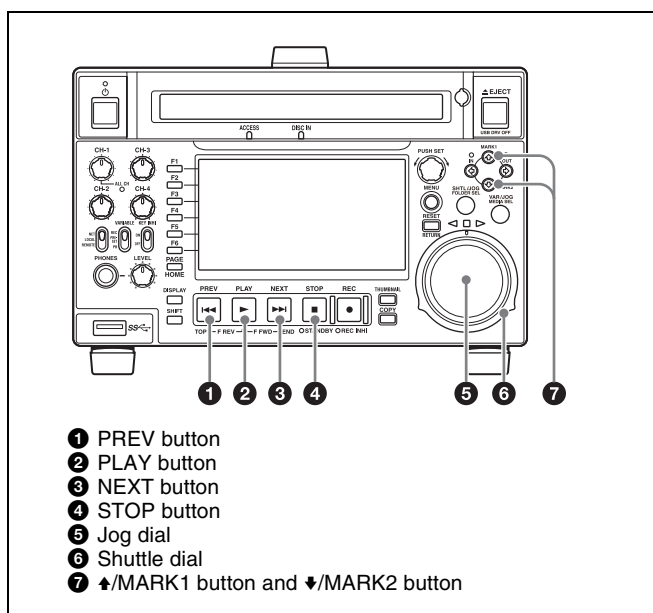

### To start playback

Press the PLAY button in continuous playback mode. Playback starts.

When two or more clips are recorded on the disc, they are played back in continuous playback mode.

#### Note

No sound is output when non-audio signals are played back.

### To jump to the next or previous clip, then start playback

Use the PREV button, NEXT button, jog dial, or shuttle dial.

### To stop playback

Press the STOP button.

If you play back to the end frame of the last clip, playback automatically stops.

If, in this state, you press the PLAY button, the message “Media End!” appears on the display.

To carry out playback again, move back to the desired clip using the PREV button, jog dial or shuttle dial.

### To set shot marks

While playing back a disc, you can set essence marks such as Shot Mark1 and Shot Mark2 in desired frames.

To set a Shot Mark1 or Shot Mark2, hold down the ▲/MARK1 or ▼/MARK2 button and press the PUSH SET knob.

You can delete essence marks on the chapter thumbnail screen (see page 65).

#### Note

Shot marks cannot be set to a locked clip.

### Playback in jog mode

In jog mode, you can control the speed of playback by the speed of turning the jog dial. The playback speed range is  $-1$  to  $+1$  times normal speed.

To carry out playback in jog mode, proceed as follows.

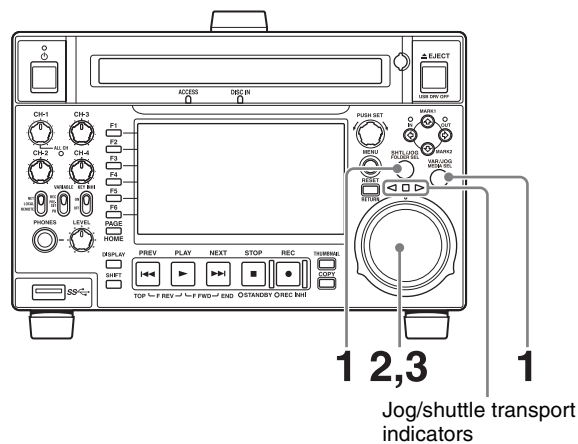

- 1 Press the SHTL/JOG button or VAR/JOG button, turning it on.

When the SHTL/JOG or VAR/JOG button is pressed during recording, recording stops and the unit enters jog mode. If you do not want to stop recording, set setup menu item 145 MODE KEY ENABLE DURING RECORDING to “stop”.

- 2 Turn the jog dial in the desired direction, at the speed corresponding to the desired playback speed.

Playback in jog mode starts.

The Jog/shuttle transport indicators light as follows.

- ◀ (green): Lights during playback in the reverse direction.
- ▶ (green): Lights during playback in the forward direction.

- 3 To stop playback in jog mode, stop turning the jog dial.

When setup menu item 101 SELECTION FOR SEARCH DIAL ENABLE is set to “dial direct” (factory default setting), you can start jog playback by simply rotating the jog dial, even when the SHTL/JOG and VAR/JOG buttons are not lit.

## Playback in shuttle mode

In shuttle mode, you can control the speed of playback by the angular position of the shuttle dial. The range of playback speed is  $\pm 20$  times normal speed or maximum speed.

To carry out playback in shuttle mode, proceed as follows.

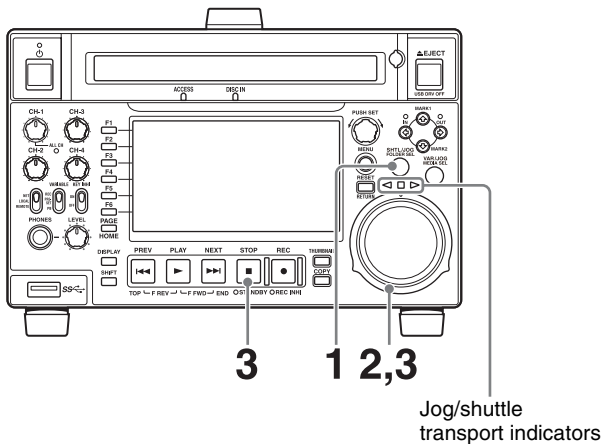

- 1 Press the SHTL/JOG button, turning it on.

When the SHTL/JOG button is pressed during recording, recording stops and the unit enters shuttle mode. If you do not want to stop recording, set setup menu item 145 MODE KEY ENABLE DURING RECORDING to “stop”.

- 2 Turn the shuttle dial to the desired angle corresponding to the desired playback speed.

Playback in shuttle mode starts.

The shuttle dial has a detent at the center position, for still image playback.

The Jog/shuttle transport indicators light as follows.

- ◀ (green): Lights during playback in the reverse direction.
- ▶ (green): Lights during playback in the forward direction.
- (red): Lights during still image display.

- 3 To stop playback in shuttle mode, return the shuttle dial to the center position, or press the STOP button.

When setup menu item 101 SELECTION FOR SEARCH DIAL ENABLE is set to “dial direct” (factory default setting), you can start shuttle playback by simply rotating the shuttle dial, even when the SHTL/JOG button is not lit.

### Notes

- When setup menu item 101 SELECTION FOR SEARCH DIAL ENABLE is set to “dial direct”, after using the shuttle dial, return it to the center position. If the shuttle dial is not in the center position, it is possible occasionally for vibration from other operations to activate the dial, and start playback in shuttle mode.
- If you switch to shuttle mode and operate the shuttle dial during playback, the initial shuttle playback speed will skip one step.  
For example, if the shuttle dial is in the center position during playback, the shuttle playback will start at 1.0 times normal speed, not at 0.5 times normal speed.

### To alternate between normal-speed playback and shuttle mode playback

Set the shuttle dial to the position corresponding to the desired shuttle playback speed, then press the PLAY and SHTL/JOG buttons alternately.

### Playback in variable mode

In variable mode, you can control the speed of playback in the range of  $-2$  to  $+2$  times normal speed by the angular position of the shuttle dial.

For playback of XAVC-format clips in variable mode, you can control the speed of playback in the range  $-1$  to  $+2$  times normal speed.

To carry out playback in variable mode, proceed as follows.

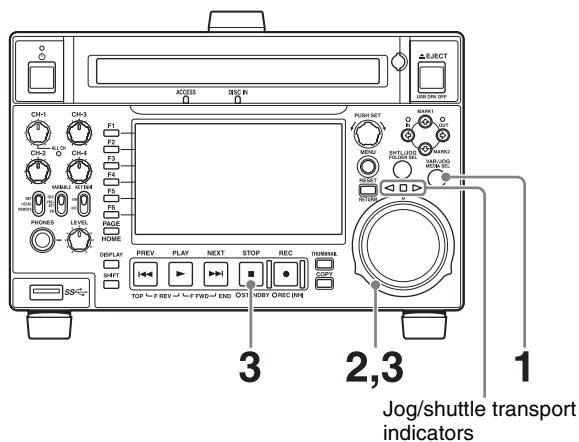

- 1 Press the VAR/JOG button, turning it on.

When the VAR/JOG button is pressed during recording, recording stops and the unit enters variable mode. If you do not want to stop recording, set setup menu item 145 MODE KEY ENABLE DURING RECORDING to “stop”.

- 2 Turn the shuttle dial to the desired angle corresponding to the desired playback speed.

Playback in variable mode starts.

The shuttle dial has a detent at the center position, for still image playback.

The Jog/shuttle transport indicators light as follows.

- ◀ **(green)**: Lights during playback in the reverse direction.
- ▶ **(green)**: Lights during playback in the forward direction.
- **(red)**: Lights during still image display.

- 3 To stop playback in variable mode, return the shuttle dial to the center position, or press the STOP button.

#### Note

If you switch to variable mode and operate the shuttle dial during playback, the initial variable playback speed will skip one step.

For example, if the shuttle dial is in the center position during playback, the variable playback will start at 0.12 times normal speed, not at 0.06 times normal speed.

#### To alternate between normal-speed playback and variable mode playback

Set the shuttle dial to the position corresponding to the desired variable playback speed, then press the PLAY and VAR/JOG buttons alternately.

#### To repeat playback in variable mode

Set setup menu item 142 REPEAT MODE to “play & VAR fwd” or “force”.

This allows you to perform repeat playback, limited to variable playback in the forward direction in the range 0 to +1 times normal speed.

## Playback operations using thumbnails

Playback operations that you can perform with thumbnails include searching for clips, displaying clip information, playing clip lists created, and locking and deleting clips. This allows you to check the actual video as you work.

See “Clip Operations” (page 64) for more information about thumbnail.

# Copying

## Overview

This unit can copy clips, EDLs, and other files stored on discs to external storage. It can also copy clips, EDLs, and other files from external storage to discs.

Copying clips and EDLs on discs to external storage enables repeated use of the disc for recording.

The unit can also copy clips, EDLs, and other files stored on SxS memory cards to discs.

To copy SxS memory cards, the SBAC-US20 SxS Memory Card USB Reader/Writer is required.

## Limitations

- When you copy a clip with a duration that exceeds six hours, the clip is divided into separate clips at each six-hour point.
- Index picture settings may be displaced forward or backward when you execute a copy.
- When an MXF clip is copied, the UMID data of the copy source clip is maintained intact. If the copy destination media contains a clip with the same UMID data as the clip selected as the copy source, it is not possible to copy the selected clip. Change the UMID data on the external device, or transfer the copy source clip via the network.
- Seamless playback and clip flag operations (addition, modification, and deletion) are not supported for MXF clips that meet the following conditions.
  - Clips containing 1,000 or more essence marks
  - Clips containing 10,804 or more timecode breaks
  - Clips with metadata files \*M01.XML more than 2 MB in size
- Do not play back a clip while copying the clip. The output may become distorted or muted.

## Copy operations

### Copying clips

#### To copy from a disc to external storage

#### To copy from external storage to a disc

- 1 Insert a disc into the disc slot.
- 2 Select the media containing target clips, and press the THUMBNAIL button.

The clip list screen appears.

#### To change the folder for displaying thumbnails

Press the FOLDER function button (F3) and select the folder to display thumbnails.

**Example:** To display thumbnails of MPEG-4 AVC/H.264-format recorded clips, press the FOLDER function button (F3) and select XDROOT.

- 3 Do one of the following to select the clip to copy.

- Turn the PUSH SET knob.
- Press the arrow buttons.

#### To select several consecutive clips

Move the cursor to the start or end of the clips that you want to select, and then proceed as described above while holding down the SHIFT button.

#### When copying all clips on a disc

Proceed to step 4 without carrying out clip selection operation.

#### To copy part of a clip

When you select a single clip and press the arrow buttons to set an IN and OUT point in the clip, it becomes possible to copy the section defined by the IN and OUT points.

*For details about how to set an IN and OUT point, see “To copy the specified part of a clip” (page 56).*

- 4 Press the COPY button.

The Clip Copy screen appears.

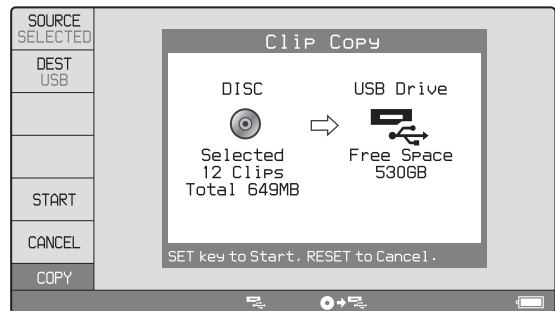

#### To change the copy source clip

Press the RETURN button to return to the clip list screen, and then select another clip.

#### To cancel the copy operation

Press the CANCEL function button (F6) or the RESET button.

- 5 Press the SOURCE function button (F1) to filter the copy source clips.

**To copy the clips selected in step 3:** Select “SELECTED”.

**To copy all the clips on the disc:** Select “ALL”.



## 6 Press the START function button (F5).

Copying of the clips starts.

The progress of the copying is shown on the Clip Copy screen, and the copy icon lights in the status display area.

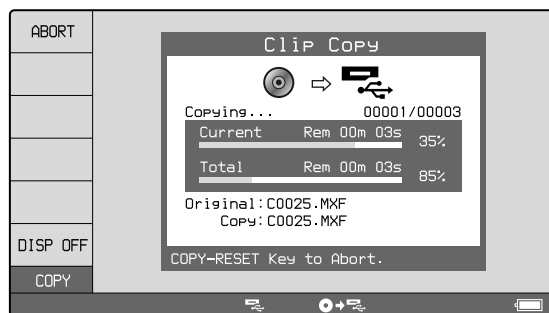

### To abort the copy operation

Press the ABORT function button (F1), and then press the YES (F5) function button.

The data already transferred to the destination media remains on that media.

If the copy operation is completed successfully, the message “Copy was successful.” appears.

## 7 Press the OK function button (F5).

The Clip Copy screen disappears, and you return to the original screen.

### To copy an EDL file

An EDL can be copied by an operation similar to a clip copy operation. However, it is necessary to make a copy of all clips referenced by the EDL in advance. Therefore, “ALL” is automatically selected in step 3 of the procedure for “Copying clips” (page 55).

### To copy the specified part of a clip

When you set an IN and OUT point in the clip, it becomes possible to copy only the part defined by the IN and OUT points.

- 1 On the video monitor screen, cue the clip up to the frame where you want set an IN point.
- 2 Press the PUSH SET knob while holding down the ◀/IN button.

An IN/OUT setting window appears in the bottom right corner of the display.

The IN point timecode is displayed in the IN/OUT setting window, and the IN indicator lights.

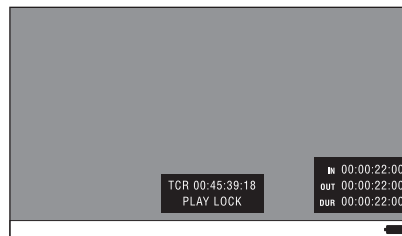

IN indicator

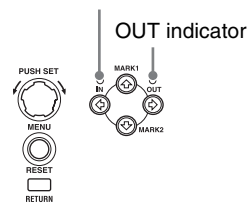

- 3 Cue up to the frame where you want to set an OUT point.

- 4 Press the PUSH SET knob while holding down the ▶/OUT button.

An IN/OUT setting window appears in the bottom right corner of the display.

The OUT point timecode and the duration (DUR) are displayed in the IN/OUT setting window, and the OUT indicator lights.

- 5 Carry out step 4 and follow the procedure in “Copying clips” (page 55).

### To check the clip with IN and OUT points set

- 1 Press the ◀/IN or ▶/OUT button.

An IN/OUT setting window appears in the lower right of the display.

- 2 Press the NEXT or PREV button.

The unit cues up the frame with the IN (or OUT) point set.

### To delete the IN/OUT points

- 1 Press the ◀/IN button (or ▶/OUT button).

The IN/OUT setting window appears in the bottom right corner of the display.

- 2 Press the RESET button.

The IN (or OUT) indicator turns off.

#### Note

The following operations delete the IN/OUT points automatically.

- Change the selection of media.
- Remove the media.



- Delete the clip in which IN/OUT points are set.
- Format the media.



# Operations on Clip List Screens

## Chapter

# 5

## Overview

Use clip list screens to search for scenes, play scenes found by searching, select clips to copy, and perform other operations related to clips.

You can switch between the details view and the thumbnails view of clip list screens.

### Switching between display screens

To switch between the basic operation screen, video monitor screen, and clip list screens (thumbnails view and

details view), press the THUMBNAIL button (1) or DISPLAY button (2). The screens change as shown in the following figure.

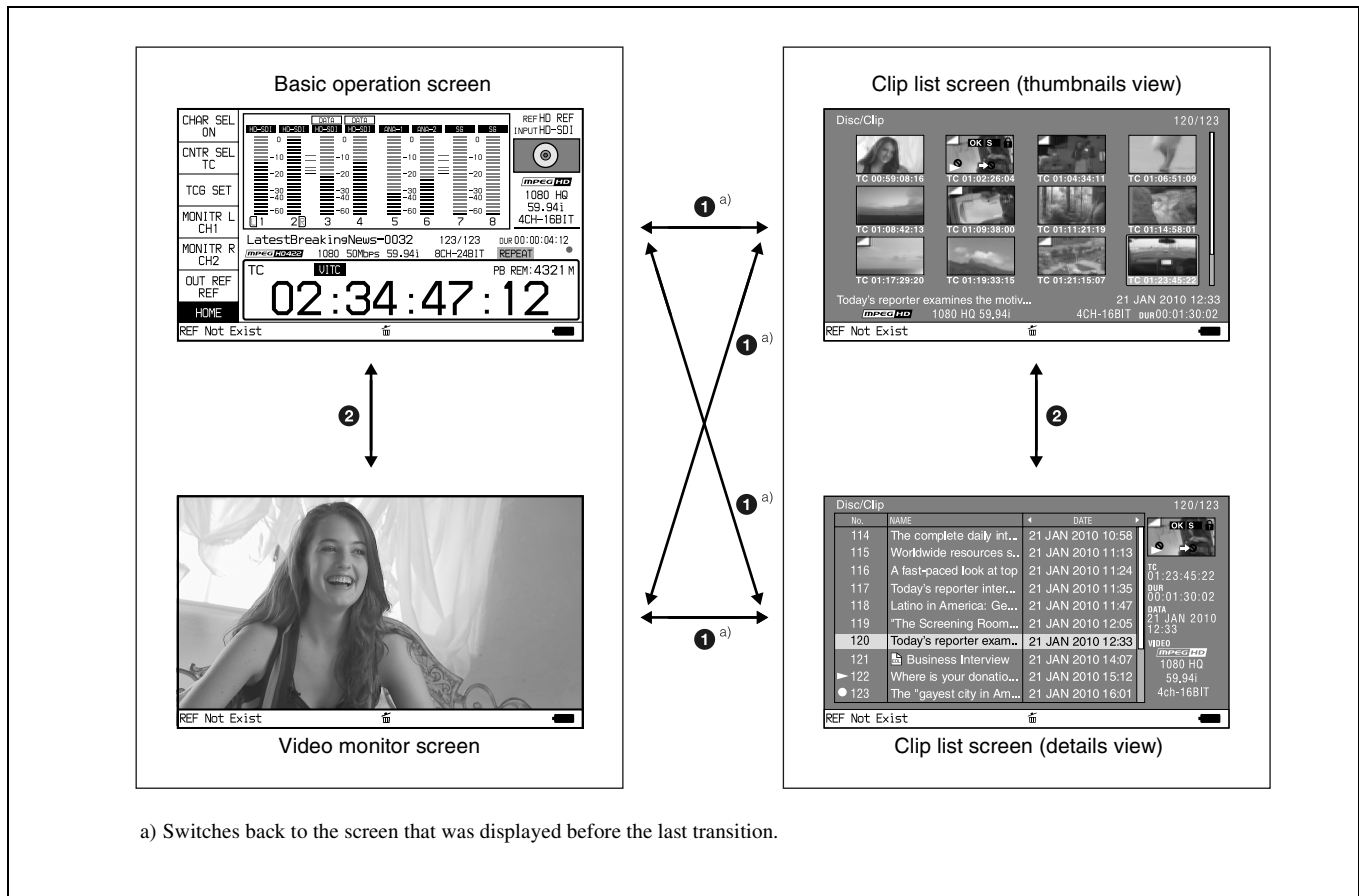

## Information and controls on clip list screens

### Thumbnails view

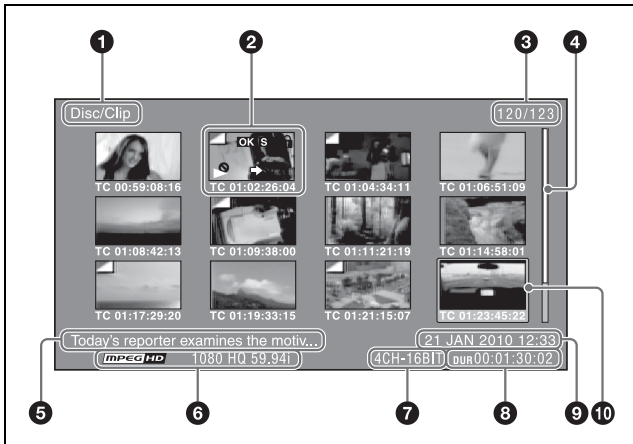

#### 1 Clip storage locations

Displays the storage location of the currently displayed clips and EDLs in the format “recording media/folder”.

#### 2 Thumbnail

Thumbnail of a clip or an EDL icon.

Thumbnails of clips and EDL icons can be displayed on the same clip list screen, with clip thumbnails displayed first.

For details, see “Thumbnail display items” (page 60).

#### 3 Clip number/total number of clips

Displays the total number of clips (including EDLs) on the selected media, and the number of the selected clip (or EDL).

#### 4 Scrollbar

When not all of the thumbnails can be displayed in the thumbnail display area, the position of the slider shows the relative position of the currently displayed clips, and the length of the slider shows the relative length of currently displayed clips within all of the clips.

#### 5 Clip name

Displays the name of the selected clip (or EDL).

When multiple clips are selected, displays the name of the first clip or the most recently selected clip.

Clip names can be displayed in European languages (English, French, German, Italian, etc.), Japanese, Hangul characters, and Chinese (both simplified and traditional characters).

### Notes

- Every character that cannot be displayed properly is represented by a ■.

- Clip names that are too long are displayed truncated. To view the entire character string of the name, access the Clip Properties screen (*see page 60*).

#### 6 Video format

The video format of the selected clip is displayed as a combination of the following items.

- Video format logo
- Number of system lines and recording quality
- System frequency

#### 7 Audio format

The audio format of the selected clip is displayed as a combination of the following items.

- Number of audio channels
- Quantization bit rate

#### 8 Duration

Displays the duration (recording time) of the selected clip. When multiple clips are selected, displays the total recording time of the selected clips.

#### 9 Clip date and time

Displays the date and time when the selected clip was shot and recorded.

#### 10 Selection frame

Indicates that the clip is selected. To select another clip, move the frame (*see page 64*). Multiple selection frames appear when multiple clips are selected (*see page 64*).

### Details view

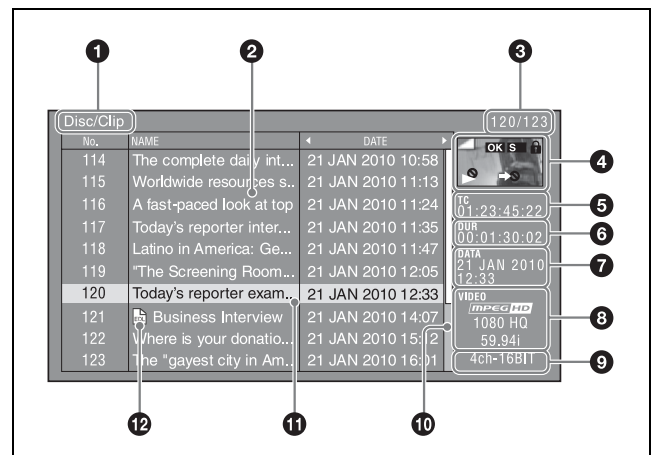

For details about the following items, see “Thumbnails view” (page 59).

- ❶ Clip storage locations
- ❸ Clip number/total number of clips
- ❹ Duration
- ❺ Clip date and time
- ❻ Video format
- ❼ Audio format
- ❽ Selection frame

## ❷ Details display area

Displays a details list of clips and EDLs on the selected media.

The list is made up of the following columns.

- No. (line number)
- NAME (clip name)
- DATE (clip date and time)
- DURATION (recording time)

## ❹ Thumbnail

Displays the thumbnail of the selected clip (or the EDL icon when an EDL is selected).

For details, see “Thumbnail display items” (page 60).

## ❺ Timecode

Displays the starting timecode of the selected clip.

## ❽ Scrollbar

When not all of the clips can be displayed in the details display area, the position of the slider shows the relative position of the currently displayed clips, and the length of the slider shows the relative length of currently displayed clips within all of the clips.

## ❽ EDL mark

The mark  appears when the item is an EDL.

## Clip Properties screen

When you select a clip and press the CLIP PROPERTY function button (F2), this screen displays the properties of the selected clip.

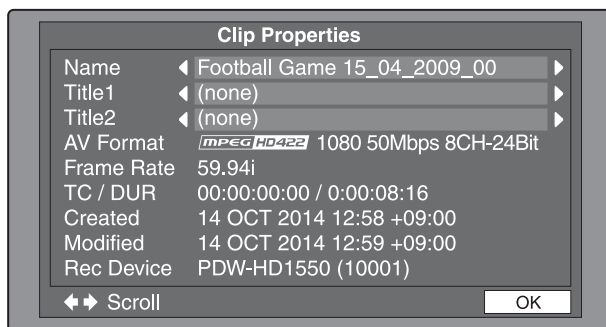

**Name:** Clip name <sup>1)</sup>

**Title1:** Title1

**Title2:** Title2 <sup>1)</sup>

**AV Format:** Recording format

**Frame Rate:** The frame rate at the time when the clip was shot. For clips shot using Slow & Quick Motion, the PB (playback)/Capture (shooting) frame rates are shown.

**TC/DUR:** Timecode of the first frame/Recording time

**Created:** Date and time of creation

**Modified:** Date and time of most recent modification

**Rec Device:** Name of device that created the clip (product number)

1) See “Clip name” in “Thumbnails view” (page 59).

The Clip Properties screen displays the entire character string of long clip names and titles.

## To scroll hidden parts of the string into view

When a ◀ or ▶ mark is displayed for an item, you can press the left arrow or right arrow button to scroll the display by one character for each press.

The up arrow and down arrow buttons scroll the beginning and end of the string into view.

When there is any hidden part of the string, arrows are displayed on the left and right of the “Scroll” indicator at the bottom left of the screen.

## Thumbnail display items

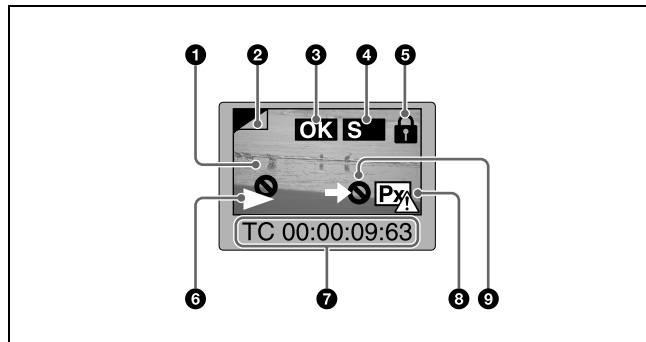

### Note

Only ❹ and ❽ are displayed on EDL icons.

## ❶ Index picture

Displays an image representing the content of the clip. Normally the index picture is the first frame in a clip, but you can change it to any frame in the clip for a different index picture.

For the method of changing the index picture frame, see “Setting the index picture frame” (page 67).

## ❷ Index picture changed mark

This mark, like the folded-over corner of a page that you want to remember, appears when the index picture has been changed to any frame other than the first frame of a clip.

## Note

When you cue up a clip, the unit always cues up the first frame, even when the index picture has been changed to a different frame.

### 3 Clip flag icon

Displays the corresponding icon when a clip flag (OK/NG/KP(KEEP)) is set in the clip (*see page 66*).

### 4 S mark

This mark appears when shot marks or other essence marks have been set in the clip.

### 5 Lock icon

This icon appears when the clip is locked (protected) (*see page 66*). Clips cannot be deleted and their clip information cannot be changed when this mark is displayed.

### 6 Unplayable icon

An unplayable icon (Ⓢ) indicates that the clip (or EDL) cannot be played, for example because the system frequency settings differ from the current settings of this unit.

A copy playback icon (▶) indicates that the clip cannot be played back directly, but copy playback is possible.

### 7 Clip information

Displays the clip information selected with the CLP INFO item in the Clip F Menu (*see page 63*). The factory default selection is the timecode of the first frame.

### 8 “No proxy AV data” icon

This icon appears when the clip does not include proxy AV data.

### 9 “Cannot copy” icon

You cannot copy clips (or EDL) marked with this icon.

## Expanded thumbnail screen

This screen displays thumbnails of equally sized divisions of the selected clip or EDL.

*For details about how to display the expanded thumbnail screen, see “To search through a clip on the expanded thumbnail screen” (page 64).*

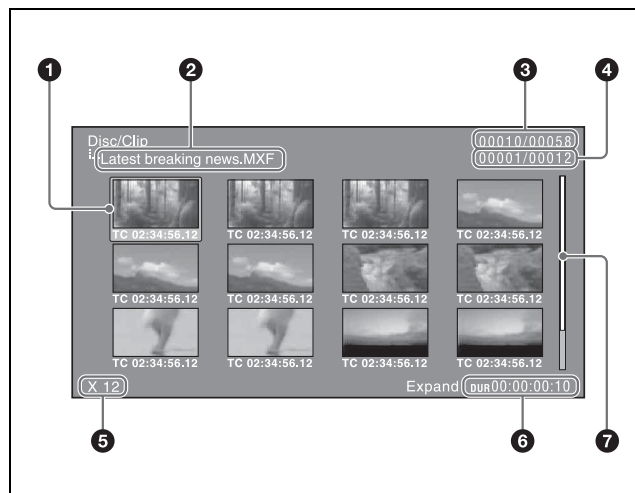

### 1 Selection frame

Indicates that the thumbnail is selected. To select another thumbnail, move the frame (*see page 64*).

### 2 Clip name

Displays the name of the clip displayed in the expanded thumbnail screen.

### 3 Clip number/total number of clips

Displays the total number of clips on the selected media and the number of the clip whose expanded thumbnails are currently displayed.

### 4 Thumbnail number/total number of thumbnails

Displays the total number of thumbnails of the divided clip and the number of the currently selected thumbnail.

### 5 Number of divisions

Displays the number of times that the selected clip has been divided to display the expanded thumbnails.

### 6 Duration

Displays the time from the selected thumbnail to the next thumbnail.

### 7 Scrollbar

*See the description of “Scrollbar” under “Thumbnails view” (page 59).*

## Chapter thumbnail screen

Chapters are the sections between the shot marks, Rec Start marks, and other essence marks that have been recorded in clips or EDL sub clips. This screen allows you to display thumbnails of the chapters in the selected clip or EDL.

*For details about how to display the chapter thumbnail screen, see “To search through a clip on the chapter thumbnail screen” (page 65).*

Rec Start essence marks are set automatically at the start of recording, but shot marks can be set at any scene during recording or playback.

See page 48 and page 52 for more information about shot mark setting.

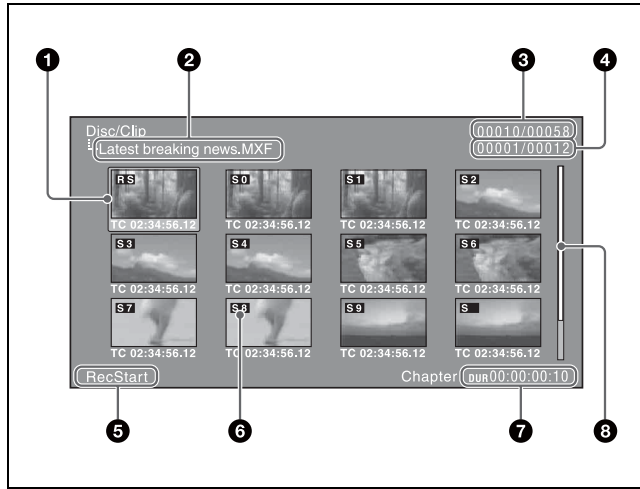

**1 Selection frame**

Indicates that the thumbnail is selected. To select another thumbnail, move the frame (see page 64). Multiple selection frames appear when multiple thumbnails are selected (see page 64).

**2 Clip name**

Displays the name of the clip displayed on the current chapter thumbnail screen.

**3 Clip number/total number of clips**

Displays the total number of clips on the selected media and the number of the clip whose chapter thumbnails are currently displayed.

**4 Chapter number/total chapters**

Displays the total number of chapters and the number of the selected chapter.

**5 Essence mark indicator**

Displays the type of the essence marks which are set on the selected chapter.

**6 S0 to S9/RS/S marks**

“S0” to “S9” and “RS” marks on the thumbnails indicate frames where Shot Mark0 to Shot Mark9 and Rec Start essence marks are set. “S” marks indicate frames where essence marks other than shot marks and Rec Start essence marks are set. No such marks are displayed on thumbnails of EDL sub clips.

**7 Duration**

Displays the time from the first frame of the selected chapter to the first frame of the next chapter.

**8 Scrollbar**

See the description of “Scrollbar” under “Thumbnails view” (page 59).

**Clip Menu**

The Clip Menu provides the following commands for operations on clips.

The shortcut buttons shown in parentheses ( ) allow you to open menu items directly. For example, “SHIFT + STOP” means to press the STOP button while holding down the SHIFT button.

Item	Sub-item	Function
Delete Clips (SHIFT + RESET)	Selected Clips	Deletes the selected clips.
	All Clips	Deletes all clips on the selected media.
Lock Unlock Clips (SHIFT + STOP)	Lock Selected Clips	Locks the selected clips.
	Lock All Clips	Locks all clips on the selected media.
	Unlock Selected Clips	Unlocks the selected clips.
	Unlock All Clips	Unlocks all clips on the selected media.
Set Clip Flag	OK	Sets the OK flags in the selected clips.
	NG	Sets the NG flags in the selected clips.
	KP(KEEP)	Sets the KEEP flags in the selected clips.
	none	Clears clip flags that have been set in the selected clips.
Format Media	–	Formats (initializes) a disc <b>Note</b> Finalized discs cannot be formatted.
Finalize Disc	–	Finalizes a write-once type Professional Disc. <b>Notes</b> • You cannot write additional data to finalized discs. • Finalized discs cannot be finalized again.
Update/Restoring Media	–	Rebuilds the disc management data.

Item	Sub-item	Function
Media Properties	–	Displays the disc information.
Settings	Select Clip Language	Selects the clip name display language. <ul style="list-style-type: none"> <li>• Alphabet</li> <li>• Korean</li> <li>• Simplified Chinese</li> <li>• Traditional Chinese</li> <li>• Japanese</li> </ul>
	Select Alarm Language	Selects the alarm display language. <ul style="list-style-type: none"> <li>• English</li> <li>• Japanese</li> </ul>

## To display the Clip Menu

Press the MENU button with a clip list screen (thumbnails view or details view) displayed.

To return to the original screen, press the MENU button again.

## Clip Menu operations

**To move the focus bar up or down:** Press the  $\blacktriangle$ /MARK1 or  $\blacktriangledown$ /MARK2 button, or turn the PUSH SET knob.

**To move from a menu level to the next lower menu level:** Press the  $\blacktriangleright$ /OUT button or PUSH SET knob.

**To move from a menu level to the next higher menu level:** Press the  $\blacktriangleleft$ /IN button or RETURN button.

**To execute a command:** Press the PUSH SET knob.

## Clip F Menu

The clip list screens provide the Clip F Menu, which can be accessed directly with function buttons.

Following is a list of Clip F Menu commands. Underlined settings are the factory defaults.

## CLIP page

Item	Function
F1: CLP INFO <sup>a)</sup>	Selects the information to be displayed at the bottom of the thumbnails. <b>DATE:</b> Date and time of creation, or date and time of the most recent modification <b>TC:</b> Timecode of first frame <b>DURATION:</b> Playback time <b>SQ NO.:</b> Sequence number of thumbnail
F2: CLIP PROPERTY	Displays the Clip Properties screen (see page 60).
F3: FOLDER	Selects the folder on the disc whose content you want to display on the clip list screen.

Item	Function
F4: CREATE USB FLDR	When external storage is connected to this unit and the USB drive is mounted, creates a copy destination folder in the USB drive to enable a clip on a disc to be copied to external storage. (The name of the copy destination folder will automatically be the shooting date of the clip.) <b>Note</b> This operation cannot be executed if the USB drive is write inhibited. Unlock the drive and try again.  <i>For the operation to write enable the USB drive, refer to the instruction manual for the external storage device that you are using.</i>
F5: CHAPTER	Displays the chapter thumbnail screen (see page 61).
F6: EXPAND	Displays the expanded thumbnail screen (see page 61).

a) Does not appear when the clip list screen is in details view.

## P1 EDL page

Parentheses ( ) indicate shortcut buttons for directly accessing a menu item.

Item	Function
F1: SET CURT.EDL	Sets the current EDL.
F2: RELEASE CURT.EDL	Releases the current EDL.
F3: CREATE NEW EDL (SHIFT + PUSH SET knob)	Creates a new EDL.
F4: ADD TO CURT.EDL	Adds sub clips to the current EDL.
F6: GOTO CURT.EDL	Refers to the current EDL.

## Shortcut buttons for EDL edit commands

If a sub clip is selected on a clip list display screen, you can invoke the F3: CREATE NEW EDL command by pressing and holding the SHIFT button and pressing the PUSH SET knob.

*For the procedure for creating EDLs, see “Creating and editing EDLs” (page 68).*

## To display the Clip F Menu

Press the PAGE/HOME button or function buttons (F1 to F6) with a clip list screen (thumbnails view or details view) displayed.

## To display a different page

Each press of the PAGE/HOME button displays the next function menu page in the order: CLIP → P1 → CLIP...

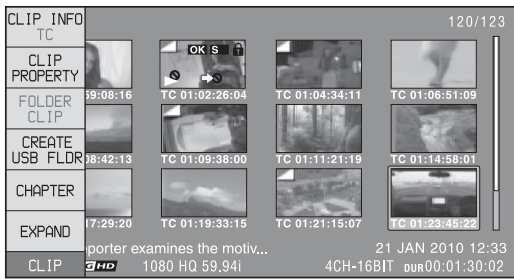

# Clip Operations

## Selecting clips

Select clips with the selection frame (*see page 59*).

## To move the selection frame

Do one of the following.

- Turn the PUSH SET knob.
- Press the arrow buttons.
- Turn the shuttle/jog dial. (The selection frame moves at high speed in shuttle mode and at low speed in jog mode.)

## To jump to the first clip

Press the PREV button while holding down the SHIFT button.

## To jump to the last clip

Press the NEXT button while holding down the SHIFT button.

## To make a consecutive selection of clips

Move the selection frame to the first clip that you want to select. Then, while holding down the SHIFT button, turn the PUSH SET knob.

To cancel the consecutive selection, move the selection frame without the SHIFT button held down.

## Searching with thumbnails

You can put the clip list screen into thumbnails view (*see page 59*) to search for desired clips while viewing thumbnails.

To search for clips while viewing clip names, press the DISPLAY button to switch to details view (*see page 59*).

## To search through a clip on the expanded thumbnail screen

The expand function allows you to divide a clip selected on the clip list screen into equally sized blocks, and to display a list of thumbnails of those blocks. This is a quick and efficient way to review the selected clip and search for target scenes. You can specify 12, 144, or 1728 divisions.





- 1 On the clip list screen, select the thumbnail of the clip that contains the scene you want to find.
- 2 Press the PAGE/HOME button to display the function menu, and press the EXPAND function button (F6).  
The selected clip is divided into 12 blocks, and a list appears on the expanded thumbnail screen (*see page 61*) with the first frame of each block displayed as a thumbnail.
- 3 Select the thumbnail that you want to expand further.
- 4 Repeat steps 2 and 3 up to 2 times, as required.

#### Note

If the duration of each block after division would be shorter than one frame, division is performed so that an expanded thumbnail screen is displayed in which the duration of each block is one frame. In this case, no such expanded thumbnail screen is displayed that represents further expansion.

For example, a 100-frame clip is divided into 100 blocks when you press the EXPAND function button (F6) twice and an expanded thumbnail screen is displayed in which the duration of each block is one frame. A third press of the EXPAND function button (F6) displays no expanded thumbnail screen representing further expansion.

#### To return to the previous expansion level

Press the EXPAND function button (F6) while holding down the SHIFT button.

#### To display the expanded thumbnail screen of the previous or next clip

With the expanded thumbnail screen still active, press the PREV button or the NEXT button.

An expanded thumbnail screen appears displaying the thumbnails of 12 equal blocks resulting from division of the previous or next clip.

#### To search through a clip on the chapter thumbnail screen

The chapter function allows you to display thumbnails of the chapters in a clip.

*See page 59 for more information about thumbnail view.*

*See page 61 for more information about the chapter thumbnail screen.*

- 1 On the clip thumbnail screen, select the thumbnail of a clip or the icon of an EDL with chapters set.

The S mark (*see page 61*) appears on the thumbnails of clips with chapters set. (No S marks are displayed on EDL icons.)

- 2 Press the PAGE/HOME button to display the function menu, and press the CHAPTER function button (F5).

The chapter thumbnail screen (*see page 61*) appears, with thumbnails of the frames where chapters are set. The “S0” to “S9” and “RS” marks on the thumbnails indicate frames where Shot Mark0 to Shot Mark9 and Rec Start essence marks are set. The “S” marks on the thumbnails indicate frames where essence marks other than shot marks and Rec Start essence marks are set. No such marks are displayed on thumbnails of EDL sub clips.

#### To delete the shot mark at a chapter position

You can delete the shot mark (Shot Mark0 to Shot Mark9) at the chapter position on the chapter thumbnail screen. (Rec Start essence marks and EDL sub clips cannot be deleted.)

- 1 On the chapter thumbnail screen, select the thumbnail for the frame whose shot mark you want to delete.
- 2 Press the PAGE/HOME button to display the function menu, and press the REMOVE function button (F4).  
A message appears asking if you are sure that you want to delete the shot mark.
- 3 Select “OK” to delete the mark, or “Cancel” to cancel the deletion, and then press the PUSH SET knob.

#### To display the chapter thumbnail screen of the previous or next clip

With the chapter thumbnail screen still active, press the PREV button or the NEXT button.

---

### Playing a clip by thumbnail search

After finding a clip with one of the methods explained in the previous section, “Searching with thumbnails” (*page 64*), you can cue up or play the clip that you have found.

#### To cue up the clip

Select the clip you have found, and then press the PUSH SET knob.

#### To play the clip

Select the clip you have found, and then press the PLAY button.

## Setting clip flags

You can set three types of clip flags (OK/NG/KP(KEEP)) for selected clips. Setting these flags in each clip that you record makes it easy for editors and other colleagues to find and select the clips that they need.

- 1 On a clip list screen, select the clip where you want to set a flag (multiple selections possible).
- 2 Display the Clip Menu.
- 3 Select Set Clip Flag.

The Set Clip Flag screen appears.

On this screen, a  mark appears in front of the name of each flag that is set in one or more of the currently selected clips.

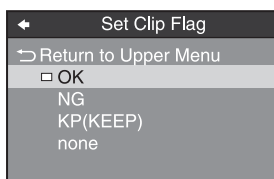

- 4 Select the clip flag that you want to set (OK/NG/KP(KEEP)), and then press the PUSH SET knob.

The clip flag is set for all selected clips, and the clip flag icon (*see page 61*) appears on thumbnails.

### To clear clip flags

Carry out steps **1** to **3**, selecting a clip that has a flag set, and then select “none” in step **4**.

## Locking (write-protecting) clips

On a clip list screen, you can lock the selected clips so that they cannot be deleted or altered.

Locking prevents the following operations on clips.

- Deletion
- Changing the index picture
- Adding and deleting shot marks
- Setting and clearing clip flags

### Notes

- Locked clips are deleted along with other clips when media is formatted.
- Clips cannot be locked or unlocked when media is write protected.

## To lock clips

- 1 On a clip list screen, select the clips that you want to lock (multiple selections possible).

This step is not needed if you lock all clips.

- 2 Display the Clip Menu.
- 3 Select Lock Unlock Clips.

The Lock Unlock Clips screen appears.

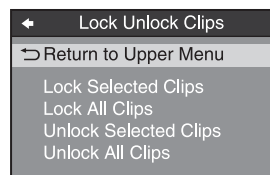

- 4 Select Lock Selected Clips or Lock All Clips, and then press the PUSH SET knob.

The clips selected in step **1** or all clips are locked.

A lock icon (*see page 61*) appears on the thumbnail of the locked clips.

### Tip

You can lock the selected clips by pressing the STOP button while holding down the SHIFT button in step **1**.

## To unlock clips

- 1 Execute steps **1** to **3** in “To lock clips” (*page 66*).
- 2 Select Unlock Selected Clips or Unlock All Clips, and then press the PUSH SET knob.
- 3 Select “OK”, and then press the PUSH SET knob.

### Tip

When you select a clip you want to unlock on the clip list screen and then press the STOP button while holding down the SHIFT button, a dialog appears asking you to confirm unlock. When you select “OK” and press the PUSH SET knob, the selected clip is unlocked. (To cancel unlock, select “CANCEL” and press the PUSH SET knob.)

## Deleting clips

### Notes

- Clips cannot be deleted when media is write protected.
- Locked clips cannot be deleted.

- 1 On a clip list screen, select the clips that you want to delete (multiple selections possible).

This step is not needed if you delete all clips.

- 2 Display the Clip Menu.

- 3 Select Delete Clips.

The Delete Clips screen appears.

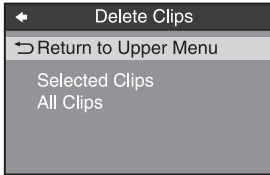

- 4 Select Selected Clips or All Clips, and then press the PUSH SET knob.

- 5 Select “OK”, and then press the PUSH SET knob.

The clips selected in step 1 or all clips are deleted.

#### Tip

You can delete the selected clips simply and easily by pressing the RESET button while holding down the SHIFT button in step 1 and by carrying out step 5.

## Copying clips

See “Copy operations” (page 55) for information about operations.

## Setting the index picture frame

The clip thumbnail screen displays thumbnails as index pictures for clips. Normally the index picture is the first frame in a clip, but you can change it to any frame in the clip for a different index picture.

#### Note

You cannot set index pictures for EDLs.

- 1 On the basic operation screen or video monitor screen, play back the clip for which you want to set the index picture frame.
- 2 Press the STOP button at the frame you want to be the index picture frame, to obtain a still frame display.

- 3 Display the P5 OTHER page of the function menu, and press the INDEX function button (F1).

A confirmation box appears asking you whether to set the frame of the still image as the index picture frame.

- 4 To set the current frame as the index picture frame, select “OK” and press the PUSH SET knob.

#### To set another frame as the index picture frame

Select “CANCEL” and press the PUSH SET knob, turning the confirmation box off. Start again from step 1.

When you switch the display to the clip list screen, the newly set index picture is displayed as the thumbnail.

# EDL Editing

## What is EDL editing?

EDL editing is a function which allows you to select material (clips) from the material recorded on media and perform cut editing. You can do this by operating on this unit only.

- EDL editing is a convenient way to perform cut editing in the field and in other offline situations.
- In EDL editing you create an EDL (editing list). Since the material itself is not affected, you can repeat this any number of times.
- You can play back the edit list created on this unit.
- Using the EDL editing function, you can easily perform functions with this unit, such as add entire clips, add partial clips, and delete sub clips.
- Changing the sequence of sub clips and modifying the IN/OUT points are not supported.
- An EDL (editing list) can be used on XPRI and other full-feature nonlinear editing systems.

## Clips

Material recorded on a disc with this unit is managed in units called “clips”. A clip contains the material from a recording start point to a recording end point. Clips have numbers beginning with C, for example C0001.

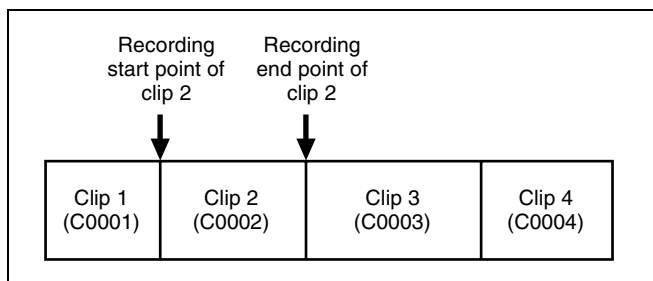

## EDLs

You can use the EDL editing function to select clips from the clips saved on a disc and create a cut edit list called an “EDL”.

EDLs have numbers beginning with E, for example E0001. Up to 99 clip lists can be saved on a disc.

## Sub clips (clips in EDLs)

Clips (or parts of clips) that have been added to an EDL are called “sub clips”. Sub clips are virtual editing data that specify ranges in the original clips. You can use them without modifying the original data.

The following figure illustrates the relation between clips and sub clips.

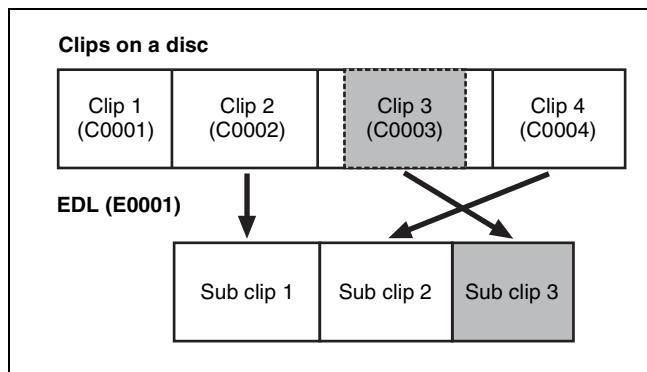

In the above example, the whole of clip 2 has been added as sub clip 1, and the whole of clip 4 has been added as sub clip 2.

Sub clip 3 is part of clip 3. Therefore, when EDL E0001 is played back, clip 4 is played after clip 2, and then the part of clip 3 shown in gray color is played.

## EDL editing (current EDL)

To edit an EDL on a disc, you must first select the target EDL for editing. Existing EDLs and newly created EDLs can be selected. The target EDL for editing is called the “current EDL”.

EDLs are automatically saved on a disc when they are created and modified.

The current EDL icon is displayed in the status display area on the clip list screen (thumbnail view) when the current EDL is selected.

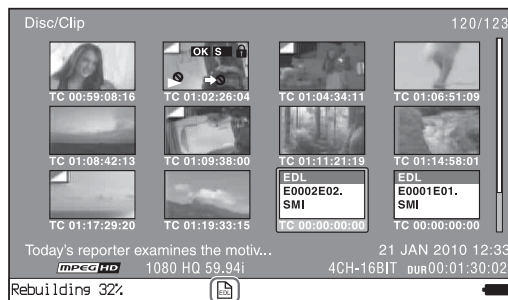

## EDL playback

Clips and EDLs are saved together on a disc.

To play an EDL, load the EDL that you want to play, and press the PLAY button. Clips are played according to the data in the EDL.

## Creating and editing EDLs

The following table lists the steps in the creation and editing of EDLs with the EDL editing function. To create an EDL, you always need to carry out the steps inside the heavy lines. Other steps can be carried out as required.

1	<b>Create EDLs:</b> Use the CREATE NEW EDL command to create an EDL containing the selected clips.
2	<b>Add sub clips:</b> Use the ADD TO CURT.EDL command to add the clips you want to use to an EDL. You can add up to 300 sub clips to one EDL.
3	<b>Delete sub clips:</b> Use the REMOVE command to delete specified sub clips from an EDL.
4	<b>Play the EDL:</b> Use the PLAY button and other playback controls to play the current EDL and check its contents.

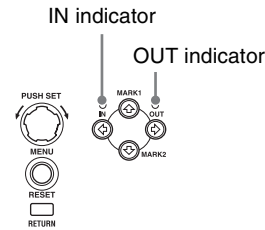

## To create an EDL

You can select multiple clips on the clip list screens and then create a new EDL. You can also create a new EDL by assigning an IN point/OUT point on the video monitor screen.

### Creating an EDL on the clip list screens

See page 58 for information about screen operations.

- 1 On a clip list screen, select the clips that you want to become sub clips (multiple selections possible).
- 2 Press and hold the SHIFT button and then press the PUSH SET knob or display the P1 EDL page of the Clip F menu and press the CREATE NEW EDL function button (F3).

The EDL creation starts.

The name for the created EDL appears when the creation finishes. The created EDL becomes the current EDL.

- 3 Select “OK”, and then press the PUSH SET knob.

### Creating an EDL on the video monitor screen

You can create an EDL while checking the video on the video monitor screen by specifying the range to use as a sub clip. You can perform this operation during recording, playback (including when stopped), and searching. During recording, the currently recording clip cannot be used as a sub clip to create a new EDL, but IN/OUT points can still be set.

- 1 On the video monitor screen, cue the frame you want to specify for the IN point.
- 2 Press and hold the ◀/IN button, and then press the PUSH SET knob.

The IN/OUT setting window appears on the bottom right.

The time code for the IN point is displayed in the IN/OUT setting window, and the IN indicator is lit.

- 3 Cue the frame you want to specify for the OUT point.

- 4 Press and hold the ▶/OUT button, and then press the PUSH SET knob.

The IN/OUT setting window appears on the bottom right.

The time codes for the OUT point and duration (DUR) are displayed in the IN/OUT setting window, and the OUT indicator is lit.

- 5 Press the PAGE/HOME button to display the function menu, and press the CREATE NEW EDL function button (F3).

The EDL creation starts.

The name for the created EDL appears when the creation finishes. The created EDL becomes the current EDL.

When the current EDL is specified, the current EDL icon appears in the status display area.

- 6 Select “OK”, and then press the PUSH SET knob.

## To add sub clips to an existing EDL

Sub clips can be added from the clip list display screens or the video monitor screen. The added clips are inserted at the end of the EDL.

Sub clips are added to the current EDL. Consequently, an EDL must be selected as the current EDL in order to perform this operation. An EDL is made the current EDL automatically after it is created, as explained in “To create an EDL” (page 69), allowing sub clips to be added immediately to the EDL. You can determine whether the current EDL is selected or not by checking whether the current EDL icon is displayed or not in the status display area. If the current EDL is not specified, you must select an existing EDL as the current EDL using the following procedure before you can add sub clips.

- 1 Select an EDL on a clip list screen.

- 2 Display the P1 EDL page of the Clip F menu and press the SET CURT.EDL function button (F1).

The selected EDL becomes the current EDL.  
When the current EDL is specified, the current EDL icon appears in the status display area.

### Adding on clip list screens

See page 58 for information about screen operations.

- 1 On a clip list screen, select the clip to add as a sub clip (multiple selections possible).
- 2 Press and hold the SHIFT button and press the PUSH SET knob or display the P1 EDL page of the Clip F menu then press the ADD TO CURT.EDL function button (F4).

The sub clip addition starts. When addition is finished, the screen displayed during execution disappears and returns to the clip list screen. Adding a sub clip simultaneously saves the EDL.

The clip is added to the end of the current EDL. The current EDL remains selected.

### Adding in the video monitor screen

When checking the image on the video monitor screen, a range to use as a sub clip can be specified and added to the current EDL. This operation is supported during playback (including when stopped) and when searching. During recording, the currently recording clip cannot be added as a sub clip to the current EDL, but IN/OUT points can still be set.

- 1 On the video monitor screen, cue the frame you want to specify for the IN point.
- 2 Press and hold the ◀/IN button, and then press the PUSH SET knob.

The IN/OUT setting window appears on the bottom right of the display.  
The timecode for the IN point is displayed in the IN/OUT setting window, and the IN indicator is lit.

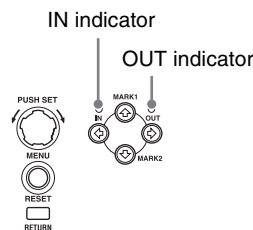
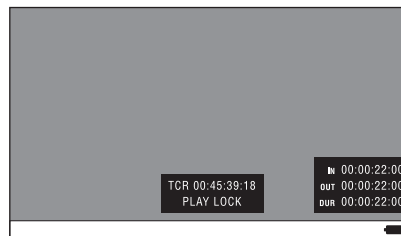

- 3 Cue the frame you want to specify for the OUT point.
- 4 Press and hold the ▶/OUT button, and then press the PUSH SET knob.  
The IN/OUT setting window appears on the bottom right of the display.  
The timecodes for the OUT point and duration (DUR) are displayed in the IN/OUT setting window, and the OUT indicator is lit.
- 5 Press the PAGE/HOME button to display the function menu, and press the ADD TO CURT.EDL function button (F4).

The sub clip addition starts. When addition is finished, the screen displayed during execution disappears and returns to the video monitor screen. Adding a sub clip simultaneously saves the EDL.

The clip is added to the end of the current EDL. The current EDL remains selected.

### To delete sub clips

This operation is performed on the chapter thumbnail screen.

- 1 On the chapter thumbnail screen, select the thumbnails for the sub clips you want to delete (multiple selections possible).
- 2 Press the PAGE/HOME button to display the function menu, and press the REMOVE function button (F4).  
A confirmation message appears asking whether to execute the delete operation.
- 3 Select “OK”, and then press the PUSH SET knob. To abort, select “Cancel”.

## To play an EDL

- 1 On the chapter thumbnail screen, select the thumbnail for the sub clip you want to start playing.

**To start playing from the first frame of the EDL**  
Select the thumbnail for the first sub clip.

- 2 Press the PLAY button.

## To release the current EDL

This operation clears the current EDL from the memory in this unit. This operation is performed on clip list screens. Releasing the current EDL after editing is finished prevents changes to the settings due to incorrect operation.

- 1 On a clip list screen, display the P1 EDL page of the Clip F menu.
- 2 Press the RELEASE CURT.EDL function button (F2).  
A confirmation message appears asking you whether to execute the release operation.
- 3 Select "OK", and then press the PUSH SET knob.

The current EDL is released and the current EDL icon is removed from the status display area.

## To reference the current EDL

Referencing the current EDL displays the chapter thumbnail screen for the current EDL. This operation is performed on clip list screens.

- 1 Display the P1 EDL page of the Clip F menu.
- 2 Press the GOTO CURT.EDL function button (F6).  
The currently specified current EDL is displayed on the chapter thumbnail screen.

# Disc Operations

## Checking the disc information

- 1 On a clip list screen, press the MENU button to display the Clip menu.
- 2 Select "Media Properties", and then press the PUSH SET knob.

The properties screen for the selected disc appears.

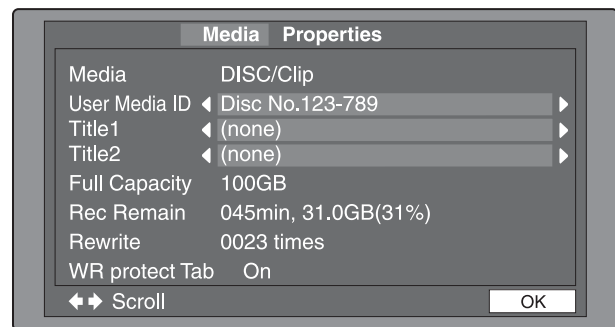

**Media:** DISC/Clip

**User Media ID:** User media ID

**Title1:** Title 1

**Title2:** Title 2

**Full Capacity:** Total capacity

**Rec Remain:** Remaining capacity for recording

**Rewrite:** Number of times the disc has been rewritten

**WR protect Tab:** Status of the Write Inhibit tab

### To display hidden text

For items displaying ◀ or ▶, press the ◀/IN or ▶/OUT button to scroll the text by one character at a time. Pressing the ▲/MARK1 or ▼/MARK2 button displays the first character or last character, respectively.

### To return to the previous screen

Press the PUSH SET knob.

## Formatting (initializing) discs

You can format recorded discs.

### Note

Finalized discs cannot be formatted.

- 1 Insert the disc you want to format into the disc slot.
- 2 Switch the display to the clip list screen.
- 3 Press the MENU button to display the Clip Menu.



- 4 Select “Format Media” and press the PUSH SET knob.

A confirmation message appears asking you whether to execute formatting.

- 5 To execute formatting, select “OK” and press the PUSH SET knob.

The formatting starts, and the message “Format Executing...” appears.

#### To cancel the formatting

Select “CANCEL” and press the PUSH SET knob.

When the formatting is completed, the message “Format was successful.” appears.

#### To format another disc

Remove the disc that has been formatted, and insert another disc into the disc slot. When the confirmation message appears asking if you want to execute formatting, execute step 5 once more.

- 6 To quit formatting, select “Exit” and press the PUSH SET knob.

---

## Finalizing discs

You can finalize write-once type Professional Discs.

### Notes

- You cannot write additional data to finalized discs.
- Finalized discs cannot be finalized again.

- 1 Insert the disc you want to finalize into the disc slot.
- 2 Switch the display to the clip list screen.
- 3 Press the MENU button to display the Clip Menu.
- 4 Select “Finalize Disc” and press the PUSH SET knob.

A confirmation message appears asking you whether to execute finalizing.

- 5 To execute finalizing, select “OK” and press the PUSH SET knob.

The finalizing starts, and the message “Finalize Executing...” appears.

#### To cancel the finalizing

Select “CANCEL” and press the PUSH SET knob.

When the finalizing is completed, the message “Finalize completed.” appears.

#### To finalize another disc

Remove the disc that has been finalized, and insert another disc into the disc slot. When the confirmation message appears asking if you want to execute finalizing, execute step 5 once more.

- 6 To quit finalizing, select “Exit” and press the PUSH SET knob.

---

## Repairing discs

If a disc is not recognized correctly, you can repair the disc for use by rebuilding the disc management data.

The repair operation can also be executed on normal discs without problem.

### Note

This function is provided in order to recover recorded material from discs in cases of unforeseen trouble, but it does not represent a 100% guarantee of data recovery.

- 1 Insert the disc you want to repair into the disc slot.

- 2 Switch the display to the clip list screen.

The clip list may not be displayed if there is an error with the disc.

- 3 Press the MENU button to display the Clip Menu.

- 4 Select “Update/Restore Media” and press the PUSH SET knob.

A confirmation message appears asking you whether to execute repairing.

- 5 To execute repairing, select “OK” and press the PUSH SET knob.

The repairing starts, and the message “Update/Restore Executing...” appears.

The repair process cannot be interrupted. When the repairing is completed, the message “Update/Restore was successful.” appears.

#### To repair another disc

Remove the disc that has been repaired, and insert another disc into the disc slot. When the confirmation message appears asking if you want to execute repairing, execute step 5 once more.

- 6 To quit repairing, select “Exit” and press the PUSH SET knob.



## Overview

A remote computer can be connected to this unit and used to operate on recorded data which has been saved in data files, such as video and audio data files.

To perform file operations, use either of the following methods to interconnect this unit and a computer.

- Make FTP connections (*see page 77*).
- Make CIFS connections (*see page 81*).

### Notes

- Discs inserted in this unit cannot be displayed or operated on the unit while there is a remote connection using FTP/CIFS from an external device.
- When disc restoration is necessary after FTP or CIFS connections are terminated, the restoration is automatically executed on this unit.
- Do not play back a clip during operation using a network connection. The output may become distorted or muted.

## Directory structure

The following figure shows an example of the directory structure visible to the computer connected to this unit.

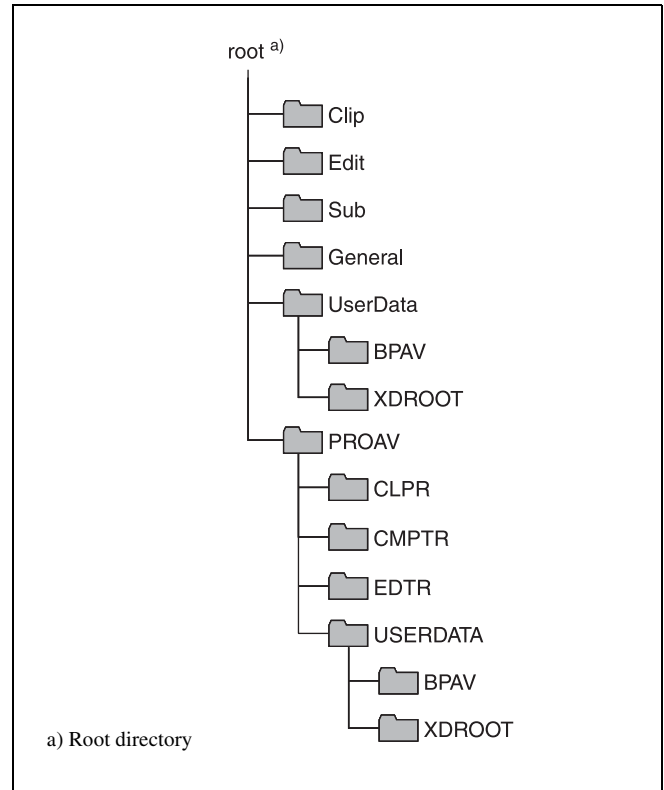

## FTPS protocol support

The unit supports the FTP and FTPS protocols. The FTPS protocol is recommended when using the unit in an insecure network environment.

## File operation restrictions

This section explains which operations are possible on files stored in each directory.

When required, the following operation tables distinguish reading and writing from partial reading and writing.

**Read:** Read data sequentially from the start to the end of the file.

**Partial read:** Read only a part of the data in the file.

**Write:** Write data sequentially from the start to the end of the file.

**Partial write:** Write data to a part of the file only.

### Note

File names are not case-sensitive.

## Root directory

File name	Content	Operations				
		Read/Partial read	Write/Partial write	Rename	Create	Delete
INDEX.XML	Contains data for management of the material on the disc.	Yes	No	No	No	No
ALIAS.XML	Contains conversion tables for assigning user-defined names to clips and clip lists.	Yes	No	No	No	No
DISCMETA.XML	Contains metadata to indicate the disc properties.	Yes	Yes <sup>a)</sup>	No	No	No
MEDIAPRO.XML	Contains a list of material on the disc, basic properties, related information, and information about access methods.	Yes	No	No	No	No
SYSPRO.XML	Contains information about device system settings and menu settings.	Yes	No	No	No	No
Other files	Files other than the above	–	No	–	No	–

a) Only files which can be written by XDCAM

### Notes

• Directories cannot be created in the root directory.

- The directories in the root directory (Clip, Edit, Sub, General, UserData, and PROAV) cannot be deleted or renamed.
- When connected by CIFS, the General and UserData directories are read only.

## Clip directory

File name	Content	Operations				
		Read/Partial read	Write/Partial write	Rename	Create	Delete
C*.MXF <sup>a)</sup>	Clip file creating during recording (MXF file) *: 0001 to 9999	Yes	Yes <sup>b), c)</sup>	Yes	Yes <sup>b)</sup>	Yes <sup>d)</sup>
C*M01.XML <sup>a)</sup>	Metadata file generated automatically when C*.MXF file is created. *: 0001 to 9999	Yes	Yes <sup>e)</sup>	No <sup>f)</sup>	No <sup>g)</sup>	No <sup>h)</sup>
C*M02.KLV <sup>a)</sup>	User metadata file. This type of file is generated automatically during recording via an FTP connection when the unit recognizes that an MXF file contains metadata that was generated by a non-XDCAM device. *: 0001 to 9999	Yes	Yes <sup>c)</sup>	No <sup>f)</sup>	Yes <sup>e)</sup>	Yes <sup>h)</sup>
Other files	Files other than the above	–	No	–	No	–

- a) The unit can handle files with user-defined names in the “C\*” part.
- b) Only files which are 2 seconds or longer in length, in a format matching the format (system frequency) and recording format (MPEG HD and number of audio channels) of the recorded sections of the disc, and which can be overwritten by XDCAM. (Partial writing is not possible.)
- c) Overwriting is not possible.
- d) Any clip may be selected and deleted.
- e) Only files which can be written by XDCAM
- f) When the “C\*” part of a C\*.MXF file name is changed, a C\*M01.XML file and a C\*M02.KLV file with the same name in the “C\*” part are also changed automatically.

- g) When a C\*.MXF file is created, a C\*M01.XML file with the same name in the “C\*” part is created automatically.
- h) When a C\*.MXF file is deleted, a C\*M01.XML file and a C\*M02.KLV file with the same name in the “C\*” part are also deleted automatically.

**Note**

Directories cannot be created in the Clip directory.

## Edit directory

File name	Content	Operations				
		Read/Partial read	Write/Partial write	Rename	Create	Delete
E*E01.SMI <sup>a)</sup>	Clip list file *: 0001 to 0099	Yes	Yes <sup>b)</sup>	Yes	Yes <sup>c)</sup>	Yes
E*M01.XML <sup>a)</sup>	Metadata file generated automatically when E*E01.SMI file is created. *: 0001 to 0099	Yes	Yes <sup>b)</sup>	No <sup>d)</sup>	No <sup>e)</sup>	No <sup>f)</sup>
Other files	Files other than the above	–	No	–	No	–

- a) The unit can handle files with user-defined names in the “E\*” part.
- b) Only files which can be written by XDCAM. Partial writing is not possible.
- c) Only files which can be written by XDCAM
- d) When the “E\*” part of an “E\*01.SMI” file name is changed, an E\*M01.XML file with the same name in the “E\*” part is also changed automatically.
- e) When an E\*E01.SMI file is created, an E\*M01.XML file with the same name in the “E\*” part is also generated automatically.
- f) When an E\*E01.SMI file is deleted, an E\*M01.XML file with the same name in the “E\*” part is also deleted automatically.

**Note**

Directories cannot be created in the Edit directory.

## Sub directory

File name	Content	Operations				
		Read/Partial read	Write/Partial write	Rename	Create	Delete
C*S01.MXF <sup>a)</sup>	Proxy AV data (MXF) file generated automatically when a C*.MXF file is created. *: 0001 to 9999	Yes	No	No <sup>b)</sup>	No <sup>c)</sup>	No <sup>d)</sup>
Other files	Files other than the above	–	No	–	No	–

- a) The unit can handle files with user-defined names in the “C\*” part.
- b) When the “C\*” part of a C\*.MXF file name is changed, a C\*S01.MXF file with the same name in the “C\*” part is changed automatically.
- c) When a C\*.MXF file is created, a C\*S01.XML file with the same name in the “C\*” part is generated automatically.
- d) When a C\*.MXF file is deleted, the C\*S01.XML file with the same name in the “C\*” part is also deleted automatically.

**Note**

Directories cannot be created in the Sub directory.

## General directory

File name	Content	Operations				
		Read/Partial read	Write/Partial write	Rename	Create	Delete
Any file		Yes	Yes	Yes <sup>a)</sup>	Yes	Yes

- a) UTF-8 file names can be up to 63 bytes in length. (Depending on the character type, file names (including extension) may be limited to 21 characters.)

The following directory operations are possible in the General directory.

- Directory creation (up to 63 levels, including the General directory)
- Deletion and renaming of directories

**Notes**

- The maximum number of files that can be created on a disc is 5,000 for single-layer discs, 6,000 for dual-layer

discs, and 20,000 for triple-layer and quad-layer discs (including directories).

- File names and directory names can use letters, numbers, and symbols from the Unicode 2.0 (UTF-8) character set.

However, the following control characters and symbols cannot be used.

- Control characters: U+0000 to U+001F, U+007F
- Symbols: ", \*, /, :, <, >, ?, \, |

## UserData directory

File name	Content	Operations				
		Read/Partial read	Write/Partial write	Rename	Create	Delete
Any file		Yes	Yes	Yes <sup>a)</sup>	Yes	Yes

a) UTF-8 file names can be up to 63 bytes in length. (Depending on the character type, file names (including extension) may be limited to 21 characters.)

The following directory operations are possible in the UserData directory.

- Directory creation (up to 62 levels, including the UserData directory)
- Deletion and renaming of directories

### XDROOT and BPAV folders

An XDROOT folder or BPAV folder will be created in the UserData directory when using this unit or Content Browser to copy to or from the UserData directory.

Folders, files, and other data making up the clips are stored in the XDROOT and BPAV folders, and modifying the data in these folders using a device other than this unit or Content Browser may render the clips inoperable. Always use this unit or Content Browser to modify clips in the XDROOT and BPAV folders.

### PROAV directory

This directory contains individual files recorded on the disc.

To display the PROAV directory, set maintenance menu item M33 FILE I/F CONFIG > PROAV DISPLAY to “enable”.

*For details, refer to the Service Manual.*

# FTP File Operations

File operations between this unit and a remote computer can be carried out by the File Transfer Protocol (FTP).

## Preparations

- 1 Connect the network connectors of this unit and a remote computer with a network cable (*see connections illustration on page 27*). Or connect this unit to the network to which the remote computer is connected (*see connections illustration on page 27*).
- 2 Set the IP address and other network setting items for this unit.<sup>1)</sup>

*For details, refer to M5: NETWORK of the maintenance menu.*

**If network settings have already been made**  
Check the IP address of this unit.

*For details, refer to M5: NETWORK of the maintenance menu.*

1) This unit is able to acquire an IP address automatically from a DHCP server. It also supports an Auto-IP function to assign an IP address automatically when access from this unit to the DHCP server times out. You can check DHCP settings and the assigned IP address with maintenance menu item M51 IP ADDRESS.

### To connect a computer running Windows Vista/Windows 7/Windows 8

Disable the Internet Protocol Version 6 (TCP/IPv6).

**Windows Vista:** (1) Open “Network and Sharing Center” > “Manage network connections” > “Local Area Connection” in the control panel. (2) In the “Local Area Connection Properties”, uncheck the “Internet Protocol Version 6 (TCP/IPv6)”, and then click the “OK” button.

**Windows 7:** (1) Open “View network status and tasks” > “Change adapter settings” > “Local Area Connection” in the control panel. (2) In the “Local Area Connection Properties”, uncheck the “Internet Protocol Version 6 (TCP/IPv6)”, and then click the “OK” button.

**Windows 8:** (1) Open “View network status and tasks” > “Change adapter settings” > “Ethernet” in the control panel. (2) In the “Ethernet Properties”, uncheck the “Internet Protocol Version 6 (TCP/IPv6)”, and then click the “OK” button.

- 3 Set the remote control switch to “NET” (*see page 11*).

## Making FTP connections

FTP connections between this unit and a remote computer can be made with either of the following.

- The command prompt
- FTP client software

This section explains how to use the command prompt. For more information about using FTP client software, refer to the documentation of the FTP client software on your system.

### To log in

- 1 Put the unit into the following state.
  - Recording, playback, search and other disc operations (*see page 47*): Stopped
  - Display screen: Other than the clip list screen (*see page 58*)
- 2 Start the command prompt.
- 3 Enter “ftp <SP> <IP address>”, and press the Enter key. (<SP> refers to a space.)

For example, if the IP address of this unit is set to “192.168.001.010”, enter “ftp 192.168.1.10”.

*Refer to the Windows help for more information about the FTP command.*

If the connection succeeds, you are prompted to enter a user name.

- 4 Enter the user name “admin” and press the Enter key.  
When the user name is verified, you are prompted to enter a password.
- 5 Enter the password and press the Enter key.

The password is set to the model name (“pdw-hd1550”) when the unit is shipped from the factory. The login is complete when the password is verified.

*See page 78 for the FTP protocol commands supported by this unit.*

### If the connection times out

This unit terminates FTP connections if no command is received within 90 seconds of the last command. If this occurs, log out (*see page 78*) and repeat steps 2 to 4.

### Note

If you power this unit off during an FTP connection, the data transferred thus far is discarded.

## To log out

To log out after finishing file operations, enter “QUIT” at the command prompt and press the Enter key.

---

## Command list

The FTP protocol commands supported by this unit include standard commands (*see page 78*) and extended commands (*see page 80*).

### Notes

- To execute FTP commands, you must install application software with FTP function on your computer.
- The commands supported by application software vary.
- An FTP client that supports UTF-8 is required to use Unicode characters other than ASCII characters. Command prompt FTP commands do not support UTF-8.

## Standard commands

In the command syntax, <SP> means a space, entered by pressing the space bar, and <CRLF> means a new line, entered by pressing the Enter key.

---

### USER

Send this command to begin the login process.

**Command syntax:** USER <SP> <user name> <CRLF>

**Input example:** USER admin

---

### PASS

After sending the USER command, send this command to complete the login process.

**Command syntax:** PASS <SP> <password> <CRLF>

**Input example:** PASS pdw-hd1550

---

### QUIT

Terminates the FTP connection. If a file is being transferred, terminates after completion of the transfer.

**Command syntax:** QUIT <CRLF>

---

### PORT

Specifies the IP address and port to which this unit should connect for the next file transfer (for data transfer from this unit).

**Command syntax:** PORT <SP> <h1,h2,h3,h4,p1,p2> <CRLF>

- h1 (most significant byte) to h4 (least significant byte): IP address
- p1 (most significant byte), p2 (least significant byte): Port number

**Input example:** PORT 10,0,0,1,242,48

(IP address: 10.0.0.1, Port number: 62000)

---

### PASV

This command requests this unit to “listen” on a data port (which is not its default data port). (It puts this unit into passive mode, waiting for the remote computer to make a data connection.)

**Command syntax:** PASV <CRLF>

---

### TYPE

Specifies the type of data to be transferred.

**Command syntax:** TYPE <SP> <type-code (options delimited by <SP>)> <CRLF>

<type-code> can be any of the following. However, for XDCAM, data is always transferred as “I”, regardless of the type-code specification.

- A: ASCII
  - N: Non-print
  - T: Telnet format
  - C: ASA Carriage Control
- E: EBCDIC
  - N: Non-print
  - T: Telnet format
  - C: ASA Carriage Control
- I: IMAGE (Binary) (default)
- L: LOCAL BYTE
  - SIZE: Byte size

**Input example:** TYPE I

---

### STRU

Specifies the data structure.

**Command syntax:** STRU <SP> <structure-code> <CRLF>

<structure-code> can be any of the following. However, for XDCAM, the structure is always “F”, regardless of the structure-code specification.

- F: File structure (default)
- R: Record structure
- P: Page structure

**Input example:** STRU F

---

### MODE

Specifies the transfer mode.

**Command syntax:** MODE <SP> <mode-code> <CRLF>

<mode-code> can be any of the following. However, for XDCAM, the mode is always “S”, regardless of the mode-code specification.

- S: Stream mode (default)

- B: Block mode
- C: Compressed mode

**Input example:** MODE S

---

## LIST

Sends a list of files from this unit to the remote computer.

**Command syntax:** LIST <SP> <options> <SP> <path-name> <CRLF>

<options> can be any of the following.

- -a: Also display file names that begin with “.”
- -F: Append “/” to directory names.

The following data is transferred, depending on whether <path-name> specifies a directory or file.

- Directory specified: A list of the files in the specified directory
- File specified: Information about the specified file
- No specification: A list of the files in the current directory

The wildcard characters “\*” (any string) and “?” (any character) may be used in <path-name>.

**Input example 1:** LIST-a Clip

**Input example 2:** LIST Clip/\*.MXF

---

## NLST

Sends a list of file names from this unit to the remote computer, with no other information.

**Command syntax:** NLST <SP> <options or path-name> <CRLF>

The following options may be specified when no path-name is specified.

- -a: Also display file names that begin with “.”
- -l: Display information other than file name (gives the same result as the LIST command).
- -F: Append “/” to directory names.

The following data is transferred, depending on whether <path-name> specifies a directory or file.

- Directory specified: A list of the file names only in the specified directory
- No specification: A list of the file names only in the current directory.

The wildcard characters “\*” (any string) and “?” (any character) may be used in <path-name>.

**Input example 1:** NLST-l

**Input example 2:** NLST Clip/\*.MXF

---

## RETR

Begins transfer of a copy of a file in the specified path on this unit to the current directory on the remote computer.

**Command syntax:** RETR <SP> <path-name> <CRLF>

**Input example:** RETR Clip/C0001.MXF

---

## STOR

Begins transfer of a copy of a file in the specified path on the remote computer to the current directory on this unit.

**Command syntax:** STOR <SP> <path-name> <CRLF>

**Input example:** STOR Edit/E0001E01.SMI

---

## RNFR

## RNTO

Renames a file.

Specify the file to be renamed with the RNFR command, and specify the new name with the RNTO command. (Always follow a RNFR command with a RNTO command.)

*For details, see “File operation restrictions” (page 74).*

**Command syntax:** RNFR <SP> <path-name (before change)> <CRLF>

**RNTO <SP> <path-name (after change)> <CRLF>**

**Input example:** RNFR General/info.txt

RNTO General/clip\_info.txt

---

## DELE

Deletes the specified file on this unit.

### Note

Depending on the directory and file type, deletion may not be possible.

*For details, see “File operation restrictions” (page 74).*

**Command syntax:** DELE <SP> <path-name> <CRLF>

**Input example:** DELE Clip/C0099.MXF

---

## STAT

Sends information about properties of the specified file, or about data transfer status, from this unit to the remote computer.

**Command syntax:** STAT <SP> <path-name> <CRLF>

The following data is transferred, depending on whether a file is specified with <path-name>.

- File specified: The properties of the specified file
- No specification: The size of the data transferred thus far (unit: bytes)

**Input example:** STAT Clip/C0001.MXF

---

**ABOR**

Requests this unit to abort a file transfer currently in progress.

**Command syntax:** ABOR <CRLF>

---

**SYST**

Displays the system name of this unit.

**Command syntax:** SYST <CRLF>

---

**HELP**

Displays a list of the commands supported by this unit, or an explanation of the specified command.

**Command syntax:** HELP <SP> <command-name>  
<CRLF>

The following data is transferred, depending on whether a command name is specified with <command-name>.

- Command name specified: Explanation of the specified command.
- No specification: Command list

**Input example:** HELP RETR

---

**NOOP**

Does nothing except return a response. (Used to check whether this unit is running.)

**Command syntax:** NOOP <CRLF>

---

**PWD**

Displays the current directory (“/” if the directory is the root directory).

**Command syntax:** PWD <CRLF>

---

**CWD**

Changes the current directory (moves from the current directory to another directory).

**Command syntax:** CWD <SP> <path-name> <CRLF>

Moves to a directory as follows, depending on whether a directory is specified with <path-name>.

- Directory specified: To the specified directory
- No specification: To the root directory

**Input example:** CWD General

---

**CDUP**

Moves one level up in the directory structure (makes the parent of the current directory be the current directory).

**Command syntax:** CDUP <CRLF>

---

**MKD**

Creates a new directory.

**Command syntax:** MKD <SP> <path-name> <CRLF>

---

**RMD**

Deletes a directory.

**Command syntax:** RMD <SP> <path-name> <CRLF>

**Note**

Some limitations apply to the deletion of directories.

*For details, see “File operation restrictions” (page 74).*

**Extended commands**

In the Command syntax, <SP> means a space, entered by pressing the space bar, and <CRLF> means a new line, entered by pressing the Enter key.

---

**SITE DF**

Displays the remaining space of the applicable media in the current directory.

**Command syntax:** SITE DF<CRLF>

---

**SITE\_MEID**

Displays the ID of the applicable media in the current directory.

**Command syntax:** SITE\_MEID<CRLF>

---

**SITE CHMOD**

Locks and unlocks clips. Also sets permissions for directories and files.

**Command syntax:** SITE CHMOD <SP> <flag> <SP>  
<path-name> <CRLF>

Specify one of the following values in <flag>, according to the specification in <path-name>.

- When a clip is specified in <path-name>
  - 444: Lock.
  - 666: Unlock.
- When a directory is specified in <path-name>
  - 555: Forbid writing to the directory.
  - 777: Allow writing to the directory.
- When a file is specified in <path-name>
  - 444: Forbid writing to and execution of the file.
  - 555: Forbid writing to the file, but allow execution.
  - 666: Allow writing to the file, but forbid execution.
  - 777: Allow writing to and execution of the file.

**Input example:** SITE CHMOD 444 Clip/C0001.MXF  
(Lock clip C0001.MXF)



---

# CIFS File Operations

You can perform file operations using the Common Internet File System (CIFS) between this unit and the computer.

## Preparations

See “Preparations” under “FTP File Operations” (page 77).

---

## Making CIFS connections

CIFS connections between this unit and a Windows computer can be made with either of the following.

- Use Windows Explorer to map this unit as a network drive
- Refer to this unit directly from Windows Explorer

The following describes the procedure for using Windows Explorer to map this unit as a network drive.

- 1** Start Windows Explorer.
- 2** In the Tools menu, select “Map Network Drive...”.  
The “Map Network Drive” dialog appears.
- 3** Enter “\\<IP address>\xdcam\” in the “Folder” field.  
For example, if the IP address of this unit is set to “192.168.001.010”, enter “\\192.168.1.10\xdcam\”.
- 4** Click on “Connect using a different user name.”.  
The “Connect As...” dialog appears.
- 5** Enter the user name “admin” and the password, and click “OK”.  
The password is set to the model name (“pdw-hd1550”) when the unit is shipped from the factory.
- 6** Click “Finish”.  
The network drive allocation is complete when the password is verified.

### To break the connections

In Windows Explorer, select the network drive and right-click it, then click “Disconnect”.

## Menu System Configuration

The settings for this unit use the following menus.

### Setup menu

The setup menu system of this unit comprises the basic setup menu and extended setup menu.

### Function menu

For details, see “Basic Operations of the Function Menu” (page 39).

### Clip Menu

For details, see “Clip Menu” (page 62).

### Maintenance menu

This provides audio control, and network and setup menu settings, and also shows version information.

#### To display the maintenance menu

Display the basic operation screen or the video monitor screen, and press the MENU button while holding down the SHIFT and PAGE/HOME buttons.

For details, refer to the Service Manual.

## Setup Menu

The setup menu system of this unit comprises the basic setup menu and extended setup menu.

### Basic menu

This menu is used to make settings related to, for example, the operating hours meter, the content and display of text information, and the menu banks for saving menu settings.

### Extended menu

This menu is used to make a wide range of settings relating to the functions of this unit, for example, the control panel functions, video and audio control, and digital data processing.

Maintenance menu item M40 EXTEND MENU must be set to “ENABLE” in order to display the extended menu.

For details, refer to the Service Manual.

### Configuration of the basic menu

The basic menu comprises the following groups of items.

Item group	Function	Refer to
Items H01 to H19	Display the total number of hours the unit has been powered on, and other information collected by the operating hours meter	page 102
Items 001 to 099	Settings relating to the superimposed text information, switching between 59.94i, 59.94P, 29.97P, 50i, 50P and 25P.	page 83
Items B01 to B20	Settings relating to the menu banks for saving menu settings	page 85

### Configuration of the extended menu

The extended menu comprises the following groups of items.

Item group	Function	Refer to
Items 100 to 199	Settings relating to control panels	page 89
Items 200 to 299	Settings relating to the remote control interface	page 91
Items 300 to 399	Settings relating to editing operations	page 91
Items 500 to 599	Settings relating to disc protection	page 91

Item group	Function	Refer to
Items 600 to 649	Settings relating to the timecode generator	page 92
Items 650 to 699	Settings relating to metadata	page 93
Items 700 to 799	Settings relating to video control	page 94
Items 800 to 899	Settings relating to audio control	page 96
Items 900 to 999	Settings relating to digital processing	page 98

## Items in the basic menu

The basic menu items (excluding the items related to the operating hours meter) are listed in the following table.

- The values in the “Settings” column are the values that appear on settings screens. The values in brackets [ ] are the value shown on menu screens (when they differ from the values shown on settings screens).
- The underlined values are the factory defaults.

Item number	Item name	Settings
002	CHARACTER H-POSITION	<p>Adjust the horizontal screen position (as a hexadecimal value) of the text information output from the COMPOSITE OUTPUT 2 (SUPER), SDDSI OUTPUT 2 (SUPER), HSDSI OUTPUT 2 (SUPER), or HDMI OUT connector for superimposed display on the monitor. The hexadecimal value 00 is for the far left of the screen. Increasing the value moves the position of the characters to the right.</p> <p><b>00 to <u>0C</u> to 28 (When the number of system lines is 1080 and the system frequency is 59.94i, 29.97P, 50i, 25P, or 23.98P)</b></p> <p><b>00 to <u>0B</u> to 28 (When the number of system lines is 720 and the system frequency is 59.94P or 50P)</b></p> <p>Set this item by adjusting to the required position while viewing the monitor.</p>
003	CHARACTER V-POSITION	<p>Adjust the vertical screen position (as a hexadecimal value) of the text information output from the COMPOSITE OUTPUT 2 (SUPER), SDDSI OUTPUT 2 (SUPER), HSDSI OUTPUT 2 (SUPER), or HDMI OUT connector for superimposed display on the monitor. The hexadecimal value 00 is for the top of the screen. Increasing the value lowers the position of the characters.</p> <p><b>00 to <u>2A</u> to 32 (When the number of system lines is 1080 and the system frequency is 59.94i, 29.97P, 50i, 25P, or 23.98P)</b></p> <p><b>00 to <u>29</u> to 32 (When the number of system lines is 720 and the system frequency is 59.94P or 50P)</b></p> <p>Set this item by adjusting to the required position while viewing the monitor.</p>
005	DISPLAY INFORMATION SELECT	<p>Determine the kind of text information to be output from the COMPOSITE OUTPUT 2 (SUPER), SDDSI OUTPUT 2 (SUPER), HSDSI OUTPUT 2 (SUPER), or HDMI OUT connector.</p> <p><b>time data &amp; status [T&amp;sta]:</b> Time data and the units status.</p> <p><b>time data &amp; UB [T&amp;UB]:</b> Time data and user bits data. (When “UB” (user bits data) is selected with CNTR SEL on the HOME page of the function menu, the “user bits data” and “time data” arranged in that order are displayed.)</p> <p><b>time data &amp; CNT [T&amp;CNT]:</b> Time data and counter count. (When “COUNTER” is selected with CNTR SEL on the HOME page of the function menu, the counter count and time data arranged in that order are displayed.)</p> <p><b>time data &amp; time data [T&amp;T]:</b> Time data and timecode (TC or VITC)</p> <p><b>time data only [time]:</b> Time data only</p>

Item number	Item name	Settings	
006	LOCAL FUNCTION ENABLE	Determine which recording and playback control buttons on the front panel are enabled when this unit is controlled from external equipment. <b>all disable [dis]:</b> All buttons and switches are disabled. <b>stop &amp; eject [st&amp;ej]:</b> Only the STOP button and EJECT button are enabled. <b>all enable [ena]:</b> All buttons and switches are enabled.	
009	CHARACTER TYPE	Determine the type of characters such as timecode output from the COMPOSITE OUTPUT 2 (SUPER), SDDS I OUTPUT 2 (SUPER), HDSDI OUTPUT 2 (SUPER), or HDMI OUT connector for superimposed display on the monitor. <b>white:</b> White letters on a black background <b>black:</b> Black letters on a white background <b>white/outline [W/out]:</b> White letters with black outline <b>black/outline [B/out]:</b> Black letters with white outline	
011	CHARACTER V-SIZE	Determine the vertical size of characters such as timecode output from the COMPOSITE OUTPUT 2 (SUPER), SDDS I OUTPUT 2 (SUPER), HDSDI OUTPUT 2 (SUPER), or HDMI OUT connector for superimposed display on the monitor. <b>×1:</b> Standard size <b>×2:</b> 2 times standard size  Set this item by selecting the required size while viewing the monitor.	
012	CONDITION DISPLAY ON VIDEO MONITOR	Select whether to display disc condition marks in external monitor output (output from the COMPOSITE OUTPUT 2 (SUPER) connector, SDDS I OUTPUT 2 (SUPER) connector, HDSDI OUTPUT 2 (SUPER) connector, or HDMI OUT connector). <b>disable [dis]:</b> Do not display. <b>enable [ena]:</b> Display.	
013	SYSTEM FREQUENCY SELECT MENU	Specify whether to enable switching the system frequencies. <b>off:</b> Do not enable switching the system frequency. <b>on:</b> Enable switching the system frequency.  You can switch between the following frequencies. 1080/59.94i, 50i, 29.97P, 25P, 23.98P, 720/59.94P, 50P  <i>For details about switching the system frequency, see page 34.</i>  <b>Note</b> Settings for both basic and extended menu items are saved separately for different system frequencies. <ul style="list-style-type: none"> <li>• 1080 59.94i/29.97P</li> <li>• 1080 50i/25P</li> <li>• 1080 23.98P</li> <li>• 720 59.94P</li> <li>• 720 50P</li> </ul> Therefore, when you switch the system frequency, all menu items are reset to the current settings for the new mode. (They are different from the setting for the previous mode.)	
027	SD CHARACTER	Specify whether to superimpose text information on the SD video signal.	
	Sub-item		
	1	SD-SDI2 <sup>a)</sup>	Specify whether to superimpose text information on the video signal output from the SDDS I OUTPUT 2 (SUPER) connector. <b>off:</b> Do not superimpose. <b>on:</b> Superimpose.
	2	COMPOSITE2 <sup>a)</sup>	Specify whether to superimpose text information on the video signal output from the COMPOSITE OUTPUT 2 (SUPER). <b>off:</b> Do not superimpose. <b>on:</b> Superimpose.
	3	LCD	Specify whether to superimpose text information on the video signal output to the display on the front panel. <b>off:</b> Do not superimpose. <b>on:</b> Superimpose.



Item number	Item name	Settings
028	HD CHARACTER	Specify whether to superimpose text information on the HD video signal.
	Sub-item	
	1 HD-SDI2	Specify whether to superimpose text information on the video signal output from the HDSDI OUTPUT 2 (SUPER) connector. <b>off:</b> Do not superimpose. <b>on:</b> Superimpose.
2	HDMI <sup>a)</sup>	Specify whether to superimpose text information on the video signal output from the HDMI OUT connector when the HDMI output is the same with the SDI output. <b>off:</b> Do not superimpose. <b>on:</b> Superimpose.
029	STORED OWNERSHIP	Specify whether to enable changing UMID ownership information settings (COUNTRY, ORGANIZATION and USER). <b>off:</b> Do not enable. <b>on:</b> Enable. <i>See "Using UMID Data" (page 116) for more information about UMID.</i>
031	RECORDING FORMAT	Set the recording format. <b>AI422:</b> XAVC Intra 1920×1080 422 <sup>b)</sup> <b>HD422:</b> HD422 <b>HD420 HQ [420HQ]:</b> HD420 HQ <b>HD420 SP [420SP]:</b> HD420 SP <sup>a), b)</sup> <b>IMX 50Mbps [IMX50]:</b> MPEG IMX 50 Mbps <sup>a)</sup> <b>IMX 30Mbps [IMX30]:</b> MPEG IMX 30 Mbps <sup>a)</sup> <b>DVCAM:</b> DVCAM <sup>a)</sup>
033	BATTERY END VOLTAGE	Set the voltage at which to shut down the unit during battery operation. The battery near end indicator flashes at +0.7 V of the set voltage. <b>10.5V to 13.5V:</b> 10.5 V to 13.5 V in 0.5 V unit.
036	FILE NAMING	Set the clip name to be assigned to a clip to record.
	Sub-item	
	1 PREFIX	Set the prefix of the clip name (up to 10 characters). The allowable characters are alphanumeric characters, symbols (! # \$ % & ' ( ) + , - . ; = @ [ ] ^ _ { } ~), and the space character. <b>CLIP</b>
	2 NUMERIC	Set the initial value of the numeric part (00001 to 99999, five-digit serial number) of the clip name. <b>00001</b>
3	AUTO NAMING	Specify the clip naming format. <b>prefix:</b> Generate clip names using PREFIX and NUMERIC. <b>C****:</b> Generate names in PDW-series standard format. (****: numeric portion) (File names become C****.MXF with numeric portion in ascending order.)
B01	RECALL SETUP BANK-1	Set to "on" to recall menu bank 1 to replace the current menu settings.
B02	RECALL SETUP BANK-2	Set to "on" to recall menu bank 2 to replace the current menu settings.
B03	RECALL SETUP BANK-3	Set to "on" to recall menu bank 3 to replace the current menu settings.
B11	SAVE SETUP BANK-1	Set to "on" to save current menu settings to menu bank 1.
B12	SAVE SETUP BANK-2	Set to "on" to save current menu settings to menu bank 2.
B13	SAVE SETUP BANK-3	Set to "on" to save current menu settings to menu bank 3.
B20	RESET SETUP MENU	Set to "on" to return the settings of the current menu to the factory default settings.

a) Not displayed when the unit is in 23.98P mode.  
b) Not displayed when the unit is in 59.94P/50P mode.

## Basic menu operations

Setup menus are displayed on the display or on a monitor connected to the HDMI OUT connector.

### To display the setup menu

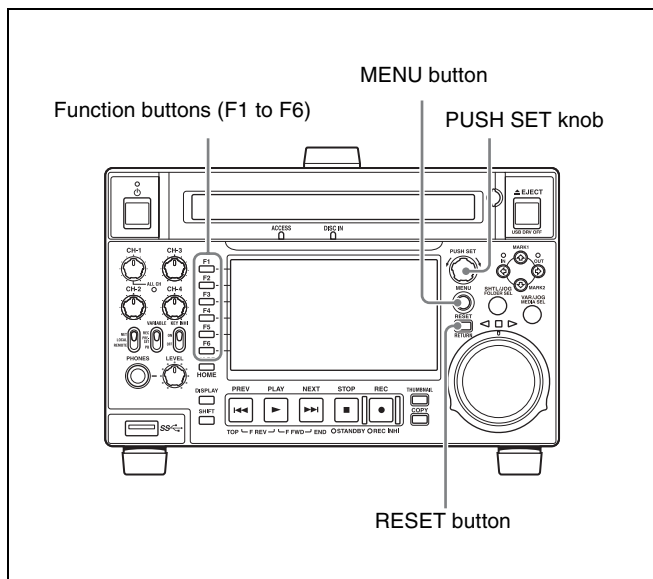

To display a setup menu, press the MENU button. The currently selected menu item is displayed in reverse video.

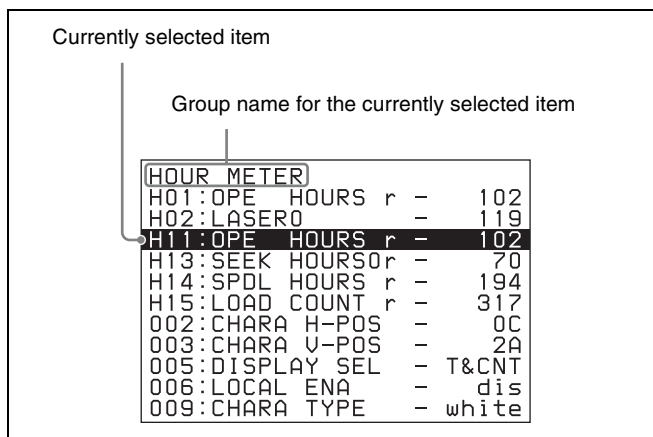

### Buttons used to change settings

Use the following buttons to change setup menu settings.

Menu control buttons	Functions
MENU button	Displays and hides the menu.

Menu control buttons	Functions
PUSH SET knob	<ul style="list-style-type: none"> <li>When turned clockwise or counterclockwise, moves the reverse video to select the item to change.</li> <li>When turned clockwise or counterclockwise, changes a menu item setting.</li> <li>When pressed, answers "Yes" to a question.</li> </ul>
Function buttons F1 to F6 (The function to be displayed varies depending on the situation.)	<p><b>RETURN:</b> Goes up one level.</p> <p><b>SELECT:</b> Selects an item.</p> <p><b>UP:</b> Skips back 100 or 50 items in the list of menu items.</p> <p><b>DOWN:</b> Skips forward 100 or 50 items in the list of menu items.</p> <p><b>SAVE:</b> Saves a new setting to memory.</p> <p><b>EXIT:</b> Exits the current menu.</p> <p><b>-:</b> Changes a setting.</p> <p><b>+:</b> Changes a setting.</p>
RESET button	<ul style="list-style-type: none"> <li>Returns the current setting to the factory default.</li> <li>Answers "No" to a question.</li> </ul>

### To change the settings of menu items

Proceed as follows to change the settings of menu items.

**1** Use the PUSH SET knob to select the required item.

**Example:** Screen display when item 005 DISPLAY SEL is selected

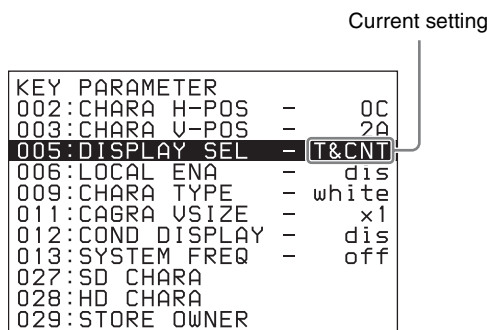

**2** Press the PUSH SET knob or the SELECT function button (F2).

This displays the setting screen for the menu item selected in step 1.

**Example:** Setting screen display when item 005 DISPLAY INFORMATION SELECT is selected

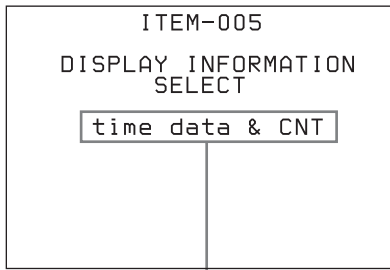

Current setting

- 3** Use the PUSH SET knob or the +/- function button (F3 or F4) to change the setting.

Turning the PUSH SET knob while holding down the SHIFT button increases the increment of adjustment.

- 4** To change other settings, press the PUSH SET knob or the RETURN function button (F1) to return to the previous screen, then repeat steps **1** to **3**.

- 5** When you have completed the settings, press the SAVE function button (F5).

The message “NOW SAVING...” appears on the video monitor screen, while the new settings are saved in memory. When the save operation is completed, the video monitor screen returns to its normal display.

#### Notes

- If you power off the unit before a save operation is completed, settings may be lost. Wait until the save is completed before powering off the unit.
- If, instead of pressing the SAVE function button (F5), you press the MENU button, the new settings are not saved. The message “ABORT !” appears on the video monitor screen for about 0.5 seconds, and the system exits the menus. To change more than one setting, be sure to press the SAVE function button (F5) after making the settings.

### To return menu settings to their factory default settings

After changing menu settings, use the following procedure to return the settings to their factory default settings (setting initialization).

#### To return a particular setting to its factory default setting

On the screen that selects the setting of that item, press the RESET button.

For example, proceed as follows to return the 005 DISPLAY INFORMATION SELECT item to its default setting. This assumes that the setting has been changed from the factory default “time data & status” in step **3** of the procedure in “To change the settings of menu items” (page 86).

- 1** Press the RESET button.  
“time data & status” (factory default setting) is selected.

- 2** Press the SAVE function button (F5).

The setting returned to its factory default is saved in memory as the current setting.

### To return all settings to their factory default settings

- 1** Press the MENU button to display the setup menu.

- 2** Press the RESET button.

The message “INITIALIZE ALL ITEMS TO FACTORY PRESET VALUES?” appears, to confirm whether you wish to return all settings to their factory default settings.

- 3** Press the SAVE function button (F5).

The message “NOW SAVING...” appears on the video monitor screen, while the settings of all items are returned to their factory default settings. These factory default settings are saved in memory.

If you power off the unit while settings are being saved, settings may not be correctly returned to their factory default settings. Wait until the save operation is completed before powering off the unit.

#### To abandon the resetting operation

Instead of pressing the SAVE function button (F5), press the RESET button.

The display returns to the top level of the setup menu, leaving the settings unchanged.

## Menu bank operations (menu items B01 to B13)

You can save menu settings in a menu bank. Menu settings saved in a menu bank can be recalled and used when needed.

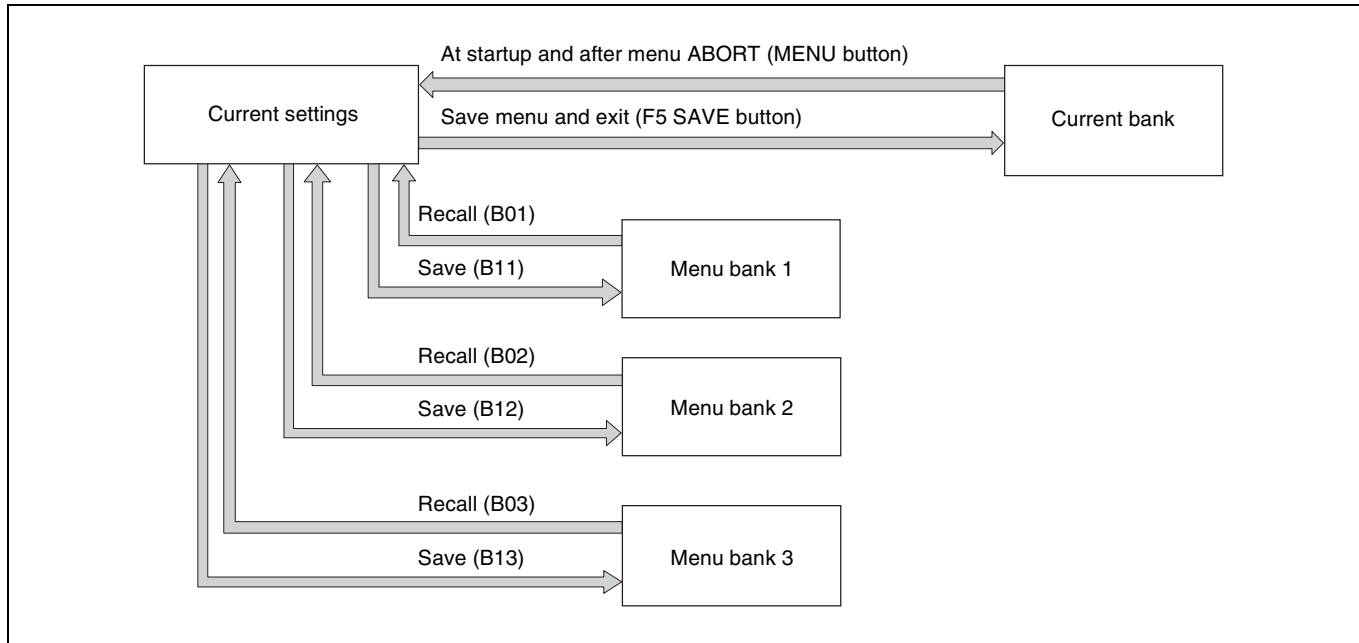

### To save the current settings in a menu bank

- 1 Select a menu item from B11 “SAVE SETUP BANK-1” to B13 “SAVE SETUP BANK-3” using the PUSH SET knob.
- 2 Press either the PUSH SET knob or the SELECT function (F2) button.
- 3 Change the setting to “on” using either the PUSH SET knob or + function (F4) button.
- 4 Press the SAVE function (F5) button.

“NOW SAVING...” is displayed, and the current settings are saved in the selected menu bank.

#### Note

Settings are not saved in the current bank when saving to a menu bank. To save changed settings in both a menu bank and the current bank, press the SAVE function (F5) button again after saving the settings in a menu bank to save the settings in the current bank.

### To recall settings saved in a menu bank

- 1 Select a menu item from B01 “RECALL SETUP BANK-1” to B03 “RECALL SETUP BANK-3” using the PUSH SET knob.

- 2 Press either the PUSH SET knob or the SELECT function (F2) button.
- 3 Change the setting to “on” using either the PUSH SET knob or + function (F4) button.
- 4 Press the LOAD function (F5) button.  
“NOW LOADING...” is displayed, and the settings saved in the selected menu bank are loaded as the current settings.
- 5 Press the SAVE function (F5) button.  
“NOW SAVING...” is displayed, and the current settings are saved in the current bank. When saving is finished, the display returns to the operating screen.



## Items in the extended menu

The following tables show the items in the extended menu.

- The values in the “Settings” column are the values that appear on settings screens. The values in brackets [ ] are the value shown on menu screens (when they differ from the values shown on settings screens).

- The underlined values are the factory defaults.

Menu items in the 100s, relating to the control panels

Item number	Item name	Settings
101	SELECTION FOR SEARCH DIAL ENABLE	Select how the unit enters the jog, shuttle, or variable mode. <b>dial direct [dial]</b> : Press the SHTL/JOG or VAR/JOG button or, except during recording/editing, turn the jog dial or shuttle dial. <b>via search key [key]</b> : Press the SHTL/JOG or VAR/JOG button.
105	REFERENCE SYSTEM ALARM	Select whether to display a warning when the reference video signal is not being supplied, or when it differs from this unit's system frequency. <b>off</b> : No warning. <b>on</b> : Flash the STOP button as a warning.
108	AUTO EE SELECT	If PB/EE is set to “EE” on the P5 OTHER page in the function menu, this selects the operation modes in which video/audio signal are handled as EE signals. <b>stop/f.fwd/f.rev [S/F/R]</b> : In stop, forward direction high-speed search, and reverse direction high-speed search modes. <b>stop</b> : In stop mode.
109	FORCED EE WHEN DISC UNLOAD	During disc loading/unloading and when no disc is inserted, select whether to control the output signal PB/EE setting. <b>on</b> : Do not control (the signal is always an EE signal). <b>off</b> : Control.
114	AUDIO MONITOR OUTPUT LEVEL	Select whether to control the level of the audio signal output from the AUDIO MONITOR OUTPUT R, L connectors with the LEVEL adjustment knob for the PHONES jack. <b>variable [var]</b> : Control. <b>fixed</b> : Do not control.
121	FRAME PB MODE	Select the variable-speed playback field/frame mode. <b>auto</b> : Field playback <b>frame</b> : Frame playback. Compared to field playback, frame playback gives more detail during playback of still pictures.
130	DISPLAY DIMMER CONTROL	Set the brightness of the display on the LCD. <b>10%, 25%, 50%, <u>75%</u>, 100%</b>
131	AUDIO VOLUME	Select whether each of the CH-1/ALL CH, CH-2 to CH-4 adjustment knobs on the control panel is enabled to control the audio recording level and playback level on each channel or the CH-1/ALL CH adjustment knob alone functions as a master control to control the audio level on all channels together. <b>each</b> : Each of the CH-1/ALL CH, CH-2 to CH-4 adjustment knobs is enabled to control each channel. <b>all</b> : The CH-1/ALL CH adjustment knob alone functions as a master control. When “all” is selected, the ALL CH indicator under the CH-1/ALL CH adjustment knob lights up.

Menu items in the 100s, relating to the control panels

Item number	Item name	Settings
142	REPEAT MODE	<p>Set whether to set repeat playback mode.</p> <p><b>off:</b> Do not set repeat playback mode.</p> <p><b>play &amp; VAR fwd [P&amp;VAR]:</b> Perform repeat playback during normal playback and 0 to +1 times normal speed variable playback in the forward direction. To select repeat playback in this mode from a device connected to the REMOTE (9P) connector, send the “REPEAT PLAY” command or the “REPEAT VAR FWD” command.</p> <p><b>force:</b> Perform repeat playback during normal playback and 0 to +1 times normal speed variable playback in the forward direction. To select repeat playback in this mode from a device connected to the REMOTE (9P) connector, send the “PLAY” command or the “VAR FWD” command.</p> <p>When “play &amp; VAR fwd” or “force” is selected, the icon indicating repeat playback mode appears on the basic operation screen. When “on” is selected also in setup menu item 154, the icon indicating both single clip playback mode and repeat playback mode appears on the basic operation screen.</p>
143	INDEX PICTURE POSITION	<p>Select the frame of the clip to use as the thumbnail image (index picture) when recording.</p> <p><b>0sec to 10sec:</b> Can be set in the range from 0 seconds (first frame of the clip) to 10 seconds, in units of 1 second.</p>
145	MODE KEY ENABLE DURING RECORDING	<p>Set the mode buttons enabled during recording.</p> <p><b>all enable [ena]:</b> All buttons are enabled.</p> <p><b>stop:</b> Only the STOP button is enabled.</p>
150	REC MODE	<p>Select the recording mode.</p> <p><b>normal [norm]:</b> Normal recording mode</p> <p><b>disc exchange cache [D.EXC]:</b> Disc Exchange Cache mode</p>
151	GUI OPERATION	<p>Set whether to disable switching to the clip list screens.</p> <p><b>enable [ena]:</b> Enabled</p> <p><b>via stop [stop]:</b> Disabled (executable from stop mode only)</p>
153	FIND MODE	<p>Specify the frame to cue up when the PREV or NEXT button is pressed.</p> <p><b>clip:</b> The first frame of the clip</p> <p><b>clip &amp; rec start mark [R.ST]:</b> The frame where a Rec Start essence mark is set (if no essence mark is set, the first frame of the clip)</p>
154	SINGLE CLIP PLAY MODE	<p>Put the unit into single clip playback mode, or exit from single clip playback mode.</p> <p><b>off:</b> Exits from single clip playback mode. (Puts the unit into continuous playback mode.)</p> <p><b>on:</b> Puts the unit into single clip playback mode.</p> <p>When “on” is selected, the icon indicating single clip playback mode appears on the basic operation screen. When “play &amp; VAR fwd” or “force” is selected also in setup menu item 142, the icon indicating both single clip playback mode and repeat playback mode appears on the basic operation screen.</p>
161	HDMI OUT SELECT	<p>Specify which signal to output from the HDMI OUT connector: the same signal as the SDI connector output, or the same signal as the SDI connector output and thumbnails view signal by automatically switching between them.</p> <p><b>auto:</b> Output the same signal as the SDI connector output and thumbnails view signal by automatically switching between them.</p> <p><b>SDI [sdi]:</b> Output the same signal as the SDI connector output.</p>

**Menu items in the 200s, relating to the remote control interface**

Item number	Item name	Settings
201	PARA RUN	Select whether to use synchronized operation, when you have connected two or more PDW-HD1550 units in a daisy chain or distributed configuration, and are using external control from a VTR or a remote controller such as the RM-280. <b>disable [dis]:</b> No synchronized operation <b>enable [ena]:</b> Use synchronized operation  <b>Notes</b> <ul style="list-style-type: none"> <li>• If you are controlling from a VTR, select “enable” on all of the PDW-HD1550 units.</li> <li>• If you controlling from the RM-280 or another remote control device, select “disable” on one of the PDW-HD1550 units and select “enable” on all of the other PDW-HD1550 units.</li> </ul>
214	REMOTE INTERFACE	When the remote control switch is set to REMOTE, select the device from which to remote-control this unit. <b>9PIN:</b> Device connected to the REMOTE (9P) connector. <b>SDI:</b> Device connected to the SD/HDSDI INPUT connector.
257	NETWORK ENABLE	Select the remote control switch positions which enable network connections. <b>network [net]:</b> Only when the remote control switch is set to “NET”. <b>network &amp; remote(9PIN) [n&amp;9P]:</b> When the remote control switch is set to “NET”, or when the switch is set to “REMOTE” and setup menu item 214 is set to “9PIN”.
259	NETWORK INTERFACE	Select network protocols to be enabled. <b>FTP/CIFS [ftp]:</b> Enable FTP and CIFS. <b>NET-RMT [nrmt]:</b> Enable NetAPI and WebAPI. <b>ALL [all]:</b> Enable all protocols.

**Menu items in the 300s, relating to editing operations**

Item number	Item name	Settings
320	DIGITAL AUDIO PB PROCESS ON EDIT POINT	Specify the handling of audio at edit points. <b>cut:</b> Carry out a cut (possibly resulting in audio discontinuities at the edit point). <b>fade:</b> Fade out and fade in.

**Menu items in the 500s, relating to disc protection**

Item number	Item name	Settings
501	STILL TIMER	To protect the disc against shock and vibration, and to lengthen the life of the laser diodes, the unit automatically enters standby state whenever a specified time elapses in a disc stop mode (stop mode or the still picture mode of search mode). This allows you to set the time after which the unit exits the disc stop mode and enters standby state. <b>0.5 sec [0.5 s]... 8 min [8 m]... 30 min [30 m]:</b> Can be set in the range from 0.5 seconds to 30 minutes. <b>off:</b> Do not put into standby state.

Menu items in the 600s, relating to the timecode and metadata

Item number	Item name	Settings
601	VITC POSITION SEL-1 <sup>a)</sup>	In 59.94i/59.94P/29.97P mode Select the line into which to insert VITC signals (SD output) <b>12H to 16H to 20H:</b> Any line from line 12 through line 20. <b>Notes</b> <ul style="list-style-type: none"> <li>You can insert VITC signals in two places. To insert in two places, set both item 601 and item 602.</li> <li>In 59.94i/59.94P/29.97P mode (J), output of wide picture information is given priority if OUTPUT in setup menu item 731 is set to “auto” and the VITC insertion line is set to line 16.</li> <li>In 59.94i/59.94P/29.97P mode (UC), output of wide picture information is given priority if OUTPUT in setup menu item 731 is set to “auto” and the VITC insertion line is set to line 20.</li> </ul>
		In 50i/50P/25P mode Select the line into which to insert VITC signals (SD output) <b>9H to 19H to 22H:</b> Any line from line 9 through line 22. <b>Note</b> You can insert VITC signals in two places. To insert in two places, set both item 601 and item 602.
602	VITC POSITION SEL-2 <sup>a)</sup>	In 59.94i/59.94P/29.97P mode Select the line into which to insert VITC signals (SD output) <b>12H to 18H to 20H:</b> Any line from line 12 through line 20. <b>Notes</b> <ul style="list-style-type: none"> <li>You can insert VITC signals in two places. To insert in two places, set both item 601 and item 602.</li> <li>In 59.94i/59.94P/29.97P mode (J), output of wide picture information is given priority if OUTPUT in setup menu item 731 is set to “auto” and the VITC insertion line is set to line 16.</li> <li>In 59.94i/59.94P/29.97P mode (UC), output of wide picture information is given priority if OUTPUT in setup menu item 731 is set to “auto” and the VITC insertion line is set to line 20.</li> </ul>
		In 50i/50P/25P mode Select the line into which to insert VITC signals (SD output) <b>9H to 21H to 22H:</b> Any line from line 9 through line 22. <b>Note</b> You can insert VITC signals in two places. To insert in two places, set both item 601 and item 602.
605	TCG REGEN MODE	Select the signal to be regenerated when the timecode generator is in regeneration mode. <b>TC&amp;UB:</b> Both the timecode and user bits are regenerated. <b>TC:</b> Only the timecode is regenerated. <b>UB:</b> Only the user bits are regenerated.
607	U-BIT BINARY GROUP FLAG	Select the user bits to be used in the timecode generated by the timecode generator. <b>000: not specified [000]:</b> Character set not specified. <b>001: iso character [001]:</b> 8-bit characters compliant with ISO 646 and ISO 2022. <b>010: unassigned-1 [010]:</b> Undefined. <b>011: unassigned-2 [011]:</b> Undefined. <b>100: unassigned-3 [100]:</b> Undefined. <b>101: page / line [101]:</b> SMPTE-262M page/line multiplex system. <b>110: unassigned-4 [110]:</b> Undefined. <b>111: unassigned-5 [111]:</b> Undefined.
611	TC OUTPUT PHASE IN EE MODE	Select the timecode output mode for output from the TIME CODE OUT connector in EE mode. <b>through [thru]:</b> Output the timecode input to the TIME CODE IN connector as is. <b>video input phase [v-in]:</b> Output the timecode with the same phase as the input video signal phase. <b>video output phase [v-out]:</b> Output the timecode with the same phase as the output video signal phase.

Menu items in the 600s, relating to the timecode and metadata

Item number	Item name	Settings
618	UPCONV EMBEDDED VITC <sup>a)</sup>	Select the source of the VITC embedded in the output HDSDI signal when up-converting during playback of an SD clip. <b>VITC:</b> Select the VITC of the SD clip. <b>LTC:</b> Select the LTC of the SD clip.
619	VITC <sup>a)</sup>	Select whether to record the VITC generated by the internal timecode generator during IMX recording. <b>off:</b> Do not record the internally generated VITC. <b>on:</b> Record the internally generated VITC. <b>Note</b> Even if this item is set to “off”, VITC is recorded if the input video signal contains VITC and the VITC line is set to “thru” in menu item 723.
651	UMID SDI OUTPUT	Select whether to output UMID in the VANC of the SDI output. <b>off:</b> Do not output. <b>on:</b> Output.  <i>See “Using UMID Data” (page 116) for more information about UMID.</i>
652	UMID SD VANC LINE <sup>a)</sup>	Select the line in which UMID is output when menu item 651 is set to “on”. <b>12H, 13H, 15H, 16H, 17H, 18H, 19H (59.94i/59.94P/29.97P mode)</b> <b>9H, 10H, 12H, 13H, 14H, 15H, 16H, 17H, 18H (50i/50P/25P mode)</b>  <i>See “Using UMID Data” (page 116) for more information about UMID.</i>
653	UMID HD VANC LINE	Select the line in which UMID is output when menu item 651 is set to “on”. <b>9H to 17H to 20H (59.94i, 50i, 29.97P, 25P, 23.98P mode)</b> <b>9H to 17H to 25H (59.94P, 50P mode)</b>  <i>See “Using UMID Data” (page 116) for more information about UMID.</i>
657	ESSENCE MARK SDI OUTPUT	Select whether to output essence marks in the SDI output VANC. <b>off:</b> Do not output. <b>on:</b> Output.
660	ESSENCE MARK SD VANC LINE <sup>a)</sup>	Select the line to which to output essence marks when menu item 657 is set to “on”. <b>12H, 13H, 15H, 16H, 17H, 18H, 19H (59.94i/59.94P/29.97P mode)</b> <b>9H, 10H, 12H, 13H, 14H, 15H, 16H, 17H, 18H (50i/50P/25P mode)</b>
665	ESSENCE MARK HD VANC LINE	Select the line to which to output essence marks when menu item 657 is set to “on”. <b>9H to 17H to 20H (59.94i, 50i, 29.97P, 25P, 23.98P mode)</b> <b>9H to 17H to 25H (59.94P, 50P mode)</b>
666	METADATA ITEM OUT	Specify whether to include the information from recorded VANC packets in data items in the DATA ITEM section of MXF files. <b>off:</b> Do not include VANC packet information in DATA ITEM. <b>on:</b> Include VANC packet information in DATA ITEM.
668	USER META DATA OUTPUT IN MXF	Select whether to output user metadata to MXF files. <b>off:</b> Do not output. <b>on:</b> Output.

a) Not displayed when the unit is in 23.98P mode.

Menu items in the 700s, relating to video control

Item number	Item name	Settings	
703	BLANK LINE SELECT <sup>a)</sup>	Switch blanking of the video output signal on or off for individual lines in the vertical blanking interval.	
	Sub-item	The Y/C signal and odd/even fields are blanked simultaneously.	
	ALL LINE	--: Specify the blanking for each line separately. <b>blank [blank]</b> : Regardless of the setting of other sub-items, blank all lines which can be specified in this menu item. <b>thru [thru]</b> : Regardless of the setting of other sub-items, switch off blanking for all lines which can be specified in this menu item.	
	In 59.94i/59.94P/ 29.97P mode (UC)	LINE 12 ... LINE 19	Specify blanking for lines 12 to 19. <b>blank [blank]</b> : Carry out blanking. <b>thru [thru]</b> : Switch off blanking.
		LINE 20	Specify blanking for line 20. <b>blank [blank]</b> : Carry out blanking. <b>half</b> : Carry out half-blanking. <b>thru [thru]</b> : Switch off blanking.
	In 59.94i/59.94P/ 29.97P mode (J)	LINE 12 ... LINE 20	Specify blanking for lines 12 to 20. <b>blank [blank]</b> : Carry out blanking. <b>thru [thru]</b> : Switch off blanking.
		LINE 21	Specify blanking for line 21. <b>blank [blank]</b> : Carry out blanking. <b>half</b> : Carry out half-blanking. <b>thru [thru]</b> : Switch off blanking.
	In 50i/50P/25P mode	LINE 9, 322 ... LINE 22, 335	Specify blanking for lines 9, 322 to 22, 335. <b>blank [blank]</b> : Carry out blanking. <b>thru [thru]</b> : Switch off blanking.
LINE 23		Specify blanking for line 23. <b>half</b> : Carry out half-blanking. <b>thru [thru]</b> : Switch off blanking.	
705	EDGE SUBCARRIER REDUCER MODE <sup>a)</sup>	Select whether to enable the edge subcarrier reducer (ESR). <b>on</b> : Enable ESR. <b>off</b> : Do not enable ESR.	
707	FORCED VERTICAL INTERPOLATION OFF	The "Y-add" function is normally switched on automatically during jog or variable-speed playback. This item selects whether to force the "Y-add" function off. <b>auto</b> : Automatically switch the "Y-add" function on. <b>forced YADD off [off]</b> : Force the "Y-add" function off.  The "Y-add" function is a circuit operation to interpolate the video signal vertically during jog or variable-speed playback for the purpose of reducing the vertical movement of the playback picture.	
710	INTERNAL VIDEO SIGNAL GENERATOR	Select the test signal to be output from the internal test signal generator. When INT SG on page P1 INPUT of the function menu is set to "ON", the internal test signal generator operates to output the selected test signal. This signal can also be recorded. <b>Off [OFF]</b> : Do not output test signal. <b>75% Color Bars [CB75]</b> : 75% color bar signal <b>100% Color Bars [CB100]</b> : 100% color bar signal <b>Multi Burst [MLTBS]</b> : Multi-burst signal <b>10 steps [10STP]</b> : 10-step signal <b>Pulse and Bar [PLSBR]</b> : Pulse and bar signal <b>Ramp [RAMP]</b> : Ramp signal <b>Black [BLACK]</b> : Black signal <b>ARIB Color Bars [ARBCB]</b> : ARIB color bar signal (modify width: 100%)  <b>Note</b> "ARIB Color Bars" cannot be specified when SD recording is selected. If "ARIB Color Bars" is selected, the selection is changed to "75% Color Bars" ([CB75]).	

Menu items in the 700s, relating to video control

Item number	Item name	Settings	
713	VIDEO SETUP REFERENCE <sup>b)</sup>	Set the video setup amount to be added to the composite output signal.	
	Sub-item		
	OUTPUT LEVEL	In 59.94i/59.94P/29.97P mode (UC) Add the setup level selected by this item to the output signal. <b>0.0%, 7.5%</b>	
		In 59.94i/59.94P/29.97P mode (J) Add the setup level selected by this item to the output signal. <b>0.0%, 7.5%</b>	
715	VIDEO GAIN CONTROL <sup>a)</sup>	Adjust the video output level of SD video signals output from the SDDSI OUTPUT, COMPOSITE OUTPUT, or HDMI OUT connectors. <b>-2048 to 0 to 848</b>	
716	CHROMA GAIN CONTROL <sup>a)</sup>	Adjust the chroma output level of SD video signals output from the SDDSI OUTPUT, COMPOSITE OUTPUT, or HDMI OUT connectors. <b>-2048 to 0 to 848</b>	
717	CHROMA PHASE CONTROL <sup>a)</sup>	Adjust the chroma phase of SD video signals output from the SDDSI OUTPUT, COMPOSITE OUTPUT, or HDMI OUT connectors. <b>-128 to 0 to 127</b>	
718	SETUP LEVEL (59.94i/59.94P/29.97P mode)/BLACK LEVEL (50i/50P/25P mode) <sup>a)</sup>	Adjust the setup level (black level) of SD video signals output from the SDDSI OUTPUT, COMPOSITE OUTPUT, or HDMI OUT connectors. <b>-272 to 0 to 272</b>	
719	SYSTEM PHASE SYNC <sup>a)</sup>	Adjust the sync phase of SD video signals output from the SDDSI OUTPUT, COMPOSITE OUTPUT, or HDMI OUT connectors. <b>-128 to 0 to 127</b>	
720	SYSTEM PHASE SC <sup>a)</sup>	Adjust the subcarrier phase of SD video signals output from the SDDSI OUTPUT, COMPOSITE OUTPUT, or HDMI OUT connectors. <b>0 to 511</b>	
723	INPUT VIDEO BLANK <sup>a)</sup>	Switch blanking on or off for lines in the vertical blanking interval of input video signals. Lines can be specified individually. Y/C signals and odd/even fields are blanked simultaneously. Blanking in recorded signals is carried out according to these settings.	
	Sub-item		
	1	ALL LINE	<b>---</b> : Specify the blanking for each line separately <b>blank [blank]</b> : Regardless of the settings of other sub-items, blank all lines which can be specified in this menu item. <b>thru [thru]</b> : Regardless of the settings of other sub-items, switch blanking off for all lines which can be specified in this menu item.
	2 1 10	LINE12- LINE20	In 59.94i/59.94P/29.97P mode Specify blanking for lines 12 to 20. <b>blank [blank]</b> : Switch blanking on. <b>thru [thru]</b> : Switch blanking off.
2 1 15	LINE9, 322- LINE22, 335	In 50i/50P/25P mode Specify blanking for lines 9, 322 to 22, 335. <b>blank [blank]</b> : Switch blanking on. <b>thru [thru]</b> : Switch blanking off.	
726	H BLANKING WIDTH <sup>a)</sup>	Select the horizontal blanking width of the output analog video signal. <b>narrow [narrow]</b> : Digital blanking (narrow) <b>wide</b> : Analog blanking (wide) When "wide" is selected, the horizontal blanking width complies with SMPTE-170M, and normally the blanking is widened and the image becomes narrower. It is recommended to select "narrow" at the editing stage, then later, for broadcast transmission to select "wide", to output a signal conforming to the standard. Note, however, that "narrow" has to be always selected for SDI signals.	
728	OUTPUT SCH PHASE <sup>a)</sup>	Set the subcarrier H phase. <b>-512 to 0 to 511</b>	

### Menu items in the 700s, relating to video control

Item number	Item name	Settings
731	WIDE MODE <sup>a)</sup>	Specify whether to record and play back with the addition of wide picture information.
	Sub-item	
	1 INPUT	Select whether to save wide picture information when recording. <b>auto:</b> Automatically save wide picture information when it is detected in the selected input video signal. <b>on:</b> Always save wide picture information. <b>off:</b> Never save wide picture information
2 OUTPUT	Select whether to add wide picture information to the signal output when down-converter output is set to squeeze mode. <b>through [thru]:</b> Do not add. <b>auto:</b> Add. <b>Notes</b> <ul style="list-style-type: none"> <li>To add wide picture information to the output signal, another setting is required in addition to this item. In setup menu item 703, set line 16 (59.94i/59.94P/29.97P mode (J)), line 20 (59.94i/59.94P/29.97P mode (UC)), or line 23 (50i/25P mode) to "thru".</li> <li>In 59.94i/59.94P/29.97P mode (J), output of wide picture information is given priority if the VITC insertion line is set to line 16 in setup menu item 601 or 602.</li> <li>In 59.94i/59.94P/29.97P mode (UC), output of wide picture information is given priority if the VITC insertion line is set to line 20 in setup menu item 601 or 602.</li> </ul>	
740	MASTER LEVEL (HD)	Adjust the high-definition video signal output from the HDSDI OUTPUT or HDMI OUT connectors. This adjusts the Y, PB, and PR levels simultaneously. <b>-2048 to 0 to 846</b>
741	Y LEVEL (HD)	Adjust the Y level of the high-definition video signal output from the HDSDI OUTPUT or HDMI OUT connectors. <b>-2048 to 0 to 846</b>
742	PB LEVEL (HD)	Adjust the PB level of the high-definition video signal output from the HDSDI OUTPUT or HDMI OUT connectors. <b>-2048 to 0 to 846</b>
743	PR LEVEL (HD)	Adjust the PR level of the high-definition video signal output from the HDSDI OUTPUT or HDMI OUT connectors. <b>-2048 to 0 to 846</b>
745	SETUP LEVEL (HD)	Adjust the setup level of the high-definition video signal output from the HDSDI OUTPUT or HDMI OUT connectors. <b>-272 to 0 to 272</b>
746	SYNC PHASE (HD)	Control the H sync phase of the high-definition video signal output from the HDSDI OUTPUT or HDMI OUT connectors. <b>-128 to 0 to 127</b>
747	FINE (HD)	Fine control the H sync phase of the high-definition video signal output from the HDSDI OUTPUT or HDMI OUT connectors. <b>0 to 1023</b>

a) Not displayed when the unit is in 23.98P mode.

b) Not displayed when the unit is in 50i/50P/25P/23.98P mode.

### Menu items in the 800s, relating to audio control

Item number	Item name	Settings
802	DIGITAL AUDIO MUTING IN SHUTTLE MODE	Set the audio muting conditions during shuttle playback. <b>off:</b> Not muted. <b>on:</b> Muted.
807	AUDIO OUTPUT PHASE	Set the output timing of digital audio playback signals (HDSDI, SDI only) as a hexadecimal value, with 80 as a reference position. Output timing is earlier for values smaller than 80 and later for values greater than 80. (80 with 128 samples = approx. 2.7 ms, 80 with 1 sample = approx. 20 μs) <b>0 to 80 to FF:</b> Values can be set in this range.



Menu items in the 800s, relating to audio control

Item number	Item name	Settings	
808	INTERNAL AUDIO SIGNAL GENERATOR	Select the operation of the internal audio test signal generator. <b>off:</b> Do not output test signal. <b>silence [silnc]:</b> Silent signal <b>1kHz sine [1kHz]:</b> 1 kHz, -20 dB FS sine wave signal When you set the INT SG item on page P1 INPUT of the function menu to "ON", the internal signal generator operates and outputs simultaneous test signals to channels 1 to 8 (see page 40).	
815	AUDIO SAMPLING RATE CONVERTER	Select the mode of operation of the sampling rate converter for AES/EBU input to channels 1 to 4. <b>off:</b> Do not operate. <b>on:</b> Operate.	
823	NON-AUDIO FLAG PB	Control non-audio flags in digital audio output.	
	Sub-item		
	1	CH1/CH2	During playback (except in EE mode), set non-audio flags in digital audio output to the following states. <b>on:</b> Set to on (data is non-audio.) <b>auto:</b> Set as follows. <ul style="list-style-type: none"> <li>• When data is read from a disc and confirmed: Follow the state on the disc.</li> <li>• When data from a disc is not confirmed: Maintain current state.</li> </ul>
	2	CH3/CH4	
	3	CH5/CH6	
4	CH7/CH8		
824	ANALOG LINE OUTPUT SELECT	Select the analog audio signals (tracks 1 to 8) to be assigned to audio output channels 1 and 2. <b>tr1/2:</b> Tracks 1 and 2 assigned to audio output channels 1 and 2. <b>tr3/4:</b> Tracks 3 and 4 assigned to audio output channels 1 and 2. <b>tr5/6:</b> Tracks 5 and 6 assigned to audio output channels 1 and 2. <b>tr7/8:</b> Tracks 7 and 8 assigned to audio output channels 1 and 2.	
827	AES/EBU AUDIO OUTPUT SELECT	Select the audio signals to assign to AES/EBU audio output channels.	
	Sub-item		
	1	CH1/CH2	<b>tr1/2:</b> Tracks 1 and 2 assigned to audio output channels 1 and 2. <b>tr3/4:</b> Tracks 3 and 4 assigned to audio output channels 1 and 2. <b>tr5/6:</b> Tracks 5 and 6 assigned to audio output channels 1 and 2. <b>tr7/8:</b> Tracks 7 and 8 assigned to audio output channels 1 and 2.
	2	CH3/CH4	<b>tr1/2:</b> Tracks 1 and 2 assigned to audio output channels 3 and 4. <b>tr3/4:</b> Tracks 3 and 4 assigned to audio output channels 3 and 4. <b>tr5/6:</b> Tracks 5 and 6 assigned to audio output channels 3 and 4. <b>tr7/8:</b> Tracks 7 and 8 assigned to audio output channels 3 and 4.
828	SDI AUDIO OUTPUT SELECT	Select the audio signals to assign to SDI audio output channels.	
	Sub-item		
	1	CH1/CH2	<b>tr1/2:</b> Tracks 1 and 2 assigned to audio output channels 1 and 2. <b>tr3/4:</b> Tracks 3 and 4 assigned to audio output channels 1 and 2. <b>tr5/6:</b> Tracks 5 and 6 assigned to audio output channels 1 and 2. <b>tr7/8:</b> Tracks 7 and 8 assigned to audio output channels 1 and 2.
	2	CH3/CH4	<b>tr1/2:</b> Tracks 1 and 2 assigned to audio output channels 3 and 4. <b>tr3/4:</b> Tracks 3 and 4 assigned to audio output channels 3 and 4. <b>tr5/6:</b> Tracks 5 and 6 assigned to audio output channels 3 and 4. <b>tr7/8:</b> Tracks 7 and 8 assigned to audio output channels 3 and 4.
834	AUDIO INPUT LEVEL	Select the analog audio input source.	
	Sub-item		
	1	CH1	<b>line:</b> Line input <b>mic:</b> Microphone input
	2	CH2	<b>line:</b> Line input <b>mic:</b> Microphone input

### Menu items in the 800s, relating to audio control

Item number	Item name	Settings
839	AUDIO AGC/LIMITER MODE	For automatic input level adjustments performed on the analog audio signals recorded on channels 1 and 2, select whether to perform the adjustments in stereo mode or independently for channels 1 and 2. <b>mono:</b> Perform automatic adjustments independently for channels 1 and 2. <b>stereo:</b> Perform automatic adjustments in stereo mode.
840	AUDIO AGC SELECT	Set the AGC saturation level. <b>off:</b> AGC does not operate. <b>-6dB, -9dB, -12dB, -15dB, -17dB:</b> AGC operates when the VARIABLE switch is set to PRESET. <b>Note</b> This setting is enabled only for channels that have “mic” (microphone input) selected in setup menu item 834. For channels that have “line” (line input) selected, this function is “off” regardless of the item setting.
841	AUDIO LIMITER SELECT	Select the limiter saturation level, for limiting large input signals, for use in manual adjustment of audio input levels. <b>off:</b> The limiter does not operate. <b>-6dB, -9dB, -12dB, -15dB, -17dB:</b> The limiter operates when the VARIABLE switch is set to REC or PB. <b>Note</b> This setting is enabled only for channels that have “mic” (microphone input) selected in setup menu item 834. For channels that have “line” (line input) selected, this function is “off” regardless of the item setting.

### Menu items in the 900s, relating to digital processing

Item number	Item name	Settings	
920	SD-SDI H-ANC CONTROL <sup>a)</sup>	Select whether to add information to the SDI output.	
	Sub-item		
	1	AUDIO 5CH-8CH	<b>off:</b> Do not add digital audio data channels 5 to 8. <b>on:</b> Add digital audio data channels 5 to 8.
	2	RP188 ATC	<b>off:</b> Do not add RP188 timecode data. <b>on:</b> Add RP188 timecode data.
925	HDMI OUTPUT SELECT <sup>a)</sup>	Select the resolution of the video output from the HDMI OUT connector. <b>1080i, 480i, 480P (59.94i, 29.97P mode)</b> <b>1080i, 576i, 576P (50i, 25P mode)</b> <b>720P, 480i, 480P (59.94P mode)</b> <b>720P, 576i, 576P (50P mode)</b>	
930	DOWN CONVERTER MODE <sup>a)</sup>	Select the down-converter mode. <b>EDGE CROP [CROP]:</b> Select the edge crop mode. <b>LETTER BOX [L-BOX]:</b> Select the letter box mode. <b>SQUEEZE [SQUEZ]:</b> Select the squeeze mode.	
931	DOWN CONVERTER LETTER BOX MODE <sup>a)</sup>	Select the aspect ratio of the down-converter output when menu item 930 is set to “LETTER BOX”. <b>16:9:</b> Set the aspect ratio of the HD-SD converter output to 16:9. <b>14:9:</b> Set the aspect ratio of the HD-SD converter output to 14:9. <b>13:9:</b> Set the aspect ratio of the HD-SD converter output to 13:9.	
932	H CROP POSITION (DC) <sup>a)</sup>	Adjust the H-crop (the horizontal position when cropping in the edge crop mode) of the down-converter output when menu item 930 is set to “EDGE CROP”. <b>-120 to 0 to 120</b>	
934	CROSS COLOR (DC) <sup>a)</sup>	Adjust the down-converter cross color. <b>0 to 8 to 15</b>	
935	DETAIL GAIN (DC) <sup>a)</sup>	Adjust the down-converter image enhancer. Adjust the sharpness of edge enhancement. <b>00 (HEX) to 7F (HEX)</b>	

Menu items in the 900s, relating to digital processing

Item number	Item name	Settings
936	LIMITER (DC) <sup>a)</sup>	Adjust the down-converter image enhancer. Set the maximum detail level added to emphasize the original signal. <b>00 (HEX) to 20 (HEX) to 3F (HEX)</b>
937	CRISP (DC) <sup>a)</sup>	Adjust the down-converter image enhancer. Set the threshold amplitude for emphasis (signals of amplitude lower than the threshold are not emphasized). <b>00 (HEX) to 0F (HEX)</b>
938	LEVEL DEPEND THRESHOLD (DC) <sup>a)</sup>	Adjust the down-converter image enhancer. Set the luminance range for edge enhancement. <b>00 (HEX) to 08 (HEX) to 0F (HEX)</b>
939	H DETAIL FREQUENCY (DC) <sup>a)</sup>	Adjust the down-converter image enhancer. Set the central frequency for edge enhancement. <b>2.6MHz, 3.4MHz, 3.9MHz, 4.6MHz</b>
940	H/V RATIO (DC) <sup>a)</sup>	Adjust the down-converter image enhancer. Set the horizontal/vertical ratio for edge enhancement. <b>00 (HEX) to 03 (HEX) to 07 (HEX)</b>
942	V FILTER SELECT (DC) <sup>a), b)</sup>	Set the vertical interpolation filter coefficient for down-converter output (in 1080 mode only). If the setting value is large, the vertical resolution is high. <b>01 (HEX) to 03 (HEX)</b>
943	CROSS COLOR CRISP (DC) <sup>a)</sup>	Set the cross color crisp level for down-converter output. <b>00 (HEX) to 04 (HEX) to 0F (HEX)</b>
944	D/C LEGALIZE (DC) <sup>a)</sup>	For down-converter output, selects whether to suppress signals with levels that are lower than the pedestal level. <b>off:</b> Do not suppress signals lower than the pedestal level. <b>on:</b> Suppress signals lower than the pedestal level.
950	UP CONVERTER MODE <sup>a)</sup>	Select the up-converter mode. <b>EDGE CROP [CROP]:</b> Select the edge crop mode. <b>LETTER BOX [L-BOX]:</b> Select the letter box mode. <b>SQUEEZE [SQUEZ]:</b> Select the squeeze mode.
951	H CROP POSITION (UC) <sup>a)</sup>	Adjust the H-crop (the horizontal position when cropping in the edge crop mode) of the up-converter output when menu item 950 is set to "EDGE CROP". <b>-120 to 0 to 120</b>
952	LETTER BOX POSITION (UC) <sup>a)</sup>	Adjust the vertical position where the picture is cut out for up-converter output in letter box mode when menu item 950 is set to "LETTER BOX". <b>-120 to 0 to 120</b>
953	UP CONVERTER PROCESS <sup>a)</sup>	Select the source picture to use in converting SD to HD. <b>FIELD:</b> Use field pictures. <b>ADAPTIVE [ADAPT]:</b> Frame or field is selected automatically.
954	DETAIL GAIN (UC) <sup>a)</sup>	Adjust the up-converter image enhancer. Adjust the sharpness of edge enhancement. <b>00 (HEX) to 40 (HEX) to 7F (HEX)</b>
955	LIMITER (UC) <sup>a)</sup>	Adjust the up-converter image enhancer. Set the maximum detail level added to emphasize the original signal. <b>00 (HEX) to 20 (HEX) to 3F (HEX)</b>
956	CRISP THRESHOLD (UC) <sup>a)</sup>	Adjust the up-converter image enhancer. Set the threshold amplitude for emphasis (signals of amplitude lower than the threshold are not emphasized). <b>00 (HEX) to 08 (HEX) to 0F (HEX)</b>
957	LEVEL DEPEND THRESHOLD (UC) <sup>a)</sup>	Adjust the up-converter image enhancer. Set the luminance range for edge enhancement. <b>00 (HEX) to 08 (HEX) to 0F (HEX)</b>

Menu items in the 900s, relating to digital processing

Item number	Item name	Settings		
958	H DETAIL FREQUENCY (UC) <sup>a)</sup>	Adjust the up-converter image enhancer. Set the center frequency and frequency properties for edge enhancement. <b>3.2MHz:</b> 3.2 MHz ±1.1 MHz <b>4.5MHz:</b> 4.5 MHz ±1.4 MHz <b>5.0MHz:</b> 5.0 MHz ±0.7 MHz <b>4.0MHz:</b> 4.0 MHz ±2.0 MHz		
959	H/V RATIO (UC) <sup>a)</sup>	Adjust the up-converter image enhancer. Set the horizontal/vertical ratio for edge enhancement. <b>00 (HEX) to 03 (HEX) to 07 (HEX)</b>		
965	IMAGE ENHANCER (INPUT UP CONVERTER) <sup>a)</sup>	Set up the operation of the up-converter image enhancer for SD input, separately from the settings for playback (menu items 950 to 959).		
	Sub-item		<p><b>pb:</b> While SD signals are input, make the behavior of the image enhancer of the up-converter follow the settings for playback (menu items 950 to 959). (Settings for sub-items 2 to 11 under menu item 965 become invalid.)</p> <p><b>input:</b> While SD signals are input, make the behavior of the image enhancer of the up-converter follow the settings for sub-items 2 to 11 under menu item 965 (separate settings during input of SD signals from those during playback).</p>	
	1	ENH SETTING		
	2	CONVERT		Select the up-converter mode. <b>EDGE CROP [CROP]:</b> Select the edge-crop mode. <b>LETTER BOX [L-BOX]:</b> Select the letter box mode. <b>SQUEEZE [SQUEEZ]:</b> Select the squeeze mode.
	3	H CROP P		Adjust the H-crop (horizontal crop) position for up-converter output in edge crop mode when sub-item CONVERT is set to "CROP". <b>-120 to 0 to 120</b>
	4	L BOX P		Adjust the vertical location of the position where the picture is cut out for up-converter output in letter box mode when sub-item CONVERT is set to "L-BOX". <b>-120 to 0 to 120</b>
	5	CNV PROC		Select the source picture to use in converting SD to HD. <b>FIELD:</b> Use field pictures. <b>ADAPTIVE [ADAPT]:</b> Frame or field is selected automatically.
	6	DETAIL		Adjust the up-converter image enhancer. Set the sharpness of edge enhancement. <b>00 to 40 to 7F (hexadecimal value)</b>
	7	LIMITER		Adjust the up-converter image enhancer. Set the maximum detail level added to emphasize the original signal. <b>00 to 20 to 3F (hexadecimal value)</b>
	8	CRISP		Adjust the up-converter image enhancer. Set the threshold amplitude at which low amplitude signals are not emphasized. <b>00 to 08 to 0F (hexadecimal value)</b>
	9	DEPEND		Adjust the up-converter image enhancer. Set the luminance range for edge enhancement. <b>00 to 08 to 0F (hexadecimal value)</b>
10	H DETL F	Adjust the up-converter image enhancer. Set the center frequency and frequency properties for edge enhancement. <b>3.2MHz:</b> 3.2 MHz ±1.1 MHz <b>4.5MHz:</b> 4.5 MHz ±1.4 MHz <b>5.0MHz:</b> 5.0 MHz ±0.7 MHz <b>4.0MHz:</b> 4.0 MHz ±2.0 MHz		
11	HV RATIO	Adjust the up-converter image enhancer. Set the horizontal/vertical ratio for edge enhancement. <b>00 to 03 to 07 (hexadecimal value)</b>		

a) Not displayed when the unit is in 23.98P mode.

b) Not displayed when the unit is in 59.94P/50P mode.



# Appendix

---

## Important Notes on Operation

### Use and storage

#### Do not subject the unit to severe shocks

The internal mechanism may be damaged or the body warped.

#### Do not cover the unit while operating

Doing so will cause temperatures to rise inside the unit, possibly resulting in failure.

#### After use

Turn off the on/standby button.

If you plan not to use the unit for a long time, turn off the POWER switch on the rear panel as well.

#### Shipping

- Remove the disc before transporting the unit.
- If sending the unit by truck, ship, air or other transportation service, pack it in the shipping carton of the unit.

#### Care of the unit

If the body of the unit is dirty, clean it with a soft, dry cloth. In extreme cases, use a cloth steeped in a little neutral detergent, then wipe dry. Do not use organic solvents such as alcohol or thinners, as these may cause discoloration or other damage to the finish of the unit.

#### In the event of operating problems

If you should experience problems with the unit, contact your Sony representative.

### Use and storage locations

Store in a level, ventilated place. Avoid using or storing the unit in the following places.

- In excessive heat or cold (operating temperature range: 5 °C to 40 °C (41 °F to 104 °F))

Remember that in summer or in warm climates the

temperature inside a car with the windows closed can easily exceed 50 °C (122 °F).

- In damp or dusty locations
- Locations where the unit may be exposed to rain
- Locations subject to violent vibration
- Near strong magnetic fields
- Close to radio or TV transmitters producing strong electromagnetic fields.
- In direct sunlight or close to heaters for extended periods

#### To prevent electromagnetic interference from portable communications devices

The use of portable telephones and other communications devices near this unit can result in malfunctions and interference with audio and video signals.

It is recommended that the portable communications devices near this unit be powered off.

### Periodic parts replacement

The battery and optical head are consumable parts that will need periodic replacement.

When operating at room temperature, a normal replacement cycle will be about 5 years.

However, this replacement cycle represents only a general guideline and does not imply that the life expectancy of these parts is guaranteed. For details on parts replacement, contact your dealer.

---

### About the LCD panel

The LCD panel fitted to this unit is manufactured with high precision technology, giving a functioning pixel ratio of at least 99.99%. Thus a very small proportion of pixels may be “stuck”, either always off (black), always on (red, green, or blue), or flashing. In addition, over a long period of use, because of the physical characteristics of the liquid crystal display, such “stuck” pixels may appear spontaneously. These problems are not a malfunction. Note that any such problems have no effect on recorded data.

---

## Condensation

If the unit is suddenly taken from a cold to a warm location, or if ambient temperature suddenly rises, moisture may form on the outer surface of the unit and/or inside of the unit. This is known as condensation. If condensation occurs, turn off the unit and wait until the condensation clears before operating the unit. Operating the unit while condensation is present may damage the unit.

---

## Periodic Maintenance

---

### Operating hours meter

The operating hours meter can provide two items of information about the operational history of the unit. The information can be displayed by text superimposition on the monitor connected to the unit. Use the information as a guide in scheduling periodic maintenance. For periodic maintenance, consult a Sony service representative.

### Display modes of the operating hours meter

#### **H01: OPERATION HOURS mode**

Displays the total number of hours the unit has been powered on in units of 1 hour.

#### **H02: LASER PARAMETER 0 mode (not resettable)**

Of the two optical heads, this shows a counter of the cumulative light output time by one optical head in units of hours.<sup>1)</sup>

This can be used as a guide in determining when to replace the optical head.

1) The counter advances at different rates during recording and playback. It is also affected by the ambient temperature.

#### **H11: OPERATION HOURS mode (resettable)**

Same as H01 except that the count is resettable.

This can be used as a guide in determining when to replace parts.

#### **H13: SEEK RUNNING HOURS 0 mode (resettable)**

Of the two optical heads, this shows the cumulative seek operation time for one optical head in units of hours. The count is resettable.

This can be used as a guide in determining when to replace the seek motor.

#### **H14: SPINDLE RUNNING HOURS mode (resettable)**

This shows the cumulative spindle rotation time, in units of hours. The count is resettable.

This can be used as a guide in determining when to replace the spindle motor.

#### **H15: LOADING COUNTER mode (resettable)**

Display the total number of times disc has been loaded in the unit. The count is resettable.

### **To display the operating hours meter**

Press the MENU button to display the setup menu, then turn the PUSH SET knob to display the required item on the monitor connected to the unit.

### **To exit from the operating hours meter**

Press the RETURN function button (F1) to return to the setup menu.

Press the EXIT function button (F6) to return to the screen that was displayed before you entered the setup menu.

# Troubleshooting

## Alarms

An alarm (warning message) appears in the status display area when an operation is attempted which is inappropriate for the settings on this unit or the state of media. Both the alarm message and the action to take to resolve the problem appear on the video monitor screen.

**High TEMP!**

Example alarm in status display area

ALARM  
HIGH TEMPERATURE.

Example alarm on video monitor screen

When an alarm is displayed, remove the alarm cause by following the action to take. If the alarm display does not disappear, contact your Sony representative.

## When the unit is powered on

Alarm message in status display area	Alarm message on video monitor screen	Description/action
ILL. SETUP!	INVALID SETTINGS SELECTED IN SETUP MENU. SET ITEMS IN THE SETUP MENU TO THE APPROPRIATE VALUES. CONTACT SERVICE IF THIS ALARM APPEARS AGAIN AFTER ABOVE PROCEDURE.	Reset the settings in the setup menu ( <i>see page 82</i> ). If the same message appears after you reset the settings, contact your Sony representative.
Exchg batt!	BATTERY NEEDS REPLACING. PLEASE CONTACT SERVICE.	The battery of the internal clock is low or dead. Contact your Sony service or sales representative.
Run Software Update Program.	RUN SOFTWARE UPDATE PROGRAM.	The software update is not properly performed. Update the software version again. If the same message appears after you update the software version, contact your Sony representative.

## When a disc is inserted

Alarm message in status display area	Alarm message on video monitor screen	Description/action
Unknown FS!	UNKNOWN FILE SYSTEM. PLEASE FORMAT DISC OR EJECT.	Format the disc ( <i>see page 62</i> ) or eject it ( <i>see page 43</i> ).
ILL. Index!	INDEX FILE ERROR. PLEASE FORMAT DISC OR EJECT.	
No FS!	NO FILE SYSTEM. PLEASE EJECT DISC.	Eject the disc.
ILL. Disc!	IRREGULAR DISC IS USED. PLEASE EJECT DISC.	Use another disc.



Alarm message in status display area	Alarm message on video monitor screen	Description/action
Over DUR!	EXCESSIVE DURATION IS IN DISC.	The total amount of recorded data exceeds the capacity of the disc.
No Support!	FORMAT NOT SUPPORTED. RECORDING AND PLAYBACK IS NOT POSSIBLE.	This appears when a disc recorded in an unsupported recording format has been inserted. Use a disc that is supported by this unit.
DISC frequency mismatch!	RECORDING AND PLAYBACK IS NOT POSSIBLE. SYSTEM SETTINGS DIFFERENT FROM DISC.	This appears when the system frequency setting of this unit and the system frequency of the inserted disc do not coincide. Replace the disc with one that is compatible with the system frequency setting of this unit, or change the system frequency setting of this unit.
1080/23.98P DISC	DISC CANNOT BE RECORDED. SYSTEM SETTINGS DIFFERENT FROM DISC.	This appears when the system frequency setting of this unit and the system frequency of the inserted disc do not coincide. Only pulldown playback is possible. Replace the disc with one that is compatible with the system frequency setting of this unit, or change the system frequency setting of this unit.
REC INHI.!	AUTO FORMATTING WAS NOT COMPLETED. THE DISC WRITE PROTECT TAB IS SET TO SAVE. PLEASE EJECT DISC.	Set the Write Inhibit tab on the disc so as to enable recording ( <i>see page 43</i> ).
FORMAT NG!	AUTO FORMATTING WAS NOT COMPLETED.	Eject the disc and then insert it again or insert another disc.
DI read err	CANNOT READ DISC INFORMATION. PLEASE EJECT DISC.	
DRV ADJ err	CANNOT PERFORM AUTO DRIVE ADJUSTMENT.	
Read err	CANNOT READ DISC DATA. PLEASE EJECT DISC.	
BCA Read Error!	CANNOT READ DISC BCA AREA. PLEASE EJECT DISC.	
DISC Error!	DISC CANNOT BE RESTORED. PLEASE RESTORE IT USING THE RECORDED EQUIPMENT.	
XDROOT needs Restoring.	DISC USERDATA XDROOT NEEDS TO BE RESTORED.	An abnormality has occurred with the UserData >XDROOT folder, and data restoration is needed. Restore the XDROOT folder.
BPAV Error!	USERDATA BPAV ERROR.	You cannot use clips in the UserData >BPAV folder.

## When a memory card is inserted

Alarm message in status display area	Alarm message on video monitor screen	Description/action
Unknown Media(A/B)	UNKNOWN MEDIA(A/B). PLEASE CHANGE.	The inserted memory card has been partitioned, or it contains more clips that the maximum that can be handled by this unit. Insert a memory card that has not been partitioned, or one that contains fewer than the maximum number of clips.
Memory (A/B) needs Restoring.	MEDIA ERROR. MEDIA(A/B) NEEDS TO BE RESTORED.	A memory card must be restored because an error has occurred in the card. Restore the card or format it.

Alarm message in status display area	Alarm message on video monitor screen	Description/action
Memory(A/B) Error!	MEDIA(A/B) CANNOT BE RESTORED. PLEASE RESTORE IT USING THE RECORDED EQUIPMENT.	An abnormality has occurred on the memory card, and data restoration is needed. Perform data restoration on the device that was used to record to the memory card.
Unknown FS!(A/B)	CANNOT USE MEDIA(A/B). UNSUPPORTED FILE SYSTEM.	The inserted memory card is formatted with an unsupported file system, or it is not formatted. Format the memory card, or exchange the memory card for one that is formatted with a file system supported by this unit.
R/W Limit(A/B)	MEDIA REACHED REWRITE LIMIT. CHANGE MEDIA(A/B).	The memory card has reached its lifetime rewriting limit. Copy clips on the memory card to other media as required, and then exchange the memory card. <b>Note</b> If you continue to use the memory card, normal recording and playback may not be possible.
Over DUR!(A/B)	EXCESSIVE DURATION IS IN MEDIA(A/B).	A clip with a duration that exceeds 24 hours is recorded on a memory card. This memory card cannot be used.
Under Repair of Media (A/B)	MEDIA (A/B) IS BEING REPAIRED.	Automatic repair of the management area of the memory card is in progress. Wait until the automatic repair is complete.
Repair Failed (A/B)	REPAIR FAILED.	The memory card may be damaged, and cannot be used. Replace the memory card.

## When a folder in external storage is being mounted

Alarm message in status display area	Alarm message on video monitor screen	Description/action
USB DRV Error!	USB DRIVE CANNOT BE RESTORED. PLEASE RESTORE IT USING THE RECORDED EQUIPMENT.	The operation target folder in external storage needs data restoration. Perform data restoration on the device that was used to record to external storage originally.
USB DRV needs Restoring.	MEDIA ERROR. USB DRIVE NEEDS TO BE RESTORED.	An abnormality has occurred with the operation target folder on external storage or the folder was edited by another device, and data restoration is needed. Perform data restoration on the external storage device or format it.
Over DUR!(USB DRV)	EXCESSIVE DURATION IS IN USB DRIVE.	The total length of the clips stored in the operation target folder in external storage exceeds 24 hours. This operation target folder cannot be used.
USB Drive not mounted due to limit of files or unsupported sector size.	—	The number of files exceeds 20,000 or external storage with an unsupported sector size is connected. Replace with other external storage.

## During front panel operations

Alarm message in status display area	Description/action
KEY INHI.!	This appears when the KEY INHI switch is “ON”. Set the KEY INHI switch to “OFF”.
Not Open Clip!	This appears when a clip operation is attempted with no clip selected. Select a clip on the clip list screen and try the operation again.
Clip Top!	During playback, this appears if you execute a reverse search when the unit is stopped at the first frame of a clip. To move to another clip, press the PREV, NEXT, SHIFT + PREV, or SHIFT + NEXT button, or perform a thumbnail search.

Alarm message in status display area	Description/action
Clip End!	During playback, this appears if you execute a forward search when the unit is stopped at the last frame of a clip. To move to another clip, press the PREV, NEXT, SHIFT + PREV, or SHIFT + NEXT button, or perform a thumbnail search.
EDL Top!	During EDL playback, this appears if you press the PREV button at the first frame of the first sub clip of an EDL.
EDL End!	During EDL playback, this appears if you press the NEXT button at the last frame of the last sub clip of an EDL.
MAX # Clips	No more clips can be recorded because the maximum number of recorded clips has been reached. Delete unneeded clips.
Media Full!	Recording or copying is not possible because the media is full. Delete unneeded clips.
TC EXT!	This appears when TCG on page P4 TC of the function menu is set to "EXT", and you try to preset timecode or user bits by setting PRST/RGN to "PRESET". Set TCG to "INT" (see page 41).
REGEN mode!	This appears when PRST/RGN on page P4 TC of the function menu is set to "TC" or "VITC", and you try to preset timecode or user bits. Set PRST/RGN to "PRESET" (see page 41).
REC mode!	Stop recording and try again.
EXIT THUMBNAIL mode!	This appears when an attempt is made to change media while the clip list screen is displayed. Switch to the basic operation screen or the video monitor screen and try the operation again.
REMOTE!	Press the REMOTE button, turning it off, to put this unit into local control mode.
No Disc!	Insert a Professional Disc and try the operation again.
Media Top!	An attempt has been made to execute a reverse search when the unit is stopped at the first frame of the first clip during playback of a disc.
Media End!	An attempt has been made to execute a forward search when the unit is stopped at the last frame of the last clip during playback of a disc.
REC INHI.!	Set the Write Inhibit tab on the disc so as to enable recording (see page 43).
No EM Space	This appears when any essence mark was not recorded because there is no space before and after the desired position. Delete unneeded shot marks 0 to 9 on the chapter thumbnail screen.
EM Full!	This appears when no more essence marks can be recorded. Delete unneeded shot marks 0 to 9 on the chapter thumbnail screen.
Illegal Operation!	This appears when an attempt is made to carry out an invalid operation.
Media is not Ready.	The media is in the course of being mounted or has not been loaded.

## During recording operations

Alarm message in status display area	Alarm message on video monitor screen	Description/action
Input Sig!	VIDEO INPUT SIGNAL DOES NOT MATCH SYSTEM SETUP.	This appears when the signal that does not correspond to the system frequency or the number of lines set in this unit is being input, or when HD-SDI is selected as a video input signal while set for SD signal recording. Input a signal that matches the system frequency, or change this unit's system frequency setting (see page 34).
ILL. REC!	ENCODING DOES NOT SYNCHRONIZE WITH REF VIDEO.	Check the signals being input to this unit.
MEM. Full!	MEMORY FULL !!	Recording on the disc is not possible because a buffer overflow has occurred in the recording buffer memory.

Alarm message in status display area	Alarm message on video monitor screen	Description/action
Verify ERR!	DISC ERROR DETECTED.	The Verify function detected an abnormality in signals recorded on the disc. Replace the disc.
Disc Damage	DISC CANNOT BE RECORDED TO. USE ANOTHER DISC FOR RECORDING.	Use another disc.
Index File!	UNSUPPORT INDEX FILE. DISC CANNOT BE RECORDED TO.	
Disc Busy!	–	A copy operation is being performed, so simultaneous recording is impossible at present.
REC STOP WITHIN 2MIN	RECORDING IS TERMINATED WITHIN 2 MINUTES AUTOMATICALLY. BECAUSE THE CLIP IS REACHED TO MAXIMUM DURATION.	The length of the clip has reached the maximum limit during recording. Recording will stop within the next two minutes.
	RECORDING IS TERMINATED WITHIN 2 MINUTES AUTOMATICALLY. BECAUSE OF INTERNAL LIMITATION.	The total recording time has reached the maximum limit during recording. Recording will stop within the next two minutes.
Cache Full!	CACHE FULL. DATA IS BEING OVERWRITTEN.	This appears when the memory becomes full while performing the disc exchange cache function. Change the disc immediately.

## During playback operations

Alarm message in status display area	Alarm message on video monitor screen	Description/action
ILL. PLAY!	ILLEGAL PLAYBACK.	Normal playback is not possible.
MEM. Empty!	MEMORY EMPTY !!	Playback is not possible because a buffer underflow has occurred in the playback buffer memory.
Media Data Error!	MEDIA DATA ERROR DETECTED.	A disc error has been detected. Replace the disc.
This Clip cannot be Played back.	–	This clip cannot be played back because its format is not supported by this unit. No clips in the UserData folder can be played back.
No MEDIA!	–	Insert a disc and try the operation again.
Operation is not Supported for EDL.	–	An EDL cannot be played back. Select a clip.
Disc Busy! NETWORK	–	The disc cannot be played as it is currently being used on the network.

## During operations on the clip list screen/thumbnaill search/EDL editing/copy

Alarm message on clip list screen	Description/action
Clip is Locked.	The clip is locked. This appears when an attempt is made to delete a clip, or set or clear a clip flag when the clip is locked.
Copy Running!	A copy operation is being performed, so another copy operation is not allowed.
Operation Failed!	The target operation failed because of generation of an internal error.
Not Supported Format.	The format is not supported by this unit, so copy operation is not possible.
Copy Aborted.	The copy operation was aborted.
Some Clip(s) are Locked.	Some of the selected clips are locked (protected).
Clip Error.	The clip is defective, so the copy operation failed.
The Disc Protect TAB is Set to Save.	You have attempted to format a disc whose Write Inhibit tab is set so as to disable recording. To execute formatting, set the Write Inhibit tab on the disc so as to enable recording.

<b>Alarm message on clip list screen</b>	<b>Description/action</b>
Irregular Disc is in Use. Use Professional Disc.	The inserted disc cannot be recorded/played back on this unit. Insert a disc that can be recorded/played back on this unit.
Set Appropriate IN/OUT Points.	The settings of IN and OUT points for partial copy operation are invalid. Check the IN and OUT point settings.
No Clip!	The clip selected for expansion or chapter display has been deleted. Alternatively, the disc has been ejected.
Cannot Expand Clip any Further.	The selected clip cannot be divided any further to display the expanded thumbnails. This alarm appears when the expanded thumbnails of a clip divided into the maximum number of blocks are displayed or when the EXPAND function button has been pressed with the expanded thumbnail screen displayed in which the duration of each block is one frame.
Delete is Prohibited. This Clip is in Use.	The target clip is being used, so it cannot be deleted.
Delete is Prohibited. Referring EDL is in Use.	The EDL which refers to the target clip is being used, so the clip cannot be deleted.
Delete is Prohibited.	Deletion of the target clip has failed.
Lock/Unlock is Prohibited. This Clip is in Use.	The target clip is being used, so it cannot be locked/unlocked.
Lock/Unlock is Prohibited.	Locking/unlocking of the target clip has failed.
Set Clip Flag was not Performed.	Set Clip Flag function has failed.
One Clip is being Recorded. Use Single Selection.	One of the selected clips was being recorded. To copy a clip which is being recorded, make a single selection of the clip.
Operation is not Supported for EDL.	You cannot select EDL to delete an essence mark or set a shot mark.
Operation is not Supported for this Folder.	You cannot delete or lock/unlock any clip in the UserData >BPAV folder.
Adding EM was not Performed.	Essence mark setting has failed.
Over DUR!	A clip with a duration that exceeds six hours cannot be copied.
Copy to /Clip is not Permitted. Change Dest to /UserData.	The selected clip cannot be copied to the Clip folder. Change the copy destination to the UserData folder.
Dest was Changed to /UserData. Copy to /Clip is not Permitted.	The selected clip was not permitted to be copied to the Clip folder, so it was copied to the UserData folder.
Cannot Display Chapter of this Clip.	Display of the selected clip on the chapter thumbnail screen has failed. Stop recording of a clip if any in progress.
Chapter was Changed. Display Again.	The chapter setting information has been updated. Try again the chapter thumbnail display.
Disc Busy!	The Professional Disc was being used, so copying was not possible.
Chapter does not Exist.	Chapter thumbnail screen cannot be displayed because no chapters are set on the clip.
Cannot Expand this Clip.	The clip cannot be expanded because it is being recorded.
Unable to Parse the EDL.	The EDL cannot be copied due to the existence of an inhibiting condition, such as a missing sub clip.
Writing this AV Format to DISC is not Permitted.	This clip cannot be copied to the currently loaded Professional Disc because of its format.
Out of Remain Space!	The remaining capacity of the copy destination media is not sufficient.

## Alarms relating to audio and video signals

Alarm message in status display area	Alarm message on video monitor screen	Description/action
No INPUT!	INPUT VIDEO IS NOT DETECTED. CHECK THE VIDEO INPUT MODE AND SUPPLY A VIDEO SIGNAL TO VIDEO INPUT.	<ul style="list-style-type: none"> <li>Check the setting of V INPUT on page P1 INPUT of the function menu (see page 40).</li> <li>Input an HDSDI signal.</li> </ul>
EMPHASIS!	INPUT AUDIO EMPHASIS IS NOT SUPPORTED. CHECK THE EMPHASIS OF THE AUDIO INPUT SIGNAL.	Check the emphasis of the audio input signal.
REF Not Exist	–	Input a reference signal.
REF NON-STD	A NON-STANDARD REF SIGNAL IS BEING USED FOR REF VIDEO. USE A STANDARD SIGNAL.	Input a standard reference signal.

## Alarms relating to sensors and drivers

Alarm message in status display area	Alarm message on video monitor screen	Description/action
MEM-138 Warning	IT IS NECESSARY TO REPLACE MEM-138. PLEASE CONTACT SERVICE.	Contact your Sony representative. <b>Note</b> The unit will not stop operating, but if you continue to use it in this state, it may fail, resulting in a total loss of the information.
FAN(1/2/3) Error	FAN1(1/2/3) ERROR.	Contact your Sony representative.
FAN1 Warning	FAN1 WARNING.	<b>Note</b> The unit will not stop operating, but if you continue to use it in this state, temperatures inside the unit will rise, possibly resulting in failure or fire.
DR-FAN Stop	DRIVE FAN MOTOR STOPPED.	
High TEMP!	HIGH TEMPERATURE IN DRIVE. HIGH TEMPERATURE.	
LASER 0 Lifetime	DISC DRIVE LASER 0 LIFETIME HAS ENDED. PLEASE CONTACT SERVICE.	The lifetime of the Professional Disc drive laser has come to an end. Contact your Sony service or sales representative.

## Other alarms

Alarm message in status display area	Alarm message on video monitor screen	Description/action
Turn off/on POWER!!	SYSTEM CONFIGURATION WAS CHANGED. PLEASE TURN OFF/ON POWER.	The system frequency was changed. Power off this unit and then power it on again.
Turn off/on POWER!!	MENU CONFIG WAS CHANGED. PLEASE TURN OFF/ON POWER.	Menu settings were changed. To apply menu settings, power this unit off and then power it on again.
Completed only XML file	–	Only the metadata file was updated, without updating the metadata in the MXF file.
Format Media is Prohibited. Confirm Mainte Menu : M395.	–	An attempt was made to execute Format Media while use of the Format Media command is prohibited by maintenance menu item M395. Check maintenance menu item M395.
Cannot finalize this Disc. It is available for QL-WO disc only.	–	An attempt has been made to finalize a disc that cannot be finalized. Only quad-layer discs can be finalized.

---

## Error messages

Error codes appear in the status display area when an error (usually a hardware problem) occurs. In addition, both error messages and error codes appear on the video monitor screen.

When an error message appears, follow the instructions in the error message to resolve the problem.

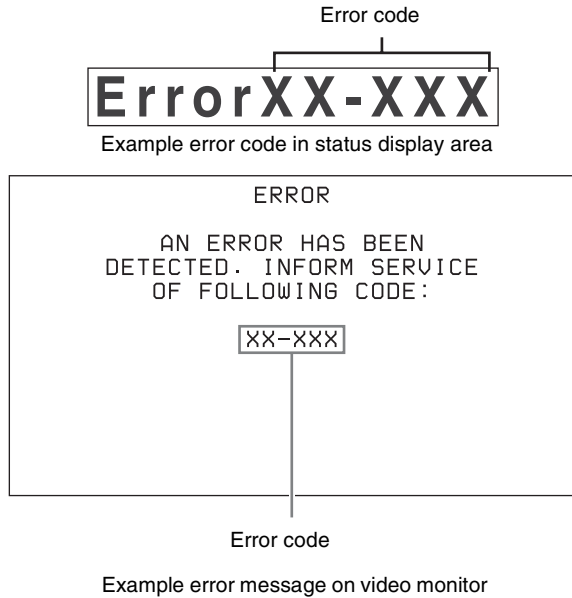

# Specifications

## General

External dimensions (w/h/d, excluding projections)

210 × 132 × 420 mm  
(8 3/8 × 5 1/4 × 16 5/8 inches)

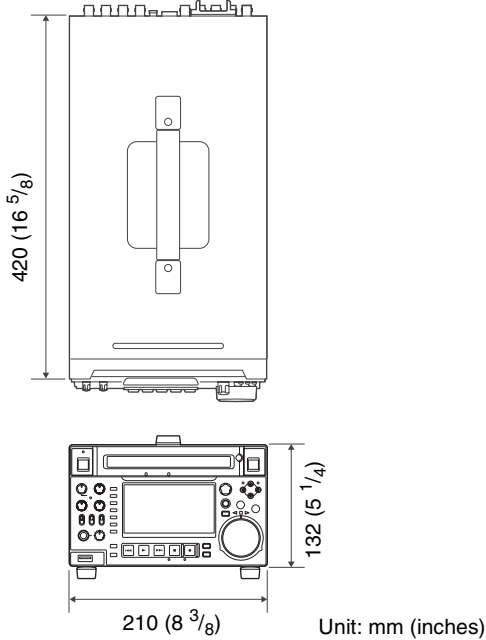

Mass 6.6 kg (14 lb 8.8 oz)

### Power requirements

100 V to 240 V AC, 50/60 Hz  
12 V DC

### Power consumption

AC operation: 100 W  
DC operation: 7.5 A

### Inrush current

- (1) Maximum possible inrush current at initial switch-on (Voltage changes caused by manual switching):  
47 A peak, 7.6 A r.m.s. (240 V AC)
- (2) Inrush current after a mains interruption of five seconds (Voltage changes caused at zero-crossing):  
12 A peak, 4 A r.m.s. (240 V AC)

### Operating temperature

5 °C to 40 °C (41 °F to 104 °F)

### Storage temperature

-20 °C to +60 °C (-4 °F to +140 °F)

### Operating relative humidity

20% to 90%

## System

### Recording/playback format

#### XAVC (option)

Video MPEG-4 AVC/H.264, Intra CLASS 100  
Audio 24-bit, 48 kHz, 8 channels

#### MPEG HD422

Video MPEG HD422: 50 Mbps  
Proxy video MPEG-4  
Audio 24-bit, 48 kHz, 8 channels  
Proxy audio A-law 8-bit, 8 kHz, 8 channels

#### MPEG HD

Video MPEG HD: HQ35/SP25/LP18 Mbps <sup>1)</sup>  
Proxy video MPEG-4  
Audio 16-bit, 48 kHz, 2/4 channels  
Proxy audio A-law 8-bit, 8 kHz, 2/4 channels

#### MPEG IMX

Video MPEG IMX: 50/40/30 Mbps <sup>2)</sup>  
Proxy video MPEG-4  
Audio 24/16-bit, 48 kHz, 4/8 channels  
Proxy audio A-law 8-bit, 8 kHz, 4/8 channels

#### DVCAM

Video DVCAM: 25 Mbps  
Proxy video MPEG-4  
Audio 16-bit, 48 kHz, 4 channels  
Proxy audio A-law 8-bit, 8 kHz, 4 channels

1) MPEG HD 18 Mbps can be used for playback only.

2) MPEG IMX 40 Mbps can be used for playback only.



## Recording/playback times

### Note

The actual recording and playback time may differ slightly from the values shown here, depending on usage conditions, etc.

Please take the following table on recording and playback time as a guide.

		Recording formats				
		XAVC AI422 <sup>a)</sup>	MPEG HD422	MPEG HD	MPEG IMX	DVCAM
Recording modes		CLASS 100	50 Mbps	HQ mode (35 Mbps/VBR)	50 Mbps	25 Mbps
Number of audio channels		8	8	2/4	4/8	4
Recording and playback time	PFD23A	Approx. 21 minutes	Approx. 43 minutes	Approx. 65 minutes	Approx. 45 minutes	Approx. 85 minutes
	PFD50DLA	Approx. 46 minutes	Approx. 95 minutes	Approx. 145 minutes	Approx. 100 minutes	Approx. 185 minutes
	PFD100TLA	Approx. 92 minutes	Approx. 190 minutes	Approx. 290 minutes	Approx. 200 minutes	Approx. 370 minutes
	PFD128QLW	Approx. 120 minutes	Approx. 240 minutes	Approx. 360 minutes	Approx. 240 minutes	Approx. 450 minutes

a) When the optional XDBK-106 is installed.

### Search speed

Jog mode	-1 to +1 times normal speed
	During remote control:
	-2 to +2 times normal speed (excluding XAVC)
	-1 to +2 times normal speed (XAVC)
Variable mode	-2 to +2 times normal speed (excluding XAVC)
	-1 to +2 times normal speed (XAVC)
Shuttle mode	-20 to +20 times normal speed
	During remote control: -50 to +50 times normal speed
F. FWD mode	+35 times normal speed
	During remote control: +50 times normal speed
F. REV mode	-35 times normal speed
	During remote control: -50 times normal speed

### Video performance

Sampling frequency	Y: 74.25 MHz, R-Y/B-Y: 37.125 MHz
Quantization	MPEG HD422/MPEG HD: 8 bits/sample XAVC: 10 bits/sample
Compression	HD422 MPEG-2 422P@HL HD: MPEG-2 MP@HL/H-14 XAVC: MPEG-4 AVC/H.264 Intra

### Composite output

Frequency response	0.5 to 5.75 MHz +0.5/-2.0 dB
--------------------	------------------------------

S/N (Y)	53 dB or more
Y/C delay	±20 ns or less
K-factor (K2T)	1.0% or less

### Processor adjustment range

Video level	-∞ to +3 dB
Chroma level	-∞ to +3 dB
Set up/black level	±30 IRE/±210 mV
Chroma phase	±30°
System phase	SYNC: ±15 μs SC: 0 to +400 ns

### Audio performance

Sampling frequency	48 kHz
Quantization	24 bits
Headroom	-20/-18/-16/-12/-9 (EBU level) (selectable)
Frequency response	20 Hz to 20 kHz +0.5/-1.0 dB (0 dB at 1 kHz)
Dynamic range	90 dB or more
Distortion	0.05% or less (at 1 kHz)

## Input connectors

### Digital video inputs

#### SD/HDSDI INPUT

BNC type, complying with SMPTE-259M (SD)/SMPTE-292M (HD)

### Analog video inputs

#### REF.VIDEO INPUT

BNC type (2) (loop-through), HD Tri-level sync (0.6 Vp-p, 75  $\Omega$ , sync positive/negative), SD black burst, or SD composite sync (0.286 Vp-p (NTSC), 0.3 Vp-p (PAL), 75  $\Omega$ , sync negative)

### Digital audio inputs

#### DIGITAL AUDIO (AES/EBU) IN 1/2, 3/4

BNC type (2), channels 1/2, 3/4, complying with AES-3id-1995

### Analog audio inputs

#### ANALOG AUDIO INPUT 1, 2

XLR 3-pin, female (2), +4 dBu, high impedance, balanced

#### ANALOG AUDIO INPUT 3, 4

XLR 3-pin, male (2), +4 dBu, high impedance, balanced

ANALOG AUDIO OUTPUT switching with maintenance menu item M374

ANALOG I/O

### Timecode input

#### TIME CODE IN

BNC type, SMPTE timecode, 0.5 to 18 Vp-p, 3.3 k $\Omega$ , unbalanced

## Output connectors

### Digital video outputs

#### HDSDI OUTPUT 1, 2 (SUPER)

BNC type (2), complying with SMPTE-292M

#### SDDSI OUTPUT 1, 2 (SUPER)

BNC type (2), complying with SMPTE-259M

#### HDMI OUT

Type A 19-pin  
Video: 1080i, 720P, 480i, 480P, 576i, 576P

Audio: Linear PCM, 48kHz/16-bit, 2 channels

### Analog video outputs

#### COMPOSITE OUTPUT 1, 2 (SUPER)

BNC type (2), 1.0 Vp-p, 75  $\Omega$ , sync negative, complying with SMPTE-170M

### Digital audio outputs

#### DIGITAL AUDIO (AES/EBU) OUT 1/2, 3/4

BNC type (2), channels 1/2, 3/4, complying with AES-3id-1995

### Analog audio outputs

#### ANALOG AUDIO OUTPUT 1, 2

XLR 3-pin, male (2), +4 dBu, 600  $\Omega$  load, low impedance, balanced

#### AUDIO MONITOR

XLR 3-pin, male (2), +4 dBu, 600  $\Omega$  load, low impedance, balanced

#### PHONES

Stereo phone jack,  $-\infty$  to  $-13$  dBu, 8  $\Omega$ , unbalanced

### Timecode output

#### TIME CODE OUT

BNC type, SMPTE timecode, 1.0 Vp-p, 75  $\Omega$ , unbalanced

### Remote control connectors

REMOTE (9P) D-sub 9-pin, female, complying with RS-422A

REMOTE 4-pin, female  
12 V DC, 7.5 W

 (Network) RJ-45 type  
1000BASE-T: complying with IEEE802.3ab

100BASE-TX: complying with IEEE802.3u

10BASE-T: complying with IEEE802.3

### USB connectors

 (front)

Super Speed USB (USB 3.0) Type-A

MAINTENANCE (rear)

High Speed USB (USB 2.0) Type-A (2)

### Accessories supplied

Operation Guide (1)

CD-ROM manual (1)

### Accessories not supplied

AC power cord

- For the customers in the U.S.A and Canada  
Part number 1-551-812-31 (125 V, 10 A, about 2.4 m)
- For the customers in the United Kingdom  
Part number 1-833-259-12 (250 V, 10 A, about 2.0 m)
- For the customers in European countries other than the United Kingdom  
Part number 1-551-631-16 (250 V, 10 A, about 2.0 m)

RCC-5G 9-pin Remote Control Cable

RM-280 Remote Edit Controller

BP-L80S Battery Pack

BKP-L551 Battery Adaptor  
PFD23A Professional Disc  
PFD50DLA Dual-Layer Professional Disc  
PFD100TLA Triple-Layer Professional Disc  
PFD128QLW Quad-Layer Write-Once Professional Disc  
XDBK-106 XAVC Codec Option  
SBAC-US20 SxS Memory Card USB Reader/Writer

Design and specifications are subject to change without notice.

SONY WILL NOT BE LIABLE FOR DAMAGES OF ANY KIND RESULTING FROM A FAILURE TO IMPLEMENT PROPER SECURITY MEASURES ON TRANSMISSION DEVICES, UNAVOIDABLE DATA LEAKS RESULTING FROM TRANSMISSION SPECIFICATIONS, OR SECURITY PROBLEMS OF ANY KIND.

#### Notes

- Always make a test recording, and verify that it was recorded successfully.  
SONY WILL NOT BE LIABLE FOR DAMAGES OF ANY KIND INCLUDING, BUT NOT LIMITED TO, COMPENSATION OR REIMBURSEMENT ON ACCOUNT OF FAILURE OF THIS UNIT OR ITS RECORDING MEDIA, EXTERNAL STORAGE SYSTEMS OR ANY OTHER MEDIA OR STORAGE SYSTEMS TO RECORD CONTENT OF ANY TYPE.
- Always verify that the unit is operating properly before use. SONY WILL NOT BE LIABLE FOR DAMAGES OF ANY KIND INCLUDING, BUT NOT LIMITED TO, COMPENSATION OR REIMBURSEMENT ON ACCOUNT OF THE LOSS OF PRESENT OR PROSPECTIVE PROFITS DUE TO FAILURE OF THIS UNIT, EITHER DURING THE WARRANTY PERIOD OR AFTER EXPIRATION OF THE WARRANTY, OR FOR ANY OTHER REASON WHATSOEVER.
- SONY WILL NOT BE LIABLE FOR CLAIMS OF ANY KIND MADE BY USERS OF THIS UNIT OR MADE BY THIRD PARTIES.
- SONY WILL NOT BE LIABLE FOR THE LOSS, REPAIR, OR REPRODUCTION OF ANY DATA RECORDED ON THE INTERNAL STORAGE SYSTEM, RECORDING MEDIA, EXTERNAL STORAGE SYSTEMS OR ANY OTHER MEDIA OR STORAGE SYSTEMS.
- SONY WILL NOT BE LIABLE FOR THE TERMINATION OR DISCONTINUATION OF ANY SERVICES RELATED TO THIS UNIT THAT MAY RESULT DUE TO CIRCUMSTANCES OF ANY KIND.

# Using UMID Data

Metadata is additional information recorded on discs along with audio-visual data. It is used to bring greater efficiency to the flow of operations from material acquisition through editing, and to make it easier to find and reuse material. UMID has been internationally standardized as a specific application using metadata.

## What is a UMID?

A UMID (Unique Material Identifier) is a unique identifier for audio-visual material defined by the SMPTE-330M-2004 standard.

A UMID may be either a 32-byte Basic UMID or an Extended UMID, which includes an additional 32 bytes of Source Pack data to make a total 64 bytes.

*For details, refer to SMPTE-330M.*

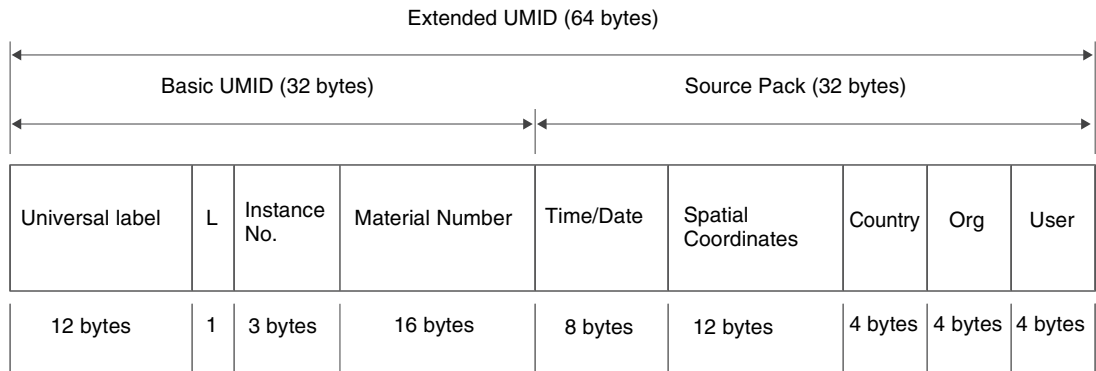

A globally unique ID is automatically recorded for every clip.

The Extended UMID is metadata that provides additional information such as location, time/date, company ID and so on.

The UMID is applied as follows.

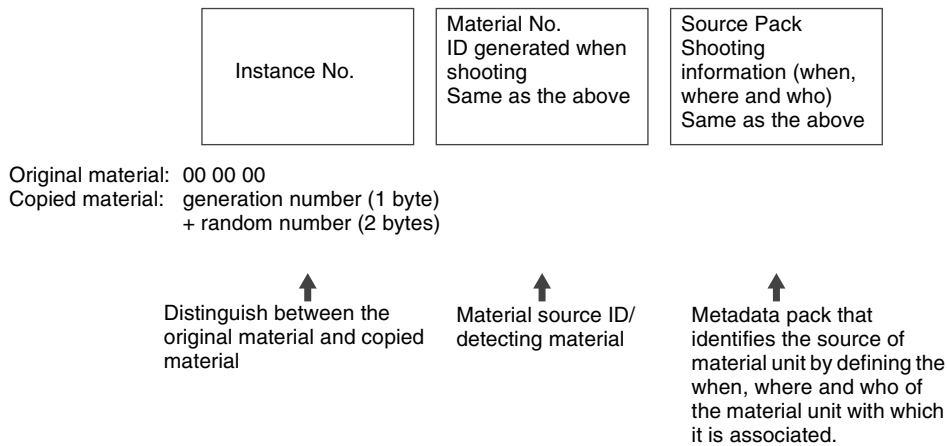

## Using the Extended UMID

You have to enter a country code, organization code and user code. Set the country code referring to the table in ISO 3166, and set the organization code and user code according to the guidelines of your organization.

*For details, see “Setting UMID ownership information” (page 117).*

## Functions of UMID data

UMID data enables the following:

- Addition of a globally unique ID to every clip of audio-visual material. The unique ID is used to detect the material source and to link it with the original source material.
- Distinguishing between original material and copied material. 00 is added to the Instance Number for original material.

- Recording with UTC time. UTC (coordinated universal time) is used when recording the UMID. Use of a universal time system enables uniform management of source material recorded all over the world.
- Calculation of date differences. Source material is recorded using modified Julian dates (MJD), which enables easy calculation of date differences between different source material items.

## Setting UMID ownership information

Proceed as follows.

- 1 Set setup menu item 029 STORED OWNERSHIP to “on” (see page 85).

See page 86 for more information about setup menu operations.

The STORED OWNERSHIP (UMID ownership information setting) screen appears.

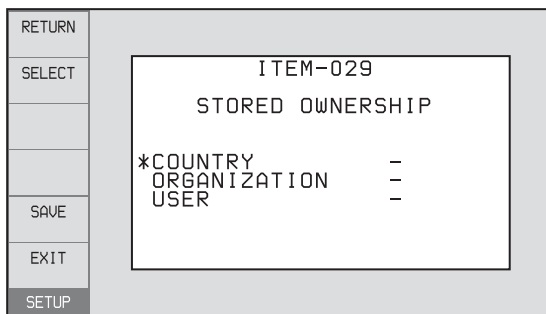

**COUNTRY:** Sets the country code.

**ORGANIZATION:** Sets the organization code.

**USER:** Sets the user code

See “About UMID ownership information” (page 117) for more information about these codes.

- 2 Use the PUSH SET knob to select the item to set and the character input location, then press the knob.
- 3 Use the PUSH SET knob, – or + function button (F3 or F4) to select characters to input at the selected location.

### To delete all input data

Press the RESET/RETURN button.

- 4 Press SAVE function button (F5).

The message “NOW SAVING...” appears, and the ownership information is saved.

## About UMID ownership information

### COUNTRY (country code)

Set the country code by entering an abbreviated alphanumeric string (4-byte alphanumeric string) according to the values defined in ISO 3166-1.

There are about 240 country codes.

Find your own country code on the following web page.

Refer to ISO 3166-1:

[http://www.iso.org/iso/country-codes/iso\\_3166\\_code\\_lists.htm](http://www.iso.org/iso/country-codes/iso_3166_code_lists.htm)

When the country code is less than 4 bytes, the active part of the code occupies the first part of the 4 bytes and the remainder must be filled with the space character (20h).

### Example: Japan

For Japan, the country code is JP, which is 2 bytes, or JPN, which is 3 bytes.

Thus, enter the following:

JP \_ \_  
or  
JPN \_  
where \_ represents a space.

### ORGANIZATION (organization code)

Enter a 4-byte alphanumeric string for the organization code.

### Notes

- There are no problems in recording or playing back audio-video signals, even if the ORGANIZATION is not set.
- Organization codes must be acquired by applying to the SMPTE registration office. When no organization code has been acquired, it is forbidden to enter an arbitrary string. As a rule, the code “00” must be entered. Freelance operators who do not belong to an organization should enter “~”.

### USER (user code)

Enter a 4-byte alphanumeric string to identify the user. The user code is registered with each organization locally. It is usually not registered centrally.

When the user code is less than 4 bytes, enter the user code at the beginning of the 4 bytes and fill the remainder of the string with the space characters (20h).

This user code is determined by the organization. The methods used depend on the organization.

### Note

A user code cannot be entered when no organization code has been entered.

---

# Ancillary Data

This unit can play and record ancillary data superimposed on the HDSDI signals. It can also input and output ancillary data in MXF files when transferring files via FTP/CIFS connections. Transferable auxiliary data includes text data (captions and metadata) and control signals.

---

## Ancillary data in HDSDI/SDSDI signals

This unit can record and play back closed captions conforming to the EIA-708-B <sup>1)</sup> standard and EIA-608-B <sup>1)</sup> standard, and text data conforming to the ARIB TR B-23 <sup>2)</sup> standard which comprise the VANC (Vertical ancillary data) packets.

1) EIA: Electronic Industries Alliance

2) ARIB: Association of Radio Industries and Businesses

### To record ancillary data

Set the lines where ancillary data is inserted, the DID (Data Identifier word), and the SDID (Secondary Data Identifier word) with maintenance menu item M3B VANC RX PARAMETER.

*For details, refer to the Service Manual.*

### To record and playback EIA-708-B standard closed caption data in HDSDI signals

Set the corresponding maintenance menu item.

*For details, refer to the Service Manual.*

### To record EIA-608-B standard closed caption data in HDSDI signals

Set the corresponding maintenance menu item.

*For details, refer to the Service Manual.*

## VANC packets

- The Japanese ARIB TR-B23 standard limits the number of packets that can be superimposed on the HDSDI signal to 4 packets per line.
- The number of VANC packets that can be recorded, depending on the relevant maintenance menu settings, is limited to 9 packets per frame for 50P or 59.94P mode and 18 packets per frame for other modes.
- When VANC packets are not continuous from word 0 and there is unused area on the line, then information

about the packet position is not recorded. Packets are output flush left.

- During input, if a parity error is detected in a VANC packet, the packet is discarded and recorded flush left.

---

## Ancillary data in MXF files

VANC ancillary data recorded from an HDSDI signal is inserted to an MXF file as an ANC Frame Element (conforming to the SMPTE436M-2006). This data can also be recorded on the disc from an MXF file that has been input via CIFS/FTP.

### To insert ancillary data into MXF files for output

In setup menu item 666 METADATA ITEM OUT, select “on”.

## HANC/VANC packets

### Detection of HANC/VANC packets

When an MXF file has been input, HANC/VANC packets are recorded on the disc if the DATA ITEM of the head frame is identified as ANC Frame Elements conforming to the SMPTE436M-2006.

## Closed caption data

This section explains the closed caption data that can be recorded, played back, and output during EE output.

### Normal EIA-708/608 recording and playback

Closed caption input data that complies with the EIA-708/608 standards can be recorded, played back, and output with no changes.

However, settings are required for recording of closed caption data in HDSDI signals.

*For details, see “To record and playback EIA-708-B standard closed caption data in HDSDI signals” (page 118) or “To record EIA-608-B standard closed caption data in HDSDI signals” (page 118).*

EIA-708/608 standard closed caption data recorded in HD video is output as HDSDI signals, regardless of menu settings.

EIA-608 standard closed caption data in SDDSII line 21 signals are recorded and played back (output as SDDSII or composite signals), regardless of menu settings.

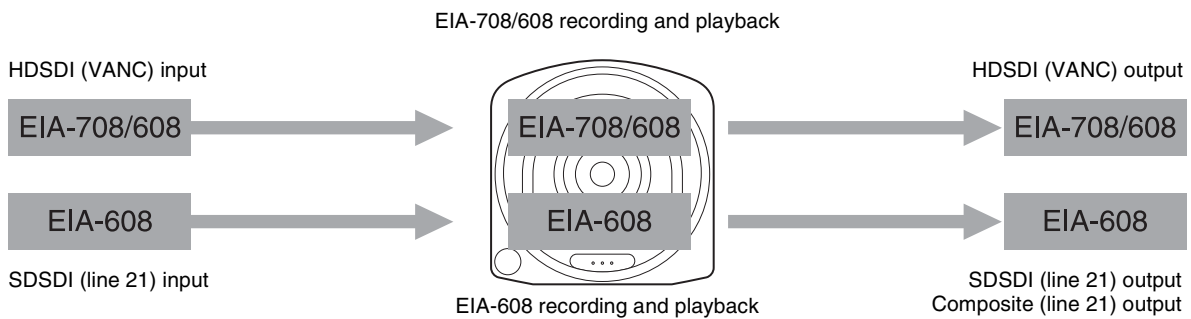

### EIA-708/608 EE output

Closed caption input data that complies with the EIA-708/608 standard can be output in EE mode.

However, settings are required for EE output of closed caption data in HDSDI signals.

*For details, see “To record and playback EIA-708-B standard closed caption data in HDSDI signals” (page 118) or “To record EIA-608-B standard closed caption data in HDSDI signals” (page 118).*

Closed caption data in SDDSII line 21 signals are output in EE mode (output as SDDSII or composite signals), regardless of menu settings.

#### Note

EE output of closed caption data in HDSDI signals is delayed by 1 frame with respect to EE output of the video signals.

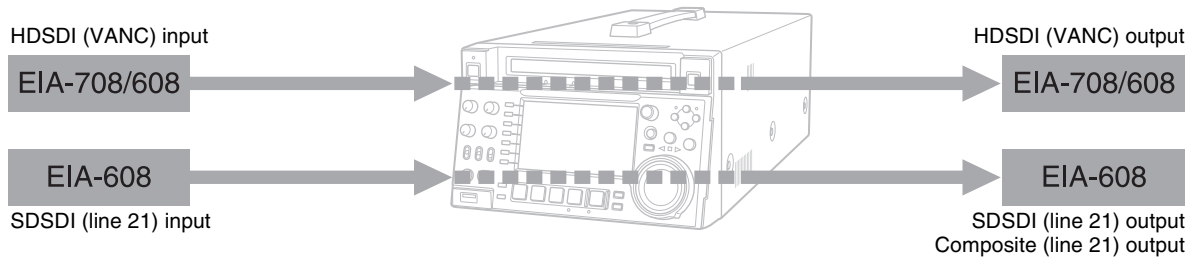

---

# Trademarks and Licenses

---

## Trademarks

- XAVC™, XAVC logo, MPEG HD422, and DVCAM are trademarks of Sony Corporation.
- Professional Disc is a trademark of Sony Corporation.
- MPEG HD and HDCAM are registered trademarks of Sony Corporation.
- The terms HDMI and HDMI High-Definition Multimedia Interface, and the HDMI Logo are trademarks or registered trademarks of HDMI Licensing LLC in the United States and other countries.
- Adobe, Acrobat, and Adobe Reader are trademarks of Adobe Systems Incorporated in the United States and/or other countries.

---

## MPEG-4 visual patent portfolio license

THIS PRODUCT IS LICENSED UNDER THE MPEG-4 VISUAL PATENT PORTFOLIO LICENSE FOR THE PERSONAL AND NON-COMMERCIAL USE OF A CONSUMER FOR

- (i) ENCODING VIDEO IN COMPLIANCE WITH THE MPEG-4 VISUAL STANDARD (“MPEG-4 VIDEO”) AND/OR
- (ii) DECODING MPEG-4 VIDEO THAT WAS ENCODED BY A CONSUMER ENGAGED IN A PERSONAL AND NON-COMMERCIAL ACTIVITY AND/OR WAS OBTAINED FROM A VIDEO PROVIDER LICENSED BY MPEG LA TO PROVIDE MPEG-4 VIDEO.

NO LICENSE IS GRANTED OR SHALL BE IMPLIED FOR ANY OTHER USE. ADDITIONAL INFORMATION INCLUDING THAT RELATING TO PROMOTIONAL, INTERNAL AND COMMERCIAL USES AND LICENSING MAY BE OBTAINED FROM MPEG LA, LLC. SEE [HTTP://WWW.MPEGLA.COM](http://www.mpegla.com)

MPEG LA is offering licenses for (i) manufacturing/sales of any storage media storing MPEG-4 Visual video information (ii) distribution/broadcasting of MPEG-4 Visual video information in any manner (such as online video distribution service, internet broadcasting, TV broadcasting). Other usage of this product may be required to obtain license from MPEG LA. Please contact MPEG LA for any further information. MPEG LA, L.L.C., 250 STEELE STREET, SUITE 300, DENVER, COLORADO 80206, <http://www.mpegla.com>

---

## MPEG-2 video patent portfolio license

ANY USE OF THIS PRODUCT OTHER THAN CONSUMER PERSONAL USE IN ANY MANNER THAT COMPLIES WITH THE MPEG-2 STANDARD FOR ENCODING VIDEO INFORMATION FOR PACKAGED MEDIA IS EXPRESSLY PROHIBITED WITHOUT A LICENSE UNDER APPLICABLE PATENTS IN THE MPEG-2 PATENT PORTFOLIO, WHICH LICENSE IS AVAILABLE FROM MPEG LA, L.L.C., 250 STEELE STREET, SUITE 300, DENVER, COLORADO 80206.

“PACKAGED MEDIA” means any storage media storing MPEG-2 video information such as DVD movie which are sold/distributed to general consumers. PACKAGED MEDIA replicators or sellers of the PACKAGED MEDIA need to obtain licenses for their own business from MPEG LA. Please contact MPEG LA for any further information. MPEG LA, L.L.C., 250 STEELE STREET, SUITE 300, DENVER, COLORADO 80206 <http://www.mpegla.com>

---

## About IJG (Independent JPEG Group)

This software is based in part on the work of the Independent JPEG Group.

---

## Character display software “iType”

This product includes technology from Monotype Imaging Inc., including iType® and certain fonts.

---

## Open software licenses

On the basis of license contracts between Sony and the software copyright holders, this product uses open software.

To meet the requirements of the software copyright holders, Sony is obligated to inform you of the content of these licenses.

For the content of these licenses, see “License1.pdf” in the “License” folder of the supplied CD-ROM.

Adobe Reader must be installed on your computer to view PDF files.

If Adobe Reader is not installed on your computer, you can download it by accessing the following URL. <http://get.adobe.com/reader>



---

## Obtaining GPL/LGPL/GPL V3 licensed software

This product uses software licensed under GPL version 2 / LGPL version 2.1 / GPL version 3. You have the right to obtain, change, and distribute the source code of this software.

You can download the source code of this software from Sony Internet servers. Access the following URL, and refer to “XDCAM HD422 Memory Deck Series”.  
<http://www.sony.net/Products/Linux/common/search.html>

We cannot respond to inquiries regarding the content of the source code.

# Index

## A

- AC IN connector 21
- ACCESS indicator 11
- Accessories
  - not supplied 114
  - supplied 114
- Alarms 104
- ANALOG AUDIO
  - INPUT 1, 2 connectors 21
  - OUTPUT 1, 2 connectors 22
- Analog audio signal input/output section 21
- Ancillary data 118
- Appendix 101
- Arrow buttons 12
- Audio
  - input display 15
- Audio level
  - adjustment section 11
  - meters 15
- AUDIO MONITOR R, L connectors 22

## B

- Basic menu 82
  - changing settings 86
  - items 83
  - operations 86
  - returning to factory default settings 87
- Battery
  - attaching a battery pack 23
  - checking the remaining power 24
  - removing 24

## C

- CH-1/ALL CH, CH-2 to CH-4
  - adjustment knobs 12
- Chapter thumbnail screen 61
- CIFS file operations 81
- Clip 68
  - continuous playback mode 51
  - copying 55
  - deleting 66
  - information 17
  - locking (write-protecting) 66
  - properties 60
  - searching with thumbnails 64
  - selecting 64
  - setting clip flags 66
  - setting the index picture frame 67

- single clip playback mode 51
- Clip F Menu 63
- Clip list screens 58
  - chapter thumbnail screen 61
  - details view 59
  - expanded thumbnail screen 61
  - thumbnails view 59
- Clip Menu 62
- Clip Properties screen 60
- Closed caption data 119
- Command list 78
- COMPOSITE OUTPUT 1, 2 (SUPER)
  - connectors 21
- Connections 27
  - cut editing system 28
  - editing control unit settings 29
  - for pool coverage 32
  - FTP connection 27
  - using the editing function of recorder 31
- Copying 55
- Current EDL 68

## D

- DC IN 12V connector 21
- DIGITAL AUDIO (AES/EBU)
  - IN 1/2, 3/4 connectors 22
  - OUT 1/2, 3/4 connectors 22
- Digital audio signal input/output section 22
- Digital hours meter 102
  - display modes 102
  - displaying 103
  - exiting 103
- Disc control section 11
- Disc exchange cache
  - function 49
- DISC IN indicator 11
- Disc slot 11
- Disc status indicator 16
- Discs
  - finalizing 72
  - formatting 43
  - handling 43
  - information 71
  - loading/unloading 43
  - reconstructing 50
  - usable discs 42
  - write-protecting 43
- Display 13, 15
  - basic operation screen 15
  - clip list screens 58
  - switching 58
  - video monitor screen 18
- DISPLAY button 13
- Display/menu control section 13

## E

- Editing
  - control unit 28
  - controller 30
  - EDL 68
- EDL 68
  - creating and editing 68
  - previewing 68
- EJECT button 11
- Error messages 111
- Essence mark
  - setting 48, 52
- Expand
  - function 7
- Expanded thumbnail screen 61
- Extended menu 82
  - items 89
- External storage 44
- External synchronization 33

## F

- Features 6
- File operations 73
  - Clip directory 74
  - directory structure 73
  - Edit directory 75
  - General directory 75
  - root directory 74
  - Sub directory 75
  - UserData directory 76
- FOLDER SEL button 12
- Front panel 10, 26
  - changing the angle 26
  - pulling out 26
  - returning to original position 26
- FTP file operations 77
  - command list 78
  - logging in 77
  - logging out 78
  - making connections 77
  - preparations 77
- Function buttons (F1 to F6) 13
- Function menu 15, 39
  - HOME page 39
  - P1 INPUT page 40
  - P2 INPUT page 40
  - P3 AUDIO page 41
  - P4 TC page 41

## G

- Gigabit Ethernet 7

## H

- Handle 10
- HDMI OUT connector 20

HDSDI  
 remote control function 48  
 HDSDI OUTPUT 1, 2 (SUPER)  
 connectors 20  
 HOME button 14

**I**

IN  
 button 12  
 indicator 12  
 Initial Setup 25

**J**

Jog  
 mode 52  
 Jog dial 13  
 Jog/shuttle transport indicators 13

**K**

KEY INHI switch 11

**L**

LEVEL adjustment knob 11  
 Loading/unloading disc 43

**M**

Maintenance  
 periodic 102  
 MAINTENANCE connector 21  
 MARK1/MARK2 buttons 12  
 MEDIA SEL button 12  
 Menu  
 bank setting 85  
 changing settings 86  
 Clip F Menu 63  
 Clip Menu 62  
 configuration 82  
 function menu 39  
 returning to default settings 87  
 setup menu 82  
 MENU button 13  
 Metadata 116  
 Microphone settings 22

**N**

Names and functions of parts 10  
 Network connector 21  
 NEXT button 14  
 Normal speed playback 52

**O**

On/standby button and indicator 10

OUT  
 button 12  
 indicator 12

**P**

PAGE button 14  
 PHONES jack 11  
 PLAY button 14  
 Playback 51  
 EDL 68  
 jog mode 52  
 normal speed 52  
 settings 51  
 shot mark settings 52  
 shuttle mode 53  
 start position 51  
 variable mode 53  
 Playback condition  
 display 38  
 mark 37  
 Power supply section 21  
 POWER switch 21  
 Preparation  
 Initial Setup 25  
 PREV button 14  
 Professional Discs 42  
 Proxy AV data 7  
 PUSH SET knob 13

**R**

Rear Panel 20  
 REC button 14  
 REC INHI indicator 14  
 Recording 47  
 HDSDI remote control function  
 48  
 level adjustment 48  
 salvage 49  
 settings 47  
 shot mark settings 48  
 Recording and playback control  
 section 14  
 Recording/playback format 17  
 REF.VIDEO INPUT connectors 21  
 Reference signal 16  
 REMOTE (9P) connector 20  
 REMOTE connector 21  
 Remote control switch 11  
 RESET/RETURN button 13  
 Returning to factory default settings  
 87

**S**

Salvage  
 function 49  
 SD/HDSDI INPUT connector 20

SDSDI OUTPUT 1, 2 (SUPER)  
 connectors 20  
 Setup menu  
 basic menu 83  
 extended menu 89  
 SHIFT button 13  
 SHTL/JOG button 12  
 Shuttle  
 mode 53  
 Shuttle dial 13  
 Shuttle/jog/variable control section 12  
 Specifications 112  
 STANDBY indicator 14  
 Status display area 18  
 Status indicator 17  
 STOP button 14  
 Sub clip 68  
 Superimposed text information 36  
 Supplying power 23  
 AC power supply 23  
 Battery power supply 23  
 DC power supply 23  
 Synchronization reference signals 33  
 System frequency setting 34  
 System information 16

**T**

Text information 36  
 THUMBNAIL button 13  
 Thumbnail search 64  
 chapter thumbnail screen 65  
 expanded thumbnail screen 64  
 Tilt mechanism 26  
 TIME CODE  
 IN connector 22  
 OUT connector 22  
 Time data display area 17  
 Timecode 34  
 after setting initial value 34  
 recording external timecode  
 directly 36  
 recording sequentially upon the  
 last recorded timecode  
 35  
 recording with the internal  
 timecode generator  
 synchronized 35  
 setting to current time 35  
 Timecode input/output section 22  
 Troubleshooting 104

**U**

UMID Data 116  
 USB connector 11, 21  
 USB DRV OFF button 11

Index

User bits  
  setting 35

## **V**

VAR/JOG button 12  
Variable  
  mode 53  
VARIABLE switch 12  
Video input indicator 16

## **W**

Write-protecting discs 43



The material contained in this manual consists of information that is the property of Sony Corporation and is intended solely for use by the purchasers of the equipment described in this manual.

Sony Corporation expressly prohibits the duplication of any portion of this manual or the use thereof for any purpose other than the operation or maintenance of the equipment described in this manual without the express written permission of Sony Corporation.

