

Panasonic®

Owner's Manual for advanced features

Digital Camera

DMC-ZS100

Model No. DMC-ZS60



DMC-ZS100



DMC-ZS60

LUMIX

Please read these instructions carefully before using this product,
and save this manual for future use.

Message Display

→375

Q&A Troubleshooting

→383

Finding the information you need

→2

Contents

→5

Contents by Function

→13

Menu list

→379

Register online at
<http://shop.panasonic.com/support>
(U.S. customers only)

SQW0547
M0116KZ0

Finding the information you need

In this "Owner's Manual for advanced features", you can find the information you need from the following pages.

By clicking a page number, you can jump to the linked page and quickly find the information.



DMC-ZS100



DMC-ZS60

Search from "Contents" → [5 -](#)

Search from the list of function names → [13 -](#)
"Contents by Function"

Search from "Names and Functions of Main Parts" → [19 -](#)

Search from "List of monitor/viewfinder displays" → [363 -](#)

Search from the list of on-screen messages → [375 -](#)
"Message displays"

Search from the menu list → [379 -](#)
"Menu list"

[Rec]	379	[Setup]	382
[Motion Picture].....	380	[Playback].....	382
[Custom].....	381		

Search from "Q&A Troubleshooting" → [383 -](#)

For details on how to use this manual, see the next page.

Wi-Fi[®] function → [301](#)



Recording mode icons

Recording mode: 

In Recording modes that show icons in black, you can select and execute indicated menus and functions.

- Click a cross reference in the text to jump to the corresponding page.

About the models

- This manual provides instructions for DMC-ZS100 and DMC-ZS60.
- Screens shown in this manual are from the DMC-ZS100 unless otherwise indicated.
- Functions vary by model. When reviewing the manual, be aware that model numbers corresponding to each function will appear as below.

Model number	DMC-ZS100	DMC-ZS60
How it appears in the manual		



Click this icon to jump to "Finding the information you need".



Click this icon to jump to "Contents".





Click this icon to jump to "Menu list".



Click this icon to return to the previously displayed page.







■ About the symbols in the text

- MENU** Indicates that the menu can be set by pressing [MENU/SET] button.
- Wi-Fi** Indicates that the Wi-Fi setting can be made by pressing [Wi-Fi] button.
-  Configurations that can be performed in the [Custom] menu.
-  Tips for skillful use and points for recording.
- (→00) Indicates the reference page. Click to go to the corresponding page.
-  Click to view the description on the next page.

In this Owner's Manual, steps for setting a menu item are described as follows:

MENU →  **[Rec]** → **[Quality]** → **[.±]**

- In this manual, ring, dial and lever operations are illustrated as below.

Turn the control ring	
ZS100 Rotate the rear dial	
ZS60 Rotate the control dial	
Rotate the zoom lever	



■ Finding the information you need 2	■ Contents by Function 13
■ How to use this manual 3	

Before Use

■ Before use 16	■ ZS100 Names and Functions of Main Parts 19
■ Standard Accessories 18	■ ZS60 Names and Functions of Main Parts 21

Preparations

■ Attaching the Hand Strap 23	■ About the Card 37
■ ZS100 Attaching the Shoulder Strap adaptor 23	Formatting the card (initialization) 38
■ Charging battery 25	Estimated recording capacity (number of pictures/recording time) 39
■ ZS100 Inserting the battery 26	■ Setting the clock 42
■ ZS60 Inserting the battery 27	Changing time settings 43
■ ZS100 Charging the battery 28	
■ ZS60 Charging the battery 29	
■ ZS100 Inserting and removing the card (optional) 35	
■ ZS60 Inserting and removing the card (optional) 36	



Basics

■ Holding the camera	44
■ Buttons/Dials/Levers	
Used for Recording	45
Zoom Lever (Use Zoom).....	45
Shutter button (Taking pictures).....	46
Motion picture button (Recording motion pictures).....	48
Mode dial (Select the recording mode).....	49
ZS100 Control ring / Rear dial	50
ZS60 Control ring / Control dial	51
Cursor button / [MENU/SET] button (Selecting/setting items)	52
[DISP.] button (Switching the display information).....	53
[LVF] button (Recording pictures using the viewfinder).....	58
■ Touch screen (Touch operations)....	61
Touching the screen and recording (Touch Shutter function).....	63
Easily Optimizing the Brightness for a Specified Area ([Touch AE]).....	64
■ Setting the menu	65
How to set the menu	65
■ Calling frequently-used menus instantly (Quick Menu)	68
ZS100 Change the Quick Menu to your preferred item	69
■ Assigning frequently used functions to the buttons	
(Function buttons)	70
Using the function buttons during recording.....	71
Using the function buttons during playback.....	73
■ ZS100 Changing the settings assigned to the control ring/ rear dial	74
■ ZS60 Changing the settings assigned to the control ring/ control dial.....	75
■ Using the [Setup] menu	76
[Online Manual].....	76
[Clock Set]	76
[World Time].....	76
[Travel Date]	77
[Wi-Fi]	77
[Beep]	78
[Live View Mode]	78
[Monitor Display] / [Viewfinder]	79
[Monitor Luminance]	80
[Economy].....	81
[USB Mode]	82
[TV Connection].....	82
[m/ft].....	84
[Menu Resume]	84
[Menu Background].....	84
[Menu Information].....	84
[Language].....	84
[Version Disp.].....	85
[Exposure Comp. Reset].....	85
[Self Timer Auto Off].....	85
[No.Reset].....	85
[Reset]	86
[Reset Wi-Fi Settings].....	86
[Demo Mode].....	86
[Format]	86
■ Entering Text	87



Recording mode

- **Taking pictures with automatic settings (Intelligent Auto Mode) 88**
 - Taking pictures using a handheld camera ([iHandheld Night Shot]) 91
 - Combining pictures into a single still picture with rich gradation ([iHDR]) 92
 - Defocusing the background (Defocus control function) 93
 - Recording images by changing the brightness (exposure) or color tone 94
 - About Intelligent Auto Plus Mode and Intelligent Auto Mode 95
- **Taking pictures after automatically setting the aperture value and shutter speed (Program AE Mode) 97**
- **Taking pictures by setting the aperture value and shutter speed... 100**
 - Taking pictures by setting the aperture value (Aperture-Priority AE Mode) 101
 - Taking pictures by setting the shutter speed (Shutter-Priority AE Mode) 102
 - Taking pictures by setting the aperture value and shutter speed (Manual Exposure Mode) 103
 - Checking the effects of the aperture value and shutter speed (Preview Mode) 106
 - Easily set aperture / shutter speed for suitable exposure (One Push AE) 108
- **Recording panorama pictures (Panorama Shot Mode) 109**
- **Taking pictures according to the scene (Scene Guide Mode) 112**
- **Taking Pictures with different picture effects (Creative Control Mode) 117**
- **Recording motion pictures by setting the aperture value/shutter speed (Creative Video Mode) 124**
 - Recording Slow Motion Pictures ([High Speed Video]) 125
 - Minimizing operational sounds during motion picture recording 126
- **Registering your own settings and recording (Custom Mode) 127**
 - Registering your own settings ([Cust.Set Mem.]) 127
 - Recording using registered custom set ... 128



Picture Quality and coloring Settings

- **Adjusting the picture quality with effects [Photo Style]** 129
- **Taking pictures using picture effects [Filter Settings]**..... 131
- **ZS100 Adjusting highlights and shadows [Highlight Shadow]** 133
- **Adjusting the White Balance** 134
- **Setting the picture quality and size**..... 139
 - Changing the aspect ratio of the still pictures 139
 - Setting the picture size 139
 - Setting the compression rate of pictures ([Quality]) 140
- **Using the picture correction functions effectively** 142
 - Correcting contrast and exposure ([i.Dynamic])..... 142
 - Enhancing the impression of high-resolution ([i.Resolution]) 142
 - Combining still pictures with different exposures ([HDR]) 143
 - ZS100** Suppressing the noise of a long exposure ([Long Shtr NR]) 144
 - Raising the resolution when the aperture is closed ([Diffraction Compensation]) 144
 - ZS100** Setting the color space 145

Adjusting the focus and brightness (exposure)

- **Taking pictures with Auto Focus...** 146
 - Set the focusing operation to be performed when the shutter button is pressed halfway (AFS, AFF, AFC) 148
 - Switching [AF Mode]..... 149
 - Changing the position and size of the AF area 156
 - Setting the AF area position with the touch pad 161
 - Optimizing the focus and brightness for a touched position 162
 - Setting your preferred focusing method 163
- **Taking close-up pictures (Macro recording)** 165
- **Taking pictures with Manual Focus**..... 167
 - Quickly adjusting the focus using Auto Focus..... 170
- **ZS100 Taking pictures by locking the focus and/or exposure (AF/AE Lock)** 173
- **ZS60 Taking pictures by locking the focus and/or exposure (AF/AE Lock)** 175
- **Taking pictures with Exposure Compensation** 177
- **Setting the ISO Sensitivity** 179
 - Setting the upper limit of ISO Sensitivity... 181
 - Setting the incremental value of ISO Sensitivity 181
 - Extending the ISO Sensitivity setting..... 182
- **Setting the metering mode**..... 183



Recording 4K Photos

■ Recording 4K Photos	184	Selecting pictures from 4K burst file and saving	190
Recording with [4K Burst]	187	Notes on the 4K Photo function.....	196
Recording with [4K Burst(S/S)].....	188		
Recording with [4K Pre-Burst]	189		

Shutter and Drive Settings

■ Setting the Shutter Type	199	■ Recording while exposure is changed automatically	
■ Selecting a Drive Mode	201	[Auto Bracket]	206
■ Burst function	202	■ Taking pictures with self-timer	208

Functions for specific subjects and purposes

■ Saving a picture by selecting a focus point after recording		■ Disabling the beeps and flash at the same time	
[Post Focus]	210	[Silent Mode]	225
Recording using [Post Focus].....	210	■ Recording with the Face Recognition function	
Select the focus point and save the picture	214	[Face Recog.]	226
■ Taking pictures automatically at set intervals		■ Setting the profile for a baby or pet to record in a picture	229
[Time Lapse Shot].....	216	■ Displaying the appropriate screen for specific recording conditions	230
■ Creating stop motion animation		■ ZS100 Recording while monitoring camera images	232
[Stop Motion Animation]	219		
■ ZS100 Performing multiple exposures for a single picture			
[Multi Exp.].....	223		

Stabilizer, Zoom and Flash

■ Correcting jitter	234	■ Setting the Flash Functions	243
■ Using Zoom	236	Changing Flash Mode.....	243
Zoom types and use	236	ZS100 Setting the 2nd curtain sync	249
Using the zoom by performing touch operations (Touch zoom).....	240	Adjusting the flash output	250
■ Taking pictures with flash	241		



Recording motion pictures

■ Recording motion pictures	251	■ Using the [Motion Picture] menu...	265
Recording 4K motion pictures.....	254	[4K Live Cropping]	265
Setting the format, picture size and		[Snap Movie].....	265
recording frame rate	255	[Rec Format].....	265
Adjusting the focus while recording		[Rec Quality]	265
motion pictures ([Continuous AF])	257	[Exposure Mode].....	265
■ Recording pans with little		[High Speed Video].....	265
vibration or recording motion		[Continuous AF]	266
pictures with zoom		[Level Shot].....	266
[4K Live Cropping].....	258	[Fldr Decrease]	266
■ Taking still pictures while a motion		[Silent Operation].....	266
picture is being recorded	261	[Wind Noise Canceller]	267
■ Recording Snap Movies	262	[Zoom Mic].....	267
Setting up [Pull Focus].....	264		

Playing Back and Editing Pictures

■ Viewing your pictures	268	■ Using the [Playback] menu	279
■ Viewing motion pictures	270	[Slide Show].....	280
Capturing still pictures from motion		[Playback Mode]	281
pictures	271	[Location Logging]	283
■ Switching the Playback Method	272	ZS100 [RAW Processing]	284
Zooming in and viewing		[Light Composition]	287
"Playback Zoom"	272	[Clear Retouch].....	289
Viewing a list of pictures		[Title Edit].....	290
"Multi Playback"	273	[Text Stamp].....	291
Viewing pictures by their recording date		[Video Divide].....	292
"Calendar Playback"	274	[Time Lapse Video]	293
Viewing group pictures	275	[Stop Motion Video]	293
■ Deleting pictures	277	[Resize].....	294
		[Cropping]	295
		[Rotate] / [Rotate Disp.]	296
		[Favorite].....	297
		[Print Set].....	298
		[Protect]	299
		[Face Rec Edit]	299
		[Picture Sort].....	300

Wi-Fi

- **What you can do with the Wi-Fi® function** 301
- **Wi-Fi Function** 302
- **Operating the camera by connecting it to a smartphone**..... 305
 - Installing the smartphone/tablet app "Panasonic Image App"305
 - Connecting to a smartphone.....306
 - Taking pictures via a smartphone (remote recording)312
 - Playing back pictures in the camera on a smartphone.....313
 - Saving pictures in the camera to a smartphone.....313
 - Sending pictures in the camera to social networking services314
 - Adding location information to pictures in the camera from a smartphone.....314
 - Combining motion pictures recorded with Snap Movie according to your preference on a smartphone.....316
- **Displaying still pictures on a TV**.... 318
- **Sending pictures**..... 319
- **Sending pictures to a smartphone** 322
- **Wireless printing**..... 323
- **Sending pictures to AV device**..... 324
- **Sending pictures to a PC** 325
- **Using WEB services** 327
 - When sending images to WEB service....327
 - When sending images to [Cloud Sync. Service]331
- **Using "LUMIX CLUB"** 332
 - About the [LUMIX CLUB].....332
- **About connections** 337
 - Connecting via a wireless access point ([Via Network])338
 - Connecting directly ([Direct])341
 - Connecting quickly with the same settings as used previously ([Select a destination from History] / [Select a destination from Favorite])342
- **[Wi-Fi Setup]**..... 344

Connecting with other devices

- **Enjoying 4K motion pictures** 346
 - Viewing 4K motion pictures346
 - Storing 4K motion pictures.....347
- **Viewing on TV screen**..... 348
 - VIERA Link (HDMI) (HDAVI Control™)....350
- **Storing recorded still pictures and motion pictures on your PC** ... 352
 - Downloading software353
 - Copying still pictures and motion pictures355
- **Storing recorded still pictures and motion pictures in the recorder**..... 357
 - Copying by inserting the card into the recorder357
- **Printing** 358
 - Printing multiple pictures.....359
 - Printing with date and text360
 - Making print settings on the camera.....361



Others

- **Optional accessories** 362
 - Using the AC adaptor (optional) and DC coupler (optional) instead of the battery 362
- **ZS100 List of monitor/viewfinder displays** 363
- **ZS60 List of monitor/viewfinder displays** 369
- **Message displays** 375
- **Menu list** 379
- **Q&A Troubleshooting** 383
- **Usage cautions and notes** 398



Recording

Recording

Recording mode	49
[Preview]	106
Panorama Shot Mode	109
Macro recording	165
[4K PHOTO]	184
[Post Focus]	210
[Time Lapse Shot]	216
[Stop Motion Animation]	219
ZS100	
[Multi Exp.]	223
[Silent Mode]	225

Focus (AF/MF)

Focus Mode	146
AF Mode	149
Adjusting the AF area position	156
Manual Focus	167
AF/AE Lock	173, 175

Drive

Drive Mode	201
[Self Timer]	208

Exposure

[Touch AE]	64
[One Push AE]	108
AF/AE Lock	173, 175
Exposure Compensation	177
ISO sensitivity	179
[Metering Mode]	183
[Auto Bracket]	206

Picture Quality and Color Tone

[Photo Style]	129
[Filter Settings]	131
ZS100	
[Highlight Shadow]	133
White Balance	134
[Picture Size]	139
[Quality]	140
[i.Dynamic]	142
[i.Resolution]	142
[HDR]	143
ZS100	
[Long Shtr NR]	144
[Diffraction Compensation]	144
ZS100	
[Color Space]	145

Flash

[Flash Mode]	243
ZS100	
2nd curtain synchro	249
[Flash Adjust.]	250

Monitoring

ZS100	
Recording while monitoring camera images	232



Motion Picture

Motion Picture

Creative Video Mode	124
[High Speed Video]	125
[Silent Operation]	126
Motion pictures in 4K	254
[Rec Format]	255
[Rec Quality]	255
[4K Live Cropping]	258
Taking still pictures while a motion picture is being recorded	261
[Snap Movie]	262

Audio

[Wind Noise Canceller]	267
------------------------------	-----

Screen settings

[Zebra Pattern]	230
[Monochrome Live View]	231





Setup/Custom

Basic settings

[Format]	38
[Clock Set]	42
Display switching	53, 57
Diopter adjustment	60
How to set menu items	65
[Q.MENU]	68
[Beep]	78
[Economy]	81
[Reset] (initialization)	86

Customization

ZS100	
[CUSTOM] in the Quick Menu	69
Function buttons	70
Custom Mode	127
[Custom] menu	381



Playback

Playback

[Auto Review]	47
Picture playback	268
Motion picture playback	270
Playback Zoom	272
Multi Playback	273
Delete	277

Display/playback settings

[Slide Show]	280
[Rotate]/[Rotate Disp.]	296

Edit

ZS100	
[RAW Processing]	284
[Light Composition]	287
[Clear Retouch]	289
[Resize]	294
[Cropping]	295

Adding information

[Location Logging]	283
[Title Edit]	290
[Text Stamp]	291

Image settings

[Favorite]	297
[Print Set]	298
[Protect]	299



**Wi-Fi****Connect**

"Image App"	305
[WPS (Push-Button)]	338, 341
Direct connection	341

Image App

Remote recording	312
Saving images	313
Sending images	314, 322
Sending and adding location information ...	314
Combining motion pictures recorded with [Snap Movie]	316

In combination with other devices

Playing back pictures on a TV	318
Printing images	323
Sending images to an AV device	324
Sending images to a PC	325
Sending images to a WEB service	327
Using [Cloud Sync. Service]	331

**Connecting with other devices****PC**

Transferring images to a PC	352
"PHOTOfunSTUDIO"	353
SILKYPIX	354

TV

Playing Back Pictures on a TV Screen	348
[VIERA Link]	350

Recorder

Dubbing	357
---------------	-----

Printer

PictBridge	358
------------------	-----



Before use

■ Camera handling

Keep the camera away from excessive vibration, force, or pressure.

- Avoid using the camera under the following conditions, which may damage the lens, monitor, viewfinder, or camera body. This may also cause the camera to malfunction or prevent recording.
 - Dropping or hitting the camera against a hard surface
 - Sitting down with the camera in your pants pocket or forcing it into a full bag
 - Adding accessories to the camera strap
 - Pushing with excessive force on the lens or monitor

The camera is not dust resistant, splash resistant, or waterproof.

Avoid using the camera in places with excessive dust or sand, or where water can come into contact with the camera.

- Avoid using the camera under the following conditions, which present a risk that sand, water, or foreign material may enter the camera through the lens or openings around buttons. Be especially careful because these conditions may damage the camera, and such damage may not be repairable.
 - In extremely dusty or sandy places
 - In the rain or by the shore, where the camera may be exposed to water



■ Condensation (When the lens, the monitor, or viewfinder, is fogged up)

- Condensation may occur when the camera is exposed to sudden changes of temperature or humidity. Avoid these conditions, which may make the lens, monitor, or viewfinder, dirty, cause mold, or damage the camera.
- If condensation does occur, turn off the camera and wait about two hours before using it. Once the camera adjusts to the surrounding temperature, the fogging will clear naturally.

Always take a test shot first

Before important events when you will use the camera (at weddings, for example), always take a test shot to make sure that pictures and sound record correctly.

No compensation for missed shots

We cannot compensate for missed shots if technical problems with the camera or card prevent recording.

Carefully observe copyright laws

Unauthorized use of recordings that contain works with copyright for purposes other than personal use is prohibited under copyright law. Recording of certain material may be restricted even for the purpose of personal use.

Also refer to “Usage cautions and notes” (→398)**Before using the camera, make sure all accessories specified in the attached “Basic Owner’s Manual” are supplied.**

For details on optional accessories (→362)

Standard Accessories

Check that all the accessories are supplied before using the camera.

- The accessories and their shape will differ depending on the country or area where the camera was purchased.

For details on the accessories, refer to “Basic Owner’s Manual”.

- Battery Pack is indicated as battery pack or battery in the text.
- SD Memory Card, SDHC Memory Card and SDXC Memory Card are indicated as card in the text.
- Please dispose of all packaging appropriately.
- Keep small parts in a safe place out of the reach of children.

■ Optional accessories

- Cards are optional.



ZS100 Names and Functions of Main Parts

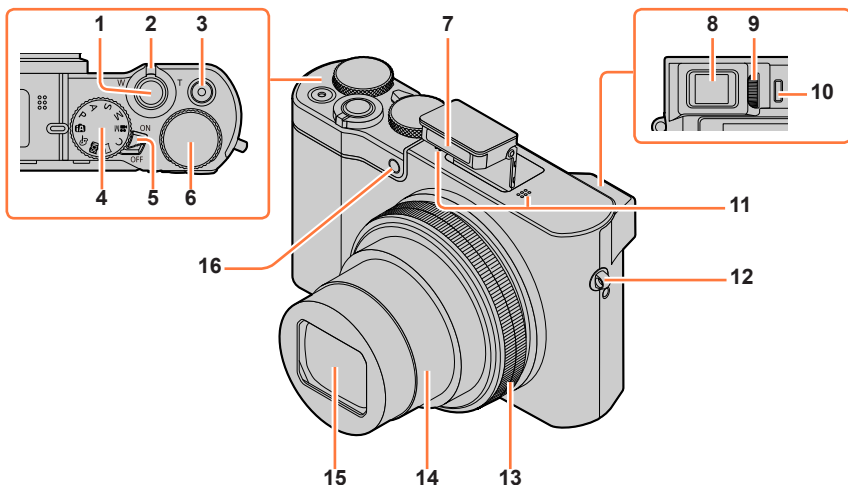

- | | | | |
|-----------|---|-----------|---|
| 1 | Shutter button (→46) | 12 | Strap eyelet (→23) |
| 2 | Zoom lever (→45) | 13 | Control ring (→50)
Allows you to zoom and adjust settings when recording. |
| 3 | Motion picture button (→48) | 14 | Lens barrel |
| 4 | Mode dial (→49)
Use this to select the recording mode. | 15 | Lens |
| 5 | Camera [ON/OFF] switch (→42) | 16 | Self-timer indicator (→208) /
AF Assist Lamp (→164) |
| 6 | Rear dial (→50) | | |
| 7 | Flash (→241) | | |
| 8 | Viewfinder (→58) | | |
| 9 | Diopter adjustment dial (→60) | | |
| 10 | Eye sensor (→58, 60) | | |
| 11 | Stereo microphone (→44)
Be careful not to cover the microphone with your finger. Doing so may make sound difficult to record. | | |

Names and Functions of Main Parts

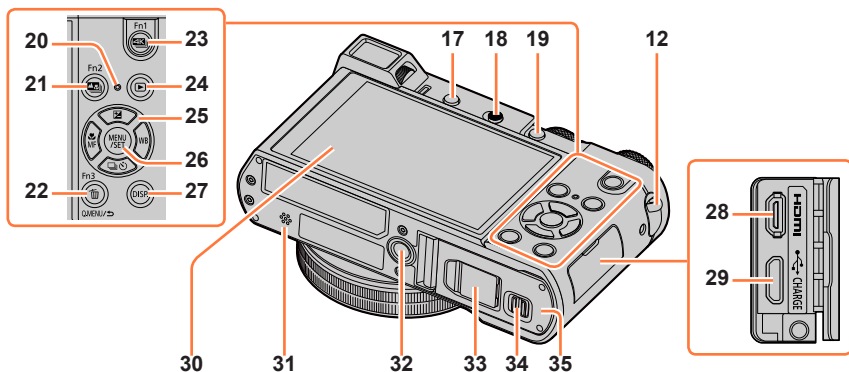

- | | | | |
|----|--|----|---|
| 12 | Strap eyelet (→23) | 30 | Touch screen (→61) / monitor (→363) |
| 17 | [L/VF] button (→58) /
[Fn4] button (→70) | 31 | Speaker (→44)
Be careful not to cover the speaker with your finger. Doing so may make sound difficult to hear. |
| 18 | Flash open lever (→241)
The flash opens, and recording with the flash becomes possible. | 32 | Tripod mount (→401)
Do not attach this unit to tripods that have screws with a length of 5.5 mm (0.22 inch) or more. Doing so may damage this unit or the unit may not be secured properly on the tripod. |
| 19 | [AF/AE LOCK] button (→173) | 33 | DC coupler cover (→362)
When using an AC adaptor, ensure that the Panasonic DC coupler (optional) and AC adaptor (optional) are used. |
| 20 | Charging lamp (→30) /
Wi-Fi® connection lamp (→302) | 34 | Release lever (→26) |
| 21 | [AF] ([Post Focus]) button (→210) /
[Fn2] button (→70) | 35 | Card/Battery door (→26) |
| 22 | [Q.MENU/⌫] (Cancel) button (→68) /
[⌫] (Delete) button (→277) /
[Fn3] button (→70) | | |
| 23 | [4K] (4K photo mode) button (→184) /
[Fn1] button (→70) | | |
| 24 | [▶] (Playback) button (→268) | | |
| 25 | Cursor button (→52)
[⬆] (Exposure compensation) (▲) (→177)
[WB] (White Balance) (▶) (→134)
[⏻] (Drive Mode) (▼) (→201)
[MF] (Focus Mode) (◀) (→146, 165, 167) | | |
| 26 | [MENU/SET] button (→52) | | |
| 27 | [DISP.] button (→53)
Use this to change display. | | |
| 28 | [HDMI] socket (→348) | | |
| 29 | [CHARGE] socket (→28) | | |
- **Function buttons [Fn5] to [Fn9]**
- Buttons [Fn5] to [Fn9] (→70) are touch icons. They can be displayed by touching the [F] tab on the recording screen.

ZS60 Names and Functions of Main Parts

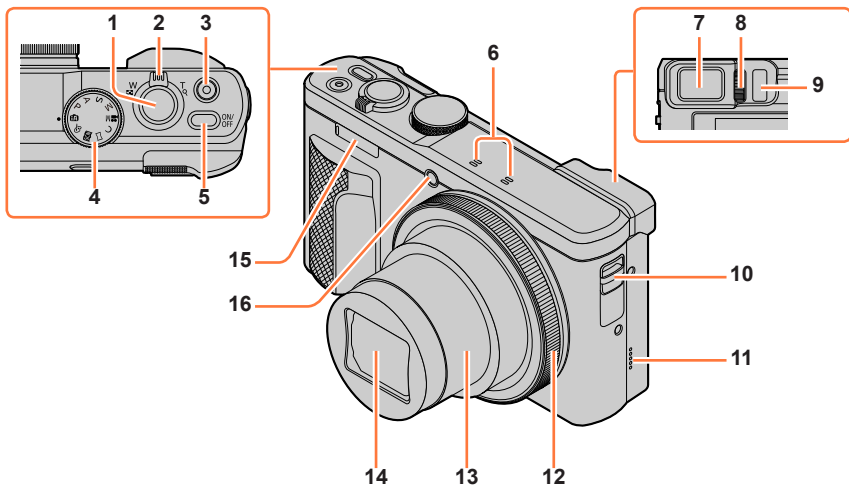

- | | | | |
|---|---|----|--|
| 1 | Shutter button (→46) | 10 | Strap eyelet (→23) |
| 2 | Zoom lever (→45) | 11 | Speaker (→44)
Be careful not to cover the speaker with your finger. Doing so may make sound difficult to hear. |
| 3 | Motion picture button (→48) | 12 | Control ring (→51)
Allows you to zoom and adjust settings when recording. |
| 4 | Mode dial (→49)
Use this to select the recording mode. | 13 | Lens barrel |
| 5 | Camera [ON/OFF] button (→42) | 14 | Lens |
| 6 | Stereo microphone (→44)
Be careful not to cover the microphone with your finger. Doing so may make sound difficult to record. | 15 | Flash (→241) |
| 7 | Viewfinder (→58) | 16 | Self-timer indicator (→208) /
AF Assist Lamp (→164) |
| 8 | Diopter adjustment dial (→60) | | |
| 9 | Eye sensor (→58, 60) | | |

Names and Functions of Main Parts

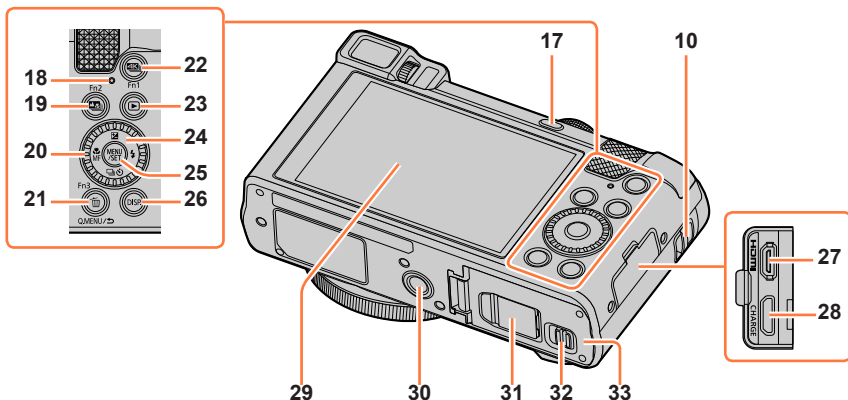

- | | |
|---|--|
| <p>10 Strap eyelet (→23)</p> <p>17 [LVF] button (→58) / [Fn4] button (→70)</p> <p>18 Charging lamp (→30) / Wi-Fi® connection lamp (→302)</p> <p>19 [AF] ([Post Focus]) button (→210) / [Fn2] button (→70)</p> <p>20 Control dial (→51)</p> <p>21 [Q.MENU/△] (Cancel) button (→68) / [] (Delete) button (→277) / [Fn3] button (→70)</p> <p>22 [4K] (4K photo mode) button (→184) / [Fn1] button (→70)</p> <p>23 [▶] (Playback) button (→268)</p> <p>24 Cursor button (→52)
[] (Exposure compensation) (▲) (→177)
[] (Flash) (▶) (→244)
[] (Drive Mode) (▼) (→201)
[] (Focus Mode) (◀) (→146, 165, 167)</p> <p>25 [MENU/SET] button (→52)</p> <p>26 [DISP.] button (→53)
Use this to change display.</p> <p>27 [HDMI] socket (→348)</p> <p>28 [CHARGE] socket (→29)</p> | <p>29 Touch screen (→61) / monitor (→369)</p> <p>30 Tripod mount (→401)
Do not attach this unit to tripods that have screws with a length of 5.5 mm (0.22 inch) or more. Doing so may damage this unit or the unit may not be secured properly on the tripod.</p> <p>31 DC coupler cover (→362)
When using an AC adaptor, ensure that the Panasonic DC coupler (optional) and AC adaptor (optional) are used.</p> <p>32 Release lever (→27)</p> <p>33 Card/Battery door (→27)</p> |
|---|--|

■ Function buttons [Fn5] to [Fn9]

- Buttons [Fn5] to [Fn9] (→70) are touch icons. They can be displayed by touching the [] tab on the recording screen.

Attaching the Hand Strap

We recommend attaching the hand strap when using the camera to prevent it from dropping.

ZS100

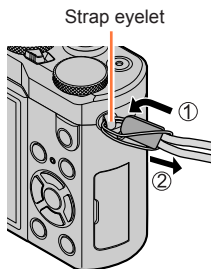

ZS60

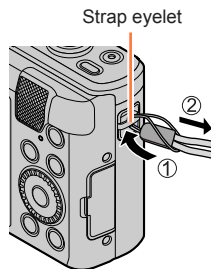

ZS100 Attaching the Shoulder Strap adaptor

You can use a shoulder strap (commercially available) by attaching a shoulder strap adaptor (supplied) to the camera.

1 Attach a shoulder strap adaptor to the strap eyelet on the camera

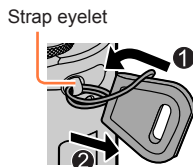

2 Pass your shoulder strap through the shoulder strap opening of the strap adaptor

- Check the operating instructions that came with the shoulder strap.

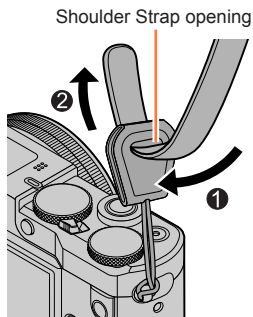

Attaching the Hand Strap

3 Pull the shoulder strap and then check that it will not come out

- Also attach the other side of the shoulder strap so it is not twisted.

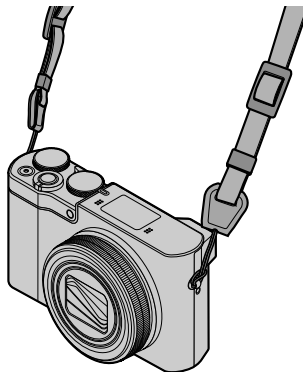
**■ An alternative way to attach the shoulder strap**

You can make the shoulder strap adaptor a little shorter.

- ① Pass the shoulder strap adaptor through the strap eyelet
- ② Pass your shoulder strap through both the shoulder strap adaptor string and shoulder strap opening
 - Check the operating instructions that came with the shoulder strap.
- ③ Pull the shoulder strap and then check that it will not come out
 - Also attach the other side of the shoulder strap so it is not twisted.

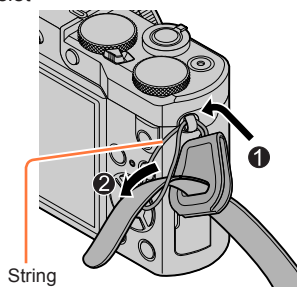

- Keep the shoulder strap adaptors out of reach of children to prevent swallowing.



Charging battery

Always use the dedicated AC adaptor (supplied), USB connection cable (supplied), and battery for this camera.

- **Always charge before first use! (battery shipped uncharged)**
- **Charge the battery while it is in the camera.**

Camera status	Charge
Turn off	Yes
Turn on	No

About batteries that you can use with this unit

It has been found that counterfeit battery packs which look very similar to the genuine products are made available to purchase in some markets. Some of these battery packs are not adequately protected with internal protection to meet the requirements of appropriate safety standards. There is a possibility that these battery packs may lead to fire or explosion. Please be advised that we are not liable for any accident or failure occurring as a result of use of a counterfeit battery pack. To ensure that safe products are used we recommend that a genuine Panasonic battery pack is used.

ZS100 Inserting the battery

To charge the battery, insert it into the camera.

- 1 Slide the release lever to the [OPEN] position and open the card/battery door**

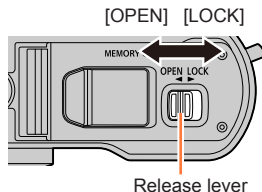

- 2 Insert the battery all the way**
 - Insert the battery all the way firmly and check that it is locked by lever.

- 3 Close the card/battery door and then slide the release lever to the [LOCK] position**

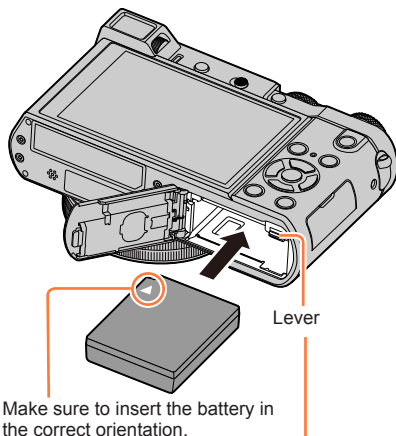
**To remove battery**

Move the lever in the card/battery compartment in the direction of the arrow.

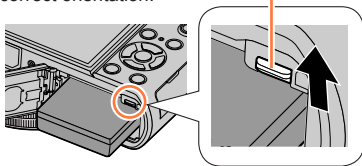

- Always use genuine Panasonic batteries.
- If you use other batteries, we cannot guarantee the quality of this product.
- To remove the battery, turn the camera off and wait until the LUMIX indicator on the screen goes off. (Failure to wait may cause the camera to malfunction and may damage the card or recorded data.)
- **Remove battery from camera after use.**
 - Keep the battery in a plastic bag, making sure that it is kept away from metallic objects (such as clips) when carrying or storing it.
- The unusable battery should be discarded in accordance with battery recycling laws. Call the RBRC hotline at 1-800-822-8837 for information.



ZS60 Inserting the battery

To charge the battery, insert it into the camera.

- 1 Slide the release lever to the [OPEN] position and open the card/battery door

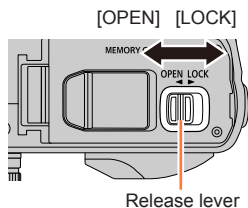

- 2 Insert the battery all the way
 - Insert the battery all the way firmly and check that it is locked by lever.
- 3 Close the card/battery door and then slide the release lever to the [LOCK] position

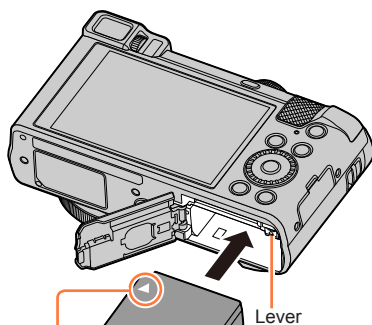

Make sure to insert the battery in the correct orientation.

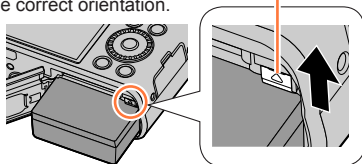

To remove battery

Move the lever in the card/battery compartment in the direction of the arrow.

- Always use genuine Panasonic batteries.
- If you use other batteries, we cannot guarantee the quality of this product.
- To remove the battery, turn the camera off and wait until the LUMIX indicator on the screen goes off. (Failure to wait may cause the camera to malfunction and may damage the card or recorded data.)
- **Remove battery from camera after use.**
 - Keep the battery in a plastic bag, making sure that it is kept away from metallic objects (such as clips) when carrying or storing it.
- The unusable battery should be discarded in accordance with battery recycling laws. Call the RBRC hotline at 1-800-822-8837 for information.

ZS100 Charging the battery

We recommend charging in a location where the ambient temperature is between 10 °C and 30 °C (50 °F to 86 °F) (same for the battery temperature).

Make sure that the camera is turned off.

The battery can be charged from an outlet or through a PC.

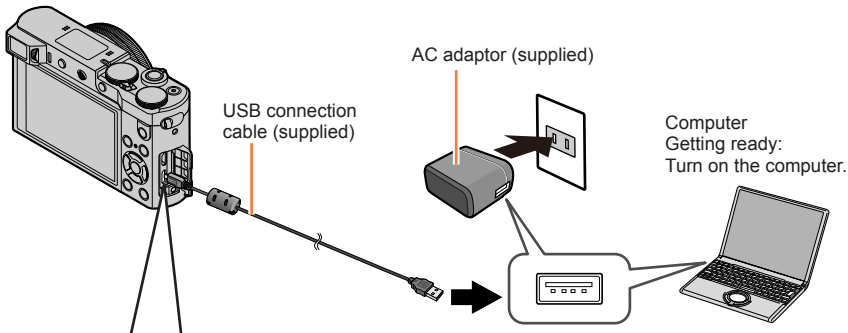

When charging the camera, connect the USB connection cable (supplied) to the [CHARGE] socket.

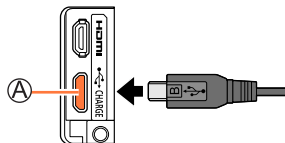

- Ⓐ: [CHARGE] socket
- This terminal is located at the bottom when the camera is in an upright position.
 - Always check the direction of the pins and hold the plug straight to insert or remove it. (If the cable is inserted in the wrong direction, the pins could become deformed and cause faulty operation.)
 - Also, do not insert into the wrong socket. Doing so may cause damage to this unit.

ZS60 Charging the battery

We recommend charging in a location where the ambient temperature is between 10 °C and 30 °C (50 °F to 86 °F) (same for the battery temperature).

Make sure that the camera is turned off.

The battery can be charged from an outlet or through a PC.

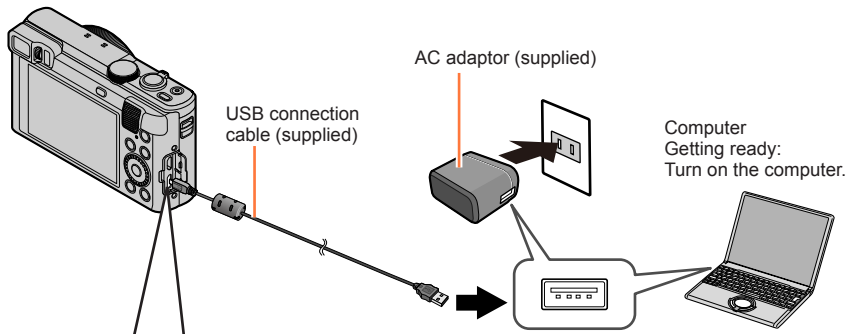

When charging the camera, connect the USB connection cable (supplied) to the [CHARGE] socket.

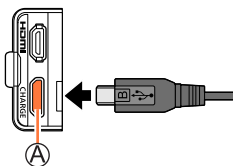

- Ⓐ: [CHARGE] socket
- This terminal is located at the bottom when the camera is in an upright position.
 - Always check the direction of the pins and hold the plug straight to insert or remove it. (If the cable is inserted in the wrong direction, the pins could become deformed and cause faulty operation.)
- Also, do not insert into the wrong socket. Doing so may cause damage to this unit.

Charging battery

- If the computer enters sleep mode during charging, charging may be stopped.
- If a notebook computer that is not connected to an electrical outlet is connected to the camera, the battery of the notebook computer will be depleted. Do not leave the camera and notebook connected for a long period of time.
- Always connect the USB connection cable to the USB connector on your computer. Do not connect the USB connection cable to the USB connector of the monitor, keyboard, printer, or USB hub.

Charging lamp indications

ZS100

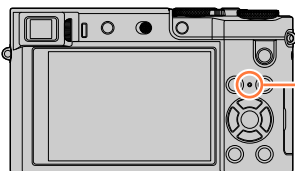

ZS60

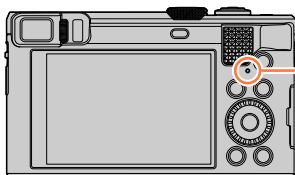

Charging lamp

On: Charging in progress

Off: Charging complete

(After charging stops, disconnect the camera from the electrical outlet or your computer.)

Flashing: Charging error

(For instructions on correcting the problem, refer to (→383).)

Notes on charging time

When using the AC adaptor (supplied)

Charging time	Approx. 190 min.
---------------	------------------

- The charging time indicated above is the time required for charging in case when the battery is completely used up. The time required for charging differs depending on conditions of battery usage. Charging takes longer in cases when temperatures are either high or low and when the battery has not been used for a long period of time.
- The time required for charging through the computer varies depending on the power supply capacity of the computer.

Charging battery

- Do not use any other USB connection cables except the supplied one. Doing so may cause malfunction of the camera.
- Do not use any other AC adaptors except the supplied one.
- Do not use a USB extension cable.
- The AC adaptor (supplied) and the USB connection cable (supplied) are dedicated accessories of this camera. Do not use them for other devices.
- Remove the battery after use. (The battery will be exhausted if left for a long period of time after being charged.)
- If there is any trouble related to the electrical outlet (i.e. power failure), charging may not complete properly. Disconnect the USB connection cable (supplied) and reconnect it to the camera.
- If the charging lamp does not light even when the camera is connected to the AC adaptor (supplied) or a computer, check to make sure it is properly connected. (→28, 29)



Remaining battery

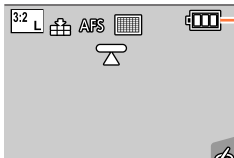

Remaining battery (only when using battery)



If the battery mark flashes red, recharge or replace a fully charged battery.

Estimated number of recordable pictures and operating time

■ Recording still pictures (When using monitor)

	ZS100	ZS60	
Number of recordable pictures	Approx. 300 pictures	Approx. 320 pictures	By CIPA standard
Recording time	Approx. 150 min.	Approx. 160 min.	

■ Recording still pictures (When using viewfinder (LVF))

	ZS100	ZS60	
Number of recordable pictures	Approx. 260 pictures	Approx. 280 pictures	By CIPA standard
Recording time	Approx. 130 min.	Approx. 140 min.	

Recording conditions by CIPA standard

CIPA is an abbreviation of “Camera & Imaging Products Association”.

- Program AE Mode
- Temperature: 23 °C (73.4 °F)/Humidity: 50%RH when monitor/viewfinder is on.
- Using a Panasonic SDHC Memory Card.
- Using the supplied battery.
- Starting recording 30 seconds after the camera is turned on (when [Stabilizer] is set to [(L)]).
- Recording once every 30 seconds with full flash every second recording.
- Rotating the zoom lever from Tele to Wide or vice versa in every recording.
- Turning the camera off every 10 recordings and leaving it until the temperature of the battery decreases.

Number reduced if intervals are longer (e.g. to approx. one quarter for 2-minute intervals under the above conditions).

■ Recording motion pictures (When using monitor)

ZS100

[Rec Format]	[AVCHD]	[MP4]	[MP4]
[Rec Quality]	[FHD/17M/60i]	[FHD/28M/60p]	[4K/100M/30p]
Available recording time	Approx. 105 min.	Approx. 100 min.	Approx. 90 min.
Actual available recording time*	Approx. 50 min.	Approx. 50 min.	Approx. 45 min.

ZS60

[Rec Format]	[AVCHD]	[MP4]	[MP4]
[Rec Quality]	[FHD/17M/60i]	[FHD/28M/60p]	[4K/100M/30p]
Available recording time	Approx. 110 min.	Approx. 110 min.	Approx. 90 min.
Actual available recording time*	Approx. 55 min.	Approx. 55 min.	Approx. 45 min.

*The time you can actually record when repeatedly turning the camera on and off, starting and stopping recording and using zoom.

Recording conditions

- Temperature 23 °C (73.4 °F), humidity 50%RH
- Motion pictures with [Rec Quality] setting of [FHD/28M/60p]/[FHD/17M/60i] in [AVCHD]:
Recording stops when the continuous recording time exceeds 29 minutes and 59 seconds.
- Motion pictures with their file size set to [FHD], [HD] or [VGA] in [MP4]:
Recording stops when the continuous recording time exceeds 29 minutes and 59 seconds or the file size exceeds 4 GB.
 - Since the file size becomes larger with [FHD], recording with [FHD] will stop before 29 minutes 59 seconds.
- MP4 motion pictures with a [Rec Quality] size of [4K]:
Recording stops when the continuous recording time exceeds 15 minutes.
When you are using an SDHC memory card, you can continue recording without interruption even if the file exceeds 4 GB, but the motion picture file will be recorded and played back in separate files.
If using an SDXC Memory Card, you can record a motion picture in a single file even if the size is greater than 4 GB.

■ Viewing pictures (When using monitor)**Playback time**

Approx. 260 min.

● The operating times and number of recordable pictures will differ according to the environment and the operating conditions.

For example, in the following cases, the operating times shorten and the number of recordable pictures is reduced.

- In low-temperature environments, such as on ski slopes.
 - When operations such as the flash and zoom are used repeatedly.
- If available battery power is significantly reduced, battery is reaching end of lifespan. Please purchase a new battery.



ZS100 Inserting and removing the card (optional)

- Make sure that the camera is turned off.

1 Slide the release lever to the [OPEN] position and open the card/battery door

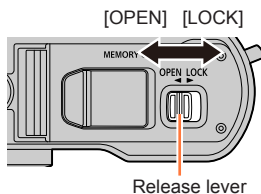

2 Insert the card all the way

- Check the orientation of a card (terminals face monitor).
- Insert the card all the way firmly until it clicks.

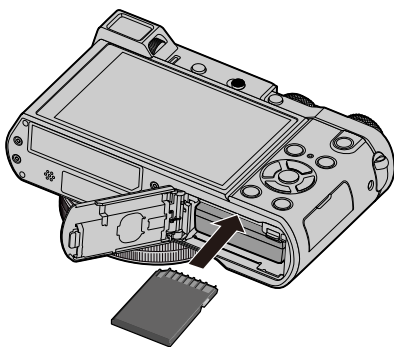

3 Close the card/battery door and slide the release lever to the [LOCK] position

■ To remove card:

Press the center of the card.

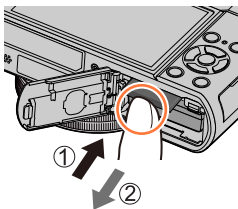

Do not touch the terminal

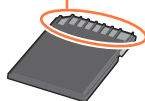

- Keep the Memory Card out of reach of children to prevent swallowing.
- To remove the card, turn the camera off and wait until the LUMIX indicator on the screen goes off. (Failure to wait may cause the camera to malfunction and may damage the card or recorded data.)



ZS60 Inserting and removing the card (optional)

- Make sure that the camera is turned off.

1 Slide the release lever to the [OPEN] position and open the card/battery door

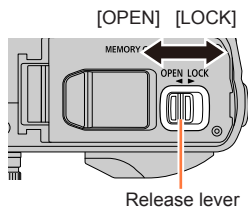

2 Insert the card all the way

- Check the orientation of a card (terminals face monitor).
- Insert the card all the way firmly until it clicks.

3 Close the card/battery door and slide the release lever to the [LOCK] position

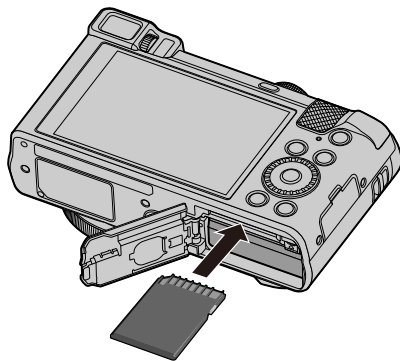

■ To remove card:

Press the center of the card.

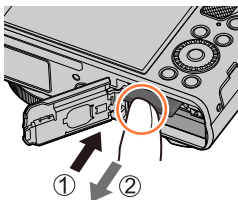

Do not touch the terminal

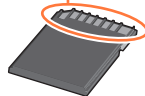

- Keep the Memory Card out of reach of children to prevent swallowing.
- To remove the card, turn the camera off and wait until the LUMIX indicator on the screen goes off. (Failure to wait may cause the camera to malfunction and may damage the card or recorded data.)

About the Card

The following SD standard-based cards (Panasonic brand recommended) can be used. Operation has been confirmed when using a Panasonic brand card.

Type of Card	Capacity	Notes
SD Memory Cards	512 MB – 2 GB	<ul style="list-style-type: none"> • Can be used with devices compatible with the respective formats. • Before using SDXC Memory Cards, check that your computer and other devices support this type of card. http://panasonic.net/avc/sdcard/information/SDXC.html • This unit is compatible with UHS-I UHS Speed Class 3 standard SDHC/SDXC memory cards. • Only the cards listed on the left with the given capacities are supported.
SDHC Memory Cards	4 GB – 32 GB	
SDXC Memory Cards	48 GB – 128 GB	

■ About motion picture/4K photo recording and speed class ratings

According to the [Rec Format] (→255) and [Rec Quality] (→255) of a motion picture, the required card differs. To record 4K photos, you need a card with a speed class rating that supports 4K photo recording. Use a card that meets the following ratings of the SD Speed Class or UHS Speed Class.

- SD Speed Class and UHS Speed Class are the speed standards regarding continuous writing. Confirm the SD speed by checking the card label or other card related materials.

[Rec Format]	[Rec Quality]	Speed class	Label example
[AVCHD]	All	Class 4 or higher	CLASS 4 4
[MP4]	[FHD]/[HD]/[VGA]		
[MP4]	[4K]/[High Speed Video]	UHS Speed Class 3	U3
When recording in 4K Photo / [Post Focus]		UHS Speed Class 3	U3

- Latest information:
<http://panasonic.jp/support/global/cs/dsc/>
(This site is available in English only.)

Access to the card

The access indication displays red when pictures are being recorded on the card.



- While the camera is accessing the card (for an operation such as picture writing, reading, deletion, or formatting), do not turn off the camera or remove the battery, card, AC adaptor (optional) or DC coupler (optional). Do not subject the camera to vibrations, impact, or static electricity. The card or the data on the card may be damaged, and this unit may no longer operate normally. If operation fails due to vibration, impact or static electricity, perform the operation again.

About the Card

- If you set the write-protect switch to “LOCK”, you may not be able to write, delete or format the data or display it by recording date.
- It is recommended that you copy important pictures to your computer (as electromagnetic waves, static electricity, or faults may cause data to be damaged).



Formatting the card (initialization)

Format the card before recording a picture with this unit.

Since data cannot be recovered after formatting, make sure to back up necessary data in advance.

1 Set the menu

MENU →  **[Setup]** → **[Format]**

- This requires a sufficiently charged battery, or an AC adaptor (optional) and DC coupler (optional).
- Do not turn off the camera or perform other operations during formatting.
- Always format cards with this camera. Please reformat the card with this camera if it has already been formatted with a computer or another device.
- If the card cannot be formatted, please try another card before contacting Panasonic.

Estimated recording capacity (number of pictures/recording time)

The number of pictures you can take and the recording time vary in proportion to card capacity (and depending on recording conditions and type of card).

Recording picture capacity (still pictures)

ZS100

When [Aspect Ratio] is set to [3:2] and [Quality] is set to [📷]

[Picture Size]	8 GB	16 GB	32 GB	64 GB
L (20M)	720	1450	2910	5810
EX M (10M)	1310	2650	5310	10510
EX S (5M)	2270	4600	9220	17640

When [Aspect Ratio] is set to [3:2] and [Quality] is set to [RAW📷]

[Picture Size]	8 GB	16 GB	32 GB	64 GB
L (20M)	220	450	920	1840
M (10M)	260	530	1070	2140
S (5M)	290	580	1170	2340

ZS60

When [Aspect Ratio] is set to [4:3] and [Quality] is set to [📷]

[Picture Size]	8 GB	16 GB	32 GB	64 GB
L (18M)	800	1610	3240	6500
EX M (9M)	1470	2970	5950	11760
EX S (4.5M)	2590	5240	10500	20590

When [Aspect Ratio] is set to [4:3] and [Quality] is set to [RAW📷]

[Picture Size]	8 GB	16 GB	32 GB	64 GB
L (18M)	240	490	1000	2000
M (9M)	280	580	1160	2330
S (4.5M)	310	630	1270	2540

- When the number of recordable pictures exceeds 9,999, "9999+" is displayed.



Recording time capacity (motion pictures)

- The recordable time is the total time of all the motion pictures which have been recorded.

([h], [m] and [s] indicate "hour", "minute" and "second".)

When [Rec Format] is [AVCHD]

ZS100

[Rec Quality]	8 GB	16 GB	32 GB	64 GB
[FHD/28M/60p]	36m00s	1h15m00s	2h30m00s	5h00m00s
[FHD/17M/60i]	1h00m00s	2h00m00s	4h05m00s	8h15m00s
[FHD/24M/30p] [FHD/24M/24p]	42m00s	1h25m00s	2h55m00s	5h50m00s

ZS60

[Rec Quality]	8 GB	16 GB	32 GB	64 GB
[FHD/28M/60p]	36m00s	1h15m00s	2h30m00s	5h00m00s
[FHD/17M/60i]	1h00m00s	2h00m00s	4h05m00s	8h15m00s
[FHD/24M/30p]	42m00s	1h25m00s	2h55m00s	5h50m00s

When [Rec Format] is [MP4]

ZS100

[Rec Quality]	8 GB	16 GB	32 GB	64 GB
[4K/100M/30p] [4K/100M/24p]	9m00s	20m00s	42m00s	1h20m00s
[FHD/28M/60p]	36m00s	1h15m00s	2h30m00s	5h00m00s
[FHD/20M/30p]	49m00s	1h40m00s	3h20m00s	6h40m00s
[HD/10M/30p]	1h30m00s	3h10m00s	6h25m00s	12h50m00s
[VGA/4M/30p]	3h25m00s	7h00m00s	14h05m00s	28h15m00s

ZS60

[Rec Quality]	8 GB	16 GB	32 GB	64 GB
[4K/100M/30p]	9m00s	20m00s	42m00s	1h20m00s
[FHD/28M/60p]	37m00s	1h15m00s	2h30m00s	5h00m00s
[FHD/20M/30p]	49m00s	1h40m00s	3h20m00s	6h40m00s
[HD/10M/30p]	1h30m00s	3h10m00s	6h25m00s	12h50m00s
[VGA/4M/30p]	3h25m00s	7h00m00s	14h05m00s	28h15m00s

- If the surrounding temperature is high, or a motion picture is recorded continuously, [] is displayed and recording may be stopped halfway through to protect the camera.
- Motion pictures with [Rec Quality] setting of [FHD/28M/60p]/[FHD/17M/60i] in [AVCHD]:
Recording stops when the continuous recording time exceeds 29 minutes and 59 seconds.
- Motion pictures with their file size set to [FHD], [HD] or [VGA] in [MP4]:
Recording stops when the continuous recording time exceeds 29 minutes and 59 seconds or the file size exceeds 4 GB.
 - Since the file size becomes larger with [FHD], recording with [FHD] will stop before 29 minutes 59 seconds.
- MP4 motion pictures with a [Rec Quality] size of [4K]:
Recording stops when the continuous recording time exceeds 15 minutes.
When you are using an SDHC memory card, you can continue recording without interruption even if the file exceeds 4 GB, but the motion picture file will be recorded and played back in separate files.
If using an SDXC Memory Card, you can record a motion picture in a single file even if the size is greater than 4 GB.
- **The maximum available continuous recording time is displayed on the screen.**

Switching the display between the number of recordable pictures that you can take and the available recording time

MENU → [Custom] → [Remaining Disp.]

(Remaining shots):

Displays the number of pictures that can be recorded.

(Remaining time):

Displays the remaining recording time.

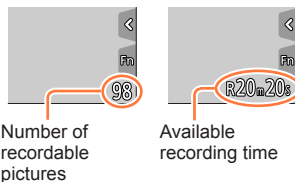

Setting the clock

The clock is not set when the camera is shipped.

- 1** **ZS100**
Set the Camera [ON/OFF] switch to [ON]

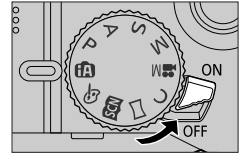

- ZS60**
Press the Camera [ON/OFF] button

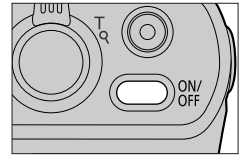

• If the language select screen is not displayed, proceed to step 4.

- 2** Press [MENU/SET] while the message is displayed
- 3** Press ▲ ▼ to select the language, and press [MENU/SET]
• The [Please set the clock] message appears.
- 4** Press [MENU/SET]
- 5** Press ◀ ▶ to select the items (year, month, day, hour, minute), and press ▲ ▼ to set

To set the display order or time display format

- Select [Style] and press [MENU/SET] to display the setting screen for display order and time display format.

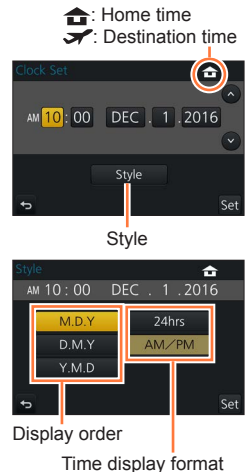

- 6 Press [MENU/SET]
- 7 When [The clock setting has been completed.] is displayed, press [MENU/SET]
- 8 When [Please set the home area] is displayed, press [MENU/SET]
- 9 Press ◀▶ to set your home area and press [MENU/SET]



- If the clock is not set, the correct date cannot be printed when you order a photo studio to print the picture, or when you stamp the date on the pictures with [Text Stamp].

Changing time settings

- 1 Select [Clock Set] from the [Setup] menu
 - For details about how to set the menu (→65)
- 2 Set the date and time (Perform steps 5 - 6. (→42))

- Clock settings will be saved for approx. 3 months even after the battery is removed, provided a fully charged battery was installed in the camera for 24 hours beforehand.

Holding the camera

Hold the camera gently with both hands keeping your arms close to your body while standing with your feet slightly apart.

- To prevent dropping, be sure to attach the supplied strap and fit it to your wrist.
- Do not block the flash, AF Assist Lamp, microphone, or speaker with your fingers or other objects.
- Make sure that the camera does not move at the moment the shutter button is pressed.
- Make sure your footing is stable and there is no danger of colliding with another person or object in the vicinity while taking pictures.

ZS100

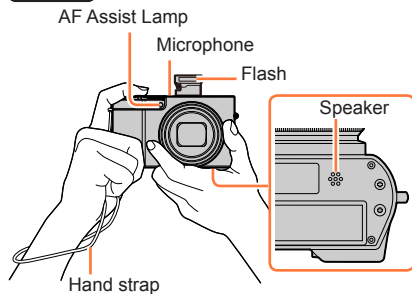

ZS60

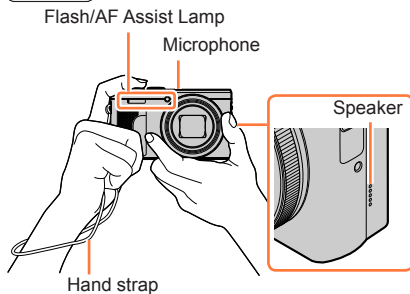

About the direction detect function

Still pictures recorded with the camera held vertically can be automatically displayed in portrait orientation during playback. (Only when [Rotate Disp.] is set to [ON].)

- The direction detect function may not operate correctly if pictures are taken with the camera pointing up or down.
- Motion pictures, 4K burst files recorded with the 4K Photo function, and pictures recorded in [Post Focus] cannot be displayed vertically.

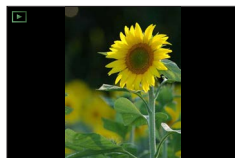

Buttons/Dials/Levers Used for Recording

Zoom Lever (Use Zoom)

You can adjust the area of a picture to be taken using the zoom or control ring.

- You can also use the zoom function from the touch panel. (→240)
- For details about zoom types and use, refer to (→236).

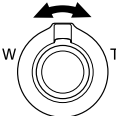
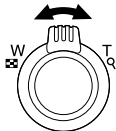
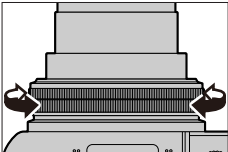
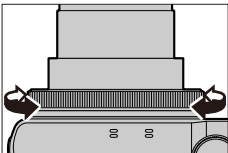
Zoom lever	Control ring
<p>1 Move the zoom lever</p> <p>ZS100</p>  <p>ZS60</p> 	<p>1 Turn the control ring*</p> <p>ZS100</p>  <p>ZS60</p>  <p>* You can perform zoom operation by assigning the [Zoom] setting to the control ring. (→74, 75)</p>
<p>T side: Telephoto, Enlarge the subject W side: Wide-angle, Capture a wider area</p>	<p>Clockwise: Telephoto, Enlarge the subject Counterclockwise: Wide-angle, Capture a wider area</p>

- Do not touch the lens barrel during zooming.
- Adjust the focus after adjusting the zoom.
- The camera may make a rattling noise and vibrate when the zoom lever or control ring is operated. This is not a malfunction.



Shutter button (Taking pictures)

- Press the [] button (▼) to set the drive mode to [] ([Single]).

1 Press the shutter button halfway (press lightly) to focus on the subject

- The aperture value and shutter speed are displayed. (If the aperture value and shutter speed are shown in red and flashing, you do not have the appropriate exposure, unless you are using the flash.)



Focus display

(When focus is aligned:
illuminated)

(When focus is not aligned:
flashing)

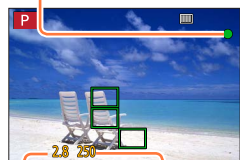

Shutter speed
Aperture value

2 Press the shutter button fully (push the button all the way), and take the picture



- Pictures can be taken only when the image is correctly focused as long as the [Focus/Release Priority] (→164) is set to [FOCUS].
- Even during menu operation or picture playback, if you press the shutter button halfway, you can instantly set the camera ready for recording.

Focus range

Focus range is displayed when operating the zoom

- The focus range is displayed in red when it is not focused after pressing the shutter button halfway.



Focus range

The focus range may change gradually depending on the zoom position.

Example: Range of focus during the Program AE Mode

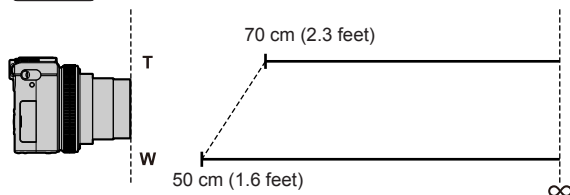
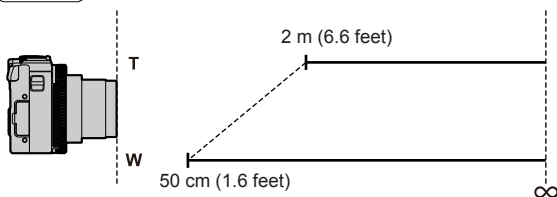
ZS100

ZS60

Displaying still pictures immediately after taking them

MENU → **fC [Custom]** → **[Auto Review]**

Set the time to display the pictures you have taken after taking still pictures.

Settings: **[HOLD]** / **[5SEC]** / **[4SEC]** / **[3SEC]** / **[2SEC]** / **[1SEC]** / **[OFF]**

- When **[HOLD]** is selected, pictures are displayed until you press the shutter button halfway.
- During 4K Photo recording (→184) and [Post Focus] recording (→210), the [Auto Review] settings items change to **[ON]** and **[OFF]**.

Motion picture button (Recording motion pictures)

1 Press the motion picture button to start recording

- Immediately release the motion picture button after pressing it.

ZS100

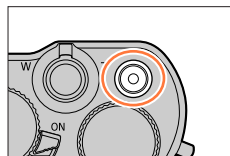

ZS60

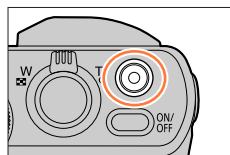

2 Press the motion picture button again to end recording



Mode dial (Select the recording mode)

1 Set to the desired recording mode

- Rotate the mode dial slowly to select the desired mode.

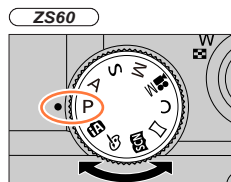
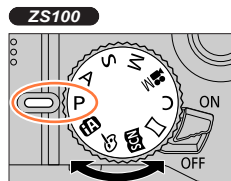

iA	Intelligent Auto Mode (→88) Take pictures with automatic settings.
iA+	Intelligent Auto Plus Mode (→95) Allows you to adjust the brightness (exposure) and color hue as desired.
P	Program AE Mode (→97) Take pictures with automatic shutter speed and aperture value settings.
A	Aperture-Priority AE Mode (→101) Determine aperture, then record pictures.
S	Shutter-Priority AE Mode (→102) Determine shutter speed, then record pictures.
M	Manual Exposure Mode (→103) Determine aperture and shutter speed, then record pictures.
M	Creative Video Mode (→124) Determine aperture and shutter speed, then record motion pictures. * You cannot take still pictures.
C	Custom Mode (→127) Record pictures using pre-registered settings.
W	Panorama Shot Mode (→109) Record panorama pictures.
SCN	Scene Guide Mode (→112) Take pictures that match the scene being recorded.
Hand icon	Creative Control Mode (→117) Take pictures by selecting your preferred picture effect.

ZS100 Control ring / Rear dial

The "Control Ring/Rear dial" is an easy and convenient way to adjust several settings, depending on the camera mode selected. You can use the control ring (A)/rear dial (B) to change the settings of the unit.

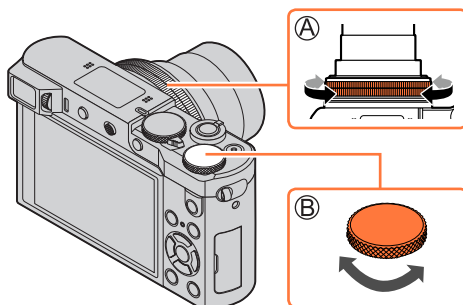

Items that can be set by the control ring/rear dial vary depending on recording modes. Following are the pre-assigned settings.

Mode dial	Control ring*1	Rear dial
[IA] (→88)	Q Step Zoom (→239)	—
[P] (→97)	P Program Shift (→97)	
[A] (→101)	F Aperture adjustment (→101)	
[S] (→102)	SS Shutter speed adjustment (→102)	
[M] (→103)	F Aperture adjustment*2 (→103)	SS Shutter speed adjustment*2 (→103)
[] (→109)	Picture effects change (→117)	
[SCN] (→112)	F Aperture adjustment*3 (→103) / SS Shutter speed adjustment*4 (→103)	
[] (→117)	Picture effects change (→117)	

*1 When Manual Focus is set, the control ring is assigned to focus adjustment. (→167)

*2 Press ▲ to switch between shutter speed adjustment and aperture adjustment.

*3 The operation is possible only when the Scene Guide Mode is set to [Appetizing Food].

*4 The operation is possible only when the Scene Guide Mode is set to [Artistic Nightscape].

- The control ring/rear dial can be used to change to your preferred settings. (→74)

ZS60 Control ring / Control dial

The "Control Ring/Control dial" is an easy and convenient way to adjust several settings, depending on the camera mode selected. You can use the control ring (A)/control dial (B) to change the settings of the unit.

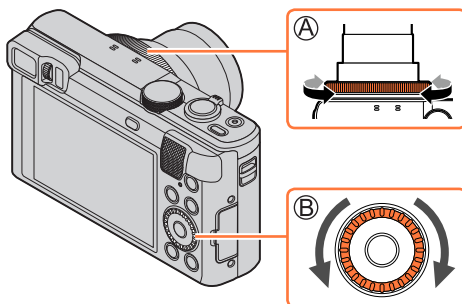

Items that can be set by the control ring/control dial vary depending on recording modes. Following are the pre-assigned settings.

Mode dial	Control ring*1	Control dial
[fA] (→88)	Step Zoom (→239)	—
[P] (→97)	Program Shift (→97)	
[A] (→101)	Aperture adjustment (→101)	
[S] (→102)	Shutter speed adjustment (→102)	
[M] (→103)	Aperture adjustment*2 (→103)	Shutter speed adjustment*2 (→103)
[□] (→109)	Picture effects change (→117)	
[SCN] (→112)	Aperture adjustment*3 (→103) / Shutter speed adjustment*4 (→103)	
[🎨] (→117)	Picture effects change (→117)	

*1 When Manual Focus is set, the control ring is assigned to focus adjustment. (→167)

*2 Press to switch between shutter speed adjustment and aperture adjustment.

*3 The operation is possible only when the Scene Guide Mode is set to [Appetizing Food].

*4 The operation is possible only when the Scene Guide Mode is set to [Artistic Nightscape].

- The control ring/control dial can be used to change to your preferred settings. (→75)

Enabling/disabling the operation guide display

MENU → **FC** [Custom] → [Dial Guide] → [ON] / [OFF]

- When you set [Dial Guide] to [ON], operation guide appears on the recording screen.



Example

Cursor button / [MENU/SET] button (Selecting/setting items)

Pressing the cursor button: Selection of items or setting of values etc., is performed.

Pressing [MENU/SET]: Confirmation of setting contents, etc., is performed.

- In this manual, the button that is to be used is indicated by ▲▼◀▶.

ZS100

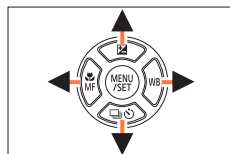

ZS60

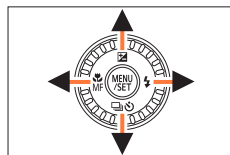

- Even when the camera is operated using the touch screen, it is possible to operate with the cursor button and [MENU/SET] button if a guide like the one shown on the right is displayed.
- Even on menu screens etc. on which the guide is not displayed, you can make settings and selections by operating the buttons.

ZS100



When the [Cursor Button Lock] is assigned to the function button, operation of the cursor button and [MENU/SET] button can be disabled. (→70)

[DISP.] button (Switching the display information)

1 Press [DISP.] button to switch the display

- If the information on the screen is not displayed any longer because no operation was performed for some time, press the [DISP.] button or touch the screen to display the information again.

ZS100

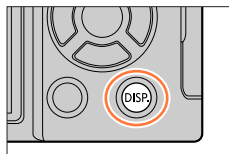

ZS60

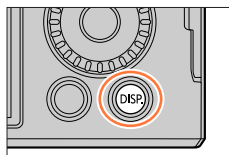

During recording

You can use [Monitor Disp. Style] and [LVF Disp.Style] in the [Custom] menu to select either [] (Monitor style display layout) or [] (Live View Finder style display layout) for the display screen of the monitor and viewfinder.

■ [] Monitor style display layout (Example of monitor style display)

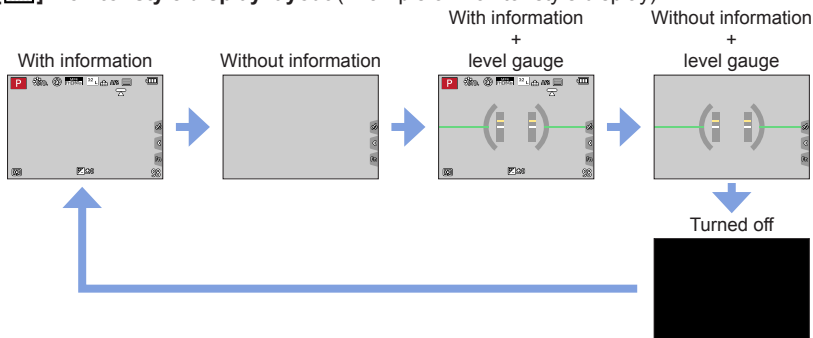

Buttons/Dials/Levers Used for Recording

■  Live View Finder style display layout (Example of viewfinder style display)

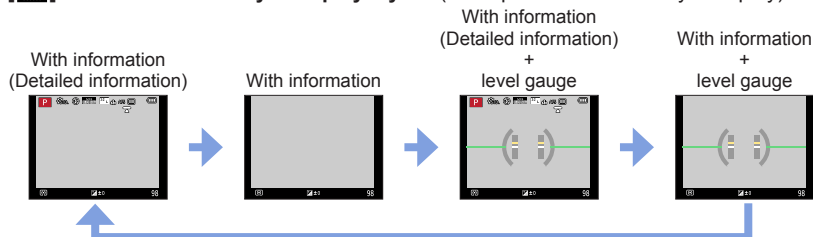

 Switching the monitor display method

MENU → **⌘** [Custom] → [Monitor Disp. Style]

: Live View Finder style display layout

: Monitor style display layout

 Switching the viewfinder display method

MENU → **⌘** [Custom] → [LVF Disp.Style]

: Live View Finder style display layout

: Monitor style display layout

Enabling/disabling the histogram display

MENU → **fC [Custom]** → **[Histogram]** → **[ON] / [OFF]**

When set to [ON], you can move the display position of the histogram by pressing ▲ ▼ ◀ ▶.

- Direct touch operation is also possible from the recording screen.

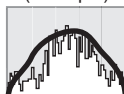

Displays distribution of brightness in picture – e.g. if the graph peaks at the right, this means there are several bright areas in the picture. A peak in the center represents correct brightness (correct exposure). This can be used as a reference for exposure correction, etc.

(Example)





Dark ← OK → Bright

- **When the histogram is not the same as that of the recorded picture under the following conditions, histogram will be displayed in orange:**

- When manual exposure assist indicates settings other than [ ] in Manual Exposure Mode or during Exposure Compensation.
- When the flash fires.
- When the correct exposure is not achieved or when the brightness of the screen cannot be displayed accurately in a dark location.
- The histogram is different from those displayed using the image editing software of a computer.

Enabling/disabling the guideline display

MENU → **fC [Custom]** → **[Guide Line]** → [] / [] / [] / [OFF]

- The guideline is not displayed during panorama picture recording.
- When you select [], you can move the position of the guideline by pressing ▲ ▼ ◀ ▶.
- You can also set the position directly by touching [] on the guideline of the recording screen.



Using the level gauge

If you want to make sure that the camera is not slanted or tilted, for example, when you take a picture of a landscape, use the level gauge indication as a reference.

1 Press [DISP.] button to display the level gauge

The yellow line indicates the current angle. Correct the angle of the camera so that it matches the white line.

Tilting up or down

- In this case, it is facing upward.

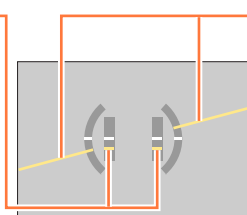
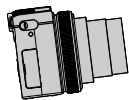

Tilting left or right

- In this case, the right side has dropped.

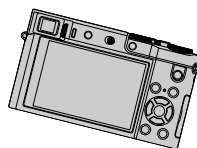

- When the camera is tilted very little or not at all, the level gauge will turn green.

- Even when angle is more or less corrected, there may be an error of about ± 1 degree.
- When [Level Gauge] is assigned to a function button, you can turn the level gauge on and off every time you press the function button.
- The level gauge may not be displayed correctly or the direction detect function ([→44](#)) may not operate correctly if the pictures are taken with the camera pointing sharply up or down.

Buttons/Dials/Levers Used for Recording

During playback

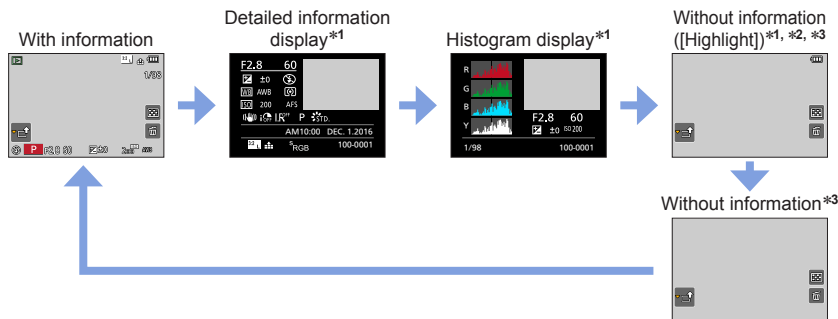

*1 This screen is not displayed during Playback Zoom, Motion Picture Playback, Automatic Scrolling Playback of panorama pictures, continuous playback or Slide Show.

*2 This screen is displayed only when [Highlight] (below) in the [Custom] menu is set to [ON].

*3 If no operation is performed for a few seconds, [] and other touch icons will disappear.

- A histogram of each color, including R (red), G (green), B (blue), and Y (luminance), is separately displayed during playback.



Enabling/disabling the overexposed area display

MENU → **ƒC [Custom]** → **[Highlight]** → **[ON] / [OFF]**

You can set overexposed areas (areas that are too bright and where there are no shades of gray) to flash on the screen when the [Auto Review] function is activated or during playback. This does not affect recorded pictures.

- To reduce overexposed areas, record a picture by setting negative exposure compensation (→177) using the histogram display (→55) and so on as a reference.
- This feature is disabled during 4K photo playback, playback of pictures recorded in Post Focus, Multi Playback, Calendar Playback, or Playback Zoom.



[LVF] button (Recording pictures using the viewfinder)

Switching between the monitor and viewfinder

You can operate the [LVF] button/[Fn4] button in two ways, using it either as the [LVF] button or as a function button [Fn4]. You can use this button as the [LVF] button at the time of purchase.

- For details on the function button, refer to (→70).

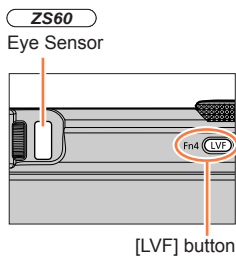
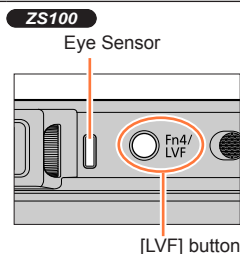

1 Press [LVF] button

Automatic switching
between viewfinder and
monitor (eye sensor)

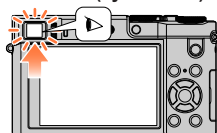

Viewfinder display

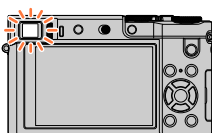

Monitor display

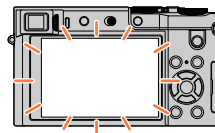

Mode	Display
Automatic switching between viewfinder and monitor (eye sensor)	The eye sensor automatically switches the display to viewfinder when your eye or an object moves close to the viewfinder. When the eye or object moves away from the viewfinder, the camera returns to monitor display.
Viewfinder display	Viewfinder display only
Monitor display	Monitor display only

■ About the eye sensor

- The eye sensor may react depending on the shape of your eyeglasses, the way you hold the camera, or whether the eye sensor is exposed to strong light.
- During motion picture playback or Slide Show, the eye sensor does not operate.

About diopter adjustment

Rotate the diopter adjustment dial to adjust until you are able to clearly see the characters displayed in the viewfinder.

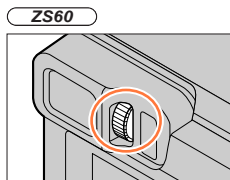
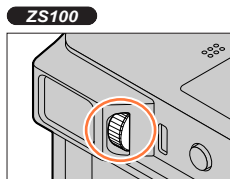

Setting the sensitivity of the eye sensor or setting to switch the display between the viewfinder and monitor

MENU → **fC** [Custom] → [Eye Sensor]

[Sensitivity]	Use this setting to set the sensitivity of the eye sensor. [HIGH] / [LOW]
[LVF/Monitor Switch]	Use this setting to switch the display between the viewfinder and monitor. [LVF/MON AUTO] (Automatic switching between viewfinder and monitor) / [LVF] (Viewfinder display) / [MON] (Monitor display) • After the display is switched using the [LVF] button, the setting of [LVF/Monitor Switch] will also change.



Adjusting/not adjusting the focus automatically when the eye sensor is activated

MENU → **fC** [Custom] → [Eye Sensor AF] → [ON] / [OFF]

- Even when [Eye Sensor AF] is set and the camera automatically adjusts the focus, a beep will not sound.
- [Eye Sensor AF] may not work when the lighting is low.

Touch screen (Touch operations)

Touch screen of this unit is capacitive. Touch the panel directly with your bare finger.

Touch

To touch and release the touch screen. Be sure to touch the center of the desired icon.



Drag

To touch and slide your finger across the touch screen. This can also be used to forward or rewind a picture during playback, etc.



Pinch (spread/pinch)

On the touch screen, spread (pinch out) your 2 fingers to zoom in, and pinch (pinch in) your 2 fingers to zoom out.

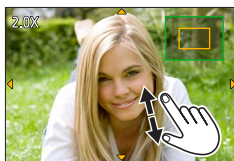

Enabling/disabling the touch operation

MENU → **fC** [Custom] → [Touch Settings]

[Touch Screen]	All touch operations. When set to [OFF], only button and dial operations can be used. [ON] / [OFF]
[Touch Tab]	Operation to display the touch icons by touching tabs such as [Q] displayed on the right of the screen. [ON] / [OFF]
[Touch AF]	Operation to optimize the focus or both the focus and brightness for a touched subject. [AF] (→156) / [AF+AE] (→162) / [OFF]
[Touch Pad AF]	Operation to move the AF area by touching the monitor when the viewfinder is in use. (→161) [EXACT] / [OFFSET] / [OFF]

Touch screen (Touch operations)

- Touch the screen with the clean and dry finger.
- If you use a commercially available monitor protection sheet, please follow the instructions that accompany the sheet. (Some monitor protection sheets may impair visibility or operability.)
- Do not press on the monitor with hard pointed tips, such as ballpoint pens.
- Do not press the touch screen with your fingernails.
- Clean the monitor with a soft, dry cloth if there are fingerprints or other kinds of dirt on it.
- Do not scratch or press the monitor too hard.
- The touch screen may not function normally in the following cases.
 - When touched by a gloved hand
 - When the touch screen is wet
 - When touched by multiple hands or fingers at the same time



Touching the screen and recording (Touch Shutter function)

Recording mode: **P**

This function enables you to focus and record still pictures simply by touching the subjects that appear on the screen.

1 Touch



2 Touch

- The icon changes to and you can now proceed with touch shutter recording.



3 Touch the subject you want to record

- To release the touch shutter function → Touch .



- If shooting with the touch shutter fails, the AF area turns red and disappears.
- Measurement of brightness is performed on the spot touched when the [Metering Mode] (→183) is set to . At the edge of the screen, the metering may be affected by the brightness around the touched location.

Easily Optimizing the Brightness for a Specified Area ([Touch AE])

Recording mode:

You can easily optimize the brightness for a touched position. When the face of the subject appears dark, you can brighten the screen according to the brightness of the face.

1 Touch []

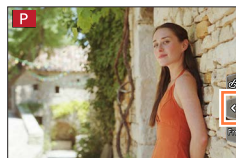

2 Touch []

- The setting screen for the brightness optimization position is displayed.
- [Metering Mode] is set to [], which is used exclusively for the [Touch AE].

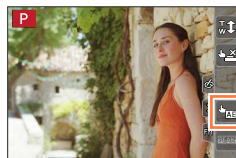

3 Touch the subject you want to optimize the brightness for

- Touching [Reset] will bring the brightness optimization position back to the center.



4 Touch [Set]

■ Canceling the [Touch AE] function

Touch []

- [Metering Mode] returns to the original setting, and the brightness optimization position is canceled.
- This function is not available in the following cases:
 - When using the Digital Zoom
 - When [High Speed Video] is set
 - When [4K Live Cropping] is set
 - When [Touch AF] in [Touch Settings] of the [Custom] menu has been set to [AF+AE] (→61)

Setting the menu

You can use the menu to set camera and recording functions, operate playback functions, and perform other operations.

In this Owner's Manual, steps for setting a menu item are described as follows:

Example: To change the [Quality] setting from [] to [] in the [Rec] menu

MENU →  **[Rec]** → **[Quality]** → **[]**

How to set the menu

Menu settings can be made either by button or touch operation.



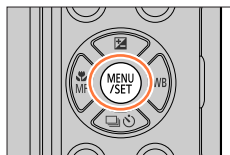

1 Press [MENU/SET] to bring up the menu

ZS100

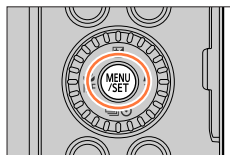

ZS60



 [Rec] (→379)	You can perform settings for the aspect ratio, number of pixels, 4K Photo, etc.
 [Motion Picture] (→380)	You can select the recording format and picture quality and other settings.
 [Custom] (→381)	Operation of the unit, such as displaying of the screen and button operations, can be set up according to your preferences. Also, it is possible to register the modified settings.
 [Setup] (→382)	You can perform settings that make usage more convenient, such as the changing the clock settings and beep volume. You can also perform Wi-Fi function-related settings.
 [Playback] (→382)	You can specify picture protection, cropping, print settings, and other settings for pictures you have taken.

Setting the menu

■ Switching menu type

- 1 Press ◀
- 2 Press ▲▼ to select a tab such as [🔧]
 - **ZS100**
Items can also be selected by rotating the rear dial.
 - **ZS60**
Items can also be selected by rotating the control dial.
- 3 Press [MENU/SET]

— **With touch screen operations** —

Touch a tab, such as [🔧]

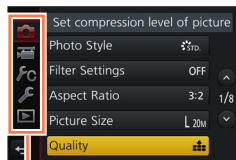

Menu type

2 Press ▲▼ to select the menu item and press [MENU/SET]

- **ZS100**
The menu item can also be selected by rotating the rear dial.
- **ZS60**
The menu item can also be selected by rotating the control dial.

- You can also switch to the next page by pressing [DISP.] button or rotating the zoom lever.

— **With touch screen operations** —

Touch the menu item

- You can switch to the next page by touching [◀]/[▶].

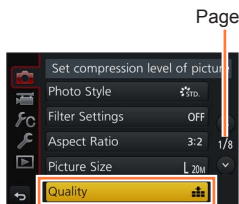

Item

3 Press ▲▼ to select the setting and press [MENU/SET]

- **ZS100**
The setting can also be selected by rotating the rear dial.
 - **ZS60**
The setting can also be selected by rotating the control dial.
- The setting methods vary depending on the menu item.

— **With touch screen operations** —

Touch the setting to set

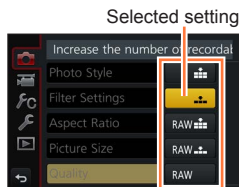

Settings

Setting the menu

4 Press [Q.MENU/↵] button repeatedly until the recording or playback screen reappears

- During recording, the menu screen can also be exited by pressing the shutter button halfway.

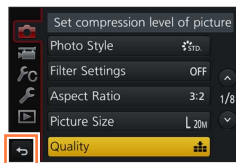
**With touch screen operations****Touch [☰]**

- When [Menu Resume] (→84) in the [Setup] menu is set to [ON], the screen displayed last after you selected the menu item will reappear. It is set to [ON] at the time of purchase.
- When the [Menu Information] (→84) in the [Setup] menu is set to [ON], descriptions of the menu items and settings will appear on the menu screen.



Calling frequently-used menus instantly (Quick Menu)

You can easily call some of the menu items and set them during recording.

- Some items or settings can not be selected depending on the mode or display style the camera is in.

1 Press [Q.MENU/☰] button

ZS100

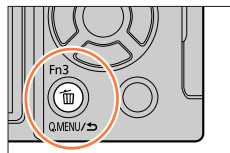

ZS60

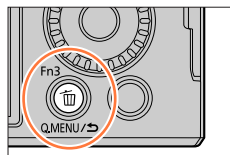

2 Rotate the rear dial to select a menu item, and press ▼ or ▲

ZS100

ZS60

Rotate the control dial to select a menu item, and press ▼ or ▲

- The menu item can also be selected by pressing ◀▶.



3 Rotate the rear dial to select the setting

ZS100

ZS60

Rotate the control dial to select the setting

- The setting can also be selected with ◀▶.

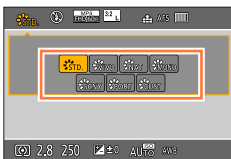

4 Press [Q.MENU/☰] button to close the Quick menu

Calling frequently-used menus instantly (Quick Menu)

**ZS100 Switching the method for setting Quick Menu items****MENU** → **ƒC** [Custom] → [Q.MENU]**[PRESET]:** The default items can be set.**[CUSTOM]:** The Quick Menu will consist of desired items (below).**ZS100 Change the Quick Menu to your preferred item**

When [Q.MENU] in the [Custom] menu is set to [CUSTOM] (above), the Quick Menu can be changed as desired. Up to 15 items can be set to the Quick Menu.

1 After pressing the [Q.MENU/↵] button, press ▼ to select [ƒC], and press [MENU/SET]

2 Press ▲▼◀▶ to select the menu item in the top row and press [MENU/SET]

- Items that are displayed in gray in the top row have already been set.

3 Press ◀▶ to select the empty space in the bottom row and press [MENU/SET]

- You can also set the menu item by dragging it from the top row to the bottom row.
- If there is no empty space in the bottom row, you can replace an existing item with a new select item by selecting the existing item.
- To cancel the setting, move to the bottom row by pressing ▼ and select an item to cancel, and then press [MENU/SET].

4 Press [Q.MENU/↵] button

- It will return to screen of step 1. Press [MENU/SET] to switch to the recording screen.

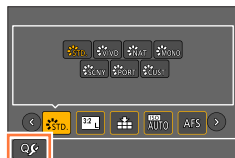

Top row:
Items that can be set

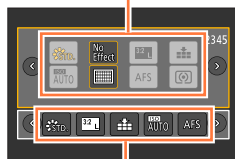

Bottom row: Set items



Assigning frequently used functions to the buttons

(Function buttons)

You can assign frequently-used functions to particular buttons ([Fn1] - [Fn4]) or icons displayed on the screen ([Fn5] - [Fn9]).

- Certain functions cannot be assigned to some function buttons.
- The function assigned to the function button may not work in some modes or on some display screens.

1 Set the menu

MENU → **ƒC [Custom]** → **[Fn Button Set]**

2 Use ▲ ▼ to select [Setting in REC mode] or [Setting in PLAY mode] and press [MENU/SET]

3 Press ▲ ▼ to select the function button you want to assign a function to and press [MENU/SET]

4 Press ▲ ▼ to select the function you want to assign and press [MENU/SET]

- For details on the functions that can be assigned in [Setting in REC mode], refer to (→71).
- For details on the functions that can be assigned in [Setting in PLAY mode], refer to (→73).

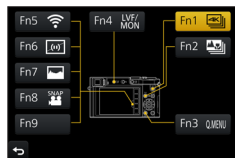

■ Rapidly assigning functions

The assignment screen displayed in Step 4 above can be displayed by holding a function button ([Fn1] to [Fn4]) for 2 seconds.

Recording mode:

The function assignment screen for [Setting in REC mode] is displayed

Playback mode:

The function assignment screen for [Setting in PLAY mode] is displayed

- In some cases the function assignment screen cannot be displayed depending on the mode or display screen

Assigning frequently used functions to the buttons (Function buttons)

Using the function buttons during recording

Press the function button to use the assigned function.

Using function buttons with touch operations

- ① Touch [F]
- ② Touch [Fn5], [Fn6], [Fn7], [Fn8] or [Fn9]



Functions that can be assigned in [Setting in REC mode]

[Rec] menu/Recording functions

- [4K PHOTO] (→184): [Fn1]*
- [Wi-Fi] (→302): [Fn5]*
- [Q.MENU] (→68): [Fn3]*
- [LVF/Monitor Switch] (→58): [Fn4]*
- [AF/AE LOCK] (→173, 175)
- [AF-ON] (→173, 175)
- [Preview] (→106)
- [One Push AE] (→108)
- [Touch AE] (→64)
- [Level Gauge] (→56): [Fn6]*
- [Focus Area Set]
- **ZS100** [Cursor Button Lock]
- [Photo Style] (→129)
- [Filter Select] (→131)
- [Aspect Ratio] (→139)
- [Picture Size] (→139)
- [Quality] (→140)
- [Sensitivity] (→179)
- **ZS60** [White Balance] (→134)
- [AF Mode] (→149)
- [AFS/AFF/AFC] (→148)
- [Metering Mode] (→183)
- [Burst Rate] (→202)
- [Auto Bracket] (→206)
- [Self Timer] (→208)
- **ZS100** [Highlight Shadow] (→133)
- [i.Dynamic] (→142)
- [i.Resolution] (→142)
- [Post Focus] (→210): [Fn2]*
- [HDR] (→143)
- [Shutter Type] (→199)
- **ZS100** [Flash Mode] (→243)
- [Flash Adjust.] (→250)
- [i.Zoom] (→237)
- [Digital Zoom] (→238)
- [Stabilizer] (→234)
- [Exposure Comp.] (→177)
- **ZS60** [Flash Mode] (→244)
- **ZS100** [White Balance] (→134)
- [Focus Mode] (→146, 165, 167)
- [Drive Mode] (→201)
- [Restore to Default]

Assigning frequently used functions to the buttons (Function buttons)

[Motion Picture] menu	
• [4K Live Cropping] (→258)	• [Motion Pic. Set] (→255)
• [Snap Movie] (→262): [Fn8]*	

[Custom] menu	
• [Silent Mode] (→225)	• [Monochrome Live View] (→231)
• [Peaking] (→172)	• [Rec Area] (→252)
• [Histogram] (→55): [Fn7]*	• [Zoom lever] (→239)
• [Guide Line] (→55)	• [Touch Screen] (→61)
• [Zebra Pattern] (→230)	

*Function button settings at the time of purchase.
([Fn9] has no function button setting at the time of purchase)

- When [Focus Area Set] is assigned to the function button, you can display the AF area or the MF Assist position setting screen.
- **ZS100**
When [Cursor Button Lock] is assigned to a function button, operation of the cursor button and [MENU/SET] is disabled. To enable operation, press the function button again.
- Setting [Restore to Default] returns the function buttons to their original settings at the time of purchase.
- The function assigned to the [Fn1] button will not work in the following cases:
 - When using [Time Lapse Shot]
 - **ZS100** When [Multi Exp.] is set
 - When recording with [] ([4K Burst(S/S)]) of the 4K Photo function.
 - When [4K Live Cropping] is set
- The function registered to the [Fn2] button will not work in the following cases.
 - **ZS100** When setting AF area when Auto Focus Mode is [Custom Multi]
 - When doing peaking operation after recording in [Post Focus]
 - When playing back [] ([4K Burst]) or [] ([4K Burst(S/S)]) 4K burst files in the 4K photo function
- [Fn5], [Fn6], [Fn7], [Fn8], and [Fn9] cannot be used when the viewfinder is in use.

Assigning frequently used functions to the buttons (Function buttons)

Using the function buttons during playback

You can directly set an assigned function to a selected image by pressing the function button during playback.

Example: When [Fn2] is set to [Favorite]

- 1 Press ◀▶ to select the picture
- 2 Press [Fn2] button, and then set the picture as [Favorite]



Functions that can be assigned in [Setting in PLAY mode]

- The following functions can be assigned to the button [Fn1], [Fn2], or [Fn4].

[Playback] menu/Playback functions	
• [Favorite] (→297): [Fn2]*	• [Delete Single] (→277)
• [Print Set] (→298)	• [Off]: [Fn1]*, [Fn4]*
• [Protect] (→299)	• [Restore to Default]

*Function button settings at the time of purchase.

ZS100 Changing the settings assigned to the control ring/rear dial

Recording mode:

Changes the settings assigned to the control ring/rear dial.

1 Set the menu

MENU → [Custom] → [Ring/Dial Set]

2 Use to select [] (control ring) or [] (rear dial) and press [MENU/SET]

3 Use to select the setting and press [MENU/SET]

[DEFLT] [Normal]	[Photo Style] (→129)
[Zoom]* (→236)	[Filter Effect] (→131)
[Step Zoom]* (→239)	[Aspect Ratio] (→139)
[Exposure Comp.] (→177)	[Highlight Shadow] (→133)
[Sensitivity] (→179)	[i.Dynamic] (→142)
[White Balance] (→134)	[i.Resolution] (→142)
[AF Mode] (→149)	[Flash] (→243)
[Focus Mode] (→146, 165, 167)	[Flash Adjust.] (→250)
[Drive Mode] (→201)	[OFF] [Not Set]*

* Items that can only be set to the control ring

- To return to the default setting, select [Normal].
- If you do not use the control ring, select [Not Set].
- Under [Highlight Shadow], use the control ring and rear dial.
If [Highlight Shadow] is assigned to the control ring (or rear dial), [Highlight Shadow] will also be assigned to the rear dial (or control ring).

- The assigned function setting applies to all the recording modes.
However, the assigned function may not operate when combined with certain recording mode.

ZS60 Changing the settings assigned to the control ring/control dial

Recording mode: **PAS**

Changes the settings assigned to the control ring/control dial.

1 Set the menu

MENU → [Custom] → [Ring/Dial Set]

2 Use ▲▼ to select [] (control ring) or [] (control dial) and press [MENU/SET]

3 Use ▲▼ to select the setting and press [MENU/SET]

[DEFLT] [Normal]	[Drive Mode] (→201)
[Zoom]* (→236)	[Photo Style] (→129)
[Step Zoom]* (→239)	[Filter Effect] (→131)
[Exposure Comp.] (→177)	[Aspect Ratio] (→139)
[Sensitivity] (→179)	[i.Dynamic] (→142)
[White Balance] (→134)	[i.Resolution] (→142)
[AF Mode] (→149)	[Flash Mode] (→244)
[Focus Mode] (→146, 165, 167)	[Flash Adjust.] (→250)
	[OFF] [Not Set]*

* Items that can only be set to the control ring

- To return to the default setting, select [Normal].
- If you do not use the control ring, select [Not Set].

- The assigned function setting applies to all the recording modes. However, the assigned function may not operate when combined with certain recording mode.

Using the [Setup] menu

[Clock Set] and [Economy] are important for clock setting and battery life. Please check these before use.

For details on how to select the [Setup] menu settings, refer to (→65).

[Online Manual]

Settings: [URL display] / [QR Code display]

[Clock Set]

Set time, date, and display format. (→42)

[World Time]

Set the recording date and time with the local time at your destination.

- You can set [Destination] after setting [Home].

Settings: [Destination] / [Home]

1 Use ▲ ▼ to select [Destination] or [Home] and press [MENU/SET]

2 Use ◀ ▶ to select area and press [MENU/SET]



■ To set daylight savings

Press ▲ in step 2. (Press again to release the setting)

- When daylight savings [☀] is set, the current time is advanced by 1 hour. If the setting is canceled, the time automatically returns to the current time.

■ When you come back from your travel destination

Select [Home] in step 1 and press [MENU/SET].

- If you cannot find your destination in the area displayed on the screen, set based on difference with home time.

For details on how to select the [Setup] menu settings, refer to (→65).

[Travel Date]

If you set your travel schedule and record pictures, the day of your trip on which the picture was taken will be recorded.

■ [Travel Setup]

Settings: [SET] / [OFF]

- 1 Use ▲ ▼ to select [Travel Setup] and press [MENU/SET]
- 2 Use ▲ ▼ to select [SET] and press [MENU/SET]
- 3 Use ▲ ▼ ◀ ▶ to select the departure date and press [MENU/SET]
- 4 Use ▲ ▼ ◀ ▶ to select the return date and press [MENU/SET]

■ To record [Location]

Once the [Travel Setup] is set, you can set the location.

- ① Select [Location] in step 1 above, and press [MENU/SET]
- ② Use ▲ ▼ to select [SET] and press [MENU/SET]
- ③ Enter your location (Entering text (→87))

- To print [Location] or the number of days that have passed, either use [Text Stamp] (→291) or print using the "PHOTOfunSTUDIO" software (→353).
- The travel date is calculated from the set departure date and the date set in the camera's clock. When destination is set in [World Time], days elapsed are calculated based on local destination time.
- When [Travel Setup] is set to [OFF], the number of days elapsed is not recorded. It is not displayed even if [Travel Setup] is set to [SET] after recording.
- When the current date passes the return date, [Travel Setup] is automatically canceled.
- [Travel Date] cannot be recorded for AVCHD motion pictures.
- [Location] cannot be recorded while recording motion pictures, recording 4K photos, or recording in [Post Focus].

[Wi-Fi]

Settings: [Wi-Fi Function] / [Wi-Fi Setup]

Configure the settings required for the Wi-Fi function. (→303, 344)

For details on how to select the [Setup] menu settings, refer to (→65).

[Beep]

Sets the beep sounds or shutter sounds.

■ [Beep Volume]

Settings: (High) / (Low) / (Off)

■ [Shutter Vol.]

Settings: (High) / (Low) / (Off)

■ [Shutter Tone]

Settings: ① / ② / ③

- When [Silent Mode] is set to [ON], [Beep Volume] and [Shutter Vol.] are set to "Off".

[Live View Mode]

Sets the display speed and picture quality of the screen (Live View screen) when recording pictures.

Settings

[30fps]	Pictures are displayed at 30 fps. For example, use when you want to record a comparatively slow-moving subject while confirming the focusing. Minimizes power consumption and the operating time is extended.
[60fps]	Display speed has higher priority over picture quality and pictures are displayed at 60 fps. For example, use when you want to record a fast-moving subject.





- The [Live View Mode] setting does not affect the recorded picture.
- The display speed may slow down in dark locations.
- When the AC adaptor (optional) and DC coupler (optional) are used, [Live View Mode] is fixed to [60fps].
- **ZS100**
[Live View Mode] is disabled while the HDMI output is being used for recording.

For details on how to select the [Setup] menu settings, refer to (→65).

[Monitor Display] / [Viewfinder]

Adjust brightness and color of the monitor or viewfinder.

Settings

 [Brightness]	Adjusts the brightness.
 [Contrast]	Adjusts the contrast.
 [Saturation]	Adjusts the vividness of colors.
 [Red Tint]	Adjusts red hues.
 [Blue Tint]	Adjusts blue hues.

1 Press ▲▼ to select the setting item and press ◀▶ to make adjustments

- **ZS100**
You can also make adjustments with the rear dial.
- **ZS60**
You can also make adjustments with the control dial.

2 Press [MENU/SET]





- It will adjust the monitor when the monitor is in use, and the viewfinder when the viewfinder is in use.
- Some subjects may look different from their actual appearance, but the recorded picture will not be affected.





For details on how to select the [Setup] menu settings, refer to (→65).

[Monitor Luminance]

Sets the monitor brightness according to the ambient light level.

Settings

	The brightness is adjusted automatically depending on how bright it is around the camera.
	The brightness is increased.
	The brightness is standard.
	The brightness is decreased.

- Some subjects may look different from their actual appearance, but the recorded picture will not be affected.
- [] returns to ordinary brightness if there is no operation for 30 seconds when recording. (Press any button or touch the screen to make the screen brighter again.)
- Setting [] or [] reduces the operating time.
- Cannot select [] during playback.
- When the AC adaptor (optional) and DC coupler (optional) are used, the initial setting is [].



For details on how to select the [Setup] menu settings, refer to (→65).

[Economy]

Turn off the camera or make the monitor go dark while not using the camera or if no operation is performed for a preset period of time to minimize battery consumption.

■ **ZS100** [Sleep Mode]

The camera is automatically turned off if the camera has not been used for the time selected on the setting.

Settings: [10MIN.] / [5 MIN.] / [2 MIN.] / [1 MIN.] / [OFF]

- To restore → Press the shutter button halfway, or turn the camera [ON/OFF] switch to [OFF] and then turn it [ON] again

■ **ZS60** [Auto Power Off]

The camera is automatically turned off if the camera has not been used for the time selected on the setting.

Settings: [10MIN.] / [5 MIN.] / [2 MIN.] / [1 MIN.] / [OFF]

- To restore → Press the Camera [ON/OFF] button

■ [Auto LVF/Monitor Off]

The monitor is automatically turned off if the camera has not been used for the time selected on the setting.

Settings: [5 MIN.] / [2 MIN.] / [1 MIN.]

- To restore → Press any button or touch the monitor.

● This function is not available in the following cases:



- During motion picture recording/playback
- When recording with [4K] ([4K Pre-Burst]) of the 4K Photo function
- **ZS100** When [Multi Exp.] is set
- When connected to computer/printer
- During Slide Shows
- When using [Time Lapse Shot]
- When [Auto Shooting] of [Stop Motion Animation] is set to [ON]
- **ZS100** While the HDMI output is being used for recording
- **ZS100**
When using the AC adaptor (optional) and DC coupler (optional), the [Sleep Mode] is disabled.
- **ZS60**
When using the AC adaptor (optional) and DC coupler (optional), the [Auto Power Off] is disabled.
- When using the AC adaptor (optional) and DC coupler (optional), [Auto LVF/Monitor Off] is fixed to [5 MIN.].

For details on how to select the [Setup] menu settings, refer to (→65).

[USB Mode]

Select communication method for when connecting camera to a computer or printer with USB connection cable (supplied).

Settings

 [Select on connection]	Select communication method each time you connect to a computer or PictBridge-compatible printer.
 [PictBridge(PTP)]	Select when connecting to a PictBridge-compatible printer.
 [PC]	Select when connecting to a computer.

[TV Connection]

Change the settings to be used when the camera is connected to a TV or other device.

■ [HDMI Mode (Play)]

Set the format for the HDMI output when playing back on the HDMI compatible high-definition TV connected with this unit using the HDMI micro cable.

Settings

[AUTO]	Automatically sets the output resolution based on information from a connected TV.
[4K]	Outputs pictures with a resolution of 3840×2160 pixels using a progressive scan method for the number of effective scanning lines (2,160 lines).
[1080p]	Outputs pictures using a progressive scan method for the number of effective scanning lines (1,080 lines).
[1080i]	Outputs pictures using an interlace scan method for the number of effective scanning lines (1,080 lines).
[720p]	Outputs pictures using a progressive scan method for the number of effective scanning lines (720 lines).
[480p]	Outputs pictures using a progressive scan method for the number of effective scanning lines (480 lines).

- If no image appears on the TV with [AUTO], switch the setting to a constant setting other than [AUTO] to set a format supported by your TV. (Please read the operating instructions for the TV.)

For details on how to select the [Setup] menu settings, refer to (→65).

[TV Connection] (continued)

■ ZS100 [HDMI Info Display (Rec)]

Set whether or not to display information when recording a picture on the camera while monitoring it on a TV, etc., connected to the camera via an HDMI micro cable.

Settings

[ON]	The camera display is output as is.
[OFF]	Only images are output.

■ [VIERA Link]

Enable automatic linking with other VIERA Link-compatible devices, and operability with a VIERA remote control when connecting via an HDMI micro cable. (→350)

Settings

[ON]	Operations may be performed via the remote control of the VIERA Link-compatible device. <ul style="list-style-type: none"> • Not all operations will be available. • Operability of the camera's own buttons will be limited.
[OFF]	Operations must be performed via the camera's own buttons.

For details on how to select the [Setup] menu settings, refer to (→65).

[m/ft]

Select how distance is displayed, in Ft or M.

Settings: [m] / [ft.]

[Menu Resume]

Save the last operated menu position.

Settings: [ON] / [OFF]

[Menu Background]

Set the background color for the menu screen.

[Menu Information]

Explanations of the menu items and settings are displayed on the menu screen.

Settings: [ON] / [OFF]

[Language]

Change display language.

Set the language displayed on the screen.

- If you set a different language by mistake, select [↺] from the menu icons to set the desired language.

For details on how to select the [Setup] menu settings, refer to (→65).

[Version Disp.]

Check the firmware version of the camera.

- When you press [MENU/SET] while the version is displayed, software information for this unit, such as the license, is displayed.

[Exposure Comp. Reset]

If the recording mode is changed or the camera is turned off, the exposure compensation (brightness) setting is reset.

Settings: [ON] / [OFF]

[Self Timer Auto Off]

The self-timer is canceled if the unit is turned off.

Settings: [ON] / [OFF]

[No.Reset]

Reset picture file numbers. (The folder number is updated and the file number starts from 0001.)

- To reset folder number to 100:
First, format the card, and reset the file numbers using [No.Reset]. Then, select [Yes] on the folder number reset screen.
- A folder number between 100 and 999 can be assigned.
Numbers cannot be reset once folder number reaches 999. In this case, save all necessary pictures to your computer, and format the card (→38).

For details on how to select the [Setup] menu settings, refer to (→65):

[Reset]

The following settings are reset to the default:

- Recording settings (except for [Face Recog.] and [Profile Setup] settings) and drive mode
- Recording settings ([Face Recog.] and [Profile Setup] settings)
- Setup/custom settings

- When the setup/custom settings are reset, the following settings are also reset:
 - The [World Time] setting
 - The [Travel Date] setting (Departure date, Return date, [Location])
 - The settings of [Rotate Disp.] and [Picture Sort] in the [Playback] menu
- Folder numbers and clock settings will not be reset.

[Reset Wi-Fi Settings]

Returns [Wi-Fi] settings to default settings.
(Excluding [LUMIX CLUB])

[Demo Mode]

You can try focusing, peaking, etc. in [Post Focus], with the image picture.

[Format]

Format (initialize) a memory card. (→38)

Entering Text

Use the cursor button to enter names with the Face Recognition function and in [Profile Setup] (babies and pets), or to register locations in [Travel Date] etc.

- Example of operation for displaying a screen:

MENU → [Rec] → [Profile Setup] → [SET] → [Baby1] → [Name] → [SET]

1 Use ▲▼◀▶ to select characters

2 Press [MENU/SET] several times until the desired character is displayed

- []: Enter a blank.

■ To change the character type

- Press [DISP.] button
- Use ▲▼◀▶ to select [] and press [MENU/SET]

■ To continue entering characters

- Use ▲▼◀▶ to select [] and press [MENU/SET]
- Move the zoom lever toward T side
- **ZS100**
Rotate the rear dial counterclockwise.
- **ZS60**
Rotate the control dial clockwise.

■ To edit text

- ① Use ▲▼◀▶ to select [] [] and press [MENU/SET]. Then, move the cursor to the text to edit
 - **ZS100**
You can also use the zoom lever or rear dial to reposition the cursor.
 - **ZS60**
You can also use the zoom lever or control dial to reposition the cursor.
- ② Use ▲▼◀▶ to select [Delete] and press [MENU/SET]
- ③ Use ▲▼◀▶ to select the correct text, and press [MENU/SET]

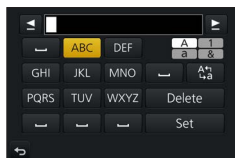

3 When you are finished entering text, use ▲▼◀▶ to select [Set] and press [MENU/SET]

- Only alphabetical characters and symbols can be entered.
- A maximum of 30 characters can be entered (maximum of 9 characters when setting names in [Face Recog.]).
- A maximum of 15 characters can be entered for [\], [[], []], [•] and [-] (maximum of 6 characters when setting names in [Face Recog.]).



Taking pictures with automatic settings

(Intelligent Auto Mode)

Recording mode:  

This mode is recommended for those who want to point and shoot as the camera optimizes settings to match the subject and recording environment.

(○: Available, -: Not available)

	 Intelligent Auto Plus Mode	 Intelligent Auto Mode
Defocus control function	○	○
Setting the brightness (exposure)	○	-
Setting the color tone	○	-
Menus that can be set	(→96)	

1 Set mode dial to []

- The camera will switch to either the most recently used of Intelligent Auto Mode or Intelligent Auto Plus Mode. (→95)

Following are the settings in effect at time of purchase.

: Intelligent Auto Plus Mode

: Intelligent Auto Mode

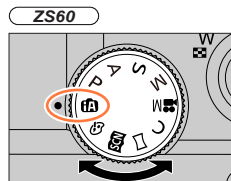
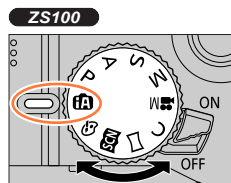

2 Point the camera at the subject

- When the camera identifies the optimal scene, the icon for each scene turns blue for 2 seconds and then changes to the normal red indication. (Automatic Scene Detection)



Taking pictures with automatic settings (Intelligent Auto Mode)

Auto Focus, Face/Eye Detection, and Face Recognition

[AF Mode] is automatically set to [i:👤]. If you touch the subject, the camera switches to [i:👁️] and the AF tracking function starts operating.

You can also switch to [i:👁️] by pressing [MENU/SET], going to the [Rec] menu, then going to the [AF Mode] menu and selecting [i:👁️] (tracking). Align the AF tracking area with the subject and press the shutter button halfway to operate the AF tracking function.

For details about AF tracking, refer to (→151).

- In [i:👁️], [i:👤], and [i:👁️], the camera adjusts the focus on the eye that is closest to this unit and matches the exposure with the face. In Intelligent Auto Plus Mode or Intelligent Auto Mode, the eye to be focused on cannot be changed. **(Face/Eye Detection)**
- Automatic Scene Detection does not function until the focus is locked on a subject during AF Tracking.
- When [Face Recog.] (→226) is set to [ON] and if the camera recognizes a face similar to a registered face, [R] is displayed on the upper right corner of the [i:👁️], [i:👤], and [i:👁️] icons.

Taking pictures with automatic settings (Intelligent Auto Mode)

Flash

ZS100

When the flash is open, the camera automatically sets [iA], [iA], [iA] (Auto/Red-Eye Reduction), [iA], or [iA] based on the type of subject and brightness.

ZS60

When **▶** is pressed and [iA] (i auto) selected, the camera will automatically be set to [iA], [iA] (Auto/Red-Eye Reduction), [iA], or [iA], depending on the type of subject and brightness.

- When [iA] or [iA] is displayed, the [Red-Eye Removal] function is activated to automatically detect red-eye and correct the picture data.
- When [iA] or [iA] is selected, the shutter speed is reduced.

Automatic Scene Detection

When taking pictures

[i-Portrait]	[i-Scenery]	[i-Macro]	[i-Night Portrait]*1
[i-Night Scenery]	[i-Handheld Night Shot]*2	[i-Food]	[i-Baby]*3
[i-Sunset]	When scene does not correspond to any of the above		

*1 Displayed only when using flash.

*2 When [iHandheld Night Shot] is [ON]. (→91)

*3 When children (that are registered in the camera with Face Recognition) under 3 years old are recognized.

- When the camera identifies [iA] as the optimal scene and if the camera determines that jitter is reduced by the use of a tripod or by other means, a shutter speed that is slower than usual is selected. After pressing the shutter button, do not move the camera while recording.
- When recording 4K photos or when recording using [Post Focus], Scene Detection works the same way as when recording motion pictures.

When recording motion pictures

[i-Portrait]	[i-Scenery]	[i-Low Light]	[i-Macro]
When scene does not correspond to any of the above			

- Depending on recording conditions, different scene types may be determined for the same subject.

Taking pictures with automatic settings (Intelligent Auto Mode)

**About Backlight Compensation**

Backlight compensation is automatically activated in Intelligent Auto Plus Mode or Intelligent Auto Mode. Backlight is a condition where a light shines from behind a subject. When there is a backlight, the subject appears darker and the camera will automatically attempt to correct it by increasing the brightness of the picture.

Taking pictures using a handheld camera ([iHandheld Night Shot])

Recording mode:

If a night scene is detected automatically while the unit is being handheld, [iHandheld Night Shot] can record a still picture with less jitter and less noise without using a tripod by combining a burst of pictures.

MENU → **[Rec]** → **[iHandheld Night Shot]** → **[ON]** / **[OFF]**

- The angle of view becomes narrow slightly.
- After the shutter button has been pressed, do not move the camera during the burst operation.
- When the camera is fixed in place on a tripod or by other means, will not be identified.
- The flash is fixed to the (Forced Flash Off) setting.
- This function will not work for still pictures while motion pictures are being recorded.
- This function is not available in the following cases:
 - When using [Burst]
 - When recording 4K photos
 - When using [Auto Bracket]
 - When recording using [Post Focus]
 - When [Quality] is set to [RAW], [RAW] or [RAW]
 - When using [Time Lapse Shot]
 - When [Auto Shooting] of [Stop Motion Animation] is set to [ON]



Taking pictures with automatic settings (Intelligent Auto Mode)



Combining pictures into a single still picture with rich gradation ([iHDR])

Recording mode:  

When there is, for example, strong contrast between the background and the subject, [iHDR] records multiple still pictures with differing exposures and combines them to create a single still picture rich in gradation.

[iHDR] is activated when required. When activated, [HDR] will be displayed on the screen.

MENU →  **[Rec]** → **[iHDR]** → **[ON]** / **[OFF]**

- The angle of view becomes narrow slightly.
- After the shutter button has been pressed, do not move the camera during the burst operation.
- Since a burst of still pictures are combined after they have been recorded, it will be a few moments before you can record another picture.
- In the case of composition from a burst, afterimages may appear if the subject was moving.
- This function will not work for still pictures while motion pictures are being recorded.
- This function is not available in the following cases:
 - When recording using the flash
 - When using [Burst]
 - When recording 4K photos
 - When using [Auto Bracket]
 - When recording using [Post Focus]
 - When [Quality] is set to [RAW , [RAW ] or [RAW]
 - When using [Time Lapse Shot]
 - When [Auto Shooting] of [Stop Motion Animation] is set to [ON]



Taking pictures with automatic settings (Intelligent Auto Mode)

Defocusing the background (Defocus control function)

Recording mode:  

You can easily set the blurriness of the background while checking the screen.

1 Press  to display the setting screen

- When in Intelligent Auto Plus mode, each press of  switches between brightness (exposure) setting operation ([→94](#)), blur control operation, and operation finish.
- When in Intelligent Auto mode, each press of  switches between blur control operation and operation finish.

2  Rotate the rear dial to adjust the background defocusing condition

Rotate the control dial to adjust the background defocusing condition



Strong defocusing

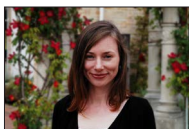



Slight defocusing





- Press [MENU/SET] to return to the recording screen.

■ With touch screen operations

- ① Touch 
- ② Touch  to display the setting screen
- ③ Drag the exposure meter to set the blurriness
 - Press [MENU/SET] to return to the recording screen.



- Pressing [Q.MENU/⏪] button on the blurriness setting screen will cancel the setting.
- In Intelligent Auto Mode ( or ), Auto Focus Mode is set to . The position of the AF area can be set by touching the screen. (Its size cannot be changed)





Taking pictures with automatic settings (Intelligent Auto Mode)

Recording images by changing the brightness (exposure) or color tone

Recording mode: 

Setting brightness (exposure)

1 Press  button

- Each press of  switches between brightness (exposure) setting operation, blur control operation (93), and operation finish.

2 

Rotate the rear dial to adjust brightness (exposure)



Rotate the control dial to adjust brightness (exposure)



Setting coloring

1 Press  to display the setting screenPress  to display the setting screen2 

Rotate the rear dial to adjust color





Rotate the control dial to adjust color

- Press [MENU/SET] to return to the recording screen.



With touch screen operations

- Touch 
- Touch the item you want to set
 - : Coloring
 - : Brightness (exposure)
- Drag the slide bar to set
 - Press [MENU/SET] to return to the recording screen.



Taking pictures with automatic settings (Intelligent Auto Mode)

- When [Exposure Comp. Reset] is set to [ON], the set brightness returns to standard (midpoint) if the camera is turned off or the camera is changed to another recording mode. (→85)
- The color setting will return to the default level (center point) when this unit is turned off or the camera is switched to another Recording mode.

About Intelligent Auto Plus Mode and Intelligent Auto Mode

Switching between Intelligent Auto Plus Mode and Intelligent Auto Mode

1 Press [MENU/SET]

2 Press ◀

3 Press ▲ ▼ to select the [iA+] or [iA] tab

- **ZS100**
Items can also be selected by rotating the rear dial.
- **ZS60**
Items can also be selected by rotating the control dial.

ZS100

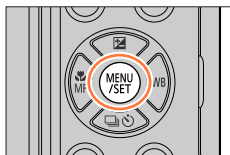

ZS60

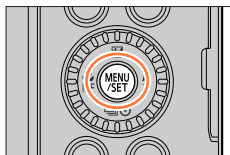

4 Use ▶ to select [iA+] or [iA] and press [MENU/SET]



It is also possible to display the selection screen by touching the Recording mode icon in recording screen.



Taking pictures with automatic settings (Intelligent Auto Mode)

Available menus

You can set only the following menus.

IA Intelligent Auto Plus Mode	
Menu	Item
[Rec]	[Photo Style], [Aspect Ratio], [Picture Size], [Quality], [AF Mode], [AFS/AFF/AFC], [Burst Rate], [4K PHOTO], [Auto Bracket], [Self Timer], [Post Focus], [iHandheld Night Shot], [iHDR], [Time Lapse Shot], [Stop Motion Animation], [Shutter Type], [Color Space]*, [Stabilizer], [Face Recog.], [Profile Setup]
[Motion Picture]	[Photo Style], [Snap Movie], [Rec Format], [Rec Quality], [AF Mode], [AFS/AFF/AFC], [Continuous AF], [Wind Noise Canceller], [Zoom Mic]
[Custom]	[Silent Mode], [Half Press Release], [Pinpoint AF Time]*, [Pinpoint AF Display]*, [Focus/Release Priority], [AF+MF], [MF Assist], [MF Assist Display], [MF Guide], [Peaking], [Histogram], [Guide Line], [Highlight], [Zebra Pattern], [Monochrome Live View], [Constant Preview]*, [Dial Guide], [LVF Disp.Style], [Monitor Disp. Style], [Rec Area], [Remaining Disp.], [Auto Review], [Fn Button Set], [Zoom lever], [Zoom Resume], [Q.MENU]*, [Ring/Dial Set], [Eye Sensor], [Touch Settings], [Touch Scroll], [Menu Guide]
[Setup]	All menu items can be set. (→76)

* ZS100

IA Intelligent Auto Mode	
Menu	Item
[Rec]	[Aspect Ratio], [Picture Size], [AF Mode], [AFS/AFF/AFC], [Burst Rate], [4K PHOTO], [Self Timer], [Post Focus], [iHandheld Night Shot], [iHDR], [Time Lapse Shot], [Stop Motion Animation], [Face Recog.]
[Motion Picture]	[Snap Movie], [Rec Format], [Rec Quality], [AFS/AFF/AFC]
[Custom]	[Silent Mode], [Guide Line], [Remaining Disp.]
[Setup]	All menu items can be set. (→76)

Taking pictures after automatically setting the aperture value and shutter speed (Program AE Mode)

Recording mode: **P**

Take pictures using automatic aperture values and shutter speed settings in accordance with the brightness of a subject.

1 Set mode dial to [P]

2 Press the shutter button halfway

- If the aperture value and shutter speed flash red, you do not have the correct exposure.

3 **ZS100** While the numeric values are displayed (approximately 10 seconds), rotate the rear dial to change the values using Program Shift

- The operation can also be performed by rotating the control ring. (→50)
- To cancel Program Shift, either turn off the camera or rotate the rear dial until the Program Shift indication turns off.



Shutter speed
Aperture value
Program Shift indication

ZS60 While the numeric values are displayed (approximately 10 seconds), rotate the control dial to change the values using Program Shift

- The operation can also be performed by rotating the control ring. (→51)
- To cancel Program Shift, either turn off the camera or rotate the control dial until the Program Shift indication turns off.
- Program Shift can easily be canceled by setting a function button to [One Push AE]. (→108)

Taking pictures after automatically setting the aperture value and shutter speed (Program AE Mode)

- ZS100**
 The camera automatically removes noise when [Long Shtr NR] is set to [ON] and the shutter speed is slow. Therefore, [Long shutter noise reduction ongoing] may be displayed. (→144)
 Although noise reduction requires the same time as the shutter speed for signal processing, you can take sharp pictures.
- ZS60**
 The camera automatically removes noise when the shutter speed is slow. Therefore, [Long shutter noise reduction ongoing] may be displayed.
 Although noise reduction requires the same time as the shutter speed for signal processing, you can take sharp pictures.

Enabling/disabling the exposure meter display

MENU → **fC [Custom]** → **[Expo.Meter]** → **[ON] / [OFF]**

- When you set this function to [ON], an exposure meter is displayed during Program Shift, aperture setting, and shutter speed operation.
- Proper exposure is not possible in the range indicated in red.
- If the exposure meter is not displayed, press the [DISP.] button to switch the display of the monitor. (→53)
- The exposure meter will turn off if no operation is performed for approximately 4 seconds.

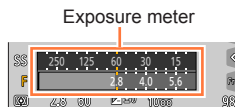

Taking pictures after automatically setting the aperture value and shutter speed (Program AE Mode)

About Program Shift

The function for maintaining the same exposure (brightness) while changing the shutter speed and aperture value combination is called "Program Shift". You can use "Program Shift" to take pictures by adjusting the shutter speed and aperture value even in Program AE Mode.

<Example of Program Shift>

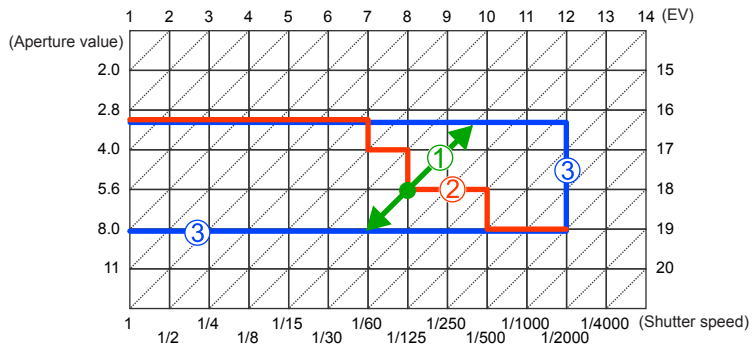

① Program Shift amount

Represents the aperture and shutter speed set automatically by the camera at each exposure value.

② Program Shift diagram

Represents the range of the aperture and shutter speed combination you can change with Program Shift at each exposure value.

③ Program Shift limit

Represents the range of the aperture and shutter speed you can select when you use Program Shift with the camera.

● Program Shift cannot be used in the following cases:

- When recording 4K photos
- When recording using [Post Focus]
- When ISO sensitivity is set to [i]ISO

Taking pictures by setting the aperture value and shutter speed

Recording mode: **ASM**

- The effect of the aperture value and shutter speed you have set is not applied to the recording screen. To check the effect on the recording screen, use Preview Mode. ([→106](#))
- The brightness of the screen may vary from the actual pictures recorded. Check the brightness of pictures using the playback screen.
- **ZS100**
The camera automatically removes noise when [Long Shtr NR] is set to [ON] and the shutter speed is slow. Therefore, [Long shutter noise reduction ongoing] may be displayed. ([→144](#))
Although noise reduction requires the same time as the shutter speed for signal processing, you can take sharp pictures.
- **ZS60**
The camera automatically removes noise when the shutter speed is slow. Therefore, [Long shutter noise reduction ongoing] may be displayed.
Although noise reduction requires the same time as the shutter speed for signal processing, you can take sharp pictures.



Taking pictures by setting the aperture value and shutter speed

Taking pictures by setting the aperture value (Aperture-Priority AE Mode)

When the aperture value is increased, the range of depth in focus expands, and the picture shows up clearly from the position of the camera to the background. When the aperture value is reduced, the range of depth in focus shrinks, and the background can get blurry.

1 Set mode dial to [A]

2 **ZS100**

Rotate the rear dial to set the aperture value

- The operation can also be performed by rotating the control ring. (→50)
- When you rotate the control ring or rear dial, an exposure meter is displayed. If the correct exposure is not achieved, the numeric values of the aperture are shown in red.

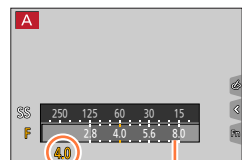

Aperture values that can be set*1	Shutter speed set (seconds)
F2.8 - F8.0	60 - 1/2000 (When the mechanical shutter is used) 1 - 1/16000 (When the electronic shutter is used)

*1 You may not be able to select some values depending on zoom position.

ZS60

Rotate the control dial to set the aperture value

- The operation can also be performed by rotating the control ring. (→51)
- When you rotate the control ring or control dial, an exposure meter is displayed. If the correct exposure is not achieved, the numeric values of the aperture are shown in red.

Aperture values that can be set*1	Shutter speed set (seconds)
F3.3 - F8.0	4*2 - 1/2000 (When the mechanical shutter is used) 1*2 - 1/16000 (When the electronic shutter is used)

*1 You may not be able to select some values depending on zoom position.

*2 Varies depending on the setting of ISO sensitivity.

- If the correct exposure is not achieved when you press the shutter button halfway, the numeric values of the aperture and shutter speed are displayed in flashing red.



Taking pictures by setting the aperture value and shutter speed

Taking pictures by setting the shutter speed (Shutter-Priority AE Mode)

When you increase the shutter speed, you can reduce jitter when recording a subject. When you decrease the shutter speed, the subject's movement is shown.

1 Set mode dial to [S]

2 **ZS100** Rotate the rear dial to set the shutter speed

- The operation can also be performed by rotating the control ring. (→50)
- When you rotate the control ring or rear dial, an exposure meter is displayed. If the correct exposure is not achieved, the numeric values of the aperture are shown in red.

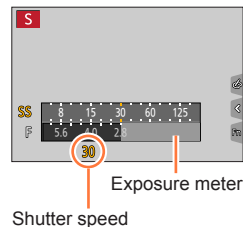

Shutter speeds that can be set (seconds)	Aperture value set
60 - 1/2000 (When the mechanical shutter is used)	F2.8 - F8.0
1 - 1/16000 (When the electronic shutter is used)	

ZS60

Rotate the control dial to set the shutter speed

- The operation can also be performed by rotating the control ring. (→51)
- When you rotate the control ring or control dial, an exposure meter is displayed. If the correct exposure is not achieved, the numeric values of the aperture are shown in red.

Shutter speeds that can be set (seconds)	Aperture value set
4* - 1/2000 (When the mechanical shutter is used)	F3.3 - F8.0
1* - 1/16000 (When the electronic shutter is used)	

* Varies depending on the setting of ISO sensitivity.

- If the correct exposure is not achieved when you press the shutter button halfway, the numeric values of the aperture and shutter speed are displayed in flashing red.
- If you switch the recording mode to Shutter-Priority AE Mode when ISO sensitivity is set to [ISO], ISO sensitivity will change to [AUTO].
- We recommend using a tripod or self-timer when the shutter speed is slow.

Taking pictures by setting the aperture value and shutter speed

Taking pictures by setting the aperture value and shutter speed (Manual Exposure Mode)

Determine the exposure by manually setting the aperture value and the shutter speed.

1 Set mode dial to [M]

2 ZS100

Rotate the rear dial to set the shutter speed and the aperture value

- You can switch between the shutter speed setting operation and the aperture value setting operation each time ▲ is pressed.
- You can also set the aperture value with the control ring and the shutter speed with the rear dial. You can switch the setting operation of control ring and rear dial by pressing ▲.

Aperture values that can be set*1	Shutter speeds that can be set (seconds)
F2.8 - F8.0	T (Time), 60 - 1/2000 (When the mechanical shutter is used) 1 - 1/16000 (When the electronic shutter is used)

*1 You may not be able to select some values depending on zoom position.

ZS60

Rotate the control dial to set the shutter speed and the aperture value

- You can switch between the shutter speed setting operation and the aperture value setting operation each time ▲ is pressed.
- You can also set the aperture value with the control ring and the shutter speed with the control dial. You can switch the setting operation of control ring and control dial by pressing ▲.

Aperture values that can be set*1	Shutter speeds that can be set (seconds)
F3.3 - F8.0	4*2 - 1/2000 (When the mechanical shutter is used) 1*2 - 1/16000 (When the electronic shutter is used)

*1 You may not be able to select some values depending on zoom position.

*2 Varies depending on the setting of ISO sensitivity.

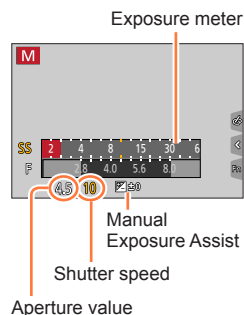

Taking pictures by setting the aperture value and shutter speed

- **ZS100**
When you rotate the control ring or rear dial, an exposure meter is displayed.
- **ZS60**
When you rotate the control ring or control dial, an exposure meter is displayed.
- If the correct exposure is not achieved when you press the shutter button halfway, the numeric values of the aperture and shutter speed are displayed in flashing red.
- If you switch the recording mode to Manual Exposure Mode when ISO sensitivity is set to [ISO], ISO sensitivity will change to [AUTO].
- We recommend using a tripod or self-timer when the shutter speed is slow.



Optimizing the ISO sensitivity for the shutter speed and aperture value

When the ISO sensitivity is set to [AUTO], the camera sets the ISO sensitivity automatically so that the exposure will be appropriate for the shutter speed and aperture value.

- Depending on recording conditions, an appropriate exposure may not be set or the ISO sensitivity may become higher.



Manual exposure assist (estimate)

	Shows pictures with standard brightness (appropriate exposure).
	Shows brighter pictures. For the appropriate exposure, either use a faster shutter speed or increase aperture value.
	Shows darker pictures. For the appropriate exposure, either use a slower shutter speed or reduce aperture value.



Taking pictures by setting the aperture value and shutter speed

ZS100 About [T] (Time)

If you set the shutter speed to [T], the shutter stays open when the shutter button is pressed fully. (Approximately up to 120 seconds)

The shutter closes if you press the shutter button again. Use this function when you want to keep the shutter open for an extended period, for example, to record pictures of fireworks or night scenes.

- When you take pictures with the shutter speed set to [T], use a sufficiently charged battery. (→25)
- Manual exposure assist is not displayed.
- When ISO sensitivity is set to [AUTO], ISO sensitivity will change to [125].
- You cannot use this function when the electronic shutter is used.



- When you take pictures with the shutter speed set to T (time), we recommend using remote recording (→312) with a tripod or smartphone as a remote shutter release, in order to prevent jitter.
- When you take still pictures with the shutter speed set to T (time), the pictures may have higher noise levels. If you want to suppress noise, we recommend taking pictures by setting [Long Shtr NR] to [ON] in the [Rec] menu. (→144)

**ZS100** Enabling/disabling the preview of the selected aperture value and shutter speed effects on the recording screen

MENU → **f/c** [Custom] → [Constant Preview] → [ON] / [OFF]

- This function is disabled when the flash is used. Close the flash.
- You can use this function only in Manual Exposure Mode.



Taking pictures by setting the aperture value and shutter speed

Checking the effects of the aperture value and shutter speed (Preview Mode)

Recording mode:

You can use Preview Mode to check the effects of the selected aperture value and shutter speed.

- **Checking the effect of the selected aperture value:** This enables you to check the depth of field (focus range) by physically narrowing the lens aperture blades to the aperture value used for the actual recording.
- **Checking the effect of the selected shutter speed:** This allows you to check motion in a scene by displaying the screen at the shutter speed used for the actual recording. When the shutter speed is increased, the screen is displayed like a frame dropping. Use this function to check the effect when you want to capture an image in a scene by stopping the motion, for example, when you take a picture of water flowing.

1 Assign [Preview] to the function button (→70)

- The following step is an example of assigning [Preview] to the [Fn3] button.

2 Press the [Fn3] button to switch the confirmation screen

- Every time you press the [Fn3] button, the screen switches.

Normal recording screen



Aperture effect preview screen
Effect of aperture value: ○
Effect of shutter speed: –



Shutter speed effect preview screen
Effect of aperture value: ○
Effect of shutter speed: ○

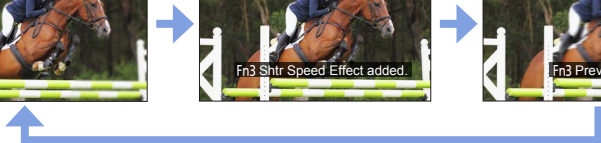
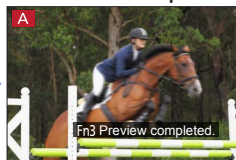

Taking pictures by setting the aperture value and shutter speed

**Depth of field characteristic**

Recording conditions	Aperture value	Small	Large
	Focal length	Telephoto	Wide-angle
	Distance to a subject	Close	Far
Depth of field (Focus range)		Shallow (narrow) Example: To take a picture by deliberately blurring the background	Deep (wide) Example: To take a picture by adjusting the focus while including the background

- You can take a picture even when Preview Mode is activated.
- The range in which you can check the effect of a selected shutter speed is between 8 seconds and 1/16000 seconds.
- This mode cannot be used with [📷] ([4K Pre-Burst]) of 4K Photo.



Taking pictures by setting the aperture value and shutter speed

Easily set aperture / shutter speed for suitable exposure (One Push AE)

Recording mode:

When the exposure setting is too bright or too dark, you can use one push AE to achieve a suitable exposure setting.



How to tell if the exposure is not adequate

- If the aperture values and shutter speed blink red when the shutter button is pressed halfway.
- If the Manual Exposure Assistance is anything other than [] when in Manual Exposure Mode. For details about the Manual Exposure Assistance, refer to (→104).

1 Assign [One Push AE] to the function button (→70)

2 (When exposure is not adequate) Press the function button

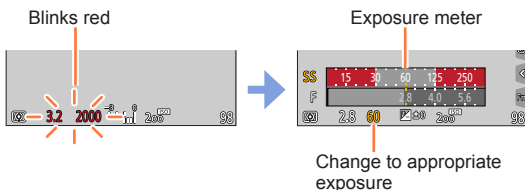

- The exposure meter is not displayed in Creative Control Mode.
- In the following cases, suitable exposure cannot be set.
 - When the subject is extremely dark and it is not possible to achieve adequate exposure by changing the aperture value or shutter speed
 - When recording using the flash
 - Preview Mode (→106)



Recording panorama pictures (Panorama Shot Mode)

Recording mode: 

Consecutive photos taken while the camera is moved are combined to form a panorama.

- 1** Set mode dial to 
- 2** Press the shutter button halfway to focus
- 3** Press the shutter button fully and pan the camera in a small circular motion to the recording direction to start recording

Taking pictures from left to right

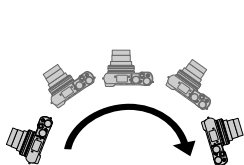

Image size: [STANDARD]

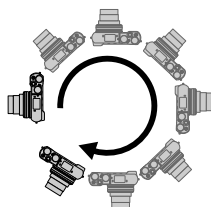

Image size: [WIDE]

Horizontal/vertical
guide line



Recording direction and
progress status (approximate)

- Pan the camera at a constant speed.
- You may not be able to take pictures successfully if you move the camera too quickly or too slowly.

- 4** Press the shutter button fully again to end recording
 - You can also end recording if you stop panning the camera while taking pictures.
 - Recording can also be ended by moving the camera to the end of the guide.



Recording panorama pictures (Panorama Shot Mode)

■ Changing the recording direction and angle of view (image size) of panorama pictures

MENU → **[Rec]** → **[Panorama Settings]**

[Direction]	Sets the recording direction. / / /
[Picture Size]	Sets the angle of view (image size). [STANDARD]: Gives priority to the image quality. [WIDE]: Gives priority to the angle of view. <ul style="list-style-type: none"> When the same angle of view is recorded, [STANDARD] results in a larger number of recording pixels.

- The number of recording pixels per horizontal line and vertical line of a panorama picture varies depending on the picture size, recording direction and number of stitched pictures. The maximum number of recording pixels is as follows:

Image size	Recording direction	Horizontal Resolution	Vertical Resolution
[STANDARD]	Horizontal	8176 pixels	1920 pixels
	Vertical	2560 pixels	7680 pixels
[WIDE]	Horizontal	8176 pixels	960 pixels
	Vertical	1280 pixels	7680 pixels



Tips

- Pan the camera in the recording direction as steadily as possible. (If the camera shakes too much, it may not be able to take pictures or may end up creating a narrow (small) panorama picture.)



Pan the camera to a point slightly ahead of the point that you want to take. (However, the last frame is not recorded to the end.)







Recording panorama pictures (Panorama Shot Mode)

About panorama picture playback

Pressing ▲ will start scrolling playback automatically in the same direction as the recording.

- The following operations can be performed during scrolling playback.

		Start panorama playback / Pause*
		Stop

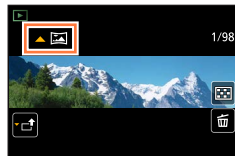

*When the playback is paused, you can scroll forwards and backwards by dragging the screen. When the scroll bar is touched, the playback position jumps to the touched position.

- The zoom position is fixed to the W end.
- The focus, exposure and White Balance are all fixed to optimal values for the first picture. If the focusing or brightness of pictures recorded as part of a panorama picture after the first picture are significantly different from those of the first picture, the panorama picture as a whole (when all pictures are stitched together) may not have consistent focus and brightness.
- Since several pictures are stitched together to create a panorama picture, some subjects may be distorted or the joining portions of successively taken pictures that are stitched may be noticeable. [Shutter Type] is fixed to [Electronic Shutter].
- Panorama pictures may not be created or pictures may not be recorded properly when taking pictures of the following subjects or when taking pictures in the following recording conditions:
 - Subjects that have a continuous monotone or pattern (sky, beach, etc.)
 - Moving subjects (person, pet, vehicle, waves, or flowers swaying in the wind, etc.)
 - Subjects whose colors or patterns change quickly (such as an image appearing on a display)
 - Dark locations
 - Locations with a flickering light source (fluorescent lamp, candle light, etc.)

Taking pictures according to the scene (Scene Guide Mode)

Recording mode: 

If you select a scene to suit the subject and recording conditions with reference to the example images, the camera will set optimal exposure, color, and focus, allowing you to record in a manner appropriate to the scene.

1 Set mode dial to **[SCN]**

2 Press **◀▶** to select the scene

- The scene can also be selected by dragging an example image or the slide bar.

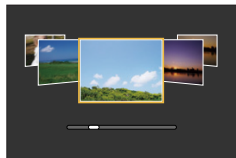

3 Press **[MENU/SET]**



- It is also possible to display the selection screen by touching the Recording mode icon in recording screen.
- Depending on the [Menu Guide] setting in the [Custom] menu, either the selection screen or the recording screen is displayed when the Mode Dial is switched. (→116)



Switching the scene selection screen display

Press the **[DISP.]** button to switch the display

- When it is set to the guide display, detailed explanations and tips for each scene are displayed.



Taking pictures according to the scene (Scene Guide Mode)

- In the following scene, the recording screen is displayed like a frame dropping with a slight delay compared to normal recording.
[Glistening Water], [Glittering Illuminations], [Soft Image of a Flower]
- To change the Scene Guide Mode, select the [SCN] tab on the menu screen, select [Scene Switch], and then press [MENU/SET]. You can return to step 2 on (→112).
- The following items cannot be set in Scene Guide Mode because the camera automatically adjusts them to the optimal setting.
 - Items other than the picture quality adjustment in [Photo Style], ISO sensitivity, [Metering Mode], [Highlight Shadow]*, [HDR] and [Multi Exp.]*
- **ZS100**
Although White Balance is fixed to [AWB] for certain types of scene, you can fine tune the White Balance or use White Balance bracketing by pressing the cursor button ► on the recording screen. (→137, 138)
- **ZS60**
Although White Balance is fixed to [AWB] for certain types of scenes, you can fine tune the White Balance or use White Balance bracketing by pressing [MENU/SET], going to the [Rec] menu, and selecting [White Balance]. (→137, 138)

For the setting procedures for the Scene Guide Mode, refer to (→112)

1: [Clear Portrait]

- The more the zoom is drawn towards T side and the closer the camera is brought to the subject, the greater the effect will be.

2: [Silky Skin]

- The more the zoom is drawn towards T side and the closer the camera is brought to the subject, the greater the effect will be.
- If a part of the background etc. is a color close to skin color, this part is also smoothed.
- This mode may not be effective when there is insufficient brightness.

3: [Backlit Softness]

4: [Clear in Backlight]

- **ZS100**
Open the flash.
- White saturation can occur if the subject is too close.
- Flash pictures taken closer or beyond the flash's rated distance may appear too bright or too dark.

Taking pictures according to the scene (Scene Guide Mode)

For the setting procedures for the Scene Guide Mode, refer to (→112)

5: [Relaxing Tone]**6: [Sweet Child's Face]**

- When you touch the face, a still picture is recorded with the focus and exposure set for the touched location.
- The more the zoom is drawn towards T side and the closer the camera is brought to the subject, the greater the effect will be.

7: [Distinct Scenery]**8: [Bright Blue Sky]****9: [Romantic Sunset Glow]****10: [Vivid Sunset Glow]****11: [Glistening Water]**

- Star filter used in this mode may cause glistening effects on the objects other than water surface.

12: [Clear Nightscape]

- Tripod, self-timer recommended.
- The shutter may remain closed after taking the picture. This is due to signal processing and is not a malfunction.
- Noise may become visible when you take pictures in dark places.

13: [Cool Night Sky]

- Tripod, self-timer recommended.
- The shutter may remain closed after taking the picture. This is due to signal processing and is not a malfunction.
- Noise may become visible when you take pictures in dark places.



Taking pictures according to the scene (Scene Guide Mode)

For the setting procedures for the Scene Guide Mode, refer to (→112)

14: [Warm Glowing Nightscape]

- Tripod, self-timer recommended.
- The shutter may remain closed after taking the picture. This is due to signal processing and is not a malfunction.
- Noise may become visible when you take pictures in dark places.

15: [Artistic Nightscape]

- Tripod, self-timer recommended.
- The shutter may remain closed after taking the picture. This is due to signal processing and is not a malfunction.
- Noise may become visible when you take pictures in dark places.

16: [Glittering Illuminations]

- Tripod, self-timer recommended.
- The shutter may remain closed after taking the picture. This is due to signal processing and is not a malfunction.
- Noise may become visible when you take pictures in dark places.

17: [Handheld Night Shot]

- After the shutter button has been pressed, do not move the camera during the burst operation.
- The angle of view becomes narrow slightly.

18: [Clear Night Portrait]

- **ZS100**
Open the flash.
- Tripod, self-timer recommended.
- When [Clear Night Portrait] is selected, keep the subject still for about 1 second after taking the picture.
- The shutter may remain closed after taking the picture. This is due to signal processing and is not a malfunction.
- Noise may become visible when you take pictures in dark places.

19: [Soft Image of a Flower]

- Tripod, self-timer recommended.
- For close-up recording, we recommend that you avoid using the flash.
- When a subject is close to the camera, the effective focus range is significantly narrowed. Therefore, if the distance between the camera and the subject is changed after focusing on the subject, it may become difficult to focus on it again.
- When you take pictures at close range, the resolution of the periphery of the picture may decrease slightly. This is not a malfunction.

Taking pictures according to the scene (Scene Guide Mode)

For the setting procedures for the Scene Guide Mode, refer to (→112)

20: [Appetizing Food]

- The more the zoom is drawn towards T side and the closer the camera is brought to the subject, the greater the effect will be.
- Tripod, self-timer recommended.
- For close-up recording, we recommend that you avoid using the flash.

21: [Cute Dessert]

- The more the zoom is drawn towards T side and the closer the camera is brought to the subject, the greater the effect will be.
- Tripod, self-timer recommended.
- For close-up recording, we recommend that you avoid using the flash.

22: [Freeze Animal Motion]

- Default [AF Assist Lamp] setting is [OFF]. (→164)

23: [Clear Sports Shot]

24: [Monochrome]



Displaying/not displaying the selection screen when the mode dial is switched to [SCN]/[

MENU →  [Custom] → [Menu Guide]

[ON]: Displays the selection screen.

[OFF]: Displays the recording screen of the currently selected mode.



Taking Pictures with different picture effects

(Creative Control Mode)

Recording mode: 

This mode records with additional picture effects. You can set the effects to be applied to a picture by selecting a sample picture and checking them simultaneously on the screen.

1 Set mode dial to 

2 Press **▲ ▼** to select the picture effect (filters)

- You can also select the picture effects (filters) by touching the example images.

Preview display

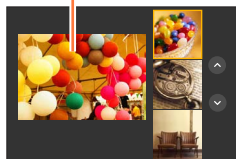

3 Press [MENU/SET]



- It is also possible to display the selection screen by touching the Recording mode icon in recording screen.
- Depending on the [Menu Guide] setting in the [Custom] menu, either the selection screen or the recording screen is displayed when the Mode Dial is switched. (→116)



■ Switching the display of a selection screen for applying picture effects (Filter)

Press the [DISP.] button to switch the display

- When it is set to the guide display, explanations for each picture effect are displayed.

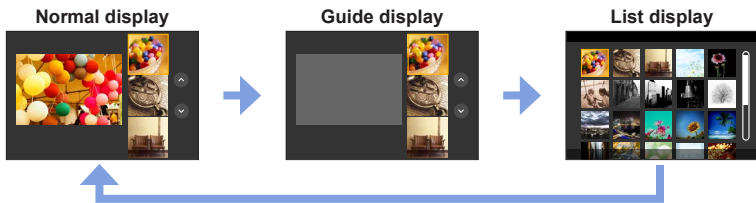

Taking Pictures with different picture effects (Creative Control Mode)

- In the following picture effect, the recording screen is displayed like a frame dropping with a slight delay compared to normal recording.
[Rough Monochrome], [Silky Monochrome], [Miniature Effect], [Soft Focus], [Star Filter], [Sunshine]
- [White Balance] will be fixed to [AWB] and ISO sensitivity to [AUTO].
- The following menu items can be set in the [⚙️] menu.
 - [Filter Effect]: Allows you to set the picture effect (filter). (→131)
 - [Simultaneous record w/o filter]: Allows you to set the camera to take a picture with and without an picture effect simultaneously. (→132)

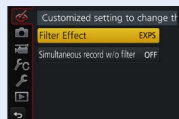

Adjusting the picture effects according to your preferences

You can easily adjust the setting conditions (such as degree and coloring of an effect) of the picture effects according to your preferences.

1 Press ► to display the setting screen

2 **ZS100**

Rotate the rear dial to adjust the setting conditions of the picture effects

ZS60

Rotate the control dial to adjust the setting conditions of the picture effects

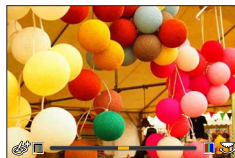





- The settings that can be adjusted vary depending on the selected picture effect.
- Press [MENU/SET] to return to the recording screen.
- When you select picture effects, [⚙️] appears on the screen.
- If you do not want to change the current setting, select the center point (standard) in the adjustment level bar.

Picture effect	Items that can be set
[Expressive]	Vividness Subdued coloring ◀️↔️▶️ Gaudy coloring
[Retro]	Coloring Yellowish coloring ◀️↔️▶️ Reddish coloring
[Old Days]	Contrast Low contrast ◀️↔️▶️ High contrast
[High Key]	Coloring Pinkish coloring ◀️↔️▶️ Light-bluish coloring
[Low Key]	Coloring Reddish coloring ◀️↔️▶️ Bluish coloring

Taking Pictures with different picture effects (Creative Control Mode)

Picture effect	Items that can be set
[Sepia]	Contrast Low contrast ↔ High contrast
[Monochrome]	Coloring Yellowish coloring ↔ Bluish coloring
[Dynamic Monochrome]	Contrast Low contrast ↔ High contrast
[Rough Monochrome]	Grainy picture effect Weak grainy picture effect ↔ Strong grainy picture effect
[Silky Monochrome]	Degree of defocusing Slight defocusing ↔ Strong defocusing
[Impressive Art]	Vividness Black & white ↔ Gaudy coloring
[High Dynamic]	Vividness Black & white ↔ Gaudy coloring
[Cross Process]	Coloring Greenish coloring / Bluish coloring / Yellowish coloring / Reddish coloring <ul style="list-style-type: none"> • ZS100 Select the desired color tone by rotating the rear dial, and press [MENU/SET]. • ZS60 Select the desired color tone by rotating the control dial, and press [MENU/SET]. 
[Toy Effect]	Coloring Orangish coloring ↔ Bluish coloring
[Toy Pop]	Range in which peripheral brightness is reduced Small ↔ Large
[Bleach Bypass]	Contrast Low contrast ↔ High contrast
[Miniature Effect]	Vividness Subdued coloring ↔ Gaudy coloring <ul style="list-style-type: none"> • For details about [Miniature Effect] (→122)
[Soft Focus]	Degree of defocusing Slight defocusing ↔ Strong defocusing
[Fantasy]	Vividness Subdued coloring ↔ Gaudy coloring

Taking Pictures with different picture effects (Creative Control Mode)

Picture effect	Items that can be set
[Star Filter]	<p>  Length of the rays of light Rays of light is short \longleftrightarrow Rays of light is long  Number of the rays of light Smaller \longleftrightarrow Larger  Angle of the rays of light Rotate to the left \longleftrightarrow Rotate to the right </p>
[One Point Color]	<p> Amount of color retained Leaves a small amount of color \longleftrightarrow Leaves a large amount of color • For details about [One Point Color] (→123) </p>
[Sunshine]	<p> Coloring Yellowish coloring / Reddish coloring / Bluish coloring / Whitish coloring </p> <ul style="list-style-type: none"> ZS100 Rotate the rear dial to select coloring, and press [MENU/SET]. ZS60 Rotate the control dial to select coloring, and press [MENU/SET]. <p> • For details about [Sunshine] (→123) </p> 

Taking Pictures with different picture effects (Creative Control Mode)

Taking a picture with a blurred background (Defocus control function)

You can easily set the blurriness of the background while checking the screen.

1 Press ▲ to display the setting screen

- Each press of ▲ switches between brightness (exposure) setting operation (below), blur control operation, and operation finish.

2 **ZS100**

Rotate the rear dial to set

ZS60

Rotate the control dial to set

- Press [MENU/SET] to return to the recording screen.
- Pressing [Q.MENU/↵] button on the blurriness setting screen will cancel the setting.

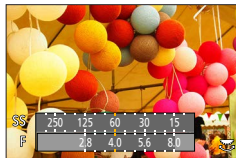

- This function is not available in the following case:

- [Miniature Effect] (Creative Control Mode)

Setting brightness (exposure)

1 Press ▲ to display the setting screen

- Each press of ▲ switches between brightness (exposure) setting operation, blur control operation (above), and operation finish.

2 **ZS100**

Rotate the rear dial to set

ZS60

Rotate the control dial to set



■ Change the settings by using the touch screen

① Touch [☰]

② Touch the item you want to set

[☰]: Adjusting the picture effect

[☰]: Degree of defocusing

[☰]: Brightness (exposure)

③ Drag the slide bar to set



- Press [MENU/SET] to return to the recording screen.



Taking Pictures with different picture effects (Creative Control Mode)

[Miniature Effect]**■ Defocusing a picture**

You can create the impression of a diorama by intentionally creating a blurred area and focusing area using [Miniature Effect]. You can set the recording direction (direction of blurred area), position and size of the focusing area.

- ① After touching [, touch [
- ② Press ▲▼ or ◀▶ to move the focusing area (frame)
 - You can also move the in-focus portion by touching the screen on the recording screen.
 - Touching [] allows you to set the recording orientation (defocus orientation).

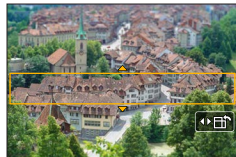

- ③ **ZS100**
Rotate the rear dial to select the size of the focusing area (frame)

ZS60

Rotate the control dial to select the size of the focusing area (frame)

- On the touch screen, spread (pinch out) your 2 fingers to zoom in, and pinch (pinch in) your 2 fingers to zoom out. (→61)
 - When you press [DISP.] button, the initial setting condition is restored.
- ④ Press [MENU/SET]

- No audio is recorded for motion pictures.
- When a motion picture is recorded, the finished recording will be approximately 1/10th of the actual recorded time period. (If you record a motion picture for 10 minutes, the resulting motion picture recording time will be approximately 1 minute.) The recordable time displayed on the camera is approx. 10 times of the actual recording time. When the Recording mode is changed, be sure to check the recordable time.
- If you stop recording motion pictures too soon, the camera may continue recording until a certain time. Hold the camera until the camera stops recording.
- If [MF] is selected for the focus mode, move the focusing area to the position at which the focus has been adjusted.

Taking Pictures with different picture effects (Creative Control Mode)

[One Point Color]**■ Select the color to be retained**

- ① After touching [📷], touch [🎨]
- ② Select the color to be retained with ▲ ▼ ◀ ▶ and press [MENU/SET]
 - You can also select it by touch operations.
 - When you press [DISP.] button, the initial setting condition is restored.



- The selected color may not be retained for some subjects.

[Sunshine]**■ Setting the light source**

- ① After touching [📷], touch [☀️]
- ② Press ▲ ▼ ◀ ▶ to move the center of the light source to a different position
 - The position of the light source can also be moved by touching the screen.

**Tips on positioning the center of the light source**

You can move the center of the light source to a point outside the image to obtain a more natural finish.

- ③ **ZS100**
Rotate the rear dial to adjust the size of the light source
- ZS60**
Rotate the control dial to adjust the size of the light source

- On the touch screen, spread (pinch out) your 2 fingers to zoom in, and pinch (pinch in) your 2 fingers to zoom out.
- When you press [DISP.] button, the initial setting condition is restored.

- ④ Press [MENU/SET]



Recording motion pictures by setting the aperture value/shutter speed (Creative Video Mode)

Recording mode: 

You can record motion pictures by manually setting the aperture value and shutter speed.

1 Set mode dial to [M]

2 Set the menu

MENU →  [Motion Picture] → [Exposure Mode]

3 Press ▲ ▼ to select [P], [A], [S] or [M], and press [MENU/SET]

- The operation for changing the aperture value or shutter speed is the same as the operation for setting the mode dial to [P], [A], [S] or [M].



It is also possible to display the selection screen by touching the Recording mode icon in recording screen.



4 Press the motion picture button (or shutter button) to start recording

5 Press the motion picture button (or shutter button) to stop recording

● About aperture value

- To record motion pictures with a sharp focus on both subject and background, set the aperture value to a higher number. To record motion pictures with a defocused background, set a lower number.

● About the shutter speed

- To record a sharp motion picture of a fast-moving subject, set a faster shutter speed. To record a motion picture with a trailing effect for a subject's movements, set a slower shutter speed.
- When you manually set a faster shutter speed, the screen noise may increase due to the higher sensitivity.
- When you record a subject in an extremely bright place or under fluorescent or LED lighting fixtures, etc., the colors and screen brightness may change or horizontal striping may appear on the screen. If this happens, we recommend changing the Recording mode or manually adjusting the shutter speed to 1/60 seconds or 1/100 seconds.

● ZS100

When [Exposure Mode] is set to [M], [AUTO] of the ISO sensitivity will switch to [125].

● ZS60

When [Exposure Mode] is set to [M], [AUTO] of the ISO sensitivity will switch to [80].

- Drive mode settings are disabled.



Recording motion pictures by setting the aperture value/shutter speed (Creative Video Mode)

Recording Slow Motion Pictures ([High Speed Video])

Slow motion pictures can be recorded by performing recording at a super high speed. When these recordings are played back, the motion is displayed slowly.

- To record pictures, use a UHS Speed Class 3 card. (→37)

1 Set mode dial to [M]

2 Set the menu

MENU → [Motion Picture] → [High Speed Video]

3 **ZS100**

Use ▲ ▼ to select [ON], and press [MENU/SET]

[120fps/FHD]	Recording is done at 120 frames/second with [FHD] in [MP4].
--------------	---

ZS60

Use ▲ ▼ to select motion picture quality, and press [MENU/SET]

[240fps/VGA]	Recording is done at 240 frames/second with [VGA] in [MP4]. • The angle of view becomes narrower.
[120fps/HD]	Recording is done at 120 frames/second with [HD] in [MP4].

4 Press the motion picture button (or shutter button) to start recording

5 Press the motion picture button (or shutter button) to stop recording

- No sound is recorded.
- Recording stops when the continuous recording time exceeds 7 minutes and 29 seconds or the file size exceeds 4 GB. (Recording can be performed up to 29 minutes and 56 seconds if converted to playback time.)
- The settings for the focus, zoom, exposure and White Balance are fixed to the settings specified when recording was started.
- Flickering or horizontal stripes may appear while recording under fluorescent lighting.

Recording motion pictures by setting the aperture value/shutter speed (Creative Video Mode)

Minimizing operational sounds during motion picture recording

The operational sound of the zoom or button operation may be recorded when it is operated during the recording of a motion picture. Using touch icons allows silent operation while recording motion pictures.

1 Set the menu





MENU →  [Motion Picture] → [Silent Operation]

2 Use ▲ ▼ to select [ON]

3 Start recording



4 Touch

5 Touch icon

	Zoom
	Aperture value
	Shutter speed
	Exposure Compensation
	ISO sensitivity

6 Drag the slide bar to set

- The speed of the operation varies depending on the position you touch.

	Changes the setting slowly
	Changes the setting quickly



7 Stop recording

- Cannot be used during [High Speed Video] recording.

Registering your own settings and recording

(Custom Mode)

Recording mode:

You can register the current camera settings as custom settings. If you then record in Custom Mode, you can use the registered settings.

- Initial setting of the Program AE Mode is registered as the custom settings initially.

Registering your own settings ([Cust.Set Mem.])

To allow recording using the same settings, up to 3 sets of current camera settings can be registered using [Cust.Set Mem.]. ([C1], [C2], [C3])

Preparations

Select the recording mode you wish to register and set the [Rec] menu, [Motion Picture] menu, [Setup] menu, etc.

1 Set the menu

 →  [Custom] → [Cust.Set Mem.]

2 Use ▲ ▼ to select custom set for registration and press [MENU/SET]

- The following menu items are not registered as custom settings.

[Rec] menu	[Setup] menu
<ul style="list-style-type: none"> • Data registered with [Face Recog.] • The [Profile Setup] setting 	<ul style="list-style-type: none"> • All menus
[Custom] menu	[Playback] menu
<ul style="list-style-type: none"> • [Touch Scroll] • [Menu Guide] 	<ul style="list-style-type: none"> • [Rotate Disp.] • [Picture Sort]

Registering your own settings and recording (Custom Mode)

Recording using registered custom set

1 Set mode dial to [C]

- The custom set you used last time will be called up.

■ To change a custom set

- Set mode dial to [C]
- Press [MENU/SET] to bring up the menu
- Press ◀▶ to select the custom set you want to use, and press [MENU/SET]



It is also possible to display the selection screen by touching the Recording mode icon in recording screen.



- The settings are switched to those settings you selected for the custom set.



Changing the registered content

Even if the menu settings are changed temporarily when the mode dial has been set to [C], the currently registered settings will remain unchanged.

To change the currently registered settings, overwrite the registered data using [Cust.Set Mem.] on the [Custom] menu.

Adjusting the picture quality with effects [Photo Style]

Recording mode: **PAS**

You can adjust the colors and picture quality according to the concept of the picture that you want to create.

MENU → **[Rec]** → **[Photo Style]**

[Standard]	Standard setting.
[Vivid]*	Setting with slightly high contrast and saturation.
[Natural]*	Setting with slightly low contrast.
[Monochrome]	Setting that creates a picture using monochrome shades of gray only, such as black and white.
[Scenery]*	Setting that creates a picture using vivid colors for the blue sky and green.
[Portrait]*	Setting that produces the look of a healthy complexion.
[Custom]*	Setting for using colors and picture quality that were registered in advance.

* This setting is not available in Intelligent Auto Plus Mode.

- In Intelligent Auto Plus Mode, the setting will be reset to [Standard] when the camera is switched to another Recording mode or this unit is turned on and off.
- Only picture quality adjustment can be set in the Scene Guide Mode.

Adjusting the picture quality with effects [Photo Style]

■ Adjusting the picture quality

- Picture quality cannot be adjusted in the Intelligent Auto Plus Mode.

① Press ◀▶ to select the type of Photo Style

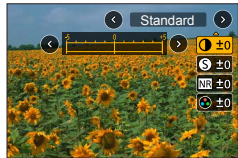

② Press ▲▼ to select an item and press ◀▶ to adjust

☉ [Contrast]	[+]	Increases the contrast in a picture.
	[-]	Decreases the contrast in a picture.
Ⓢ [Sharpness]	[+]	Enhances the outlines in a picture.
	[-]	Softens the outlines in a picture.
NR [Noise Reduction]	[+]	Increases the noise reduction effect to reduce noise. This setting may slightly lower the resolution.
	[-]	Lowers the noise reduction effect to achieve a picture quality with clearer resolution.
🌈 [Saturation]*1	[+]	Gaudy coloring
	[-]	Subdued coloring
🌈 [Color Tone]*1	[+]	Bluish coloring
	[-]	Yellowish coloring
🎛️ [Filter Effect]*2	[Yellow]	Enhances the contrast of a subject. (Effect: Low) Records a blue sky clearly.
	[Orange]	Enhances the contrast of a subject. (Effect: Medium) Records a blue sky with vibrant colors.
	[Red]	Enhances the contrast of a subject. (Effect: High) Records a blue sky with even more vibrant colors.
	[Green]	Applies subdued coloring for the skin and lips of a person. Emphasizes green leaves and makes them brighter.
	[Off]	—

*1 [Color Tone] is displayed only when [Monochrome] is selected. Otherwise, [Saturation] is displayed.

*2 Displayed only when [Monochrome] is selected.

- When the picture quality is adjusted, [+] will be displayed in the [Photo Style] icon.

③ Press [MENU/SET]

■ Registering the setting for the adjusted picture quality to [Custom]

① Perform the picture quality adjustment in Step ② of “Adjusting the picture quality” and press the [DISP.] button

Taking pictures using picture effects [Filter Settings]

Recording mode: **PAS**

You can apply picture effects (filters) that are available for Creative Control Mode to images in other modes, such as Aperture-Priority AE Mode or Panorama Shot Mode. For details (→117).

MENU → **[Rec]** → **[Filter Settings]** → **[Filter Effect]**

[ON]	Record with the set picture effect added.
[OFF]	Record without adding picture effect.
[SET]	Set picture effect. (→117)

■ Change the settings by using the touch screen

- ① Touch
- ② Touch the item you want to set
 - : Picture effects ON or OFF
 - : Picture effects (Filter)
 - : Adjusting the picture effect



- Cannot be used during [High Speed Video] recording.
- [Rough Monochrome], [Silky Monochrome], [Miniature Effect]*, [Soft Focus], [Star Filter] and [Sunshine] are not available in the following cases.
 - Creative Video Mode
 - During motion picture recording
 - [Toy Effect] and [Toy Pop] also cannot be used when [4K Live Cropping] is set.
 - When recording 4K photos
 - When recording using [Post Focus]
 - * In Creative Video Mode or when recording motion pictures, this item is not available only if the motion picture size is [4K] in [Rec Quality].
- The following functions are not available in Panorama Shot Mode.
 - [Toy Effect], [Toy Pop], [Miniature Effect], [Sunshine]
- When recording panorama pictures, the following effects are not applied to the recording screen.
 - [Rough Monochrome], [Silky Monochrome], [Soft Focus], [Star Filter]
- When recording a panorama picture in a scene with low brightness, you may not be able to achieve the desired results if [High Key] is used in the Panorama Shot Mode.
- The available ISO sensitivity settings will be limited up to [3200]. The ISO sensitivity for [High Dynamic] will be fixed to [AUTO].
- Settings will be stored even if the recording mode is changed or the camera is turned off.



Taking pictures using picture effects [Filter Settings]

**Taking two still pictures with and without picture effects
([Simultaneous record w/o filter])**

You can take two still pictures at the same time by pressing the shutter button once; one with effects and one without effects.

MENU →  **[Rec]** → **[Filter Settings]** → **[Simultaneous record w/o filter]**

Settings: [ON] / [OFF]

- When [ON] is set, the camera will take a still picture with the effects applied and then a still picture without the effects.
 - After taking the picture, [Auto Review] will display only the still picture with the effects applied.
- This function is not available in the following cases:
 - When [Filter Effect] of [Filter Settings] is set to [OFF]
 - Panorama Shot Mode
 - When using [Burst]
 - When recording 4K photos
 - When using [Auto Bracket]
 - When recording using [Post Focus]
 - During motion picture recording
 - Taking still pictures while a motion picture is being recorded.
 - When [Quality] is set to [RAW ], [RAW ] or [RAW]
 - When using [Time Lapse Shot]
 - When using [Stop Motion Animation]

ZS100 Adjusting highlights and shadows

[Highlight Shadow]

Recording mode: **PAS**

You can adjust the highlights and shadows in a picture while confirming the brightness of these areas on the screen.

1 Set the menu

MENU → [Rec] → [Highlight Shadow]

2 Press ◀▶ to select the item

<input checked="" type="checkbox"/> ([Standard])	No adjustments.
<input checked="" type="checkbox"/> ([Higher contrast])	Makes the highlighted areas brighter and shadowed areas darker.
<input checked="" type="checkbox"/> ([Lower contrast])	Makes the highlighted areas darker and shadowed areas brighter.
<input checked="" type="checkbox"/> ([Brighten shadows])	Makes the shadowed areas brighter.
/ / (Custom)	You can set a custom registration shape.

3 Rotate the control ring to adjust the brightness of the highlighted areas and rotate the rear dial to adjust the brightness of the shadowed areas

- To register your preferred settings, press ▲ to select the registration target icon (Custom 1, Custom 2, and Custom 3).
- Adjustments can also be made by dragging the graph.

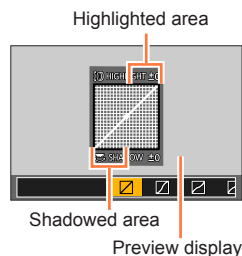

4 Press [MENU/SET]

- You can press the [DISP.] button on the brightness adjustment screen to switch the screen display.

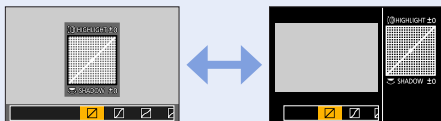

- The settings registered in , , or will be retained even if the camera is turned off.
- The settings adjusted in , , , or will be restored to the default settings when the camera is turned off.

Adjusting the White Balance

Recording mode:

In sunlight, under incandescent lights or in other such conditions where the color of white takes on a reddish or bluish tinge, this item adjusts to the color of white which is closest to what is seen by the eye in accordance with the light source.

1 Press [WB] button (▶)

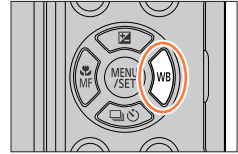

Set the menu

MENU → **[Rec]** → **[White Balance]**

2 Rotate the rear dial to select the White Balance

Rotate the control dial to select the White Balance

[AWB]	Automatic adjustment in accordance with the light source.
	Adjust to the color under a clear sky.
	Adjust to the color under a cloudy sky.
	Adjust to the color in the shade.
	Adjust to the color under incandescent lights.
*1	Adjust to the color that is optimal for taking pictures using the flash.
*2	Use the White Balance value that was set manually. (→136)
	Use the preset color temperature setting. (→136)

*1 The [AWB] setting is applied while recording motion pictures, recording 4K photos, or recording in [Post Focus].

*2

3 Press [MENU/SET] to finalize the setting

- You can also press the shutter button halfway to set the White Balance.

Adjusting the White Balance



Under fluorescent lighting, LED lighting fixtures, etc., the optimal White Balance will vary depending on the lighting type, so use [AWB], [], [], []* or []*.

* **ZS100**

- The White Balance may not operate correctly if you take pictures using a flash or the subject is recorded outside of the effective flash range (→242).
- In Scene Guide Mode, changing the scene or recording mode will return White Balance settings (including the White Balance fine adjustment setting) back to [AWB].
- In the Scene Guide Mode, settings suitable for each scene are made.

■ Auto White Balance

When [AWB] (Automatic White Balance) is set, the coloring is adjusted in accordance with the light source. However, if the scene is too bright or too dark or if other extreme conditions apply, the pictures may appear reddish or bluish. The White Balance may not operate correctly if there is a multiple number of light sources. In that case, set the [White Balance] to settings other than [AWB] to adjust the coloring.

: [AWB] operational range

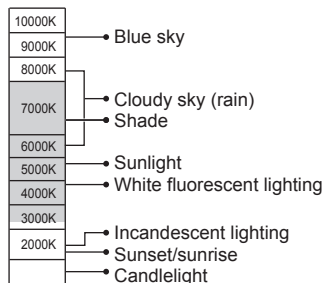

K=Kelvin Color Temperature



Adjusting the White Balance

Setting the White Balance manually

Take a picture of a white object under the target light source to adjust colors.

1 In steps **1 - 2** of “Adjusting White Balance,” (→134) select [**1**], [**2**], [**3**]*¹ or [**4**]*¹ and press **▲**

*¹ **ZS100**

2 Point the camera at a white object such as a piece of paper, ensuring that it is inside the frame at the center of the screen, and press the shutter button

- This will set the White Balance and return you to the recording screen.
- The same operation can be performed by pressing [MENU/SET].

- It may not be possible to set the correct White Balance if subjects are too bright or too dark. In this case, adjust the brightness and try to set the White Balance again.

Setting the White Balance using color temperature

You can set the White Balance using color temperature. Color temperature is a numeric value that expresses the color of light (unit: K*²). A picture becomes bluish when the color temperature value is higher, and reddish when the temperature value is lower.

*² Kelvin

1 In steps **1 - 2** of “Adjusting White Balance,” (→134) select [**1/∞**] and press **▲**

2 Use **▲ ▼** to select the color temperature value and press [MENU/SET]

- You can set the color temperature from [2500K] to [10000K].

3 Press [MENU/SET] to finalize the setting

- You can also press the shutter button halfway to set the White Balance.

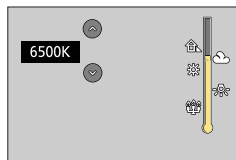

Adjusting the White Balance

Performing White Balance fine adjustments

White Balance settings can be individually fine-tuned if colors still do not appear as anticipated.

1 In steps **1 - 2** of “Adjusting White Balance,” (→134) select the White Balance and press ▼

2 Use ▲ ▼ ◀ ▶ to perform White Balance fine adjustments

- ◀: A (amber: orangish colors) ▶: B (blue: bluish colors)
- ▲: G (green: greenish colors) ▼: M (magenta: reddish colors)
- You can also make fine adjustments by touching the White Balance graph.
- Pressing [DISP.] button resets the position back to the center.

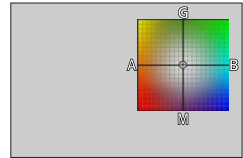

3 Press [MENU/SET]

4 Press [MENU/SET] to finalize the setting

- You can also press the shutter button halfway to set the White Balance.

- When you perform fine adjustments of the White Balance toward the A (amber) or B (blue) side, the color of the White Balance icon displayed on the screen will change to the fine-tuned color.
- When you perform fine adjustments of the White Balance toward the G (green) or M (magenta) side, [+] (green) or [-] (magenta) will be displayed in the White Balance icon on the screen.
- Settings remain applied when using flash.
- When you set a new White Balance value by selecting [1], [2], [3]* or [4]*, or change the color temperature by selecting [K], the White Balance fine adjustment level will be returned to the standard setting (center point).

* ZS100

Adjusting the White Balance

Bracket recording using White Balance

Bracket settings are performed based on the fine adjustment values for White Balance, and three pictures with different coloring are automatically recorded when the shutter button is pressed once.

- ZS100**
Perform fine adjustments of the White Balance in step 2 of “Performing White Balance fine adjustments” (→137) and rotate the rear dial to perform the Bracket setting

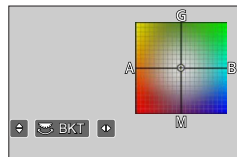

- ZS60**
Perform fine adjustments of the White Balance in step 2 of “Performing White Balance fine adjustments” (→137) and rotate the control dial to perform the Bracket setting

Clockwise: Horizontal ([A] to [B])
Counterclockwise: Vertical ([G] to [M])

- You can also set the bracket by touching [↕]/[↔].

- Press [MENU/SET]

- Press [MENU/SET] to finalize the setting

- You can also press the shutter button halfway to set the White Balance.

- When the White Balance Bracket is set, [BKT] appears on the White Balance icon.
- ZS100**
When the camera is turned off (Including [Sleep Mode]), the White Balance Bracket setting is canceled.
- ZS60**
When the camera is turned off (Including [Auto Power Off]), the White Balance Bracket setting is canceled.
- This function is not available in the following cases:
 - Panorama Shot Mode
 - [Glistening Water], [Glittering Illuminations], [Handheld Night Shot], [Soft Image of a Flower] (Scene Guide Mode)
 - When using [Burst]
 - When recording 4K photos
 - When using [Auto Bracket]
 - When recording using [Post Focus]
 - When taking still pictures while a motion picture is being recorded
 - When [Quality] is set to [RAW:📷], [RAW:📷] or [RAW]
 - When [HDR] is set to [ON]
 - ZS100** When [Multi Exp.] is set
 - When using [Time Lapse Shot]

Setting the picture quality and size

Changing the aspect ratio of the still pictures

Recording mode: **PAS** **M** **C**

This allows you to select the aspect ratio of the pictures to suit printing or the playback method.

MENU → **[Rec]** → **[Aspect Ratio]**

[4:3]	Aspect ratio of a 4:3 TV
[3:2]	Aspect ratio of standard film cameras
[16:9]	Aspect ratio of high-definition TV, etc.
[1:1]	Aspect ratio of a square image

ZS100

If you use the HDMI output during recording, the setting is fixed to [16:9]. (→232)

Setting the picture size

Recording mode: **PAS** **M** **C**

The higher the numbers of pixels, the finer the detail of the pictures will appear even when they are printed onto large sheets.

MENU → **[Rec]** → **[Picture Size]**

ZS100

[Aspect Ratio]	4:3	3:2	16:9	1:1
[Picture Size]	[L] 17.5M 4864×3648	[L] 20M 5472×3648	[L] 17M 5472×3080	[L] 13.5M 3648×3648
	[EX M] 9M 3456×2592	[EX M] 10M 3888×2592	[EX M] 8M 3840×2160	[EX M] 6.5M 2592×2592
	[EX S] 4.5M 2432×1824	[EX S] 5M 2736×1824	[EX S] 2M 1920×1080	[EX S] 3.5M 1824×1824

ZS60

[Aspect Ratio]	4:3	3:2	16:9	1:1
[Picture Size]	[L] 18M 4896×3672	[L] 16M 4896×3264	[L] 13.5M 4896×2752	[L] 13.5M 3664×3664
	[EX M] 9M 3456×2592	[EX M] 8M 3456×2304	[EX M] 8M 3840×2160	[EX M] 7M 2592×2592
	[EX S] 4.5M 2400×1800	[EX S] 4M 2400×1600	[EX S] 2M 1920×1080	[EX S] 3.5M 1824×1824

- When [Burst Rate] is set to [SH], [Picture Size] is fixed to [S].
- The picture size will be fixed to [4K] ([4:3]: 3328×2496; [3:2]: 3504×2336; [16:9]: 3840×2160; [1:1]: 2880×2880) when recording 4K photos or recording in Post Focus.

Setting the picture quality and size

Setting the compression rate of pictures ([Quality])

Recording mode: **PAS** **M** **C**

Set the compression rate used for storing pictures.

MENU → **[Rec]** → **[Quality]**

Settings	File format	Description
	JPEG	Gives priority to picture quality and saves pictures in JPEG file format.
		Saves pictures in JPEG file format using standard picture quality. This setting is useful when you want to increase the number of recordable pictures without changing the number of pixels.
 	RAW + JPEG	Saves pictures in JPEG file format (or) in addition to the RAW file format.*1
[RAW]	RAW	Saves pictures in the RAW file format.*2 [RAW] images are recorded with a smaller data volume than or .

*1 If you delete a RAW file from the camera, the corresponding JPEG file is also deleted.

*2 Regardless of the aspect ratio of the picture during recording, a RAW still picture is always recorded at the following aspect ratio.



ZS100: [3:2] (5472×3648)**ZS60**: [4:3] (4896×3672)

About RAW file

In RAW file format the data is saved without any picture processing by the camera. To play back and edit RAW file pictures, you must use this unit or dedicated software. You can perform advanced editing of RAW file pictures, such as correcting the White Balance of pictures recorded previously, and save the pictures in file formats that can be displayed on a PC. This format delivers a higher picture quality than the JPEG format, but the amount of data is greater.

- **ZS100**
You can develop the RAW file pictures using [RAW Processing] in the [Playback] menu. (→284)
- To develop and edit RAW file pictures on a PC, use the software (Ichikawa Soft Laboratory's "SILKYPIX Developer Studio"). To get this software, download it from the supplier's website and install it on your PC. (→353)

Setting the picture quality and size

- When you play back a picture recorded with [RAW], the gray area is displayed according to the aspect ratio of the picture during recording.
- The setting is fixed to  when recording 4K photos or recording in [Post Focus].
- The following effects cannot be used on RAW file pictures.
 - Intelligent Auto Plus Mode
 - Creative Control Mode
 - White Balance
 - [Photo Style]^{*1}, [Aspect Ratio], [Highlight Shadow]^{*1, *2}, [i.Dynamic]^{*1}, [Red-Eye Removal]^{*3}, [i.Resolution]^{*1}, [Diffraction Compensation]^{*3}, [Color Space]^{*1, *2} ([Rec] menu)
- You cannot set to ,  or [RAW] in the following cases:
 - Panorama Shot Mode
 - [Handheld Night Shot] (Scene Guide Mode)

^{*1} **ZS100**

When you use [RAW Processing] in the [Playback] menu, adjustments are made from the settings at the time of recording. Therefore, you can output a JPEG format picture with the settings at the time of recording.

^{*2} **ZS100**

^{*3} **ZS100**

If corrections are made at the time of recording, the corrected JPEG format picture is output when [RAW Processing] in the [Playback] menu is used.

Using the picture correction functions effectively

Compensation effect may not be achieved depending on the conditions.

Correcting contrast and exposure ([i.Dynamic])

Recording mode: **PAS** **M** **C**

Automatically adjusts contrast and exposure to give more lifelike colors when there is significant contrast between background and subject.

MENU → **[Rec]** → **[i.Dynamic]**

Settings: **[AUTO]** / **[HIGH]** / **[STANDARD]** / **[LOW]** / **[OFF]**

- This function is not available in the following case:
 - When [HDR] is set to [ON]
 - **ZS100**
When [Sensitivity] is set to [H.16000], [H.20000] or [H.25600]
 - **ZS60**
When [Sensitivity] is set to [H.4000], [H.5000] or [H.6400]

Enhancing the impression of high-resolution ([i.Resolution])

Recording mode: **PAS** **M** **C**

You can use the camera's Intelligent Resolution technology to record still pictures with sharper outlines and clearer resolution.

MENU → **[Rec]** → **[i.Resolution]**

Settings: **[HIGH]** / **[STANDARD]** / **[LOW]** / **[EXTENDED]** / **[OFF]**

- When [EXTENDED] is set, you can take more natural pictures with the impression of high-resolution.
- The [EXTENDED] setting will automatically change to the [LOW] setting while recording motion pictures, recording 4K photos, or recording in [Post Focus].

Using the picture correction functions effectively

Combining still pictures with different exposures ([HDR])

Recording mode:   **PAS** **M**  **C**  

The camera can combine 3 still pictures taken at different exposures into a single properly exposed picture with rich gradation. The individual pictures used to create the HDR picture are not saved. You can minimize the loss of gradations in bright areas and dark areas when, for example, the contrast between the background and the subject is large.

A combined HDR picture is saved in JPEG format.

MENU →  **[Rec]** → **[HDR]**

[ON]	Creates a combined HDR picture.	
[OFF]	Does not create a combined HDR picture.	
[SET]*	[Dynamic Range]	<p>[AUTO]: Takes pictures after automatically setting the adjustment range of the exposure based on the contrast of a subject.</p> <p>[±1EV] / [±2EV] / [±3EV]: Takes pictures using the adjustment range of the exposure being set.</p>
[SET]*	[Auto Align]	<p>[ON]: Automatically adjusts the displacement of pictures caused by jitter, etc. We recommend using this setting to take pictures with a handheld camera.</p> <p>[OFF]: Does not adjust the displacement of pictures. We recommend using this setting when you use a tripod.</p>

* **ZS100**

- After the shutter button has been pressed, do not move the camera during the burst operation.
- Since a burst of still pictures are combined after they have been recorded, it will be a few moments before you will be able to record another picture.
- A subject that was in motion when it was recorded may be recorded as an afterimage.

● **ZS100**

When [Auto Align] is set to [ON], the angle of view narrows slightly.

- When you take pictures using a flash, the flash mode is fixed to  (Forced Flash Off).
- This function will not work for still pictures while motion pictures are being recorded.
- This function is not available in the following cases:
 - When using [Burst]
 - When recording 4K photos
 - When using [Auto Bracket]
 - **ZS100** During T (Time) recording
 - When recording using [Post Focus]
 - When [Quality] is set to [RAW:⬢], [RAW:⬢] or [RAW]
 - When using [Time Lapse Shot]
 - When [Auto Shooting] of [Stop Motion Animation] is set to [ON]

Using the picture correction functions effectively

ZS100 Suppressing the noise of a long exposure ([Long Shtr NR])

Recording mode: **PAS** **M** **C**

The camera can automatically eliminate the noise made when taking pictures with a slower shutter speed (e.g. to record night scenes) in order to take sharp pictures.

MENU → **[Rec]** → **[Long Shtr NR]**

Settings: **[ON]** / **[OFF]**

- While the camera eliminates the noise, [Long shutter noise reduction ongoing] is displayed for the same period as the shutter speed for the signal processing time.
- This function is not available in the following cases:
 - During motion picture recording
 - When [Burst Rate] is set to [SH]
 - When recording 4K photos
 - When recording using [Post Focus]
 - When using the electronic shutter

Raising the resolution when the aperture is closed ([Diffraction Compensation])

Recording mode: **PAS** **M** **C**

The camera raises the resolution by correcting the blurriness caused by diffraction when the aperture is closed.

MENU → **[Rec]** → **[Diffraction Compensation]**

Settings: **[AUTO]** / **[OFF]**

- Noise in the periphery of the picture may stand out with higher ISO sensitivity.

Using the picture correction functions effectively

ZS100 Setting the color spaceRecording mode:   **PAS**    

You can set the method for reproducing the colors to correctly display the recorded pictures on the screens of a PC or printer, etc.

MENU →  **[Rec]** → **[Color Space]**

[sRGB]	Sets the sRGB color space. This setting is widely used for devices such as PCs.
[AdobeRGB]	Sets the AdobeRGB color space. AdobeRGB color space has a wider color reproduction range than sRGB color space. Therefore, AdobeRGB color space is mainly used for business applications such as commercial printing.

- Select [sRGB] if you do not have expert knowledge about AdobeRGB color space.
- The setting is fixed to [sRGB] while recording motion pictures, recording 4K photos, or recording in [Post Focus].

Taking pictures with Auto Focus

ZS100 Recording mode:

ZS60 Recording mode:

By setting the optimum Focus Mode or Auto Focus Mode for the subject or recording condition, you can let the camera automatically adjust focus in various scenes.

1 Press button (◀)

2 Press ◀▶ to select [AF] and press [MENU/SET]

- Set the focusing action when the shutter is pressed halfway (→148)
- Switch the Auto Focus mode (→149)

ZS100

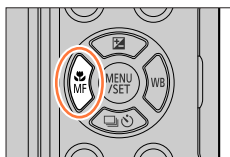

ZS60

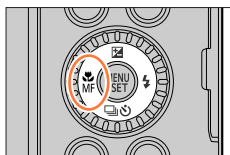

3 Press the shutter button halfway

- Two “beep” sounds are heard and Auto Focus is activated.
- Four “beep” sounds when focus is not aligned.
- When you take a picture in a dark location, [●_{LOW}] is displayed for the focus display and it may take longer to adjust focus than usual.

ZS100

If the camera detects stars in the night sky after displaying [●_{LOW}], Starlight AF will be activated. When focus is achieved, the focus indication [●_{STAR}] and AF areas in focus are displayed.

(Detection with Starlight AF works only for approximately 1/3 of the center area of the screen.)

Focus display

(When focus is aligned: illuminated)

(When focus is not aligned: flashing)

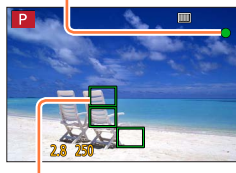

AF area

(When focus is aligned: green)

Taking pictures with Auto Focus

- When the [AFS/AFF/AFC] in [Rec] menu is set to [AFF] or [AFC].
 - A beep will be emitted when focus is first achieved during the pressing halfway.
 - **ZS100**
If Auto Focus Mode is set to [] or to a Custom Multi setting like [], the AF area will be displayed momentarily only the first time the picture is focused while the button is pressed halfway.
 - **ZS60**
If Auto Focus Mode is set to [], the AF area will be displayed momentarily only the first time the picture is focused while the button is pressed halfway.



- Subjects/environments which may make focusing difficult:
 - Fast-moving or extremely bright objects, or objects with no color contrast.
 - Taking pictures through glass or near objects emitting light.
 - In the dark, or with significant jitter.
 - When too close to object or when taking pictures of both distant and close objects together in the same picture.



Set the focusing operation to be performed when the shutter button is pressed halfway (AFS, AFF, AFC)

Recording mode: **PAS**

MENU → [Rec] → [AFS/AFF/AFC]

Settings	The movement of the subject and the scene (recommended)	Description
[AFS]	Subject is still (Scenery, anniversary photograph, etc.)	“AFS” is an abbreviation of “Auto Focus Single”. Focus is set automatically when the shutter button is pressed halfway. Focus will be fixed while it is pressed halfway.
[AFF]	Movement cannot be predicted (Children, pets, etc.)	“AFF” is an abbreviation of “Auto Focus Flexible”. In this mode, focusing is performed automatically when the shutter button is pressed halfway. If the subject moves while the shutter button is pressed halfway, the focus is corrected to match the movement automatically.
[AFC]	Subject is moving (Sport, trains, etc.)	“AFC” is an abbreviation of “Auto Focus Continuous”. In this mode, while the shutter button is pressed halfway, focusing is constantly performed to match the movement of the subject. When the subject is moving, the focusing is performed by predicting the subject position at the time of recording. (Movement prediction)



When recording using [AFF], [AFC]

- Focusing may take time if the zoom is suddenly changed from max. Wide to max. Tele, or if you suddenly move closer to a subject from a greater distance.
- Press the shutter button halfway again when it is difficult to focus on the subject.
- While the shutter button pressed halfway, shake may be seen on the screen.

- If the light on a subject is insufficient when using [AFF] or [AFC], the camera performs the same focusing operation as [AFS]. In this case, the indication on the screen will change to yellow [AFS].
- [AFF] or [AFC] in [AFS/AFF/AFC] operates as [AFS] in the following case:
 - When recording with ([4K Burst(S/S)]) of the 4K Photo function.
- It is fixed to [AFS] when panorama mode is set.
- [AFF] is not available when recording 4K photos. Continuous AF works during recording.
- This setting cannot be used when recording using [Post Focus].



Switching [AF Mode]

Recording mode:

This allows the focusing method that suits the positions and number of the subjects to be selected.

1 Set the menu

MENU → **[Rec]** → **[AF Mode]**

2 Press ◀▶ to select Auto Focus mode and press [MENU/SET]

• **ZS100**

If you press ▼ when [], [], [], or [] is selected, or touch the screen, the AF area setting screen appears.

(→157, 159)

• **ZS60**

If you press ▼ when [], [] or [] is selected, or touch the screen, the AF area setting screen appears. (→157)



- In Intelligent Auto Mode and Intelligent Auto Plus Mode, [] or [] can be set.
- Auto Focus is fixed to [] (1-area-focusing) in the following cases:
 - When using the Digital Zoom
 - [Miniature Effect] (Creative Control Mode)
- Setting cannot be made during recording in [Post Focus] or when [4K Live Cropping] is set.



Taking pictures with Auto Focus

Taking front-on pictures of people (Face/Eye Detection)

The camera automatically detects the faces and eyes of subjects. The camera adjusts the focus on the eye that is closer to the camera and the exposure using the face (when [Metering Mode] is set to [☉] (Multi Metering)).

- The camera can detect up to 15 faces. The camera can detect only the eyes of faces to be focused on.

When the camera recognized a face, the AF area and eye used for focusing are displayed.

Yellow: When the shutter button is pressed halfway and the subject is focused, the frame turns green.

White: Displayed when more than one face is detected.

Other faces that are the same distance away as faces within the yellow AF area are also focused.

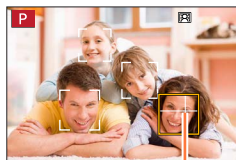

Eye used for focusing

■ Changing the eye to be in focus**Touch the eye to be used for focusing**

If you touch a location outside the yellow frame, the AF area setting screen will be displayed. (→157)

- If you touch [AF] or press [MENU/SET], the eye focus setting will be canceled.
- If the yellow frame moves to another face or the frame disappears after you change the composition or do something similar, the eye focus setting will be canceled.

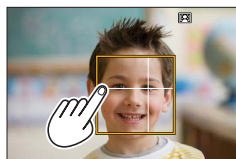

- This function is not available in the following cases:

- [Clear Nightscape], [Cool Night Sky], [Warm Glowing Nightscape], [Artistic Nightscape], [Glittering Illuminations], [Handheld Night Shot], [Appetizing Food], [Cute Dessert] (Scene Guide Mode)
- The Eye Detection cannot be changed when [4K Live Cropping] is set.
- If conditions prevent the face from being recognized, such as when the movement of the subject is too rapid, the AF Mode setting switches to [] (49-area-focusing).

Automatically locking the focus on a moving subject (Tracking)

With cursor button operations

Align the AF Tracking frame with the subject and press the shutter button halfway

When the subject is recognized, the AF Tracking frame changes from white to yellow, and the subject is automatically kept in focus.

- To release AF Tracking → Press [MENU/SET].
- Focus range: same as macro recording []

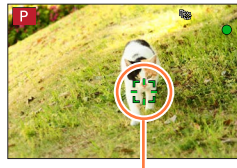

AF Tracking frame





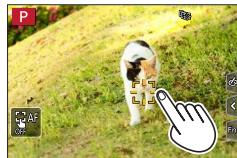

With touch screen operations

Touch the subject

Perform these operations with the touch shutter function released. The AF area turns yellow while the subject is locked.

- To release AF Tracking → Touch [].



- If AF Lock fails, a red frame flashes for a while and then turns off. Retry the locking operation.
- When you set [Metering Mode] to [] (Multi Metering), the camera adjusts the exposure using a locked subject. (→183)
- Under certain recording conditions, such as when the subject is small or dark, [] may not operate correctly. When [] does not work, focus will be on [] (1-area-focusing).
- This function is not available in the following case:
 - When using [Time Lapse Shot]
- In the following cases, [] performs the operation of [] (1-area-focusing).
 - [Glistening Water], [Glittering Illuminations], [Soft Image of a Flower], [Monochrome] (Scene Guide Mode)
 - [Sepia], [Monochrome], [Dynamic Monochrome], [Rough Monochrome], [Silky Monochrome], [Soft Focus], [Star Filter], [Sunshine] (Creative Control Mode)
 - [Monochrome] ([Photo Style])

Taking pictures with Auto Focus

Subject not centered in picture  (49-area-focusing)

Focuses on the subject in the wide range area (up to 49-area-focusing) on the recording screen.



- You can select the focusing area. ([→158](#))

ZS100 Setting the shape of an AF area , etc. (Custom Multi)

You can set the preferred shape of an AF area by selecting 49 points in the AF area, based on the subject.







1 Set the menu

MENU →  **[Rec]** → **[AF Mode]**

2 Select a Custom Multi icon (, etc.), and press **▲**

- When you press **▼**, the AF area setting screen appears.

3 Use **◀▶** to select the setting item

 ([Horizontal Pattern])	Horizontal line shape Ideal shape for panning, etc.	
 ([Vertical Pattern])	Vertical line shape Ideal shape for recording structures, etc.	
 ([Central Pattern])	Shape distributed over the center Ideal shape for focusing around the center.	
 ([C1] / [C2] / [C3]) (Custom)	You can set a custom registration shape.	

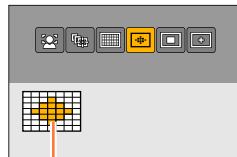

Current AF area shape

4 Press **▼**

- The AF area setting screen appears.

5 Select the AF area

When selecting [] / [] / []

You can set the size and position of the area in the vertical direction when [] is selected, in the horizontal direction when [] is selected, and in all directions when [] is selected.

Operation	Touch operation	Description
▲▼◀▶	Touch	Moves position
	Pinch out / Pinch in	Changes the size (3 stages)
[DISP.]	[Reset]	Restores to the initial settings

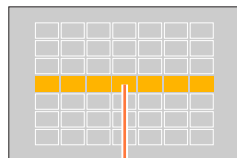

Selected AF area

When selecting [C1] / [C2] / [C3]

With cursor button operations

Use ▲▼◀▶ to select AF area and press [MENU/SET] to set (repeat)

- If you press [MENU/SET] again, the setting will be canceled.
- To cancel all the settings, press the [DISP.] button.

With touch screen operations

Touch the parts you want to set as AF areas

- If you touch one of the selected AF areas, the selection of the area will be canceled.

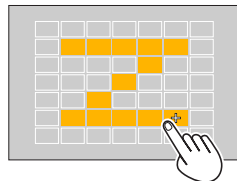

6 Press [Fn2] button

■ Registering the set AF area in [C1], [C2] and [C3] (Custom)

- ① Press ▲ on the screen of step 4 on (→153)
- ② Use ▲▼ to select the registration target icon and press [MENU/SET]

- The settings registered in [C1], [C2] and [C3] will be retained even if the camera is turned off.
- The settings adjusted in [], [] or [] will be restored to the default settings when the camera is turned off.
- If you press the cursor button when [Direct Focus Area] in the [Custom] menu is set to [ON], the AF area setting screen will appear.

ZS100 (1-area-focusing) / (Pinpoint-focusing)

ZS60 (1-area-focusing)

(1-area-focusing)

Focuses on AF area in center of picture. (Recommended when focus is difficult to align)
 • You can change the position and size of the AF area. (→157)



Locking the focus

If a subject you want to record is not in the center, follow the steps below. (Only when [AFS/AFF/AFC] in [Rec] menu is set to [AFS].)

1 Adjust focus according to subject

Align the AF area with the subject



Hold down halfway



Press fully

Focus display

(When focus is aligned: illuminated
 When focus is not aligned: flashing)



AF area



(When focus is aligned: green)



2 Return to desired composition

ZS100 (Pinpoint-focusing)

Enables more precise focusing on a smaller point than  (1-area-focusing).

- You can set the focus position using the enlarged screen. (→159)
- When you press the shutter button halfway, an enlarged display of the focus position appears.
- You can set the timeout for the enlarged display using [Pinpoint AF Time] in the [Custom] menu. (→160)
- If  (Pinpoint-focusing) is selected while recording motion pictures or 4K photos, the setting is changed to  (1-area-focusing).
- Cannot set to  (Pinpoint-focusing) in the following case:
 - When [AFS/AFF/AFC] in [Rec] menu is set to [AFF] or [AFC]



Changing the position and size of the AF area

Recording mode: **PAS**

ZS100

When [], [], [], or [] in Auto Focus Mode is selected, you can change the position and size of the AF area.

ZS60

When [], [] or [] in Auto Focus Mode is selected, you can change the position and size of the AF area.

- Perform these operations with the touch shutter function released.
- When setting with touch operation, set [Touch AF] in [Touch Settings] of the [Custom] menu to [AF]. (→61)



Enabling/disabling use of cursor button to move the AF area

MENU → [Custom] → [Direct Focus Area] → [ON] / [OFF]

ZS100

When [], [], or [] is selected, you can move the AF area and when [] is selected, you can move the enlarged position.

ZS60

When [], [], or [] is selected, you can move the AF area.

- Use the Quick menu (→68) to set functions to be assigned to the cursor button, such as Drive mode and Exposure Compensation.

- When you set [Metering Mode] (→183) to [] (spot-focusing), the metering target will move along with the AF area. When the AF area is moved to the edges of the screen, the metering operation may be affected by the surrounding brightness.
- [Direct Focus Area] is fixed to [OFF] in the following cases:
 - [Glistening Water] (Scene Guide Mode)
 - Creative Control Mode
 - When [4K Live Cropping] is set
- The position and size of the AF area cannot be changed in the Digital Zoom range.



■ When selecting [⦿] / [□]

You can change the position and size of the AF area.

① Set the menu

MENU → **[Rec]** → **[AF Mode]**

② Select [⦿] or [□] and press ▼

- The AF area setting screen appears.
- You can also display the AF area setting screen by touching the screen.



③ To change the AF area

Operation	Touch operation	Description
	Touch	To move the position of the AF area.
—	Pinch out / Pinch in	Enlarges/reduces the AF area in small steps.
	—	Enlarges/reduces the AF area in large steps.
[DISP.]	[Reset]	Resets the AF area back to the center. <ul style="list-style-type: none"> • If you press the button again, the frame size will be reset to the initial setting.

- If you set the AF area to an eye in the yellow frame when [⦿] is selected, the eye to be used for focusing will be changed.

④ Press [MENU/SET]

- AF area with the same function as [⦿] is displayed in the touched position, when the [□] is selected. Setting of the AF area is cleared when [MENU/SET] is pressed or [⦿] is touched.

Taking pictures with Auto Focus

■ When selecting [AF]

You can set the focus position by selecting an AF area group. The AF area, which is configured with 49 points, is divided into groups consisting of 9 points each (6 points or 4 points for the groups located at the edges of the screen).

① Set the menu

MENU → [Rec] → [AF Mode]

② Select [AF] and press ▼

- The AF area setting screen appears.

③ Press ▲▼◀▶ to select an AF area group

- You can also select a group by touching the screen.

④ Press [MENU/SET]

- Only the [+] indications (center points of the selected group) remain on the screen.

- Setting of the AF area is cleared when [MENU/SET] is pressed or [AF] is touched.

Examples of group

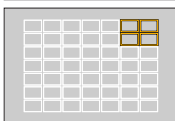
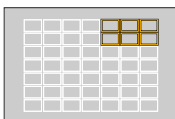
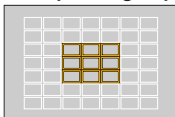

ZS100 When selecting [+]

You can enlarge the screen to perform more precise settings of the focus position.
 • You cannot set the focus position at the edges of the screen.

① Set the menu

MENU →  **[Rec]** → **[AF Mode]**



② Select [+] and press ▼

③ Use ▲▼◀▶ to set the focus position and press [MENU/SET]

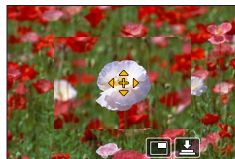
- The enlarged assist screen will appear for setting the focus position.
- The assist screen can also be displayed by touching the subject.



④ Move [+] to the focus position with ▲▼◀▶

Operation	Touch operation	Description
▲▼◀▶	Touch	Moves [+].
—	Pinch in / Pinch out	Enlarges/reduces the AF area in small steps.
	—	Enlarges/reduces the AF area in large steps.
—		Switches the enlarged display. (windowed/full screen)
[DISP.]	[Reset]	Resets [+] back to the center.



- The image of a part of the screen can be enlarged or reduced approximately 3 to 6 times. The image of the entire screen can be enlarged or reduced approximately 3 to 10 times.
- If you use the HDMI output during recording, the screen cannot be enlarged in windowed mode.
- On the assist screen, it is also possible to record a picture by touching .



**ZS100 Changing the display of the assist screen****MENU** → **fC** [Custom] → [Pinpoint AF Display]**[FULL]**: Enlarges the assist screen using the entire screen.**[PIP]**: Enlarges the assist screen on part of the screen.

- The display of the assist screen can also be switched by touching .

**ZS100 Setting the timeout for the enlarged display****MENU** → **fC** [Custom] → [Pinpoint AF Time] →**[LONG]** (approx. 1.5 seconds) / **[MID]** (approx. 1.0 second) /**[SHORT]** (approx. 0.5 seconds)

Setting the AF area position with the touch pad

Recording mode:

You can move the AF area displayed on the viewfinder by touching the monitor.

- **ZS100**

If you touch the monitor when the Auto Focus Mode is set to [Custom Multi] such as [], the AF area setting screen will be displayed. (→153)

MENU → [Custom] → [Touch Settings] → [Touch Pad AF]

[EXACT]	Moves the AF area of the viewfinder by touching a desired position on the touch pad.	
[OFFSET]	Moves the AF area of the viewfinder according to the distance you drag the touch pad (→61).	
[OFF]	—	—

- Press the shutter button halfway to determine the focus position. If you press the [DISP.] button before determining the focus position, the focus position returns to the center.
 - To cancel the settings for the AF area when the Auto Focus Mode (→149) is set to [] (Face/Eye Detection), [] (tracking), or [] (49-area-focusing), press [MENU/SET].
- The Touch Shutter function (→63) is disabled when using [Touch Pad AF].
 - The [Touch Pad AF] does not function in the following cases:
 - When [4K Live Cropping] is set
 - When [Pull Focus] in [Snap Movie] is set to [ON]

Optimizing the focus and brightness for a touched position

Recording mode:

You can optimize the focus and brightness for the position you have touched.

1 Set the menu

MENU → **fC [Custom]** → **[Touch Settings]** → **[Touch AF]** → **[AF+AE]**

2 Touch the subject you want to optimize the brightness for

- The AF area setting screen appears. (→157)
- The brightness optimization position is displayed on the center of the AF area. The position follows the movement of the AF area.
- [Metering Mode] is set to , which is used exclusively for the [Touch AE].
- Touching [Reset] returns the brightness optimization position and the AF area to the center.



3 Touch [Set]

- The AF area with the same function as is displayed on the touched position.
- If you touch , the Metering Mode returns to the original setting, and the brightness optimization position is canceled. The AF area setting is also canceled.
- If you touch , the Metering Mode returns to the original setting, and the brightness optimization position is canceled.



When the background has become too bright, etc., the brightness contrast with the background can be adjusted by compensating the exposure.

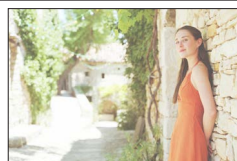

- When recording with the Touch Shutter, the focus and brightness are optimized for the touched position before recording takes place.
- At the edge of the screen, the metering may be affected by the brightness around the touched location.
- The [AF+AE] does not function in the following cases:
 - When using the Digital Zoom
 - When the AF area has been set by using the cursor button
 - When [4K Live Cropping] is set

Setting your preferred focusing method

You can use the [Custom] menu to set the focusing method in detail.

Enabling/disabling focus adjustment when the shutter button is pressed halfway

MENU → **fC** [Custom] → [Shutter AF] → [ON] / [OFF]

Enabling/disabling shutter release when the shutter button is pressed halfway

MENU → **fC** [Custom] → [Half Press Release] → [ON] / [OFF]

ZS100 Focusing using the [AF/AE LOCK] button

You can use the [AF/AE LOCK] button instead of the shutter button to focus on a subject.

1 Set the menu

MENU → **fC** [Custom] → [Shutter AF] → [OFF]

MENU → **fC** [Custom] → [AF/AE Lock] → [AF-ON]

2 Press the [AF/AE LOCK] button

- The camera focuses on a subject.

3 Press the shutter button to take a picture

- The camera takes a picture by adjusting the exposure.

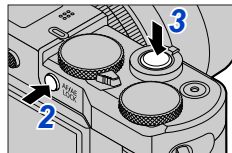

Enabling/disabling pre-adjustment of focus

MENU → **fC** [Custom] → [Quick AF] → [ON] / [OFF]

The focus is automatically adjusted when camera blurring is small even when the shutter button is not pressed. (Increases battery consumption)

- Press shutter button halfway if focus is difficult to align.
- This function is not available in the following cases:
 - Preview Mode
 - When the lighting is low

Turning on/off the AF Assist Lamp

MENU → **fC** [Custom] → [AF Assist Lamp] → [ON] / [OFF]

Illuminates the AF Assist Lamp when the shutter button is pressed halfway when it is too dark to facilitate focusing. (A large AF area is displayed based on recording conditions.)

- The AF Assist Lamp has an effective distance of 1.5 m (4.9 feet).
- AF Assist Lamp is effective for a subject at the center of the screen.
- If you do not want to illuminate the AF Assist Lamp when you take a picture in a dark location (e.g. taking a picture of an animal in the dark), set this function to [OFF]. When the AF Assist Lamp is set to [OFF], sharper focusing will become difficult.
- The setting is fixed to [OFF] in the following cases:
 - [Distinct Scenery], [Bright Blue Sky], [Romantic Sunset Glow], [Vivid Sunset Glow], [Glistening Water], [Clear Nightscape], [Cool Night Sky], [Warm Glowing Nightscape], [Artistic Nightscape], [Handheld Night Shot] (Scene Guide Mode)
 - When [Silent Mode] is set to [ON]

Enabling/disabling recording when a subject is out of focus

MENU → **fC** [Custom] → [Focus/Release Priority]

[FOCUS]: Recording is disabled unless the focusing is performed properly.

[RELEASE]: Recording is performed when you fully press the shutter button to place priority on the shutter release timing that helps to avoid missed opportunities.

Enabling/disabling manual focus adjustment after AF

MENU → **fC** [Custom] → [AF+MF] → [ON] / [OFF]

ZS100

You can manually perform fine focusing during AF Lock (pressing the shutter button halfway when [AFS/AFF/AFC] in [Rec] menu is set to [AFS] or setting AF Lock using the [AF/AE LOCK] button).

ZS60

You can manually perform fine focusing during AF Lock (pressing the shutter button halfway when [AFS/AFF/AFC] in [Rec] menu is set to [AFS]).

Taking close-up pictures (Macro recording)

Recording mode: **PASM**

This mode allows you to take close-up pictures of a subject, e.g. when taking pictures of flowers.

1 Press button (◀)

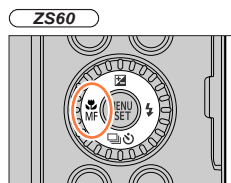
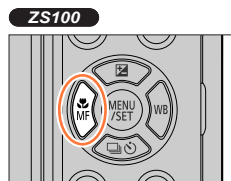

2 Press ◀▶ to select the item and press [MENU/SET]

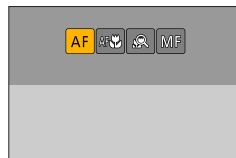

 ([AF Macro])	You can take pictures of a subject as close as ZS100 5 cm (0.16 feet), ZS60 3 cm (0.098 feet) from the lens by rotating the zoom lever upmost to Wide (1x).
 ([Macro Zoom])	Use this setting to get close to the subject and then further enlarge when taking the picture. You can take a picture with the Digital Zoom up to 3x while maintaining the distance to the subject for the extreme Wide position (ZS100 5 cm (0.16 feet), ZS60 3 cm (0.098 feet)). <ul style="list-style-type: none"> • Note that enlarging will decrease picture quality. • Zoom range will be displayed in blue. (digital zoom range)

Taking close-up pictures (Macro recording)

- When recording a subject close to the camera, we recommend taking a picture without using the flash.
- A picture may be out of focus when the subject is out of focus range, even if the focus display is lit.
- When a nearby subject is to be recorded
 - Using a tripod and [Self Timer] (→208) is recommended.
 - The effective focus range (depth of field) is significantly narrowed. Therefore, if the distance between the camera and the subject is changed after focusing on the subject, it may become difficult to focus on it again.
 - Resolution may be slightly reduced around the edges of the picture. This is not a malfunction.
- Cannot set to [Macro Zoom] in the following cases:
 - [Handheld Night Shot] (Scene Guide Mode)
 - Panorama Shot Mode
 - During [High Speed Video] recording
 - [Impressive Art], [Toy Effect], [Toy Pop], [Miniature Effect] (Creative Control Mode)
 - When [Burst Rate] is set to [SH]
 - When [HDR] is set to [ON]
 - **ZS100** When [Multi Exp.] is set
 - When [Quality] is set to [RAW], [RAW] or [RAW]

Taking pictures with Manual Focus

Recording mode:

Manual Focus is convenient when you want to lock the focus to take pictures or when it is difficult to adjust focus using Auto Focus.

- 1 Press [] button (◀)
- 2 Press ◀▶ to select [MF] and press [MENU/SET]
- 3 Touch the screen twice, set the focus position with ▲▼◀▶, and press [MENU/SET]

- The screen changes to the assist screen and an enlarged display appears. (MF Assist)
- You can also enlarge the area by pinching out (→61) the screen.
- You can also adjust the focus position by dragging (→61) the screen.
- If you press [DISP.] button, the area to be enlarged will be reset to the center.
- If you turn the control ring, you can perform Step 4. However, you will not be able to select the focus position.

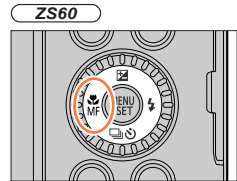
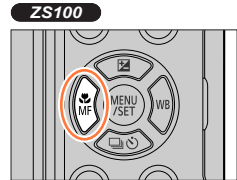

Taking pictures with Manual Focus

4 Turn the control ring to adjust focus

Turning the control ring to the right:

Focusing on a nearby subject

Turning the control ring to the left:

Focusing on a distant subject

- Color is added to the portions of the image that are in focus. (Peaking) (→172)
- About the MF Guide (→171)

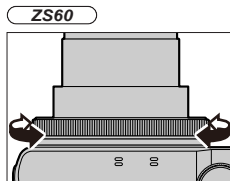
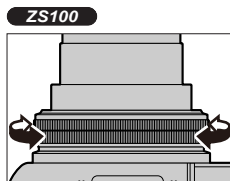



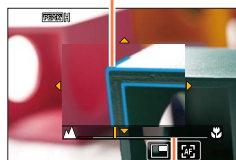

**MF Assist
(Enlarged screen)
Peaking**



MF Guide

Taking pictures with Manual Focus

Operation	Touch operation	Description
▲▼◀▶	Drag	Moves the enlarged area.
—	Pinch in / Pinch out	Enlarges/reduces the AF area in small steps.
ZS100  ZS60 	—	Enlarges/reduces the AF area in large steps.
—		Switches the enlarged display. (windowed/full screen) 
[DISP.]	[Reset]	Resets the area to be enlarged back to the center.

- The image of a part of the screen can be enlarged or reduced approximately 3 to 6 times. The image of the entire screen can be enlarged or reduced approximately 3 to 10 times.
- **ZS100**
If you use the HDMI output during recording, the screen cannot be enlarged in windowed mode.

Changing the MF Assist display

MENU →  [Custom] → [MF Assist Display]

[FULL]: Enlarges the assist screen using the entire screen.

[PIP]: Enlarges the assist screen on part of the screen.

- The display of the assist screen can also be switched by touching .

5 Press the shutter button halfway

- The assist screen will close. The recording screen will be displayed.
- You can also exit MF Assist by pressing [MENU/SET].

- If you press the cursor button when [Direct Focus Area] in the [Custom] menu is set to [ON], the setting screen for the enlarged position appears.
- MF Assist is not displayed in the following cases:
 - During motion picture recording
 - When recording with  ([4K Pre-Burst]) of the 4K Photo function
 - When using the Digital Zoom

Quickly adjusting the focus using Auto Focus

In Manual Focus, the focus can be set on the subject through Auto Focus. (One shot AF)

1 Touch [MF Assist]

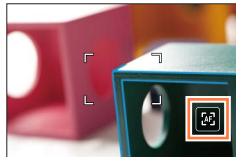

- Auto Focus is activated at the center of the frame.
- When Auto Focus is activated on the MF Assist screen, the camera will adjust the focus at the center of the MF Assist screen.
- Auto Focus also works with the following operations.
 - **ZS100**
Pressing the [AF/AE LOCK] button to which [AF-ON] is assigned (→173)
 - Pressing the function button to which [AF-ON] is assigned
 - Dragging the monitor and releasing your finger at the position you want to focus on
- One-shot AF cannot be used when [4K Live Cropping] is set.



Technique for Manual Focus

- 1 Turn the control ring to focus on the subject
- 2 Rotate it a little more
- 3 Finely focus on the subject by rotating it slowly in reverse

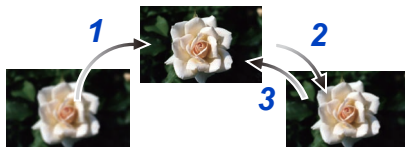

ZS100

After canceling [Sleep Mode], be sure to readjust the focus.

ZS60

After canceling [Auto Power Off], be sure to readjust the focus.

- When a nearby subject is to be recorded (→166)



Setting the display method of MF Assist

MENU → **fC** [Custom] → [MF Assist] → [ON] / [OFF]

When [MF Assist] is set to [ON] in the [Custom] menu and you perform the Manual Focus operation, an enlarged display of the MF area (the position to be focused on) appears.

- Shortly after you stop operating Manual Focus, the display switches to normal.



Enabling/disabling MF Guide display

MENU → **fC** [Custom] → [MF Guide] → [ON] / [OFF]

When [MF Guide] on the [Custom] menu is set to [ON] and you focus manually, the MF guide is displayed on the screen. You can check whether the point of focus is to the near side or the far side.

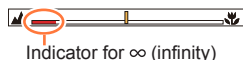

Indicator for ∞ (infinity)





Enabling/disabling [Peaking] to add color to the portions of the image that are in focus

MENU → **FC [Custom]** → **[Peaking]**

- [Peaking] functions during Manual Focus or when you are adjusting focus manually using [AF+MF].

[ON]	Color is added to the portions of the image that are in focus.																								
[OFF]	The portions of the image that are in focus are not displayed.																								
[SET]	[Detect Level]	<p>The detection level for in-focus portions is set. Settings: [HIGH] / [LOW] When [HIGH] is set, portions to be highlighted are reduced, allowing you to achieve a more precise focus. • The detection level setting does not affect the focus range.</p>																							
	[Display Color]	<p>Sets the highlighting color used for [Peaking]. Settings Changing the [Detect Level] setting also changes the [Display Color] setting as follows.</p> <table border="1"> <thead> <tr> <th>[Detect Level]</th> <th>[HIGH]</th> <th>↔</th> <th>[LOW]</th> </tr> </thead> <tbody> <tr> <td></td> <td>[Light blue]</td> <td>↔</td> <td>[Blue]</td> </tr> <tr> <td></td> <td>[Yellow]</td> <td>↔</td> <td>[Orange]</td> </tr> <tr> <td>[Display Color]</td> <td>[Yellow Green]</td> <td>↔</td> <td>[Green]</td> </tr> <tr> <td></td> <td>[Pink]</td> <td>↔</td> <td>[Red]</td> </tr> <tr> <td></td> <td>[White]</td> <td>↔</td> <td>[Gray]</td> </tr> </tbody> </table>	[Detect Level]	[HIGH]	↔	[LOW]		[Light blue]	↔	[Blue]		[Yellow]	↔	[Orange]	[Display Color]	[Yellow Green]	↔	[Green]		[Pink]	↔	[Red]		[White]	↔
[Detect Level]	[HIGH]	↔	[LOW]																						
	[Light blue]	↔	[Blue]																						
	[Yellow]	↔	[Orange]																						
[Display Color]	[Yellow Green]	↔	[Green]																						
	[Pink]	↔	[Red]																						
	[White]	↔	[Gray]																						

- When [Peaking] is set to [ON], [**PEAK H**] ([Detect Level]: [HIGH]) or [**PEAK L**] ([Detect Level]: [LOW]) will be displayed.
- Each time [**PEAK**] in [**FC**] is touched, the setting is switched in order of [ON] ([Detect Level]: [LOW]) → [ON] ([Detect Level]: [HIGH]) → [OFF].
- When [Fn Button Set] (→70) in the [Custom] menu is set to [Peaking], you can switch the setting in the following order every time the assigned function button is pressed: [ON] ([Detect Level]: [LOW]) → [ON] ([Detect Level]: [HIGH]) → [OFF].
- Since portions with clear outlines on the screen are highlighted as in-focus portions, portions to be highlighted vary depending on the recording conditions.
- The color used for highlighting does not affect recorded pictures.
- This function is not available in the following case:
 - [Rough Monochrome] (Creative Control Mode)



ZS100 Taking pictures by locking the focus and/or exposure (AF/AE Lock)

Recording mode: **PAS**

The AF/AE Lock function is convenient, for example, when there is too much contrast with the subject and you cannot get appropriate exposure (AE Lock) or when you want to take a still picture composed with the subject outside the AF area (AF Lock).

- 1 Point the camera at the subject
- 2 Lock the focus and/or exposure while you press and hold the [AF/AE LOCK] button

- When you release the [AF/AE LOCK] button, the focus and/or exposure lock is canceled.
- Only the exposure is locked at the time of purchase.

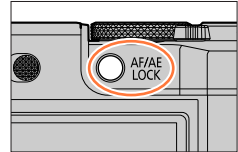

- 3 While you press and hold the [AF/AE LOCK] button, move the camera to compose the picture you want to take and fully press the shutter button

- When [AE LOCK] is set, press the shutter button halfway to focus, then press it fully.

AEL :
Exposure is locked
(AE Lock)



Setting the function of the [AF/AE LOCK] button

MENU → **fC** [Custom] → [AF/AE Lock]

[AE LOCK]	Locks exposure only. • [AEL], aperture value, and shutter speed are displayed when the correct exposure is achieved.
[AF LOCK]	Locks focus only. • [AFL], focus, aperture value, and shutter speed are displayed when the subject comes into focus.
[AF/AE LOCK]	Locks focus and exposure. • [AFL], [AEL], focus, aperture value, and shutter speed are displayed when the subject is in focus and the correct exposure is achieved.
[AF-ON]	Auto Focus is activated.

Maintaining/not maintaining the lock when [AF/AE LOCK] button is released

MENU → **fC** [Custom] → [AF/AE Lock Hold] → [ON] / [OFF]

Taking pictures by locking the focus and/or exposure (AF/AE Lock)

- AF Lock only is effective in the following case:
 - Manual Exposure Mode
- During Manual Focus, only AE Lock can be used.
- The subject can be focused again by pressing the shutter button halfway, even when AE is locked.
- Program Shift can be set even when AE is locked.



ZS60 Taking pictures by locking the focus and/or exposure (AF/AE Lock)

Recording mode: **P** **A** **S** **M** **C**

The AF/AE Lock function is convenient, for example, when there is too much contrast with the subject and you cannot get appropriate exposure (AE Lock) or when you want to take a still picture composed with the subject outside the AF area (AF Lock).

Preparation

To execute the AF/AE Lock function, it is necessary to register [AF/AE LOCK] to the function button. (→70)

- 1** Point the camera at the subject
- 2** Lock the focus and/or exposure while you press and hold the function button
 - When you release the function button, the focus and/or exposure lock is canceled.
- 3** While you press and hold the function button, move the camera to compose the picture you want to take and fully press the shutter button
 - When [AE LOCK] is set, press the shutter button halfway to focus, then press it fully.



Setting the function of the function button where [AF/AE LOCK] is registered

MENU → [Custom] → [AF/AE Lock]

[AE LOCK]	Locks exposure only. • [AEL], aperture value, and shutter speed are displayed when the correct exposure is achieved.
[AF LOCK]	Locks focus only. • [AFL], focus, aperture value, and shutter speed are displayed when the subject comes into focus.
[AF/AE LOCK]	Locks focus and exposure. • [AFL], [AEL], focus, aperture value, and shutter speed are displayed when the subject is in focus and the correct exposure is achieved.
[AF-ON]	Auto Focus is activated.



Maintaining/not maintaining the lock when the function button where [AF/AE LOCK] is registered is released

MENU → [Custom] → [AF/AE Lock Hold] → [ON] / [OFF]



Taking pictures by locking the focus and/or exposure (AF/AE Lock)

- AF Lock only is effective in the following case:
 - Manual Exposure Mode
- During Manual Focus, only AE Lock can be used.
- The subject can be focused again by pressing the shutter button halfway, even when AE is locked.
- Program Shift can be set even when AE is locked.



Taking pictures with Exposure Compensation

Recording mode: **PAS**

Corrects the exposure when there is a backlight or when the subject is too dark or too bright.

1 Press [] button (▲)

2 **ZS100**
Rotate the rear dial to compensate the exposure

ZS60

Rotate the control dial to compensate the exposure

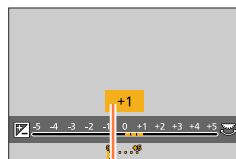
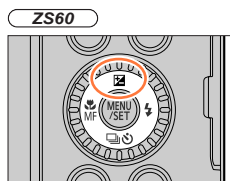
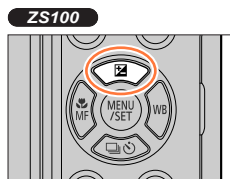

Exposure compensation value

Under-exposed



Adjust the exposure to the [+] direction

Optimum exposure



Adjust the exposure to the [-] direction

Over-exposed

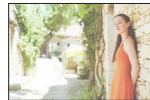

	ZS100	ZS60
Adjust the exposure to the [+] direction		
Adjust the exposure to the [-] direction		

3 Press [MENU/SET] to set

- You can also press the shutter button halfway to set.

- You can set the exposure compensation value in the range between -5 EV and $+5$ EV. Settings can be made within a range of -3 EV to $+3$ EV while recording motion pictures, recording 4K photos, or recording in [Post Focus].
- Depending on the brightness, this may not be possible in some cases.
- The set Exposure Compensation value is stored even if the camera is turned off. (When [Exposure Comp. Reset] ($\rightarrow 85$) is set to [OFF])



Setting the ISO Sensitivity

Recording mode:

Set ISO sensitivity (sensitivity to lighting) manually.

We recommend higher settings to take clear pictures in darker locations.

1 Set the menu

MENU → **[Rec]** → **[Sensitivity]**

2 Select the ISO sensitivity by rotating the rear dial

ZS100

ZS60

Select the ISO sensitivity by rotating the control dial

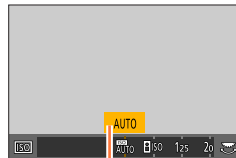

ISO sensitivity

3 Press [MENU/SET]

- You can also press the shutter button halfway to set.

AUTO	ISO sensitivity is automatically set in a range up to 3200 (ZS60) with the flash on: 1600)* ¹ depending on the brightness of a subject.
ISO (Intelligent ISO)	ISO sensitivity is automatically set in a range up to 3200 (ZS60) with the flash on: 1600)* ¹ depending on the movement and brightness of a subject. <ul style="list-style-type: none"> The shutter speed is not fixed when the shutter button is pressed halfway. It is continuously changing to match the movement of the subject until the shutter button is pressed fully.
ZS100 80* ² /100* ² /125/ 200/400/800/ 1600/3200/6400/ 12800/25600* ²	ISO sensitivity is fixed at the selected setting. <ul style="list-style-type: none"> When [ISO Increments] is set to [1/3EV], more ISO sensitivity settings can be selected. (→181)
ZS60 80/100/200/400/ 800/1600/3200/ 6400* ²	

*¹ When [ISO Limit Set] (→181) is set to other than [OFF], the ISO sensitivity is automatically set in the range up to the [ISO Limit Set] setting value.

*² Only when [Extended ISO] is [ON].

Setting the ISO Sensitivity



Setting guide

ZS100

ISO sensitivity	[125]	↔	[12800]
Location (recommended)	Bright (outdoors)		Dark
Shutter speed	Slow		Fast
Interference	Low		High
Subject blur	High		Low

ZS60

ISO sensitivity	[80]	↔	[3200]
Location (recommended)	Bright (outdoors)		Dark
Shutter speed	Slow		Fast
Interference	Low		High
Subject blur	High		Low

- For details on the available flash range used when the ISO sensitivity is set to [AUTO], refer to (→242).
- Cannot select [ISO] in the following cases:
 - Shutter-Priority AE Mode
 - Manual Exposure Mode
 - When recording using [Post Focus]
- **ZS100**
When [Multi Exp.] is set, the maximum setting is [3200].
- You can use the following settings in the Creative Video Mode or when recording 4K photos.
 - **ZS100**
[AUTO], [125] - [6400]
 - **ZS60**
[AUTO], [80] - [3200]



Setting the upper limit of ISO Sensitivity

Recording mode: **PAS** **M** **C**

You can set the upper limit of ISO sensitivity when ISO sensitivity is set to [AUTO] or [ISO].

MENU → [Rec] → [ISO Limit Set]

- **ZS100**

Settings: [200] / [400] / [800] / [1600] / [3200] / [6400] / [12800] / [OFF]

- **ZS60**

Settings: [200] / [400] / [800] / [1600] / [3200] / [OFF]

• This function is not available in the following cases:

- **ZS100**

[Clear Nightscape], [Cool Night Sky], [Warm Glowing Nightscape], [Handheld Night Shot] (Scene Guide Mode)

- **ZS60**

[Clear Nightscape], [Cool Night Sky], [Warm Glowing Nightscape], [Artistic Nightscape], [Handheld Night Shot] (Scene Guide Mode)

- During motion picture recording

Setting the incremental value of ISO Sensitivity

Recording mode: **PAS** **M** **C**

You can change the setting to increase ISO sensitivity by 1 EV or 1/3 EV.

MENU → [Rec] → [ISO Increments]

[1/3EV]	<p>ZS100</p> <p>[L.80]* / [L.100]* / [125] / [160] / [200] / [250] / [320] / [400] / [500] / [640] / [800] / [1000] / [1250] / [1600] / [2000] / [2500] / [3200] / [4000] / [5000] / [6400] / [8000] / [10000] / [12800] / [H.16000]* / [H.20000]* / [H.25600]*</p> <p>ZS60</p> <p>[80] / [100] / [125] / [160] / [200] / [250] / [320] / [400] / [500] / [640] / [800] / [1000] / [1250] / [1600] / [2000] / [2500] / [3200] / [H.4000]* / [H.5000]* / [H.6400]*</p>
[1 EV]	<p>ZS100</p> <p>[L.80]* / [L.100]* / [125] / [200] / [400] / [800] / [1600] / [3200] / [6400] / [12800] / [H.25600]*</p> <p>ZS60</p> <p>[80] / [100] / [200] / [400] / [800] / [1600] / [3200] / [H.6400]*</p>

* Only when [Extended ISO] is [ON].

• When this setting is changed from [1/3EV] to [1 EV], the setting for ISO sensitivity may be changed. (The closest ISO sensitivity that can be set for [1 EV] will be used.)

Extending the ISO Sensitivity setting

Recording mode:   **P** **A** **S** **M**  **C**  

You can extend the numeric values that can be set for ISO Sensitivity.

MENU →  **[Rec]** → **[Extended ISO]**

Settings: **[ON]** / **[OFF]**



- The setting cannot be made during 4K photo recording or recording in [Post Focus].

Setting the metering mode

Recording mode:   **P** **A** **S** **M**  **C**  

You can change the metering method used for measuring brightness.

MENU →  **[Rec]** → **[Metering Mode]**

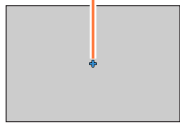
[Metering Mode]	Brightness measurement position	Conditions
 (Multiple)	Whole screen	Normal usage (produces balanced pictures)
 (Center weighted)	Center and surrounding area	Subject in center
 (Spot)	Center of [+] (spot metering target) 	Great difference between brightness of subject and background (e.g. person in spotlight on stage, backlighting)



Recording 4K Photos

Recording mode: 

You can select the desired moment from a burst of 4K photos taken at 30 frames/second and save that moment as a picture of approx. 8 million pixels.

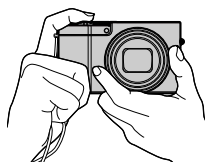

Record a 4K photo

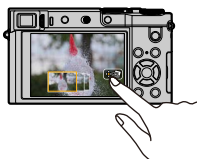



Select and save pictures



The picture is complete

- To record pictures, use a UHS Speed Class 3 card. (→37)
- When recording 4K photos, the angle of view becomes narrower.

1 Press [4K] button

- The same operation can be performed by pressing the [] button (▼), using ◀▶ to select a 4K photo icon ([]), etc.), and pressing ▲. (→201)

ZS100

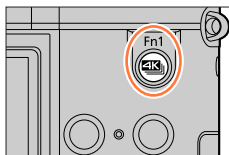

ZS60

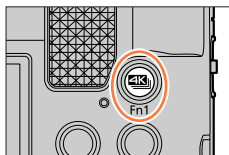





2 Press ◀▶ to select the recording method and press [MENU/SET]

- The recording method can also be set from [4K PHOTO] in the [Rec] menu.

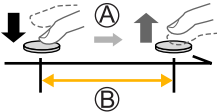

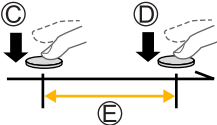

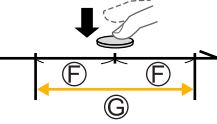
Recording 4K Photos

 [4K Burst] (→187)	<p>For capturing the best shot of a fast-moving subject (e.g., sports, aeroplanes, trains) Burst recording is performed while the shutter button is pressed and held. The shutter sound will be heard repeatedly.</p> <p>Ⓐ Press and hold Ⓑ Recording is performed</p>	
 [4K Burst(S/S)] (→188) “S/S” is an abbreviation of “Start/Stop”.	<p>For capturing unpredictable photo opportunities (e.g., plants, animals, children) Burst recording starts when the shutter button is pressed and stops when pressed again. Start and stop tones will be heard.</p> <p>Ⓒ Start (First) Ⓓ Stop (Second) Ⓔ Recording is performed</p>	
 [4K Pre-Burst] (→189)	<p>For recording as needed whenever a photo opportunity arises (e.g. the moment when a ball is thrown) Burst recording is performed for approximately 1 second before and after the moment that the shutter button is pressed. The shutter sound will be heard only once.</p> <p>Ⓕ Approximately 1 second Ⓖ Recording is performed</p>	
	Continuous recording length: Up to 15 minutes	Audio recording: None
	Continuous recording length: Up to 15 minutes	Audio recording: Available*
	Recording length: Approximately 2 seconds	Audio recording: None



* Audio is not played back when you perform playback with the camera.

3 Record a 4K photo

- Recording with  ([4K Burst]) (→187)
- Recording with  ([4K Burst(S/S)]) (→188)
- Recording with  ([4K Pre-Burst]) (→189)
- When you perform 4K burst photo recording, a 4K burst file will be saved in the MP4 format.
- When [Auto Review] is enabled, the picture selection screen will be displayed automatically. To continue recording, press the shutter button halfway to display the recording screen.
- When using [Light Composition] (→287), it is recommended to use a tripod or use a smartphone instead of the shutter and do remote recording (→312) to control camera shaking.



■ To cancel the 4K Photo functions

In step 2, select .

- The operation can be canceled by pressing the  button (▼) and then selecting  ([Single]) or  ([Off]).



Battery drainage and camera temperature

- If the surrounding temperature is high, or 4K photos are recorded continuously, or the temperature of the camera rises,  may be displayed and recording may be stopped halfway through to protect the camera. Wait until the camera cools down.
- **When  ([4K Pre-Burst]) is set, the battery drains faster and the camera temperature rises. Select  ([4K Pre-Burst]) only when recording.**



Recording with [4K Burst]

- 1 Select [] ([4K Burst]) (→184)
- 2 Press the shutter button halfway

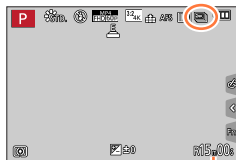

Available recording time

- 3 Press and hold the shutter button fully for as long as you want to perform recording

- Recording will start approximately 0.5 seconds after you press the shutter button fully. Therefore, press the button fully as soon as possible.
 - A 4K burst file will be recorded while the shutter button is pressed and held.
 - If you are using Auto Focus, continuous AF will work while recording. Focus will be adjusted continuously.
 - For information on how to select and save pictures from recorded 4K burst files, refer to (→190).
- Recording stops when the continuous recording time exceeds 15 minutes. When you are using an SDHC memory card, you can continue recording without interruption even if the file exceeds 4 GB, but the motion picture file will be recorded and played back in separate files. If using an SDXC Memory Card, you can record a motion picture in a single file even if the size is greater than 4 GB.
 - If you remove your finger from the shutter button immediately after the start of recording, up to a period of approximately 1.5 seconds after the moment that the finger has been removed may be recorded.

Recording with [4K Burst(S/S)]

1 Select [] ([4K Burst(S/S)]) (→184)

2 Press the shutter button fully

- Recording will start.
- If you are using Auto Focus, continuous AF will work while recording. Focus will be adjusted continuously.

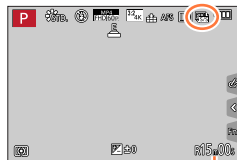

Available recording time

3 Press the shutter button fully again

- Recording will stop.



Recording tips

Adding markers to select and save pictures

When you press the [Fn1] button while recording, you can add a marker. (Up to 40 markers for each recording.) When selecting and saving pictures from a 4K burst file, you can skip to the positions where you added markers.

- For information on how to select and save pictures from recorded 4K burst files, refer to (→190).

- Recording stops when the continuous recording time exceeds 15 minutes. When you are using an SDHC memory card, you can continue recording without interruption even if the file exceeds 4 GB, but the motion picture file will be recorded and played back in separate files. If using an SDXC Memory Card, you can record a motion picture in a single file even if the size is greater than 4 GB.



Recording with [4K Pre-Burst]

1 Select [4K Pre-Burst] (→184)

- When you press the shutter button halfway, the aperture value and shutter speed are displayed.

2 Press the shutter button fully

- Recording of a 4K burst file will be performed for approximately 1 second before and after the moment that the shutter button is pressed.

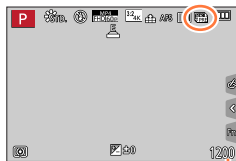

Number of recordings that can be made



Recording tips

Focus and exposure

Auto Focus adjusts focus continuously, and except in Manual Exposure Mode, it also adjusts exposure continuously.

- Focus cannot be adjusted at the desired timing by pressing the shutter button halfway or operating other controls.
- In situations where you want to lock focus and exposure, such as when the subject is not at the center, use [AF/AE LOCK]. (→173, 175)
- For information on how to select and save pictures from recorded 4K burst files, refer to (→194).

- When recording with [4K Pre-Burst], images may not be displayed as smoothly as when recording with the normal recording screen.

Selecting pictures from 4K burst file and saving

- The picture will be saved in JPEG format.
- The picture will be saved with recording information (Exif information), including its shutter speed, aperture and ISO sensitivity information.



Setting [Playback Mode] in the [Playback] menu to [4K PHOTO] enables you to play back only 4K burst files and pictures created from them.

4K burst files recorded with [📷] ([4K Burst]) or [📷] ([4K Burst(S/S)])

1 Select a 4K burst file on the playback screen, and press ▲

- [📷] is displayed on a 4K burst file.
- The same operation can be performed by touching [📷].
- The slide view screen for selecting pictures will be displayed. It takes a few seconds until the screen is displayed.



2 Touch and drag the frames to select the frame you want to save as a picture

- You can also perform the same operation by pressing ◀▶.



When you select pictures from a 4K burst file with a long burst time, we recommend that you make a rough selection of scenes using the 4K burst playback screen (→193) first, and then select the frame to be saved as a picture using the slide view screen.



<Slide view screen>

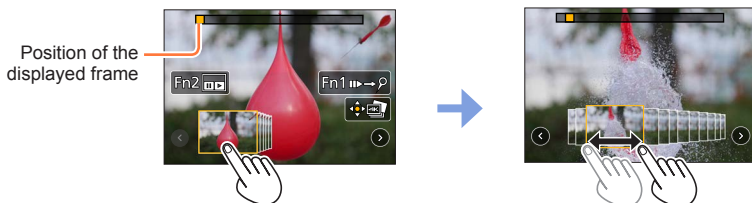





Operation	Touch operation	Description
ZS100	◀▶	Touch → Drag
ZS60		
Select ◀ ▶ with ◀▶ → [MENU/SET]	◀ ▶	<ul style="list-style-type: none"> Displays the previous or next frames in slide view The previous or next 45 frames (burst time of approximately 1.5 seconds) will replace 45 of the frames that are currently displayed in slide view. Pressing the same button again will display the frames following the next ones or the ones preceding the previous ones.
—	 Touch / Drag	<ul style="list-style-type: none"> Selects the frames to be displayed Frames preceding and following the selected frame will be displayed in slide view.
	Pinch out / Pinch in	Enlarges/reduces the display
▲▼◀▶	Drag	Moves the enlarged area (during enlarged display)
[Fn2]		Displays the 4K burst playback screen
[Fn1]	▶▶→P	Switches to marker operation ([4K Burst(S/S)] only)
[MENU/SET]		Saves the picture

- If the burst time was short, a smaller number of frames are displayed in slide view. [◀] and [▶] cannot be selected.

Recording 4K Photos

- During marker operation, you can skip to the markers that you added or the beginning or end of the 4K burst file. Press [Fn1] button again to return to the original operation.

Operation	Touch operation	Description
▶		Moves to the next marker.
◀		Moves to the previous marker.

- When you have selected frames that are not currently displayed in slide view, such as when you have selected [] or [], it may take a few seconds until the slide view frames are displayed.



<4K burst playback screen>

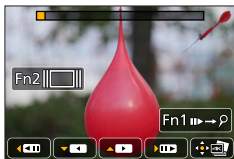

During pause

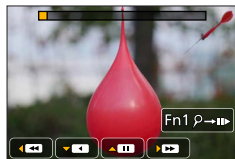

During continuous playback

Operation	Touch operation	Description
▲		Continuous playback
▼		Continuous rewind • Frames are rewound in approximately 0.5 second intervals at a faster speed than that of continuous playback.
▲▼		Pause (during continuous playback/rewind)
		Fast forward playback
		Single-frame forward (while paused)
		Fast rewind playback
		Single-frame rewind (while paused)
—	Touch / Drag	Selects the frames to be displayed (while paused)
	Pinch out / Pinch in	Enlarges/reduces the display (while paused)
▲▼◀▶	Drag	Moves the enlarged area (during enlarged display)
[Fn2]		Displays the slide view screen (while paused)
[Fn1]		Switches to marker operation (([4K Burst(S/S)]) only)
[MENU/SET]		Saves the picture (while paused)

3 Press [MENU/SET] to save the picture

- Pause the playback to perform this operation when using the 4K burst playback screen.

4K burst files recorded with [] ([4K Pre-Burst])

1 Select a 4K burst file on the playback screen, and press **▲**





- [] is displayed on a 4K burst file.
- The same operation can be performed by touching [].
- The slide view screen for selecting pictures will be displayed. It takes a few seconds until the screen is displayed.

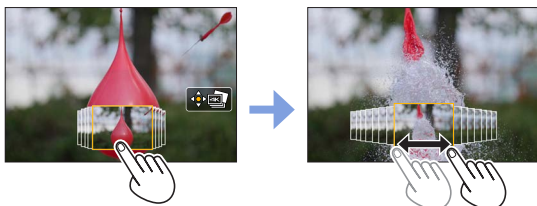

2 Touch and drag the frames to select the frame you want to save as a picture

- You can also perform the same operation by pressing ◀▶.



Operation	Touch operation	Description
ZS100  ZS60 	◀▶	Touch / Drag Selects a frame
	Pinch out / Pinch in	Enlarges/reduces the display
▲▼◀▶	Drag	Moves the enlarged area (during enlarged display)
[MENU/SET]		Saves the picture

3 Press [MENU/SET] to save the picture

■ Selecting and saving pictures on the TV screen

Preparation

Set [HDMI Mode (Play)] (→82) to [AUTO] or [4K].

- When connecting to a TV that does not support 4K motion picture, select [AUTO].

① Connect this unit to a TV using an HDMI micro cable and display the playback screen (→348)

- If you want to select and save pictures while the camera is connected to a TV with the HDMI micro cable, set [VIERA Link] of [TV Connection] in the [Setup] menu to [OFF].
- If you connect the camera to a TV with an HDMI micro cable and display 4K burst files on the TV, they will be displayed only on the 4K burst playback screen.
The 4K burst playback screen for playing back 4K burst files recorded with [4K Burst] or [4K Burst(S/S)] is displayed, and the slide view screen is not displayed.
- Even if you insert the SD card to a 4K-compatible TV with an SD card slot, you cannot play back 4K burst files recorded with [Aspect Ratio] set to an option other than [16:9].
To play them back, connect the camera and a 4K-compatible TV with an HDMI micro cable.
(As of January 2016)

- If you display the playback screen when the camera contains many picture files, the acquiring information icon [] or [] may be displayed for a long time. In this case, you cannot play back 4K burst files recorded with the 4K Photo function. Wait until the icon disappears.
- If you touch the slide view screen or 4K burst playback screen twice, the screen will be enlarged. To return to the original display, touch the enlarged screen twice.
- To select and save pictures from 4K burst files on a PC, use the software "PHOTOfunSTUDIO". Download the software from the website (→353) and install it on your PC. Please note that it is not possible to edit a 4K burst file as a motion picture.
- 4K burst files recorded on other devices may not be played back correctly on this unit.

Notes on the 4K Photo function

■ To change the aspect ratio

Selecting [Aspect Ratio] in the [Rec] menu allows you to change the aspect ratio for 4K photos.

■ To record the subject with reduced blur

You can reduce the blur of the subject by setting a faster shutter speed.

① Set mode dial to [S]

② **ZS100**

Set the shutter speed by rotating the rear dial

ZS60

Set the shutter speed by rotating the control dial

- Approximate shutter speed for outdoor recording in fine weather conditions: 1/1000 seconds or faster.
- If you increase the shutter speed, the ISO sensitivity becomes higher, which may increase the noise on the screen.

■ Shutter sound for 4K photo recording

When using [] ([4K Burst]) or [] ([4K Pre-Burst]), recording is performed with the electronic shutter. You can change the electronic shutter sound settings in [Shutter Vol.] and [Shutter Tone]. (→78)

When recording with [] ([4K Burst(S/S)]), you can set the start/stop tone volume in [Beep Volume].

- You can perform high speed burst recording quietly using the 4K Photo function in combination with [Silent Mode].

■ Scenes not suitable for the 4K Photo function

Recording indoors

When recording under fluorescent lighting or LED lighting fixtures, etc., the colors and brightness may change or horizontal striping may appear on the screen. The striping may be reduced by setting a slower shutter speed.

Fast-moving subjects

Subjects moving fast may appear distorted when recorded.

■ Limitations on the 4K Photo function

To optimize settings for 4K photo recording, certain limitations apply to some recording functions, menu items and other settings.

- The following settings are fixed.

	[4K] (8M)
[Picture Size]	<ul style="list-style-type: none"> • Following picture sizes will be applied: [4:3]: 3238×2496 [3:2]: 3504×2336 [16:9]: 3840×2160 [1:1]: 2880×2880
[Quality]	[]
[Shutter Type]	[ESHTR]
[Rec Format]*	[MP4]
[Rec Quality]*	[4K/100M/30p]
[Continuous AF]*	[ON]

* Settings in the [Motion Picture] menu are not applied to 4K burst files recorded with the 4K Photo function.

- The following limitations apply to the recording functions indicated below.

	([4K Burst])/ ([4K Burst(S/S)])	([4K Pre-Burst])
Program Shift	-	
Exposure compensation	-3 EV to +3 EV	
Shutter speed	1/30 to 1/16000	
[AFS/AFF/AFC]	AFS	
ZS100		
[AF Mode] ([])	-	
[MF Assist]	○	-
White Balance ([]), White Balance Bracket	-	
ISO sensitivity	ZS100 [AUTO], 125 to 6400 ZS60 [AUTO], 80 to 3200	
Flash	-	

- The following menu items are disabled:

Applicable to ([4K Burst])/ ([4K Burst(S/S)]/ ([4K Pre-Burst])

[Rec]	[Picture Size], [Quality], [AFS/AFF/AFC], [iHandheld Night Shot], [iHDR], [HDR], [Panorama Settings], [Shutter Type], [Flash]* ¹ , [Flash Adjust.]* ² , [Extended ISO], [Long Shtr NR]* ¹ , [Color Space]* ¹ , [Face Recog.], [Profile Setup]
[Custom]	[Rec Area]

*¹

*²

Only ([4K Pre-Burst])

[Setup]	[Economy]
----------------	-----------

- The following changes occur when recording 4K photos:
 - The [i.Resolution] setting changes from [EXTENDED] to [LOW].
 - [Destination] in [Travel Date] cannot be recorded.
 - [Simultaneous record w/o filter] is not available.
 - It is not possible to use the HDMI output.
- When recording using the ([4K Pre-Burst]) function, Step Zoom does not operate.
- Scene Detection in Intelligent Auto Mode works the same way as when recording motion pictures.
- The 4K Photo function is disabled when using the following settings:
 - [Clear in Backlight], [Glistening Water], [Artistic Nightscape], [Glittering Illuminations], [Handheld Night Shot], [Clear Night Portrait], [Soft Image of a Flower] (Scene Guide Mode)
 - [Rough Monochrome], [Silky Monochrome], [Miniature Effect], [Soft Focus], [Star Filter], [Sunshine] (Creative Control Mode)
 - When recording using [Post Focus]
 - During motion picture recording
 - During T (Time) recording
 - When [Multi Exp.] is set
 - When using [Time Lapse Shot]
 - When using [Stop Motion Animation]

Setting the Shutter Type

Recording mode: **PAS**

You can take pictures using two types of shutter modes: the mechanical shutter and electronic shutter.

	Mechanical shutter	Electronic shutter
Description	Starts the exposure electronically and ends the exposure using the mechanical shutter.	Starts and ends the exposure electronically.
Flash	○	—
Shutter Speed (seconds)	<div style="border: 1px solid black; border-radius: 10px; padding: 2px; display: inline-block; margin-bottom: 5px;">ZS100</div> T (Time)*1, 60 - 1/2000 <div style="border: 1px solid black; border-radius: 10px; padding: 2px; display: inline-block; margin-bottom: 5px;">ZS60</div> 4*2 - 1/2000	<div style="border: 1px solid black; border-radius: 10px; padding: 2px; display: inline-block; margin-bottom: 5px;">ZS100</div> 1 - 1/16000 <div style="border: 1px solid black; border-radius: 10px; padding: 2px; display: inline-block; margin-bottom: 5px;">ZS60</div> 1*2 - 1/16000
Shutter sound	Mechanical shutter sound*3 + Electronic shutter sound*4	Electronic shutter sound*4

*1 This setting is available only in Manual Exposure Mode. (→103)

*2 Varies depending on the setting of ISO sensitivity. (→179)

*3 You cannot turn off the mechanical shutter sound.

*4 You can use [Shutter Vol.] and [Shutter Tone] to adjust the volume of the electronic shutter sound. (→78)

1 Set the menu

MENU → **[Rec]** → **[Shutter Type]**

[AUTO]	The shutter mode automatically switches based on the recording conditions and shutter speed. <ul style="list-style-type: none"> The mechanical shutter mode has higher priority over the electronic shutter mode because the mechanical shutter has less function-related restrictions when recording with a flash, etc.
[MSHTR]	Uses only the mechanical shutter mode to take a picture.
[ESHTR]	Uses only the electronic shutter mode to take a picture.

Setting the Shutter Type

- In the following cases, recording is performed with an electronic shutter.
 - [E] is displayed on the screen
 - When [Burst Rate] is set to [SH]
 - When recording 4K photos
 - When recording using [Post Focus]
 - When [Silent Mode] is set to [ON]
- **If you take a picture of a moving subject using the electronic shutter, the subject in the picture may be skewed in some cases.**
- **When you take a picture under a fluorescent or LED lighting fixture using the electronic shutter, the recorded picture may have horizontal stripes. If you use a slower shutter speed, the horizontal stripes may be reduced. (→102)**



Selecting a Drive Mode

Recording mode: **PASM**

You can switch the operation to be performed when you press the shutter button.

1 Press button (▼)

2 Press ◀▶ to select the drive mode and press [MENU/SET]

A [Single]	When the shutter button is pressed, only one picture is recorded.
B [Burst] (→202)	The pictures are recorded in succession while the shutter button is pressed.
C [4K PHOTO] (→184)	When the shutter button is pressed, a 4K photo is recorded.
D [Auto Bracket]* (→206)	When the shutter button is pressed, the pictures are recorded with different exposure settings based on the Exposure Compensation range.
E [Self Timer] (→208)	When the shutter button is pressed, recording takes place after the set time has elapsed.

* Cannot be set when using Intelligent Auto Mode.

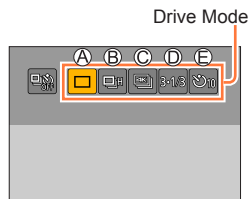
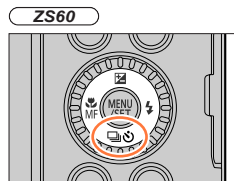
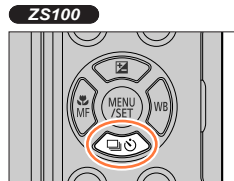

- To cancel drive mode, select [□] ([Single]) or [OFF].
- When you press ▲, you can change the settings of each drive mode. Note, however, that you cannot change the settings of [Single].



Burst function

Recording mode: **P** **A** **S** **M** **C**

The pictures are recorded in succession while the shutter button is pressed.

- Pictures that are taken while the burst speed is set to [SH] are recorded together as a single burst group (→275).

1 Press button (▼)

2 Press ◀▶ to select an item ([H], etc.) and press ▲

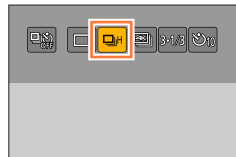

3 Press ◀▶ to select the burst speed and press [MENU/SET]



ZS100

		[SH] (Super high speed)*1	[H] (High speed)	[M] (Middle speed)	[L] (Low speed)
Speed (pictures/ sec.)	[AFS]	50	10	6	2
	[AFF] / [AFC]	—	6	6	2
Live View during burst recording		None	None	Available	Available
Number of recordable pictures*2	With RAW files	—	12*3		
	Without RAW files	60	Depends on the capacity of the card*3		

ZS60

		[SH] (Super high speed)* ¹	[H] (High speed)	[M] (Middle speed)	[L] (Low speed)
Speed (pictures/ sec.)	[AFS]	40	10	5	2
	[AFF] / [AFC]	—	5	5	2
Live View during burst recording		None	None	Available	Available
Number of recordable pictures* ²	With RAW files	—	12* ³		
	Without RAW files	60	Depends on the capacity of the card* ³		

*¹ The electronic shutter starts working, and the [Picture Size] is set to [S].

*² The number of burst pictures is limited by the picture-taking conditions and the type and/or status of the card used.

*³ Pictures can be taken until the card becomes full. However, the burst speed will become slower halfway through the recording. The exact time when the slower burst speed will start depends on the settings of the aspect ratio, picture size, and quality as well as the type of card used.

- The burst speed may become slower depending on the following settings:
 - [Picture Size] (→139), [Quality] (→140), ISO sensitivity (→179), [AFS/AFF/AFC] (→148), [Focus/Release Priority] (→164)
- Burst speed can also be set with [Burst Rate] in the [Rec] menu.
- For information about RAW files, refer to (→140).

4 Focus on the subject and take a picture



■ To cancel burst

In step 2, select [□] ([Single]) or [Off].



Focusing in burst mode

Focusing varies depending on the [AFS/AFF/AFC] in [Rec] menu (→148) and the setting of [Focus/Release Priority] (→164) in the [Custom] menu.

If the focus mode is [MF], the focus is set manually.

[AFS/AFF/AFC]	[Focus/Release Priority]	Focus
[AFS]	[FOCUS]	At the first picture
	[RELEASE]	
[AFF] / [AFC]*1	[FOCUS]	Normal focusing*2
	[RELEASE]	Predicted focusing*3

*1 Focus is fixed in the first picture when dark subjects are recorded or the burst speed is set to [SH].

*2 Since the camera records a burst of pictures while it adjusts the focus, the burst speed may be slower.

*3 The camera predicts the focus within a possible range by giving higher priority to the burst speed.



- When the burst speed is set to [H] and if many burst pictures are taken, the burst speed may be reduced while burst pictures are being taken.
- When the burst speed is set to [SH] or [H] ([AFS/AFF/AFC] in [Rec] menu is set to [AFS] or the focus mode is set to [MF]), and the exposure and White Balance are fixed to those of the first picture.
 - When the burst speed is set to [H] ([AFS/AFF/AFC] in [Rec] menu is set to [AFF] or [AFC]), [M], or [L], and the exposure and White Balance are adjusted individually for each still picture.
- Burst speed may be reduced if shutter speed (pictures/sec.) is reduced in darker locations.
- With repeated recordings, it may take a while between recordings, depending on the usage conditions.
- **It may take a while to store still pictures that were taken using the burst function. If you continue to record while storing, the number of burst pictures that can be taken will be reduced. A high-speed card is recommended when recording using the burst function.**
- This function is not available in the following cases:
 - [Glistening Water], [Glittering Illuminations], [Handheld Night Shot], [Soft Image of a Flower] (Scene Guide Mode)
 - [Rough Monochrome], [Silky Monochrome], [Miniature Effect], [Soft Focus], [Star Filter], [Sunshine] (Creative Control Mode)
 - When using [Time Lapse Shot]
 - When [Auto Shooting] of [Stop Motion Animation] is set to [ON]
 - When recording using [Post Focus]
 - During motion picture recording
 - When recording using the flash
 - **ZS100** During T (Time) recording
 - **ZS100** When [Multi Exp.] is set
- [SH] in Burst Mode cannot be used in the following cases:
 - When [Quality] is set to [RAW], [RAW] or [RAW]
 - When using [Stop Motion Animation]



Recording while exposure is changed automatically

[Auto Bracket]

Recording mode: **PAS**

Each time the shutter button is pressed, recordings are made of up to 7 pictures with different exposure settings based on the Exposure Compensation range.

Example of Auto Bracket recording when [Step] is set to [3·1/3] and [Sequence] is set to [0/-/+]

1st picture



±0 EV

2nd picture



-1/3 EV

3rd picture



+1/3 EV

- 1 Press [] button (▼)
- 2 Press ◀▶ to select an item ([3·1/3], etc.) and press ▲

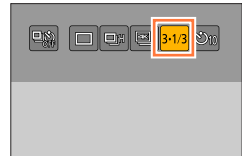

- 3 Press ◀▶ to select the compensation range and press [MENU/SET]

• **ZS60**

You can also set the amount of compensation by going to the [Rec] menu and choosing [Auto Bracket].

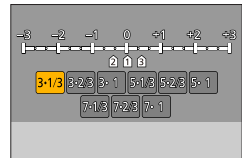

- 4 Focus on the subject and take a picture

- If you press and hold the shutter button, a burst of pictures can be recorded.
- The display of Auto Bracket flashes until all of the burst pictures you have set are recorded.
- The camera restarts recording from the first still picture if you change the Auto Bracket settings or turn off the camera before all of the burst pictures you have set are recorded.



■ To cancel [Auto Bracket]

In step 2, select [] ([Single]) or [] ([OFF]).

Recording while exposure is changed automatically [Auto Bracket]



ZS100 Changing the Single/Burst setting, compensation range, and recording sequence of Auto Bracket

① Set the menu

MENU → [Rec] → [Auto Bracket]

② Press ▲ ▼ to select [Single/Burst Settings], [Step] or [Sequence] and press [MENU/SET]

③ Press ▲ ▼ to select the setting and press [MENU/SET]

[Single/Burst Settings]	 (single)	[Step]	3·1/3 (3 pictures)	[Sequence]	0/-/+
	 (burst)		3·2/3 (3 pictures)		-/0/+
	3·1 (3 pictures)				
	5·1/3 (5 pictures)				
	5·2/3 (5 pictures)				
	5·1 (5 pictures)				
	7·1/3 (7 pictures)				
	7·2/3 (7 pictures)				
	7·1 (7 pictures)				

- When you take pictures using Auto Bracket after performing Exposure Compensation, the camera will take pictures using the corrected exposure value as a reference.
- This function is not available in the following cases:
 - [Glistening Water], [Glittering Illuminations], [Handheld Night Shot], [Soft Image of a Flower] (Scene Guide Mode)
 - [Rough Monochrome], [Silky Monochrome], [Miniature Effect], [Soft Focus], [Star Filter], [Sunshine] (Creative Control Mode)
 - When recording using [Post Focus]
 - During motion picture recording
 - When recording using the flash
 - **ZS100** During T (Time) recording
 - **ZS100** When [Multi Exp.] is set
 - When using [Time Lapse Shot]
 - When [Auto Shooting] of [Stop Motion Animation] is set to [ON]

Taking pictures with self-timer

Recording mode: **P** **A** **S** **M** **C**

We recommend using a tripod. This is also effective for preventing jitter when pressing the shutter button, by setting the self-timer to 2 seconds.

- 1 Press [] button (▼)
- 2 Press ◀▶ to select an item ([, etc.) and press ▲



- 3 Press ◀▶ to select the self-timer operation setting and press [MENU/SET]



	The shutter is activated after 10 seconds.
	The shutter is activated after 10 seconds and three pictures are taken at intervals of approximately 2 seconds.
	The shutter is activated after 2 seconds.

- You can also set the time for the self-timer using [Self Timer] in the [Rec] menu.

Taking pictures with self-timer

4 Press the shutter button halfway to focus, and press it fully to start recording

- The focus and exposure are fixed when the shutter button is pressed halfway.
- After the self-timer indicator flashes, recording will start.



ZS100

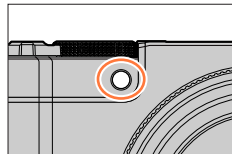

ZS60

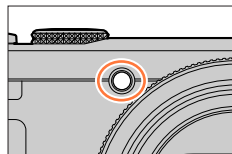

■ To cancel self-timer

In step 2, select [□] ([Single]) or [OFF].

- You can cancel the self-timer by turning off the camera. (When [Self Timer Auto Off] (→85) is set to [ON].)
- If you take a picture with a flash when [] is set, the flash output may not be stable in some cases.
- It cannot be set to [] in the following cases:
 - When White Balance Bracket is set
 - When recording using [Post Focus]
 - **ZS100** During T (Time) recording
 - **ZS100** When [Multi Exp.] is set
 - When [Simultaneous record w/o filter] of [Filter Settings] is set to [ON]
- This function is not available in the following cases:
 - During motion picture recording
 - When using [Time Lapse Shot]
 - When [Auto Shooting] of [Stop Motion Animation] is set to [ON]

Saving a picture by selecting a focus point after recording [Post Focus]

Recording mode: **PAS**

You can record bursts of photos with the same quality as a 4K photo while automatically changing the focus point ([Post Focus] recording). After recording, you can select a point on the screen to save a picture with that point as the focus point.

This function is best for non-moving subjects.



4K burst recording with automatic focus shift

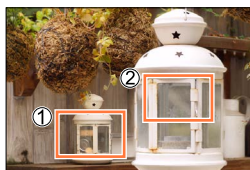

Touch the desired focus point



Finished picture has the desired focus point

- To record pictures, use a UHS Speed Class 3 card. (→37)
- During recording, the angle of view will be narrower.

Recording using [Post Focus]

1 Press button

2 Press to select [ON] and press [MENU/SET]

- It can also be set by going to the [Rec] menu and selecting [ON] for [Post Focus].

[Post Focus] icon



3 Determine the composition and press the shutter button halfway

- Auto Focus activates and automatically detects the focus point on the screen.
- If there is no focus point on the screen, the Focus indicator (●) blinks and you cannot record.

From halfway pressing the shutter button to completion of recording

- Do not change the distance to subject or the composition.



Saving a picture by selecting a focus point after recording [Post Focus]

4 Press the shutter button fully to start recording

- The focus point changes automatically while recording. When the recording progress bar disappears, recording automatically ends.
- A motion picture will be recorded in MP4 format. (No audio is recorded.)
- If Auto Review is set, a screen will automatically appear that lets you select the focus point. Refer to (→214).
To record continuously, press the shutter button halfway to display the recording screen.

Recording progress bar



- To learn how to save pictures from images recorded using [Post Focus], refer to (→214).

■ Canceling [Post Focus]

Select [OFF] in step 2.

- You can also cancel the [Post Focus] by selecting [OFF] of [Post Focus] in [Rec] menu.

**About camera temperature**

If the surrounding temperature is high, or [Post Focus] recording is performed continuously, or the temperature of the camera rises, [△] may be displayed and recording may be stopped halfway through to protect the camera. Wait until the camera cools down.

■ Limitations in [Post Focus] recording



Certain limitations apply to some recording functions, menu items and other settings.

- The following settings are fixed.

[Picture Size]	[4K] (8M) • Following picture sizes will be applied: [4:3]: 3328×2496 [3:2]: 3504×2336 [16:9]: 3840×2160 [1:1]: 2880×2880
[Quality]	[]
[Shutter Type]	[ESHTR]
[Rec Format]	[MP4]
[Rec Quality]	[4K/100M/30p]
[Continuous AF]	[ON]

Saving a picture by selecting a focus point after recording [Post Focus]

- The following limitations apply to the recording functions indicated below.

Program Shift	x
Exposure compensation	-3 EV to +3 EV
Shutter speed	1/30 to 1/16000
[AFS/AFF/AFC]	
[AF Mode]	
Manual Focus operation	-
White Balance ([]), White Balance Bracket	
ISO sensitivity	ZS100 [AUTO], 125 to 6400 ZS60 [AUTO], 80 to 3200
Flash	-
Motion picture recording	
Drive Mode	[Single], [Self Timer] ([] or [])

- The following menu items are disabled.

[Rec]	[Picture Size], [Quality], [AF Mode], [AFS/AFF/AFC], [iHandheld Night Shot], [iHDR], [HDR], [Panorama Settings], [Shutter Type], [Flash]*1, [Flash Adjust.]*2, [Extended ISO], [Long Shtr NR]*1, [Digital Zoom], [Color Space]*1, [Face Recog.], [Profile Setup]
[Motion Picture]	All items
[Custom]	[Shutter AF], [Focus/Release Priority], [Rec Area], [Remaining Disp.]

*1 **ZS100**

*2 **ZS60**

Saving a picture by selecting a focus point after recording [Post Focus]

- The following changes occur when [Post Focus] recording:
 - The [i.Resolution] setting changes from [EXTENDED] to [LOW].
 - [Destination] in [Travel Date] cannot be recorded.
 - [Simultaneous record w/o filter] is not available.
 - It is not possible to use the HDMI output.
- Scene Detection in Intelligent Auto Mode works the same way as when recording motion pictures.
- The [Post Focus] function is disabled when using the following settings:
 - [Clear in Backlight], [Glistening Water], [Artistic Nightscape], [Glittering Illuminations], [Handheld Night Shot], [Clear Night Portrait], [Soft Image of a Flower] (Scene Guide Mode)
 - [Rough Monochrome], [Silky Monochrome], [Miniature Effect], [Soft Focus], [Star Filter], [Sunshine] (Creative Control Mode)
 - **ZS100** When [Multi Exp.] is set
 - When using [Time Lapse Shot]
 - When using [Stop Motion Animation]



Saving a picture by selecting a focus point after recording [Post Focus]





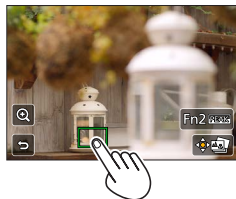

Select the focus point and save the picture**1 On the playback screen, select the image with the [▲▶] icon and press ▲**

- The same operation can be performed by touching [▲▶].

**2 Select the focus point by touching it**

- The picture will be displayed with the focus on the selected point.
- If there are no pictures with the focus on the selected point, a red frame will be displayed, and pictures cannot be saved.
- The edge of the screen cannot be selected.
- To make slight adjustments to focus, refer to (→215).



Operation	Touch operation	Description
ZS100  ZS60 	▲▼◀▶	Select focus point • No selection can be made while display is enlarged.
		Enlarge display
		Shrink display (when in enlarged display)
[Fn2]		Highlight in-focus portion with color (peaking) (→215)
[MENU/SET]		Save picture

3 Touch [▶] to save the picture

- The picture will be saved in JPEG format.
- After saving, return to step 2.

- You cannot choose and save the picture from a TV screen even if the camera is connected to a TV through an HDMI micro cable.



Saving a picture by selecting a focus point after recording [Post Focus]

Making fine adjustments to focus

You can enlarge and make fine adjustments to the focus of the picture that you touched to display in Step 2 of "Select the focus point and save the picture" (→214)

1 Touch [Q]

- The picture can be enlarged.

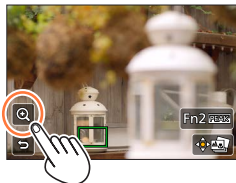

2 Drag the slide bar to make fine adjustments to focus

- The same operation can be performed using ◀▶.

3 Touch [⊞] to save the picture

- The screen returns to step 1.

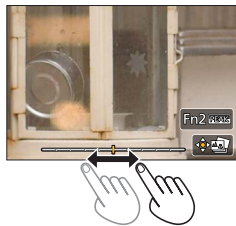

Highlight in-focus portion with color (peaking)

You can check the degree of focus by setting the detection level for the in-focus portion and highlighting it with color.

1 Touch [PEAK]

- Each time the icon is touched, the setting is switched in order of [PEAK L] ([Detect Level]: [LOW]) → [PEAK H] ([Detect Level]: [HIGH]) → [OFF].
- The display color will be the same as set in [Peaking] under the [Custom] menu. (→172)



Taking pictures automatically at set intervals

[Time Lapse Shot]

Recording mode: **PAS**

You can preset data such as recording start time and time lapse to take still pictures automatically. This setting is convenient for taking pictures at constant intervals for landscape scenes, observation of the gradual changes in animals/plants, and other applications. The pictures are recorded as a set of group pictures (→275). When [Time Lapse Video] in the [Playback] menu is used, you can create a motion picture. (→293)

- Complete the date and time settings in advance. (→42)

1 Set the menu

MENU → **[Rec]** → **[Time Lapse Shot]**

2 Press ▲ ▼ to select the item and press [MENU/SET]

[Start Time]	[Now]	Starts the recording by fully-pressing the shutter button.
	[Start Time Set]	Set the time to start recording. Any time up to 23 hours 59 minutes ahead can be set. Press ◀▶ to select the item (hour and/or minute), and ▲ ▼ to set the start time, and press [MENU/SET]
[Shooting Interval] / [Image Count]	The recording interval and the number of pictures can be set. ◀▶ : Select the item (minute/second/number of pictures) ▲ ▼ : Setting [MENU/SET]: Set	
	<ul style="list-style-type: none"> • You can set the interval from 1 second to 99 minutes 59 seconds in 1-second intervals. • You can set the number of pictures to be recorded from 1 picture to 9,999 pictures. <hr/> <ul style="list-style-type: none"> • Be sure to use an interval (A) setting that is longer than the exposure time (shutter speed) (B). (Illustration below) If the interval (A) setting is shorter than the exposure time (shutter speed) (B) (e.g. recording at night), it may cause the recording to skip. <div style="text-align: center;"> </div> <ul style="list-style-type: none"> • The camera may not be able to record using the preset interval and number of pictures to be recorded under some recording conditions. 	



3 Press ▲ ▼ to select [Start] and press [MENU/SET]



Taking pictures automatically at set intervals [Time Lapse Shot]

4 Press the shutter button fully

- The recording starts automatically.
- During recording standby, the camera turns off automatically when no operation is performed for a preset interval. The [Time Lapse Shot] recording will continue even if the camera is turned off, and the camera is automatically turned on at the recording start time. If you want to turn on the camera manually, press the shutter button halfway.
- Operations during recording standby (The camera is turned on)

Operation	Touch operation	Description
[Fn1]		Displays a selection screen that lets you pause or stop the recording
		Displays a selection screen that lets you resume or stop the recording (during pause)

5 Select the motion picture creation method

- [Rec Format]: [MP4]

[Rec Quality]	Sets the picture quality of the motion picture. [4K/30p] / [4K/24p] ^{*1} / [FHD/60p] / [FHD/30p] / [HD/30p] / [VGA/30p] ^{*1} ZS100
[Frame Rate]	Set the number of frames per second. When you set a higher number, you can create a more seamless animation. [60fps] ^{*2} / [30fps] / [15fps] / [10fps] / [7.5fps] / [6fps] / [3fps] / [1fps] ^{*2} Only available with [FHD/60p] setting • ZS100 You can set the number of frames to [24fps], [12fps], [8fps], [6fps], [4.8fps], [2.4fps], or [1fps] when [Rec Quality] is set to [4K/24p].
[Sequence]	[NORMAL]: Stitches the still pictures in the recording sequence. [REVERSE]: Stitches the still pictures in the reverse order of recording.

6 Use ▲ ▼ to select [OK] and press [MENU/SET]

- You can also create a motion picture using [Time Lapse Video] in the [Playback] menu. (→293)

Taking pictures automatically at set intervals [Time Lapse Shot]

- This function is not intended for application-specific systems (monitoring cameras).
- **If you leave the camera unattended during [Time Lapse Shot] recording, make sure that the camera is not stolen.**
- **Exercise caution when you perform [Time Lapse Shot] recording for a long period of time in cold regions or in a low-temperature or high-temperature/high-humidity environment, since such use could cause malfunctions.**
- Use a sufficiently charged battery or an AC adaptor (optional) and DC coupler (optional).
- When using zoom, the camera could tilt when the lens barrel extends. Make sure to secure the camera in place with a tripod or by other means.
- [Time Lapse Shot] is paused in the following cases:
 - When the remaining battery power runs out
 - Turning the camera off
 If this occurs during [Time Lapse Shot] recording, you can restart the operation by replacing the battery or card in the pause state and turning the camera on. (Note, however, that the pictures recorded after restarting the operation are saved as a separate set of group pictures.) When you replace the battery or card, turn the camera off.
- Do not connect the HDMI micro cable or USB connection cable during [Time Lapse Shot] recording.
- When you select the picture quality for an aspect ratio that is different from the original picture, the picture will be displayed with a black band on the upper/lower side or the left/right side of a stop motion animation.
- If the power supply is cut off due to a power outage or AC adaptor disconnection while a motion picture is being recorded using the AC adaptor (optional), that motion picture will not be recorded.
- **ZS100**
When creating motion pictures at a picture quality setting of [4K/30p] or [4K/24p], recording times are limited to 29 minutes and 59 seconds.
- **ZS60**
When creating motion pictures at a picture quality setting of [4K/30p], recording times are limited to 29 minutes and 59 seconds.
- If using an SDHC Memory Card, you will not be able to create motion pictures with a file size greater than 4 GB. With an SDXC Memory Card, you can create motion pictures with a file size greater than 4 GB.
- When creating a motion picture with a picture quality setting of [FHD/60p], [FHD/30p], [HD/30p], or [VGA/30p], you will be unable to create it if the recording time is more than 29 minutes and 59 seconds or the file size is greater than 4 GB.
- If only one still picture is recorded, it will not be recorded as a group picture.
- This function is not available in the following cases:
 - [Handheld Night Shot] (Scene Guide Mode)
 - **ZS100** When [Multi Exp.] is set
 - When using [Stop Motion Animation]



Creating stop motion animation [Stop Motion Animation]

Recording mode: **PASM**

You can stitch still pictures to create stop motion animation.

- **Complete the date and time settings in advance.** (→42)
- Still pictures that were captured using frame-by-frame recording are grouped into a single picture group. (→275)



Before creating stop motion animation

When you use [Stop Motion Animation] to record still pictures by moving a subject such as a doll little by little and then stitching those pictures, you can create a stop motion animation as if the subject is moving.

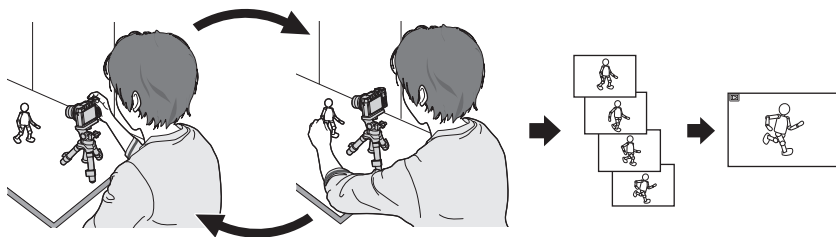

- To create stop motion animation using this camera, it is necessary to record 1 to 60 frames of still pictures for every 1 second of motion picture.
- To produce smooth movement of the subject, record the motion using as many frames as possible and set a higher number of frames per second (frame rate) when you create a stop motion animation.

1 Set the menu

MENU → **[Rec]** → **[Stop Motion Animation]**

2 Press **▲▼** to select the recording method, and press **[MENU/SET]**

[Auto Shooting]	[ON]	Takes pictures automatically at a set recording interval.
	[OFF]	Takes pictures manually, one frame at a time.
[Shooting Interval]	(Only when [Auto Shooting] is set to [ON]) Set the interval used for [Auto Shooting]. You can set the interval from 1 second to 60 seconds in 1-second intervals.	

3 Press **▲▼** to select **[Start]** and press **[MENU/SET]**

Creating stop motion animation [Stop Motion Animation]

4 Press ▲▼ to select [New] and press [MENU/SET]

5 Press the shutter button fully

- Up to 9,999 frames can be recorded.

6 Move the subject to decide on the composition

- Repeat the recording of still pictures in the same way.
- When you turn off the camera during recording, a message to restart recording will appear when you turn on the camera. To start recording from the next still picture, select [Yes].



How to create stop motion animation effectively

- Up to two previously recorded pictures are displayed on the recording screen. Check this screen as a guideline for determining the amount of required motion.
- You can press the Playback button to check the recorded pictures. Press the [Q.MENU/↵] button to delete unnecessary pictures. To return to the recording screen, press the Playback button again.

7 Touch [] to end the recording

- You can also end the recording by selecting [Stop Motion Animation] in the [Rec] menu, and then pressing [MENU/SET].
- When [Auto Shooting] is set to [ON], select [End] on the confirmation screen. (If you select [Pause], press the shutter button fully to resume recording.)

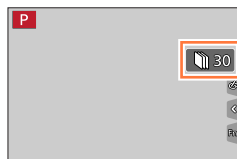

Creating stop motion animation [Stop Motion Animation]

8 Select a method to create a stop motion animation

- [Rec Format]: [MP4]

[Rec Quality]	Sets the picture quality of the motion picture. [4K/30p] / [4K/24p] ^{*1} / [FHD/60p] / [FHD/30p] / [HD/30p] / [VGA/30p] ZS100
[Frame Rate]	Set the number of frames per second. When you set a higher number, you can create a more seamless animation. [60fps] ^{*2} / [30fps] / [15fps] / [10fps] / [7.5fps] / [6fps] / [3fps] / [1fps] ^{*2} Only available with [FHD/60p] setting • ZS100 You can set the number of frames to [24fps], [12fps], [8fps], [6fps], [4.8fps], [2.4fps], or [1fps] when [Rec Quality] is set to [4K/24p].
[Sequence]	[NORMAL] : Stitches the still pictures in the recording sequence. [REVERSE] : Stitches the still pictures in the reverse order of recording.

9 Press ▲ ▼ to select [OK] and press [MENU/SET]

- You can also create a stop motion animation using [Stop Motion Video] in the [Playback] menu. (→293)

■ Adding pictures to an already recorded stop motion animation group

When you select [Additional] in step 4, group pictures recorded using [Stop Motion Animation] are displayed. Select a set of group pictures and press [MENU/SET]. Then, select [Yes] on the confirmation screen.

Creating stop motion animation [Stop Motion Animation]

- [Auto Shooting] may not be performed according to the preset interval because recording could take time under some recording conditions, such as when pictures are taken using a flash.
- When you select the picture quality for an aspect ratio that is different from the original picture, the picture will be displayed with a black band on the upper/lower side or the left/right side of a stop motion animation.
- Use a sufficiently charged battery or an AC adaptor (optional) and DC coupler (optional).
- If the power supply is cut off due to a power outage or AC adaptor disconnection while a motion picture is being recorded using the AC adaptor (optional), that motion picture will not be recorded.
- **ZS100**
 - When creating motion pictures at a picture quality setting of [4K/30p] or [4K/24p], recording times are limited to 29 minutes and 59 seconds.
- **ZS60**
 - When creating motion pictures at a picture quality setting of [4K/30p], recording times are limited to 29 minutes and 59 seconds.
 - If using an SDHC Memory Card, you will not be able to create motion pictures with a file size greater than 4 GB. With an SDXC Memory Card, you can create motion pictures with a file size greater than 4 GB.
 - When creating a motion picture with a picture quality setting of [FHD/60p], [FHD/30p], [HD/30p], or [VGA/30p], you will be unable to create it if the recording time is more than 29 minutes and 59 seconds or the file size is greater than 4 GB.
 - If only one still picture is recorded, it will not be recorded as a group picture. You cannot select only one recorded still picture using [Additional].
 - This function is not available in the following cases:
 - **ZS100** When [Multi Exp.] is set
 - When using [Time Lapse Shot]
 - [Auto Shooting] in [Stop Motion Animation] cannot be used in the following case:
 - [Handheld Night Shot] (Scene Guide Mode)

ZS100 Performing multiple exposures for a single picture [Multi Exp.]

Recording mode: **PASM**

You can create an effect similar to the operation of up to four times of exposure on a single picture.

1 Set the menu

MENU → [Rec] → [Multi Exp.]

2 Press ▲ ▼ to select [Start] and press [MENU/SET]

3 Decide on your composition and take the first picture

- After recording the first picture, press the shutter button halfway to proceed to the next recording.
- Press ▲ ▼ to select the item and press [MENU/SET]. You can perform the following operations.
 - [Next]: Proceed to the next recording.
 - [Retake]: Delete the result of the last shot and take another picture.
 - [Exit]: Exit Multi Exposure and save the picture that was taken.

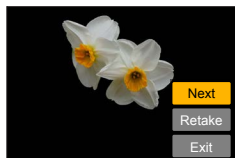

4 Record the second, third, and fourth pictures

- When you press [Fn1] button while taking pictures, the pictures that you took are saved and Multi Exposure is closed.

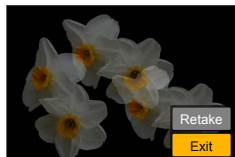

5 Press ▼ to select [Exit] and press [MENU/SET]

- You can also end the operation by pressing the shutter button halfway.

Performing multiple exposures for a single picture [Multi Exp.]

■ About the automatic gain compensation setting

Select [Auto Gain] on the screen in step **2** of “Performing multiple exposures for a single picture” (→223).

- **[ON]:** Combines several pictures into one by automatically adjusting the brightness in accordance with the number of pictures taken.
- **[OFF]:** Combines several pictures into one by simply overlapping the exposure results of all pictures, as is. Perform the Exposure Compensation based on the requirements of a subject.

■ To overlay the pictures on the RAW file picture in a card

Set [Overlay] to [ON] on the screen in step **2** of “Performing multiple exposures for a single picture” (→223). After selecting [Start], the pictures on a card will be displayed. Select the RAW file pictures and press [MENU/SET] to continue recording.

- You can perform [Overlay] on RAW file pictures recorded using this camera only.

- Pictures are not saved in memory until Multi Exposure is ended.
- Information for the picture taken last will be used as recording information of pictures taken using Multi Exposure.
- While [Multi Exp.] recording is being performed, you cannot set items displayed in gray on the menu screen.
- This function is not available in the following cases:
 - When using [Time Lapse Shot]
 - When using [Stop Motion Animation]

Disabling the beeps and flash at the same time

[Silent Mode]

Recording mode: **PAS**

This mode is useful when you are taking pictures in a quiet environment or public facilities or when you take pictures of a subject such as a baby or animal.

1 Set the menu

MENU → [Custom] → [Silent Mode]

Settings: [ON] / [OFF]

- This mode will mute beeps, set the flash to [] (Forced Flash Off), and disable AF Assist Lamp. The settings for the following functions are fixed:
 - [Shutter Type]: [ESHTR]
 - Flash: [] (Forced Flash Off)
 - [AF Assist Lamp]: [OFF]
 - [Beep Volume]: [] (Off)
 - [Shutter Vol.]: [] (Off)

- Even when this mode is set to [ON], the following lamps/indicators will light or flash.
 - Self-timer indicator
 - Wi-Fi connection lamp
- The operation sounds of this camera such as the lens aperture sound are not muted.
- **If you take a picture of a moving subject using the electronic shutter, the subject in the picture may be skewed in some cases.**
- **When you take a picture under a fluorescent or LED lighting fixture using the electronic shutter, the recorded picture may have horizontal stripes. If you use a slower shutter speed, the horizontal stripes may be reduced. (→102)**

Recording with the Face Recognition function

[Face Recog.]

Recording mode:

The Face Recognition function recognizes a face similar to a registered face and automatically adjusts focus and exposure for the face with higher priority. Even if a person you want to focus on is standing at the back or corner in a group photo, the camera will automatically recognize the person and record this person's face clearly.

1 Set the menu

MENU → [Rec] → [Face Recog.]

Settings: [ON] / [OFF] / [MEMORY]

Default [Face Recog.] setting is [OFF].

When the face pictures are registered, the setting will be [ON] automatically.

■ How the Face Recognition function works

During recording

- The camera recognizes a registered face and adjusts focus and exposure.
- When registered faces that have set names are recognized, the names are displayed (max. 3 people).

During playback

- The name and age are displayed (if information is registered).
- The names that have been set for the recognized faces are displayed (max. 3 people).
- Only pictures of the selected registered people are played back ([Category Play]).



- **[Face Recog.] functions only when Auto Focus mode is set to .**
- Only the first picture of the burst recording will contain Face Recognition information.
- The name of the person recognized in the first picture is displayed in the case of group pictures.
- Face Recognition may take more time to select and recognize distinctive facial features than regular Face/Eye Detection.
- Face Recognition searches for faces similar to those registered, but there is no guarantee it will always recognize these faces. In some cases, the camera cannot recognize or incorrectly recognizes even registered people depending on their expression or the environment.
- Even if Face Recognition information is registered, pictures recorded when the name is [OFF] are not categorized for Face Recognition in [Category Play].
- **Even if Face Recognition information is changed, Face Recognition information for previously recorded pictures is not changed. (→228)**
For example, if a name is changed, pictures recorded before the change are not categorized for Face Recognition in [Category Play].
- To change name information for pictures already recorded, perform a [REPLACE] (→299) in [Face Rec Edit].

Recording with the Face Recognition function [Face Recog.]

● This function is not available in the following cases:

- [Miniature Effect] (Creative Control Mode)
- During motion picture recording
- When recording 4K photos
- When recording using [Post Focus]
- When using [Time Lapse Shot]

Registering face pictures

Up to 6 people's face pictures can be registered along with such information as name and birthdate.

■ Recording tips when registering face pictures

- Make sure the subject's eyes are open and mouth closed; have the subject face the camera directly, and make sure the outline of the face, the eyes and eyebrows are not hidden by hair.
- Make sure there are no heavy shadows on the face. (During registration, the flash is not used.)

Good example for registering a face



■ If the camera seems to have difficulty recognizing faces when recording

- Register additional pictures of the same person's face, indoors and outdoors or with different expressions or angles.
- Register additional pictures at the place you are recording.
- If a registered person is no longer recognized, re-register that person.

1 Use ▲ ▼ to select [MEMORY] and press [MENU/SET]

2 Use ▲ ▼ ◀ ▶ to select [New] and press [MENU/SET]

- If 6 people are already registered, first delete a registered person. (→228)

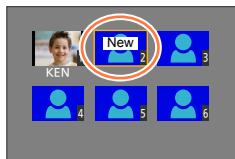

3 Align the face with the guide and record

- Faces of subjects other than people (e.g. pets) cannot be registered.
- When ▶ is pressed or [f] is touched, an explanation is displayed.

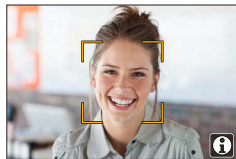

Recording with the Face Recognition function [Face Recog.]

4 Use ▲ ▼ to select the item for editing and press [MENU/SET]

[Name]	① Use ▼ to select [SET] and press [MENU/SET] ② Enter the name (See "Entering Text": (→87))
[Age]	Set the birthdate. ① Use ▼ to select [SET] and press [MENU/SET] ② Use ◀▶ to select year, month and day, set with ▲ ▼, and press [MENU/SET]
[Add Images]	Up to 3 face pictures of the person can be registered. ① Use ◀▶ to select [Add] and press [MENU/SET] <ul style="list-style-type: none"> • If only one picture is registered, you can skip the cursor button operation. Just press [MENU/SET] to register an additional face picture. • When a registered face picture is selected with cursor button, a screen to confirm deletion is displayed. Select [Yes] to delete the face picture. ② Record the picture (step 3 (→227))

Editing or deleting information about registered persons**1 Use ▼ to select [MEMORY] and press [MENU/SET]****2 Use ▲ ▼ ◀▶ to select the picture of the person to be edited or deleted and press [MENU/SET]****3 Use ▲ ▼ to select the item and press [MENU/SET]**

[Info Edit]	Edit name or other registered information. (Step 4 above)
[Priority]	Set priority order for focus and exposure. ① Use ▲ ▼ ◀▶ to select the registration order and press [MENU/SET]
[Delete]	Delete information and face pictures of registered persons.

Setting the profile for a baby or pet to record in a picture

Recording mode: **PAS**

You can set a name or birthday of a baby or pet before taking a picture to record the name or age in months/years in the picture.

■ Setting the name and age in months/years

① Set the menu

MENU → **[Rec]** → **[Profile Setup]**

Settings: [¹] ([Baby1]) / [²] ([Baby2]) / [] ([Pet]) / [OFF] / [SET]

② Use ▼ to select [SET] and press [MENU/SET]

③ Use ▲▼ to select [Baby1], [Baby2] or [Pet] and press [MENU/SET]

④ Use ▲▼ to select [Age] or [Name] and press [MENU/SET]

⑤ Use ▲▼ to select [SET] and press [MENU/SET]

Age: Use ◀▶ to select year, month and day, set with ▲▼, and press [MENU/SET]

Name: (See "Entering Text": (→87))

⑥ Use ▼ to select [Exit] and press [MENU/SET] to finish

■ Canceling the display of the name and age in months/years

Select [OFF] in step ①.

- [Name] and [Age] print settings can be made on your computer using "PHOTOfunSTUDIO" software, which you download from a website (→353). Text may also be stamped onto the still picture using the camera's [Text Stamp].
- [Profile Setup] is not available for 4K photo recording or recording in [Post Focus].
- You cannot record the name or age in months/years in the following cases:
 - During motion picture recording
 - Still pictures that are taken while recording motion pictures (→261)

Displaying the appropriate screen for specific recording conditions

Checking the area where overexposure may occur ([Zebra Pattern])

Recording mode:

You can check the area in a picture that is brighter than a certain brightness, which could result in overexposure, by displaying such an area using a zebra pattern. You can also set the brightness to be represented by the zebra pattern.

MENU → **fC** [Custom] → [Zebra Pattern]

[ZEBRA1]	Displays an area brighter than a certain brightness using a right-leaning zebra pattern.	
[ZEBRA2]	Displays an area brighter than a certain brightness using a left-leaning zebra pattern.	
[OFF]	—	
[SET]	<p>Sets the brightness to be displayed for each zebra pattern. [Zebra 1] / [Zebra 2]</p> <p>1 Use ▲ ▼ to select the brightness and press [MENU/SET]</p> <ul style="list-style-type: none"> The range of brightness you can select from is [50%] to [105%]. The [OFF] setting is available for [Zebra 2]. When [100%] or [105%] is selected, only the overexposed areas are displayed with the zebra pattern. When a smaller numeric value is set, the range of brightness to be displayed by each zebra pattern will increase. 	

- If there is overexposure, we recommend taking pictures using a lower exposure value (→177), using the histogram (→55) as a guideline.
- The displayed zebra pattern is not recorded.
- If you set [Zebra Pattern] to [Fn Button Set] (→70) in the [Custom] menu, every time you press the assigned function button the setting will switch in the following order: [Zebra 1] → [Zebra 2] → [Zebra OFF]. When [Zebra 2] is set to [OFF], you can switch the setting quickly in the following order: [Zebra 1] → [Zebra OFF].



Displaying the appropriate screen for specific recording conditions

Setting a monochrome display for the recording screen ([Monochrome Live View])

Recording mode:   **P** **A** **S** **M**  **C**  

You can display the recording screen in black and white. This function is useful when a black and white screen will make it easier to adjust focus in Manual Focus mode.

MENU →  [Custom] → [Monochrome Live View]

Settings: [ON] / [OFF]

- **ZS100**
Even if you use the HDMI output during recording, this function will not work for the connected device.
- This does not affect recorded pictures.

ZS100 Recording while monitoring camera images

Recording mode: 

When using the HDMI output, you can take pictures while monitoring the camera image on a TV, etc.



■ To connect with an HDMI micro cable

Check the plug direction and insert it straight in. (If the cable is inserted in the wrong direction, the plug could become deformed and cause faulty operation.) Also, do not insert into the wrong socket. Doing so may cause damage to this unit.

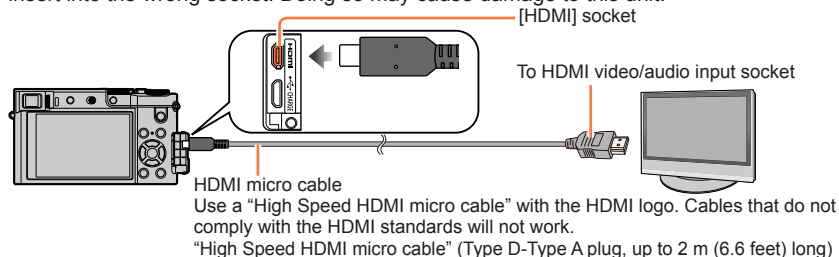

■ Switching the information displayed

You can change the display shown during HDMI output using [HDMI Info Display (Rec)] (→83) in [TV Connection] on the [Setup] menu.

[ON]: The camera display is output as is.

[OFF]: Only images are output.

Recording while monitoring camera images

- When using the Auto Focus Mode [\square +] or MF assist, the screen cannot be enlarged in windowed mode.
- [Aspect Ratio] in the [Rec] menu is fixed to [16:9].
- An electronic sound or shutter sound will not sound.
- If you set up a Wi-Fi connection while using the HDMI output, no image will be displayed on the camera monitor.
- The scene selection screen in Scene Guide Mode is not output through the HDMI connection.
- This function is not available in the following cases:
 - During motion picture recording
 - During panorama picture recording
 - When recording 4K photos
 - When recording using [Post Focus]



Correcting jitter

Recording mode: **PAS**

Automatically detects and prevents jitter.

1 Set the menu

MENU → **[Rec]** → **[Stabilizer]**

2 Use ▲ ▼ to select the item and press [MENU/SET]

(Normal)	Corrects vertical and horizontal jitter.
(Panning)	Corrects vertical jitter. This setting is ideal for panning (technique of recording a subject by matching the camera movement with the movement of a subject going in a specific direction). We recommend using the Viewfinder.
[OFF]	[Stabilizer] does not work.







To prevent jitter

If a warning is displayed about jitter, use [Stabilizer], a tripod, or [Self Timer].

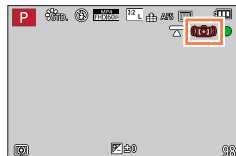
- Shutter speed will be slower particularly in the following cases. Keep the camera still from the moment the shutter button is pressed until the picture appears on the screen. We recommend using a tripod.

- [Slow Sync.]
- [Slow Sync./Red-Eye]
- [Clear Nightscape], [Cool Night Sky], [Warm Glowing Nightscape], [Artistic Nightscape], [Glittering Illuminations], [Clear Night Portrait] (Scene Guide Mode)
- When the shutter speed is slowed



- When you use a tripod, we recommend setting [Stabilizer] to [OFF].  is displayed on the screen at that time.
- [Stabilizer] cannot be used by selecting  (Normal) in Panorama Shot Mode.
- In the following cases, the [Stabilizer] will switch to  (Normal), even if it is set to  (Panning):
 - During motion picture recording
 - When 4K Photo function has been set
 - When recording using [Post Focus]
- [Stabilizer] cannot be used when recording high-speed motion pictures.
- The 5-axis Hybrid Image Stabilizer function automatically functions while recording motion pictures. This decreases the jitter of the image when recording motion pictures while zooming or walking, etc.
 - The recording range may become narrower.
 - If you record an [MP4] motion picture with the [Rec Quality] set to [VGA/4M/30p], the stabilizer function may be weaker compared to other picture quality settings.
 - **ZS100**
The 5-axis Hybrid Image Stabilizer function is not available when recording motion pictures for which [Rec Quality] is set to either [4K/100M/30p] or [4K/100M/24p].
 - **ZS60**
The 5-axis Hybrid Image Stabilizer function is not available when recording motion pictures for which [Rec Quality] is set to [4K/100M/30p].
- Cases where the stabilizer function may be ineffective:
 - When there is a lot of jitter
 - When the zoom magnification is high (also in the Digital Zoom range)
 - When taking pictures while following a moving subject
 - When the shutter speed becomes slower to take pictures indoors or in dark places
- The panning effect by selecting  is not fully achieved in the following cases:
 - Bright summer days or other bright locations
 - When the shutter speed is higher than 1/100 seconds
 - When the motion of a subject is slow and the speed with which the camera is moved is too slow (a nice background blur is not achieved)
 - When the camera is not adequately tracking the motion of a subject



Using Zoom

Zoom types and use

The zoom ratio changes when the picture size is changed.

Optical Zoom

Recording mode: **PAS**

You can zoom in without degrading the picture quality.

Maximum magnification: **ZS100** 10x
ZS60 30x

- This function is not available in the following case:
 - When recording with [Macro Zoom]

Extended optical zoom

Recording mode: **PAS**

This function works when picture sizes with [EX] have been selected in [Picture Size] (→139). Extended optical zoom allows you to zoom in using a higher zoom ratio than Optical Zoom, without degrading the picture quality. The maximum zoom ratio varies depending on the picture size.

Maximum magnification: **ZS100** 20x
ZS60 61.2x

- This function is not available in the following cases:
 - [Toy Effect], [Toy Pop] (Creative Control Mode)
 - [Handheld Night Shot] (Scene Guide Mode)
 - When recording 4K photos
 - When [Burst Rate] is set to [SH]
 - When [HDR] is set to [ON]
 - **ZS100** When [Multi Exp.] is set
 - When [iHandheld Night Shot] is set to [ON]
 - When [iHDR] is set to [ON]
 - When [Quality] is set to [RAW], [RAW] or [RAW]
 - When recording with [Macro Zoom]
 - During motion picture recording





To increase the zoom ratio further, the following zoom can be used in combination.

[i.Zoom]

Recording mode:   **P** **A** **S** **M**  **C**  

You can use the camera's Intelligent Resolution technology to increase the zoom ratio up to 2x higher than the original zoom ratio with limited deterioration of picture quality.

MENU →  **[Rec]** /  **[Motion Picture]** → **[i.Zoom]** → **[ON]** / **[OFF]**

- This function is not available in the following cases:
 - [Impressive Art], [Toy Effect], [Toy Pop] (Creative Control Mode)
 - [Handheld Night Shot] (Scene Guide Mode)
 - During [Macro Zoom] recording
 - When [Burst Rate] is set to [SH]
 - When [HDR] is set to [ON]
 - **ZS100** When [Multi Exp.] is set
 - When [iHandheld Night Shot] is set to [ON]
 - When [iHDR] is set to [ON]
 - When [Quality] is set to [RAW , [RAW , or [RAW]



[Digital Zoom]

Recording mode: **PAS**

Zoom 4x further than Optical/Extended optical zoom. When [Digital Zoom] is used simultaneously with [i.Zoom], you can only increase the zoom ratio up to 2x. Note that, with Digital Zoom, enlarging will decrease picture quality.

MENU → **[Rec]** / **[Motion Picture]** → **[Digital Zoom]** → **[ON]** / **[OFF]**

- When using [Digital Zoom], we recommend using a tripod and the self-timer (→208) for taking pictures.
- The AF area is largely displayed at the center in the Digital Zoom range.
- This function is not available in the following cases:
 - [Impressive Art], [Toy Effect], [Toy Pop], [Miniature Effect] (Creative Control Mode)
 - [Handheld Night Shot] (Scene Guide Mode)
 - When recording using [Post Focus]
 - When recording with [High Speed Video]
 - When [Burst Rate] is set to [SH]
 - When [HDR] is set to [ON]
 - **ZS100** When [Multi Exp.] is set
 - When [Quality] is set to [RAW], [RAW] or [RAW]

The illustration is an example of when using Optical Zoom, [i.Zoom], and [Digital Zoom] in Program AE Mode.

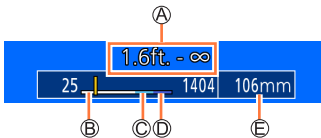

- (A) Focus range
- (B) Optical Zoom range
- (C) i.Zoom range
- (D) Digital Zoom range
- (E) Current zoom position (Focal lengths the same as those of a 35 mm film camera)

Changing the zoom operation settings

MENU → **fC** [Custom] → [Zoom lever]

Q (Zoom)	The zoom operates in the normal way.
Q (Step Zoom)	<p>Each time zoom is operated, the zoom stops at the position for one of the preset focal lengths.</p> <ul style="list-style-type: none"> This setting does not work when recording motion pictures or 4K photos with [4K] (4K Pre-Burst).  <p>The diagram shows a zoom scale with values 25, 28, 35, and 50. A red box highlights the range from 1.6ft. to infinity. A vertical orange line points to the value 28, labeled 'Current zoom position'. The entire scale is labeled 'Focus range'.</p>

- The zoom or step zoom setting can be assigned to the control ring. (→74, 75)

Retaining / not retaining the zoom position when the camera is turned off

MENU → **fC** [Custom] → [Zoom Resume] → [ON] / [OFF]

Using the zoom by performing touch operations (Touch zoom)

1 Touch [◀]

2 Touch [⏮]

- The slide bar is displayed.



3 Perform zoom operations by dragging the slide bar

- The zoom speed varies depending on the touched position.

[▼] / [▲]	Slow zooming
[⏮] / [⏭]	Fast zooming

- Touch [⏮] again to end touch zoom operations.

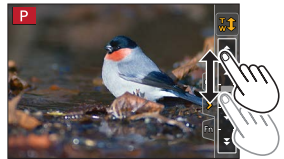

- When the zoom operation of the [Zoom lever] is set to Step Zoom (→239), a slide bar for step zoom appears.
- This function is not available in the following cases:
 - When [High Speed Video] is set
 - When recording 4K photos
 - When recording using [Post Focus]

Taking pictures with flash

Recording mode: **PAS**

With the flash you can take pictures in dark places or adjust the entire contrast of a picture by illuminating a subject with a bright background.

ZS100 Open/Close the built-in flash

A To open the flash
Slide the flash open lever.

- Be careful when opening the flash as the flash will jump out.

B To close the flash
Press the flash until it clicks.

- Be careful not to catch a finger or any other part of your body or any object when you close the flash.
- Forcibly closing the flash can damage the camera.
- Be sure to close the built-in flash when not in use.
- The flash setting is fixed to while the flash is closed.

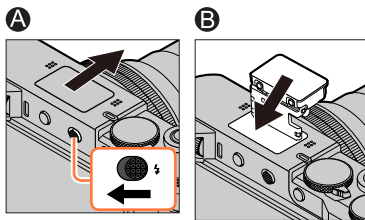

ZS60 Use / Do not use flash

You can record with flash as appropriate to the recording mode.
Setting the way the flash works ([→244](#))

If you do not wish to use flash,
press the button () and select (Forced Flash Off).

- The flash is fixed to (Forced Flash Off) in the following cases:
 - During motion picture recording
 - When recording 4K photos
 - When recording using [Post Focus]
 - When using the electronic shutter
 - When [HDR] is set to [ON]
 - When [Silent Mode] is set to [ON]
 - When a picture effect in [Filter Effect] of [Filter Settings] is set



About [ⓧ] (Forced Flash Off)

- When pictures cannot be taken using the flash because the flash is closed or during motion picture recording, etc., [ⓧ] (Forced Flash Off) is displayed on the recording screen and the flash will not fire.

ZS100

Close the flash in places where its use is prohibited so that it will not fire.

ZS60

Press **▶** and select [ⓧ] in places where its use is prohibited so that it will not fire.



How to use the flash effectively

Taking a picture using the flash with the subject too close may cause overexposure. When you set [Highlight] in the [Custom] menu to [ON], the overexposed areas will flash black and white during [Auto Review] or playback. If that happens, we recommend taking the picture again, for example, after setting a lower flash output using [Flash Adjust.] (→250).

■ The available flash range

Edges of a picture may become slightly dark if using flash at short distances without using zoom (close to max. Wide). This may be remedied by using a little zoom.

	Max. Wide	Max. Tele
ZS100	Approx. 0.6 m - 8.0 m (2.0 feet - 26 feet)	Approx. 0.7 m - 3.8 m (2.3 feet - 12 feet)
ZS60	Approx. 0.6 m - 5.6 m (2.0 feet - 18 feet)	Approx. 2.0 m - 2.9 m (6.6 feet - 9.5 feet)

- These ranges are obtained, the ISO sensitivity is set to [AUTO], and [ISO Limit Set] is set to [OFF].

- Avoid doing the following, as the heat or light could cause deformation or discoloration.
 - Putting the flash close to objects
 - Covering the flash with your hand as it is firing
 - **ZS100** Closing the flash as it is firing
- **ZS100**
Do not close the flash immediately after the preliminary flash is operated prior to taking pictures for Forced ON/Red-Eye Reduction and other flash settings. If you close the flash immediately, it will cause a malfunction.
- Flash charging may take time if battery is low or if using flash repeatedly. When the flash is being charged, the flash icon flashes red, and you cannot take a picture even when you fully press the shutter button.



Setting the Flash Functions

Changing Flash Mode

Set the flash to match the recording.

ZS100 Recording mode: **P** **A** **S** **M** **C** **SCN**

1 Set the menu

MENU → **[Rec]** → **[Flash]** → **[Flash Mode]**

2 Press ▲ ▼ to select the item and press [MENU/SET]

: [Forced Flash On]	Always takes pictures using the flash. • Ideal for taking pictures with a backlight or when a subject is located under bright lighting such as a fluorescent light.
: [Forced On/Red-Eye]*	
: [Slow Sync.]	When taking pictures against a dark background landscape, this feature will slow the shutter speed when the flash is activated. • Ideal for taking pictures of people against a nightscape. • Using a slower speed can cause motion blur. We recommend using a tripod.
: [Slow Sync./Red-Eye]*	

* **Two flashes will be emitted. Do not move until after the second flash. Interval between flashes varies according to brightness of subject.**

- The red-eye reduction effect varies depending on the subject and is affected by factors such as distance from the subject and whether the subject is looking at the camera during the preliminary flash. In some cases, red-eye reduction may be negligible.

Setting the Flash Functions

ZS60 Recording mode:

1 Press button (▶)

2 Use ◀▶ to select the desired type and press [MENU/SET]

A : [Auto] iA : iAuto*1	The flash is automatically activated when the recording conditions make it necessary.
A⊙ : [Auto/Red-Eye]*2	The flash fires automatically to control red eye according to recording conditions <ul style="list-style-type: none"> • Use this when you take pictures of people in low lighting conditions.
: [Forced Flash On] ⊙ : [Forced On/Red-Eye]*2	The flash is activated every time regardless of the recording conditions. <ul style="list-style-type: none"> • Use this when your subject is back-lit or under fluorescent light.
S : [Slow Sync.] S⊙ : [Slow Sync./Red-Eye]*2	Takes brighter pictures such as pictures of subjects against a nightscape by decreasing the shutter speed when firing a flash. <ul style="list-style-type: none"> • Ideal for taking pictures of people against a nightscape. • Using a slower speed can cause motion blur. We recommend using a tripod.
⊖ : [Forced Flash Off]	The flash is not activated in any recording conditions. <ul style="list-style-type: none"> • Use this when you take pictures in places where the use of the flash is not permitted.

*1 This can be set only in Intelligent Auto Mode [] or []. The icon changes depending on the type of subject and brightness.



*2 Two flashes will be emitted. Do not move until after the second flash. Interval between flashes varies according to brightness of subject.

- The red-eye reduction effect varies depending on the subject and is affected by factors such as distance from the subject and whether the subject is looking at the camera during the preliminary flash. In some cases, red-eye reduction may be negligible.



Setting the Flash Functions

■ Reducing red-eye

Recording mode:   **PAS**    **ZS100**

Automatically detects red-eye and corrects still picture data when recording with flash red-eye reduction ([], []).



ZS60

Automatically detects red-eye and corrects still picture data when recording with flash red-eye reduction ([], [] or []).

MENU →  **[Rec]** → **[Red-Eye Removal]**

Settings: **[ON]** / **[OFF]**

● **ZS100**

When this function is set to [ON], the flash icon changes to []/[].

● **ZS60**

When this function is set to [ON], the flash icon changes to []/[]/[].

● Depending on the circumstance, it may not be possible to correct red-eye.



Setting the Flash Functions

ZS100 Flash settings for each Recording mode (○: Available, –: Not available)

Recording mode					
Intelligent Auto Mode					–*
Intelligent Auto Plus Mode					–*
P Program AE Mode		○	○	○	○
A Aperture-Priority AE Mode		○	○	○	○
S Shutter-Priority AE Mode		○	○	–	–
M Manual Exposure Mode		○	○	–	–
M Creative Video Mode		–	–	–	–
Panorama Shot Mode		–	–	–	–
Creative Control Mode		–	–	–	–
Scene Guide Mode (●: Default settings)	[Clear Portrait]	○	●	–	–
	[Silky Skin]	○	●	–	–
	[Backlit Softness]	–	–	–	–
	[Clear in Backlight]	●	–	–	–
	[Relaxing Tone]	–	–	–	–
	[Sweet Child's Face]	○	●	–	–
	[Distinct Scenery]	–	–	–	–
	[Bright Blue Sky]	–	–	–	–
	[Romantic Sunset Glow]	–	–	–	–
	[Vivid Sunset Glow]	–	–	–	–
	[Glistening Water]	–	–	–	–
	[Clear Nightscape]	–	–	–	–
	[Cool Night Sky]	–	–	–	–
	[Warm Glowing Nightscape]	–	–	–	–
	[Artistic Nightscape]	–	–	–	–
	[Glittering Illuminations]	–	–	–	–
	[Handheld Night Shot]	–	–	–	–
	[Clear Night Portrait]	–	–	–	●
	[Soft Image of a Flower]	●	–	–	–
	[Appetizing Food]	●	–	–	–
	[Cute Dessert]	●	–	–	–
	[Freeze Animal Motion]	●	–	–	–
	[Clear Sports Shot]	●	–	–	–
	[Monochrome]	●	○	○	○

*The display will show when the flash is in use. (→90)

- When the built-in flash is closed, the display will show Forced Flash Off () regardless of flash setting.
- The Scene Guide Mode flash setting is returned to the initial value with each change of scene.

Setting the Flash Functions

ZS60 Flash settings for each Recording mode (○: Available, –: Not available)

Recording mode					
Intelligent Auto Mode			–*1		○
Intelligent Auto Plus Mode			–*1		○
P Program AE Mode	○	○	○	○	○
A Aperture-Priority AE Mode	○	○	○	○	○
S Shutter-Priority AE Mode	○	○	–	–	○
M Manual Exposure Mode	○	○	–	–	○
Creative Video Mode	–	–	–	–	○
Panorama Shot Mode	–	–	–	–	○
Creative Control Mode	–	–	–	–	○
Scene Guide Mode (●: Default settings)	[Clear Portrait]	○	●*4	–	○
	[Silky Skin]	○	●*4	–	○
	[Backlit Softness]	–	–	–	●
	[Clear in Backlight]	●*2	–	–	○
	[Relaxing Tone]	–	–	–	●
	[Sweet Child's Face]	○	●*4	–	○
	[Distinct Scenery]	–	–	–	●
	[Bright Blue Sky]	–	–	–	●
	[Romantic Sunset Glow]	–	–	–	●
	[Vivid Sunset Glow]	–	–	–	●
	[Glistening Water]	–	–	–	●
	[Clear Nightscape]	–	–	–	●
	[Cool Night Sky]	–	–	–	●
	[Warm Glowing Nightscape]	–	–	–	●
	[Artistic Nightscape]	–	–	–	●
	[Glittering Illuminations]	–	–	–	●
	[Handheld Night Shot]	–	–	–	●
	[Clear Night Portrait]	–	–	–	●
	[Soft Image of a Flower]	●*3	–	–	○
	[Appetizing Food]	●*3	–	–	○
	[Cute Dessert]	●*3	–	–	○
	[Freeze Animal Motion]	●*3	–	–	○
	[Clear Sports Shot]	●*3	–	–	○
[Monochrome]	●*3	○	○	○	

*1 The display will show when the flash is in use. (→90)

*2 Default setting is .

*3 Default setting is .

*4 Default setting is .

● The Scene Guide Mode flash setting is returned to the initial value with each change of scene.

Setting the Flash Functions

■ Shutter speeds for each flash mode

Flash Mode	Shutter speed (seconds)
	1/60*2 - 1/2000

Flash Mode	Shutter speed (seconds)
	1 - 1/16000
	60*3 - 1/16000

*1 **ZS60***2 **ZS100**

The shutter speed is set to 60 seconds in Shutter-Priority AE Mode and to T (Time) in Manual Exposure Mode.

ZS60

The shutter speed is set to 4 seconds in Shutter-Priority AE Mode.

*3 **ZS100**

The shutter speed is set to T (Time) in Manual Exposure Mode.

- In Intelligent Auto Mode ([IA] or [IA⁺]), the shutter speed changes depending on the detected scene.

Setting the Flash Functions

ZS100 Setting the 2nd curtain syncRecording mode: **PAS**

2nd curtain sync is a recording method in which the flash fires just before the shutter closes when you take a picture of a moving subject (such as a car) using the flash with a slow shutter speed.

1 Set the menu

MENU → **[Rec]** → **[Flash]** → **[Flash Synchro]**

2 Press **▲ ▼** to select the setting item and press **[MENU/SET]**

[1ST]	1st curtain sync is the normal recording method when using the flash.	
[2ND]	The light source is captured in back of the subject and this produces a picture that is vibrant and lively.	

- If you set to [2ND], [2nd] will be displayed in the flash icon on the screen.
- When a fast shutter speed is set, the [Flash Synchro] effect may not be sufficiently achieved.
- When [2ND] is set, you cannot set the flash setting to [] or [].

Adjusting the flash output

Recording mode: **PAS** **M** **C**

Adjust the flash output if a picture taken using the flash is too bright or too dark.

1 Set the menu

ZS100

MENU → **[Rec]** → **[Flash]** → **[Flash Adjust.]**

ZS60

MENU → **[Rec]** → **[Flash Adjust.]**

2 Press ◀▶ to set the flash output and press [MENU/SET]

Settings: -2 EV to +2 EV (unit: 1/3 EV)

When you do not want to adjust the intensity of the flash, select [±0 EV].

- When the intensity of the flash is adjusted, [+] or [-] is displayed on the flash icon.

Recording motion pictures

Recording mode: 

You can record full high-definition quality images that comply with the AVCHD standard, as well as motion pictures recorded in MP4. You can also record a 4K motion picture in MP4. (→254)

Audio is recorded in stereo.

1 Press the motion picture button to start recording

- Recording of motion picture appropriate for each motion picture mode is possible.
- Immediately release the motion picture button after pressing it.
- While you are recording motion pictures, the recording status indicator (red) will flash.
- **With recording in a quiet environment, the sound of aperture, focus and other actions may be recorded in motion pictures. This is not a malfunction.**

The focus operation during recording of motion pictures can be set to [OFF] in [Continuous AF]. (→257)

- If some information is no longer displayed on the screen, press the [DISP.] button or touch the monitor.
- Still pictures can be taken during motion picture recording. (→261)

2 Press the motion picture button again to end recording

ZS100

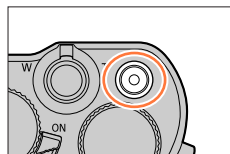

ZS60

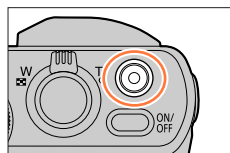

Recording state indicator



Elapsed recording time

Remaining recording time



Switching the angle of view setting used for recording still pictures and motion pictures

MENU → [Custom] → [Rec Area] → [] (Picture) / [] (Motion picture)

- If the aspect ratio is different for still pictures and motion pictures, the angle of view will change when starting to record a motion picture.
When you set [Rec Area] to [], the angle of view setting used for recording motion pictures is displayed.
- [Rec Area] is not available for 4K photo recording or recording in [Post Focus].



About operation sound when recording ends

If the operation sound of the motion picture button pressed to end recording bothers you, try the following:

- Record the motion picture about three seconds longer, and then divide the last part of the motion picture using [Video Divide] ([→292](#)) in the [Playback] menu.



Recording motion pictures

- If the surrounding temperature is high, or a motion picture is recorded continuously, [△/A] is displayed and recording may be stopped halfway through to protect the camera. Wait until the camera cools down.
- If Extended optical zoom is used before pressing the motion picture button, these settings will be cleared, and the recordable area will be changed significantly.
- Note that if you perform operations such as zoom, using buttons or dials, while recording a motion picture, operation noise may be recorded.
- The zoom speed will be slower than normal during motion picture recording.
- Depending on the type of the card, the card access indication may appear for a while after recording motion pictures. This is not a malfunction.
- ISO sensitivity is set to [AUTO] (for motion pictures) while a motion picture is being recorded. Also [ISO Limit Set] is disabled.
- It is recommended to use a fully charged battery or an AC adaptor (optional) and DC coupler (optional) when recording motion pictures.
- If while recording motion pictures using the AC adaptor (optional) and the power supply is cut off due to a power outage or if the AC adaptor is disconnected etc., the motion picture being recorded will not be recorded.
- The below-mentioned motion picture recording modes are set in the following cases:

Selected Scene Guide Mode	Recording mode at the time of recording motion pictures
[Clear in Backlight]	Portrait Mode
[Clear Nightscape], [Artistic Nightscape], [Handheld Night Shot], [Clear Night Portrait]	Low Light Mode

- This function is not available in the following cases:
 - [Glistening Water], [Glittering Illuminations], [Soft Image of a Flower] (Scene Guide Mode)
 - [Rough Monochrome], [Silky Monochrome], [Toy Effect]*1, [Toy Pop]*1, [Miniature Effect]*1, *2, [Soft Focus], [Star Filter], [Sunshine] (Creative Control Mode)
 - *1 When [4K Live Cropping] is set to [ON].
 - *2 When recording motion pictures with [Rec Quality] of [4K]
 - When recording using [Post Focus]
 - When using [Time Lapse Shot]
 - When using [Stop Motion Animation]



Recording 4K motion pictures

Recording mode: 

You can record high-resolution 4K motion pictures by setting [Rec Quality] to [4K].

- To record 4K motion pictures, use a UHS Speed Class 3 card. (→37)
- When you record 4K motion pictures, the angle of view will be narrower than motion pictures of other sizes.
- Limitations on continuous recording (→41)

■ To record motion pictures in 4K

- ① Select the recording mode (→49)
- ② Set the [Rec Format] in the [Motion Picture] menu to [MP4] (→255)
- ③ **ZS100**
Set [Rec Quality] in the [Motion Picture] menu to [4K/100M/30p] or [4K/100M/24p] (→255)
- ZS60**
Set [Rec Quality] in the [Motion Picture] menu to [4K/100M/30p] (→255)
- ④ Start recording by pressing the motion picture button
- ⑤ Stop the recording by pressing the motion picture button again

- Recording is performed by reducing the Auto Focus speed in order to adjust the focus at high precision. Sometimes focus adjustment with Auto Focus mode is difficult, but this is not a malfunction.

Setting the format, picture size and recording frame rate

Recording mode: **PAS** **M** **C**

1 Set the menu

[MENU] → **[Motion Picture]** → **[Rec Format]**

2 Use ▲ ▼ to select the item and press **[MENU/SET]**

[AVCHD]	This is a data format suitable for playback on high-definition TVs.
[MP4]	This data format is suited for playing back motion pictures on a computer and other such devices.

3 Use ▲ ▼ to select **[Rec Quality]** and press **[MENU/SET]**

4 Use ▲ ▼ to select the item and press **[MENU/SET]**

When **[AVCHD]** is selected

[Rec Quality]	Picture size	Recording frame rate	Sensor output	Bit rate
[FHD/28M/60p]*1	1920×1080	60p	60 fps	Approx. 28 Mbps
[FHD/17M/60i]	1920×1080	60i	60 fps	Approx. 17 Mbps
[FHD/24M/30p]	1920×1080	60i	30 fps	Approx. 24 Mbps
[FHD/24M/24p]*2	1920×1080	24p	24 fps	Approx. 24 Mbps

When **[MP4]** is selected

[Rec Quality]	Picture size	Recording frame rate	Sensor output	Bit rate
[4K/100M/30p]	3840×2160	30p	30 fps	Approx. 100 Mbps
[4K/100M/24p]*2	3840×2160	24p	24 fps	Approx. 100 Mbps
[FHD/28M/60p]	1920×1080	60p	60 fps	Approx. 28 Mbps
[FHD/20M/30p]	1920×1080	30p	30 fps	Approx. 20 Mbps
[HD/10M/30p]	1280×720	30p	30 fps	Approx. 10 Mbps
[VGA/4M/30p]	640×480	30p	30 fps	Approx. 4 Mbps

*1 AVCHD Progressive

*2 **ZS100**

- The quality becomes higher when the number of bit rate gets bigger. This unit uses the “VBR” recording method, and the bit rate is changed automatically depending on the subject to record. Therefore, the recording time is shortened when a subject with fast movement is recorded.
- Limitations on continuous recording (→41)

■ About the compatibility of the recorded motion pictures

Motion pictures recorded in [AVCHD] or [MP4] may be played back with poor picture or sound quality or playback may not be possible even when played back with equipment compatible with these formats. Also, the recording information may not be displayed properly.

• ZS100

When you play back and import motion pictures recorded with [FHD/28M/60p], [FHD/24M/30p], or [FHD/24M/24p] in [AVCHD] using a device other than this unit, a compatible Blu-ray disc recorder or PC installed with “PHOTOfunSTUDIO” software downloaded from our website (→353) is required.

• ZS100

For details on motion pictures recorded with [4K/100M/30p] or [4K/100M/24p] in the [MP4] format, refer to “Enjoying 4K motion pictures” (→346).

• ZS60

When you play back and import motion pictures recorded with [FHD/28M/60p], or [FHD/24M/30p] in [AVCHD] using a device other than this unit, a compatible Blu-ray disc recorder or PC installed with “PHOTOfunSTUDIO” software downloaded from our website (→353) is required.

• ZS60

For details on motion pictures recorded with [4K/100M/30p] in the [MP4] format, refer to “Enjoying 4K motion pictures” (→346).

Adjusting the focus while recording motion pictures ([Continuous AF])

Recording mode:

Focusing varies depending on the setting of [AFS/AFF/AFC] (→148) in the [Rec] menu and the setting of [Continuous AF] in the [Motion Picture] menu.

If the focus mode is [MF], the focus can be set manually. (→167)

[AFS/AFF/AFC]	[Continuous AF]	Setting
[AFS]/[AFF]/ [AFC]	[ON]	Allow the focus to be constantly adjusted automatically while recording motion pictures. (→148)
	[OFF]	Fix focus position at the start of motion picture recording.

- When [AFS/AFF/AFC] is set to [AFS], [AFF], or [AFC], the camera will refocus if the shutter button is pressed halfway while recording motion pictures.
- When Auto Focus is activated while you are recording motion pictures, the focusing operation sound may be recorded under some conditions. If you want to suppress this sound, we recommend taking pictures after setting [Continuous AF] to [OFF] in the [Motion Picture] menu.
- When using zoom while recording motion pictures, it may take some time to focus.
- [Continuous AF] does not work while [Pull Focus] in [Snap Movie] is in operation.

Recording pans with little vibration or recording motion pictures with zoom [4K Live Cropping]

Recording mode: 

You can pan while recording subjects without horizontal shaking of the camera, and you can zoom in and out during motion picture recording without using zoom. During recording, you can crop your video down from the 4K angle of view (3840×2160) to Full High Definition (1920×1080) by capturing the subject at a wide angle of view and setting a crop start frame and crop end frame.

- Hold the camera firmly in place while recording.
- A motion picture will be recorded at [FHD/20M/30p] under [MP4].

Example of panning while recording.



Setting crop frames at 4K angle of view



Screen moves from left to right without moving the camera

1 Set mode dial to  [M]

2 Set the menu

MENU →  [Motion Picture] → [4K Live Cropping]

3 Use   to set panning or zooming time and press **[MENU/SET]**

Settings: [40SEC] / [20SEC] / [OFF]

- The angle of view narrows.



Recording pans with little vibration or recording motion pictures with zoom [4K Live Cropping]

4 Set the crop start frame

- When making settings for the first time, a crop start frame of size 1920×1080 is displayed. (After setting the crop start frame and end frame, the start frame and end frame that you set immediately before will be displayed.)
- The camera will remember the frame position and size even when the camera is turned off.

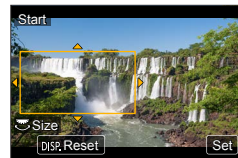

Operation	Touch operation	Description
▲▼◀▶	Touch	Moves the frame
 	Pinch out / Pinch in	Enlarges/reduces the frame (The range of settings allowed is from 1920×1080 to 3840×2160.)
[DISP.]	[Reset]	The frame will return to the size of 1920×1080, with the position of the frame as its center.
[MENU/SET]	[Set]	Decides the position and size of the frame

5 Set the crop end frame

- Do the same as in step 4 to set the end frame position and size,*1 making it coincide with the movement in the image you wish to record (see below).

*1 Press [DISP.] or touch [Reset] to return to the start frame position and size.

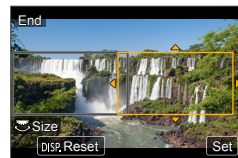

Movement of the image on the screen	Frame size	
	Start frame	End frame
Pan (move right and left)	Same	
Zoom in	Large	Small
Zoom out	Small	Large

- The setting of [AF Mode] switches to [👤] (Face/Eye Detection).*2 If a face is detected in the crop start frame, a yellow or white AF area frame is displayed.
*2 The Eye Detection cannot be used. If no face is recognized, the camera switches to [■] (49-area-focusing) (→150).

■ Changing the position and size of a crop frame

Press [Fn1] button.

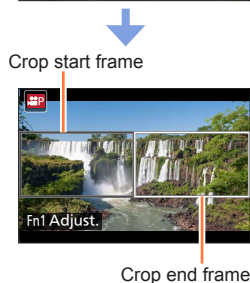

Recording pans with little vibration or recording motion pictures with zoom [4K Live Cropping]

6 Press the motion picture button to start recording

The display switches to the angle of view set in step 4 and the panning or zoom operation is displayed.

- Immediately release the motion picture button after pressing it.
- When the set operating time has elapsed, recording automatically ends.
- Zoom operation is not available.
- If a face is detected in the crop frame during recording, the AF area frame is displayed, similar to step 5.

Elapsed recording time



Set operating time

■ To end [4K Live Cropping] recording midway

Press the motion picture button again during recording.

■ To cancel [4K Live Cropping] recording

Set [OFF] in step 3.

- [4K Live Cropping] recording cannot be performed when [High Speed Video] is set.
- Brightness is measured and focus is done in the crop start frame. During motion picture recording, they are done in the crop frame.
- The metering mode will be [Multi Metering].
- If you assign [4K Live Cropping] in [Fn Button Set] (→70) under the [Custom] menu, you can display a screen that lets you switch [4K Live Cropping] between [40 sec.], [20 sec.], and [OFF] by pressing the assigned function button. If you select [40 sec.] or [20 sec.], you can set the crop start frame by pressing the [Fn1] button.
 - **ZS100**
You can do the same as above if you set [4K Live Cropping] via [CUSTOM] under [Q.MENU] on the [Custom] menu (→69).
- Touch AE is not available during recording with [4K Live Cropping].
- [Touch AF] does not work during Auto Focus (→61).
- 1 Shot AF does not work during Manual Focus (→170).



Taking still pictures while a motion picture is being recorded

Recording mode:   **PAS**    

1 Press the shutter button fully during the motion picture recording

- Up to 30 pictures can be recorded.
- When you take a still picture, the simultaneous still/motion picture recording icon is displayed.
- Recording with the Touch Shutter function (→63) is also available.



- The aspect ratio of a still picture is fixed to [16:9].
- Takes a still picture using [Picture Size] [S] (2M). The picture quality may be different to [S] (2M) of standard pictures.
- Only pictures in JPEG file format are recorded when [Quality] is set to [RAW , [RAW , or [RAW]. ([Quality] is used with the  setting when [RAW] is set.)
- When the Creative Control Mode is set to [Miniature Effect], a still picture may be taken with a slight delay from the time you fully press the shutter button.
- This function is not available in the following cases:
 - **ZS100**
When [Rec Format] is set to [MP4], [Rec Quality] is set to [4K/100M/30p], [4K/100M/24p], or [VGA/4M/30p]
 - **ZS60**
When [Rec Format] is set to [MP4], [Rec Quality] is set to [4K/100M/30p] or [VGA/4M/30p]
 - When [Snap Movie] is set to [ON]



Recording Snap Movies

Recording mode: **PAS**

You can specify the recording time in advance and record motion pictures casually like you take snapshots. The function also allows you to shift a focus at the start of recording and add fade in/out effects in advance.

- Motion pictures will be recorded with [FHD/20M/30p] in [MP4].
- Using the smartphone/tablet app “Panasonic Image App”, you can combine motion pictures recorded with the camera. Music can be added and various editing operations can be performed when you combine them. In addition, you can send the combined motion picture to a web service. (→316)

1 Set the menu

MENU → [Motion Picture] → [Snap Movie]

2 Use ▲ ▼ to select [SET] and press [MENU/SET]

3 Use ▲ ▼ to select the item and press [MENU/SET]

[Record time]	Sets the recording time of motion pictures. [8SEC] / [6SEC] / [4SEC] / [2SEC]
[Pull Focus]	Allows dramatic imaging expression by shifting focus gradually at the start of recording. [ON] / [OFF] • For details (→264).
[Fade]	Adds a fade-in (gradual appearance) effect to an image and audio as recording starts or adds a fade-out (gradual disappearance) effect to them as recording ends. [WHITE-IN] / [WHITE-OUT]: Adds a fade-in or fade-out effect that uses a white screen. [BLACK-IN] / [BLACK-OUT]: Adds a fade-in or fade-out effect that uses a black screen. [COLOR-IN] / [COLOR-OUT]: Adds an effect that fades in from black-and-white to color or an effect that fades out from color to black-and-white. Audio will be recorded normally. [OFF]

4 Press [Q.MENU/↵] button

5 Press [MENU/SET]

6 Press ▲ ▼ to select [ON] and press [MENU/SET]

- If [Pull Focus] is set to [ON], set its focus. (→264)



Recording Snap Movies

7 Press the motion picture button to start recording

- Immediately release the motion picture button after pressing it.
- You cannot stop motion picture recording in the middle. The recording will stop automatically when the set recording time has elapsed.

Elapsed recording time

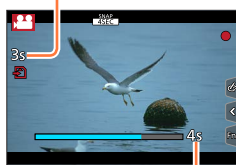

Set recording time

■ Deactivating Snap Movie

Select [OFF] in step 2.

- Motion pictures recorded with [WHITE-IN] or [BLACK-IN] are displayed as all-white or all-black thumbnails in Playback Mode.
- If you assign [Snap Movie] to [Fn Button Set] (→70), you can display a screen that lets you switch [Snap Movie] between [ON]/[OFF] by pressing the assigned function button. If you press [DISP.] button while the screen is displayed, you can change the settings for Snap Movie.
- [Snap Movie] will be set to [OFF] when you connect to Wi-Fi with [Remote Shooting & View].
- This function is not available in the following cases:
 - [Miniature Effect] (Creative Control Mode)
 - When [4K PHOTO] is set
 - When [4K Live Cropping] is set
 - During [High Speed Video] recording



Setting up [Pull Focus]

Set the frames that determine a focus start (first) position and focus end (second) position. The camera then measures its distance to the subjects and sets focus. When you start motion picture recording, focus shifts from the first frame to the second frame.

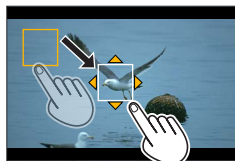

Touch operation

Touch a subject (first position), drag your finger to the desired location (second position), and release the finger.

- Auto Focus will work to set the start and end focus of [Pull Focus]. When the setup has failed, the frame returns to the first position. Perform the setup again.
- To cancel the frame settings, touch

Button operation

- ① Assign [AF Mode] to a function button ([Fn1] - [Fn4]) ([→70](#))
- ② Press the function button that [AF Mode] has assigned to at step ①
- ③ Press to move the frame, and press [MENU/SET] (First position)
 - If you press [DISP.] button before pressing [MENU/SET], the frame will return to the center.
- ④ Repeat step ③ (Second position)
 - Auto Focus will work to set the start and end focus of [Pull Focus]. When the setup has failed, the frame returns to the first position. Perform the setup again.
 - To cancel the frame settings, press [MENU/SET].



- A greater effect can be achieved by creating a striking contrast of focus between the start and end positions, for example by shifting focus from the background to foreground, or vice versa.
- After setting focus, try to keep the distance between the subject and the camera constant.

- When [Pull Focus] is set to [ON]
 - Auto Focus Mode will be switched to , a setting specially designed for [Pull Focus].
 - If you take a picture, the Auto Focus operation will take place at the first frame position.
- To re-adjust the focus while recording a motion picture, press the shutter button halfway after the [Pull Focus] operation finishes.
- Even when [Metering Mode] ([→183](#)) is set to , the spot metering target does not move with focus. The target is fixed at the start position (first position) of [Pull Focus].
- This function is not available in the following cases:
 - In Manual Focus
 - When using the Digital Zoom

Using the [Motion Picture] menu

For the setting procedures for the [Motion Picture] menu, refer to (→65)

- The [Motion Picture] menu is not displayed in the recording mode in which motion pictures cannot be recorded.

[4K Live Cropping]

- For details (→258).

[Snap Movie]

- For details (→262).

[Rec Format]

- For details (→255).

[Rec Quality]

- For details (→255).

[Exposure Mode]

- For details (→124).

[High Speed Video]

- For details (→125).

Using the [Motion Picture] menu

For the setting procedures for the [Motion Picture] menu, refer to (→65)

[Continuous AF]

- For details (→257).

[Level Shot]

Recording mode:   **PAS** **M**  **C**  

Level Shot function automatically detects the camera's tilt while recording motion pictures, and horizontally corrects the recording motion picture so it will not be tilted.

Settings: [ON] / [OFF]

- If you record while walking, or if the camera's tilt is large, it may not be possible to horizontally correct the motion pictures.
- When [Level Shot] is set to [ON]
 - The angle of view becomes slightly narrow when motion picture recording starts.
- Still pictures taken while recording motion pictures will not be horizontally corrected.
- This function is not available in the following cases:
 - When recording with [High Speed Video]
 - When [Stabilizer] is set to [OFF]
 - **ZS100**
 - When [Rec Format] is set to [MP4], and [Rec Quality] is set to [4K/100M/30p], [4K/100M/24p], or [VGA/4M/30p]
 - **ZS60**
 - When [Rec Format] is set to [MP4], and [Rec Quality] is set to [4K/100M/30p] or [VGA/4M/30p]

[Flicker Decrease]

Recording mode:   **PAS** **M** **C**  

The shutter speed can be fixed to reduce the flicker or striping in the motion picture.

Settings: [1/50] / [1/60] / [1/100] / [1/120] / [OFF]

[Silent Operation]

- For details (→126).

Using the [Motion Picture] menu

For the setting procedures for the [Motion Picture] menu, refer to (→65)

[Wind Noise Canceller]

Recording mode:   **P** **A** **S** **M**  **C**  

This will reduce the wind noise coming into the built-in microphone while maintaining sound quality.

Settings: [HIGH] / [STANDARD] / [OFF]

- [HIGH] effectively reduces the wind noise by minimizing the low-pitched sound when a strong wind is detected.
- [STANDARD] extracts and reduces only the wind noise without deteriorating the sound quality.

● You may not see the full effect depending on the recording conditions.

[Zoom Mic]

Recording mode:   **P** **A** **S** **M**  **C**  

Coupled to the zoom operation, it will more clearly record far sounds during enlarging image, and surrounding sounds with wide-angle.

Settings: [ON] / [OFF]

- When set to [ON] and performing zoom, the operation sound may be recorded enhanced in accordance with the surrounding sounds. Also, audio recording level will be lower compared to when [OFF].
- The stereo effect of the audio is reduced during enlarging image.

Viewing your pictures

1 Press the Playback button

2 Press ◀▶ to select a picture to be displayed

- When you press and hold ▶, the pictures are displayed one after another.

ZS100

Pictures can also be forwarded or rewound by rotating the rear dial or dragging the screen horizontally (→61).

ZS60

Pictures can also be forwarded or rewound by rotating the control dial or dragging the screen horizontally (→61).

- If you keep your finger touching the left or right edge of the screen after scrolling the pictures, the pictures will continue to be scrolled. (The pictures are displayed in a reduced size.)
- The playback speed of pictures varies depending on the playback conditions.

ZS100

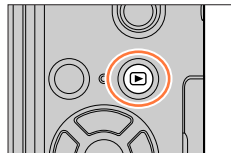

ZS60

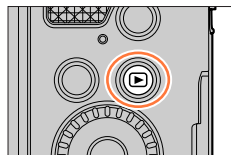

Switching the speed for forwarding or rewinding pictures continuously

MENU → **fC** [Custom] → [Touch Scroll] → [H] (High speed) / [L] (Low speed)



Sending pictures to the WEB services

If you press ▼ while a single picture is being displayed, you can send the picture to the WEB service quickly. (→330)



■ Ending Playback

Press the Playback button again or press the Motion picture button.
The Playback can also be ended by pressing the shutter button halfway.

- **ZS100**
The playback screen appears if the camera is turned on while pressing the Playback button.
- **ZS60**
By holding down the Playback button while the camera is off, you can turn the camera on in playback mode.
- When the camera is switched to the playback screen from the recording screen, the lens barrel is retracted after approx. 15 seconds.
- This camera is compliant with the unified DCF (Design rule for Camera File system) standard formulated by the Japan Electronics and Information Technology Industries Association (JEITA), and with Exif (Exchangeable image file format).
Files that are not DCF-compliant cannot be played back.
- It may not be possible to properly play back pictures taken using other cameras on this unit or it may not be possible to use the functions of this unit for those pictures.



Viewing motion pictures

This unit was designed to play motion pictures using the AVCHD and MP4 formats.

- Motion pictures are displayed with the motion picture icon ([]).
- 4K burst files recorded with the 4K Photo function are displayed with ([]). To select and save a picture from 4K burst files, refer to (→190).
- The [Post Focus] icon ([]) is shown on images recorded using [Post Focus]. To save pictures with a selected focus point, refer to (→214).

1 Press to start playback

- Touching [] in the middle of the screen allows you to play back motion pictures.
- Motion pictures recorded with [Snap Movie] are played back automatically.
- Some information will not be displayed for motion pictures recorded in [AVCHD].



Motion picture recording time

■ Operations during motion picture playback

Operation	Touch operation	Description
		Play/pause
		Fast rewind*1
		Single-frame rewind*2 (while paused)
		Stop
		Fast forward*1
		Single-frame forward (while paused)
 	/	Volume down / Volume up

*1 The fast forward or rewind speed increases if you press again.

*2 Motion pictures recorded in [AVCHD] are rewound frame by frame approximately every 0.5 seconds.

- Control panel disappears when no operation is performed for some time. Touch the screen to redisplay the control panel.
- If you press [MENU/SET] during a pause, you can create a picture from a motion picture. (→271)

Operations during automatic Snap Movie playback

▲	Playback from the beginning
◀	Returning to the previous picture
▶	Scrolling to the next picture

• If you touch the screen, automatic playback will stop.

- Motion pictures recorded with other devices can be played back on this camera but cannot be edited with it.
- Motion pictures recorded with this camera cannot be played back on other devices.
- Motion pictures can be viewed on your computer using "PHOTOfunSTUDIO" (→353).



Capturing still pictures from motion pictures

Save a scene from a motion picture as a still picture.

1 Display the picture that you want to capture as a still picture by pressing ▲ to pause a motion picture being played back on the camera

- If you press ◀▶ while paused, you can make finer adjustments to the positions in a motion picture.

2 Press [MENU/SET]

- The same operation can be performed by touching .
- The still picture is saved with aspect ratio of [16:9] and [Quality] of []. The picture size varies depending on the motion picture being played back.



[Rec Quality]	[Picture Size]
[4K]	[M] (8M)
[FHD], [HD]	[S] (2M)

- The picture quality becomes slightly lower depending on the [Rec Quality] setting of the original motion picture.
- When a still picture captured from a motion picture is played back,  is displayed.
- If you want to capture a still picture from a motion picture while the camera is connected to a TV with the HDMI micro cable, set [VIERA Link] of [TV Connection] in the [Setup] menu to [OFF].
- You cannot capture a still picture from the following motion pictures.
 - Motion pictures recorded in [MP4] using the [VGA/4M/30p] setting

Switching the Playback Method

Zooming in and viewing “Playback Zoom”

1 Move the zoom lever toward T side

- Each time you move the zoom lever toward the T side, the magnification increases through four levels: 1x, 2x, 4x, 8x, and 16x. (The picture quality displayed becomes successively lower.)
- To reduce zoom → Move the zoom lever toward W side.
- You can also enlarge/reduce the image by pinching out/pinching in (→61) on the part you want to enlarge/reduce.
- When you change the magnification, the zoom position indication appears for about 1 second.
- You can move the enlarged part by pressing ▲▼◀▶ of the cursor button or dragging the screen. (→61)
- You can also zoom in by quickly touching the touch screen twice. (If the display was enlarged, it returns to the same magnification ratio.)

ZS100

You can forward or rewind a picture while maintaining the same zoom magnification and zoom position by rotating the rear dial during Playback Zoom.

ZS60

You can forward or rewind a picture while maintaining the same zoom magnification and zoom position by rotating the control dial during Playback Zoom.

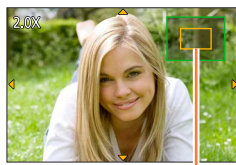
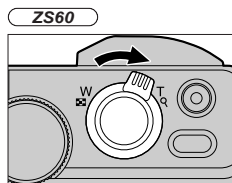
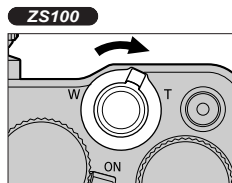

Current zoom position



Switching the Playback Method

Viewing a list of pictures “Multi Playback”

1 Move the zoom lever toward W side

- Move the zoom lever toward the W side and you can switch the display methods in the following order: 1-picture screen (full-screen) → 12-picture screen → 30-picture screen → Calendar screen. (Move the lever to the T side to return.)
- It is possible to switch the playback screen by touching the following icons.

– [■]: 1-picture screen	– [■]: 12-picture screen
– [■]: 30-picture screen	– [CAL]: Calendar screen
- The screen can be switched gradually by dragging the screen up or down.
- When you select a picture using the cursor button and press [MENU/SET] on the 12-picture or 30-picture screen, the selected picture is displayed on the 1-picture screen (full-screen).

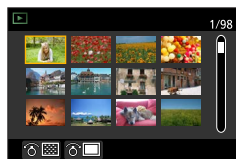
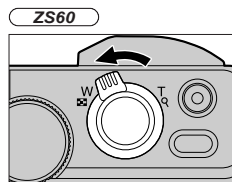
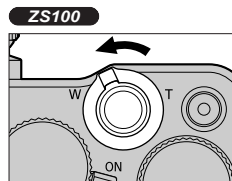

- Pictures displayed with [!] cannot be played back.

Switching the Playback Method

Viewing pictures by their recording date “Calendar Playback”

- 1 Move the zoom lever toward the W side to display the calendar screen

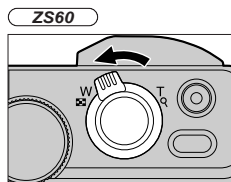
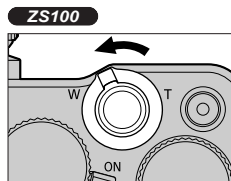

- 2 Use ▲▼◀▶ to select recording date and press [MENU/SET]

- Pictures are displayed in a 12-picture screen.
- Turn the zoom lever toward the W side to return to the Calendar screen display.

Selected date



- The recording date of the picture selected in the playback screen becomes the date selected when the Calendar screen is first displayed.
- You can display the calendar between January 2000 to December 2099.
- Pictures taken without clock settings are displayed with the date January 1st, 2016.
- Pictures taken with destination settings made in [World Time] are displayed in the calendar screen using the appropriate date for the destination's time zone.

Viewing group pictures

You can consecutively play back multiple pictures in a group or play back group pictures one by one.

- []: Group pictures recorded consecutively by setting the burst speed to [SH] (→202)
- []: Group pictures recorded using [Time Lapse Shot] (→216)
- []: Group pictures recorded using [Stop Motion Animation] (→219)



- You can delete or edit pictures in group units. (For example, if you delete one of pictures in a group, all pictures in that group will be deleted.)

● Pictures will not be grouped if they are recorded without setting [Clock Set].

Playing back group pictures consecutively

1 Press ▲

- The same operation can be performed by touching the group picture icon (, ,).
- When you play back group pictures one by one, the option settings are displayed.
 - [From the first picture]: Play back the group pictures consecutively from the first picture in a group.
 - [From the current picture]: Play back the group pictures consecutively from the picture currently played back.

■ Operations during continuous playback

▲		Continuous playback / Pause	▼		Stop
◀		Fast rewind playback	▶		Fast forward playback
		Returning to the previous picture (while paused)			Scrolling to the next picture (while paused)

Switching the Playback Method

Playing back group pictures one by one

1 Press ▼

- The same operation can be performed by touching .

2 Use ▲ ▼ to select [Display In Group] and press [MENU/SET]**3 Use ◀ ▶ to scroll through the pictures**

- Pressing ▼ again or touching  and selecting [Exit Display In Group] will return you to the normal playback screen.
- You can use the same operations for pictures stored in a group as in normal still picture playback. (Multi Playback, Playback Zoom, deletion of pictures, etc.)



Deleting pictures

Deleted pictures cannot be recovered.

Pictures will not be deleted in the following cases:

- Protected pictures.
- Card switch is in "LOCK" position.
- Pictures that are not based on the DCF standard. (→269)

- Do not turn off the camera while deleting.
- Use a sufficiently charged battery or an AC adaptor (optional) and DC coupler (optional).

[Delete Single]

1 Press [] button to delete displayed picture

- The same operation can be performed by touching [].

ZS100

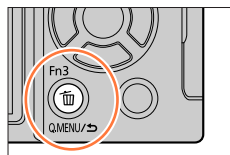

ZS60

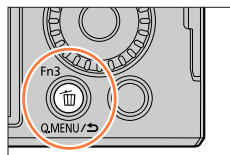

2 Use to select [Delete Single] and press [MENU/SET]

Deleting pictures

To delete multiple (up to 100)/To delete all pictures

A picture group (→275) is handled as 1 picture. (All the pictures in the selected picture group are deleted.)

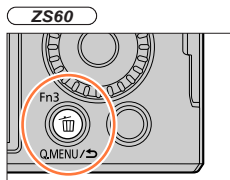
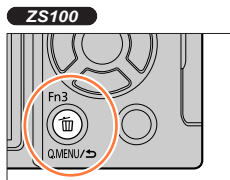
1 Press [Fn3] button while viewing a picture**2 Use ▲▼ to select [Delete Multi]/[Delete All] and press [MENU/SET]**

- You can select [All Delete Except Favorite] in [Delete All] if there are pictures that have been set as [Favorite] (→297).

3 (When [Delete Multi] is selected) Use ▲▼◀▶ to select picture and press [MENU/SET] (repeat)

- To cancel → Press [MENU/SET] again.

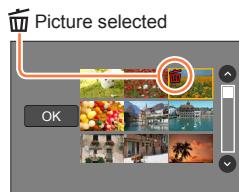
**4 (When [Delete Multi] is selected) Use ◀ to select [OK] and press [MENU/SET]**

- May take time depending on number of pictures deleted.

Using the [Playback] menu

You can specify picture protection, resizing, print settings, and other settings for pictures you have taken.

- For the setting procedures of the menu. (→65)

● In the following cases, new pictures are created after they have been edited. Before starting to edit, make sure that there is enough free space in the memory card.

- **ZS100** [RAW Processing]
 - [Light Composition]
 - [Clear Retouch]
 - [Text Stamp]
 - [Time Lapse Video]
 - [Stop Motion Video]
 - [Resize]
 - [Cropping]
- It may not be possible to set or edit pictures taken with other cameras.

■ How to select an image(s) after selecting [Single] or [Multi]

Some menu items allow you to specify how to select an image(s).

[Single]

- ① Use ◀▶ to select a still picture and press [MENU/SET]
 - If [Set/Cancel] is displayed at the right bottom of the screen, the setting is canceled when [MENU/SET] is pressed again.

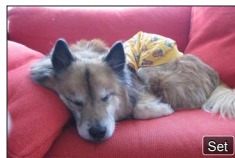

[Multi]

When a screen similar to the one on the right is displayed:

- ① Use ▲▼◀▶ to select a still picture and press [MENU/SET] (repeat)
 - To cancel → Press [MENU/SET] again.
- ② Use ◀ to select [OK] and press [MENU/SET]

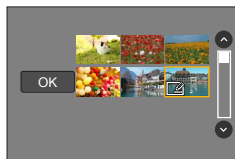

When a screen similar to the one on the right is displayed:

- ① Use ▲▼◀▶ to select a still picture and press [MENU/SET] (repeat)
 - To cancel → Press [MENU/SET] again.

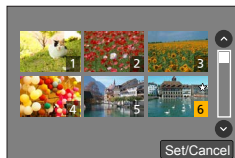

[Slide Show]

Automatically play pictures in order. You can also put together a slide show composed of only still pictures, only motion pictures, or only 4K Photos, etc. Recommended when viewing on TV screen.

1 Set the menu

MENU →  **[Playback]** → **[Slide Show]**





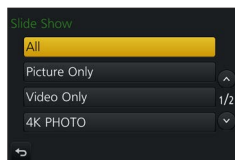

2 Use ▲ ▼ to select the item and press [MENU/SET]

- If you select [Video Only], 4K burst files recorded with the 4K Photo function and pictures recorded using [Post Focus] will also be played back.
- Only an in-focus representative image will be played back from pictures recorded using [Post Focus].
- When you select [Category Selection], use ▲ ▼ ◀ ▶ to select category and press [MENU/SET]. For details about category, refer to (→282).



3 Use ▲ to select [Start] and press [MENU/SET]

■ Operations during Slide Show

Operation	Touch operation	Description
▲		Play/Pause
◀		Previous
▼		Stop
▶		Next
 		Volume down / Volume up

Using the [Playback] menu

To change settings such as music or display time

Select [Effect] or [Setup] and press [MENU/SET].

[Effect]		[AUTO] / [NATURAL] / [SLOW] / [SWING] / [URBAN] / [OFF]
[Setup]	[Duration]	[5SEC] / [3SEC] / [2SEC] / [1SEC]
	[Repeat]	[ON] / [OFF]
	[Sound]	[AUTO]: With still pictures, music will play back, and with motion pictures, audio will play back. [Music]: Music effect will play back. [Audio]: Audio is played back from motion pictures. [OFF]: Music and audio will not play back.

- When [URBAN] has been selected, the picture may appear in black and white as a screen effect.
- [AUTO] can be used only when [Category Selection] is selected. The pictures are played back with the recommended effects for each category.
- [Effect] is fixed to [OFF] when in [Video Only], or during the slide show for , , or in [Category Selection].
- During slide shows of 4K photo burst files, pictures recorded in [Post Focus], or group pictures, effects will stay turned off even if [Effect] is set.
- When you play back the following pictures in a slide show, the [Duration] setting is disabled.
 - Motion pictures
 - 4K burst files
 - Pictures recorded using [Post Focus]
 - Panorama pictures
 - Group pictures
- [Duration] can be set only when [Effect] is set to [OFF].
- Part of [Effect] cannot be used when displaying pictures on television using an HDMI micro cable or when displaying pictures recorded in portrait position.

[Playback Mode]

Recorded pictures can be played back in a variety of ways.

1 Set the menu

[MENU] → [Playback] → [Playback Mode]

2 Use ▲▼ to select the item and press [MENU/SET]

- If you select [Video Only], 4K burst files recorded with the 4K Photo function and pictures recorded using [Post Focus] will also be played back.

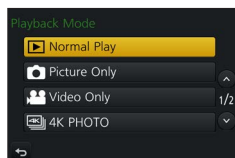











Using the [Playback] menu

When selecting [Category Play] in step 2 (→281)

3 Use ▲▼◀▶ to select the category and press [MENU/SET]

- The available categories are as follows.

	[Face Recog.]*
	[i-Portrait], [i-Night Portrait], [i-Baby] in Automatic Scene Detection [Clear Portrait], [Silky Skin], [Backlit Softness], [Clear in Backlight], [Relaxing Tone], [Sweet Child's Face], [Clear Night Portrait] (Scene Guide Mode)
	[i-Scenery], [i-Sunset] in Automatic Scene Detection [Distinct Scenery], [Bright Blue Sky], [Romantic Sunset Glow], [Vivid Sunset Glow], [Glistening Water] (Scene Guide Mode)
	[i-Night Portrait], [i-Night Scenery], [i-Handheld Night Shot] in Automatic Scene Detection [Clear Nightscape], [Cool Night Sky], [Warm Glowing Nightscape], [Artistic Nightscape], [Glittering Illuminations], [Handheld Night Shot], [Clear Night Portrait] (Scene Guide Mode)
	[Clear Sports Shot] (Scene Guide Mode)
	[i-Food] in Automatic Scene Detection [Appetizing Food], [Cute Dessert] (Scene Guide Mode)
	[Travel Date]
	A burst of pictures recorded by setting the burst speed to [SH]
	[Time Lapse Shot], [Time Lapse Video]
	[Stop Motion Animation], [Stop Motion Video]

* Use ▲▼◀▶ to select a person to be played back and press [MENU/SET]. Face Recognition is applied for all the pictures in the group.

- The category for recording motion pictures is different from the category of still pictures used in some Recording modes. For that reason, the pictures may not be played back.



[Location Logging]

After you send location information (latitude and longitude) obtained by your smartphone/tablet to this unit, you can write this information on pictures using the unit.

Preparation

Send location information to this unit from your smartphone/tablet. (→314)

- You must install "Panasonic Image App" on your smartphone/tablet. (→305)

1 Set the menu

MENU →  **[Playback]** → **[Location Logging]** → **[Add Location Data]**

2 Use ▲▼ to select a period for writing location information, and press [MENU/SET]

- [GPS] is displayed for pictures that have location information written to it.

■ Abort writing location information

- ① Press [MENU/SET] while location information is being written
 - [○] is displayed for the period of the abort operation.
 - If selected again while [○] is displayed, writing location information will resume where it left off.

■ Delete received location information

- ① Use ▲▼ to select [Delete Location Data] and press [MENU/SET]
- ② Use ▲▼ to select a period for deleting location information, and press [MENU/SET]

● The location information cannot be written in the following cases:

- Pictures that were recorded after you sent the location information (→314)
- Pictures that already have location information
- Motion pictures recorded in [AVCHD] format
- Protected pictures
- If there is not enough free space on your card
- Card switch is in "LOCK" position.
- Pictures recorded using cameras other than this unit



Writing the location information using a smartphone/tablet

When you use your smartphone/tablet as a remote controller for this unit, you can write the location information on pictures using the smartphone/tablet. (→315)

ZS100 [RAW Processing]

You can use the camera to develop still pictures that were recorded in RAW format. The created still pictures are saved in JPEG format.

1 Set the menu

[MENU] → **[Playback]** → **[RAW Processing]**

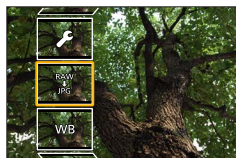
2 Press ◀▶ to select RAW file and press [MENU/SET]**3 Press ▲▼ to select the item**

- The following items can be set. The settings used during recording are applied at the time of setting.

[White Balance]	You can select White Balance to make adjustments. When you select an item with [Q] , you can develop the pictures using the same settings that were applied for recording.
[Exposure Comp.]	You can perform Exposure Compensation in the range from -1 EV to +1 EV.
[Photo Style]	You can select the [Photo Style] effects ([Standard], [Vivid], [Natural], [Monochrome], [Scenery], or [Portrait]).
[i.Dynamic]	You can select the [i.Dynamic] settings ([HIGH], [STANDARD], [LOW], or [OFF]).
[Contrast]	You can adjust the contrast.
[Highlight]	You can adjust the brightness of a highlighted area.
[Shadow]	You can adjust the brightness of a shadowed area.
[Saturation] / [Color Tone]	You can adjust the saturation. (You can adjust the coloring when [Monochrome] is selected for [Photo Style].)
[Filter Effect]	You can select a Filter effect. (Only when [Monochrome] is selected for [Photo Style].)
[Noise Reduction]	You can set noise reduction.
[i.Resolution]	You can select the [i.Resolution] settings ([HIGH], [STANDARD], [LOW], [EXTENDED], or [OFF]).
[Sharpness]	You can adjust the impression of resolution.
[Setup]	<p>You can perform the following settings.</p> <p>[Reinstate Adjustments]: You can restore the settings to the ones used during recording.</p> <p>[Color Space]: You can select [Color Space] from either [sRGB] or [AdobeRGB].</p> <p>[Picture Size]: You can select the picture size ([L], [M], or [S]) of a JPEG file when saving pictures.</p>

4 Press [MENU/SET] to set

- The setting methods vary depending on the item. For details, refer to "Setting each item" (→285).

Using the [Playback] menu

5 Press [MENU/SET]

- The screen in step 3 reappears. To set another item, repeat steps 3 to 5.

6 Press ▲ ▼ to select [Begin Processing] and press [MENU/SET]**■ Setting each item**

When you select an item, the setting screen appears.

Operation	Touch operation	Description
	Drag	Used to make adjustments
▲	[WB K Set]	Used to display the color temperature setting screen (→136) (Only when [White Balance] is set to [K])
▼	[Adjust.]	Used to display the White Balance fine adjustment screen (→137) (Only when [White Balance] is set)
[DISP.]	[DISP.]	Used to display the comparison screen
[MENU/SET]	[Set]	Used to finalize an adjustment you just made and to return to the item selection screen

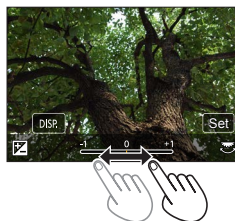

- If you have selected [Noise Reduction], [i.Resolution], or [Sharpness], the comparison screen is not displayed.
- Pictures can be enlarged by operating the zoom lever.
- You can also zoom in by quickly touching the touch screen twice. (If the display was enlarged, it returns to the same magnification ratio.)

The following operating methods are available to make adjustments on the comparison screen.

Operation	Touch operation	Description
	Drag	Used to make adjustments
[DISP.]	[DISP.]	Used to return to the setting screen
[MENU/SET]	[Set]	Used to finalize an adjustment you just made and to return to the item selection screen

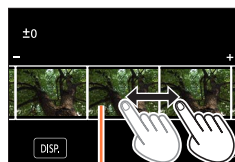

Current setting

- If you touch the picture at the center, it will be enlarged. If you touch [⏏], the picture will be reduced to the original size.

Using the [Playback] menu

When [Setup] is selected

When you select an item, the screen for selecting [Reinstate Adjustments], [Color Space], or [Picture Size] is displayed.

- ① Use ▲▼ to select the item and press [MENU/SET]
 - When [Reinstate Adjustments] is selected, confirmation screen is displayed. When you select [Yes], the item selection screen reappears.
- ② Use ▲▼ to select the setting and press [MENU/SET]

- The result of a RAW file developed by this camera and a RAW file developed by the software "SILKYPIX Developer Studio SE" (→354) will not be exactly the same.
- Regardless of the aspect ratio of the picture during recording, a RAW image recorded on this camera is always recorded with the aspect ratio set to [3:2] (5472×3648), but if you perform [RAW Processing] from the [Playback] menu, the picture will be processed with the aspect ratio fixed as that at the time of recording.
- The range that can be set using Exposure Compensation varies from the range used during recording.
- The [White Balance] setting of still pictures recorded using [Multi Exp.] is fixed to the setting used during recording.
- When an HDMI micro cable is connected, [RAW Processing] is disabled.
- You can perform RAW processing on pictures recorded using this unit only. [RAW Processing] cannot be used for pictures recorded on other devices or for pictures recorded in formats other than the RAW format.



[Light Composition]

Select multiple frames from 4K burst files recorded in 4K Photo mode (→184) that you wish to combine. Parts of the image that are brighter than the preceding frame will be superimposed on the preceding frame to combine the frames into one picture.



1 Set the menu

MENU → **[Playback]** → **[Light Composition]**

2 Using ◀▶, select the 4K photo burst files and press [MENU/SET]

3 Choose the combining method and press [MENU/SET]

■ When [Composite Merging] is selected

Select the frames you wish to combine, and then camera superimposes brighter parts of the image.

① Select the frames

For button and touch operation, refer to (→193).

- Images displayed cannot be enlarged or shrunk or shown as in slide view
- **[OK]** in touch operation becomes **[OK]**.

② Press [MENU/SET]

The selected frames are remembered, and the display goes to the preview screen.

Use ▲▼ to select items and press [MENU/SET] to perform the following operations.

- [Next]: Lets you select more frames for combining. Goes back to step ①.
- [Reselect]: Discards the frame selected immediately before and lets you select a different image.
- [Save]: Ends frame selection.

③ Repeat steps ① - ② to select more frames to combine

- You can select up to 40 frames.

④ Press ▼ to select [Save], and then press [MENU/SET]

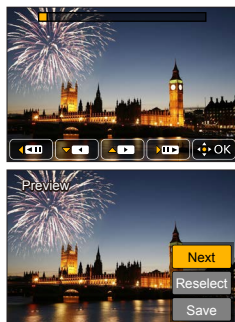

■ When [Range Merging] is selected

Select the first and last frames, and the brighter parts of frames within that range will be superimposed.

① Select the frame of the first picture

The selection method is the same as in step ① when selecting [Composite Merging].

② Press [MENU/SET]

The position of the first picture will be remembered.

③ Select the frame of the last picture**④ Press [MENU/SET]**

The position of the last picture will be remembered.

4 Select [Yes] at the confirmation screen and press [MENU/SET]

The combined picture is displayed.

- Pictures are saved in JPEG format. Recording information (Exif information) such as shutter speed, aperture, and ISO sensitivity are also registered.



Using the [Playback] menu

[Clear Retouch]

You can erase unnecessary parts recorded on the pictures taken.

- The erasure operation can only be performed by touching. [Clear Retouch] automatically enables the touch operation.

**1 Set the menu**

MENU → **[Playback]** → **[Clear Retouch]**

2 Use ◀▶ to select a still picture and press [MENU/SET]**3 Drag your finger over the part you want to erase**

- The parts to be erased are colored.
- Touching [Undo] will return the colored part back to its previous state.

**Erasing details (enlarging the display)****① Touch [SCALING]**

- On the touch screen, pinch out your two fingers to zoom in, and pinch in your two fingers to zoom out (→61).
- You can also zoom in/out with the zoom lever.
- Dragging the screen allows you to move the enlarged part.

② Touch [REMOVE]

- This will bring you back to the operation of dragging your finger over the part you want to erase. The part you want to erase can be dragged even while the picture is enlarged.

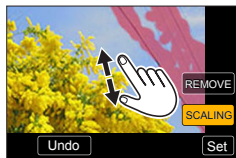
**4 Touch [Set]****5 Touch [Save] or press [MENU/SET]**

- Pictures may appear unnatural because the background of deleted parts is artificially created.
- For group pictures, perform [Clear Retouch] on each picture. (They cannot be edited at once.)
- When [Clear Retouch] is performed on group pictures, they are saved as new pictures separate from the original ones.
- Not available when the viewfinder is in use.
- This function is not available in the following cases:
 - Panorama pictures
 - Motion pictures
 - 4K burst files
 - Pictures recorded using [Post Focus]
 - Still pictures recorded with the [Quality] setting [RAW]

Using the [Playback] menu

[Title Edit]

You can enter characters (titles etc.) on a recorded picture. After text has been registered, it can be stamped in prints using [Text Stamp] (→291).

1 Set the menu

MENU →  **[Playback]** → **[Title Edit]** → **[Single]** or **[Multi]**

2 Select a still picture (→279)

-  is displayed for pictures with texts already stamped.

3 Enter characters (Entering text (→87))

- To delete texts, delete all the characters in the character input screen.

- You can print out texts using the “PHOTOfunSTUDIO” software (→353).
- You can set up to 100 pictures at one time with [Multi].
- This function is not available in the following cases:
 - Motion pictures
 - 4K burst files
 - Pictures recorded using [Post Focus]
 - Still pictures recorded with the [Quality] setting [RAW:📷], [RAW:📷] or [RAW]

[Text Stamp]

You can stamp the recording date and time, names, travel destination, travel dates, etc. on the recorded still pictures.

1 Set the menu

[MENU] →  **[Playback]** → **[Text Stamp]** → **[Single]** or **[Multi]**



2 Select a still picture (→279)

-  appears on screen if the picture is stamped with text.

3 Use ▲ ▼ to select [Set] and press [MENU/SET]

4 Use ▲ ▼ to select the item and press [MENU/SET]

5 Use ▲ ▼ to select the setting and press [MENU/SET]

[Shooting Date]	[W/O TIME]: Stamp recording date [WITH TIME]: Stamp recording date and time
[Name]	 : Stamp name registered in Face Recognition  : Stamp name registered in [Profile Setup]
[Location]	Stamp location registered in [Setup] menu's [Travel Date]
[Travel Date]	Stamp number of days that have elapsed since the travel date set in [Setup] menu's [Travel Date]
[Title]	Stamp text registered in [Title Edit]

6 Press [Q.MENU/↵] button

7 Use ▲ to select [OK] and press [MENU/SET]

- **Do not request date printing in store or make date printing on printer for still pictures with date stamps. (Date printing may be overlapped.)**
- You can set up to 100 pictures at one time with [Multi].
- The picture quality may be coarser.
- If you stamp text on the pictures in a group, those pictures are saved as new pictures.
- This function is not available in the following cases:
 - Motion pictures
 - 4K burst files
 - Pictures recorded using [Post Focus]
 - Still pictures recorded with the [Quality] setting [RAW]
 - Panorama pictures
 - Still pictures that other texts had already been stamped
 - Still pictures taken without setting clock

Using the [Playback] menu

[Video Divide]

A single motion picture can be split into 2 parts. This is convenient when you want to keep just the necessary scenes, or if you wish to delete unnecessary scenes to increase free space on your card, such as when traveling.

1 Set the menu

MENU → **[Playback]** → **[Video Divide]**

2 Use ◀▶ to select a motion picture to split and press [MENU/SET]**3 Press ▲ at where you want to split a motion picture to pause it**

- If you press ◀▶ while paused, you can make finer adjustments to the splitting positions in a motion picture.

4 Press ▼

- **The original motion picture that was split does not remain.**
(There will only be the 2 motion pictures that were created after the split.)



- During dividing, do not turn off the camera or remove the card or battery. If you do so, the motion picture may be deleted.
- Motion pictures cannot be divided at a location close to the start or end of the motion picture.
- This function is not available in the following cases:
 - Pictures recorded using [Post Focus]
 - Motion pictures with a short recording time

[Time Lapse Video]

You can create a motion picture from the pictures in a group that was recorded using [Time Lapse Shot]. The motion picture you created is saved in the MP4 recording format.

1 Set the menu

MENU →  **[Playback]** → **[Time Lapse Video]**

2 Use ◀▶ to select the [Time Lapse Shot] picture group and press [MENU/SET]

3 Create a motion picture after selecting a production method

- For details, refer to step 5 and the subsequent steps (→217).
For details on the motion picture you created, refer to (→218).

[Stop Motion Video]

You can create a motion picture from the pictures in a group that was recorded using [Stop Motion Animation]. The motion picture you created is saved in the MP4 recording format.

1 Set the menu

MENU →  **[Playback]** → **[Stop Motion Video]**

2 Use ◀▶ to select a stop motion animation group and press [MENU/SET]

3 Create a motion picture after selecting a production method

- For details, refer to step 8 and the subsequent steps (→221).
For details on the motion picture you created, refer to (→222).

Using the [Playback] menu

[Resize]

Picture size can be reduced to facilitate e-mail attachment and use in web pages, etc.

1 Set the menu

[MENU] → **[Playback]** → **[Resize]** → **[Single]** or **[Multi]**

2 Select a still picture and size**[Single]**

- ① Use ◀▶ to select a still picture and press [MENU/SET]
- ② Use ▲▼ to select size and press [MENU/SET]

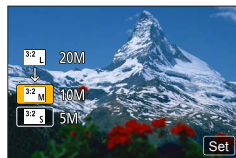
**[Multi] (up to 100 pictures)**

- ① Use ▲▼ to select size and press [MENU/SET]
- ② Use ▲▼◀▶ to select a still picture and press [MENU/SET] (repeat)
 - To cancel → Press [MENU/SET] again.
- ③ Use ◀ to select [OK] and press [MENU/SET]

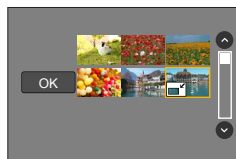

- Picture quality is reduced after resizing.
- This function is not available in the following cases:
 - Motion pictures
 - 4K burst files
 - Pictures recorded using [Post Focus]
 - Still pictures recorded with the [Quality] setting [RAW]
 - Panorama pictures
 - Group pictures
 - Still pictures that other texts had already been stamped

[Cropping]



Enlarge your still pictures and crop unwanted areas.

1 Set the menu

MENU →  **[Playback]** → **[Cropping]**

2 Use ◀▶ to select a still picture and press [MENU/SET]

3 Select area to crop and press [MENU/SET]

- You can also touch  /  to enlarge/reduce.
- You can also move by dragging on the screen.

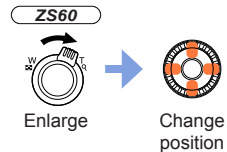
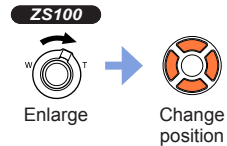

- Perform cropping for each picture in the group. (You cannot edit pictures in group units.)
- If you crop a picture in the group, it is saved as a new picture.
- Original Face Recognition information will not be copied when still pictures are cropped.
- Picture quality is reduced after cropping.
- This function is not available in the following cases:
 - Motion pictures
 - 4K burst files
 - Pictures recorded using [Post Focus]
 - Still pictures recorded with the [Quality] setting [RAW]
 - Panorama pictures
 - Still pictures that other texts had already been stamped

Using the [Playback] menu

[Rotate] / [Rotate Disp.]

You can automatically display a still picture recorded in portrait orientation by taking the picture with the camera held vertically, or manually rotate the picture in 90-degree units.

[Rotate] Rotating a picture manually

- You cannot select [Rotate] when [Rotate Disp.] is set to [OFF].

1 Set the menu

MENU →  **[Playback]** → **[Rotate]**

2 Use ◀▶ to select picture and press [MENU/SET]

- You cannot rotate group pictures.

3 Use ▲▼ to select the rotation direction and press [MENU/SET]

: Rotate a picture 90 degrees clockwise.

: Rotate a picture 90 degrees counterclockwise.

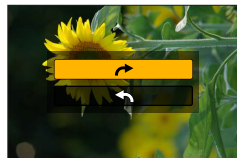
**[Rotate Disp.] Rotating a picture automatically to display****1 Set the menu**

MENU →  **[Playback]** → **[Rotate Disp.]** → **[ON]**

- When you play back pictures on a PC, they cannot be displayed in the rotated direction unless the OS or software is compatible with Exif. Exif is a file format for still pictures which allows recording information, etc. to be added. It was established by "JEITA (Japan Electronics and Information Technology Industries Association)".
- A picture may not be automatically rotated to display it with portrait orientation on the Multi Playback screen, which is displayed for settings such as [Delete Multi].

Using the [Playback] menu

[Favorite]

By labeling your favorite pictures with a star [★], you can play back your favorite pictures only, or you can delete all pictures except your favorites.

1 Set the menu

[MENU] →  [Playback] → [Favorite] → [Single] or [Multi]

2 Select picture (→279)**To clear all**

In step **1**, select [Favorite] → [Cancel] → [Yes], and then press [MENU/SET]

- Up to 999 pictures can be set.
- When you set [Favorite] for a picture in a group, the number of pictures set is displayed with the [Favorite] icon of the first picture.
- Only when [Playback Mode] is set to [Normal Play], you can select [Cancel].
- This function is not available in the following case:
 - Still pictures recorded with the [Quality] setting [RAW]

[Print Set]

Picture/picture no./date printing settings can be made for when printing with DPOF print-compatible shops or printers. (Contact the local photo printing store or read operating instructions of the printer to check if DPOF is supported.)

For more information visit:

http://panasonic.jp/dc/dpof_110/white_e.htm

1 Set the menu

MENU → **[Playback]** → **[Print Set]** → **[Single]** or **[Multi]**

2 Select a still picture (→279)

3 Use ▲▼ to set number of still pictures and press [MENU/SET] (up to 999 pictures)

(Repeat steps 2 and 3 when using [Multi])

- Date print setting/release → Press .

■ To clear all

In step 1, select [Print Set] → [Cancel] → [Yes], and then press [MENU/SET]

- When you have performed [Print Set] for pictures in a group, the setting for how many prints to make applies to all pictures in the group, and the number of prints set and total number of prints are shown on the print settings icon of the first picture. If the total number of pictures is 1,000 or higher, [999+] is displayed.
- Date print setting cannot be made for pictures with a [Text Stamp] applied.
- Depending on the type of printer, the printer settings may take priority over camera settings.
- Some DPOF information (print settings) set by other equipment cannot be used. In such cases, delete all of the DPOF information and then set it again with this camera.
- This function is not available in the following cases:
 - Motion pictures
 - 4K burst files
 - Pictures recorded using [Post Focus]
 - Still pictures recorded with the [Quality] setting [RAW]
 - Cannot be set for files that are not compliant with the DCF standard

[Protect]

Set protection to disable picture deletion. Prevents deletion of important pictures.

1 Set the menu

MENU →  **[Playback]** → **[Protect]** → **[Single]** or **[Multi]**

2 Select picture (→279)

■ To clear all

In step **1**, select **[Protect]** → **[Cancel]** → **[Yes]**, and then press **[MENU/SET]**



When you set the write-protect switch on the card to the “LOCK” position, the picture is not erased.

- The picture is erased when formatting, even if it is protected.
- May not be effective when using other devices.
- When you set **[Protect]** for a picture in a group, the number of pictures set is displayed with the **[Protect]** icon of the first picture.

[Face Rec Edit]

Edit or delete the recognition information for pictures with incorrect information.

1 Set the menu

MENU →  **[Playback]** → **[Face Rec Edit]** → **[REPLACE]** or **[DELETE]**

2 Use ◀▶ to select picture and press [MENU/SET]

3 Use ◀▶ to select a person and press [MENU/SET]

- If **[DELETE]**, go to step **5**.

4 Use ▲▼◀▶ to select the person to replace for another and press [MENU/SET]

5 Use ◀▶ to select [Yes] and press [MENU/SET]

- When Face Recognition information is deleted, it cannot be restored.
- Pictures for which all Face Recognition information has been deleted are not categorized in Face Recognition during **[Category Play]** or **[Category Selection]**.
- Edit the Face Recognition information in group units for a picture group. (You cannot edit the information for each picture in a group.)
- You can edit only the first picture in a group.

[Picture Sort]

You can set the display sequence used for playing back pictures on this unit.

1 Set the menu

MENU →  **[Playback]** → **[Picture Sort]**

2 Use ▲ ▼ to select the item and press [MENU/SET]

[FILE NAME]	Displays pictures in the folder name or file name sequence. This display format allows you to find the storage location of a picture on a card more easily.
[DATE/TIME]	Displays pictures according to the date and time that the pictures were taken in chronological order. When the pictures are taken using several cameras and stored on the same card, this display format allows you to find a specific picture more easily.

- Pictures may not be displayed according to the [DATE/TIME] sequence immediately after a card is inserted into this unit. In that case, wait a while, and the pictures will be displayed in the [DATE/TIME] sequence.

What you can do with the Wi-Fi® function

Operating the camera by connecting it to a smartphone/tablet (→305)

- Taking pictures via a smartphone (remote recording)
- Playing back pictures in the camera on a smartphone
- Saving pictures in the camera to a smartphone
- Sending pictures in the camera to social networking services
- Writing the location information on pictures in the camera
- Combining motion pictures recorded with Snap Movie according to your preference on a smartphone



Connect easily

You can easily set up a direct connection to your smartphone without entering a password.

Displaying still pictures on a TV (→318)

Wireless printing (→323)

Sending pictures to AV device (→324)

Still pictures and motion pictures can be sent to AV device in the home (home AV device).

Sending pictures to a PC (→325)

Using WEB services (→327)

Through “LUMIX CLUB”, you can send still pictures and motion pictures to social networking services, etc. You can receive still pictures and motion pictures on a PC or a smartphone/tablet using the Cloud Sync. Service.

- Hereafter, this manual uses the term “smartphone” for both smartphones and tablets unless it is necessary to distinguish between them.



Wi-Fi Function

■ Before Use

- Complete the date and time settings in advance. (→42)
- To use the Wi-Fi function on this unit, a wireless access point or a destination device equipped with the wireless LAN function is required.

■ Lighting of the Wi-Fi connection lamp when the Wi-Fi function is in use

ZS100

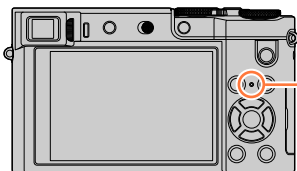

Lit: When the Wi-Fi function is ON or connected by Wi-Fi

Blinking: When sending picture data

ZS60

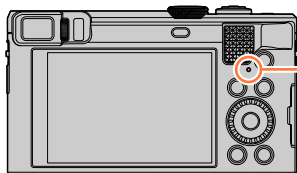

■ About the [Wi-Fi] button

In this Owner's Manual, a function button to which [Wi-Fi] is assigned is referred to as the [Wi-Fi] button. (At the time of purchase, [Wi-Fi] is assigned to [Fn5] button.)

- For details on the function button, refer to (→70).

To start up the Wi-Fi function:

① Touch [Fn]



② Touch [Wi-Fi]



- Before a Wi-Fi connection is established, press the [Wi-Fi] button to perform the following operations:

- The information (SSID) required for directly connecting your smartphone to this unit is displayed.
- You can select the following items by pressing [DISP.] button.

[New Connection]

[Select a destination from History] (→342)

[Select a destination from Favorite] (→342)



SSID

- You can also display the same menu by selecting **MENU** → [Setup] → [Wi-Fi] → [Wi-Fi Function].
 - This manual provides information on the process when [New Connection] is selected.
- Pressing the [Wi-Fi] button during a Wi-Fi connection enables the following operation.

[Terminate the Connection]	Terminates the Wi-Fi connection.
[Change the Destination]* ¹	Terminates the Wi-Fi connection, and allows you to select a different Wi-Fi connection.
[Change Settings for Sending Images]* ²	For details (→321).
[Register the Current Destination to Favorite]* ¹	Registering the current connection destination or the connection method, you can easily connect with the same connection method next time.
[Network Address]	For details (→345).

*¹ This item will not be displayed if you press ▼ to send pictures to WEB services while the pictures are displayed (→330).

*² This item will not be displayed if the destination for [Remote Shooting & View], [Playback on TV] or [Send Images Stored in the Camera] is set to [Printer].



■ Describing method

When “**select [Select a destination from History]**”, etc. is described in a step, perform any of the following operations.

With cursor button operations

Use cursor button to select [Select a destination from History] and press [MENU/SET].

With touch screen operations

Touch [Select a destination from History].

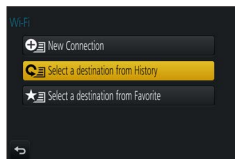

- **Do not remove the memory card or battery or move to an area without any reception while sending images.**
- The camera cannot be used to connect to a public wireless LAN connection.
- Use a IEEE802.11b, IEEE802.11g or IEEE802.11n compatible device when using a wireless access point.
- We recommend that you use a fully charged battery when you send pictures.
- When sending images on a mobile network, high packet communication fees may be incurred depending on the details of your contract.
- Pictures may not be completely sent depending on radio wave conditions. If the connection is terminated while sending pictures, pictures with missing sections may be sent.
- The monitor display may become distorted for an instant while connected to the service, however this will not affect the image being sent.





Operating the camera by connecting it to a smartphone

You can remotely operate the camera using a smartphone.

The "Panasonic Image App" (hereafter "Image App") must be installed on your smartphone.

Installing the smartphone/tablet app "Panasonic Image App"

	For Android™ apps	For iOS apps
Supported OS	Android 4.0 or later	iOS 7.0 or later
Installation procedure	① Connect your Android device to a network ② Select "Google Play™ Store" ③ Enter "Panasonic Image App" or "LUMIX" to search for the app ④ Select "Panasonic Image App" and install it • The icon will be added to the menu. 	① Connect the iOS device to the network ② Select "App Store SM " ③ Enter "Panasonic Image App" or "LUMIX" to search for the app ④ Select "Panasonic Image App" and install it • The icon will be added to the menu. 

- Use the latest version.
- Supported OS versions as of January 2016. Supported OS versions may be changed without prior notice.
- The service may not be able to be used properly depending on the type of smartphone being used.

For the latest information on the "Image App", refer to the support site below.
<http://panasonic.jp/support/global/cs/dsc/> (This site is available in English only.)

- When downloading the app on a mobile network, high packet communication fees may be incurred depending on the details of your contract.
- For details about the operating procedure, etc., refer to [Help] in the "Image App" menu.
- If you connect the camera and smartphone over a Wi-Fi connection and run "Image App", [Help] may not be displayed in the "Image App" menu for some smartphones. In such a case, disconnect the Wi-Fi connection with the camera, connect the camera to a cellular data line such as 3G and LTE, or the Internet to display [Help] in the "Image App" menu.
- Some of the screens and information provided in this document may be different depending on the supported operating system and "Image App" version.

Operating the camera by connecting it to a smartphone

Connecting to a smartphone

You can easily establish a Wi-Fi connection on this unit without entering a password on your smartphone.

Preparation

(On the camera) Set [Wi-Fi Password] to [OFF]. (→344)

(On your smartphone) Install "Image App" in advance. (→305)

[Wi-Fi Password] is set to [OFF] at the time of purchase. In [OFF] state, a third party can tap into the Wi-Fi transmission and steal transmitted data. To set [Wi-Fi Password] to [ON], refer to (→308).

- It may take some time for the operation to end after operating a smartphone.

1 Select the menu on the camera

MENU → **[Setup]** → **[Wi-Fi]** → **[Wi-Fi Function]** → **[New Connection]**
→ **[Remote Shooting & View]**

- The information required for directly connecting your smartphone to this unit (SSID) is displayed.
- You can also display the information by pressing [Wi-Fi] button on the camera.
- To change the connection method, refer to (→310).



SSID

2 Operate the smartphone

- The connection method differs depending on the smartphone used.

Operating the camera by connecting it to a smartphone

■ Using an iOS device

- ① Turn on the Wi-Fi function in the setting menu of the smartphone



- ② Select the SSID displayed on the screen of this unit



- ③ Return to the home screen and start "Image App" (→305)
- When the connection confirmation screen appears on this unit, select [Yes] and press [MENU/SET]. (Only when making a connection for the first time.)

■ Using an Android device

- ① Start "Image App" (→305)
- If a message appears stating that a camera search is in progress, close the message.
- ② Select [📶]
- ③ Select the SSID displayed on this unit
- When the connection confirmation screen appears on this unit, select [Yes] and press [MENU/SET]. (Only when making a connection for the first time.)

Operating the camera by connecting it to a smartphone

Using a password to set up a connection

When [Wi-Fi Password] is set to [ON], you can strengthen security by using manual input or a QR code for password authentication.

Preparation

(On the camera) Set [Wi-Fi Password] to [ON]. (→344)

(On your smartphone) Install “Image App” in advance. (→305)

1 Select the menu on the camera

MENU → **[Setup]** → **[Wi-Fi]** → **[Wi-Fi Function]** → **[New Connection]**
→ **[Remote Shooting & View]**

- The information (QR Code, SSID and Password) required for directly connecting your smartphone to this unit is displayed.
- You can also display the information by pressing [Wi-Fi] button on the camera.
- Switching the connection method (→310)



SSID and Password

QR Code

2 Operate the smartphone

- The connection method differs depending on the smartphone used.

Operating the camera by connecting it to a smartphone

■ Using an iOS device

- When reading a QR Code to connect
(Steps ① to ⑤ are not necessary when reconnecting.)
 - ① Start "Image App" (→305)
 - ② Select [] → [OK]
 - ③ Read the QR Code displayed on this unit with "Image App"
(When you press [MENU/SET] on the camera, the QR code is displayed in an enlarged size.)
 - When the smartphone is connected to a wireless access point, it may take time to display QR code.
 - ④ Install the profile
 - The message is displayed in the Web browser.
 - If a passcode is required to unlock the smartphone, you will have to input the passcode.
 - ⑤ Press the home button to close the Web browser
 - ⑥ Turn on the Wi-Fi function in the setting menu of the smartphone



- ⑦ Select the SSID displayed on the screen of this unit



- ⑧ Return to the home screen and start "Image App" (→305)
- When connecting with SSID and password
 - ① Turn on the Wi-Fi function in the setting menu of the smartphone
 - ② Select the SSID displayed on the screen of this unit
 - ③ Enter the password displayed on this unit (First time connecting only)
 - ④ Return to the home screen and start "Image App" (→305)

Operating the camera by connecting it to a smartphone

■ Using an Android device

- When reading a QR Code to connect
 - ① Start “Image App” (→305)
 - ② Select [📷]
 - ③ Read the QR Code displayed on this unit with “Image App”
(When you press [MENU/SET] on the camera, the QR code is displayed in an enlarged size.)
 - When the smartphone is connected to a wireless access point, it may take time to display QR code.
- When connecting with SSID and password
 - ① Start “Image App” (→305)
 - If a message appears stating that a camera search is in progress, close the message.
 - ② Select [📶]
 - ③ Select the SSID displayed on this unit
 - ④ Enter the password displayed on this unit (First time connecting only)
 - If you check the item to display the password, you can confirm the password as you enter it.

Changing the connection method

To change the connection method, follow the steps below:

(When the connection is made using [Wi-Fi] in the [Setup] menu)
Press [DISP.] button

(When the connection is made by pressing [Wi-Fi] button)

Wi-Fi → [DISP.] button → [New Connection] → [Remote Shooting & View] → [DISP.] button

■ When connecting with [Via Network]

(On the camera)

- ① Select [Via Network] and press [MENU/SET]
 - Connect the camera to a wireless access point by following the connection method (→338).

(On your smartphone)

- ② Set Wi-Fi function to “ON”
- ③ Select the wireless access point you connected to the camera, and set
- ④ Start “Image App” (→305)



Operating the camera by connecting it to a smartphone

■ When connecting with [Direct]

(On the camera)

① Select [Direct] and press [MENU/SET]

- Select [Wi-Fi Direct] or [WPS Connection]*, and connect the camera to the smartphone by following the connection method (→341).

*WPS refers to a function that allows you to easily configure the settings related to the connection and security of wireless LAN devices. To check if the smartphone you are using is compatible with WPS, refer to the instruction manual of the smartphone.

(On your smartphone)

② Start “Image App” (→305)

Closing the connection

(On the camera)

1 On the recording standby screen, terminate the connection from the menu of the camera

MENU →  **[Setup]** → **[Wi-Fi]** → **[Wi-Fi Function]** → **[Yes]**

- You can also terminate the connection by pressing [Wi-Fi] button on the camera (→303).

(On your smartphone)

2 Close “Image App”

<Using an iOS device>

From the “Image App” screen, press the home button on the smartphone to close the app

<Using an Android device>

From the “Image App” screen, press the back button on the smartphone twice to close the app

- When recording with [4K Pre-Burst] with the smartphone, terminate the connection only after switching to 4K Burst recording by pressing [Q.MENU/🔄] button on the camera.

Taking pictures via a smartphone (remote recording)

1 Connect to a smartphone (→306)

2 Operate the smartphone

- ① Select [
- ② Take pictures
 - The recorded images are saved in the camera.
 - Some settings are not available.

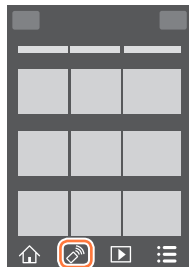

- When using zoom, the camera could tilt when the lens barrel extends. Make sure to secure the camera in place with a tripod or by other means.
- This function is not available in the following cases:
 - Panorama Shot Mode
 - When using [Time Lapse Shot]
 - When [Snap Movie] is set to [ON]



Taking a picture while jumping

When you hold your smartphone and jump, the camera's shutter can be released automatically as the smartphone detects the peak of the jump.

1 [] → [] → Select the sensitivity

- [] will be displayed on the remote recording screen of the smartphone.
- We recommend that you take test pictures.
- For details about the operating procedure, refer to [Help] in the "Image App".



Playing back pictures in the camera on a smartphone

1 Connect to a smartphone (→306)

2 Operate the smartphone

① Select [▶]

- You can switch a device of pictures to be displayed using the icon at the top left on the screen. Select [LUMIX] to display a picture saved in the camera.
- When the picture is touched, it is played back at a larger size.

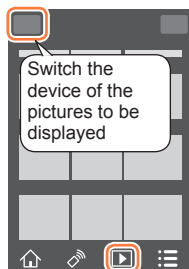

- When playing back motion pictures, the data size is reduced during transmission of motion pictures to "Image App". Therefore, the picture quality may be different from the actual motion picture that you have recorded. Depending on your smartphone and its usage environment, you may notice degradation in the picture quality or skipping of sound when playing back motion pictures and still pictures.

Saving pictures in the camera to a smartphone

1 Connect to a smartphone (→306)

2 Operate the smartphone

① Select [▶]

- You can switch a device of pictures to be displayed using the icon at the top left on the screen. Select [LUMIX] to display a picture saved in the camera.

② Press and hold the picture and drag it to save it on the smartphone



- Functions can be assigned to the top, bottom, left and right as you wish.

- RAW still pictures, AVCHD motion pictures, MP4 motion pictures for which the [Rec Quality] size is [4K], 4K burst files, and pictures recorded with [Post Focus] cannot be saved.

Sending pictures in the camera to social networking services

1 Connect to a smartphone (→306)

2 Operate the smartphone

① Select [▶]

- You can switch a device of pictures to be displayed using the icon at the top left on the screen. Select [LUMIX] to display a picture saved in the camera.

② Press and hold the picture and drag it to send it to the social networking service, etc.

- The picture will be sent to the social networking service or other WEB services.

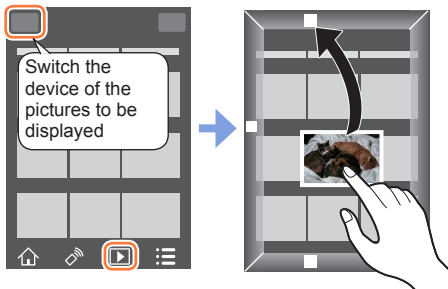

- Functions can be assigned to the top, bottom, left and right as you wish.

Adding location information to pictures in the camera from a smartphone



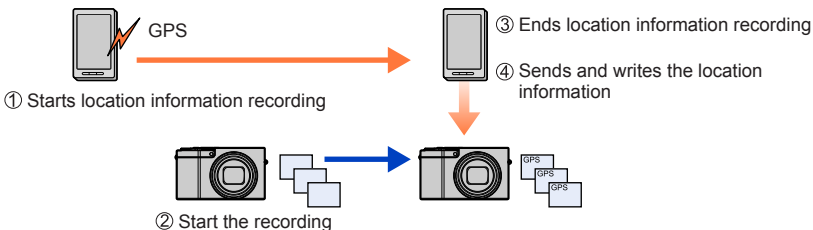

You can send the location information acquired from a smartphone to the camera. After the information is sent, you can write it on the pictures in the camera.



- You can also use [Location Logging] in the [Playback] menu to write the sent location information to the pictures.
- Location information that is different from the information acquired during recording may be written. Take care regarding the following matters.
 - Set [Home] of [World Time] of the camera to your home area.
 - Once a smartphone starts recording the location information, do not change the [Home] setting of [World Time] of the camera.
- The location information cannot be written to pictures recorded without setting [Clock Set].

Operating the camera by connecting it to a smartphone

■ Recording location information and taking pictures



- ① Start recording the location information on your smartphone
 - ❶ Start "Image App" (→305)
 - ❷ Select []
 - ❸ Select []
 - ❹ Select [ Start geotagging]
- ② Take pictures using the camera
- ③ End recording of the location information on your smartphone
 - ❶ Select [ Stop geotagging] to end recording of location information



■ Writing location information to a picture

Preparation

(On the camera) Connect to a smartphone. (→306)

- ④ Operate the smartphone
 - ❶ Start "Image App" (→305)
 - ❷ Select []
 - ❸ Select []
 - ❹ Select [] to send or write location information
 - Follow the messages on the screen to perform the operation.
 - [GPS] is displayed for pictures that have location information written to it.



- The smartphone battery drains faster while location information is being recorded. When recording of location information is not necessary, stop it.
- For details about the operating procedure, etc., refer to [Help] in the "Image App" menu.
 - On the smartphone, you can set the acquisition interval of location information and check the transfer status of location information
- The location information cannot be written in the following cases:
 - Images recorded after location information was sent to the camera
 - Pictures that already have location information
 - Motion pictures recorded in [AVCHD] format
 - Protected pictures
 - There is not enough free space on your card
 - Card switch is in "LOCK" position
 - When connected to computer/printer
 - Pictures recorded using cameras other than this unit

Combining motion pictures recorded with Snap Movie according to your preference on a smartphone

Using a smartphone, you can combine motion pictures recorded with the camera's [Snap Movie] function (→262). Music can be added to motion pictures to be combined. In addition, you can save the combined motion picture or upload it on a web service.

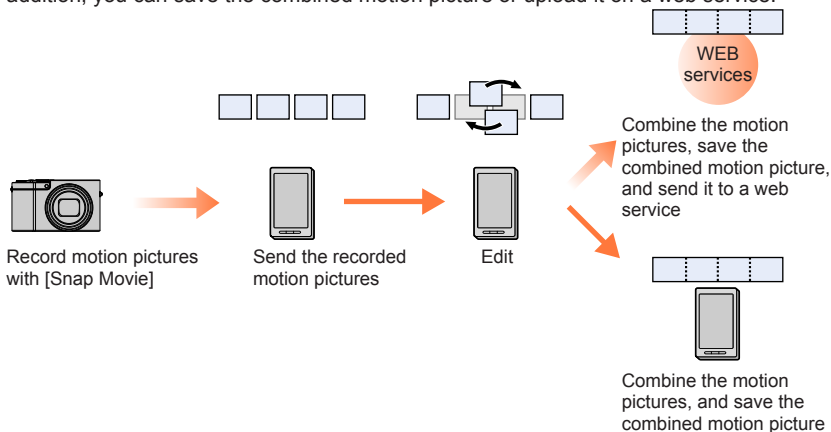

Operating the camera by connecting it to a smartphone

■ Combining motion pictures by operating a smartphone

① Connect to a smartphone (→306)

② Operate the smartphone

① Select []



② Select []

- [Snap Movie] motion pictures with recent recording dates will be selected and automatically sent to the smartphone.
- When motion pictures with recent recording dates are not available, a screen that lets you select motion pictures will be displayed. Select motion pictures and send them.

③ Operate the smartphone to edit the motion pictures

- Read the [Help] in the "Image App" menu for further details on how to operate [Snap Movie] of "Image App".

- [Snap Movie] of the "Image App" requires a smartphone that supports Android OS 4.3 or higher.
- The iPhone 4 does not support [Snap Movie] of the "Image App".
- The smartphone may not be able to play back and save [Snap Movie] motion pictures recorded with another device.



Displaying still pictures on a TV

You can display still pictures on a TV that is compatible with a DLNA certified digital media renderer (DMR) function.

Preparation

Set the TV to DLNA waiting Mode.

- Read the operating instructions for your TV.

1 Set the menu

MENU →  [Setup] → [Wi-Fi] → [Wi-Fi Function] → [New Connection] → [Playback on TV]

2 Select [Via Network] or [Direct] to connect (→338, 341)

3 Select the device you wish to connect to

- When the connection is established, the screen is displayed.

4 Take or play back still pictures on this unit

- To terminate the connection, follow the steps below:

MENU →  [Setup] → [Wi-Fi] → [Wi-Fi Function] → [Yes]

(You can also close the connection by pressing the [Wi-Fi] button. (→303))

- When you display the pictures on a TV using the Wi-Fi function, they are not output using 4K resolution. To output pictures using 4K resolution, connect this unit to the TV using an HDMI micro cable. (→348)
- When a TV is connected to this unit, the TV screen may temporarily return to the status before the connection. Pictures are displayed again when you take or play back pictures.
- Even if [Effect] and [Sound] are set on this unit, these settings are disabled when the pictures are played back on a TV during Slide Show playback.
- Motion pictures and 4K burst files cannot be played back.
- During Multi Playback, Calendar Playback, or when selecting a focus position from a picture recorded in Post Focus, pictures displayed on the screen of the camera are not displayed on the TV.



Sending pictures

When sending pictures, first select [New Connection], then select the method of sending pictures.

After you have completed connecting, you can also change the sending settings, such as the size of pictures to be sent.

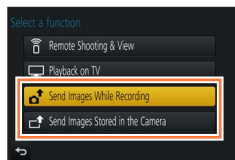

■ Images that can be sent

Destination	JPEG	RAW	MP4*1	AVCHD*1, *2	4K Burst File*1 Pictures recorded in [Post Focus]*1
[Smartphone] (→322)	○	—	○*3	—	—
[PC] (→325)	○	○	○	○	○
[Cloud Sync. Service] (→331)	○	—	○*3	—	—
[Web service] (→327)	○	—	○*3	—	—
[AV device] (→324)	○	—	—	—	—
[Printer]*1 (→323)	○	—	—	—	—

*1 Sending by [Send Images While Recording] is not available.

*2 Files larger than 4 GB cannot be sent.

*3 Excluding motion pictures recorded with [Rec Quality] of [4K].

- Some images may not be played back or sent depending on the device.
- For more information about picture playback, see the operating instructions of the destination device, or check the WEB service to which you will send the pictures.

[Send Images While Recording]

A picture can be automatically sent to a specified device every time you take it.

- [Wi-Fi] is displayed on the recording screen while connected by [Send Images While Recording], and [Send] is displayed while files are being sent.

- To terminate the connection, follow the steps below:

MENU → [Setup] → [Wi-Fi] → [Wi-Fi Function] → [Yes]

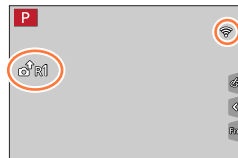

- You can terminate the connection or change the send settings by pressing [Wi-Fi] button. (→303)
You cannot change the settings while sending a still picture. Wait until sending is complete.

Sending pictures

- Since the camera gives priority to recording, sending may take longer during the recording.
- If you turn off the camera before you have completed sending, or if you close the Wi-Fi connection, or in similar situations, unsent files will not be resent.
- You may not be able to delete files or use the [Playback] menu while sending.
- Motion pictures, 4K burst files recorded with the 4K Photo function, and pictures recorded in [Post Focus] cannot be sent.
- If you set [Time Lapse Shot], the Wi-Fi connection is terminated and you cannot use this function.

[Send Images Stored in the Camera]

You can select and send recorded images.

■ How to select an image(s) after selecting [Single Select] or [Multi Select]**[Single Select]**

- ① Select the picture
- ② Select [Set]

**[Multi Select]**

- ① Select the picture (repeat)
 - If selected again, the setting will be canceled.
- ② Select [OK]
 - The number of pictures that can be sent by [Multi Select] is limited.

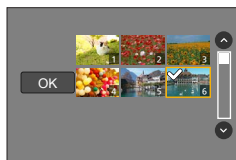

- To change the send settings on a screen that is displayed after the image has been sent, press [DISP.] button. To close the connection, select [Exit].

- Details of the [Playback] menu [Favorite] or [Print Set] settings will not be sent.
- Some images taken with a different camera may not be able to be sent.
- Images that have been modified or edited with a computer may not be able to be sent.

Changing the settings for sending images

After you have completed connecting, you can change the sending settings, such as the size of pictures to be sent, by pressing the [DISP.] button.

Item	Description
[Size]	Resize the image to send. [Original] / [Auto]*1 / [Change] <ul style="list-style-type: none"> If you select [Auto], the image size is determined by the circumstances at the destination. You can select the image size for [Change] from [M], [S], or [VGA]. The aspect ratio does not change.
[File Format]*2	[JPG] / [RAW+JPG] / [RAW]
[Delete Location Data]*3	Select whether to delete the location information from images before sending them. [ON]: Delete the location information, then send. [OFF]: Keep the location information and send. <ul style="list-style-type: none"> This operation only deletes the location information from the images that are set to be sent. (The location information will not be deleted from the original images stored in this unit.)
[Cloud Limit]*4	You can select whether to send images when the Cloud Folder runs out of free space. [ON]: Do not send images. [OFF]: Delete images from the oldest ones, then send new images.

*1 Only available when the destination is set to [Web service].

*2 Only available when the destination is set to [PC].

*3 Only available when the destination for [Send Images Stored in the Camera] is set to [Cloud Sync. Service] or [Web service].

*4 Only available when the destination is set to [Cloud Sync. Service].

Sending pictures to a smartphone

Preparation

Install "Image App" in advance. (→305)

1 Set the menu

MENU →  **[Setup]** → **[Wi-Fi]** → **[Wi-Fi Function]** → **[New Connection]**
 → **[Send Images While Recording]** / **[Send Images Stored in the Camera]**
 → **[Smartphone]**

2 Select [Via Network] or [Direct] to connect (→338, 341)

(On your smartphone)

■ When connecting with [Via Network]

- ① Set Wi-Fi function to "ON"
- ② Select a wireless access point and set
- ③ Start "Image App" (→305)

■ When connecting with [Wi-Fi Direct] or [WPS Connection] in [Direct]

- ① Start "Image App" (→305)

■ When connecting with [Manual Connection] in [Direct]

- ① Set Wi-Fi function to "ON"
- ② Select the SSID displayed on this unit
- ③ Start "Image App" (→305)

3 Select the device you wish to connect to

4 Check the send settings, and select [Set]

- To change the send setting, press the [DISP.] button. (→321)

[Send Images While Recording]

5 Take a still picture (→319)

[Send Images Stored in the Camera]

5 Select the picture (→320)



Wireless printing

You can print out recorded still pictures wirelessly from a PictBridge (wireless LAN-compatible)* printer.

* Compliant with the DPS over IP standards.

Contact the printer manufacturers for details on PictBridge (wireless LAN-compatible) printers.

1 Set the menu

MENU →  **[Setup]** → **[Wi-Fi]** → **[Wi-Fi Function]** → **[New Connection]**
→ **[Send Images Stored in the Camera]** → **[Printer]**

2 Select **[Via Network]** or **[Direct]** to connect (→338, 341)

3 Select a printer you want to connect

4 Select the still picture and print

- Pictures are selected the same way as when connecting by USB connection cable. For details (→358).
- To terminate the connection, press [Q.MENU/↵] button.
(You can also close the connection by pressing the [Wi-Fi] button. (→303))

● Motion pictures, 4K burst files, and pictures recorded with [Post Focus] cannot be printed.



Sending pictures to AV device

Still pictures and motion pictures can be sent to AV devices in the home (home AV devices), such as DLNA compatible recorders.

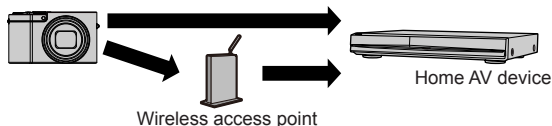

Preparations

When sending a picture to AV devices, set your device to DLNA waiting Mode.

- Read the operating instructions of your device for details.

1 Set the menu

MENU → [Setup] → [Wi-Fi] → [Wi-Fi Function] → [New Connection]
 → [Send Images While Recording] / [Send Images Stored in the Camera]
 → [AV device]

2 Select [Via Network] or [Direct] to connect (→338, 341)

3 Select the device you wish to connect to

4 Check the send settings, and select [Set]

- To change the send setting, press the [DISP.] button. (→321)

[Send Images While Recording]

5 Take a still picture (→319)

[Send Images Stored in the Camera]

5 Select the picture (→320)



Sending pictures to a PC

Still pictures and motion pictures recorded by the camera can be sent to a PC.

Preparations

- Turn the computer on.
- Prepare folders for receiving images on the PC before sending a picture to the PC (below).
- If the standard settings are changed for the workgroup on the connected PC, you must change settings in [PC Connection] on this unit. (→344)

To create a folder that receives images

- Create a PC user account (account name (up to 254 characters) and password (up to 32 characters)) consisting of alphanumeric characters. An attempt to create a receive folder may fail if the account includes non-alphanumeric characters.

■ When using “PHOTOfunSTUDIO”

- ① Install “PHOTOfunSTUDIO” on the PC (→353)
- ② Create a folder that receives images with “PHOTOfunSTUDIO”
 - For details, refer to the operating instructions of “PHOTOfunSTUDIO” (PDF).

■ When not using “PHOTOfunSTUDIO”

(For Windows)

Supported OS: Windows 10 / Windows 8.1 / Windows 8 / Windows 7

Example: Windows 7

- ① Select a folder you intend to use for receiving, then right-click
- ② Select [Properties], then enable sharing of the folder
 - For details, refer to the operating instructions of your PC or Help on the operating system.

(For Mac)

Supported OS: OS X v10.5 to v10.11

Example: OS X v10.8

- ① Select a folder you intend to use for receiving, then click on the items in the following order
[File] → [Get Info]
- ② Enable sharing of the folder
 - For details, refer to the operating instructions of your PC or Help on the operating system.

Sending pictures to a PC

1 Set the menu

MENU →  [Setup] → [Wi-Fi] → [Wi-Fi Function] → [New Connection]
→ [Send Images While Recording] / [Send Images Stored in the Camera]
→ [PC]

2 Select [Via Network] or [Direct] to connect (→338, 341)

3 Select the PC you want to connect to

- If the PC you want to connect to is not displayed, select [Manual Input], then enter the computer name (for Mac, enter the NetBIOS name).

4 Select the folder you want to send to

5 Check the send settings, and select [Set]

- To change the send setting, press the [DISP.] button. (→321)

[Send Images While Recording]

6 Take a still picture (→319)

[Send Images Stored in the Camera]

6 Select the picture (→320)

- Folders sorted by the sent date are created in the specified folder, and pictures are saved in those folders.
- If the screen for a user account and password entry appears, enter the one you set on your PC.
- If the computer name (for Mac, the NetBIOS name) contains spaces, etc., the name may not be properly recognized. If you cannot connect, we recommend changing the computer name (for Mac, the NetBIOS name) to a combination of 15 or less alphanumeric characters only.



Using WEB services

Through “LUMIX CLUB”, you can send still pictures and motion pictures to social networking services, etc. By selecting the setting to automatically transfer still pictures and motion pictures to [Cloud Sync. Service], you can receive the transferred still pictures and motion pictures on a PC or a smartphone.



When sending images to WEB service

Preparation

You need to register to “LUMIX CLUB” (→332) to send a picture to a WEB service.

To send images to a WEB service, you need to register the WEB service. (→328)

- Panasonic assumes no responsibility for the damages resulting from the leakage, loss, etc. of images uploaded on WEB services.
- When uploading images to the WEB service, do not delete images from this camera, even after they have finished sending, until you have checked that they have been properly uploaded to the WEB service. Panasonic assumes no responsibility for the damages resulting from the deletion of images stored in this unit.
- Images uploaded to the WEB service cannot be displayed or deleted with this camera. Check images by accessing the WEB service with your smartphone or computer.
- If sending images fails, a report email outlining the failure will be sent to the email address registered with “LUMIX CLUB”.



Registering the WEB service to “LUMIX CLUB”

Check the “FAQ/Contact us” on the following site for compatible WEB services.
http://lumixclub.panasonic.net/eng/c/lumix_faqs/

Preparation

Make sure that you have created an account on the WEB service you want to use, and have the login information available.

- 1 Connect to the “LUMIX CLUB” site using a smartphone or computer**
<http://lumixclub.panasonic.net/eng/c/>
- 2 Enter your “LUMIX CLUB” login ID and password and log in to the service**
- 3 If you have not registered your email address with “LUMIX CLUB”, register the email address**
- 4 Select the WEB service to be used for WEB service link settings and register it**
 - Follow the instructions on the screen to register the service.



Sending pictures

1 Set the menu

MENU →  [Setup] → [Wi-Fi] → [Wi-Fi Function] → [New Connection]
→ [Send Images While Recording] / [Send Images Stored in the Camera]
→ [Web service]

2 Select [Via Network] and connect (→338)

3 Select a WEB service you want to connect

4 Check the send settings, and select [Set]

• To change the send setting, press the [DISP.] button. (→321)

[Send Images While Recording]

5 Take a still picture (→319)

[Send Images Stored in the Camera]



5 Select the picture (→320)



Quickly sending pictures in the camera to WEB services

Once you send a picture, you can send pictures to the WEB service as quickly and easily as using a smartphone, only when the environment for connecting to a wireless access point is available.

(The instructions below assume that you are already registered to “LUMIX CLUB” and the camera has a record of a connection to a wireless access point.)

- ① Display the picture
 - When pictures are displayed as a group, they are all sent.
When a single picture in a group is displayed, only the picture being displayed is sent.
- ② Select [Yes] after pressing ▼
(When group pictures are being displayed, select [Upload(Wi-Fi)] → [Yes])
 - The same operation can be performed by touching [].
(When group pictures are selected, touch [], and select [Upload(Wi-Fi)].)
- ③ Select a WEB service you want to connect
- ④ Check the send settings, and select [Set]

The camera is connected to the previously used wireless access point and the pictures are sent to the WEB service.

 - Step ③, ④ are not necessary when you continue to send another image.
 - To change the transmission setting for the picture, press the [DISP.] button. (→321)
 - To terminate the connection, press [MENU/SET] or operate other controls to exit the playback screen. You can also terminate the connection by pressing [Wi-Fi] button on the camera. (→303)



To change the settings for sending images or web service

Terminate the Wi-Fi connection, and follow step ① and onwards again.

- You can also change the send settings by pressing [Wi-Fi] button while using a Wi-Fi connection. (→303)
- If the camera has no records of connections to wireless access points that are available, a screen that asks you to select a connection method is displayed. Select the connection method and connect the camera to a wireless access point. (→338)
 - When you are not registered to “LUMIX CLUB”, a screen that asks you to acquire a new login ID is displayed. Get a login ID and set a password. (→333)

When sending images to [Cloud Sync. Service]

Preparation

You need to register to "LUMIX CLUB" (→332) and configure the Cloud Sync. setting to send a picture to a Cloud Folder. Use "PHOTOfunSTUDIO" (→353) on a PC or "Image App" on a smartphone to configure the Cloud Sync. settings.

■ About the images sent to a Cloud Folder by the use of [Cloud Sync. Service] (Current as of January 2016)

- If you set the picture destination to [Cloud Sync. Service], sent pictures are temporarily saved in the cloud folder, and they can be synchronized with the device in use, such as the PC or smartphone.
- A Cloud Folder stores transferred images for 30 days (up to 1,000 pictures). Transferred images are deleted automatically 30 days after the transfer. Furthermore, when the number of stored images exceeds 1,000, some images may be deleted depending on the [Cloud Limit] (→321) setting even within 30 days after the transfer.
- When the download of images from a Cloud Folder to all specified devices is complete, images may be deleted from the Cloud Folder even within 30 days after the transfer.

1 Set the menu

MENU →  [Setup] → [Wi-Fi] → [Wi-Fi Function] → [New Connection] → [Send Images While Recording] / [Send Images Stored in the Camera] → [Cloud Sync. Service]

2 Check the message and press [MENU/SET]

3 Select [Via Network] and connect (→338)

4 Check the send settings, and select [Set]

- To change the send setting, press the [DISP.] button. (→321)

[Send Images While Recording]

5 Take a still picture (→319)

[Send Images Stored in the Camera]

5 Select the picture (→320)

Using “LUMIX CLUB”

About the [LUMIX CLUB]

Acquire a “LUMIX CLUB” login ID (free).

If you register this unit to the “LUMIX CLUB”, you can synchronize images between the devices you are using, or transfer these images to WEB services.

Use the “LUMIX CLUB” when uploading pictures to WEB services.

- You can set the same “LUMIX CLUB” login ID for this unit and a smartphone. (→335)

Refer to the “LUMIX CLUB” site for details.
<http://lumixclub.panasonic.net/eng/c/>

Please note;

- The service may be suspended due to regular maintenance or unexpected problems, and service contents may be changed or added to, without prior notice to the users.
- The service may be stopped in whole or in part with a reasonable period of advance notice.



Acquiring a new login ID ([New account])

1 Set the menu

MENU →  [Setup] → [Wi-Fi] → [Wi-Fi Setup] → [LUMIX CLUB]

2 Select [Set/Add Account]

3 Select [New account]

- Connect to the network. Proceed to the next page by selecting [Next].
- A confirmation screen will be displayed if a login ID has already been acquired for the camera. Select [Yes] to acquire a new login ID, or [No] if you do not need to acquire a new login ID.

4 Select the method for connecting to a wireless access point, and set

- For details (→338).
- The settings screen will only appear during the first connection. Connection methods set on this unit are stored and will be used for subsequent connections. If you want to change the wireless access point to connect to, press the [DISP.] button, then change the connecting destination.
- Proceed to the next page by selecting [Next].

5 Read through the "LUMIX CLUB" terms of use and select [Agree]

- You can press ▲▼ to switch pages.
- Turn the zoom lever to the T side to enlarge the page display (x2 magnification).
- If you turn the zoom lever to the W side after enlarging the page, the page returns to its original size (no magnification).
- You can use ▲▼◀▶ to move the position of the area to be enlarged.
- Press [Q.MENU/⏏] button to cancel the process without acquiring a login ID.

6 Enter the password

- Enter any combination of 8 to 16 characters and numbers for the password.
- For details on how to enter characters, refer to "Entering Text" (→87).

7 Check the login ID and select [OK]

- The login ID (12-digit number) will be displayed automatically.
When logging in to the "LUMIX CLUB" with a computer, you only need to enter the numbers.
- A message is displayed when the connection is complete. Select [OK].
- Be sure to make a note of the login ID and password.



Using a previously acquired login ID/confirming and changing login ID and password ([Set Login ID])

Preparation

To use a previously acquired login ID, confirm your ID and password.

To change the "LUMIX CLUB" password on the camera, access the "LUMIX CLUB" website from your smartphone or PC and change the "LUMIX CLUB" password in advance.

1 Set the menu

MENU →  **[Setup]** → **[Wi-Fi]** → **[Wi-Fi Setup]** → **[LUMIX CLUB]**

2 Select [Set/Add Account]

3 Select [Set Login ID]

- The login ID and password are displayed.
- The password is displayed as "★".
- Close the menu if only checking the login ID.

4 Select the item you wish to change

5 Enter your login ID or password

- For details on how to enter characters, refer to "Entering Text" (→87).
- Enter the new password you have created on your smartphone or PC into the camera.

6 Select [Exit]



To set the same login ID for the camera and the smartphone

- Setting the same login ID on this unit and your smartphone is convenient for sending images on this unit to other devices or WEB services.

■ When either this unit or the smartphone has acquired the login ID

① Connect this unit to the smartphone (→306)

② From the "Image App" menu, set the common login ID

- After connecting this unit to the smartphone, the setup screen for a common login ID may appear when you display the playback screen. You can also set a common login ID by following the on-screen instructions.
- This operation is not available for [Wi-Fi Direct] connection.

■ When this unit and the smartphone have acquired different login IDs

When you want to use the smartphone's login ID for this unit

Change the login ID and password for this unit to those acquired by the smartphone.

When you want to use this unit's login ID for the smartphone

Change the login ID and password for the smartphone to those acquired by this unit.

Check the "LUMIX CLUB" terms of use

Check the details if the terms of use have been updated.

1 Set the menu

MENU →  [Setup] → [Wi-Fi] → [Wi-Fi Setup] → [LUMIX CLUB]

2 Select [Terms of use]

Delete your login ID and account from the “LUMIX CLUB”

Delete the login ID from the camera when transferring it to another party or disposing of it. You can also delete your “LUMIX CLUB” account.

- Changes and other actions to login IDs can only be made to the login ID acquired with the camera.

1 Set the menu

MENU →  **[Setup]** → **[Wi-Fi]** → **[Wi-Fi Setup]** → **[LUMIX CLUB]**

2 Select [Delete account]

- The message is displayed. Select [Next].

3 Select [Yes] in the login ID delete confirmation screen

- The message is displayed. Select [Next].

4 Select [Yes] on the confirmation screen for deleting the “LUMIX CLUB” account

- If you want to continue using the service, selecting [No] will only delete the login ID. Exit the menu after it is executed.

5 Select [Next]

- The login ID is deleted, and then the message notifying the deletion of your account is displayed. Select [OK].



About connections

If you have selected [New Connection], select the Wi-Fi function and sending destination, and then select the connection method.

If you are connecting with the same settings as used previously, you can quickly start using the Wi-Fi function by connecting with [Select a destination from History] or [Select a destination from Favorite].

This section describes connection methods.

- When connecting with the same settings as used previously, refer to (→342).

When a screen similar to the one below is displayed, select a connection method.

- Example of operation for displaying a screen:

MENU → [Setup] → [Wi-Fi] → [Wi-Fi Function] → [New Connection]
→ [Send Images While Recording] → [Smartphone]

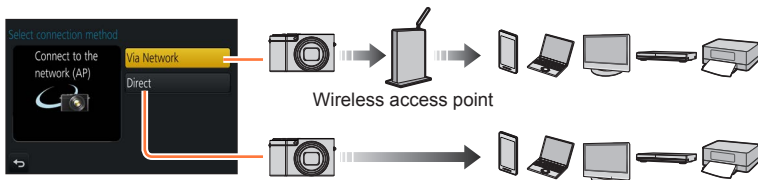

Connection method	Description	
[Via Network]	Connects through a wireless access point.	(→338)
[Direct]	Your device connects directly to this unit. (If you are out and unable to use your wireless access point, or temporarily connecting to equipment you do not ordinarily use, or in a similar situation, it is convenient to make a direct connection.)	(→341)

Connecting via a wireless access point ([Via Network])

Select a connection method to the wireless access point.

- WPS refers to a function that allows you to easily configure the settings related to the connection and security of wireless LAN devices. To check if the wireless access point you are using is compatible with WPS, refer to the instruction manual of the wireless access point.

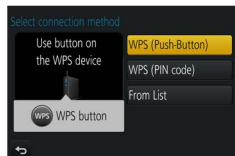

Connection method	Description
[WPS (Push-Button)]	<p>Save push button type wireless access point that is compatible with Wi-Fi Protected Setup™ with a WPS mark.</p> <ol style="list-style-type: none"> 1 Press the wireless access point WPS button until it switches to WPS Mode <ul style="list-style-type: none"> • Refer to the wireless access point instruction manual for details.
[WPS (PIN code)]	<p>Save PIN code type wireless access point that is compatible with Wi-Fi Protected Setup with a WPS mark.</p> <ol style="list-style-type: none"> 1 On the camera screen, select the wireless access point you are connecting to 2 Enter the PIN code displayed on the camera screen into the wireless access point 3 Press [MENU/SET] on the camera <ul style="list-style-type: none"> • Refer to the wireless access point instruction manual for details.
[From List]	<p>Select this option when you are not sure about the WPS compatibility, or when you want to search for and connect to a wireless access point. (→339)</p>



If you are not sure about the WPS compatibility (connecting by [From List])

Search for available wireless access points.

- Confirm encryption key of the selected wireless access point if the network authentication is encrypted.
- When connecting by [Manual Input], confirm SSID, network authentication type, encryption type, encryption key of the wireless access point you are using.

1 Select the wireless access point you are connecting to

- Pressing [DISP.] button will search for a wireless access point again.
- If no wireless access point is found, refer to “When connecting with [Manual Input]” (→340).

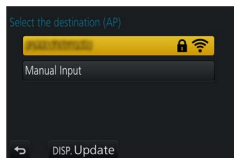

2 (If network authentication is encrypted)

Enter the encryption key

- For details on how to enter characters, refer to “Entering Text” (→87).



■ When connecting with [Manual Input]

- ① On the screen of step 1 of “If you are not sure about the WPS compatibility (connecting by [From List])”, select [Manual Input] (→339)
- ② Enter the SSID of the wireless access point you are connecting to, then select [Set]
 - For details on how to enter characters, refer to “Entering Text” (→87).
- ③ Select the network authentication type
 - For information on network authentication, see the instruction manual of the wireless access point.
- ④ Select the encryption type
 - The type of settings that can be changed may vary depending on the details of network authentication settings.

Network authentication type	Encryption types that can be set
[WPA2-PSK] / [WPA-PSK]	[TKIP] / [AES]
[Common Key]	[WEP]
[Open]	[No Encryption] / [WEP]

- ⑤ **(When an option other than [No Encryption] is selected)**
Enter the encryption key

- Check the wireless access points instruction manual and settings when saving a wireless access point.
- If no connection can be established, the wireless access point's radio waves may be too weak. Refer to “Message displays” (→376) and “Q&A Troubleshooting” (→383) for details.
- Transmission speed may decrease, or may not be usable depending on the environment it is used in.

Connecting directly ([Direct])

Select a connection method with which your equipment is compatible.

- Read the operating instructions of your device for details.



Connection method	Description
[Wi-Fi Direct]	<ol style="list-style-type: none"> 1 Set the device to Wi-Fi Direct® mode 2 Select [Wi-Fi Direct] on the camera screen 3 On the camera screen, select the device to connect to
[WPS Connection]	[WPS (Push-Button)] <ol style="list-style-type: none"> 1 Select [WPS (Push-Button)] 2 Set the device to WPS mode <ul style="list-style-type: none"> • You can wait longer for a connection by pressing the [DISP.] button on this unit.
	[WPS (PIN code)] <ol style="list-style-type: none"> 1 Select [WPS (PIN code)] 2 Enter the PIN code of the device into the camera
[Manual Connection]	<ol style="list-style-type: none"> 1 Enter the SSID and password into the device. The SSID and password are displayed on the connection waiting screen of this unit <ul style="list-style-type: none"> • If a device to be connected is [Smartphone], the password is not displayed. Select SSID to connect. (→306)



Connecting quickly with the same settings as used previously ([Select a destination from History] / [Select a destination from Favorite])

The camera keeps a History of times you used the Wi-Fi function. You can register items in the History to Favorite.

You can easily connect with the same settings as used previously by connecting from History or Favorite.

- If the Wi-Fi settings of the device to connect to have been changed, it may not be possible to connect to the device.

1 Set the menu

MENU →  [Setup] → [Wi-Fi] → [Wi-Fi Function]

2 Select [Select a destination from History] or [Select a destination from Favorite]

Item	Description
[Select a destination from History]	Connects using the same settings as used previously.
[Select a destination from Favorite]	Connects using settings registered in Favorite.

3 Select the desired connection setting

- If the device you want to connect to (smartphone, etc.) is connected to a wireless access point other than the camera, you cannot connect the device to the camera using [Direct]. Change the Wi-Fi settings of the device you want to connect to so that the access point to be used is set to the camera.

You can also select [New Connection] and reconnect the devices. (→306)

Registering History items to Favorite

1 Set the menu

MENU →  [Setup] → [Wi-Fi] → [Wi-Fi Function]
→ [Select a destination from History]

2 Select the item you wish to register and press ►

3 Enter a registration name

- For details on how to enter characters, refer to "Entering Text" (→87).
- Up to 30 characters can be entered. A double-byte character will be treated as two characters.



Editing items registered in Favorite

1 Set the menu

MENU →  [Setup] → [Wi-Fi] → [Wi-Fi Function]
→ [Select a destination from Favorite]

2 Select the Favorite item you wish to edit and press ►

3 Select item

Item	Description
[Remove from Favorite]	Cancels Favorites setting.
[Change the Order in Favorite]	Select the destination.
[Change the Registered Name]	<ul style="list-style-type: none"> For details on how to enter characters, refer to “Entering Text” (→87). Up to 30 characters can be entered. A double-byte character will be treated as two characters.



Registering and saving frequently used Wi-Fi connection settings to Favorites ([→342](#))

- The number of settings that can be saved in the history is limited.



Checking connection details of History or Favorite

- When selecting History or Favorite items, you can view connection details by pressing the [DISP.] button.

- Performing [Reset Wi-Fi Settings] deletes content registered in History and Favorite.
- When using [Select a destination from History] or [Select a destination from Favorite] to connect to a network to which many PCs are connected, it may be difficult to make the connection because the camera searches for previously connected equipment out of a large number of equipment pieces. If you cannot connect, retry the connection using [New Connection].

[Wi-Fi Setup]

Configure the settings required for the Wi-Fi function.
[Wi-Fi Setup] cannot be changed when connected to Wi-Fi.

1 Set the menu

MENU →  **[Setup]** → **[Wi-Fi]** → **[Wi-Fi Setup]** → **Desired setting**

Item	Description
[Wi-Fi Password] You can improve security by enabling password entry for a direct connection to a smartphone.	[ON]: Connects the camera and a smartphone using an SSID and password. (→308) [OFF]: Connects the camera and a smartphone using an SSID. (→306) <hr/> <ul style="list-style-type: none"> • When [ON] is selected, you can also set up a connection by scanning a QR code. (→309, 310)
[LUMIX CLUB] Acquires or changes the "LUMIX CLUB" login ID.	<ul style="list-style-type: none"> • For details (→332).
[PC Connection] You can set the workgroup.	You must connect to the same workgroup as the destination computer when sending pictures to the computer. (The default is set to "WORKGROUP") [Change Workgroup Name]: Enter the workgroup of the connecting computer. [Restore to Default]: Returns settings to default settings. <hr/> <ul style="list-style-type: none"> • For details on how to enter characters, refer to "Entering Text" (→87). • To use with a computer of the standard settings, you do not have to change the workgroup.
[Device Name] You can change the name (SSID) of this unit.	<ol style="list-style-type: none"> ① Press [DISP.] button ② Enter the desired device name (Up to 32 characters can be entered) <ul style="list-style-type: none"> • For details on how to enter characters, refer to "Entering Text" (→87).



Item	Description
<p>[Wi-Fi Function Lock] To prevent incorrect operation or use of the Wi-Fi function by a third party and to protect saved personal information, it is recommended that you protect the Wi-Fi function with a password.</p>	<p>Setting a password will automatically display the password input screen when the Wi-Fi function is used. [Setup]: Enter any 4-digit numbers as the password. [Cancel]</p> <hr/> <ul style="list-style-type: none"> • For details on how to enter characters, refer to “Entering Text” (→87). • Make a copy of password. If you forget the password, you can reset it with [Reset Wi-Fi Settings] in the [Setup] menu, however other settings will also be reset. (excluding [LUMIX CLUB])
<p>[Network Address] Displays the MAC address and IP address of this unit.</p>	<ul style="list-style-type: none"> • A “MAC Address” is a unique address that is used to identify network equipment. • “IP address” refers to a number that identifies a PC connected to a network such as the Internet. Usually, the addresses for homes are automatically assigned by the DHCP function such as a wireless access point. (Example: 192.168.0.87)
<p>[Approved Regulations] The authentication number is displayed.</p>	<p>–</p>



Enjoying 4K motion pictures

Viewing 4K motion pictures

■ Viewing on TV screen

When you connect this unit to a 4K-compatible TV and play back a motion picture recorded with [Rec Quality] of [4K], you can enjoy high-resolution 4K motion pictures. Although resolution output will be lower, you can also play back 4K motion pictures by connecting to a high-definition TV and other devices that do not have 4K support.

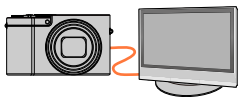
**Preparations**

- Set [HDMI Mode (Play)] (→82) to [AUTO] or [4K].
- When connecting to a TV that does not support 4K motion picture, select [Auto].

① Connect this unit to a 4K-compatible TV using an HDMI micro cable and display the playback screen (→348)

- When the [VIERA Link] setting on the camera is set to [ON] and the camera is connected to a VIERA Link (HDMI)-compatible Panasonic television (VIERA), the television automatically switches its input and the playback screen is displayed. For details (→350).
- When you have motion pictures recorded with [Rec Format] set to [MP4] and their size set to [4K] in [Rec Quality], you can also play them back by inserting the card into the SD card slot of a TV that supports motion pictures in 4K.
- Read the operating instructions for the TV.

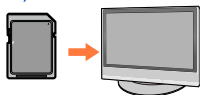

■ Viewing 4K motion pictures on a PC screen

To play back motion pictures recorded with [Rec Quality] of [4K] on a PC, use the software "PHOTOfunSTUDIO" (→353).

- To play back and edit 4K motion pictures, a high-performance PC environment is required.
- For details, refer to the operating instructions of "PHOTOfunSTUDIO" (PDF).



Storing 4K motion pictures

■ Storing 4K motion pictures on your PC

For details ([→352](#)).

■ Storing 4K motion pictures on a DVD

You cannot transfer or copy motion pictures recorded in [Rec Quality] with [4K] to a Blu-ray disc or DVD using a Panasonic recorder. (Current as of January 2016)

You can use the software “PHOTOfunSTUDIO” ([→353](#)) to convert the file size of a motion picture to a smaller size or copy it to a DVD.

- For details, refer to the operating instructions of “PHOTOfunSTUDIO” (PDF).

Viewing on TV screen

You can view pictures on a TV screen by connecting your camera to your TV with the HDMI micro cable.

Preparation

Turn off both camera and TV.

1 Connect camera to TV

Check the plug direction and insert it straight in. (If the cable is inserted in the wrong direction, the plug could become deformed and cause faulty operation) Also, do not insert into the wrong socket. Doing so may cause damage to this unit.

An HDMI micro cable can be used to enable viewing of still and motion pictures in high-resolution.

ZS100

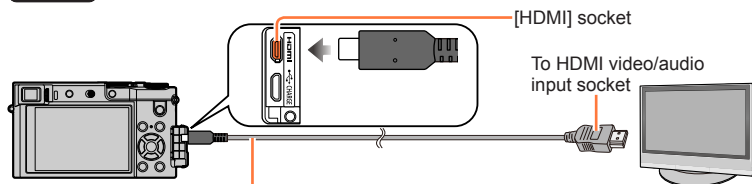

HDMI micro cable

Use a "High Speed HDMI micro cable" with the HDMI logo. Cables that do not comply with the HDMI standards will not work.

"High Speed HDMI micro cable" (Type D-Type A plug, up to 2 m (6.6 feet) long)

ZS60

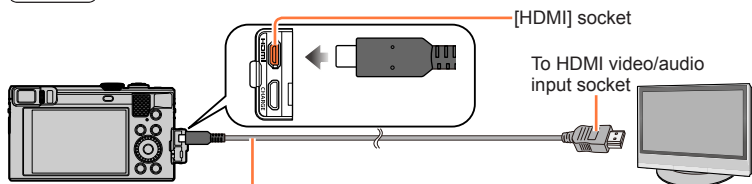

HDMI micro cable

Use a "High Speed HDMI micro cable" with the HDMI logo. Cables that do not comply with the HDMI standards will not work.

"High Speed HDMI micro cable" (Type D-Type A plug, up to 2 m (6.6 feet) long)

2 Turn on the TV and switch the TV input source to match the connection socket

3 Turn on the camera and press the Playback button

- Input of the TV will switch automatically and playback screen is displayed when connected to a VIERA Link-compatible TV using an HDMI micro cable with the [VIERA Link] set to [ON]. (→350)

Viewing on TV screen

- Bars may appear at the sides or at the top and bottom of the screen, depending on the aspect ratio setting.
- Change the screen mode on your TV if the picture is displayed with the top or bottom cut off.
- When pictures are displayed, they may not be displayed properly depending on the type of TV.
- Pictures rotated to portrait may be blurred slightly.
- Check the [HDMI Mode (Play)]. (→82)

ZS100

To play back 24p motion pictures, set [HDMI Mode (Play)] to [AUTO]. Otherwise, the picture is not output at 24 frames per second.

- When an HDMI micro cable is connected, pictures are not displayed on the screen.
- HDMI output will be canceled if a USB connection cable (supplied) is connected simultaneously.
- Audio output is stereo.
- Read the operating instructions for the TV.



The recorded pictures can be played back on a TV with an SD Memory Card slot

- Proper playback (aspect ratio) will be dependent on the TV used for viewing.
- The file format of the motion pictures that can be played back differs depending on the TV model.
- You may not be able to play back panorama pictures. Also you cannot perform automatic scrolling playback of panorama pictures.
- For cards compatible with playback, refer to the operating instructions of the TV.



VIERA Link (HDMI) (HDAVI Control™)

What is VIERA Link (HDMI)?

- VIERA Link is a function that automatically links this camera to VIERA Link-compatible devices by connecting HDMI micro cables for enabling easy operation with the VIERA remote control. (Some operations are not available.)
- VIERA Link (HDMI) is an exclusive Panasonic function added to the industry-standard HDMI control functions known as HDMI CEC (Consumer Electronics Control). Operation is not guaranteed when connecting with non-Panasonic HDMI CEC-compatible devices. Refer to your product manual to verify compatibility with VIERA Link (HDMI).
- This camera supports VIERA Link (HDMI) Version 5. This is the Panasonic standard that also supports previous Panasonic VIERA Link devices.

Preparation

Set [VIERA Link] to [ON] (→83).

- 1 Connect the camera to a VIERA Link (HDMI)-compatible Panasonic television (VIERA) with an HDMI micro cable (→348)**
- 2 Turn on the camera and press the Playback button**
- 3 Operate with the remote control for the TV**

- To play back the audio of the motion pictures in a slide show, set the [Sound] in the Slide Show setting screen to [AUTO] or [Audio].
- It is recommended to connect this unit to an HDMI terminal other than the HDMI1 if there are 2 or more HDMI input terminals on the TV.
- If the [VIERA Link] setting on the camera is [ON], operations via the camera buttons will be limited.

■ Other related operations

Turning the unit OFF

- The camera can also be turned off when the television is turned off with the remote control.

Automatic input select

- When the camera and TV are connected by HDMI micro cable, the camera is turned ON, and the camera's Playback button is pressed, the television input automatically switches to the camera's screen. The television can also be switched on via the camera from Standby Mode (if "Power on link" on the television is set to "on").
- If VIERA Link (HDMI) does not function correctly ([→395](#))

- If you do not know if your TV is VIERA Link (HDMI) compatible, see the TV's operating instructions.
- Use a "High Speed HDMI micro cable" with the HDMI logo. Cables that do not comply with the HDMI standards will not work.
- "High Speed HDMI micro cable" (Type D-Type A plug, up to 2 m (6.6 feet) long)
- When VIERA Link is activated, the [HDMI Mode (Play)] setting of this unit is automatically recognized.

Storing recorded still pictures and motion pictures on your PC

Still/motion pictures can be copied from the camera to your computer by connecting the two together.

- Some computers can read directly from the camera's memory card.
For details, see the instruction manual for your computer.
- If your computer does not support SDXC Memory Cards, a message will be displayed requesting you to format the card. (Do not format the card. This will erase recorded pictures.)

If the card is not recognized, refer to the following support website.

<http://panasonic.net/avc/sdcard/information/SDXC.html>

■ Computer specifications

You can connect the camera to a computer that can detect a mass storage device (device that stores a large volume of data).

- Windows: Windows 10 / Windows 8.1 / Windows 8 / Windows 7
- Mac: OS X v10.5 - v10.11



Some motion pictures recorded in [AVCHD] may not be scanned correctly by copying a file or folder

- When using Windows, be sure to use the "PHOTOfunSTUDIO" software (→353) to copy motion pictures recorded in [AVCHD].
- When using Mac, you can copy motion pictures recorded in [AVCHD] using "iMovie". Note, however, that it may not be possible to copy pictures depending on the picture quality settings.
(For details about iMovie, please contact Apple Inc.)



Storing recorded still pictures and motion pictures on your PC

Downloading software

If you wish to play back or edit pictures on a PC, download software from the supplier's website and install it on your PC.

PHOTOfunSTUDIO 9.8 PE

You can capture still pictures or motion pictures to your PC, or organize captured pictures by categorizing by recording date, model name of the digital camera used to record, etc. You can also correct still pictures, edit motion pictures, or write to DVD.

Check the website below to download/install the software.

The software is available for download until the end of March 2021.

http://panasonic.jp/support/global/cs/soft/download/d_pfs98pe.html

• Operating environment

Supported OS	Windows® 10 (32-bit/64-bit) Windows® 8.1 (32-bit/64-bit) Windows® 8 (32-bit/64-bit) Windows® 7 (32-bit/64-bit) SP1	
CPU	Windows® 10	Pentium® 4 2.8 GHz or higher
	Windows® 8.1	
	Windows® 8	
	Windows® 7	
Display	1024×768 pixels or more (1920×1080 pixels or more recommended)	
RAM	Windows® 10	1 GB or more (32-bit) / 2 GB or more (64-bit)
	Windows® 8.1	
	Windows® 8	
	Windows® 7	
Free hard disk space	450 MB or more for installing software	

- To edit 4K motion pictures, you need the 64-bit versions of Windows 10, Windows 8.1, Windows 8, or Windows 7.
- Refer to the operating instructions of "PHOTOfunSTUDIO" (PDF) for further information about the operating environment.

Storing recorded still pictures and motion pictures on your PC

SILKYPIX Developer Studio SE

This software develops and edits RAW file pictures. Edited pictures can be saved in a file format such as JPEG or TIFF that can be displayed on a PC, etc.

Check the website below to download/install the software.

<http://www.isl.co.jp/SILKYPIX/english/p/>

• Operating environment

Supported OS	Windows® 10 Windows® 8.1 Windows® 8 Windows® 7 Mac® OS X v10.6 - v10.11
---------------------	---

- For details on the operating environment and how to use the SILKYPIX Developer Studio SE, refer to the “Help” or the Ichikawa Soft Laboratory’s support website.

LoiLoScope 30 day full trial version

(Windows 10 / 8.1 / 8 / 7)

Motion pictures can be edited easily.

Check the website below to download/install the software.

<http://loilo.tv/product/20>

- For more information on how to use LoiLoScope and its operating environment, read the LoiLoScope manual available for download at the website.

- To download the software, the PC must be connected to the Internet.
- It may take time to download the software in some communication environments.



Storing recorded still pictures and motion pictures on your PC

Copying still pictures and motion pictures

Preparations

- Install "PHOTOfunSTUDIO" on your computer before starting the copying procedure. (→353)
- Turn on the camera and computer.

1 Connect camera to computer

- Check the plug direction and insert it straight in. (If the cable is inserted in the wrong direction, the plug could become deformed and cause faulty operation) Also, do not insert into the wrong socket. Doing so may cause damage to this unit.
- Do not use any other USB connection cables except the supplied one.

ZS100

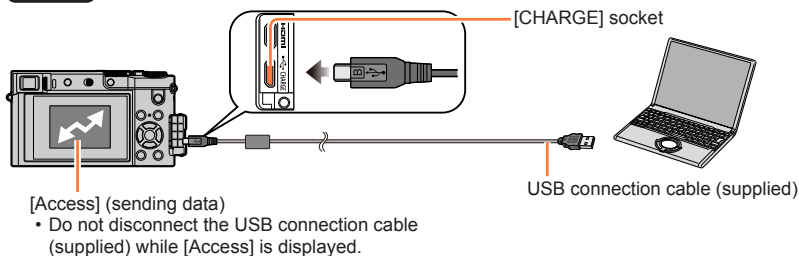

ZS60

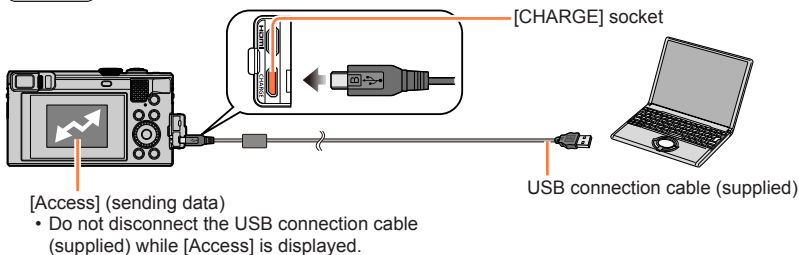

2 Use ▲ ▼ to select [PC] and press [MENU/SET]

- If you set the [USB Mode] (→82) to [PC] in the [Setup] menu in advance, the camera will be automatically connected to the PC without displaying the [USB Mode] selection screen.
- If you connect the camera to a PC with the [USB Mode] set to [PictBridge(PTP)], a message may appear on the PC screen. In such a case, close the message and remove the USB connection cable safely, and then reset the [USB Mode] to [PC].

3 Use "PHOTOfunSTUDIO" to copy pictures to your computer

- Do not delete or move copied files and folders using Windows Explorer or other browsers. Otherwise, you will not be able to play back or edit the files using "PHOTOfunSTUDIO".

Storing recorded still pictures and motion pictures on your PC

■ For PTP mode

The camera can be connected to your computer even if [USB Mode] (→82) is set to [PictBridge(PTP)].

- Data can be read only from the card in the PC.
- It may not be possible to import if there are 1,000 or more pictures on the card.
- Motion pictures cannot be played back in the PTP mode.

■ Copying to your computer without using “PHOTOfunSTUDIO”

You can save pictures to use on your computer by dragging and dropping folders and files into separate folders on your computer.

- **The card of this unit contains the following files (folder structure).**

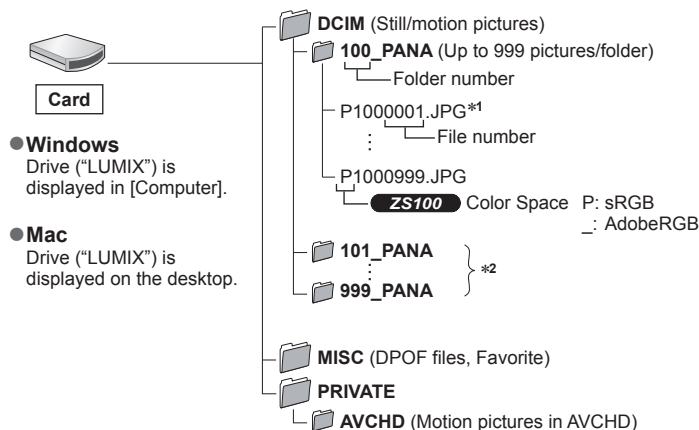

*1 .JPG: Still pictures

.RW2: Still pictures recorded in RAW file

.MP4: [MP4] Motion Pictures

*2 New folders are created in the following cases:

- When there is a picture with file number 999 inside the folder.
- When using cards already containing the same folder number (for example, pictures taken with other cameras, etc.).
- When recording after performing [No.Reset]. (→85)

- Before inserting or removing a card, turn the camera off and disconnect the USB connection cable. Otherwise, data may be destroyed.
- Use a battery with sufficient battery power or the AC adaptor (optional) and DC coupler (optional).
- When the battery begins to run out during communication, a warning beep sounds. Remove the USB connection cable safely. Otherwise, data may be destroyed.
- Before connecting or disconnecting the AC adaptor (optional), turn the camera off.

Storing recorded still pictures and motion pictures in the recorder

Copying by inserting the card into the recorder

You can copy pictures using Panasonic equipment (such as Blu-ray disc recorders) with support for each file format.

- The method of importing still pictures and motion pictures recorded in this unit to other devices will vary depending on the file format (JPEG, RAW, AVCHD, or MP4).
- You cannot copy 4K burst files (MP4 format) with [Aspect Ratio] set to an option other than [16:9] to hard disk drives, including those of Panasonic recorders compatible with import of 4K motion pictures. (As of January 2016)
- See the instruction manual for the recorder for details for copying and playing back.

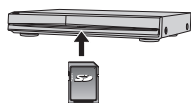

Printing

You can connect directly to a PictBridge-compatible printer for printing.

Preparations

- Adjust the print quality or other settings on your printer, as needed.
- Turn on the camera and printer.

1 Connect camera to printer

- Check the plug direction and insert it straight in. (If the cable is inserted in the wrong direction, the plug could become deformed and cause faulty operation) Also, do not insert into the wrong socket. Doing so may cause damage to this unit.
- Do not use any other USB connection cables except the supplied one. Using cables other than the above may cause a malfunction.

ZS100

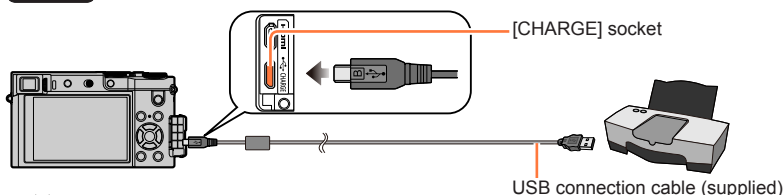

- [🔌]
- Do not disconnect the USB connection cable (supplied) when the cable disconnection icon [🔌] is displayed (may not be displayed with some printers).

ZS60

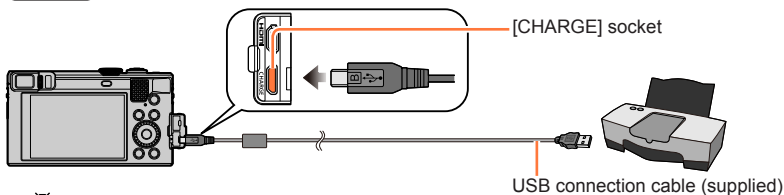

- [🔌]
- Do not disconnect the USB connection cable (supplied) when the cable disconnection icon [🔌] is displayed (may not be displayed with some printers).

2 Use ▲ ▼ to select [PictBridge(PTP)] and press [MENU/SET]

3 Use ◀ ▶ to select a picture and press [MENU/SET]

4 Use ▲ to select [Print start] and press [MENU/SET]
(Print settings (→361))

Printing multiple pictures

Multiple pictures are printed at one time.

1 Press **▲** to select **[Multi Print]** in step **3** of “Printing” (→358)

2 Use **▲ ▼** to select the item and press **[MENU/SET]**

- **[Multi Select]:**
 - ① Scroll between pictures with **▲ ▼ ◀ ▶**, select pictures to print with **[MENU/SET]** (Press **[MENU/SET]** again to release selection.)
 - ② Use **◀** to select **[OK]**, and press **[MENU/SET]**
- **[Select All]:** Print all pictures.
- **[Print Set (DPOF)]:** Print pictures selected in **[Print Set]**. (→298)
- **[Favorite]:** Print pictures selected as **[Favorite]**. (→297)

3 Use **▲** to select **[Print start]** and press **[MENU/SET]**

(Print settings (→361))

- The group pictures are displayed one by one instead of all pictures at the same time.
- Disconnect USB connection cable (supplied) after printing.
- Use a battery with sufficient battery power or the AC adaptor (optional) and DC coupler (optional). When the battery begins to run out during communication, a warning beep sounds. Cancel printing and disconnect USB connection cable (supplied).
- Before connecting or disconnecting the AC adaptor (optional), turn the camera off.
- Before inserting or removing a card, turn the camera off and disconnect the USB connection cable.
- Some printers can print directly from the camera’s memory card. For details, see the manual for your printer.
- An orange “●” displayed during printing indicates an error message.
- When printing a large number of pictures, the remaining sheets display may differ from the number of pictures set for printing.
- Motion pictures, 4K burst files, and pictures recorded with **[Post Focus]** cannot be printed.
- Still pictures recorded in a RAW file cannot be printed. (The still pictures recorded in JPEG file format at the same time as the RAW file can be printed.)

Printing with date and text

Time and date can be set to be printed on the picture when taking the picture by activating the [Text Stamp] function in the [Playback] menu. (→291)

■ Printing date without [Text Stamp]

Printing in store:

Only recording date can be printed. Request date printing in store.

- Making [Print Set] (→298) settings on the camera in advance allows settings for numbers of copies and date printing to be designated before giving the card to the store.
- You cannot request a store to print the characters entered for [Age] or [Name] of [Profile Setup] or [Face Recog.], [Travel Date], [Location], and [Title Edit].

Using computer:

Print settings for recording date and text information can be made using "PHOTOfunSTUDIO" software (→353).

Using printer:

Recording date can be printed by setting [Print Set] on the camera, or by setting [Print with Date] (→361) to [ON] when connecting to a printer compatible with date printing.

Making print settings on the camera

Setting options include the number of printed pictures and their size. Make settings before selecting [Print start].

1 Use ▲▼ to select the item and press [MENU/SET]

Item	Settings
[Print with Date]	[ON] / [OFF]
[Num.of prints]	Set number of pictures (up to 999 pictures)
[Paper Size]	When [📄] is selected, the printer settings take priority.
[Page Layout]	[📄] (printer takes priority) / [📄] (1 picture, no border) / [📄] (1 picture, with border) / [📄] (2 pictures) / [📄] (4 pictures)

2 Use ▲▼ to select the setting and press [MENU/SET]

- When [Print Set (DPOF)] has been selected, the [Print with Date] and [Num.of prints] items are not displayed.
- If the printer does not support date printing, the date cannot be printed on the picture.
- When setting [Print with Date] to [ON], check the date printing settings on the printer (printer settings may be prioritized).
- To print a picture on which text or a date has been stamped, set [Print with Date] to [OFF]. (The still picture is printed with the date superimposed on it.)
- In some printers, dates for pictures taken with the aspect ratio set to [1:1] will be printed vertically.
- Items may not be displayed if incompatible with printer.
- To print to paper sizes/layouts not supported by this camera, set to [📄] and make settings on the printer. (Consult your printer's operating manual.)
- Even with completed [Print Set] settings, dates may not be printed, depending on the shop or printer used.

Optional accessories

Using the AC adaptor (optional) and DC coupler (optional) instead of the battery

By using the AC adaptor (optional) and DC coupler (optional), you can record and play back without worrying about the remaining battery charge.

The optional DC coupler can only be used with the designated Panasonic AC adaptor (optional).









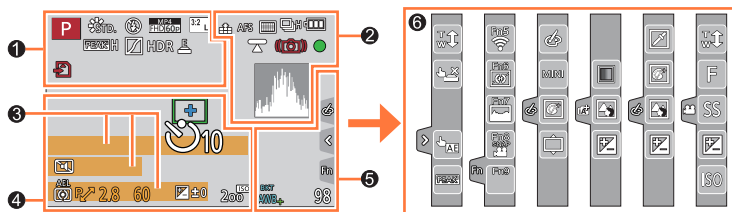

- Always use a genuine Panasonic AC adaptor (optional).
- Also read the AC adaptor and DC coupler operating instructions.





ZS100 List of monitor/viewfinder displays

- The following images are examples of when the display screen is set to  (monitor style) in the monitor.
- The information displayed, such as histograms, magnifications, and numeric values, are only for the purpose of reference.











In recording



	Recording mode (→49)
C 1	Custom Set (→127)
	[Photo Style] (→129)
	Flash Mode (→243)
	[Rec Format]/[Rec Quality] (→255)
	[Snap Movie] (→262)
	[Aspect Ratio]/[Picture Size] (→139)
	Image size (Panorama Shot Mode) (→109)
	Picture effect (Filter) adjustment display (→118, 131)
EXPS	Types of picture effects (Filter) (→131)
	Card (displayed only during recording) (→37)
XXhXXmXXs	Elapsed recording time*1 (→251)
	Simultaneous recording indicator (→261)













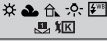





LVF/ MON AUTO	Automatic switching between viewfinder and monitor (→59)
PEAK H PEAK L	[Peaking] (→172, 215)
	[Highlight Shadow] (→133)
HDR	[HDR] (→143)/ [iHDR] (→92)
	[Multi Exp.] (→223)
	Electronic shutter (→199)
	Overheat indicator (→186, 384, 386)

List of monitor/viewfinder displays

2	 RAW	[Quality] (→140)
	120fps	[High Speed Video] (→125)
		[Post Focus] (→210)
	AFS AFF AFC MF	[AFS/AFF/AFC] (→148)/ MF (→167)
		AF Mode (→149)
		[Pull Focus] (→264)
		[Face Recog.] (→226)
	AFL	AF Lock (→173)
		Burst (→202)
		[4K PHOTO] (→184)
		[Auto Bracket] (→206)
		[Self Timer] (→208)
		Remaining battery (→32)
	AF 	Macro recording (→165)
		[Level Shot] (→266)
		[Stabilizer] (→234)
		Jitter alert (→234)
		Recording state (Flashes red.) (→251)/ Focus (Lights green.) (→46)
		Focus (Under low illumination) (→146)
		Focus (Starlight AF) (→146)
		Wi-Fi connection status
		Histogram (→55)
4		AF area (→146, 156, 161)
	+	Spot metering target (→183)
		[Self Timer]*4 (→208)
		[Silent Mode] (→225)
	AEL	AE Lock (→173)
		[Metering Mode] (→64, 183)
	P	Program Shift (→97)
	2.8	Aperture value (→97)
	60	Shutter speed (→97)
		Exposure compensation value (→177)
		Brightness (exposure) (→94, 121)
		Manual Exposure Assist (→104)
	200 ^{ISO}	ISO sensitivity (→179)

3	Name*2 (→229)
	Travel elapsed days*3 (→77)
	Age in years/months*2 (→229)
	Location*3 (→77)
	Current date/time*3
	Travel destination setting*3:  (→76)
	Exposure meter (→98)
	Zoom (→238)

List of monitor/viewfinder displays

5		6	
	[Dial Guide] (→52)	Touch tab (→61)	
BKT AWB ↓	White Balance Bracket (→138)		Touch zoom (→240)
	White Balance Fine Adjustment (→137)		Touch Shutter (→63)
	White Balance (→134)		[Touch AE] (→64)
	Coloring (→94)		[Peaking] (→172)
98	Number of recordable pictures*5 (→39)		Function buttons (→71)
RXXmXXs	Available recording time*1, *5 (→40)		Coloring (→94)
			Defocus control function (→93, 121)
			Brightness (exposure) (→94, 121)
			Type of defocus ([Miniature Effect]) (→122)
			[One Point Color] (→123)
			[Sunshine] (→123)
			Picture effect (Filter) adjustment display (→118, 131)
			Picture effects ON or OFF (→131)
			Picture effects (Filter) (→131)
			Aperture value (→46)
			Shutter speed (→46)
			ISO sensitivity (→179)

*1 [h], [m] and [s] indicate “hour”, “minute” and “second”.

*2 This is displayed for about 5 seconds when the camera is turned on if the [Profile Setup] setting is set.

*3 This is displayed for about 5 seconds when the camera is turned on, after setting the clock and after switching from Playback Mode to Recording mode.

*4 This is displayed during countdown.

*5 It is possible to switch the display between the number of recordable pictures and available recording time with the [Remaining Disp.] setting in the [Custom] menu.

In playback

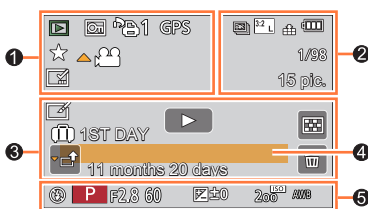









1

	Playback Mode (→281)
	Protected picture (→299)
	Number of prints (→298)
	GPS With location information (→283, 315)
	★ Favorites (→297)
	Cable disconnect prohibit icon (→358)
	▲ Motion picture playback (→270)
	▶ Panorama picture playback (→111)
	▶ Continuous playback of burst picture group (→275)
	▶ Save pictures from the 4K burst file (→190, 194)
	▶ Save a picture from pictures recorded using [Post Focus] (→214)
	▶ Continuous playback of Time Lapse Shot picture group (→275)
	▶ Continuous playback of stop motion animation group (→275)
	☑ Text stamped display (→291)
XXhXXmXXs	Elapsed playback time*1

2





	4K Photo (4K burst file) (→184)
	[Post Focus] (→210)
	[Aspect Ratio]/[Picture Size] (→139)
	[MP4 FHD] [60p] [Rec Format]/[Rec Quality] (→255)
	[SNAP] [Snap Movie] (→262)
	RAW [Quality] (→140)
	120fps [High Speed Video] (→125)
	Remaining battery (→32)
	1/98 Picture number/Total pictures
	Wi-Fi connection status
	15 pic. Number of group pictures
XXhXXmXXs	Motion picture recording time*1 (→270)

List of monitor/viewfinder displays

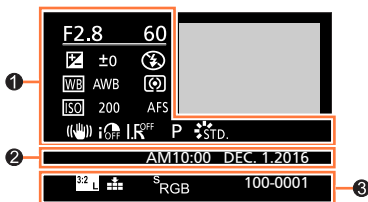





3		Clear Retouch completed icon (→289)	4	Name*2 (→228, 229)
		Acquiring information icon (→378)		Location*2 (→77)
		Playback (Motion Pictures) (→270)		Title*2 (→290)
		1ST DAY Travel elapsed days (→77)	5	Recording information*3
		Upload (Wi-Fi) icon (→330)		
		Submenu icon (→276, 330)		
		[Silent Mode] (→225)		
	11 months 20 days	Age in years/months (→228, 229)		
		Multi Playback (→273)		
		Delete (→277)		

■ Detailed information display



1		[Stabilizer] (→234)
		[i.Dynamic]*3 (→142)
		[HDR]*4 (→143)/[iHDR]*4 (→92)
		[i.Resolution] (→142)

2	Recording date/time World time (→76)
----------	---

3		[Aspect Ratio]/[Picture Size] (→139)
		[Rec Format]/[Rec Quality] (→255)
	120fps	[High Speed Video] (→125)
		[Quality] (→140)
		[Color Space]*4 (→145)
		4K Photo (4K burst file) (→184)
		[Post Focus] (→210)
	100-0001	Folder/File number*3 (→356)

■ Histogram display

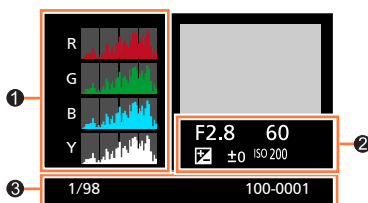

①
Histogram (→57)

②
Recording information*3

③

1/98	Picture number/Total pictures
100-0001	Folder/File number*3 (→356)

*1 [h], [m] and [s] indicate “hour”, “minute” and “second”.

*2 It is displayed in order of [Title], [Location], [Name] ([Baby1]/[Baby2], [Pet]), [Name] ([Face Recog.]).

*3 This is not displayed for motion pictures recorded in [AVCHD].

*4 This is not displayed for motion pictures.

ZS60 List of monitor/viewfinder displays

- The following images are examples of when the display screen is set to [] (monitor style) in the monitor.
- The information displayed, such as histograms, magnifications, and numeric values, are only for the purpose of reference.

In recording

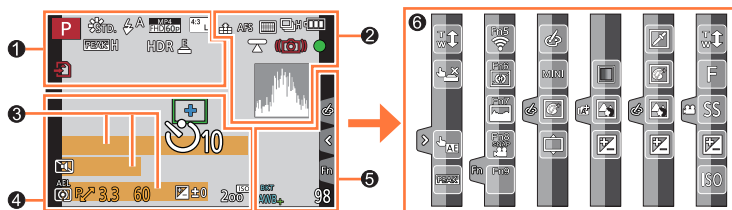

	Recording mode (→49)
	Custom Set (→127)
	[Photo Style] (→129)
	Flash Mode (→244)
	[Rec Format]/[Rec Quality] (→255)
	[Snap Movie] (→262)
	[Aspect Ratio]/[Picture Size] (→139)
	Image size (Panorama Shot Mode) (→109)
	Picture effect (Filter adjustment display) (→118, 131)
EXPS	Types of picture effects (Filter) (→131)
	Card (displayed only during recording) (→37)
XXhXXmXXs	Elapsed recording time*1 (→251)

	Simultaneous recording indicator (→261)
	Automatic switching between viewfinder and monitor (→59)
	[Peaking] (→172, 215)
	[HDR] (→143)/ [iHDR] (→92)
	Electronic shutter (→199)
	Overheat indicator (→186, 384, 386)

List of monitor/viewfinder displays

②

	RAW [Quality] (→140)
	240fps 120fps [High Speed Video] (→125)
	[Post Focus] (→210)
	AFS AFF AFC MF [AFS/AFF/AFC] (→148)/ MF (→167)
	AF Mode (→149)
	[Pull Focus] (→264)
	[Face Recog.] (→226)
	AFL AF Lock (→175)
	Burst (→202)
	[4K PHOTO] (→184)
	[Auto Bracket] (→206)
	[Self Timer] (→208)
	Remaining battery (→32)
	Macro recording (→165)
	[Level Shot] (→266)
	[Stabilizer] (→234)
	Jitter alert (→234)
	Recording state (Flashes red.) (→251)/ Focus (Lights green.) (→46)
	Focus (Under low illumination) (→146)
	Wi-Fi connection status
	Histogram (→55)

④





	AF area (→146, 156, 161)
	+ Spot metering target (→183)
	[Self Timer]*4 (→208)
	[Silent Mode] (→225)
	AEL AE Lock (→175)
	[Metering Mode] (→64, 183)
	Program Shift (→97)
	3.3 Aperture value (→97)
	60 Shutter speed (→97)
	Exposure compensation value (→177)
	Brightness (exposure) (→94, 121)
	Manual Exposure Assist (→104)
	200 ^{ISO} ISO sensitivity (→179)

③

















Name*2 (→229)
Travel elapsed days*3 (→77)
Age in years/months*2 (→229)
Location*3 (→77)
Current date/time*3
Travel destination setting*3: (→76)
Exposure meter (→98)
Zoom (→238)

List of monitor/viewfinder displays

5

	[Dial Guide] (→52)
	White Balance Bracket (→138)
	White Balance Fine Adjustment (→137)
	White Balance (→134)
	Coloring (→94)
98	Number of recordable pictures*5 (→39)
RXXmXXs	Available recording time*1, *5 (→40)

6

Touch tab (→61)	
	Touch zoom (→240)
	Touch Shutter (→63)
	[Touch AE] (→64)
	[Peaking] (→172)
	Function buttons (→71)
	Coloring (→94)
	Defocus control function (→93, 121)
	Brightness (exposure) (→94, 121)
	Type of defocus ([Miniature Effect]) (→122)
	[One Point Color] (→123)
	[Sunshine] (→123)
	Picture effect (Filter) adjustment display (→118, 131)
	Picture effects ON or OFF (→131)
	Picture effects (Filter) (→131)
	Aperture value (→46)
	Shutter speed (→46)
	ISO sensitivity (→179)

*1 [h], [m] and [s] indicate "hour", "minute" and "second".

*2 This is displayed for about 5 seconds when the camera is turned on if the [Profile Setup] setting is set.

*3 This is displayed for about 5 seconds when the camera is turned on, after setting the clock and after switching from Playback Mode to Recording mode.

*4 This is displayed during countdown.

*5 It is possible to switch the display between the number of recordable pictures and available recording time with the [Remaining Disp.] setting in the [Custom] menu.

In playback

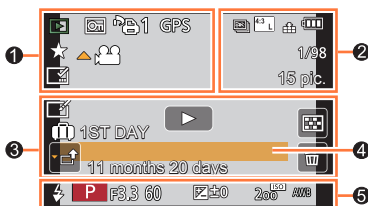













1

	Playback Mode (→281)
	Protected picture (→299)
	Number of prints (→298)
	With location information (→283, 315)
	Favorites (→297)
	Cable disconnect prohibit icon (→358)
	Motion picture playback (→270)
	Panorama picture playback (→111)
	Continuous playback of burst picture group (→275)
	Save pictures from the 4K burst file (→190, 194)
	Save a picture from pictures recorded using [Post Focus] (→214)
	Continuous playback of Time Lapse Shot picture group (→275)
	Continuous playback of stop motion animation group (→275)
	Text stamped display (→291)
XXhXXmXXs	Elapsed playback time*1

2





	4K Photo (4K burst file) (→184)
	[Post Focus] (→210)
	[Aspect Ratio]/[Picture Size] (→139)
	[Rec Format]/[Rec Quality] (→255)
	[Snap Movie] (→262)
[Quality] icon"/>	[Quality] (→140)
[High Speed Video] icon"/>	[High Speed Video] (→125)
Remaining battery icon"/>	Remaining battery (→32)
Picture number/Total pictures icon"/>	Picture number/Total pictures
Wi-Fi connection status icon"/>	Wi-Fi connection status
15 pic. icon"/>	Number of group pictures
Motion picture recording time icon"/>	Motion picture recording time*1 (→270)

List of monitor/viewfinder displays

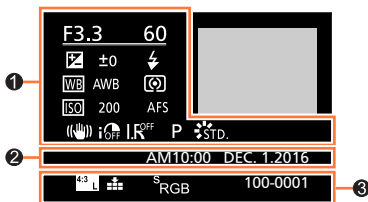



	Clear Retouch completed icon (→289)		Name*2 (→228, 229)
	Acquiring information icon (→378)		Location*2 (→77)
	Playback (Motion Pictures) (→270)		Title*2 (→290)
	1ST DAY Travel elapsed days (→77)		Recording information*3
	Upload (Wi-Fi) icon (→330)		
	Submenu icon (→276, 330)		
	[Silent Mode] (→225)		
11 months 20 days	Age in years/months (→228, 229)		
	Multi Playback (→273)		
	Delete (→277)		

■ Detailed information display



	[Stabilizer] (→234)
	[i.Dynamic]*3 (→142)
	[HDR]*4 (→143)/[iHDR]*4 (→92)
	[i.Resolution] (→142)

	Recording date/time World time (→76)
---	---

	[Aspect Ratio]/[Picture Size] (→139)
	[Rec Format]/[Rec Quality] (→255)
240fps 120fps	[High Speed Video] (→125)
	[Quality] (→140)
	4K Photo (4K burst file) (→184)
	[Post Focus] (→210)
100-0001	Folder/File number*3 (→356)

■ Histogram display

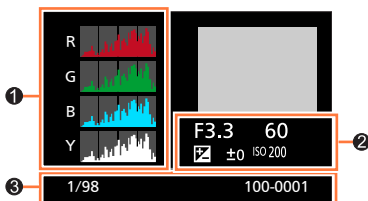

①
Histogram (→57)

②
Recording information*3

③

1/98	Picture number/Total pictures
100-0001	Folder/File number*3 (→356)

*1 [h], [m] and [s] indicate "hour", "minute" and "second".

*2 It is displayed in order of [Title], [Location], [Name] ([Baby1]/[Baby2], [Pet]), [Name] ([Face Recog.]).

*3 This is not displayed for motion pictures recorded in [AVCHD].

*4 This is not displayed for motion pictures.

Message displays

The following explains the meaning of major messages displayed on the monitor or viewfinder, and how to respond to them.

■ Memory cards

[Memory Card Error] [Format this card?]

- Save needed data on a computer or other device, and then use [Format] on the camera. (→38)
- Try with a different card.

[Read Error] / [Write Error] [Please check the card]

- Check whether card has been inserted correctly (→35, 36).
- Turn off the camera and remove the card. Reinsert the card and turn the camera on again.
- Try with a different card.

[Motion recording was cancelled due to the limitation of the writing speed of the card]

- The speed class of a required card varies depending on [Rec Format] and [Rec Quality] of a motion picture. 4K photo recording requires a card that meets a particular speed class rating. Use a card that meets the rating. Be sure to use a card of the recommended speed class. For details, refer to "About motion picture/4K photo recording and speed class ratings" (→37).
- If recording stops even when using a card of the recommended speed class (→37), the data writing speed has dropped. If this happens, we recommend backing up the data on the memory card and formatting it (→38). Depending on the type of the card, recording may stop in the middle.

[Memory Card Error] [This memory card cannot be used]

- Use a compatible card. (→37)

[Cannot record due to incompatible format(NTSC/PAL) data on this card.]

- Format the card after saving necessary data on a PC etc. (→38)
- Insert a different card.



■ Battery

[This battery cannot be used]

- Use a genuine Panasonic battery. Consult the dealer or your nearest Service Center if display still remains.
- Wipe any dirt away from the battery terminal.

■ Wi-Fi function

[Failed to connect wireless access point] / [Connection failed] / [No destination found]

- Check following regarding the wireless access point.
 - The wireless access point information set on this unit is wrong. Check the authentication type, encryption type, and encryption key. (→339)
 - Power of the wireless access point is not turned on.
 - Setting of the wireless access point is not supported by this unit.
- Check the network setting of the destination.
- Radio waves from other devices may block the connection to a wireless access point. Check other devices that are connected to the wireless access point and devices that use the 2.4 GHz band.

[No picture to send]

- This is displayed when there is no image to transmit due to the restriction of the destination. Check the file type of the image to transmit. (→319)

[Connection failed. Please retry in a few minutes.] / [Network disconnected. Transfer stopped.]

- Radio waves from the wireless access point are getting weak. Perform the connection closer to the wireless access point.
- There is no reply from the server or it has exceeded the communication processing time. Try again after a while.
- Depending on the wireless access point, connection may be automatically disconnected after specific time has passed. Reconnect the connection again.

[Upload to the Cloud Folder is available after Cloud Sync settings have been set up on downloadable devices such as PCs or smartphones.]

- Devices that download images from a cloud folder are not registered.
- Perform Cloud Sync setting. Configure the settings on a PC with "PHOTOfunSTUDIO" (→353) or on a smartphone with "Image App". For details on [Cloud Sync. Service], refer to (→331).



Message displays

[Connection failed]

- Check following regarding the smartphones you intend to connect.
 - The smartphone does not operate.
 - Change the access point to connect to in the smartphone Wi-Fi settings to this camera.
 - There is no free storage space on the smartphone.

[Login failed. Please check Login ID and Password.]

- Login ID or password for the “LUMIX CLUB” is not correct. Please enter it again. If you have forgotten the login ID or the password, there is information in the login screen of the “LUMIX CLUB” website.

[Some files cannot be sent because of destination limit] /**[Transfer completed. Some files are left because of destination limit.]**

- Check the file format of the image to send. (→319)
- Sending motion pictures may fail if the file size is too large. Split the motion picture using [Video Divide]. (→292)

[Unavailable. Please set Login settings on LUMIX CLUB web site.]

- Login to the “LUMIX CLUB” from your smartphone or PC, and set the login details of the destination WEB service.

[Both picture and video sharing service cannot be selected together]

- WEB services designed only for pictures, and WEB services designed only for motion pictures cannot be selected at the same time. Deselect one of the services.

[Cannot get IP address. Please set wireless AP's IP address setting to DHCP.]

- Turn on DHCP settings of the IP address of the connected wireless access points.

[Cannot connect to server]

- If a message is displaying asking to update the root certificate, agree to update the root certificate.



■ Others

[This picture is protected]

- Delete the picture after canceling the protect setting (→299).

[Some pictures cannot be deleted] [This picture cannot be deleted]

- Non-DCF pictures (→269) cannot be deleted. Save needed data on a computer or other device, and then use [Format] on the camera. (→38)

[Cannot be set on this picture]

- [Print Set], [Title Edit], [Text Stamp], and other functions cannot be used for pictures that are not compliant with the DCF standard (→269).



[Please turn camera off and then on again] [System Error]

- Turn the camera on again. (Consult the dealer or your nearest Service Center if display still remains.)

[A folder cannot be created]

- Folder numbers in use have reached 999. Save needed data on a computer or other device, and then use [Format] on the camera (→38). Folder number is reset to 100 when performing [No.Reset] (→85).

[Editing operation cannot proceed as another operation is taking place.]

- If you display the playback screen when the camera contains many picture files, the acquiring information icon [] or [] may be displayed for a long time. While either one of these icons is displayed, some of the [Playback] menus cannot be used. You cannot create pictures from motion pictures or play back 4K burst files recorded with the 4K Photo function. If you have been playing back a motion picture, stop the playback and wait for while until the message disappears.

When the camera is turned off while information is being acquired, only the pictures whose information has been acquired up to that time are saved as a group. When the camera is turned on again, the camera once again begins acquiring information of the remaining pictures in the group.



Menu list

[Rec]

- The [Photo Style], [Filter Settings], [Sensitivity], [AF Mode], [AFS/AFF/AFC], [Metering Mode], **ZS100** [Highlight Shadow], [i.Dynamic], [i.Resolution], [Diffraction Compensation], [i.Zoom] and [Digital Zoom] menu items are common for both [Rec] and [Motion Picture] menus. If a setting in one menu is changed, the setting with the same name in other menu will also be changed automatically.

[Photo Style]	→129
[Filter Settings]	→131
[Aspect Ratio]	→139
[Picture Size]	→139
[Quality]	→140
[Sensitivity]	→179
ZS60	
[White Balance]	→134
[AF Mode]	→149
[AFS/AFF/AFC]	→148
[Metering Mode]	→183
[Burst Rate]	→202
[4K PHOTO]	→184
[Auto Bracket]	→206
[Self Timer]	→208
ZS100	
[Highlight Shadow]	→133
[i.Dynamic]	→142
[i.Resolution]	→142
[Post Focus]	→210
[iHandheld Night Shot]	→91
[iHDR]	→92
[HDR]	→143
ZS100	
[Multi Exp.]	→223

[Time Lapse Shot]	→216
[Stop Motion Animation]	→219
[Panorama Settings]	→110
[Shutter Type]	→199
ZS100	
[Flash]	→243
ZS60	
[Flash Adjust.]	→250
[Red-Eye Removal]	→245
[ISO Limit Set]	→181
[ISO Increments]	→181
[Extended ISO]	→182
ZS100	
[Long Shtr NR]	→144
[Diffraction Compensation]	→144
[i.Zoom]	→237
[Digital Zoom]	→238
ZS100	
[Color Space]	→145
[Stabilizer]	→234
[Face Recog.]	→226
[Profile Setup]	→229

[Motion Picture]

- The [Photo Style], [Filter Settings], [Sensitivity], [AF Mode], [AFS/AFF/AFC], [Metering Mode], **ZS100** [Highlight Shadow], [i.Dynamic], [i.Resolution], [Diffraction Compensation], [i.Zoom] and [Digital Zoom] menu items are common for both [Rec] and [Motion Picture] menus. If a setting in one menu is changed, the setting with the same name in other menu will also be changed automatically.
For details, refer to the corresponding item of the [Rec] menu.

[4K Live Cropping]	→258
[Snap Movie]	→262
[Rec Format]	→255
[Rec Quality]	→255
[Exposure Mode]	→124
[High Speed Video]	→125

[Continuous AF]	→257
[Level Shot]	→266
[Flkr Decrease]	→266
[Silent Operation]	→126
[Wind Noise Canceller]	→267
[Zoom Mic]	→267

f_c [Custom]

[Cust.Set Mem.]	→127	[Highlight]	→57
[Silent Mode]	→225	[Zebra Pattern]	→230
[AF/AE Lock]	→173 →175	[Monochrome Live View]	→231
[AF/AE Lock Hold]	→173 →175	ZS100	
[Shutter AF]	→163	[Constant Preview]	→105
[Half Press Release]	→163	[Expo.Meter]	→98
[Quick AF]	→163	[Dial Guide]	→52
[Eye Sensor AF]	→60	[LVF Disp.Style]	→53 →54
ZS100		[Monitor Disp. Style]	→53 →54
[Pinpoint AF Time]	→160	[Rec Area]	→252
ZS100		[Remaining Disp.]	→41
[Pinpoint AF Display]	→160	[Auto Review]	→47
[AF Assist Lamp]	→164	[Fn Button Set]	→70
[Direct Focus Area]	→156 →169	[Zoom lever]	→239
[Focus/Release Priority]	→164	[Zoom Resume]	→239
[AF+MF]	→164	ZS100	
[MF Assist]	→171	[Q.MENU]	→69
[MF Assist Display]	→169	[Ring/Dial Set]	→74 →75
[MF Guide]	→171	[Eye Sensor]	→60
[Peaking]	→172	[Touch Settings]	→61
[Histogram]	→55	[Touch Scroll]	→268
[Guide Line]	→55	[Menu Guide]	→116

[Setup]

[Online Manual]	→76
[Clock Set]	→42
[World Time]	→76
[Travel Date]	→77
[Wi-Fi]	→344
[Beep]	→78
[Live View Mode]	→78
[Monitor Display]/[Viewfinder]	→79
[Monitor Luminance]	→80
[Economy]	→81
[USB Mode]	→82
[TV Connection]	→82
[m/ft]	→84

[Menu Resume]	→84
[Menu Background]	→84
[Menu Information]	→84
[Language]	→84
[Version Disp.]	→85
[Exposure Comp. Reset]	→85
[Self Timer Auto Off]	→85
[No.Reset]	→85
[Reset]	→86
[Reset Wi-Fi Settings]	→86
[Demo Mode]	→86
[Format]	→38

[Playback]

[Slide Show]	→280
[Playback Mode]	→281
[Location Logging]	→283
ZS100	
[RAW Processing]	→284
[Light Composition]	→287
[Clear Retouch]	→289
[Title Edit]	→290
[Text Stamp]	→291
[Video Divide]	→292
[Time Lapse Video]	→293

[Stop Motion Video]	→293
[Resize]	→294
[Cropping]	→295
[Rotate]	→296
[Rotate Disp.]	→296
[Favorite]	→297
[Print Set]	→298
[Protect]	→299
[Face Rec Edit]	→299
[Picture Sort]	→300

Q&A Troubleshooting

① Try checking these items (→383 - 397) first.

If the problem persists,

- ② Performing [Reset] in the [Setup] menu may resolve the issue (→86). (Note that except for some items such as [Clock Set], all settings are returned to their values at the time of purchase.)
- ③ Also, see the Panasonic support site for the latest support information.
<http://panasonic.jp/support/global/cs/dsc/>
 (This site is available in English only.)

■ Battery, power

The charging lamp blinks.

- Charging is being performed in a place with extremely high or low temperature.
 → Reconnect the USB connection cable (supplied) and retry charging in a place where ambient temperature is 10 °C to 30 °C (50 °F to 86 °F) (temperature conditions also apply to the battery itself).
- Charging is not possible if the power supply capacity of the computer is low.

Camera does not work even if the camera is turned on. Camera switches off as soon as the camera is turned on.

- Battery needs recharging.
 → Turn the camera off frequently by using the [Economy] etc. (→81)

This unit is turned off automatically.

- [Economy] is activated. (→81)
- The linked operation of VIERA Link (HDMI) is enabled.
 → If you are not using VIERA Link (HDMI), set [VIERA Link] to [OFF]. (→83)

Card/battery door does not close.

- Insert the battery securely all the way in. (→26, 27)

The battery runs down quickly.

- [4K PHOTO] is set to [] ([4K Pre-Burst]).
 → When [] ([4K Pre-Burst]) has been selected, the battery drains faster.
 Select [] ([4K Pre-Burst]) only when recording.
- The Wi-Fi connection has been on for a long time.
 → The battery is used up faster with a Wi-Fi connection. Turn off the camera as often as possible using [Economy] (→81) or other methods.

■ Recording

Cannot record pictures. The shutter will not operate immediately when the shutter button is pressed.

- [4K PHOTO] is set to [] ([4K Pre-Burst]).
→ When [4K PHOTO] in the [Rec] menu is set to [] ([4K Pre-Burst]), the camera temperature rises. In some cases, the camera may display [], switch to [] ([4K Burst]) and stop the recording to protect itself. Wait until the camera cools down.
- Focus is not aligned.
→ When [Focus/Release Priority] is set to [FOCUS], the camera will not record until proper focusing is achieved. (→164)

Recorded pictures look white.

- Lens is dirty (fingerprints, etc.).
→ Turn the camera off and clean the lens surface with a soft dry cloth.

Recorded pictures are too bright/too dark.

- Adjust the exposure (→177).
- AE Lock (→173, 175) is set inappropriately.

Some pictures are taken when I press the shutter button just once.

- Cancel the following settings:
 - [Simultaneous record w/o filter] (→132)
 - White Balance Bracket (→138)
 - [Burst]/[Auto Bracket]/[] of the self-timer (→201)

Focus not aligned correctly.

- Subject outside of focus range. (→46)
- Caused by jitter or subject movement. (→234)
- [Focus/Release Priority] is set to [RELEASE]. (→164)
- [Shutter AF] is set to [OFF]. (→163)
- AF Lock (→173, 175) is set inappropriately.
- If there are fingerprints or dirt on the lens, the focus may be set to the lens and not the subject. (When the Scene Guide Mode is set to [Soft Image of a Flower], and during macro recording)

Recorded pictures are blurred. The stabilizer function ineffective.

- Shutter speed is slower in dark locations and the stabilizer function is less effective.
→ Hold camera firmly with both hands, keeping arms close to body.
→ Use a tripod and the self-timer when using a slower shutter speed (→208).
- If you take a picture of a moving subject using the electronic shutter, the subject in the picture may be skewed in some cases. (→199)

Taking pictures using White Balance Bracket is not possible.

- Is there any memory remaining on the card?

Recorded pictures appear coarse, or there is interference.

- We recommend trying the following methods.
 - Lower ISO sensitivity (→179).
 - Take pictures in brighter locations.
 - Either adjust [Noise Reduction] of [Photo Style] to a higher setting or set each item other than [Noise Reduction] to a lower setting. (→130)
 - **ZS100**
 - Set [Long Shtr NR] to [ON]. (→144)
 - Change the settings of [Picture Size] (→139) and [Quality] (→140).
- When Digital Zoom is used, the picture quality will become lower if you zoom in higher.

Subject appears skewed in pictures.

- If you take a picture of a moving subject in the electronic shutter mode, motion picture recording mode, or 4K photo recording mode, the subject in the picture may be skewed in some cases. This is characteristic of MOS sensors which serve as the camera's pickup sensors. This is not a malfunction.

Striping or flicker may appear under lighting such as fluorescent lighting and LED lighting fixture.

- This is characteristic of MOS sensors which serve as the camera's pickup sensors. This is not a malfunction.
- If you are taking still pictures using the electronic shutter, the striping may be reduced by setting a slower shutter speed. (→102)
- When noticeable flicker or striping is seen under lighting such as a fluorescent or LED lighting fixture in the motion picture recording mode, you can reduce the flicker or striping by setting up [Flkr Decrease] (→266) and fixing the shutter speed. It is possible to select a shutter speed from [1/50], [1/60], [1/100], or [1/120]. You can set the shutter speed manually in the Creative Video Mode. (→124)

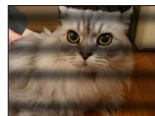
**Brightness or coloring of recorded picture different from real life.**

- When recording under fluorescent or LED lighting fixture etc., increasing the shutter speed may introduce slight changes to brightness and color. These are a result of the characteristics of the light source and do not indicate a malfunction.
- When recording subjects in extremely bright locations or recording under fluorescent lighting, LED lighting fixture, mercury lamp, sodium lighting etc., the colors and screen brightness may change or horizontal striping may appear on the screen.

Subject cannot be locked. (AF tracking not possible)

- Set the AF area to the distinctive color of the subject if there is a part that is different from the surrounding color. (→151)

Low or inaudible operating sound.

- The speaker is blocked.

Panorama picture recording stops before finishing.

- If the pan motion of the camera is too slow, the camera assumes that the operation has been aborted and stops recording.
- If the pan motion of the camera is too shaky when it is moved toward the recording direction, the camera stops recording.

4K photo recording stops before finishing.

- When the ambient temperature is high or recording with [] ([4K Burst]) or [] ([4K Burst(S/S)]) of the 4K Photo function is performed continuously, the camera may display [] and stop the recording to protect itself. Wait until the camera cools down.

■ Motion Picture**Cannot record motion pictures.**

- When a large capacity card is used, you may not be able to take a picture for a while after you turn on the camera.

Motion picture recording stops midway.

- When the ambient temperature is high or motion picture is recorded continuously, the camera may display [] and stop the recording to protect itself. Wait until the camera cools down.
- The speed class of a required card varies depending on [Rec Format] and [Rec Quality] of a motion picture. Be sure to use a card of the recommended speed class. For details, refer to "About motion picture/4K photo recording and speed class ratings" (→37).
- If recording stops even when using a card of the recommended speed class, the data writing speed has dropped. If this happens, we recommend backing up the data on the memory card and formatting it (→38).

The screen turns dark while recording motion pictures.

- While motion pictures are being recorded, the screen may turn dark as time passes in order to slow battery consumption. This condition, however, will not affect the recorded motion picture.

The screen turns momentarily black or noise is recorded.

- While motion pictures are being recorded, the screen may momentarily turn black or noise may be recorded due to static electricity or strong electromagnetic waves (radio transmitters, high-voltage lines, etc.) under some environmental conditions.

Sometimes focus adjustment with Auto Focus mode is difficult while recording 4K motion pictures.

- This may occur when taking a picture by reducing the Auto Focus speed in order to adjust the focus at high precision. This is not a malfunction.

A noise, such as a clicking or buzzing noise, is recorded on a motion picture. Audio is recorded at low volumes.

- With recording in a quiet environment, the sound of aperture, focus and other actions may be recorded in motion pictures. This is not a malfunction. The focus operation during recording of motion pictures can be set to [OFF] in [Continuous AF] (→257).
- Use of [Silent Operation] is recommended if you are concerned about operational sounds. (→126)
- If you block the microphone with your fingers while motion pictures are being recorded, the audio may be recorded at a low volume or may not be recorded at all. In this case, the camera may pick up the lens operating sounds more easily.

Operating sounds are recorded at the end of the motion picture recording.

- If the operation sound of the motion picture button pressed to end recording bothers you, try the following:
 - Record the motion picture about three seconds longer, and then divide the last part of the motion picture using [Video Divide] (→292) in the [Playback] menu.

Flash**No flash emitted.**

- The flash becomes unavailable in the following cases.
 - **ZS100**
The flash is closed. (→241)
 - **ZS60**
Flash set to [⊘] (Forced Flash Off). (→244)
- Set [Shutter Type] to [AUTO] or [MSHTR]. (→199)
- Set [Silent Mode] to [OFF]. (→225)

The flash fires twice.

- The flash fires twice. When red-eye reduction (→243, 244) is set, the firing interval will be longer. Make sure that the subject does not move until the second firing is completed.

■ Monitor/viewfinder

The monitor display momentarily turns off.

- When the monitor display automatically switches between finder and monitor (→59), the action of the eye sensor causes automatic switching of the display to the finder if the finder gets close to the user's eye or an object.

The monitor/viewfinder is turned off although the camera is turned on.

- If no operations are performed during the set time period [Auto LVF/Monitor Off] (→81) is activated, and the monitor/viewfinder turns off.
- When a hand or an object is close to the eye sensor, the monitor display mode could be switched to viewfinder display mode. (→59)

The screen is too bright/too dark.

- Check [Monitor Luminance] setting. (→80)
- Use [Monitor Display]/[Viewfinder] to adjust the brightness of the screen. (→79)

It may flicker for an instant or the brightness of the screen may change significantly for an instant.

- This occurs due to the aperture of the lens changing when the shutter button is pressed halfway, or when the brightness of the subject changes. This is not a malfunction.

The screen flickers indoors.

- The screen may flicker for a few seconds after turning on. This is an operation to correct flicker caused by lighting such as fluorescent lights, LED lights, etc. and is not a malfunction.

Pictures do not show on the monitor.

- Viewfinder display mode is activated.
→ Press the [LVF] button to switch to the monitor display mode. (→58)
- Monitor is turned off.
→ Press the [DISP.] button to switch the display information. (→53)

Cannot switch between the monitor and viewfinder when pressing [LVF] button.

- When it is connected to a computer or printer, the camera can display pictures on the monitor only.

Black, white, red, blue and green dots appear on the Monitor/Viewfinder.

- This is not a fault, and will not be recorded on the actual pictures.

Noise appears on the monitor/viewfinder.

- In dark places, noise may appear to maintain the brightness of the monitor/viewfinder.

■ Playback

The picture being played back is not rotated, or is rotated in an unexpected direction, when displayed.

- When [Rotate Disp.] is set to [OFF], the picture is displayed without changing its orientation. (→296)
- You can rotate pictures with the [Rotate] function. (→296)

Cannot view pictures. There are no recorded pictures.

- A card is not inserted in the camera.
- Has the file name of the picture been changed on a computer? If so, it cannot be played back on the camera.
→ It is recommended to use the "PHOTOfunSTUDIO" software (→353) to write pictures from PC to card.
- Set [Playback Mode] to [Normal Play]. (→281)

Folder/file number displayed as [-]. Picture is black.

- Is this a non-standard picture, a picture which has been edited using a PC or a picture which was taken by another device?
- Battery removed immediately after picture taken, or picture taken with low battery.
→ Save needed data on a computer or other device, and then use [Format] on the camera. (→38)

Playback and operation sounds are too low.

- The speaker is blocked. (→20, 21)

Incorrect date displayed in Calendar Search.

- Is the clock in the camera set properly? (→42)
- Pictures edited on a PC or pictures recorded on other cameras might display a different date to the recorded date during Calendar Playback.

White round spots like soap bubbles appear on the recorded picture.



- If you take a picture with the flash in a dark place or indoors, white round spots may appear on the picture caused by the flash reflecting particles of dust in the air. This is not a fault.





[Thumbnail is displayed] is shown on the screen.



- The pictures may have been recorded on another device. If so, they may be displayed with poor picture quality.

Red areas in pictures appear blackened.**ZS100**

When the digital red-eye correction ([, [) is operating, red areas may be blackened.
→ We recommend closing the built-in flash, setting the flash mode to [, or turning [Red-Eye Removal] to [OFF] before recording. (→245)

ZS60

When the digital red-eye correction ([, [, [) is operating, red areas may be blackened.

→ We recommend setting the flash mode to []/[] or [Red-Eye Removal] to [OFF] before recording. (→245)

Motion pictures taken with this camera cannot be played in other cameras.

- Even if a motion picture is played back on a compatible device, it may have bad picture quality or sound quality upon playback, or it may not be played back. Also, the recording information may not be displayed correctly.

■ Wi-Fi function

It cannot connect to the wireless LAN. Radio waves get disconnected. Wireless access point is not displayed.

General tips for using a Wi-Fi connection

- Use within the communication range of the wireless LAN network.
- Is any device, such as microwave oven, cordless phone, etc., that uses 2.4 GHz frequency operated nearby?
 - Radio waves may get interrupted when used simultaneously. Use them sufficiently away from the device.
- When the battery indicator is flashing red, the connection with other equipment may not start or the connection may be disrupted. (A message such as [Communication error] is displayed.)
- When this unit is placed on a metal table or shelf, the connection may not be established easily. Use the camera away from metal surfaces.

About a wireless access point

- Check if the wireless access point to connect is in operating state.
- The camera may not display or connect to a wireless access point depending on the radio wave condition.
 - Perform the connection closer to the wireless access point.
 - Remove the obstacles between this unit and the wireless access point.
 - Change the direction of this unit.
 - Move the location or change the angle of the wireless access point.
 - Perform the [Manual Input]. (→340)
- It may not display even if the radio waves exist depending on the setting of the wireless access point.
- Is the network SSID of the wireless access point set not to broadcast?
 - It may not be detected when it is set not to broadcast. Enter and set the network SSID. (→339)
Alternatively, set the network SSID of the wireless access point to broadcast.
- Connection types and security setting methods are different depending on the wireless access point.
 - Refer to the operating instructions of the wireless access point.
- Is the 5 GHz/2.4 GHz switchable wireless access point connected to other equipment using the 5 GHz band?
 - The use of a wireless access point that can use 5 GHz/2.4 GHz simultaneously is recommended. It cannot be used simultaneously with this camera if it is not compatible.

It takes long time every time to connect to a smartphone.

- It may take longer time to connect depending on the Wi-Fi connection setting of the smartphone, but it is not a malfunction.

This unit is not displayed in the Wi-Fi setting screen of the smartphone.

- Try switching the ON/OFF of the Wi-Fi function in the Wi-Fi settings of the smartphone.

I have forgotten the login ID or password for the "LUMIX CLUB".

- Check the information in the login screen of "LUMIX CLUB".
<http://lumixclub.panasonic.net/eng/c/>

I do not have a wireless access point at my home, but I would like to perform service user registration of the "LUMIX CLUB".

- Service user registration for the "LUMIX CLUB" is not possible in the environment without a wireless access point.

The camera cannot be connected to Mac computer/Windows PC via Wi-Fi connection.

- Please confirm login name and password are correctly typed.
- When the system time of Mac computer or Windows PC connected to a camera differs severely from that of the camera, the camera cannot be connected to the computer or PC in some OSs. Please confirm clock set and world time of the camera matches with time, date and time zone in Windows PC or Mac computer. When both settings do not match severely, please match them.

I am having a problem connecting to my Windows 8 PC. The user name and password are not recognized.

- Depending on the OS version, on Windows 8, for example, there are two types of user account (local account/Microsoft account).
→ Be sure to set the local account and use the user name and password for the local account.



The Wi-Fi connection is not recognizing my PC.

- By default, the Wi-Fi connection uses the default workgroup name of "WORKGROUP". If the name of the workgroup has been changed, it will not be recognized.
→ Select [PC Connection] then [Change Workgroup Name] in the [Wi-Fi Setup] to change the workgroup name to match that of your PC. (→344)

Pictures cannot be transmitted to the computer.

- If a firewall is enabled by the OS or security software, this unit may be unable to connect to the computer.

Images cannot be transmitted to the WEB service.

- Confirm that the login information (login ID/user name/email address/password) is correct.
- WEB service server or the network may be busy.
→ Try again after a while.
→ Check the site of the WEB service you are sending the image to.

It takes time to transmit an image to the WEB service.

- Is the size of the image too large?
→ Transmit after dividing the motion picture with [Video Divide] (→292).
→ Reduce the image size at [Size] (→321), and then send.
- It may take longer time to transmit when distance to the wireless access point is far.
→ Transmit closer to the wireless access point.

The image that was supposed to have uploaded to the WEB service is not there.

- Upload may not complete when it is disconnected while transmitting the image.
- It may take some time after uploading the image to be reflected in the WEB service depending on the status of the server.
→ Wait for a while and try again.
- You can check the transmission status on the WEB service link settings by logging into "LUMIX CLUB".

I would like to return the image in the WEB service to the camera.

- The images in the WEB Service cannot be saved (downloaded) to this unit. Do not delete the uploaded images, and make a backup of them.

I cannot display or delete the images uploaded to the WEB service by this unit.

- The images uploaded to the WEB service cannot be displayed or deleted by this unit.
→ Perform the task using a smartphone or a PC.

Your “LUMIX CLUB” login ID and password were deleted after sending the camera in to be repaired.

- The settings stored in the camera may be deleted depending on the type of repair.
→ Always make a copy of important settings.

Transmission of the image fails midway. There is an image that could not be transmitted.

- Image cannot be transmitted when the battery indicator is flashing red.
- Is the size of the image too large?
→ Divide the motion picture using [Video Divide] (→292).
→ Reduce the image size at [Size] (→321), and then send.
- File format of the picture that can be sent differs depending on the destination. (→319)
- Capacity or number of images in the WEB service is full.
→ Login to “LUMIX CLUB”, and check the status of the destination on the WEB service link settings.

I have forgotten the password for the Wi-Fi.

- Execute the [Reset Wi-Fi Settings] in the [Setup] menu. (→86)
However, the information you have set on the [Wi-Fi Setup] will be reset.

I cannot send images to an AV device.

- Sending may fail depending on the operational status of the AV device. Also, sending may take a while.

■ TV, computer, printer**No image appears on TV. Image blurred or not colored.**

- Not connected correctly (→348).
- The television has not been switched to auxiliary input.

The display on the TV and on the camera do not match.

- Aspect ratio may be incorrect or edges may be cut off with certain televisions.

Cannot play motion pictures on TV.

- Card is inserted into TV.
→ Connect with HDMI micro cable and play on camera (→348).

No sound is output from the camera speaker.

- When the HDMI micro cable is connected to the camera, no sound is output from the camera.

VIERA Link (HDMI) is not working.

- Check that the HDMI micro cable is fully inserted. (→348)
- Is the camera's [VIERA Link] setting set to [ON]? (→83)
 - The input setting may not be able to be changed automatically with certain television HDMI sockets. In this case, please change the input setting with your television's remote control (consult your television's operating instructions for details).
 - Check the VIERA Link (HDMI) settings on the device you are connecting to.
 - Turn the camera off and on again.
 - Turn the "VIERA Link control (HDMI device control)" setting on your television (VIERA) to off and then to on again. (Consult your VIERA's operating instructions for details.)

Cannot communicate with the computer.

- Check whether computer has recognized camera (→355).
 - Set [USB Mode] to [PC] (→82).
 - Turn the camera off and then on again.



Computer does not recognize card.

- Disconnect USB connection cable (supplied) and reconnect with card in place.
- If there are two or more USB terminal on a single PC, try connecting the USB connection cable to another USB terminal.

Computer does not recognize card. (When using an SDXC Memory Card)

- Check whether your computer is compatible with SDXC Memory Cards.
<http://panasonic.net/avc/sdcard/information/SDXC.html>
- A message prompting you to format the card may appear when you connect it. Do not format the card.
- If the [Access] indicator on the screen does not go off, turn the camera off before disconnecting the USB connection cable.

Cannot print when connecting to printer.

- Printer not compatible with PictBridge.
- Set [USB Mode] to [PictBridge(PTP)] (→82, 358).

The edges of pictures are cut off when printing.

- Release any trimming or edgeless printing settings on printer before printing.
- The aspect ratio of pictures is different from that of paper used for printing.
→ If printing in shop, check if 16:9 sizes can be printed.

Cannot print panorama pictures properly.

- The aspect ratio of panorama pictures is different from that of regular still pictures, and some panorama pictures may not be printed correctly.
→ Use a printer with support for panorama pictures.
→ We recommend adjusting the size of a picture in accordance with print paper using the "PHOTOfunSTUDIO" software (→353).



■ Others

The lens makes a clicking noise.

- When the camera is turned on or off, the lens is moved, or an aperture operation is performed, such a noise may be heard. This is not a malfunction.
- When the brightness changes after a zooming operation or moving the camera, the lens may make a noise while adjusting the aperture. This is not a malfunction.

Zooming stops instantaneously.

- When using the Extended Optical Zoom, the zooming action will stop temporarily. This is not a malfunction.

Red lamp illuminated when pressing shutter button halfway in dark locations.

- [AF Assist Lamp] is set to [ON] (→164).

AF Assist Lamp is not illuminated.

- [AF Assist Lamp] is set to [OFF] (→164).
- Not illuminated in bright locations.

Part of a picture flashes black and white.

- [Highlight] is set to [ON]. (→57)

Camera is hot.

- Camera may become a little warm during use, but this does not affect performance or quality.

Clock is incorrect.

- If you do not use the camera for a long time, the clock may be reset.
→ Reset the clock (→43).

When using zoom, picture becomes slightly warped and the edges of the subject become colored.

- Pictures may be slightly warped or colored around the edges, depending on the zoom ratio, but this is not a fault.

File numbers are not recorded in sequence.

- If you perform an operation after performing a specific operation, the picture may be saved in a folder with a different folder number than the previous folder number.

File numbers have jumped backwards.

- If you insert or remove the battery before turning off the camera, the folder and file numbers for the pictures taken will not be stored in the memory. Therefore, when the camera is turned on again and pictures are taken, they may be stored under file numbers which should have been assigned to previous pictures.

Usage cautions and notes

When in use

- Camera may become warm if used for long periods of time, but this is not a fault.
- **Keep this unit as far away as possible from electromagnetic equipment (such as microwave ovens, TVs, video games etc.).**
 - If you use this unit on top of or near a TV, the pictures and/or sound on this unit may be disrupted by electromagnetic wave radiation.
 - Do not use this unit near cell phones because doing so may result in noise adversely affecting the pictures and/or sound.
 - Recorded data may be damaged, or pictures may be distorted, by strong magnetic fields created by speakers or large motors.
 - Electromagnetic wave radiation may adversely affect this unit, disturbing the pictures and/or sound.
 - If this unit is adversely affected by electromagnetic equipment and stops functioning properly, turn this unit off and remove the battery or disconnect AC adaptor (supplied)/ AC adaptor (optional). Then reinsert the battery or reconnect AC adaptor and turn this unit on.

Do not use this unit near radio transmitters or high-voltage lines.

- If you record near radio transmitters or high-voltage lines, the recorded pictures and/or sound may be adversely affected.
- Do not extend the supplied cord or cable.
- Do not allow camera to come into contact with pesticides or volatile substances (can cause surface damage or coating to peel).
- **ZS100**
Do not keep objects that may be influenced magnetically close to the speaker.
 - Magnetized objects such as bank cards, commuter passes, watches, may be adversely affected by the magnetic influence of the speaker.
- Never leave the camera and the battery in a car or on a car hood in the summer. Doing so may cause leakage of the battery electrolyte, overheating, fire or a battery explosion due to the high temperature.

Caring for your camera

To clean your camera, remove the battery, the DC coupler (optional) or a card, or disconnect the power plug from the outlet, and wipe with a soft, dry cloth.

- Use a damp cloth to remove stubborn stains, before wiping with a dry cloth.
- Do not use benzine, thinners, alcohol, or kitchen detergent, as these may damage the outer casing and finish of the camera.
- If using a chemically-treated cloth, read the supplied instructions carefully.
- Do not touch the lens barrier.

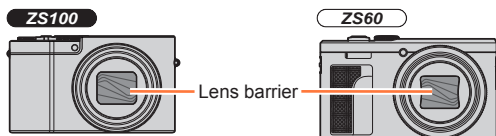

When not using for a while

- Turn off the camera before removing battery and card (ensure that battery is removed to prevent damage through over-discharge).
- Do not leave in contact with rubber or plastic bags.
- Store together with a drying agent (silica gel) if leaving in drawer, etc. Store batteries in cool (15 °C to 25 °C (59 °F to 77 °F)) places with low humidity (40%RH to 60%RH) and no major temperature changes.
- Charge battery once per year and use completely before storing again.
- Check all the parts before taking pictures when you have not used the camera for a long period of time.

Monitor/viewfinder

- Do not press hard on the monitor. This may cause uneven display and damage the monitor.
- In cold climates or other situations when the camera becomes cold, the monitor or the viewfinder may appear slightly darker than normal immediately after the camera is turned on. Normal brightness will return once the internal components have warmed up.

The monitor and viewfinder are made with extremely high precision technology. However there may be some dark or bright spots (red, blue or green) on the screen. This is not a malfunction. The monitor and viewfinder screens are controlled with extremely high precision, but some pixels may be inactive. The spots will not be recorded on pictures on a card.



Lens

- Do not press the lens with excessive force.
- Images may appear slightly white if lens is dirty (fingerprints, etc.). Turn the camera on, hold the extracted lens barrel with your fingers, and gently wipe the lens surface with a soft, dry cloth.
- Do not leave the camera with the lens facing the sun as rays of light from the sun may cause it to malfunction. Also, be careful when placing the camera outside or near a window.
- Do not touch the lens barrier, as this may damage the lens. Be careful when removing camera from bag, etc.

Battery

The battery is a rechargeable lithium ion battery.

This battery is easily affected by temperature and humidity, and is affected more when the temperature is high or low.

- The time required for charging varies depending on conditions of battery usage. Charging takes longer at high or low temperatures and when the battery has not been used in some time.
- Battery will be warm during charging and for some time thereafter.
- Battery will run out if not used for long periods of time, even after being charged.
- Do not leave any metal items (such as clips) near the contact areas of the power plug. Otherwise, a fire and/or electric shocks may be caused by short-circuiting or the resulting heat generated.
- Frequently charging up battery is not recommended. (Frequently charging battery reduces maximum usage time and can cause battery to expand.)
- If available battery power is significantly reduced, battery is reaching end of lifespan. Please purchase a new battery.
- When charging:
 - Wipe dirt from the battery terminal with a dry cloth.
 - Keep at least 1 m (3.3 feet) away from AM radio (may cause radio interference).
- Do not use a damaged or dented battery (especially connectors), e.g. by dropping (can cause faults).

AC adaptor (supplied)

- Keep at least 1 m (3.3 feet) away from AM radio (may cause radio interference).
- The AC adaptor (supplied) may generate whirring sounds when it is being used. This is not a malfunction.
- After use, be sure to disconnect the power supply device from the electrical outlet. (A very small amount of current is consumed if it is left connected.)

Memory cards

- To prevent damage to cards and data
 - Avoid high temperatures, direct sunlight, electromagnetic waves, and static electricity.
 - Do not bend, drop, or expose to strong impacts.
 - Put the card in the card case or the storage bag after use and when storing or carrying the card.
 - Do not touch terminals on reverse of card or allow them to become dirty or wet.
- Recorded data may be damaged or lost if the camera breaks down due to inappropriate handling. Panasonic will not be liable for any damage caused due to loss of recorded data.
- When disposing of/transferring memory cards
 - If using the "format" or "delete" functions on your camera or computer, this only changes the file management information, and does not completely delete the data from within the memory card. When disposing of or transferring your memory cards, we recommend physically destroying them, or using commercially available computer data erasing software to completely delete the data from the card. Data within memory cards should be managed responsibly.

When using a tripod or unipod

- Do not apply excessive force or tighten screws when they are crooked. (This may damage the camera, screw hole, or label.)
- Ensure that the tripod is stable. (Refer to the tripod instructions.)
- You may not be able to remove the card or the battery when using a tripod or unipod.

Personal Information

To protect personal information, we recommend that you set a Wi-Fi password or a Wi-Fi function lock. (→344, 345)

If names or birthdays are set in [Profile Setup] or in the [Face Recog.] function, keep in mind that the camera and recorded pictures will contain personal information.

Be sure to pay special attention to the privacy, likeness rights, etc. of a subject and take your own responsibility when you use the [Silent Mode], or use functions such as writing the location information and changing the shutter noise, etc.

● Disclaimer

- Data containing personal information can be altered or lost due to malfunction, static electricity, accidents, breakdowns, repairs, or other operations.

Panasonic will not be liable for any damage that occurs, direct or indirect, as a result of the alteration or loss of data containing personal information.

● When ordering repairs or transferring/disposing of the camera

- After you make a note of the personal information, perform [Reset Wi-Fi Settings]/ [Delete account] to delete data containing personal information such as wireless LAN connection settings that you registered or set in this unit. (→86, 336)
- To protect your personal information, please reset the settings. (→86)
- Remove the memory card from the camera.
- When ordering repairs, settings may be returned to the initial purchase state.
- If the above operations cannot be performed because of a camera malfunction, consult with the dealer or nearest Service Center.

● When transferring or disposing of your memory card, see “When disposing of/ transferring memory cards” in the previous section. (→401)

● Uploading pictures to WEB services

- Pictures may contain personal information that can be used to identify the user, such as titles, recording dates and times, and location information. Before uploading the pictures to WEB services, check the pictures carefully for information that should not be disclosed.

Wi-Fi function

■ Use the camera as a wireless LAN device

When using equipment or computer systems that require more reliable security than wireless LAN devices, ensure that the appropriate measures are taken for safety designs and defects for the systems used. Panasonic will not take any responsibility for any damage that arises when using the camera for any purpose other than as a wireless LAN device.

■ Use of the Wi-Fi function of this camera is presumed to be in countries where this camera is sold

There is the risk that the camera violates the radio wave regulations if used in countries other than those where this camera is sold, and Panasonic takes no responsibility for any violations.

■ There is the risk that data sent and received via radio waves may be intercepted

Please note that there is the risk that data sent and received via radio waves may be intercepted by a third party. We strongly recommend that you enable encryption in the settings of your wireless access point to ensure information security.

■ Do not use the camera in areas with magnetic fields, static electricity or interference

- Do not use the camera in areas with magnetic fields, static electricity or interference, such as near microwave ovens. Radio waves may not reach the camera.
- Using the camera near devices such as microwave ovens or cordless telephones that use the 2.4 GHz radio wave band may cause a decrease in performance in both devices.

■ Do not connect to the wireless network you are not authorized to use

When the camera utilizes its Wi-Fi function, wireless networks will be searched automatically. When this happens, wireless networks that you are not authorized to use (SSID*) may be displayed, however do not attempt to connect to the network as it may be considered as unauthorized access.

*SSID refers to the name that is used to identify a network over a wireless LAN connection. If the SSID matches for both devices, transmission is possible.

Usage cautions and notes

- SDXC Logo is a trademark of SD-3C, LLC.
- The terms HDMI and HDMI High-Definition Multimedia Interface, and the HDMI Logo are trademarks or registered trademarks of HDMI Licensing, LLC in the United States and other countries.
- HDAVI Control™ is a trademark of Panasonic Corporation.
- "AVCHD", "AVCHD Progressive" and the "AVCHD Progressive" logo are trademarks of Panasonic Corporation and Sony Corporation.
- Manufactured under license from Dolby Laboratories. Dolby and the double-D symbol are trademarks of Dolby Laboratories.
- Adobe is a trademark or registered trademark of Adobe Systems Incorporated in the United States and/or other countries.
- Pentium is a trademark of Intel Corporation in the U.S. and/or other countries.
- Windows is either registered trademark or trademark of Microsoft Corporation in the United States and/or other countries.
- iMovie, Mac and Mac OS are trademarks of Apple Inc., registered in the U.S. and other countries.
- iPad, iPhone, iPod, and iPod touch are trademarks of Apple Inc., registered in the U.S. and other countries.
- App Store is a service mark of Apple Inc.
- Android and Google Play are trademarks or registered trademarks of Google Inc.
- The Wi-Fi CERTIFIED™ Logo is a certification mark of Wi-Fi Alliance®.
- The Wi-Fi Protected Setup™ Identifier mark is a certification mark of Wi-Fi Alliance®.
- "Wi-Fi®" and "Wi-Fi Direct®" are registered trademarks of Wi-Fi Alliance®.
- "Wi-Fi Protected Setup™", "WPA™", and "WPA2™" are trademarks of Wi-Fi Alliance®.
- DLNA, the DLNA Logo and DLNA CERTIFIED are trademarks, service marks, or certification marks of the Digital Living Network Alliance.
- QR Code is a registered trademark of DENSO WAVE INCORPORATED.
- This product uses "DynaFont" from DynaComware Corporation. DynaFont is a registered trademark of DynaComware Taiwan Inc.
- Other names, company names, and product names mentioned in these instructions are trademarks or registered trademarks of the companies concerned.



Usage cautions and notes

This product is licensed under the AVC Patent Portfolio License for the personal use of a consumer or other uses in which it does not receive remuneration to (i) encode video in compliance with the AVC Standard ("AVC Video") and/or (ii) decode AVC Video that was encoded by a consumer engaged in a personal activity and/or was obtained from a video provider licensed to provide AVC Video. No license is granted or shall be implied for any other use. Additional information may be obtained from MPEG LA, L.L.C.
See <http://www.mpegla.com>



Usage cautions and notes

This product incorporates the following software:

- (1) the software developed independently by or for Panasonic Corporation,
- (2) the software owned by third party and licensed to Panasonic Corporation, and/or
- (3) open source software

The software categorized as (3) is distributed in the hope that it will be useful, but WITHOUT ANY WARRANTY, without even the implied warranty of MERCHANTABILITY or FITNESS FOR A PARTICULAR PURPOSE. Please refer to the detailed terms and conditions thereof displayed by selecting [MENU/SET] → [Setup] → [Version Disp.] → [Software info].

