

Projector

***PX602UL-WH/PX602UL-BK/
PX602WL-WH/PX602WL-BK***

User's Manual

- Apple, Mac, Mac OS, and MacBook are trademarks of Apple Inc. registered in the U.S. and other countries.
- Microsoft, Windows, Windows Vista, Internet Explorer, .NET Framework and PowerPoint are either a registered trademark or trademark of Microsoft Corporation in the United States and/or other countries.
- MicroSaver is a registered trademark of Kensington Computer Products Group, a division of ACCO Brands.
- Adobe, Adobe PDF, Adobe Reader, and Acrobat are either registered trademarks or trademarks of Adobe Systems Incorporated in the United States and/or other countries.
- Virtual Remote Tool uses WinI2C/DDC library, © Nicomsoft Ltd.
- HDMI, the HDMI Logo and High-Definition Multimedia Interface are trademarks or registered trademarks of HDMI Licensing LLC.



- DisplayPort and DisplayPort Compliance Logo are trademarks owned by the Video Electronics Standards Association.



- HDBaseT™ is a trademark of HDBaseT Alliance.



- DLP and BrilliantColor are trademarks of Texas Instruments.
- Trademark PJLink is a trademark applied for trademark rights in Japan, the United States of America and other countries and areas.
- Wi-Fi®, Wi-Fi Alliance®, and Wi-Fi Protected Access (WPA, WPA2)® are registered trademarks of the Wi-Fi Alliance.
- Blu-ray is a trademark of Blu-ray Disc Association
- CRESTRON and ROOMVIEW are registered trademarks of Crestron Electronics, Inc. in the United States and other countries.
- Ethernet is either a registered trademark or trademark of Fuji Xerox Co., Ltd.
- Other product and company names mentioned in this user's manual may be the trademarks or registered trademarks of their respective holders.
- TOPPERS Software Licenses

The product includes software licensed under TOPPERS License.

For more information on each software, see "readme.pdf" inside the "about TOPPERS" folder on the supplied CD-ROM.

NOTES

- (1) The contents of this user's manual may not be reprinted in part or whole without permission.
- (2) The contents of this user's manual are subject to change without notice.
- (3) Great care has been taken in the preparation of this user's manual; however, should you notice any questionable points, errors or omissions, please contact us.
- (4) Notwithstanding article (3), NEC will not be responsible for any claims on loss of profit or other matters deemed to result from using the Projector.

Important Information

Safety Cautions

Precautions

Please read this manual carefully before using your NEC projector and keep the manual handy for future reference.

CAUTION



To turn off main power, be sure to remove the plug from power outlet. The power outlet socket should be installed as near to the equipment as possible, and should be easily accessible.

CAUTION



TO PREVENT SHOCK, DO NOT OPEN THE CABINET. THERE ARE HIGH-VOLTAGE COMPONENTS INSIDE. REFER SERVICING TO QUALIFIED SERVICE PERSONNEL.



This symbol warns the user that uninsulated voltage within the unit may be sufficient to cause electrical shock. Therefore, it is dangerous to make any kind of contact with any part inside of the unit.



This symbol alerts the user that important information concerning the operation and maintenance of this unit has been provided. The information should be read carefully to avoid problems.

WARNING: TO PREVENT FIRE OR SHOCK, DO NOT EXPOSE THIS UNIT TO RAIN OR MOISTURE. DO NOT USE THIS UNIT'S PLUG WITH AN EXTENSION CORD OR IN AN OUTLET UNLESS ALL THE PRONGS CAN BE FULLY INSERTED.

DOC Compliance Notice (for Canada only)

This Class B digital apparatus complies with Canadian ICES-003.

Machine Noise Information Regulation - 3. GPSGV,

The highest sound pressure level is less than 70 dB (A) in accordance with EN ISO 7779.

Disposing of your used product



EU-wide legislation as implemented in each Member State requires that used electrical and electronic products carrying the mark (left) must be disposed of separately from normal household waste. This includes projectors and their electrical accessories. When you dispose of such products, please follow the guidance of your local authority and/or ask the shop where you purchased the product.

After collecting the used products, they are reused and recycled in a proper way. This effort will help us reduce the wastes as well as the negative impact to the human health and the environment at the minimum level. The mark on the electrical and electronic products only applies to the current European Union Member States.

WARNING TO CALIFORNIA RESIDENTS:

Handling the cables supplied with this product will expose you to lead, a chemical known to the State of California to cause birth defects or other reproductive harm. WASH HANDS AFTER HANDLING.

RF Interference (for USA only)

WARNING

The Federal Communications Commission does not allow any modifications or changes to the unit EXCEPT those specified by NEC Display Solutions of America, Inc. in this manual. Failure to comply with this government regulation could void your right to operate this equipment. This equipment has been tested and found to comply with the limits for a Class B digital device, pursuant to Part 15 of the FCC Rules. These limits are designed to provide reasonable protection against harmful interference in a residential installation. This equipment generates, uses, and can radiate radio frequency energy and, if not installed and used in accordance with the instructions, may cause harmful interference to radio communications. However, there is no guarantee that interference will not occur in a particular installation.

If this equipment does cause harmful interference to radio or television reception, which can be determined by turning the equipment off and on, the user is encouraged to try to correct the interference by one or more of the following measures:

- Reorient or relocate the receiving antenna.
- Increase the separation between the equipment and receiver.
- Connect the equipment into an outlet on a circuit different from that to which the receiver is connected.
- Consult the dealer or an experienced radio / TV technician for help.

For UK only: In UK, a BS approved power cord with moulded plug has a Black (five Amps) fuse installed for use with this equipment. If a power cord is not supplied with this equipment please contact your supplier.

Important Safeguards

These safety instructions are to ensure the long life of your projector and to prevent fire and shock. Please read them carefully and heed all warnings.

Installation

- Do not place the projector in the following conditions:
 - on an unstable cart, stand, or table.
 - near water, baths, or damp rooms.
 - in direct sunlight, near heaters, or heat radiating appliances.
 - in a dusty, smoky or steamy environment.
 - on a sheet of paper or cloth, rugs or carpets.
- If you wish to have the projector installed on the ceiling:
 - Do not attempt to install the projector yourself.
 - The projector must be installed by qualified technicians in order to ensure proper operation and reduce the risk of bodily injury.
 - In addition, the ceiling must be strong enough to support the projector and the installation must be in accordance with any local building codes.
 - Please consult your dealer for more information.

WARNING

- Do not place any objects, which are easily affected by heat, in front of the projector lens. Doing so could lead to the object melting from the heat that is emitted from the light output.



Do not use the projector with it leaning to the left and right. This may result in a malfunction, however, portrait installation* is possible. For portrait installation, install the projector with the intake vent at the bottom. Observe precautions for portrait installation.

* A customized stand and a safety cover (sold separately) need to be attached to the projector. (→ page 136)

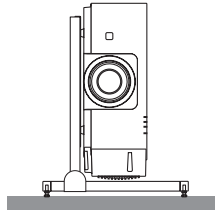

⚠ Fire and Shock Precautions ⚠

- Ensure that there is sufficient ventilation and that vents are unobstructed to prevent the build-up of heat inside your projector. Allow enough space between your projector and a wall. (→ page vii)
- Do not try to touch the exhaust vent on the left front (when seen from the front) as it can become heated while the projector is turned on and immediately after the projector is turned off. Parts of the projector may become temporarily heated if the projector is turned off with the POWER button or if the AC power supply is disconnected during normal projector operation.
Use caution when picking up the projector.
- Prevent foreign objects such as paper clips and bits of paper from falling into your projector. Do not attempt to retrieve any objects that might fall into your projector. Do not insert any metal objects such as a wire or screwdriver into your projector. If something should fall into your projector, disconnect it immediately and have the object removed by a qualified service personnel.
- Do not place any objects on top of the projector.
- Do not touch the power plug during a thunderstorm. Doing so can cause electrical shock or fire.
- The projector is designed to operate on a power supply of 100-240V AC 50/60 Hz. Ensure that your power supply fits this requirement before attempting to use your projector.
- Do not look into the lens while the projector is on. Serious damage to your eyes could result.
- Do not look into the light source using optical instruments (such as magnifying glasses and mirrors). Visual impairment could result.
- When turning on the projector, make sure no one within projection range is looking at the lens.



- Keep any items (magnifying glass etc.) out of the light path of the projector. The light path being projected from the lens is extensive, therefore any kind of abnormal objects that can redirect light coming out of the lens, can cause an unpredictable outcome such as a fire or injury to the eyes.
- Do not place any objects, which are easily affected by heat, in front of a projector exhaust vent. Doing so could lead to the object melting or getting your hands burned from the heat that is emitted from the exhaust vent.

- Handle the power cord carefully. A damaged or frayed power cord can cause electric shock or fire.
 - Do not use any power cord other than the one supplied with the projector.
 - Do not bend or tug the power cord excessively.
 - Do not place the power cord under the projector, or any heavy object.
 - Do not cover the power cord with other soft materials such as rugs.
 - Do not heat the power cord.
 - Do not handle the power plug with wet hands.
- Turn off the projector, unplug the power cord and have the projector serviced by a qualified service personnel under the following conditions:
 - When the power cord or plug is damaged or frayed.
 - If liquid has been spilled into the projector, or if it has been exposed to rain or water.
 - If the projector does not operate normally when you follow the instructions described in this user's manual.
 - If the projector has been dropped or the cabinet has been damaged.
 - If the projector exhibits a distinct change in performance, indicating a need for service.
- Disconnect the power cord and any other cables before carrying the projector.
- Turn off the projector and unplug the power cord before cleaning the cabinet.
- Turn off the projector and unplug the power cord if the projector is not to be used for an extended period of time.
- When using a LAN cable:
For safety, do not connect to the terminal for peripheral device wiring that might have excessive voltage.

CAUTION

- Do not place your fingers inside the lens hood while performing a lens shift. Failure to do so could result in fingers being pinched between the cabinet and lens.
- Do not use the tilt-foot for purposes other than originally intended. Misuses such as gripping the tilt-foot or hanging on the wall can cause damage to the projector.
- Do not send the projector in the soft case by parcel delivery service or cargo shipment. The projector inside the soft case could be damaged.
- Select [HIGH] in Fan mode if you continue to use the projector for consecutive days. (From the menu, select [SETUP] → [OPTIONS(1)] → [FAN MODE] → [MODE] → [HIGH].)
- Do not bring the projector holding it by the lens hood. The projector may be dropped down and it may be cause of human injury.
- If a safety cover (sold separately) is used, do not carry the projector by the cover. The safety cover can come off and the projector may be dropped, causing personal injury.
- Do not unplug the power cord from the wall outlet or projector when the projector is powered on. Doing so can cause damage to the AC IN terminal of the projector and (or) the prong plug of the power cord.
To turn off the AC power supply when the projector is powered on, use the projector's main power switch, a power strip equipped with a switch, or a breaker.

Caution on Handling the Optional Lens

When shipping the projector with the lens, remove the lens before shipping the projector. Always attach the dust cap to the lens whenever it is not mounted on the projector. The lens and the lens shift mechanism may encounter damage caused by improper handling during transportation.

Do not hold the lens part when carrying the projector.

Doing so could cause the focus ring to rotate, resulting in accidental dropping of the projector.

Remote Control Precautions

- Handle the remote control carefully.
- If the remote control gets wet, wipe it dry immediately.
- Avoid excessive heat and humidity.
- Do not short, heat, or take apart batteries.
- Do not throw batteries into fire.
- If you will not be using the remote control for a long time, remove the batteries.
- Ensure that you have the batteries' polarity (+/-) aligned correctly.
- Do not use new and old batteries together, or use different types of batteries together.
- Dispose of used batteries according to your local regulations.

Light Module

1. A light module containing multiple laser diodes is equipped in the product as the light source.
2. These laser diodes are sealed in the light module. No maintenance or service is required for the performance of the light module.
3. End user is not allowed to replace the light module.
4. Contact qualified distributor for light module replacement and further information.

Laser Safety Caution

- This product is classified as Class 2 of IEC60825-1 Second edition 2007-03. Also complies with FDA performance standards 21 CFR 1040.10 and 1040.11 for laser products except for deviations pursuant to Laser Notice No.50, dated June 24, 2007. Obey the laws and regulations of your country in relation to the installation and management of the device.
- The laser module is equipped in this product. Use of controls or adjustments of procedures other than those specified herein may result in hazardous radiation exposure.



DO NOT STARE INTO THE LENS WHILE IN USE.

- This caution labels are on the side face of the cabinet.



The explanatory label of the CLASS 2 LASER PRODUCTS is on the right side of the projector body.

About High Altitude mode

- Set [FAN MODE] to [HIGH] when using the projector at altitudes approximately 2500 feet/760 meters or higher. Using the projector at altitudes approximately 2500 feet/760 meters or higher without setting to [HIGH] can cause the projector to overheat and the protector could shut down. If this happens, wait a couple minutes and turn on the projector.
- Using the projector at altitudes approximately 2500 feet/760 meters or higher can shorten the life of optical components such as the light module.

About Copyright of original projected pictures:

Please note that using this projector for the purpose of commercial gain or the attraction of public attention in a venue such as a coffee shop or hotel and employing compression or expansion of the screen image with the following functions may raise concern about the infringement of copyrights which are protected by copyright law. [ASPECT RATIO], [KEYSTONE], Magnifying feature and other similar features.

Turkish RoHS information relevant for Turkish market

EEE Yönetmeliğine Uygundur.

This device is not intended for use in the direct field of view at visual display workplaces. To avoid incommoding reflections at visual display workplaces this device must not be placed in the direct field of view.

Health precautions to users viewing 3D images

Before viewing, be sure to read health care precautions that may be found in the user's manual included with your 3D eyeglasses or your 3D compatible content such as Blu-ray Discs, video games, computer's video files and the like. To avoid any adverse symptoms, heed the following:

- Do not use 3D eyeglasses for viewing any material other than 3D images.
- Allow a distance of 2 m/7 feet or greater between the screen and a user. Viewing 3D images from too close a distance can strain your eyes.
- Avoid viewing 3D images for a prolonged period of time. Take a break of 15 minutes or longer after every hour of viewing.
- If you or any member of your family has a history of light-sensitive seizures, consult a doctor before viewing 3D images.
- While viewing 3D images, if you get sick such as nausea, dizziness, queasiness, headache, eyestrain, blurry vision, convulsions, and numbness, stop viewing them. If symptoms still persist, consult a doctor.
- View 3D images from the front of the screen. Viewing from an angle may cause fatigue or eyestrain.

Power management function

In order to keep power consumption low, the following power management functions (1) and (2) have been set when shipped from the factory. Please display the on-screen menu and change the settings (1) and (2) according to the aim of using the projector.

1. STANDBY MODE (Factory preset: NORMAL)

- When [NORMAL] is selected for [STANDBY MODE], the following terminals and functions will not work:
HDMI OUT terminal, Ethernet/HDBaseT Port, USB Port, LAN functions, Mail Alert function
(→ page 114)

2. AUTO POWER OFF (Factory preset: 1 hour)

- When [1:00] is selected for [AUTO POWER OFF], you can enable the projector to automatically turn off in 1 hour if there is no signal received by any input or if no operation is performed.
(→ page 115)

Clearance for Installing the Projector

Allow ample clearance between the projector and its surroundings as shown below. The high temperature exhaust coming out of the device may be sucked into the device again. Avoid installing the projector in a place where air movement from the HVAC is directed at the projector. Heated air from the HVAC can be taken in by the projector's intake vent. If this happens, the temperature inside the projector will rise too high causing the over-temperature protector to automatically turn off the projectors power.

Example 1 – If there are walls on both sides of the projector.

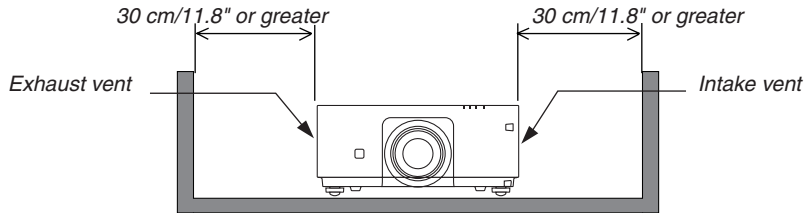

NOTE:
The drawing shows the proper clearance required for the front, back and top of the projector.

Example 2 – In the case of portrait projection.

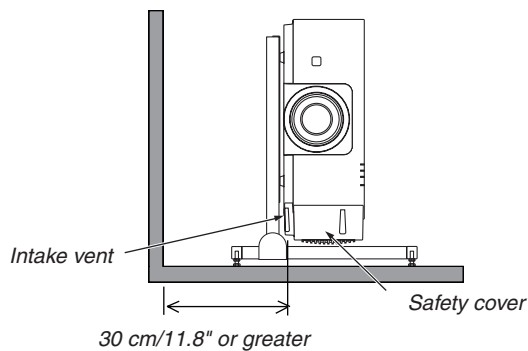

NOTE:

- The drawing shows the proper clearance required for the front, back and top of the projector.
- See page 135 for an installation example on portrait projection.

Table of Contents

Important Information	i
1. Introduction	1
① What's in the Box?	1
② Introduction to the Projector	2
Congratulations on Your Purchase of the Projector	2
General	2
Light source · Brightness	2
Installation.....	2
Videos.....	3
Network.....	3
Energy-saving	3
About this user's manual.....	4
③ Part Names of the Projector	5
Front/Top.....	5
Rear	6
Controls/Indicator Panel.....	7
Terminals Features	8
④ Part Names of the Remote Control	9
Battery Installation	10
Remote Control Precautions.....	10
Operating Range for Wireless Remote Control.....	11
Using the Remote Control in Wired Operation.....	11
2. Projecting an Image (Basic Operation)	12
① Flow of Projecting an Image.....	12
② Connecting Your Computer/Connecting the Power Cord.....	13
③ Turning on the Projector	14
Note on Startup screen (Menu Language Select screen).....	15
④ Selecting a Source	16
Selecting the computer or video source.....	16
⑤ Adjusting the Picture Size and Position	18
Adjusting the vertical position of a projected image (Lens shift).....	19
Focus	21
Zoom.....	21
Adjusting the Tilt Foot	22
⑥ Optimizing Computer Signal Automatically	23
Adjusting the Image Using Auto Adjust.....	23
⑦ Turning off the Projector	24
⑧ After Use.....	25
3. Convenient Features	26
① Turn off the light of the projector (LENS SHUTTER)	26
② Turning off the Image.....	26
③ Turning Off the On-Screen Menu (On-Screen Mute).....	26
④ Freezing a Picture	27
⑤ Magnifying a Picture	28

6	Changing LIGHT MODE/Checking Energy-Saving Effect Using LIGHT MODE [LIGHT MODE].....	29
	Checking Energy-Saving Effect [CARBON METER]	31
7	Correcting Horizontal and Vertical Keystone Distortion [CORNERSTONE]	32
8	Preventing the Unauthorized Use of the Projector [SECURITY]	35
9	Projecting 3D videos.....	38
	Procedure to watch 3D videos using this projector.....	38
	When videos cannot be viewed in 3D	41
10	Controlling the Projector by Using an HTTP Browser	42
 4. Multi-Screen Projection		48
1	Things that can be done using multi-screen projection	48
	Case 1. Using a single projector to project two types of videos [PIP/PICTURE BY PICTURE]	48
	Case 2. Using four projectors (resolution: WUXGA) to project videos with a resolution of 2560 × 1600 pixels [TILING].....	49
	Things to note when installing projectors.....	51
2	Displaying Two Pictures at the Same Time.....	52
	Projecting two screens.....	53
	Switching the main display with the sub-display and vice versa	54
	Restrictions	55
3	Displaying a Picture Using [EDGE BLENDING]	56
	Setting the overlap of projection screens.....	57
	Black Level Adjustment.....	60
 5. Using On-Screen Menu		62
1	Using the Menus.....	62
2	Menu Elements.....	63
3	List of Menu Items	64
4	Menu Descriptions & Functions [INPUT]	70
	HDMI.....	70
	DisplayPort.....	70
	BNC	70
	BNC(CV).....	70
	BNC(Y/C).....	70
	COMPUTER	70
	HDBaseT	70
	SLOT.....	70
	ENTRY LIST	70
	TEST PATTERN.....	70
5	Menu Descriptions & Functions [ADJUST].....	74
	[PICTURE]	74
	[IMAGE OPTIONS]	78
	[VIDEO].....	82
	[3D SETTINGS]	84
6	Menu Descriptions & Functions [DISPLAY].....	85
	[PIP/PICTURE BY PICTURE].....	85
	[GEOMETRIC CORRECTION].....	87
	[EDGE BLENDING]	91

[MULTI SCREEN].....	92
7 Menu Descriptions & Functions [SETUP].....	94
[MENU]	94
[INSTALLATION]	96
[CONTROL]	99
[NETWORK SETTINGS].....	107
[SOURCE OPTIONS]	112
[POWER OPTIONS]	114
Returning to Factory Default [RESET]	116
8 Menu Descriptions & Functions [INFO.]	117
[USAGE TIME]	117
[SOURCE(1)]	117
[SOURCE(2)]	118
[SOURCE(3)]	118
[SOURCE(4)]	118
[WIRED LAN].....	119
[VERSION(1)]	119
[OTHERS]	119
[HDBaseT]	120
6. Connecting to Other Equipment	121
1 Mounting a lens (sold separately).....	121
Part Names of the Lens Mount	121
Mounting the lens.....	122
Removing the lens	124
2 Making Connections.....	125
Analog RGB signal connection	125
Digital RGB signal connection	126
Connecting an External Monitor	129
Connecting Your Blu-ray Player or Other AV Equipment.....	130
Connecting Component Input	131
Connecting HDMI Input.....	132
Connecting to a Wired LAN	133
Connecting to a HDBaseT transmission device (sold commercially).....	134
Portrait projection (vertical orientation)	135
Stacking projectors	138
7. Maintenance	141
1 Cleaning the Lens.....	141
2 Cleaning the Cabinet.....	141
8. User Supportware	142
1 Operating Environment for Software Included on CD-ROM	142
Names and Features of Bundled Software Programs.....	142
Download service	142
Operating Environment.....	142
2 Installing Software Program	143
Installation for Windows software.....	143
3 Operating the Projector Via the LAN (Virtual Remote Tool).....	146
Connect the projector to a LAN.....	147

④ Controlling the Projector over a LAN (PC Control Utility Pro 4/Pro 5)	149
9. Appendix	153
① Throw distance and screen size	153
Lens types and throw distance	153
Tables of screen sizes and dimensions	155
Lens shifting range.....	156
② Mounting the Optional Board (sold separately)	157
③ Compatible Input Signal List.....	159
④ Specifications	162
⑤ Cabinet Dimensions	165
⑥ Pin assignments and signal names of main terminals	166
⑦ Troubleshooting	168
Indicator Messages.....	168
Common Problems & Solutions	170
If there is no picture, or the picture is not displayed correctly.....	172
⑧ PC Control Codes and Cable Connection	173
⑨ Troubleshooting Check List.....	174

1. Introduction

① What's in the Box?

Make sure your box contains everything listed. If any pieces are missing, contact your dealer. Please save the original box and packing materials if you ever need to ship your projector.

Projector

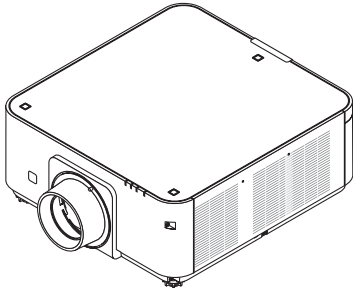

Dust cap for lens

* The projector is shipped without a lens. For the types of lens and throw distances, see page 153.

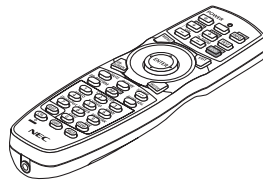

Remote control
(7N901041)

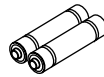

AA alkaline batteries (x2)

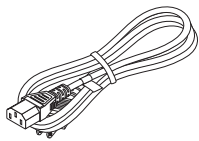

Power cord
(US: 79TG0251)
(EU: 79TG0261)



3 Stacking holders (79TG0291)

When stacking projectors (double stacking), the tilt foot of the upper projector will be placed onto these stacking holders. (→ page 139)

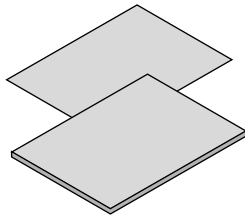

- Important Information (7N8N5111)
- Quick Setup Guide (7N8N5131)
- Security Sticker (Use this sticker when security password is set on.)

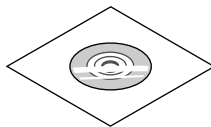

NEC Projector CD-ROM
User's manual (PDF) and the
utility software
(7N952062)

For North America only

Limited warranty

For customers in Europe:

You will find our current valid Guarantee Policy on our Web Site:

www.nec-display-solutions.com

② Introduction to the Projector

This section introduces you to your new projector and describes the features and controls.

Congratulations on Your Purchase of the Projector

This projector is one of the very best projectors available today. The projector enables you to project precise images up to 500 inches across (measured diagonally) from your PC or Mac computer (desktop or notebook), VCR, Blu-ray player, or document camera.

You can use the projector on a tabletop or cart, you can use the projector to project images from behind the screen, and the projector can be permanently mounted on a ceiling*¹. The remote control can be used wirelessly.

*¹ Do not attempt to mount the projector on a ceiling yourself.

The projector must be installed by qualified technicians in order to ensure proper operation and reduce the risk of bodily injury.

In addition, the ceiling must be strong enough to support the projector and the installation must be in accordance with any local building codes. Please consult your dealer for more information.

General

- **Single-chip DLP projector with high resolution and high brightness**

Model name	DMD panel	Resolution	Aspect ratio
PX602UL-WH/PX602UL-BK	0.67 type	1,920 × 1,200 pixels	16:10
PX602WL-WH/PX602WL-BK	0.65 type	1,280 × 800 pixels	16:10

Light source • Brightness

- **A long-life laser diode is equipped in the light module**

The product can be operated at low cost because the laser light source can be used for a long time without requiring replacement or maintenance.

- **Brightness can be adjusted within a wide range**

Unlike with ordinary light sources, the brightness can be adjusted from 20 to 100% in 1% increments.

- **[CONSTANT BRIGHTNESS] mode**

Brightness normally decreases with use, but by selecting [CONSTANT BRIGHTNESS] mode, sensors inside the projector detect and automatically adjust the output, thereby maintaining constant brightness throughout the life of the light module.

However, if brightness output is set at the maximum, brightness will decrease with use.

Installation

- **Wide range of optional lenses selectable according to the place of installation**

This projector supports 4 types, however PX602UL-WH and PX602UL-BK support 3 types of optional lenses, providing a selection of lenses adapted to a variety of places of installation and projection methods.

In addition, the lenses can be mounted and removed in one touch.

Note that no lens is mounted upon shipment from the factory. Please purchase optional lenses separately.

- **Tilt-free, portrait projection**

This projector can be set to any angle within a vertical 360° range.

It can also rotate the picture 90° into portrait orientation.

This projector cannot be installed with right or left slant besides the portrait projection.

- **Double stackable for high light output projection**

By stacking 2 projectors, increased brightness on a large screen is possible.

- **Power lens control for quick and easy adjustment**

By using buttons on the projector or the remote control, zoom, focus, and position (lens shift) can be adjusted.

Videos

- **Wide range of input/output terminals (HDMI, DisplayPort, BNC, HDBaseT, etc.) and built-in monaural speaker**

The projector is equipped with a variety of input/output terminals: HDMI, DisplayPort, BNC (5-core), computer (analog), HDBaseT, etc.

The projector's HDMI input/output terminals and DisplayPort input terminal support HDCP.

HDBaseT, promoted and advanced by the HDBaseT Alliance, is a consumer electronic (CE) and commercial connectivity technology.

- **Slot for optional board**

This projector has a slot for optional boards (sold separately).

- **Simultaneous display of 2 images (PIP/PICTURE BY PICTURE)**

Two images can be projected simultaneously with a single projector.

There are two types of layouts for the two images: "picture-in-picture" (PIP) in which a sub-picture is displayed on the main picture, and "picture-by-picture" (PICTURE BY PICTURE) in which the main and sub pictures are displayed next to each other.

- **Multi-screen projection using multiple projectors**

This projector is equipped with multiple HDMI input & output terminals that can connect multiple projectors in a daisy chain. A high quality picture is achieved by dividing and projecting high resolution videos among the various projectors.

Furthermore, the boundaries of the screens are smoothed using an edge blending function.

- **Supports HDMI 3D format**

This projector can be used to watch videos in 3D using commercially-available active shutter-type 3D eyewear and 3D emitters that support Xpand 3D.

Network

- **Convenient utility software (User Supportware) provided as standard**

The three utility software stored in the enclosed NEC Projector CD-ROM (Virtual Remote Tool, PC Control Utility Pro 4 (for Windows) and PC Control Utility Pro 5 (for Mac OS)) can be used.

- **CRESTRON ROOMVIEW compatible**

This projector supports CRESTRON ROOMVIEW, allowing multiple devices connected to the network to be managed from a computer or controller.

Energy-saving

- **Energy-saving design with a standby power consumption of 0.5 watts**

When the on-screen menu's standby mode is set to "NORMAL", the power consumption in the standby mode is 0.5 watts.

- **"LIGHT MODE" for low power consumption and "Carbon Meter" display**

The projector is equipped with an "LIGHT MODE" for reducing power consumption during use. Furthermore, the power-saving effect when the LIGHT MODE is set is converted into the amount of reductions of CO₂ emissions and this is indicated on the confirmation message displayed when the power is turned off and at "Information" on the on-screen menu (CARBON METER).

About this user's manual

The fastest way to get started is to take your time and do everything right the first time. Take a few minutes now to review the user's manual. This may save you time later on. At the beginning of each section of the manual you'll find an overview. If the section doesn't apply, you can skip it.

3 Part Names of the Projector

Front/Top

The lens is sold separately. The description below is for when the NP35ZL lens is mounted.

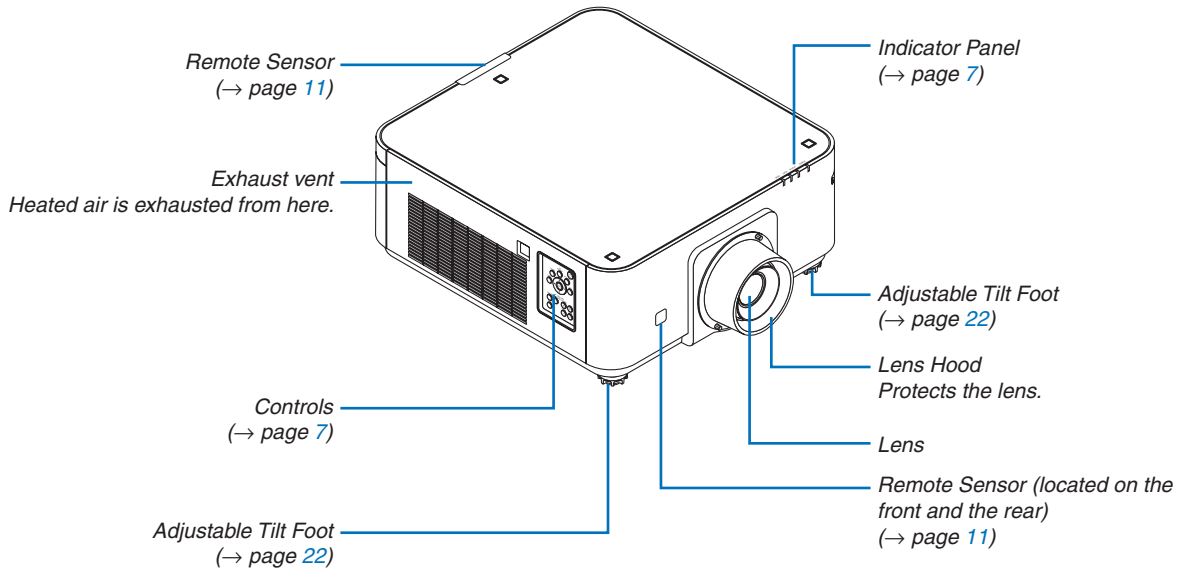

Rear

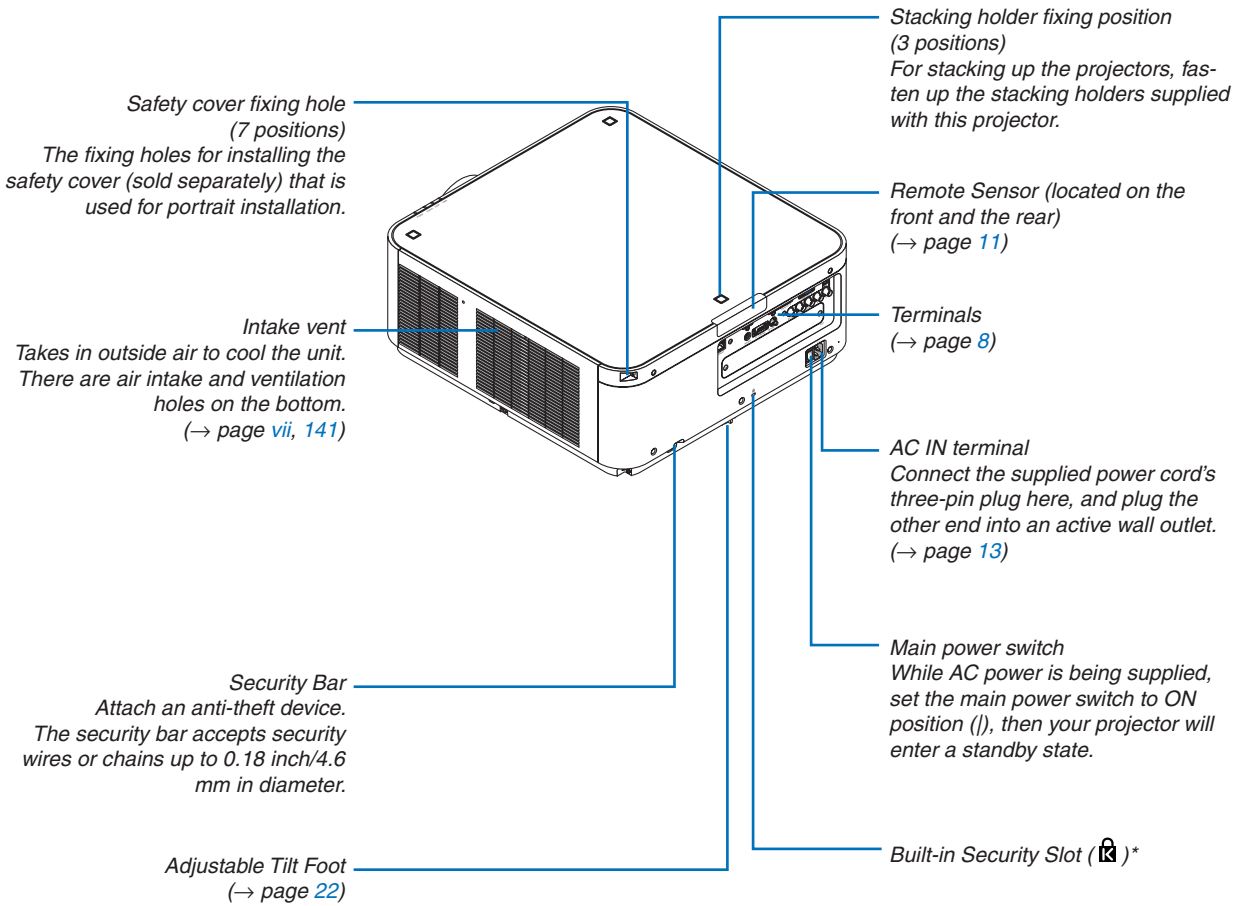

* This security slot supports the MicroSaver® Security System.

Controls/Indicator Panel

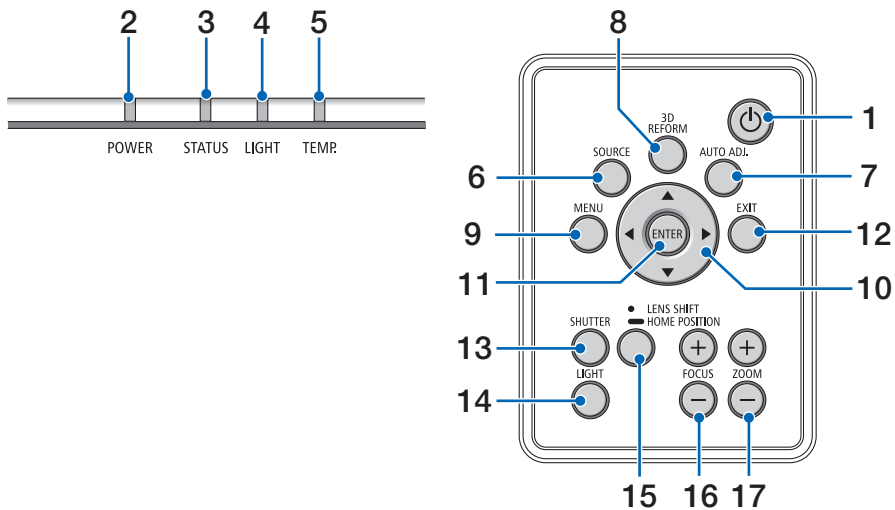
1.  (POWER) Button

(→ page 14, 24)

2. POWER Indicator

(→ page 14, 15, 24, 168)

3. STATUS Indicator

(→ page 168)

4. LIGHT Indicator

(→ page 29, 169)

5. TEMP. Indicator

(→ page 169)

6. SOURCE Button

(→ page 16)

7. AUTO ADJ. Button

(→ page 23)

8. 3D REFORM Button

(→ page 32)

9. MENU Button

(→ page 62)

10.  Buttons

(→ page 62)

11. ENTER Button

(→ page 62)

12. EXIT Button

(→ page 62)

13. SHUTTER Button

(→ page 26)

14. LIGHT Button

(→ page 29)

15. LENS SHIFT/HOME POSITION Button

(→ page 19, 26, 124, 156)

16. FOCUS +/- Button

(→ page 21)

17. ZOOM +/- Button

(→ page 21)

Terminals Features

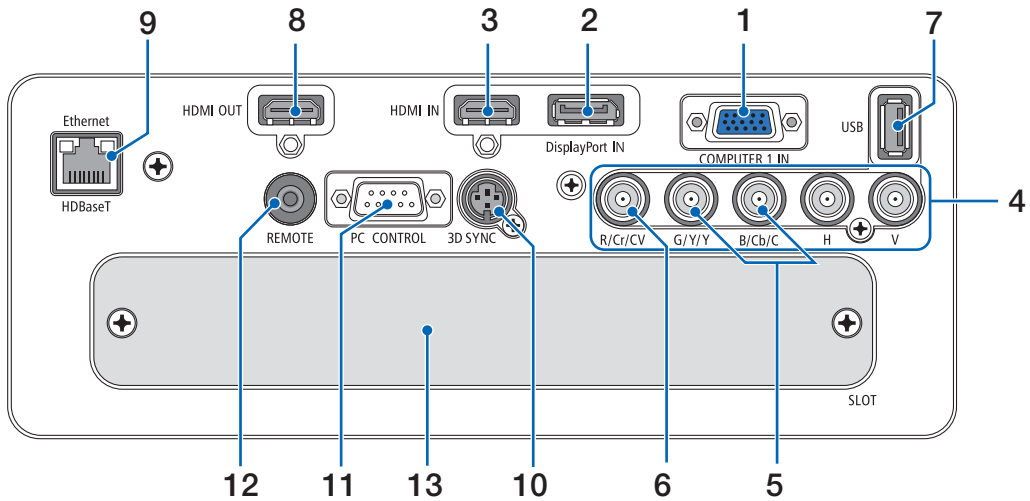

1. **COMPUTER 1 IN/ Component Input Terminal (Mini D-Sub 15 Pin)**
(→ page 13, 125, 131, 166)
2. **DisplayPort IN Terminal (DisplayPort 20 Pin)**
(→ page 126, 166)
3. **HDMI IN Terminal (Type A)**
(→ page 126, 128, 132, 166)
4. **BNC Input [R/Cr/CV, G/Y/Y, B/Cb/C, H, V] Terminals (BNC × 5)**
(→ page 125, 130)
5. **BNC (Y/C) Input Terminal (BNC × 2)**
(→ page 130)
6. **BNC (CV) Input Terminal (BNC × 1)**
(→ page 130)
7. **USB Port (Type A)**
(→ page 167)
(For future expansion. This port allows for power supply.)
8. **HDMI OUT Terminal (Type A)**
(→ page 129)
9. **Ethernet/HDBaseT Port (RJ-45)**
(→ page 133, 134, 167)
10. **3D SYNC Terminal (Mini DIN 4 Pin)**
(→ page 40)
11. **PC CONTROL Port (D-Sub 9 Pin)**
(→ page 167, 173)
Use this port to connect a PC or control system. This enables you to control the projector using serial communication protocol. If you are writing your own program, typical PC control codes are on page 173.

12. **REMOTE Terminal (Stereo Mini)**
Use this jack for wired remote control of the projector using a commercially available remote cable with Ø3.5 stereo mini-plug (without resistance). Connect the projector and the supplied remote control using a commercially available wired remote control cable.
(→ page 11)

NOTE:

- When a remote control cable is connected to the REMOTE terminal, infrared remote control operations cannot be performed.
- Power cannot be supplied from the REMOTE terminal to the remote control.
- When [HDBaseT] is selected in the [REMOTE SENSOR] and the projector is connected to a commercially-available transmission device that supports HDBaseT, remote control operations in infra-red cannot be carried out if transmission of remote control signals has been set up in the transmission device. However, remote control using infrared rays can be carried out when the power supply of the transmission device is switched off.

13. **SLOT**
(→ page 157)

4 Part Names of the Remote Control

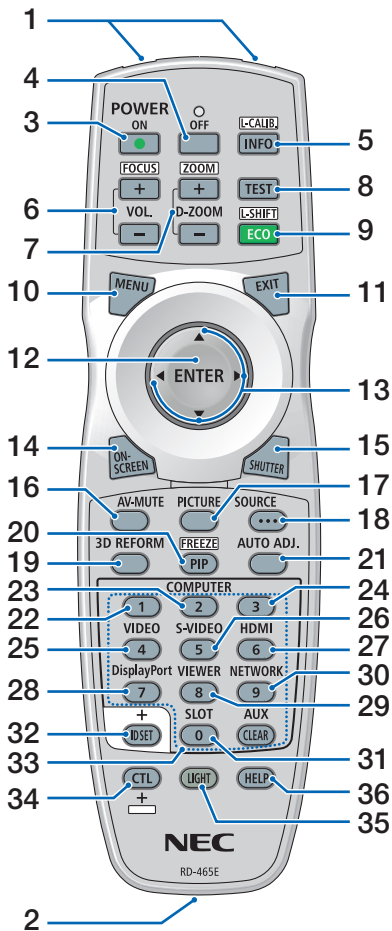

1. **Infrared Transmitter**
(→ page 11)
2. **Remote Jack**
Connect a commercially available remote cable here for wired operation. (→ page 11)
3. **POWER ON Button**
(→ page 14)
4. **POWER OFF Button**
(→ page 24)
5. **INFO/L-CALIB. Button**
Display the [SOURCE(1)] screen of the on-screen menu.
(→ page 117)
6. **VOL./FOCUS +/- Buttons**
(→ page 21)
7. **D-ZOOM/ZOOM +/- Buttons**
(→ page 28)
8. **TEST Button**
(→ page 70)
9. **ECO/L-SHIFT Button**
(→ page 20, 29)
10. **MENU Button**
(→ page 62)
11. **EXIT Button**
(→ page 62)
12. **ENTER Button**
(→ page 62)
13. **▲▼◀▶ Button**
(→ page 62)
14. **ON-SCREEN Button**
(→ page 26)
15. **SHUTTER Button**
(→ page 26)
16. **AV-MUTE Button**
(→ page 26)
17. **PICTURE Button**
(→ page 74, 76)
18. **SOURCE Button**
(→ page 16)
19. **3D REFORM Button**
(→ page 32)
20. **PIP/FREEZE Button**
(→ page 27, 53)
21. **AUTO ADJ. Button**
(→ page 23)
- 22, 23, 24. **COMPUTER 1/2/3 Button**
(→ page 16)
25. **VIDEO Button**
(→ page 16)
26. **S-VIDEO Button**
(→ page 16)
27. **HDMI Button**
(→ page 16)
28. **DisplayPort Button**
(→ page 16)
29. **VIEWER Button**
(The VIEWER button will not work on this series of projectors.)
30. **NETWORK Button**
(→ page 16)
31. **SLOT Button**
(→ page 158)
32. **ID SET Button**
(→ page 105)
33. **Numeric (0 to 9/CLEAR) Buttons**
(→ page 105)
(The AUX button will not work on this series of projectors.)
34. **CTL Button**
This button is used in conjunction with other buttons, similar to a CTRL key on a computer.
35. **LIGHT Button**
This button is used to turn on the backlight for the remote control buttons.
The backlight will turn off if no button operation is made for 10 seconds.
36. **HELP Button**
(→ page 117)

Battery Installation

1. Press the catch and remove the battery cover.
2. Install new ones (AA). Ensure that you have the batteries' polarity (+/-) aligned correctly.
3. Slip the cover back over the batteries until it snaps into place.

NOTE: Do not mix different types of batteries or new and old batteries.

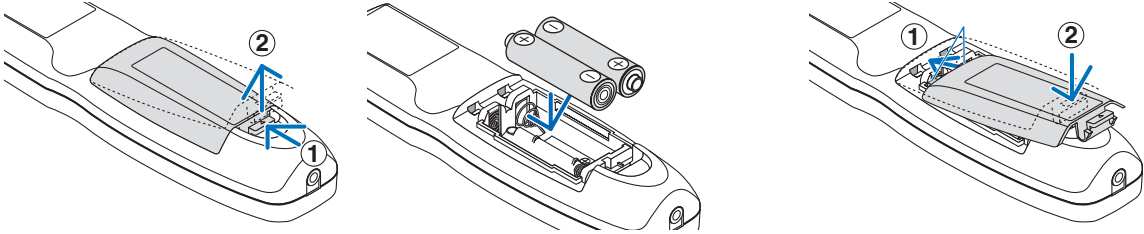

Remote Control Precautions

- Handle the remote control carefully.
- If the remote control gets wet, wipe it dry immediately.
- Avoid excessive heat and humidity.
- Do not short, heat, or take apart batteries.
- Do not throw batteries into fire.
- If you will not be using the remote control for a long time, remove the batteries.
- Ensure that you have the batteries' polarity (+/-) aligned correctly.
- Do not use new and old batteries together, or use different types of batteries together.
- Dispose of used batteries according to your local regulations.

Operating Range for Wireless Remote Control

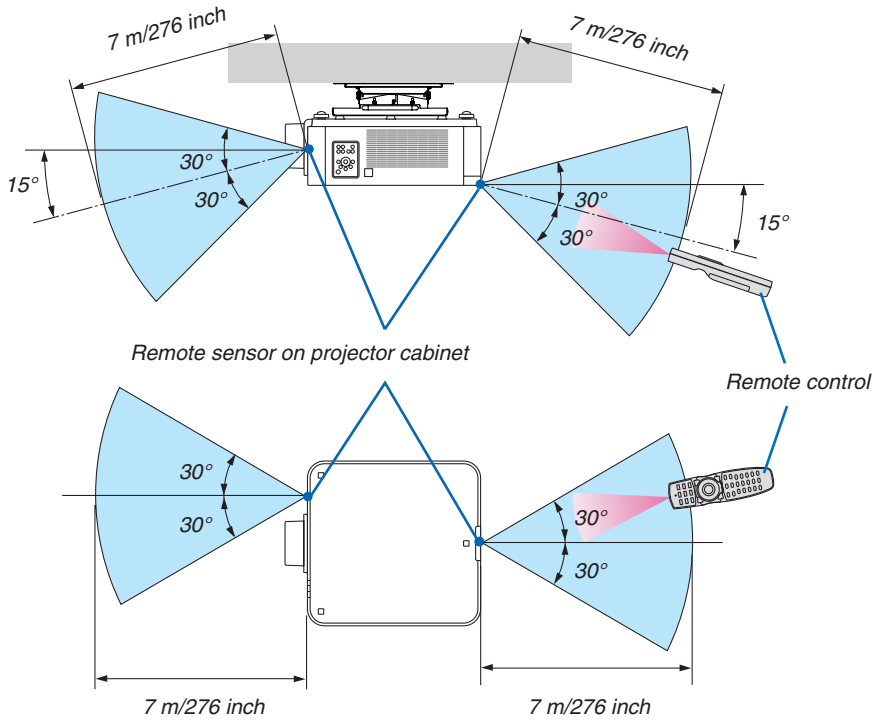

- The infrared signal operates by line-of-sight up to a distance of above meters and within a 60-degree angle of the remote sensor on the projector cabinet.
- The projector will not respond if there are objects between the remote control and the sensor, or if strong light falls on the sensor. Weak batteries will also prevent the remote control from properly operating the projector.

Using the Remote Control in Wired Operation

Connect one end of the remote cable to the REMOTE terminal and the other end to the remote jack on the remote control.

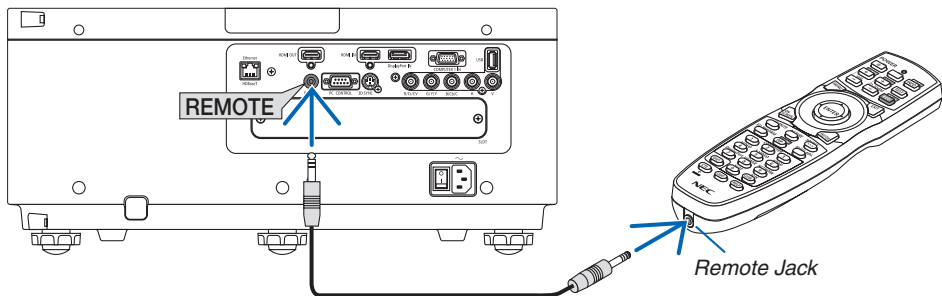

NOTE:

- When a remote cable is inserted into the REMOTE terminal, the remote control does not work for infrared wireless communication.
- Power will not be supplied to the remote control by the projector via the REMOTE jack. Battery is needed when the remote control is used in wired operation.

2. Projecting an Image (Basic Operation)

This section describes how to turn on the projector and to project a picture onto the screen.

① Flow of Projecting an Image

Step 1

- *Connecting your computer / Connecting the power cord* (→ [page 13](#))



Step 2

- *Turning on the projector* (→ [page 14](#))



Step 3

- *Selecting a source* (→ [page 16](#))



Step 4

- *Adjusting the picture size and position* (→ [page 18](#))
- *Correcting keystone distortion [CORNERSTONE]* (→ [page 32](#))



Step 5

- *Adjusting a picture*
 - *Optimizing a computer signal automatically* (→ [page 23](#))



Step 6

- *Making a presentation*



Step 7

- *Turning off the projector* (→ [page 24](#))



Step 8

- *After use* (→ [page 25](#))

② Connecting Your Computer/Connecting the Power Cord

1. Connect your computer to the projector.

This section will show you a basic connection to a computer. For information about other connections, see “(2) Making Connections” on page 125.

Connect the display output terminal (mini D-sub 15 pin) on the computer to the COMPUTER 1 IN terminal on the projector with a commercially-available computer cable (with ferrite core) and then turn the knobs of the terminals to secure them.

2. Connect the supplied power cord to the projector.

First connect the supplied power cord's three-pin plug to the AC IN terminal of the projector, and then connect the other plug of the supplied power cord in the wall outlet.

Important Information:

- When plugging in or unplugging the supplied power cord, make sure that the main power switch is pushed to the off [O] position. Failure to do so may cause damage to the projector.

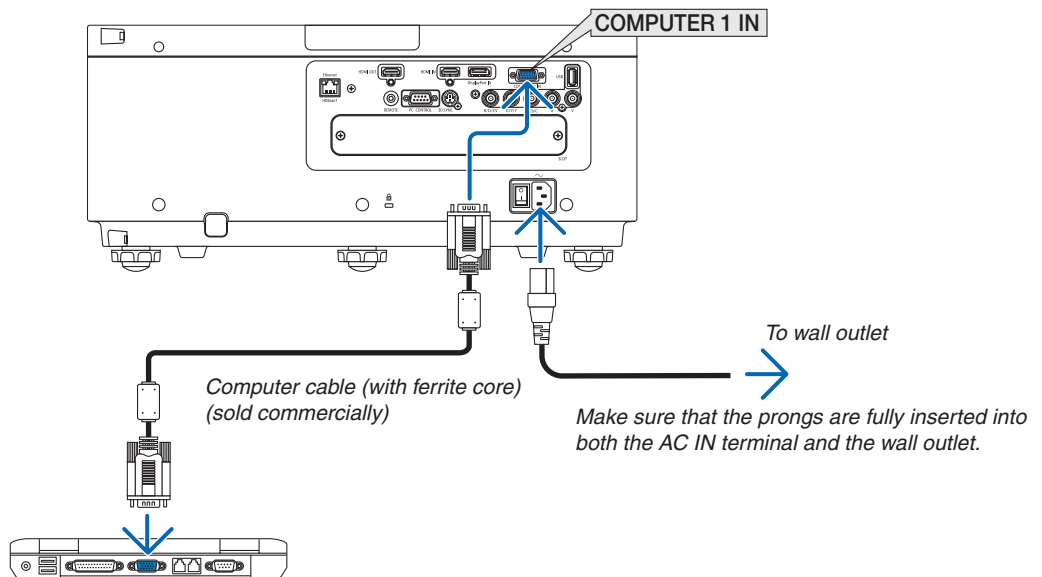

⚠ CAUTION:

Parts of the projector may become temporarily heated if the projector is turned off with the POWER button or if the AC power supply is disconnected during normal projector operation. Use caution when picking up the projector.

3 Turning on the Projector

NOTE:

- The projector has two power switches: A main power switch and a POWER button (POWER ON and OFF on the remote control)

• **Turning on the projector:**

1. **Press the main power switch to the ON position (I).**

The projector will go into standby mode.

2. **Press the POWER button .**

The projector will become ready to use.

• **Turning off the projector:**

1. **Press the POWER button.**

The confirmation message will be displayed.

2. **Press the POWER button again.**

The projector will go into standby mode.

3. **Press the main power switch to the OFF position (O).**

The projector will be turned off.

1. **Press the main power switch to the ON position (I).**

The POWER indicator lights up red.*

* This indicates that the STANDBY mode is in [NORMAL] setting.

(→ page 114, 168)

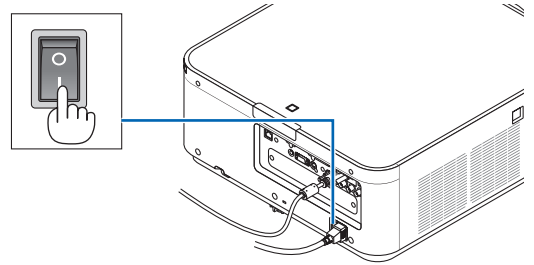

WARNING

The projector produces a strong light. When turning on the power, make sure no one within projection range is looking at the lens.

NOTE:

- The [STANDBY MODE] setting will be disabled and the projector will go into the sleep mode when the network service is utilized or the projector receives HDBaseT signal. In the sleep mode, the fans in the projector rotate for the purpose of interior parts protection. Please refer to page 114 about the sleep mode.

2. **Press the  (POWER) button on the projector cabinet or the POWER ON button on the remote control.**

The POWER indicator goes from a steady red light to a flashing blue light, and the picture is projected on the screen.

TIP:

- When the message “PROJECTOR IS LOCKED! ENTER YOUR PASSWORD.” is displayed, it means that the [SECURITY] feature is turned on. (→ page 35)

After you turn on your projector, ensure that the computer or video source is turned on.

NOTE: The blue screen ([BLUE] background) is displayed when no signal is being input (by factory default menu settings).

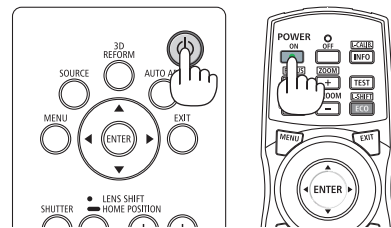

Standby

Blinking

Power On

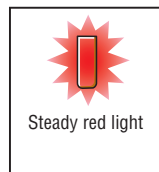

(→ page 168)

2. Projecting an Image (Basic Operation)

Note on Startup screen (Menu Language Select screen)

When you first turn on the projector, you will get the Startup menu. This menu gives you the opportunity to select one of the 29 menu languages.

To select a menu language, follow these steps:

1. Use the ▲, ▼, ◀ or ▶ button to select one of the 29 languages from the menu.

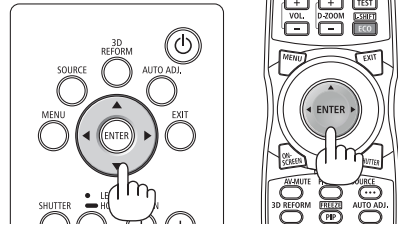

2. Press the ENTER button to execute the selection.

After this has been done, you can proceed to the menu operation.

If you want, you can select the menu language later.
(→ [LANGUAGE] on page 66 and 94)

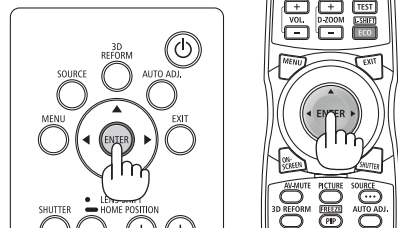

NOTE:

- If one of the following things happens, the projector will not turn on.
 - If the internal temperature of the projector is too high, the projector detects abnormal high temperature. In this condition the projector will not turn on to protect the internal system. If this happens, wait for the projector's internal components to cool down.
 - If the STATUS indicator lights orange with the power button pressed, it means that the [CONTROL PANEL LOCK] is turned on. Cancel the lock by turning it off. (→ page 104)
- While the POWER indicator is blinking blue in short cycles, the power cannot be turned off by using the power button. (While the POWER indicator is blinking blue in long cycles, the OFF TIMER is functioned and the power can be turned off.)

4 Selecting a Source

Selecting the computer or video source

NOTE: Turn on the computer or video source equipment connected to the projector.

Detecting the Signal Automatically

Press the SOURCE button for 1 second or longer. The projector will search for the available input source and display it. The input source will change as follows:

HDMI → DisplayPort → BNC → BNC(CV) → BNC(Y/C) → COMPUTER → HDBaseT → SLOT → ...

- Press it briefly to display the [INPUT] screen.

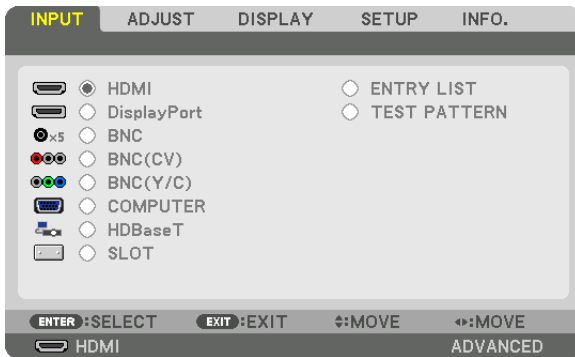

Press the ▼/▲ buttons to match the target input terminal and then press the ENTER button to switch the input. To delete the menu display in the [INPUT] screen, press the MENU or EXIT button.

TIP: If no input signal is present, the input will be skipped.

Using the Remote Control

Press any one of the HDMI, DisplayPort, COMPUTER 2, VIDEO, S-VIDEO, COMPUTER 1, NETWORK, or SLOT buttons.

- COMPUTER 2 button selects the BNC input terminal.
- VIDEO button selects the BNC (CV) input terminal (Composite Video).
- S-VIDEO button selects the BNC (Y/C) input terminal (S-Video).

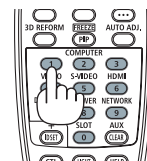
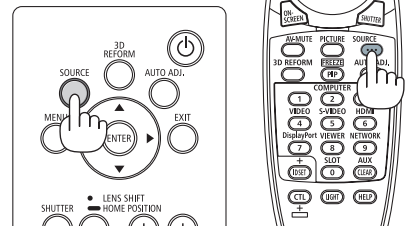

Selecting Default Source

You can set a source as the default source so that it will be displayed each time the projector is turned on.

1. Press the MENU button.

The menu will be displayed.

2. Press the ► button to select [SETUP] and press the ▼ button or the ENTER button to select [BASIC].

3. Press the ► button to select [SOURCE OPTIONS].

4. Press the ▼ button four times to select [DEFAULT INPUT SELECT] and press the ENTER button.

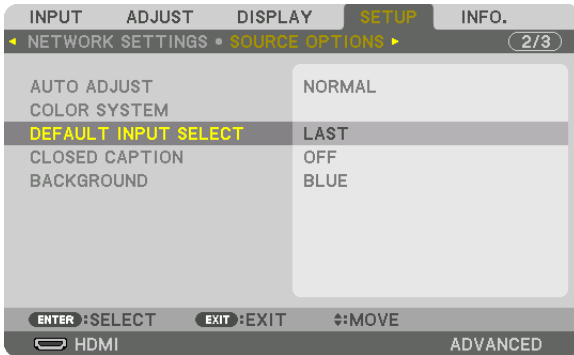

The [DEFAULT INPUT SELECT] screen will be displayed.

(→ page 112)

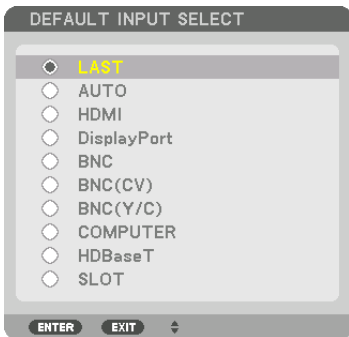

5. Select a source as the default source, and press the ENTER button.

6. Press the EXIT button three times to close the menu.

7. Restart the projector.

The source you selected in step 5 will be projected.

NOTE: Even when [AUTO] is turned on, the [HDBaseT] will not be automatically selected. To set your network as the default source, select [HDBaseT].

TIP:

- When the projector is in Standby mode, applying a computer signal from a computer connected to the COMPUTER 1 IN input will power on the projector and simultaneously project the computer's image.
([AUTO POWER ON SELECT] → page 115)
- On the Windows 7 keyboard, a combination of the Windows and P keys allows you to set up external display easily and quickly.

5 Adjusting the Picture Size and Position

Use the lens shift dial, the adjustable tilt foot lever, the zoom lever/zoom ring and the focus ring to adjust the picture size and position.

In this chapter drawings and cables are omitted for clarity.

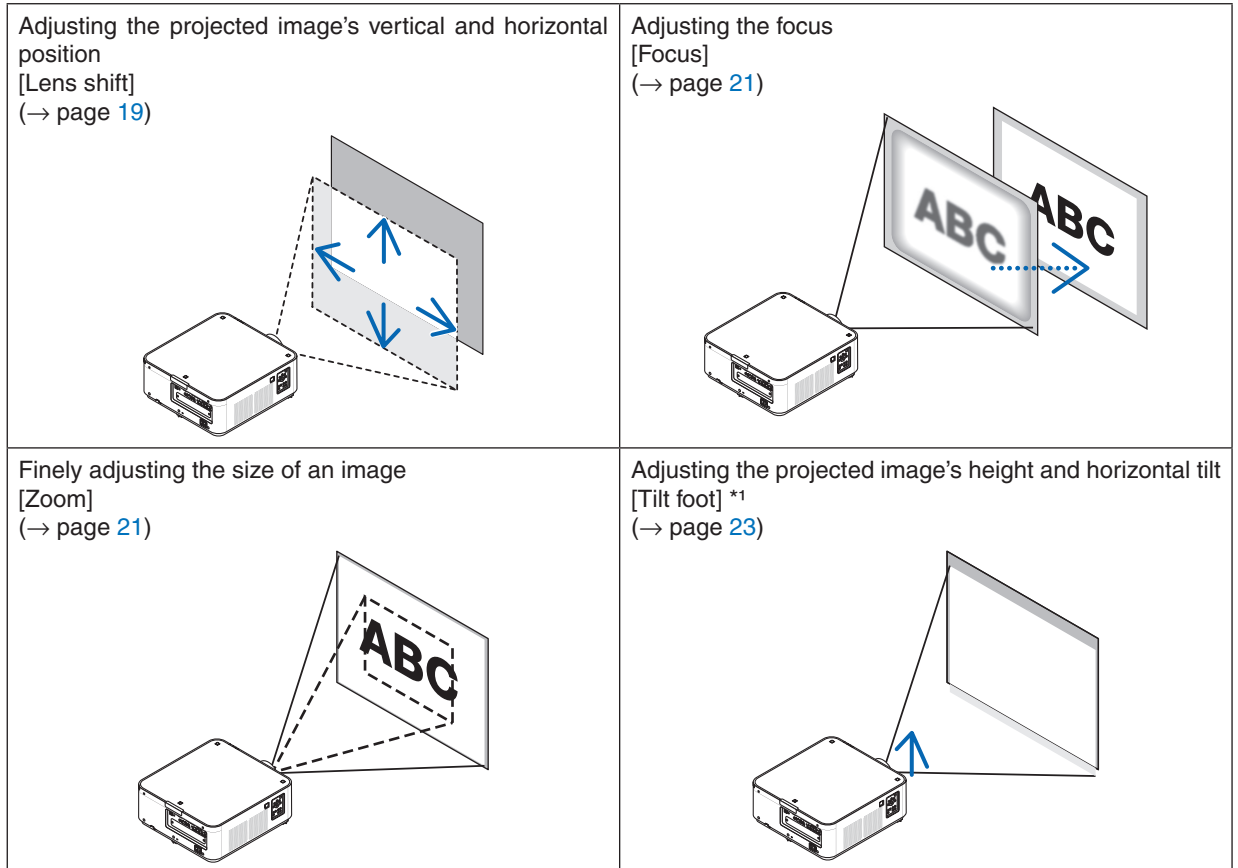

*NOTE*1: Adjust the projected image's height using the tilt feet when you want to project the image at a position higher than the lens shift adjustment range.*

Adjusting the vertical position of a projected image (Lens shift)

CAUTION

- Perform the adjustment from behind or from the side of the projector. Performing adjustment from the front could expose your eyes to strong light which could injure them.
- Keep hands away from the lens hood while the lens shift is in operation. Failure to do so could result in fingers being pinched between the lens and the lens hood.

Adjusting with buttons on the cabinet

1. Press the **LENS SHIFT/HOME POSITION** button.

The [LENS SHIFT] screen will be displayed.

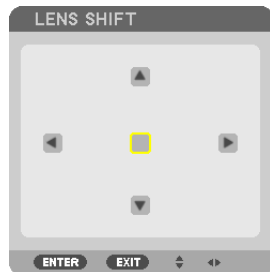

2. Press the **▼▲◀▶** or **▶** button.

Use the **▼▲◀▶** buttons to move the projected image.

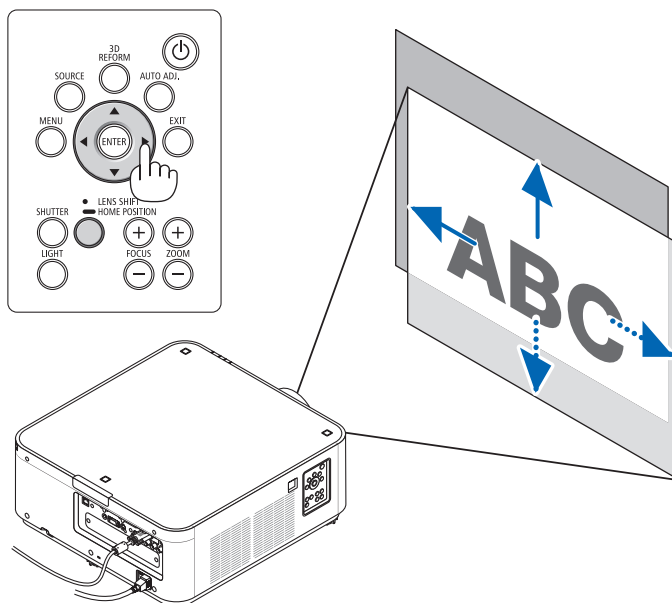

- *Returning the lens shift position to the home position*

Press and hold the LENS SHIFT/HOME POSITION button for 2 seconds to return the lens shift position to the home position (nearly center position)

2. Projecting an Image (Basic Operation)

Adjusting with the remote control

1. Hold the CTL button and press the ECO/L-SHIFT button.

The [LENS SHIFT] screen will be displayed.

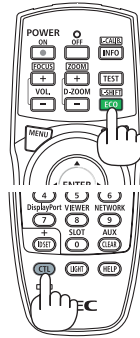
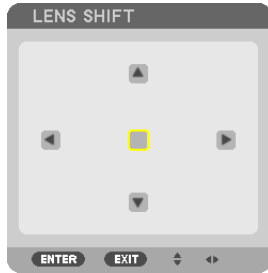

2. Press the ▼▲◀ or ▶ button.

Use the ▼▲◀▶ buttons to move the projected image.

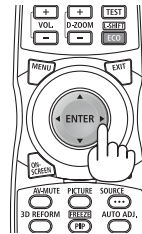

NOTE:

Lens Calibration

If the power of the projector is wrongly shut down during the motion of lens shift, it may shift the home position of the lens and may cause of malfunction. In this case, perform lens calibration.

Lens calibration procedures

1. Power on the projector.
2. Press and hold the (CTL) button and press the (INFO/L-CALIB.) button on the remote control.
Calibration is performed.

TIP:

- The diagram below shows the lens shift adjustment range for the PX602UL-WH and PX602UL-BK (projection mode: desktop front). To raise the projection position higher than this, use the tilt feet. (→ page 22)
- For the PX602WL-WH/PX602WL-BK and the ceiling mount/front projection lens shift adjustment range, see page 156.

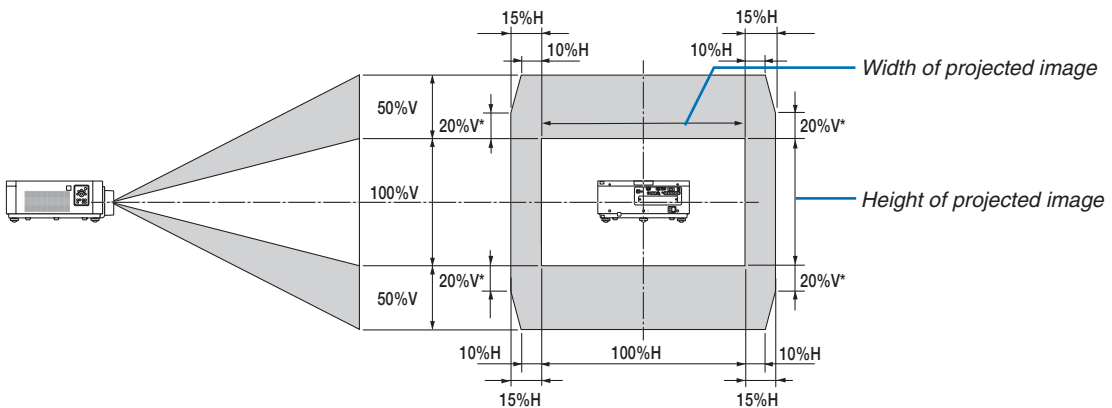

* 30%V for the PX602WL-WH/PX602WL-BK.

Description of symbols: V indicates vertical (height of the projected image), H indicates horizontal (width of the projected image).

2. Projecting an Image (Basic Operation)

Focus

1. Press the FOCUS +/- button.

- On the remote control, while pressing on the CTL button, press on VOL/FOCUS (+) or (-) button.
The focus is adjusted.

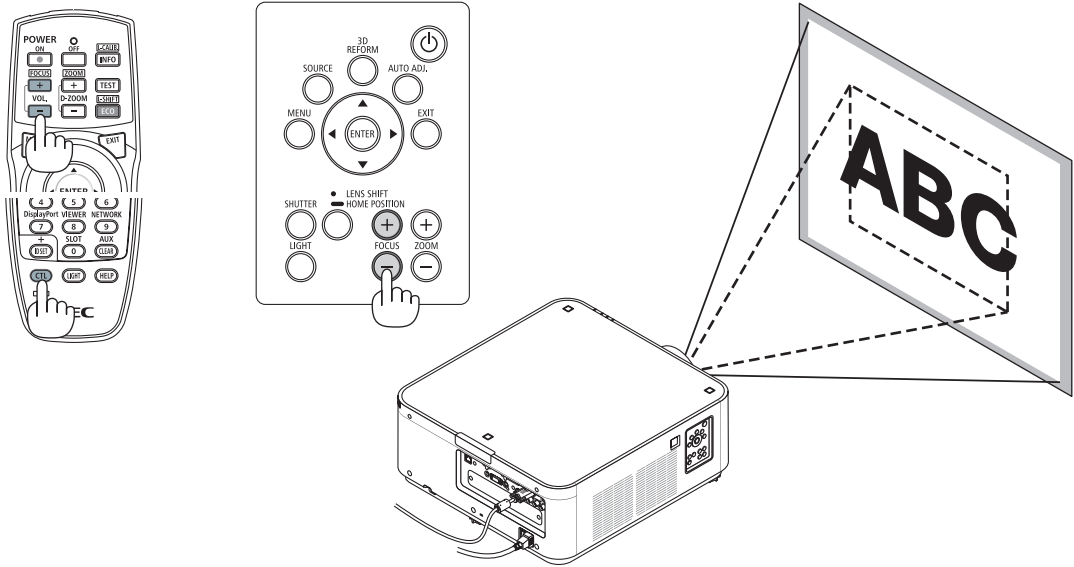

Zoom

1. Press the ZOOM +/- button.

- On the remote control, while pressing on the CTL button, press the D-ZOOM/ZOOM (+) or (-) button.
The zoom is adjusted.

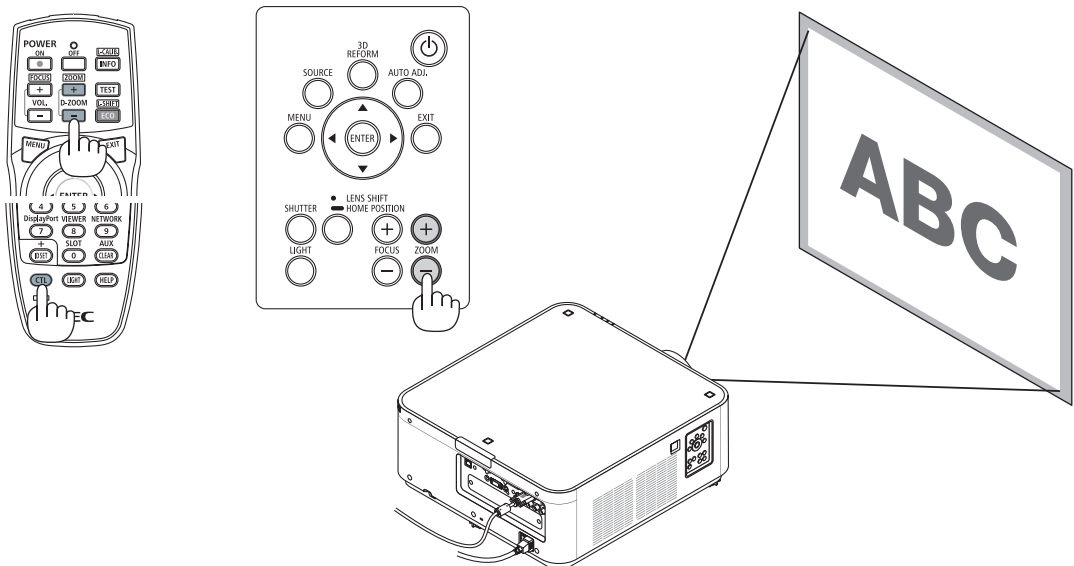

2. Projecting an Image (Basic Operation)

Adjusting the Tilt Foot

1. The position to project image may be adjusted by the tilt feet positioned at right, left and rear of the cabinet bottom.

The tilt foot height can be adjusted by its turn.

“To adjust the height of the projected image”

The height of the projected image is adjusted by turning the left and right tilt feet.

“If the projected image is tilted”

If the projected image is tilted, turn one of the tilt feet to adjust the image so that it is level.

“To adjust the projector so that it is perpendicular to the screen”

Turn the rear tilt foot to adjust its height.

- If the projected image is distorted, see “3-7 Correcting Horizontal and Vertical Keystone Distortion [CORNERSTONE]” (→ page 32) and “[GEOMETRIC CORRECTION]” (→ page 100).
- The tilt foot can be lengthened by a maximum of 48 mm.
- The tilt foot can be used to tilt the projector by a maximum of 6°.

NOTE:

- Do not lengthen the tilt foot any more than 50 mm/1.9". Doing so will make the tilt feet's mount section unstable and could cause the tilt feet to come off the projector.
- Do not use the tilt foot for any purpose other than adjusting the projector's projection angle.
Handling the tilt foot improperly, such as carrying the projector by grasping the tilt foot or hooking it onto a wall using the tilt foot, could damage the projector.

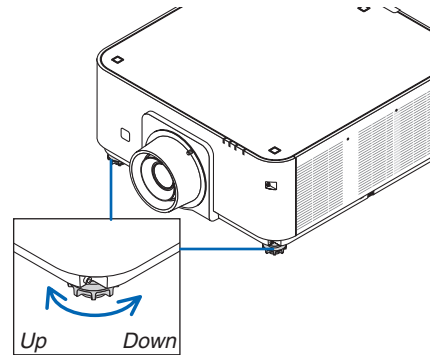
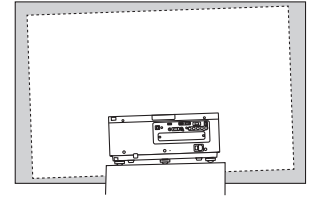

Tilt foot
(there is one more in the rear)

⑥ Optimizing Computer Signal Automatically

Adjusting the Image Using Auto Adjust

When an image from HDMI IN, DisplayPort IN, BNC input terminal (analog RGB), COMPUTER 1 IN, or HDBaseT is being projected, and the edge is cut off or the image quality is poor, this button can be used to automatically optimize the projection image on the screen.

Press the AUTO ADJ. button to optimize a computer image automatically. This adjustment may be necessary when you connect your computer for the first time.

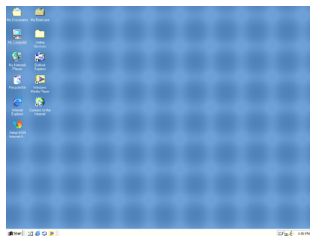
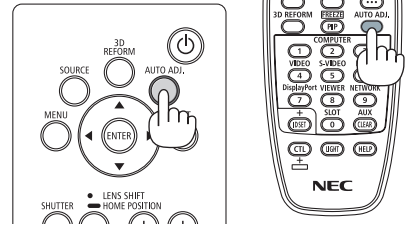

[Poor picture]

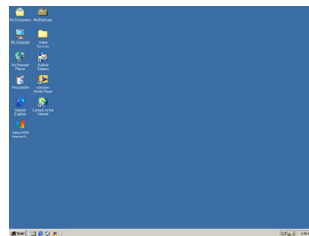

[Normal picture]

NOTE:

Some signals may take time to display or may not be displayed correctly.

- If the Auto Adjust operation cannot optimize the computer signal, try to adjust [HORIZONTAL], [VERTICAL], [CLOCK], and [PHASE] manually. (→ page 78, 79)

7 Turning off the Projector

To turn off the projector:

1. First, press the  (POWER) button on the projector cabinet or the POWER OFF button on the remote control.

The [POWER OFF / ARE YOU SURE ? / CARBON SAVINGS- SESSION 0.000[g-CO2]] message will appear.

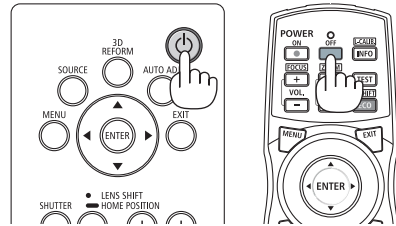
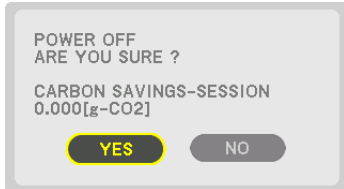

2. Secondly, press the ENTER button or press the  (POWER) or the POWER OFF button again.

When the projector is in STANDBY MODE, the POWER indicator lights up red. (When [STANDBY MODE] is in [NORMAL] setting)

3. Make sure the projector is in STANDBY MODE, then turn off the main power switch (○ OFF)

The POWER indicator will go off and the main power will turn off.

- While the POWER indicator is blinking blue in short cycles, the power cannot be turned off.

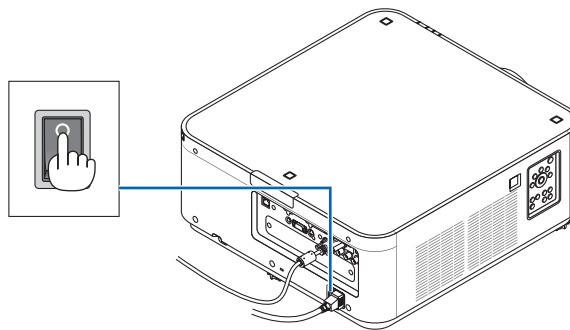
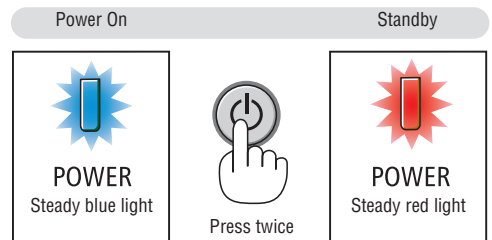

CAUTION:

Parts of the projector may temporarily overheat if the projector is turned off with the main power switch or the AC power supply is disconnected while the projector is in operation or the cooling fan is running. Handle with care.

NOTE:

- *Do not unplug the power cord from the projector or from the power outlet while an image is being projected. Doing so could deteriorate the projector's AC IN terminal or the power plug's contact. To turn off the AC power supply when the projector is powered on, use the projector's main power switch, a power strip equipped with a switch, or a breaker.*
 - *Do not turn off the main power switch or disconnect the AC power supply within 10 seconds of making adjustments or setting changes and closing the menu. Doing so can cause loss of adjustments and settings.*
-

⑧ After Use

Preparation: Make sure that the projector is turned off.

- 1. Unplug the power cord.**
- 2. Disconnect any other cables.**
- 3. Mount the lens cap on the lens.**
- 4. Before moving the projector, screw in the tilt feet if they have been lengthened.**

3. Convenient Features

1 Turn off the light of the projector (LENS SHUTTER)

Press the SHUTTER button.

The light source will turn off and the light of the projector will temporarily go dark.

Press again to allow the screen to become illuminated again.

- Another way to shut the light source off is to press the SHUTTER button on the remote control.

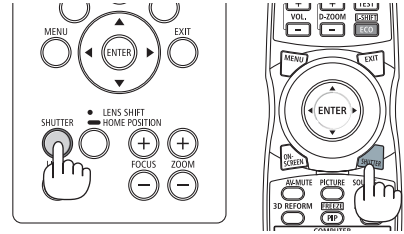

2 Turning off the Image

Press the AV-MUTE button to turn off the image for a short period of time.

Press again to restore the image.

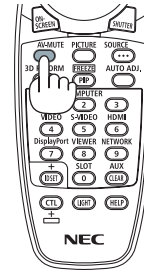

TIP:

- The video will disappear but not the menu display.

3 Turning Off the On-Screen Menu (On-Screen Mute)

A press of the ON-SCREEN button on the remote control will hide the on-screen menu, the source display and other messages. Press again to restore them.

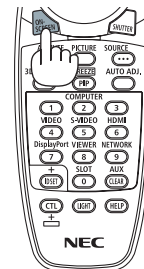

TIP:

- To confirm that the on-screen mute is turned on, press the MENU button. If the on-screen menu is not displayed even though you press the MENU button, it means the on-screen mute is turned on.
- The on-screen mute is maintained even when the projector is turned off,
- Holding down the MENU button for at least 10 seconds will turn off the on-screen mute.

4 Freezing a Picture

Hold the CTL button and press the PIP/FREEZE button to freeze a picture.
Press again to resume motion.

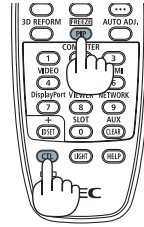

NOTE: The image is frozen but the original video is still playing ahead.

5 Magnifying a Picture

You can magnify the picture up to four times.

NOTE:

- Depending on an input signal, the maximum magnification may be less than four times, or the function may be restricted.

To do so:

1. Press the D-ZOOM (+) button to magnify the picture.

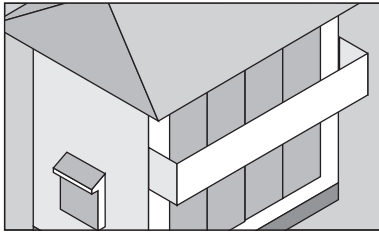
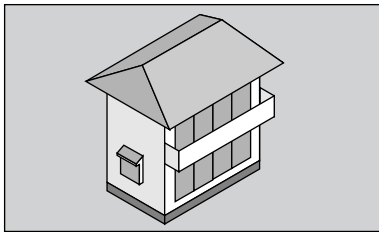

2. Press the ▲▼◀▶ button.

The area of the magnified image will be moved

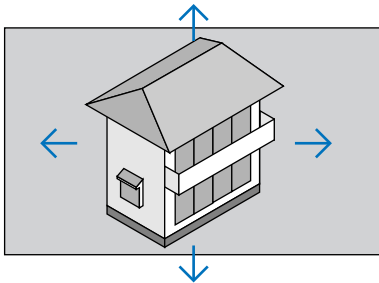

3. Press the D-ZOOM (-) button.

Each time the D-ZOOM (-) button is pressed, the image is demagnified.





NOTE:

- The image will be magnified or demagnified at the center of the screen.
- Displaying the menu will cancel the current magnification.

⑥ Changing LIGHT MODE/Checking Energy-Saving Effect Using LIGHT MODE [LIGHT MODE]

When either [ECO1] or [ECO2] in [LIGHT MODE] is selected, motion noise of the projector is cut down by lowering brightness of its light source. By saving energy consumption, the CO₂ emission from this projector can be reduced.

LIGHT MODE	Icon at the bottom of the menu	Description
NORMAL		100% brightness The screen will be brightly lit.
ECO1		Brightness will be at about 80%. The cooling fan will also slow down accordingly. Lower power consumption
ECO2		Brightness will be at about 50%. The cooling fan will also slow down accordingly. Lower power consumption considerably

* When the brightness is lowered, the cooling fan speed will be reduced accordingly.

To turn on the [LIGHT MODE], do the following:

1. Press LIGHT button on the cabinet.

- In another way, press ECO/L-SHIFT button on the remote control.

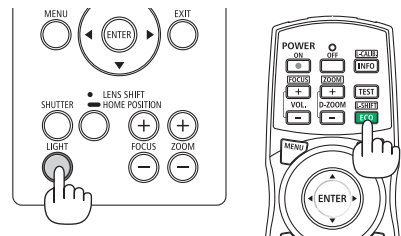
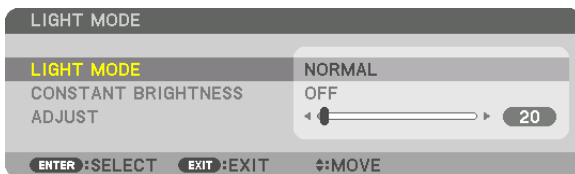

The [LIGHT MODE] screen will be displayed.

2. Press the ENTER button.

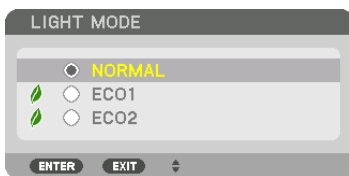

The [LIGHT MODE] selection screen will be displayed.

3. Use the ▼▲ buttons to make a selection, and press the ENTER button.

The display will return to the [LIGHT MODE] screen and the selected option will be applied.

Press the MENU button to return to the original screen.

NOTE:

- The [LIGHT MODE] can be changed by using the menu.
Select [SETUP] → [INSTALLATION] → [LIGHT MODE] → [LIGHT MODE].
 - The light module hours used can be checked in [USAGE TIME]. Select [INFO.] → [USAGE TIME].
 - After a lapse of 1 minute from when the projector displays a blue, black or logo screen, [LIGHT MODE] will automatically switch to [ECO].
 - If the projector is overheated in [NORMAL] mode, there may be a case where the [LIGHT MODE] automatically changes to [ON] mode to protect the projector. This is called "Forced LIGHT MODE". When the projector is in the Forced LIGHT MODE, the picture brightness decreases slightly and the TEMP. indicator lights orange. At the same time the Thermometer symbol [] is displayed at the bottom right of the screen.
When the projector comes back to normal temperature, the Forced LIGHT MODE is cancelled and the [LIGHT MODE] returns to [NORMAL] mode.
-

Checking Energy-Saving Effect [CARBON METER]

This feature will show energy-saving effect in terms of CO₂ emission reduction (kg) when the projector's [LIGHT MODE] is set to either [ECO1] or [ECO2]. This feature is called as [CARBON METER].

There are two messages: [TOTAL CARBON SAVINGS] and [CARBON SAVINGS-SESSION]. The [TOTAL CARBON SAVINGS] message shows the total amount of CO₂ emission reduction from the time of shipment up to now. You can check the information on [USAGE TIME] from [INFO.] of the menu. (→ page 117)

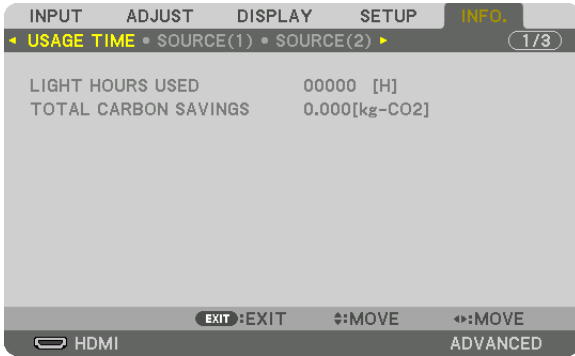

The [CARBON SAVINGS-SESSION] message shows the amount of CO₂ emission reduction between the time of changing to LIGHT MODE immediately after the time of power-on and the time of power-off. The [CARBON SAVINGS-SESSION] message will be displayed in the [POWER OFF/ ARE YOU SURE ?] message at the time of power-off.



TIP:

- The formula shown below is used to calculate the amount of CO₂ emission reduction. Amount of CO₂ emission reduction = (Power consumption in [NORMAL] LIGHT MODE – Power consumption in current setting) × CO₂ conversion factor. * When an energy-saving LIGHT MODE is selected, or the Lens Shutter is used, there will be a further reduction in CO₂ emission.
 - * Calculation for amount of CO₂ emission reduction is based on an OECD publication "CO₂ Emissions from Fuel Combustion, 2008 Edition".
- The [TOTAL CARBON SAVINGS] is calculated based on savings recorded in 15 minutes intervals.
- This formula will not apply to the power consumption which is not affected by whether [LIGHT MODE] is turned on or off.

7 Correcting Horizontal and Vertical Keystone Distortion [CORNERSTONE]

Use the [CORNERSTONE] feature to correct keystone (trapezoidal) distortion to make the top or bottom and the left or right side of the screen longer or shorter so that the projected image is rectangular.

1. **Press and hold the 3D REFORM button for 2 seconds at least to reset current adjustments.**

Current adjustments for [GEOMETRIC CORRECTION] will be cleared.

2. **Project an image so that the screen is smaller than the area of the raster.**

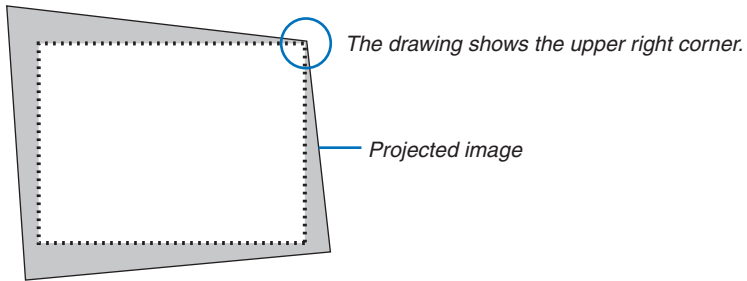

3. **Pick up any one of the corners and align the corner of the image with a corner of the screen.**

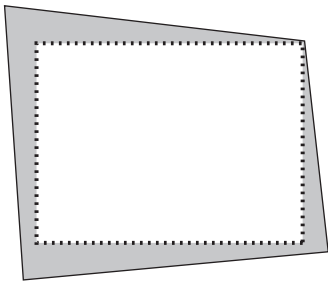

4. **Press the 3D REFORM button.**

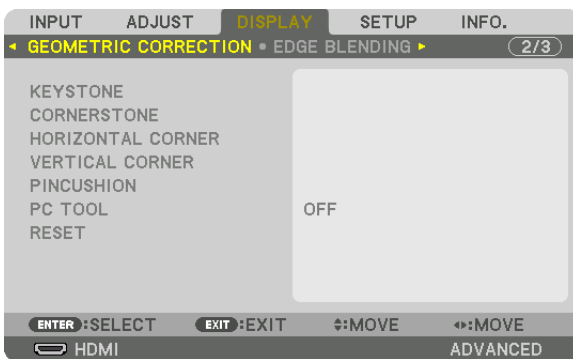

Display the [GEOMETRIC CORRECTION] screen of the on-screen menu.

5. Press the ▼ button to align with the [CORNERSTONE] and then press the ENTER button.



The drawing shows the upper left icon (▼) is selected.

The screen will switch to the [CORNERSTONE] screen.

NOTE:

- When a [GEOMETRIC CORRECTION] function other than [CORNERSTONE] has been set up, the [CORNERSTONE] screen will not be displayed. When the screen is not displayed, either press the 3D REFORM button for 2 or more seconds, or run [RESET] in [GEOMETRIC CORRECTION] to clear the adjustment value of [GEOMETRIC CORRECTION].

6. Use the ▲▼◀▶ button to select one icon (▲) which points in the direction you wish to move the projected image frame.

7. Press the ENTER button.

8. Use the ▲▼◀▶ button to move the projected image frame as shown on the example.

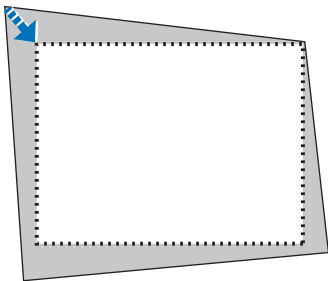

9. Press the ENTER button.

10. Use the ▲▼◀▶ button to select another icon which points in the direction.

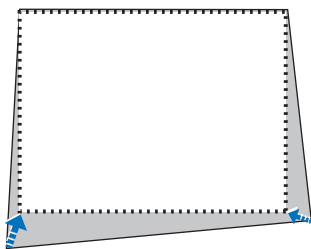

11. Repeat steps from 7 to 10 to complete the cornerstone adjustment.

12. On the [CORNERSTONE] screen, select [EXIT] or press the EXIT button on the remote control.

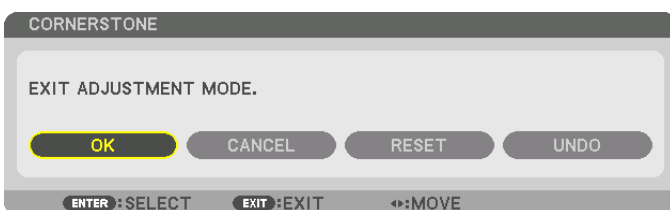

The confirmation screen is displayed.

13. Press the ◀ or ▶ button to highlight the [OK] and press the ENTER button.

This completes the [CORNERSTONE] correction.

- *Returning to the [CORNERSTONE] screen, select [CANCEL] and press the ENTER button.*

NOTE:

- *Even when the projector is turned on, the last used correction values are applied.*
 - *Carry out either one of the following actions to clear the adjustment value of [CORNERSTONE].*
 - *In Step 12, select [RESET] and then press the ENTER button.*
 - *Press the 3D REFORM button for 2 or more seconds.*
 - *Run [DISPLAY] → [GEOMETRIC CORRECTION] → [RESET] in the on-screen menu.*
 - *Using CORNERSTONE correction can cause the image to be slightly blurred because the correction is made electronically.*
-

8 Preventing the Unauthorized Use of the Projector [SECURITY]

A keyword can be set for your projector using the Menu to avoid operation by an unauthorized user. When a keyword is set, turning on the projector will display the Keyword input screen. Unless the correct keyword is entered, the projector cannot project an image.

- The [SECURITY] setting cannot be cancelled by using the [RESET] of the menu.

To enable the Security function:

1. Press the MENU button.

The menu will be displayed.

2. Press the ► button twice to select [SETUP] and press the ▼ button or the ENTER button to select [MENU].

3. Press the ► button to select [CONTROL].

4. Press the ▼ button three times to select [SECURITY] and press the ENTER button.

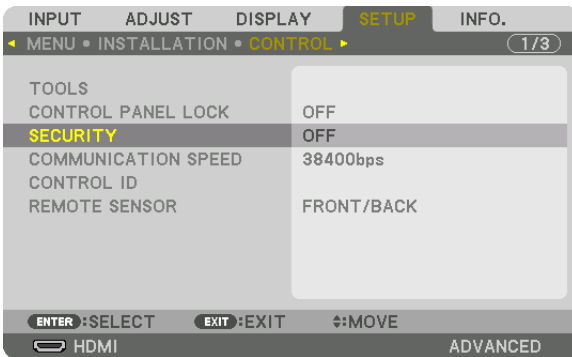

The OFF/ON menu will be displayed.

5. Press the ▼ button to select [ON] and press the ENTER button.

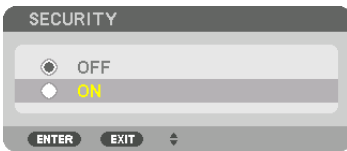

The [SECURITY KEYWORD] screen will be displayed.

6. Type in a combination of the four ▲▼◀▶ buttons and press the ENTER button.

NOTE: A keyword must be 4 to 10 digits in length.

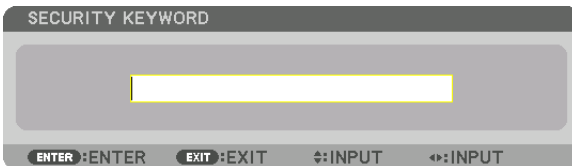

The [CONFIRM KEYWORD] screen will be displayed.

NOTE: Make a note of your password and store it in a safe place.

7. Type in the same combination of ▲▼◀▶ buttons and press the ENTER button.

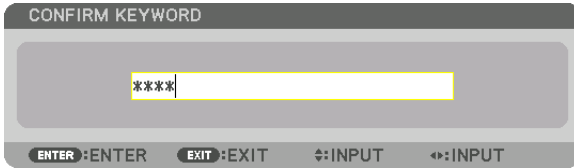

The confirmation screen will be displayed.

8. Select [YES] and press the ENTER button.



The SECURITY function has been enabled.

To turn on the projector when [SECURITY] is enabled:

1. Press the  button.

- If using the remote control, press the POWER ON button.

The projector will be turned on and display a message to the effect that the projector is locked.

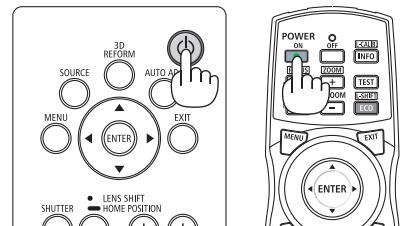

2. Press the MENU button.

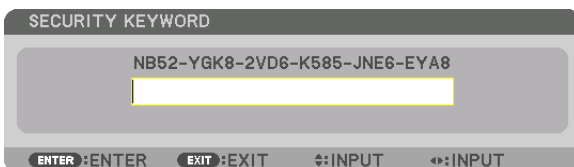

3. Type in the correct keyword and press the ENTER button. The projector will display an image.

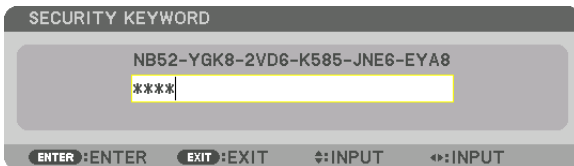

NOTE: The security disable mode is maintained until the main power is turned off or unplugging the power cord.

To disable the SECURITY function:

1. Press the MENU button.

The menu will be displayed.

2. Select [SETUP] → [CONTROL] → [SECURITY] and press the ENTER button.

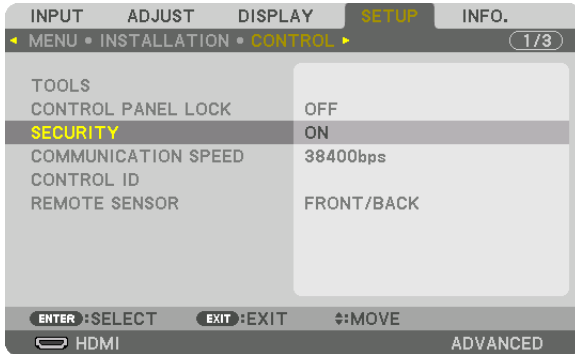

The OFF/ON menu will be displayed.

3. Select [OFF] and press the ENTER button.

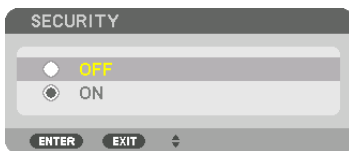

The SECURITY KEYWORD screen will be displayed.

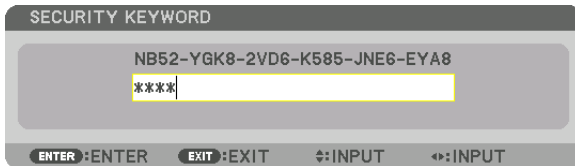

4. Type in your keyword and press the ENTER button.

When the correct keyword is entered, the SECURITY function will be disabled.

NOTE: If you forget your keyword, contact your dealer. Your dealer will provide you with your keyword in exchange for your request code. Your request code is displayed in the Keyword Confirmation screen. In this example [NB52-YGK8-2VD6-K585-JNE6-EYA8] is a request code.

9 Projecting 3D videos

This projector supports DLP-Link glasses and 3D emitter.

CAUTION

Health precautions

Before use, please make sure to read any health precautions that may be stated in the operating manuals enclosed with the 3D eyewear and 3D video software (Blu-ray player, games, computer animation files, etc.).

Please take note of the following in order to avoid adverse health effects.

- Please do not use the 3D eyewear for purposes other than to watch 3D videos.
- Please keep a distance of at least 2 m away from the screen when watching videos. Watching a video too close to the screen will increase eye fatigue.
- Please do not watch videos continuously for a long period of time. Please take a 15 minutes' break after every hour of watching.
- Please consult a doctor before watching if you or any of your family members have a history of suffering from seizures caused by light sensitivity.
- Please stop watching immediately and take a rest when you feel physically unwell while watching (vomiting, giddiness, nausea, headaches, sore eyes, blurred vision, cramps and numbness in the limbs, etc.). Please consult a doctor if the symptoms persist.
- Please watch a 3D video directly in front of the screen. If you watch a 3D video obliquely from the sides, this may result in physical and eye fatigue.

Procedure to watch 3D videos using this projector

The description here are for DLP® Link. [DLP® Link] is default setting for [3D GLASSES] at the factory.

3D eyewear and 3D emitter preparations

Use DLP® Link glasses or other compatible commercially-available liquid crystal shutter spectacles.

1. **Connect the video device to the projector.**
2. **Switch on the projector.**
3. **Run the 3D video software.**

The 3D video will be projected.

The default factory setting is [AUTO]. When 3D image is not projected, it may cause input signal does not contain 3D detection signal or it can not be detected by this projector. In this case, please set up the format manually.

(1) Press the MENU button.

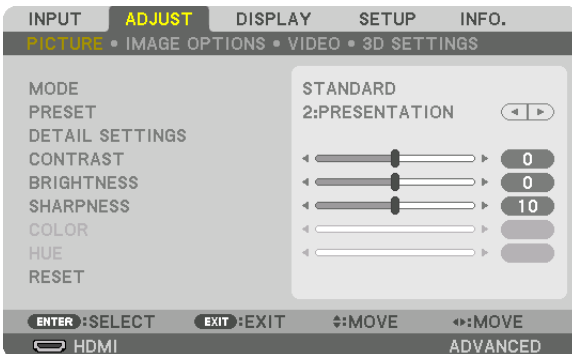

The MENU will be displayed.

(2) Press the ► button, select [ADJUST], then press ENTER.

[PICTURE] will be highlighted.

(3) Use the ► button to select [3D SETTINGS].

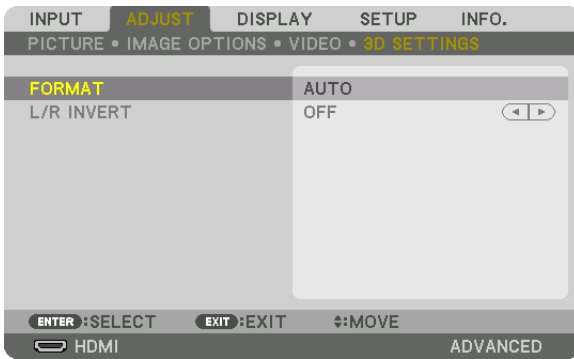

The [3D SETTINGS] screen will be displayed.

(4) Use the ▼ button to align the cursor with [FORMAT], then press ENTER.

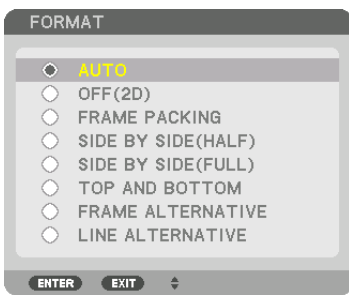

The [FORMAT] screen will be displayed.

(5) Use the ▼/▲ buttons to align the cursor at one among format options, then press ENTER for setting it up.

The display will return to the [FORMAT] screen.

Press the MENU button to return to the original screen.

- The 3D caution message screen will be displayed when switching to a 3D video (default factory setting when shipped). Please read the “Health Precautions” on the previous page to watch videos in the correct manner. The screen will disappear after 60 seconds or when the ENTER button is pressed. (→ page 95)

4. Turn on the power supply of the 3D eyewear and wear the eyewear to watch the video.

A normal video will be shown when a 2D video is input.

To watch a 3D video in 2D, select [OFF(2D)] in the [FORMAT] screen mentioned above in (3).

NOTE:

- If 3D content is played back on your computer and the performance is poor, it may be caused by the CPU or graphics chip. In this case you may have difficulty seeing the 3D images as they were intended. Check to see if your computer meets the requirements provided in your user’s manual included with your 3D content.
- The DLP® Link compatible 3D eyeglasses allow you to view 3D images by receiving synch signals, which are included in left eye and right eye images, reflected from the screen. Depending on environments or conditions such as the ambient brightness, screen size or viewing distance, the 3D eyeglasses may fail to receive synch signals, causing poor 3D images.
- When the 3D mode is enabled, the Keystone correction range will be narrower.
- When the 3D mode is enabled, the following settings are invalid.
[WALL COLOR], [PRESET], [REFERENCE], [COLOR TEMPERATURE], [DYNAMIC CONTRAST], [Brilliant Color]
- Signals other than those listed in “Compatible Input Signal List” on page 160 and 161 will be out of range or displayed in 2D.

Using a 3D emitter

This projector can be used to watch videos in 3D using commercially-available active shutter-type 3D eyewear. In order to synchronize the 3D video and eyewear, a commercially-available 3D emitter needs to be connected to the projector (on the projector side).

The 3D eyewear receives information from the 3D emitter and performs opening and closing on the left and right.

3D eyewear and 3D emitter preparations

Please use an active shutter-type 3D eyewear that conforms with the VESA standard.

A commercially-available RF type made by Xpand is recommended.

3D eyewear..... Xpand X105-RF-X2

3D emitter..... Xpand AD025-RF-X1

Connect your 3D emitter to the 3D SYNC terminal of the projector.

Change [3D GLASSES] setting to [OTHERS].

NOTE:

- Upon switching to 3D image, the following functions will be cancelled and disabled. [BLANKING], [PIP/PICTURE BY PICTURE], [GEOMETRIC CORRECTION], [EDGE BLENDING] ([GEOMETRIC CORRECTION] and [EDGE BLENDING] adjustment values will be maintained.)
 - The output may not automatically switch to a 3D video depending on the 3D input signal.
 - Check the operating conditions described in the user manual of the Blu-ray player.
 - Please connect the DIN terminal of the 3D emitter to the 3D SYNC of the main projector.
 - The 3D eyewear allows videos to be viewed in 3D by receiving synchronized optical signals output from the 3D emitter. As a result, the 3D image quality may be affected by conditions such as the brightness of the surroundings, screen size, viewing distance, etc.
 - When playing a 3D video software on a computer, the 3D image quality may be affected if the computer CPU and graphics chip performance are low. Please check the required operating environment of the computer that is stated in the operating manual attached to the 3D video software.
 - Depending on the signal, [FORMAT] and [L/R INVERT] may not be able to be selected. Please change the signal in that case.
-

When videos cannot be viewed in 3D

Please check the following points when videos cannot be viewed in 3D.

Please also read the operating manual attached to the 3D eyewear.

Possible reasons	Solutions
The selected signal does not support 3D output.	Please change the video signal input to one that supports 3D.
The format for the selected signal is turned to [OFF(2D)].	Please change the format in the on-screen menu to [AUTO] or a format that supports 3D.
A eyewear that is not supported by the projector is being used.	Please purchase a commercially-available 3D eyewear or 3D emitter (recommended). (→ page 40)
Please check the following points when a video cannot be viewed in 3D using a 3D eyewear that is supported by the projector.	
The power supply of the 3D eyewear is turned off.	Please turn on the power supply of the 3D eyewear.
The internal battery of the 3D eyewear is flat.	Please charge or replace the battery.
The viewer is located too far away from the screen.	Please get closer to the screen until the video can be seen in 3D.
	Please turn the L/R INVERT in the on-screen menu to [OFF].
Due to multiple 3D projectors working at the same time in the vicinity, the projectors may interfere with one another. Alternatively, there may be a bright light source near the screen.	Please maintain sufficient distance between the projectors.
	Please keep the light source away from the screen.
	Please turn the L/R INVERT in the on-screen menu to [OFF].
Please check the following points when videos played back on the computer cannot be viewed in 3D.	
Settings on the computer are not compatible with 3D video playback.	Check to make sure that settings on the computer meet requirements for 3D video playback.
Image resolution on the computer cannot be recognized by the projector as 3D video.	Change the image resolution on the computer to one that the projector can recognize as 3D video.
The vertical scan rate on the computer cannot be recognized by the projector as 3D video.	Change the vertical scan rate on the computer to 60 Hz or 120 Hz.
There is an obstacle between the optical receiver of the 3D eyewear and the 3D emitter.	Please remove the obstacle.
The 3D format of the 3D video contents is not supported.	Please check with the company selling the 3D video contents.

10 Controlling the Projector by Using an HTTP Browser

Overview

The HTTP Server function provides settings and operations for:

1. Setting for wired network (NETWORK SETTINGS)

To use wired LAN connection, connect the projector to the computer with a commercially available LAN cable. (→ page 133)

2. Setting Alert Mail (ALERT MAIL)

When the projector is connected to a wired network, error messages will be sent via e-mail.

3. Operating the projector

Power on/off, selecting input, volume control and picture adjustments are possible.

4. Setting PJLink PASSWORD and AMX BEACON

Access to the HTTP server function is available:

- **Start the Web browser on the computer via the network connected to the projector and enter the following URL :**

`http://<the projector's IP address> /index.html`

TIP: The factory setting IP address is [DHCP ON].

NOTE:

- To use the projector in a network, consult with your network administrator about network settings.
 - The display's or button's response can be slowed down or operation may not be accepted depending the settings of your network. Should this happen, consult your network administrator. The projector may not respond if its buttons are repeatedly pressed in rapid intervals. Should this happen, wait a moment and repeat. If you still can't get any response, turn off and back on the projector.
 - If the PROJECTOR NETWORK SETTINGS screen does not appear in the web browser, press the Ctrl+F5 keys to refresh your web browser (or clear the cache).
 - This projector uses "JavaScript" and "Cookies" and the browser should be set to accept these functions. The setting method will vary depending on the version of browser. Please refer to the help files and the other information provided in your software.
-

Preparation before Use

Connect the projector to a commercially available LAN cable before engaging in browser operations. (→ page 133)
Operation with a browser that uses a proxy server may not be possible depending on the type of proxy server and the setting method. Although the type of proxy server will be a factor, it is possible that items that have actually been set will not be displayed depending on the effectiveness of the cache, and the contents set from the browser may not be reflected in operation. It is recommended that a proxy server not be used unless it is unavoidable.

Handling of the Address for Operation via a Browser

Regarding the actual address that is entered for the address or entered to the URL column when operation of the projector is via a browser, the host name can be used as it is when the host name corresponding to the IP address of the projector has been registered to the domain name server by a network administrator, or the host name corresponding to the IP address of the projector has been set in the “HOSTS” file of the computer being used.

Example 1: When the host name of the projector has been set to “pj.nec.co.jp”, access is gained to the network setting by specifying
 http://pj.nec.co.jp/index.html
 for the address or the entry column of the URL.

Example 2: When the IP address of the projector is “192.168.73.1”, access is gained to the network setting by specifying
 http://192.168.73.1/index.html
 for the address or the entry column of the URL.

PROJECTOR ADJUSTMENT

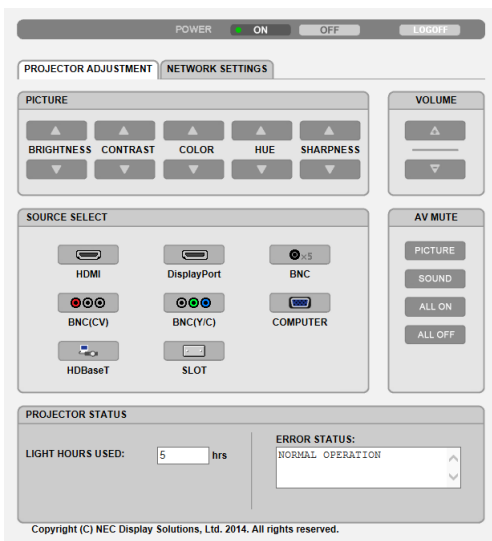

POWER: This controls the power of the projector.
 ON Power is switched on.
 OFF Power is switched off.

VOLUME: Can not be used for this device.

AV-MUTE: This controls the mute function of the projector.
 PICTURE ON..... Mutes the video.
 PICTURE OFF..... Cancels the video muting.
 SOUND ON Cannot be used for this device.
 SOUND OFF Cannot be used for this device.
 ALL ON Mutes the video functions.
 ALL OFF..... Cancels the muting of the video functions.

PICTURE: Controls the video adjustment of the projector.

BRIGHTNESS ▲ Increases the brightness adjustment value.

BRIGHTNESS ▼ Decreases the brightness adjustment value.

CONTRAST ▲ Increases the contrast adjustment value.

CONTRAST ▼ Decreases the contrast adjustment value.

COLOR ▲ Increases the color adjustment value.

COLOR ▼ Decreases the color adjustment value.

HUE ▲ Increases the hue adjustment value.

HUE ▼ Decreases the hue adjustment value.

SHARPNESS ▲ Increases the sharpness adjustment value.

SHARPNESS ▼ Decreases the sharpness adjustment value.

- The functions that can be controlled will vary depending on the signal being input to the projector. (→ page 76, 77)

SOURCE SELECT: This switches the input terminal of the projector.

HDMI Switches to the HDMI IN terminal.

DisplayPort Switches to the DisplayPort IN.

BNC Switch to BNC video input.

BNC(CV) Switch to BNC (CV) video input.

BNC(Y/C) Switch to BNC (Y/C) video input.

COMPUTER Switches to the COMPUTER 1 IN terminal.

HDBaseT Switch to image input sent from a transmission device that supports HDBaseT.

SLOT The projector switches to video input from the optional board when an optional board (sold separately) is equipped on.

PROJECTOR STATUS: This displays the condition of the projector.

LIGHT HOURS USED Displays how many hours the light module has been used.

ERROR STATUS Displays the status of errors occurring within the projector.

LOG OFF: Logging off your projector and returning to the authentication screen (LOGON screen).

NETWORK SETTINGS

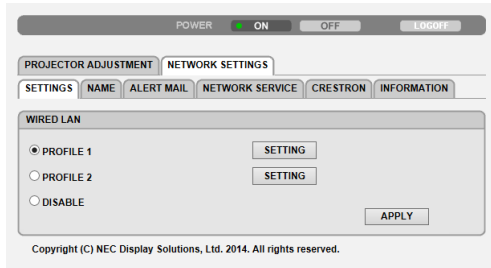

• SETTINGS

WIRED

SETTING	Set for wired LAN.
APPLY	Apply your settings to wired LAN.
PROFILE 1/PROFILE 2	Two settings can be set for wired LAN connection. Select PROFILE 1 or PROFILE 2.
DISABLE	Turn off wired LAN connection
DHCP ON	Automatically assign IP address, subnet mask, and gateway to the projector from your DHCP server.
DHCP OFF	Set IP address, subnet mask, and gateway to the projector assigned by your network administrator.
IP ADDRESS	Set your IP address of the network connected to the projector.
SUBNET MASK	Set your subnet mask number of the network connected to the projector.
GATEWAY	Set the default gateway of the network connected to the projector.
AUTO DNS ON	DHCP server will automatically assign IP address of DNS server connected to the projector.
AUTO DNS OFF	Set your IP address of DNS server connected to the projector.

• NAME

PROJECTOR NAME	Enter a name for your projector so that your computer can identify the projector. A projector name must be 16 characters or less. TIP: Projector name will not be affected even when [RESET] is done from the menu.
HOST NAME	Enter the hostname of the network connected to the projector. A host name must be 15 or less.
DOMAIN NAME	Enter the domain name of the network connected to the projector. A domain name must be 60 characters or less.

• ALERT MAIL

ALERT MAIL	This option will notify your computer of error messages via e-mail when using wired LAN. Placing a checkmark will turn on the Alert Mail feature. Clearing a checkmark will turn off the Alert Mail feature. Sample of a message to be sent from the projector: Subject: [Projector] Projector Information THE COOLING FAN HAS STOPPED. [INFORMATION] PROJECTOR NAME: PX602UL Series LIGHT HOURS USED: 0000[H]
SENDER'S ADDRESS	Enter sender's address.
SMTP SERVER NAME	Enter the SMTP server name to be connected to the projector.
RECIPIENT'S ADDRESS 1, 2, 3	Enter your recipient's address. Up to three addresses can be entered.
TEST MAIL	Send a test mail to check whether your settings are correct or not <i>NOTE:</i> <ul style="list-style-type: none"> • If you execute a test, you may not receive an Alert mail. Should this happen, check if network settings are correct. • If you entered an incorrect address in a test, you may not receive an Alert mail. Should this happen, check if the Recipient's Address is correct.
SAVE	Click this button to save your settings to the projector's memory.

• NETWORK SERVICE

PJLink PASSWORD	Set a password for PJLink*. A password must be 32 characters or less. Do not forget your password. However, if you forget your password, consult with your dealer.
HTTP PASSWORD	Set a password for HTTP server. A password must be 10 characters or less. When a password is set up, you will be prompted for your user name (arbitrary) and password during LOGON.
AMX BEACON	Turn on or off for detection from AMX Device Discovery when connecting to the network supported by AMX's NetLinx control system. <i>TIP:</i> <i>When using a device that supports AMX Device Discovery, all AMX NetLinx control system will recognize the device and download the appropriate Device Discovery Module from an AMX server. Placing a checkmark will enable detecting the projector from AMX Device Discovery. Clearing a checkmark will disable detecting the projector from AMX Device Discovery.</i>

NOTE: If you forget your password, contact your dealer.

*What is PJLink?

PJLink is a standardization of protocol used for controlling projectors of different manufacturers. This standard protocol is established by Japan Business Machine and Information System Industries Association (JBMIA) in 2005. The projector supports all the commands of PJLink Class 1.

Setting of PJLink will not be affected even when [RESET] is done from the menu.

CRESTRON

• ROOMVIEW for managing from the computer.

DISABLE	Disables ROOMVIEW.
ENABLE	Enables ROOMVIEW.

• CRESTRON CONTROL for managing from the controller.

DISABLE	Disables CRESTRON CONTROL.
ENABLE	Enables CRESTRON CONTROL.
IP ADDRESS	Set your IP address of CRESTRON SERVER.
IP ID	Set your IP ID of CRESTRON SERVER.

• INFORMATION

WIRED LAN	Display a list of settings of wired LAN connection.
UPDATE	Reflect settings when they are changed.

TIP: The CRESTRON settings are required only for use with CRESTRON ROOMVIEW.

For more information, visit <http://www.crestron.com>

4. Multi-Screen Projection

① Things that can be done using multi-screen projection

This projector can be used singly or arranged in multiple units for multi-screen projection. We will introduce an example using two projection screens here.

Case 1

Using a single projector to project two types of videos at the same time [PIP/PICTURE BY PICTURE]

Case 2

Using four projectors (resolution: WUXGA) to project video with a resolution of 2560 × 1600 pixels [TILING]

Case 1. Using a single projector to project two types of videos [PIP/PICTURE BY PICTURE]

Connection example and projection image

In the case of [PICTURE BY PICTURE]

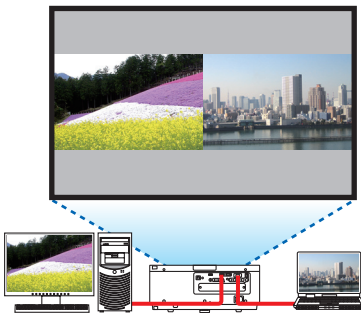

In the case of [PIP]

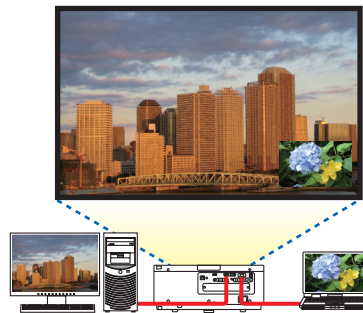

On-screen menu operations

Display [DISPLAY] → [PIP/PICTURE BY PICTURE] → [MODE] screen in the on-screen menu and select [PIP] or [PICTURE BY PICTURE].

For details, please refer to “4-2 Displaying Two Pictures at the Same Time”. (→ page 52)

Case 2. Using four projectors (resolution: WUXGA) to project videos with a resolution of 2560 × 1600 pixels [TILING]

Connection example and projection image

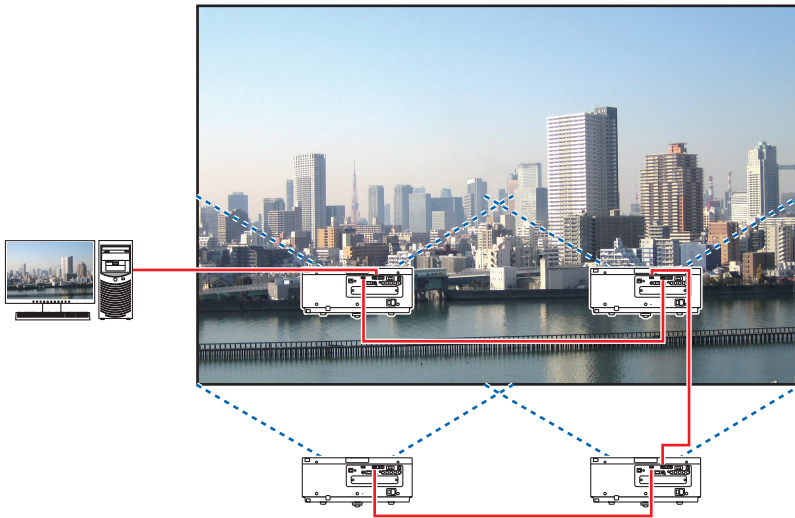

On-screen menu operations

1 *Four similar videos are displayed when four projectors are projected.*

Please request the dealer to adjust the projection position of each projector.



4. Multi-Screen Projection

2 Operate the on-screen menu using the four respective projectors to divide the image into four portions.

Display [DISPLAY] → [MULTI SCREEN] → [PICTURE SETTING] Screen in the on-screen menu and select [TILING].

(1) In the screen for setting the number of horizontal units, select [2 UNITS]. (number of units in the horizontal direction)

(2) In the screen for setting the number of vertical units, select [2 UNITS]. (number of units in the vertical direction)

(3) In the screen for setting the horizontal order, select [1st UNIT] or [2nd UNIT].

(look at the screens, the one on the left is the [1st UNIT] while the one on the right is the [2nd UNIT])

(4) In the screen for setting the vertical order, select the [1st UNIT] or the [2nd UNIT].

(look at the screens, the one at the top is the [1st UNIT] while the one at the bottom is the [2nd UNIT])



3 Adjust the lens shift of each projector to fine-tune the boundaries of the screen.

For further fine-tuning, adjust using [DISPLAY] → [EDGE BLENDING] in the on-screen menu for each projector.

For details, please refer to “4-3 Displaying a Picture Using [EDGE BLENDING]”.

(→ page 56)

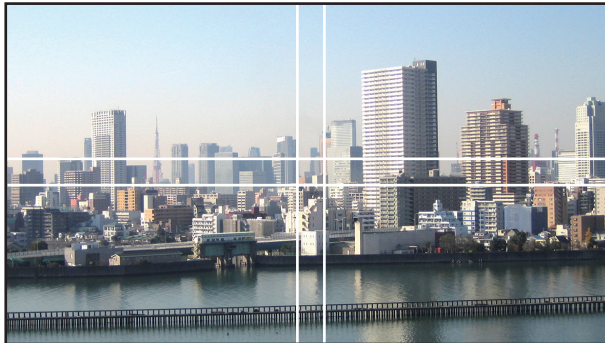

Things to note when installing projectors

- Leave 1 m or over space between the projectors when projectors are installed side by side, so that the intake and exhaust vents of the projectors are not obstructed. In addition, leave a space of at least 30 cm between the intake/exhaust vent and the wall. When the air intake and discharge outlet are obstructed, the temperature inside the projector will rise and this may result in a malfunction.

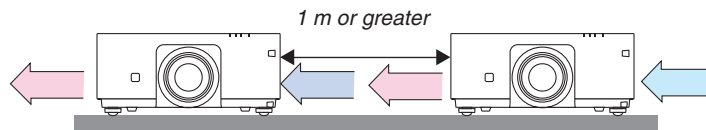

- Two projectors can be stacked on top of each other (STACK setting). (→ page 138) Do not attempt to directly stack three or more projectors. When the projectors are piled up on top of one another, they may fall down, resulting in damage and failure.



- Installation example when using 3 or more projectors
The following installation is recommended when installing a combination of 3 or more projectors for multi-screen projection.
[Installation example]

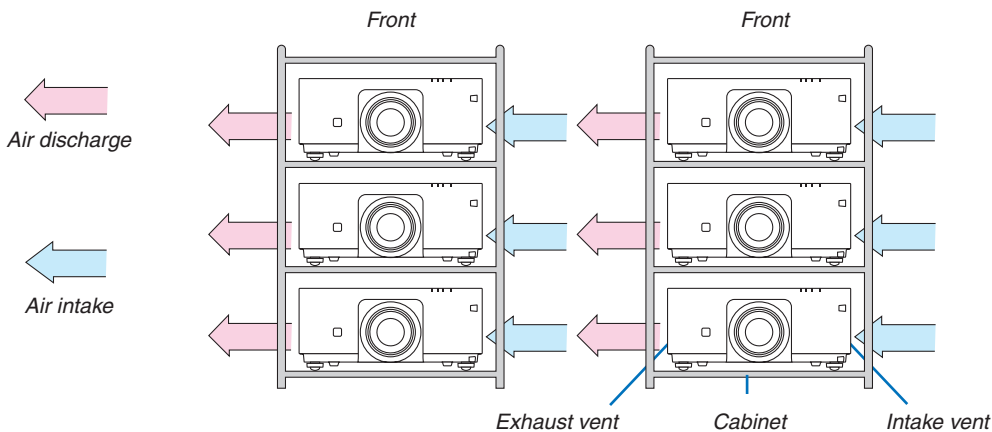

WARNING

Please request the dealer for special installation services such as when mounting the projector to the ceiling. Never carry out the installation by yourself. The projector may fall down and result in injury. Please use a sturdy cabinet that can withstand the weight of the projector for the installation. Please do not pile up the projectors directly on top of one another.

NOTE:

- For the range of the projection distance, please refer to the Appendix "Throw distance and screen size". (→ page 153)

② Displaying Two Pictures at the Same Time

The projector has a feature that allows you to view two different signals simultaneously. You have two modes: picture in picture (PIP) mode and picture by picture (PICTURE BY PICTURE) mode.

The projection video in the first screen display is known as the main display while the projection video that is called out subsequently is known as the sub-display.

Select the projection function under [DISPLAY] → [PIP/PICTURE BY PICTURE] → [MODE] in the on-screen menu (the default factory setting when shipped is PIP). (→ page 85)

- A single screen is projected when power is turned on.

Picture in Picture function (PIP)

A small sub-display is displayed inside the main display.

The sub-display can be set up and adjusted as follows. (→ page 86)

- Select whether to display the sub-display at the top right, top left, bottom right or bottom left of the screen (the size of the sub-display can be selected and the position can be fine-tuned)
- Switch the main display with the sub-display

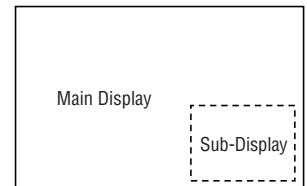

Picture by picture function (PICTURE BY PICTURE)

Display the main display and sub-display side by side.

The main display and sub-display can be set up and adjusted as follows. (→ page 86)

- Selecting the display boundary (ratio) of the main display and sub-display
- Switch the main display and sub-display

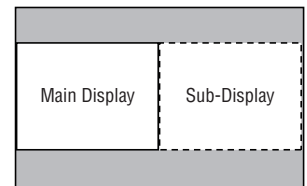

Input terminals that can be used for the main screen and sub-screen.

The main screen and sub-screen can provide the following input terminals.

- The main display and sub-display support computer signals up to WUXGA@60HzRB.

		Sub-Display or additional display							
		HDMI	DisplayPort	BNC	BNC(CV)	BNC(Y/C)	COMPUTER	HDBaseT	SLOT
Main Display	HDMI	No		Yes	Yes	Yes	Yes	No	No
	DisplayPort	No		Yes	Yes	Yes	Yes		
	BNC	Yes	Yes	No			No	Yes	Yes
	BNC(CV)	Yes	Yes	No			Yes	Yes	Yes
	BNC(Y/C)	Yes	Yes	No			Yes	Yes	Yes
	COMPUTER	Yes	Yes	No	Yes	Yes	No	Yes	Yes
	HDBaseT	No		Yes	Yes	Yes	Yes	No	No
SLOT	No		Yes	Yes	Yes	Yes	No	No	

NOTE:

- Some signals may not appear depending on the resolution.

Projecting two screens

1. Press the **MENU** button to display the on-screen menu and select **[DISPLAY]** → **[PIP/PICTURE BY PICTURE]**.

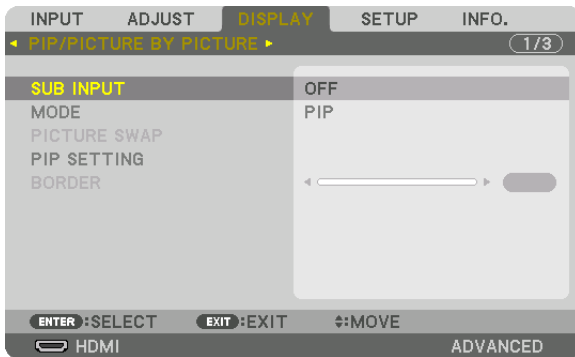

This displays the **[PIP/PICTURE BY PICTURE]** screen in the on-screen menu.

2. Select **[SUB INPUT]** using the **▼/▲** buttons, and press the **ENTER** button.

This displays the **[SUB INPUT]** screen.

3. Select the input signal using the **▼/▲** buttons, and press the **ENTER** button.

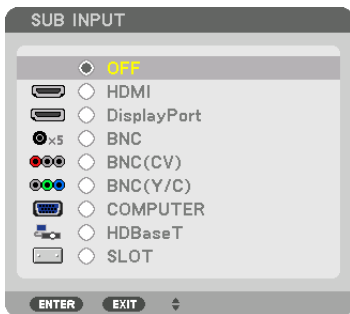

The **[PIP]** (PICTURE IN PICTURE) or **[PICTURE BY PICTURE]** screen set up under **[MODE]** is projected. (→ page 85)

- When the signal name is displayed in grey, this means that it cannot be selected.
- The signal can also be selected by pressing the **PIP/FREEZE** button on the remote control.

4. Press the **MENU** button.

The on-screen menu will disappear.

5. When returning to single screen, display the **[PIP/PICTURE BY PICTURE]** screen one more time and select **[OFF]** in the **[SUB INPUT]** screen of the Step 3.

TIP:

- During dual-screen projection, if the selected input is not supported by the sub-screen, the sub-screen will appear as a black screen.

Switching the main display with the sub-display and vice versa

1. Press the **MENU** button to display the on-screen menu and select **[DISPLAY]** → **[PIP/PICTURE BY PICTURE]**.

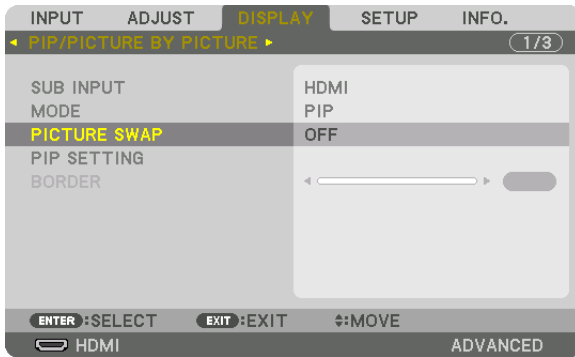

This displays the **[PIP/PICTURE BY PICTURE]** screen in the on-screen menu.

2. Select **[PICTURE SWAP]** using the **▼/▲** buttons and then press the **ENTER** button.
Display the screen for switching the display positions.
3. Select **[ON]** using the **▼** button and then press the **ENTER** button.



The video of the main display will switch with that of the sub-display.

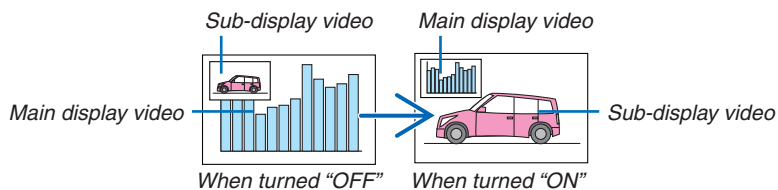

The signal output from the **HDMI OUT** terminal does not change even if the display positions are switched.

4. Press the **menu** button.

The on-screen menu will disappear.

Restrictions

- The following operations are enabled only for the main display.
 - Visual adjustments
 - Video magnification / demagnification using the partial D-ZOOM/ZOOM +/- buttons.
However, magnification / demagnification is up to the boundary set in [PICTURE BY PICTURE].
 - TEST PATTERN
- The following operations are enabled for both the main display and sub-display. These operations cannot be applied individually.
 - Momentary deletion of video
 - Video pause
- [PIP/PICTURE BY PICTURE] cannot be used when a 3D video is being displayed.
- When using the [PIP/PICTURE BY PICTURE] function, [CLOSED CAPTION] and [DYNAMIC CONTRAST] can be used.
- [PIP/PICTURE BY PICTURE] cannot be used when the signal input has a resolution of 1920 × 1200 or more.
- The HDMI OUT terminal has a repeater function. The output resolution is limited by the maximum resolution of the connected monitor and projector.

③ Displaying a Picture Using [EDGE BLENDING]

A high resolution video can be projected on an even bigger screen by combining multiple projectors on the left, right, top and bottom.

This projector is equipped with an “EDGE BLENDING Function” that makes the edges (boundaries) of the projection screen indistinguishable.

NOTE:

- For projector throw distances, refer to “Throw distance and screen size” on page 153.
- Before performing the Edge Blending function, place the projector in the correct position so that the image becomes square in the appropriate size, and then make optical adjustments (lens shift, focus, and zoom).
- Adjust the brightness of each projector using [ADJUST] under [LIGHT MODE]. After adjusting the brightness, you can keep the set brightness level by turning ON the [CONSTANT BRIGHTNESS] mode. In addition, use [REF. WHITE BALANCE] to adjust the [CONTRAST] and [BRIGHTNESS].

Before explaining use of the Edge Blending function

This section explains the case for “Example: Placing two projectors side by side”. As shown, the projected image on the left is referred to as “Projector A” and the projected image on the right is referred to as “Projector B”. Unless otherwise specified hereinafter, the “projector” is used to mean both A and B.

Example: Placing two projectors side by side

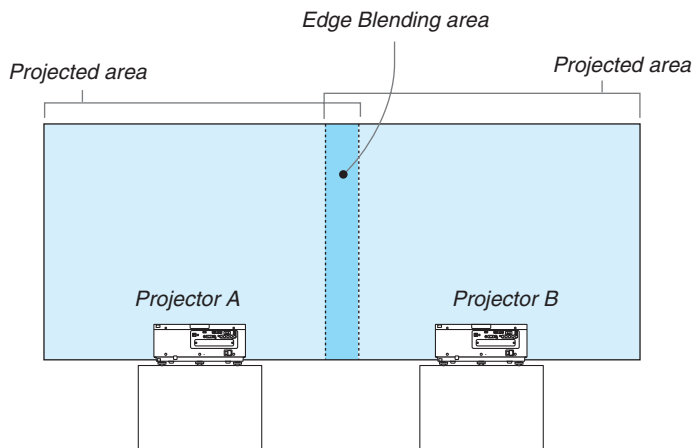

Preparation:

- Turn on the projector and display a signal.
- When performing settings or adjustments using the remote control, enable the [CONTROL ID] so as not to activate the other projectors. (→ page 105)

Setting the overlap of projection screens

① Enable [EDGE BLENDING].

1. Press the **MENU** button.

The menu will be displayed.

2. Select [EDGE BLENDING].

The [EDGE BLENDING] screen will be displayed. Align the cursor with [MODE] and then press the **ENTER** button. The mode screen will be displayed.

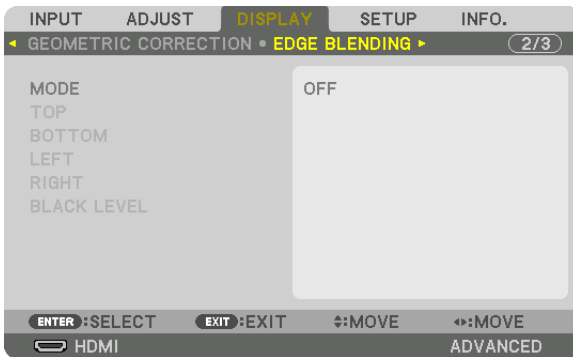

3. Select [MODE] → [ON] and press the **ENTER** button.

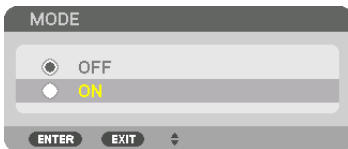

This enables the Edge Blending function. The following menu items are available: [TOP], [BOTTOM], [LEFT], [RIGHT], and [BLACK LEVEL]

4. Select [RIGHT] for Projector A and [LEFT] for Projector B.

Press the **ENTER** button.



The following items are available:

[CONTROL], [MARKER], [RANGE], and [POSITION]

5. Select [CONTROL] → [ON] and press the ENTER button.

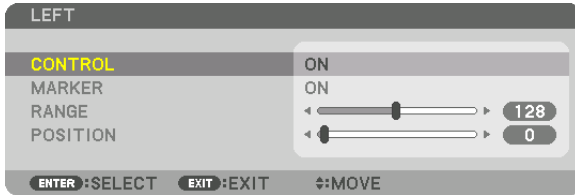

Each [TOP], [BOTTOM], [LEFT], [RIGHT], and [BLACK LEVEL] has its own [CONTROL], [MARKER], [RANGE], and [POSITION].

- For Projector A, set the [CONTROL] for the [TOP], [LEFT] and [BOTTOM] to [OFF]. Similarly for Projector B, set the [CONTROL] for the [TOP], [RIGHT] and [BOTTOM] to [OFF].

② Adjust [RANGE] and [POSITION] to determine an area of overlapped edges of images projected from each projector.

Turning on [MARKER] will display markers in magenta and green.
The magenta marker is used for [RANGE] and green one for [POSITION].

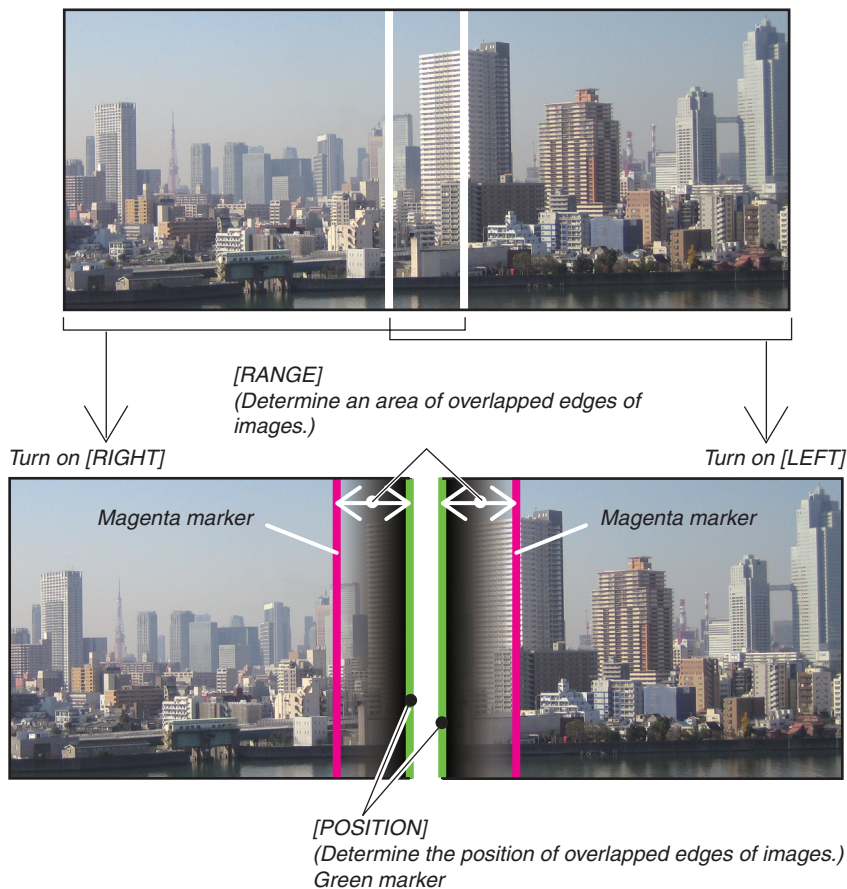

* The 2 screens are separated in the diagram for explanatory purposes.

1 Adjust [RANGE].

Use the ◀ or ▶ button to adjust the overlapped area.

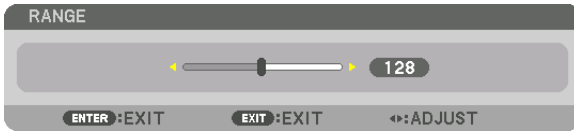

TIP:

- Adjust to overlap one projector's marker with the other projector's marker.

2 Adjust [POSITION].

Use the ◀ or ▶ button to align one edge with the other edge of overlapped images.

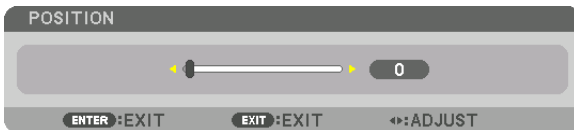

TIP:

- When displaying a signal with a different resolution, perform the Edge Blending function from the start.
- Setting of [MARKER] will not be saved and return to [OFF] when the projector is turned off.
- To display or hide the marker while the projector is running, turn on or off [MARKER] from the menu.

Black Level Adjustment

This adjusts the black level of the overlapping area and the non-overlapping area of the multi-screen (EDGE BLENDING). Adjust the brightness level if you feel the difference is too large.

NOTE:

This function is enabled only when [MODE] is turned on.

Adjustable area varies depending on what combination of [TOP], [BOTTOM], [LEFT] and [RIGHT] are turned on.

Example: Adjusting the Black Level when placing two projectors side by side

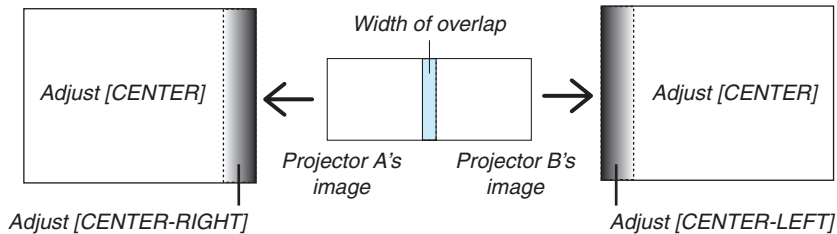

1. Turn on [MODE]

2. Select [BLACK LEVEL] and press the ENTER button.

The screen will switch to the black level adjustment screen.



3. Use the ▼ or ▲ button to select an item and use the ◀ or ▶ to adjust the black level.

Do this for the other projector if necessary.

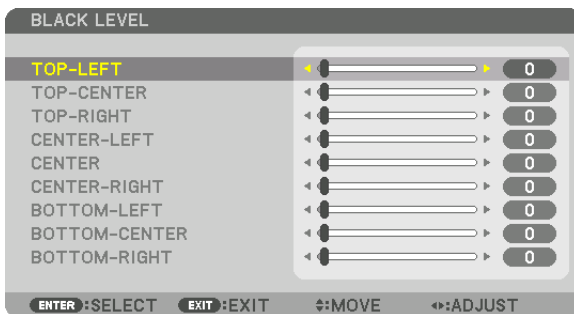

9-segmented portions for Black Level adjustment

The center projector

This function adjusts the brightness level of 9-segmented portions for the center projector and 4-segmented portions for the left bottom projector as shown below.

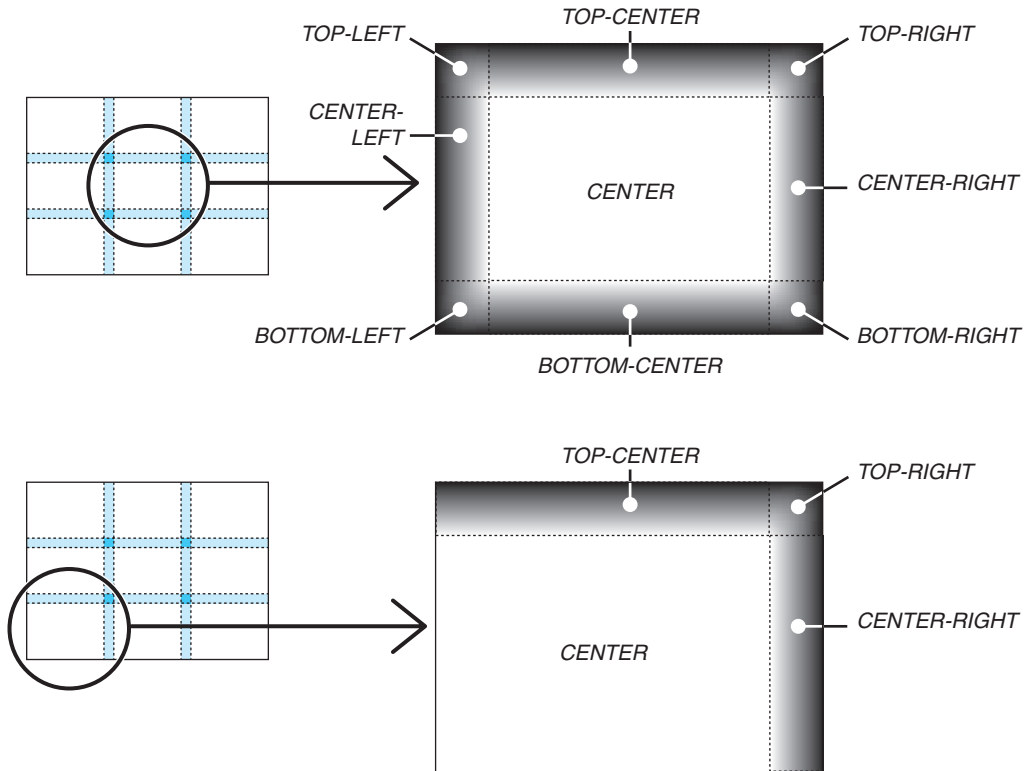

TIP:

- The number of black level division screens (maximum of nine divisions) changes depending on the number of edge blending positions selected (top, bottom, right, left). In addition, when the top / bottom and left / right ends are selected, the corner division screen appears.
- The edge blending width is the width set in the range and the corner is formed by the intersecting area of the top / bottom ends or left / right ends.
- The [BLACK LEVEL] can be adjusted to make it brighter only.

5. Using On-Screen Menu

① Using the Menus

NOTE: The on-screen menu may not be displayed correctly depending on input signal and the projector setting.

1. Press the **MENU** button on the remote control or the projector cabinet to display the menu.

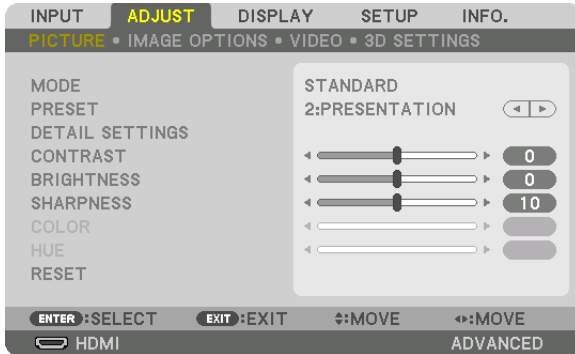

NOTE: The commands such as ENTER, EXIT, ▲▼, ◀▶ in the bottom show available buttons for your operation.

2. Press the ◀▶ buttons on the remote control or the projector cabinet to display the submenu.
3. Press the ENTER button on the remote control or the projector cabinet to highlight the top item or the first tab.
4. Use the ▲▼ buttons on the remote control or the projector cabinet to select the item you want to adjust or set.
You can use the ◀▶ buttons on the remote control or the projector cabinet to select the tab you want.
5. Press the ENTER button on the remote control or the projector cabinet to display the submenu window.
6. Adjust the level or turn the selected item on or off by using the ▲▼◀▶ buttons on the remote control or the projector cabinet.
Changes are stored until adjusted again.
7. Repeat steps 2-6 to adjust an additional item, or press the EXIT button on the remote control or the projector cabinet to quit the menu display.

NOTE: When a menu or message is displayed, several lines of information may be lost, depending on the signal or settings.

8. Press the **MENU** button to close the menu.
To return to the previous menu, press the **EXIT** button.

2 Menu Elements

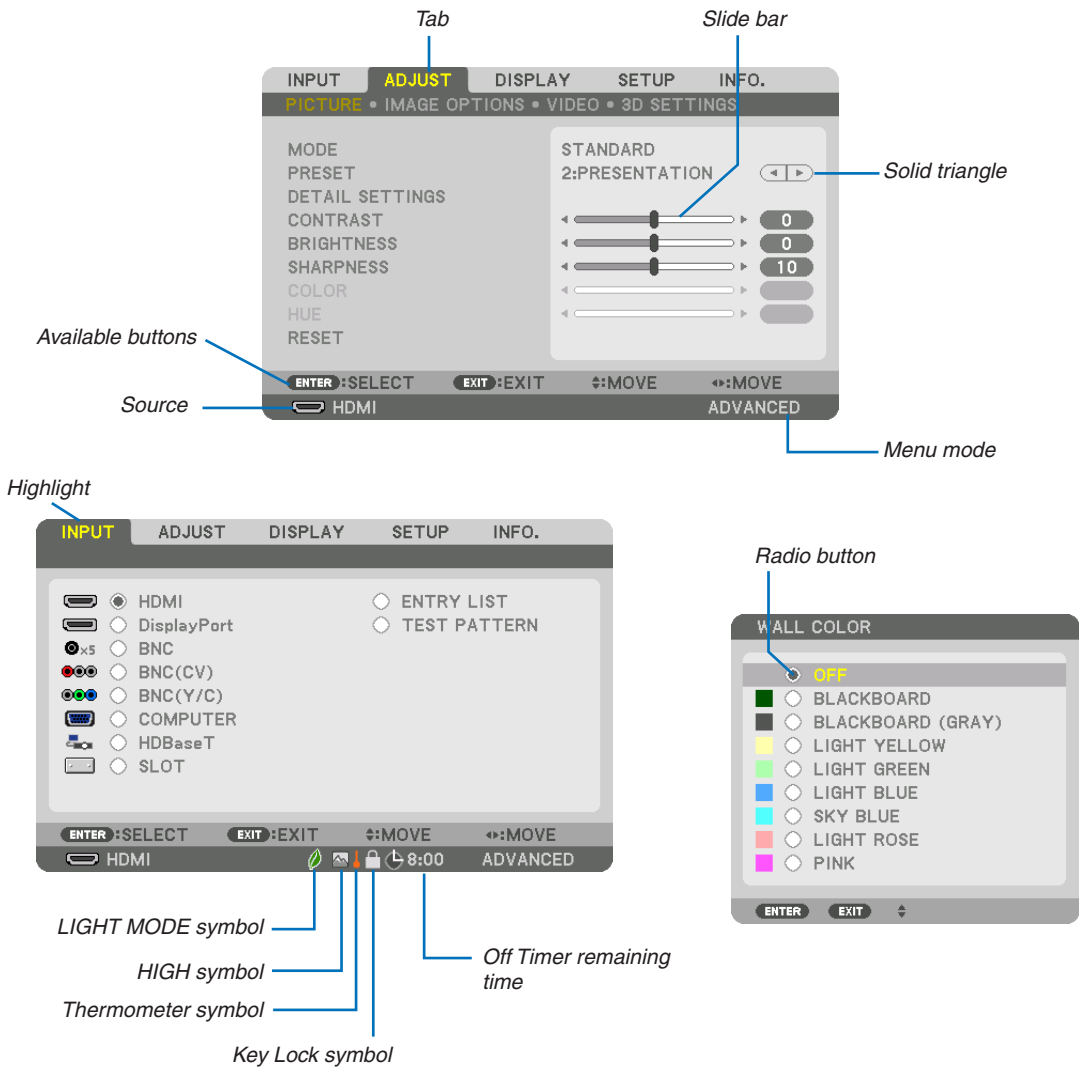

Menu windows or dialog boxes typically have the following elements:

- Highlight..... Indicates the selected menu or item.
- Solid triangle Indicates further choices are available. A highlighted triangle indicates the item is active.
- Tab..... Indicates a group of features in a dialog box. Selecting on any tab brings its page to the front.
- Radio button..... Use this round button to select an option in a dialog box.
- Source Indicates the currently selected source.
- Menu mode Indicates the current menu mode: BASIC or ADVANCED.
- Off Timer remaining time.... Indicates the remaining countdown time when the [OFF TIMER] is preset.
- Slide bar Indicates settings or the direction of adjustment.
- LIGHT MODE symbol..... Indicates [LIGHT MODE] is set.
- Key Lock symbol Indicates the [CONTROL PANEL LOCK] is enabled.
- Thermometer symbol Indicates the [LIGHT MODE] is forcibly set to [ECO] mode because the internal temperature is too high.
- HIGH symbol Indicates the [FAN MODE] is set to [HIGH] mode.

3 List of Menu Items

• Basic menu items are indicated by shaded area.

Some menu items are not available depending on the input source.

Menu Item	Default	Options		
INPUT	HDMI	*		
	DisplayPort	*		
	BNC	*		
	BNC(CV)	*		
	BNC(Y/C)	*		
	COMPUTER	*		
	HDBaseT			
	SLOT			
	ENTRY LIST			
	TEST PATTERN			
ADJUST	MODE	STANDARD	STANDARD, PROFESSIONAL	
	PRESET	*	HIGH-BRIGHT, PRESENTATION, VIDEO, MOVIE, GRAPHIC, sRGB, DICOM SIM.	
	DETAIL SETTINGS	GENERAL		
		REFERENCE	*	HIGH-BRIGHT, PRESENTATION, VIDEO, MOVIE, GRAPHIC, sRGB, DICOM SIM.
		GAMMA CORRECTION*1		DYNAMIC, NATURAL, BLACK DETAIL
		SCREEN SIZE*2	*	LARGE, MEDIUM, SMALL
		COLOR TEMPERATURE*3	*	
		DYNAMIC CONTRAST	*	OFF, ON
		Brilliant Color	*	OFF, MEDIUM, HIGH
		IMAGE MODE	*	STILL, MOVIE
		WHITE BALANCE		
		CONTRAST R	0	
		CONTRAST G	0	
		CONTRAST B	0	
		BRIGHTNESS R	0	
		BRIGHTNESS G	0	
		BRIGHTNESS B	0	
	COLOR CORRECTION			
	RED	0		
	GREEN	0		
	BLUE	0		
	YELLOW	0		
	MAGENTA	0		
	CYAN	0		
	CONTRAST	50		
	BRIGHTNESS	50		
	SHARPNESS	10		
	COLOR	50		
	HUE	0		
	RESET			
	IMAGE OPTIONS	CLOCK	*	
		PHASE	*	
HORIZONTAL		*		
VERTICAL		*		
BLANKING		*	TOP, BOTTOM, LEFT, RIGHT	
OVERSCAN		AUTO	AUTO, 0[%], 5[%], 10[%]	
ASPECT RATIO		AUTO	(COMPUTER) AUTO, 4:3, 5:4, 16:9, 15:9, 16:10, NATIVE	
		AUTO	(COMPONENT/VIDEO/S-VIDEO) AUTO, 4:3, LETTERBOX, WIDE SCREEN, ZOOM	
INPUT RESOLUTION		*	(COMPONENT/VIDEO/S-VIDEO) AUTO, 4:3 WINDOW, LETTERBOX, WIDE SCREEN, FULL	
VIDEO		NOISE REDUCTION	OFF	OFF, LOW, MEDIUM, HIGH
	MOSQUITO NR	OFF	OFF, LOW, MEDIUM, HIGH	
	BLOCK NR	OFF	OFF, LOW	
	DEINTERLACE	NORMAL	NORMAL, MOVIE, STILL	
	CONTRAST ENHANCEMENT	MODE	AUTO	OFF, AUTO, NORMAL
	SIGNAL TYPE		AUTO	AUTO, RGB, COMPONENT
	VIDEO LEVEL		AUTO	AUTO, NORMAL, ENHANCED, SUPER WHITE
3D SETTINGS	FORMAT	AUTO	AUTO, OFF(2D), FRAME PACKING, SIDE BY SIDE(HALF), SIDE BY SIDE(FULL), TOP AND BOTTOM, FRAME ALTERNATIVE, LINE ALTERNATIVE	
	L/R INVERT	OFF	OFF, ON	

* The asterisk (*) indicates that the default setting varies depending on the signal.

*1 The [GAMMA CORRECTION] item is available when an item other than [DICOM SIM.] is selected for [REFERENCE].

*2 The [SCREEN SIZE] item is available when [DICOM SIM.] is selected for [REFERENCE].

*3 When [PRESENTATION] or [HIGH-BRIGHT] is selected in [REFERENCE], the [COLOR TEMPERATURE] is not available.

5. Using On-Screen Menu

Menu Item		Default	Options		
DISPLAY	PIP/PICTURE BY PICTURE	SUB INPUT		OFF, HDMI, DisplayPort, BNC, BNC(CV), BNC(Y/C), COMPUTER, HDBaseT, SLOT	
		MODE		PIP	
		PICTURE SWAP		OFF	PIP, PICTURE BY PICTURE
		PIP SETTING	START POSITION		TOP-LEFT
			HORIZONTAL POSITION		
			VERTICAL POSITION		
	SIZE		MEDIUM	LARGE, MEDIUM, SMALL	
	BORDER				
	GEOMETRIC CORRECTION	KEystone	HORIZONTAL		
			VERTICAL		
			TILT		
			THROW RATIO		
		CORNERSTONE			TOP-LEFT, TOP-CENTER, TOP-RIGHT, CENTER-LEFT, CENTER-RIGHT, BOTTOM-LEFT, BOTTOM-CENTER, BOTTOM-RIGHT
		HORIZONTAL CORNER			TOP-LEFT, TOP-CENTER, TOP-RIGHT, CENTER-LEFT, CENTER-RIGHT, BOTTOM-LEFT, BOTTOM-CENTER, BOTTOM-RIGHT
		VERTICAL CORNER			TOP-LEFT, TOP-CENTER, TOP-RIGHT, CENTER-LEFT, CENTER-RIGHT, BOTTOM-LEFT, BOTTOM-CENTER, BOTTOM-RIGHT
	PINCUSHION			TOP, BOTTOM, LEFT, RIGHT	
	PC TOOL		OFF	OFF, 1, 2, 3	
	RESET				
	EDGE BLENDING	MODE		OFF	OFF, ON
		TOP	CONTROL		ON
			MARKER		ON
			RANGE		
			POSITION		
		BOTTOM	CONTROL		ON
			MARKER		ON
			RANGE		
			POSITION		
		LEFT	CONTROL		ON
			MARKER		ON
			POSITION		
		RIGHT	CONTROL		ON
			MARKER		ON
			POSITION		
		BLACK LEVEL	TOP-LEFT		
			TOP-CENTER		
			TOP-RIGHT		
			CENTER-LEFT		
	CENTER				
	CENTER-RIGHT				
	BOTTOM-LEFT				
BOTTOM-CENTER					
BOTTOM-RIGHT					
MULTI SCREEN	WHITE BALANCE	MODE		OFF	
		CONTRAST W			
		CONTRAST R			
		CONTRAST G			
		CONTRAST B			
		BRIGHTNESS W			
		BRIGHTNESS R			
		BRIGHTNESS G			
	BRIGHTNESS B				
	PICTURE SETTING	MODE		OFF	OFF, ZOOM, TILING
		ZOOM	HORIZONTAL ZOOM		
			VERTICAL ZOOM		
			HORIZONTAL POSITION		
			VERTICAL POSITION		
TILING		WIDTH		1 UNIT, 2 UNITS, 3 UNITS, 4 UNITS	
	HEIGHT		1 UNIT, 2 UNITS, 3 UNITS, 4 UNITS		
	HORIZONTAL POSITION		1st UNIT, 2nd UNIT, 3rd UNIT, 4th UNIT		
	VERTICAL POSITION		1st UNIT, 2nd UNIT, 3rd UNIT, 4th UNIT		

5. Using On-Screen Menu

Menu Item		Default	Options		
SETUP	MENU	LANGUAGE	ENGLISH, DEUTSCH, FRANÇAIS, ITALIANO, ESPAÑOL, SVENSKA, 日本語, DANSK, PORTUGUÊS, ČEŠTINA, MAGYAR, POLSKI, NEDERLANDS, SUOMI, NORSK, TÜRKÇE, РУССКИЙ, عربي, Ελληνικά, 中文, 한국어, ROMÂNĂ, HRVATSKA, БЪЛГАРСКИ, INDONESIA, हिन्दी, ไทย, ភ្នំខ្មែរ, 繁體中文		
		COLOR SELECT	COLOR COLOR, MONOCHROME		
		INPUT DISPLAY	ON OFF, ON		
		MESSAGE DISPLAY	ON OFF, ON		
		ID DISPLAY	ON OFF, ON		
		3D CAUTION MESSAGE	ON OFF, ON		
		DISPLAY TIME	AUTO 45 SEC MANUAL, AUTO 5 SEC, AUTO 15 SEC, AUTO 45 SEC		
	INSTALLATION	ORIENTATION	AUTO	AUTO, DESKTOP FRONT, CEILING REAR, DESKTOP REAR, CEILING FRONT	
		SCREEN TYPE	FREE	FREE, 4:3 SCREEN, 16:9 SCREEN, 16:10 SCREEN	
		WALL COLOR	OFF	OFF, BLACKBOARD, BLACKBOARD (GRAY), LIGHT YELLOW, LIGHT GREEN, LIGHT BLUE, SKY BLUE, LIGHT ROSE, PINK	
		FAN MODE	AUTO	AUTO, HIGH	
		LIGHT MODE	LIGHT MODE	NORMAL	NORMAL, ECO1, ECO2
			CONSTANT BRIGHTNESS	OFF	OFF, ON
			ADJUST		20–100%
		REF. WHITE BALANCE	CONTRAST R		
			CONTRAST G		
			CONTRAST B		
			BRIGHTNESS R		
			BRIGHTNESS G		
			BRIGHTNESS B		
UNIFORMITY R					
UNIFORMITY B					
3D GLASSES	DLP® Link	DLP® Link, OTHERS			

5. Using On-Screen Menu

Menu Item		Default	Options					
SETUP	CONTROL	TOOLS	ADMINISTRATOR MODE	MENU MODE ADVANCED	ADVANCED, BASIC			
			NOT SAVE SETTING VALUES	OFF	OFF, ON			
			NEW PASSWORD					
			CONFIRM PASSWORD					
			PROGRAM TIMER	SETTINGS	ENABLE	OFF	OFF, ON	
					EDIT	ACTIVE		OFF, ON
						DAY		SUN, MON, TUE, WED, THU, FRI, SAT, MON-FRI, MON-SAT, EVERY DAY
						TIME		
						FUNCTION		POWER, INPUT, LIGHT MODE
						ADVANCED SETTINGS		
						POWER		OFF, ON
						INPUT		HDMI, DisplayPort, BNC, BNC(CV), BNC(Y/C), COMPUTER, HDBaseT, SLOTT
						LIGHT MODE		NORMAL, ECO1, ECO2
					REPEAT		OFF, ON	
					DELETE UP			
					DOWN			
					BACK			
			DATE AND TIME SETTINGS	TIME ZONE SETTINGS	GMT		-12:00, -11:30, -11:00, -10:30, -10:00, -09:30, -09:00, -08:30, -08:00, -07:30, -07:00, -06:30, -06:00, -05:30, -05:00, -04:30, -04:00, -03:30, -03:00, -02:30, -02:00, -01:30, -01:00, -00:30, 00:00, +00:30, +01:00, +01:30, +02:00, +02:30, +03:00, +03:30, +04:00, +04:30, +05:00, +05:30, +06:00, +06:30, +07:00, +07:30, +08:00, +08:30, +09:00, +09:30, +10:00, +10:30, +11:00, +11:30, +12:00, +12:30, +13:00	
						DATE MM/DD/YYYY		
				DATE AND TIME SETTINGS	TIME HH:MM			
					INTERNET TIME SERVER		OFF, ON	
					IP ADDRESS			
					UPDATE			
				SUMMER TIME SETTINGS	ENABLE		OFF, ON	
					MON(START)		1, 2, 3, 4, 5, 6, 7, 8, 9, 10, 11, 12	
					DAY(START)		FIRST WEEK, SECOND WEEK, THIRD WEEK, FOURTH WEEK, LAST WEEK	
							SUN, MON, TUE, WED, THU, FRI, SAT	
					TIME(START)			
					MON(EXIT)		1, 2, 3, 4, 5, 6, 7, 8, 9, 10, 11, 12	
					DAY(EXIT)		FIRST WEEK, SECOND WEEK, THIRD WEEK, FOURTH WEEK, LAST WEEK	
				SUN, MON, TUE, WED, THU, FRI, SAT				
			TIME(EXIT)					
			TIME DIFFERENCE		+01:00, +00:30, -00:30, -01:00			
			MOUSE		(Note) Cannot be used for this device.			
			CONTROL PANEL LOCK		OFF	OFF, ON		
			SECURITY		OFF	OFF, ON		
			COMMUNICATION SPEED		38400bps	4800bps, 9600bps, 19200bps, 38400bps, 115200bps		
			CONTROL ID	CONTROL ID NUMBER	1	1-254		
				CONTROL ID	OFF	OFF, ON		
			REMOTE SENSOR		FRONT/ BACK	FRONT/BACK, FRONT, BACK, HDBase-T		

5. Using On-Screen Menu

Menu Item		Default	Options		
SETUP	NETWORK SETTINGS	PROFILES	DISABLE, PROFILE 1, PROFILE 2		
		DHCP	OFF, ON		
		IP ADDRESS	192.168.0.10		
		SUBNET MASK	255.255.255.0		
		GATEWAY	192.168.0.1		
		AUTO DNS	OFF, ON		
		DNS CONFIGURATION			
		RECONNECT			
		PROJECTOR NAME	PROJECTOR NAME	PX602UL Series	
		DOMAIN	HOST NAME	necpj	
			DOMAIN NAME		
		ALERT MAIL	ALERT MAIL	OFF, ON	
			HOST NAME		
			DOMAIN NAME		
			SENDER'S ADDRESS		
			SMTP SERVER NAME		
			RECIPIENT'S ADDRESS 1		
			RECIPIENT'S ADDRESS 2		
			RECIPIENT'S ADDRESS 3		
		TEST MAIL			
		NETWORK SERVICE	HTTP SERVER	NEW PASSWORD CONFIRM PASSWORD	
			PJLink	NEW PASSWORD CONFIRM PASSWORD	
			AMX BEACON	OFF, ON	
			CRESTRON	ROOMVIEW	OFF, ON
				CRESTRON CONTROL (ENABLE, CONTROLLER IP ADDRESS, IP ID)	
			SOURCE OPTIONS	AUTO ADJUST	NORMAL
	COLOR SYSTEM	BNC(VIDEO)		AUTO	AUTO, NTSC3.58, NTSC4.43, PAL, PAL-M, PAL-N, PAL60, SECAM
		BNC(Y/C)		AUTO	AUTO, NTSC3.58, NTSC4.43, PAL, PAL-M, PAL-N, PAL60, SECAM
	DEFAULT INPUT SELECT	LAST		LAST, AUTO, HDMI, DisplayPort, BNC, BNC(CV), BNC(Y/C), COMPUTER, HDBaseT, SLOT	
	CLOSED CAPTION	OFF		OFF, CAPTION1, CAPTION2, CAPTION3, CAPTION4, TEXT1, TEXT2, TEXT3, TEXT4	
	BACKGROUND	BLUE	BLUE, BLACK, LOGO		
	POWER OPTIONS	STANDBY MODE	NORMAL	NORMAL, NETWORK STANDBY	
		DIRECT POWER ON	OFF	OFF, ON	
		AUTO POWER ON SELECT	OFF	OFF, HDMI, DisplayPort, COMPUTER, HDBaseT, SLOT	
		AUTO POWER OFF	1:00	OFF, 0:05, 0:10, 0:15, 0:20, 0:30, 1:00	
		OFF TIMER	OFF	OFF, 0:30, 1:00, 2:00, 4:00, 8:00, 12:00, 16:00	
		SLOT POWER	PROJECTOR ON	ON	OFF, ON
			PROJECTOR STANDBY	ENABLE	DISABLE, ENABLE
	RESET	CURRENT SIGNAL			
		ALL DATA			
ALL DATA (INCLUDING ENTRY LIST)					

5. Using On-Screen Menu

Menu Item		Default	Options
INFO.	USAGE TIME	LIGHT HOURS USED	
		TOTAL CARBON SAVINGS	
	SOURCE(1)	INPUT TERMINAL	
		RESOLUTION	
		HORIZONTAL FREQUENCY	
		VERTICAL FREQUENCY	
		SYNC TYPE	
		SYNC POLARITY	
		SCAN TYPE	
		SOURCE NAME	
	SOURCE(2)	ENTRY NO.	
		SIGNAL TYPE	
		VIDEO TYPE	
		BIT DEPTH	
		VIDEO LEVEL	
		LINK RATE	
		LINK LANE	
	SOURCE(3)	3D FORMAT	
		INPUT TERMINAL	
		RESOLUTION	
		HORIZONTAL FREQUENCY	
		VERTICAL FREQUENCY	
		SYNC TYPE	
		SYNC POLARITY	
		SCAN TYPE	
	SOURCE(4)	SOURCE NAME	
		ENTRY NO.	
		SIGNAL TYPE	
		VIDEO TYPE	
		BIT DEPTH	
		VIDEO LEVEL	
		LINK RATE	
	WIRED LAN	LINK LANE	
		3D FORMAT	
		IP ADDRESS	
		SUBNET MASK	
	VERSION(1)	GATEWAY	
		MAC ADDRESS	
		FIRMWARE	
	OTHERS	DATA	
		SUB-CPU	
		DATE TIME	
		PROJECTOR NAME	
MODEL NO.			
HDBaseT	SERIAL NUMBER		
	CONTROL ID (when [CONTROL ID] is set)		
	SIGNAL QUALITY		
	OPERATION MODE		
	LINK STATUS		
	HDMI STATUS		

4 Menu Descriptions & Functions [INPUT]

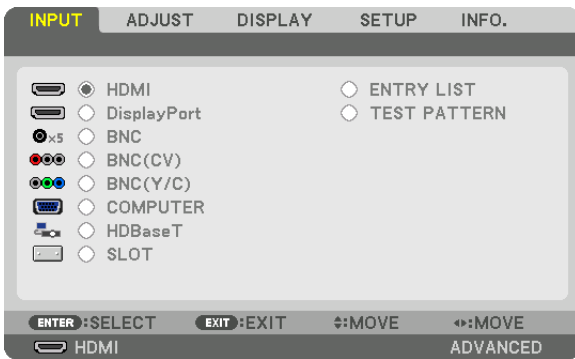

HDMI

This projects the video of the device connected to the HDMI IN terminal.

DisplayPort

This projects the video of the device connected to the Display Port IN terminal.

BNC

This projects the video of the device connected to the video input terminal.
(This projects the analog RGB signal or component signal.)

BNC(CV)

This projects the video of the device connected to the BNC (CV) video input terminal.
(This projects the composite video signal.)

BNC(Y/C)

This projects the video of the device connected to the BNC (Y/C) video input terminal.
(This projects the S-video signal.)

COMPUTER

This projects the video of the device connected to the COMPUTER 1 IN terminal.
(This projects the analog RGB signal or component signal.)

HDBaseT

Projecting the HDBaseT or WIRED LAN signal.

SLOT

Projects the picture via the optional board (sold separately) inserted into the SLOT.

ENTRY LIST

Displays a list of signals. See the following pages.

TEST PATTERN

Closes the menu and switches to the test pattern screen.
Select the pattern using the ◀▶ buttons.

Using the Entry List

When any source adjustments are made, the adjustments are automatically registered in the Entry List. The (adjustment values of) registered signals can be loaded from the Entry List whenever necessary. However, only up to 100 patterns can be registered in the Entry List. When 100 patterns have been registered in the Entry List, an error message is then displayed and no additional patterns can be registered. You should thus delete (adjustment values of) signals that are no longer needed.

Displaying the Entry list

1. Press the MENU button.

The menu will be displayed.

2. Press the ◀ or ▶ button to select [INPUT].

The INPUT list will be displayed.

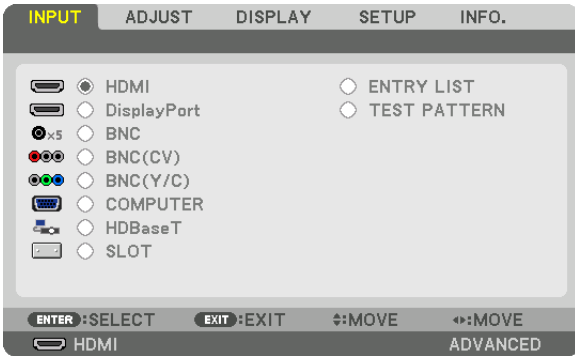

3. Use the ◀, ▶, ▲, or ▼ to select [ENTRY LIST] and press the ENTER button.

The ENTRY LIST windows will be displayed.

If the ENTRY LIST window is not displayed, switch the menu to [ADVANCED].

To switch the menu between [ADVANCED] and [BASIC], select [SETUP] → [CONTROL] → [TOOLS] → [ADMINISTRATOR MODE] → [MENU MODE]. (→ page 99)

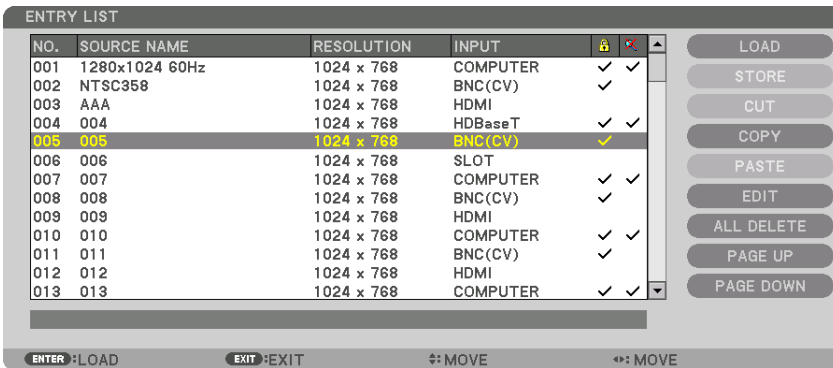

Entering the currently projected signal into the Entry List [STORE]

1. Press the ▲ or ▼ button to select any number.
2. Press the ◀ or ▶ button to select [STORE] and press the ENTER button.

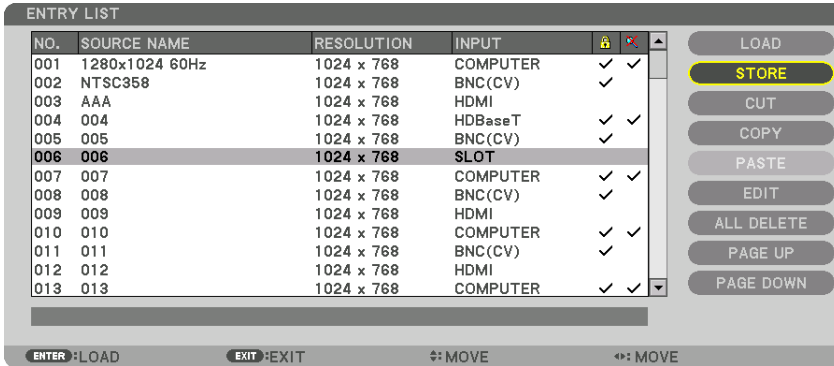

Calling up a signal from the Entry List [LOAD]

Press the ▲ or ▼ button to select a signal and press the ENTER button.

Editing a signal from the Entry List [EDIT]

1. Press the ▲ or ▼ button to select a signal you wish to edit.
2. Press the ◀, ▶, ▲, or ▼ button to select [EDIT] and press the ENTER button.

The Edit window will be displayed.

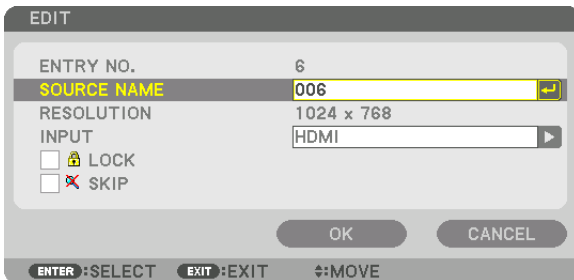

SOURCE NAME	Enter a signal name. Up to 18 alphanumeric characters can be used.
INPUT	The input terminal can be changed. Switching between HDMI/DisplayPort/BNC/BNC (CV)/BNC (Y/C)/Computer/HDBaseT/SLOT is possible.
LOCK	Set so that the selected signal cannot be deleted when [ALL DELETE] is executed. The changes made after LOCK execution cannot be saved.
SKIP	Set so that the selected signal will be skipped during auto search.

3. Set the above items and select [OK] and press the ENTER button.

NOTE: The input terminal cannot be changed to the currently projected signal.

Cutting a signal from the Entry List [CUT]

1. Press the ▲ or ▼ button to select a signal you wish to delete.
2. Press the ◀, ▶, ▲, or ▼ button to select [CUT] and press the ENTER button.

The signal will be deleted from the Entry List and the deleted signal will be displayed on the clipboard at the bottom of the Entry List.

NOTE:

- The currently projected signal cannot be deleted.
 - When the locked signal is selected, it will be displayed in gray which indicates it is not available.
-

TIP:

- Data on the clipboard can be passed onto the Entry List.
- Data on the clipboard will not be lost after the Entry List is closed.

Copying and pasting a signal from the Entry List [COPY] / [PASTE]

1. Press the ▲ or ▼ button to select a signal you wish to copy.
2. Press the ◀, ▶, ▲, or ▼ button to select [COPY] and press the ENTER button.
The copied signal will be displayed on the clipboard at the bottom of the Entry List.
3. Press the ◀ or ▶ button to move to the list.
4. Press the ▲ or ▼ button to select a signal.
5. Press the ◀, ▶, ▲, or ▼ button to select [PASTE] and press the ENTER button.

Data on the clipboard will be pasted to the signal.

Deleting all the signals from the Entry List [ALL DELETE]

1. Press the ◀, ▶, ▲, or ▼ button to select [ALL DELETE] and press the ENTER button.
The confirmation message will be displayed.
2. Press the ◀ or ▶ button to select [YES] and press the ENTER button.

NOTE: The locked signal cannot be deleted.

5 Menu Descriptions & Functions [ADJUST]

[PICTURE]

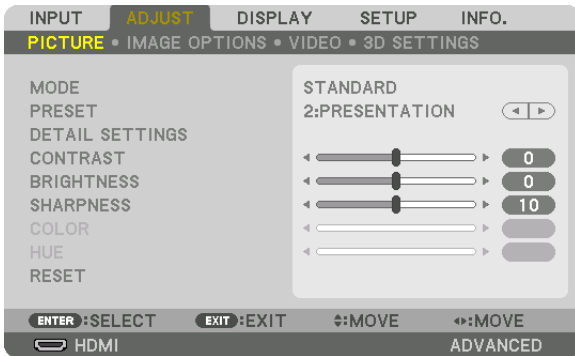

[MODE]

This function allows you to determine how to save settings for [DETAIL SETTINGS] of [PRESET] for each input.

STANDARD Saves settings for each item of [PRESET] (Preset 1 through 7)

PROFESSIONAL..... Saves all the settings of [PICTURE] for each input.

NOTE:

- When [TEST PATTERN] is displayed, [MODE] cannot be selected.
-

[PRESET]

This function allows you to select optimized settings for your projected image.

You can adjust neutral tint for yellow, cyan or magenta.

There are seven factory presets optimized for various types of images. You can also use [DETAIL SETTINGS] to set user adjustable settings to customize each gamma or color.

Your settings can be stored in [PRESET 1] to [PRESET 7].

HIGH-BRIGHT Recommended for use in a brightly lit room.

PRESENTATION Recommended for making a presentation using a PowerPoint file.

VIDEO Recommended for typical TV program viewing.

MOVIE Recommended for movies.

GRAPHIC Recommended for graphics.

sRGB Standard color values

DICOM SIM. Recommended for DICOM simulation format.

NOTE:

- The [DICOM SIM.] option is for training/reference only and should not be used for actual diagnosis.
 - DICOM stands for Digital Imaging and Communications in Medicine. It is a standard developed by the American College of Radiology (ACR) and the National Electrical Manufacturers Association (NEMA).
The standard specifies how digital image data can be moved from system to system.
 - Adjustment may not work depending on input signal.
-

[DETAIL SETTINGS]

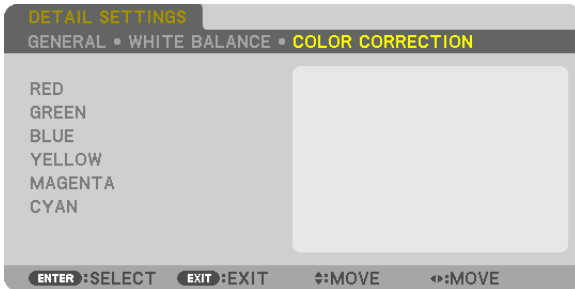
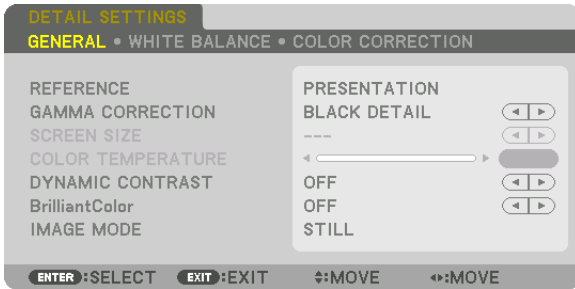

[GENERAL]

Storing Your Customized Settings [REFERENCE]

This function allows you to store your customized settings in [PRESET 1] to [PRESET 7].

First, select a base preset mode from [REFERENCE], then set [GAMMA CORRECTION] and [COLOR TEMPERATURE].

- HIGH-BRIGHT Recommended for use in a brightly lit room.
- PRESENTATION Recommended for making a presentation using a PowerPoint file.
- VIDEO Recommended for typical TV program viewing.
- MOVIE Recommended for movies.
- GRAPHIC Recommended for graphics.
- sRGB Standard color values.
- DICOM SIM. Recommended for DICOM simulation format.

Selecting Gamma Correction Mode [GAMMA CORRECTION]

Each mode is recommended for:

- DYNAMIC Creates a high-contrast picture.
- NATURAL Natural reproduction of the picture.
- BLACK DETAIL Emphasizes detail in dark areas of the picture.

NOTE: This function is not available when [DICOM SIM.] is selected for [DETAIL SETTINGS].

Selecting Screen Size for DICOM SIM [SCREEN SIZE]

This function will perform gamma correction appropriate for the screen size.

- LARGE For screen size of 150"
- MEDIUM For screen size of 100"
- SMALL For screen size of 50"

NOTE: This function is available only when [DICOM SIM.] is selected for [DETAIL SETTINGS].

Adjusting Color Temperature [COLOR TEMPERATURE]

This option allows you to select the color temperature of your choice.
A value between 5000 K and 10500 K can be set in 100 K units.

NOTE: When [PRESENTATION] or [HIGH-BRIGHT] is selected in [REFERENCE], this function is not available.

Adjusting Brightness and Contrast [DYNAMIC CONTRAST]

If [ON] is selected, the most optimal contrast ratio is used according to the picture.

NOTE:

- Depending on the conditions, projector settings such as [DYNAMIC CONTRAST] may not be able to be selected.
-

[Brilliant Color]

Selects the brightness of the color white.
Selecting options from [MEDIUM] to [HIGH] increases the brightness of the color white.

NOTE:

- If under [REFERENCE], [HIGH-BRIGHT] or [PRESENTATION] are selected, [BrilliantColor] cannot be changed.
-

Selecting Still Image Mode or Movie Mode [IMAGE MODE]

This function allows you to select the still image mode or the movie mode.

STILL..... This mode is for a still image.

MOVIE This mode is for a movie.

NOTE:

- This mode may not be available depending on input signal.
-

Adjusting White Balance [WHITE BALANCE]

This allows you to adjust the white balance. Contrast for each color (RGB) to adjust the white level of the screen;
Brightness for each color (RGB) is used to adjust the black level of the screen.

[COLOR CORRECTION]

Corrects the color for all signals.
Adjusts the tone for the colors red, green, blue, yellow, magenta and cyan.

RED	HUE	+ Direction	Magenta direction
		- Direction	Yellow direction
	SATURATION	+ Direction	Vivid
		- Direction	Weak
GREEN	HUE	+ Direction	Yellow direction
		- Direction	Cyan direction
	SATURATION	+ Direction	Vivid
		- Direction	Weak
BLUE	HUE	+ Direction	Cyan direction
		- Direction	Magenta direction
	SATURATION	+ Direction	Vivid
		- Direction	Weak
YELLOW	HUE	+ Direction	Red direction
		- Direction	Green direction
	SATURATION	+ Direction	Vivid
		- Direction	Weak
MAGENTA	HUE	+ Direction	Blue direction
		- Direction	Red direction
	SATURATION	+ Direction	Vivid
		- Direction	Weak

CYAN	HUE	+ Direction	Green direction
		- Direction	Blue direction
	SATURATION	+ Direction	Vivid
		- Direction	Weak

[CONTRAST]

Adjusts the intensity of the image according to the incoming signal.

[BRIGHTNESS]

Adjusts the brightness level or the back raster intensity.

[SHARPNESS]

Controls the detail of the image.

[COLOR]

Increases or decreases the color saturation level.

[HUE]

Varies the color level from +/- green to +/- blue. The red level is used as reference.

Input signal	CONTRAST	BRIGHTNESS	SHARPNESS	COLOR	HUE
RGB system of "COMPUTER/DisplayPort/HDMI/HDBaseT"	Yes	Yes	Yes	No	No
COMPONENT system of "COMPUTER/DisplayPort/HDMI/HDBaseT"	Yes	Yes	Yes	Yes	Yes
Composite Video/S-Video	Yes	Yes	Yes	Yes	Yes

Yes = Adjustable, No = Not adjustable

NOTE:

- When [TEST PATTERN] is displayed, [CONTRAST], [BRIGHTNESS], [SHARPNESS], [COLOR] and [HUE] cannot be adjusted.

[RESET]

The settings and adjustments for [PICTURE] will be returned to the factory settings with the exception of the following; Preset numbers and [REFERENCE] within the [PRESET] screen.

The settings and adjustments under [DETAIL SETTINGS] within the [PRESET] screen that are not currently selected will not be reset.

[IMAGE OPTIONS]

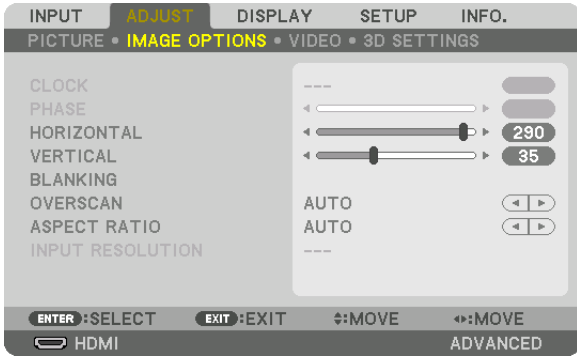

Adjusting Clock and Phase [CLOCK/PHASE]

This allows you to manually adjust CLOCK and PHASE.

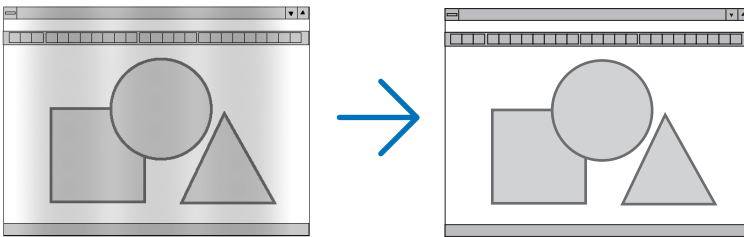

CLOCK..... Use this item to fine tune the computer image or to remove any vertical banding that might appear. This function adjusts the clock frequencies that eliminate the horizontal banding in the image.

This adjustment may be necessary when you connect your computer for the first time.

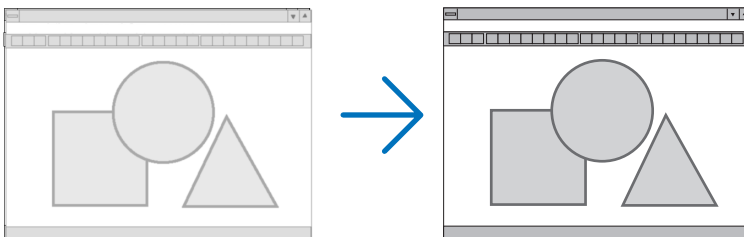

PHASE..... Use this item to adjust the clock phase or to reduce video noise, dot interference or cross talk. (This is evident when part of your image appears to be shimmering.)

Use [PHASE] only after the [CLOCK] is complete.

NOTE: The [CLOCK] and [PHASE] items are available for RGB signals only.

Adjusting Horizontal/Vertical Position [HORIZONTAL/VERTICAL]

Adjusts the image location horizontally and vertically.

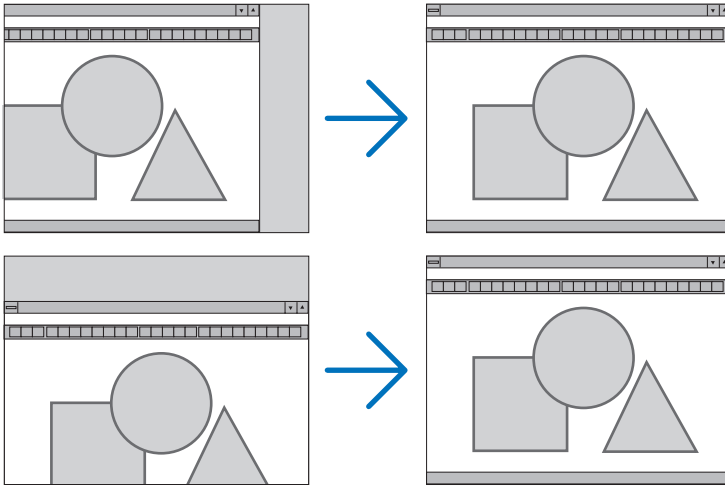

- An image can be distorted during the adjustment of [CLOCK] and [PHASE]. This is not malfunction.
- The adjustments for [CLOCK], [PHASE], [HORIZONTAL], and [VERTICAL] will be stored in memory for the current signal. The next time you project the signal with the same resolution, horizontal and vertical frequency, its adjustments will be called up and applied.
To delete adjustments stored in memory, from the menu, you select [RESET] → [CURRENT SIGNAL] and reset the adjustments.

[BLANKING]

Adjusts the display range (blanking) at the top, bottom, left and right edges of the input signal.

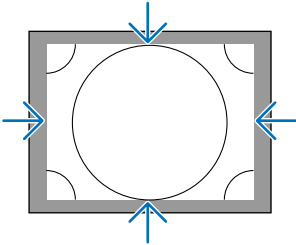

Selecting Overscan Percentage [OVERSCAN]

Select overscan percentage (Auto, 0%, 5% and 10%) for signal.

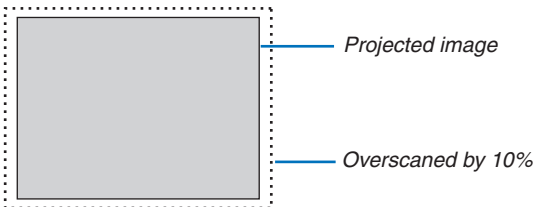

NOTE:

- The [OVERSCAN] item is not available:
- when [NATIVE] is selected for [ASPECT RATIO].

Selecting the Aspect Ratio [ASPECT RATIO]

Use this function to select the screen's vertical:horizontal aspect ratio.

Select the screen type (4:3 screen, 16:9 screen or 16:10 screen) at the screen setting before setting the aspect ratio. (→ page 97)

The projector automatically identifies the signal being input and sets the optimum aspect ratio.

For Computer signal

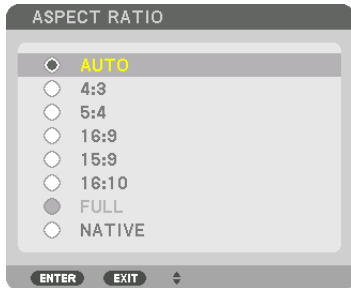

For Component/Video/S-Video signals

When the screen type is set to 4:3

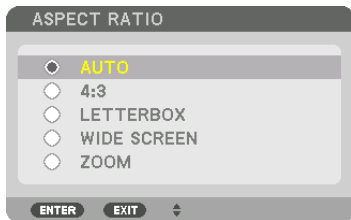

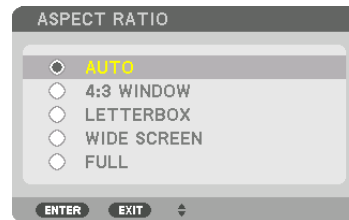

When the screen type is set to 16:9 or 16:10



Resolution	Aspect Ratio	
VGA	640 × 480	4:3
SVGA	800 × 600	4:3
XGA	1024 × 768	4:3
WXGA	1280 × 768	15:9
WXGA	1280 × 800	16:10
HD(FWXGA)	1366 × 768	approx. 16:9
WXGA+	1440 × 900	16:10
SXGA	1280 × 1024	5:4
SXGA+	1400 × 1050	4:3
WXGA++	1600 × 900	16:9
UXGA	1600 × 1200	4:3
WSXGA+	1680 × 1050	16:10
FHD(1080P)	1920 × 1080	16:9
WUXGA	1920 × 1200	16:10
WQXGA	2560 × 1600	16:10

Options	Function
AUTO	The projector will automatically determine the incoming signal and display it in its aspect ratio. The projector may erroneously determine the aspect ratio depending on its signal. If this occurs, select the appropriate aspect ratio from the following.
4:3	The image is displayed in 4:3 aspect ratio.
5:4	The image is displayed in 5:4 aspect ratio
16:9	The image is displayed in 16:9 aspect ratio
15:9	The image is displayed in 15:9 aspect ratio
16:10	The image is displayed in 16:10 aspect ratio

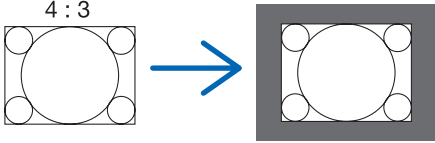
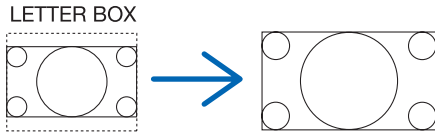
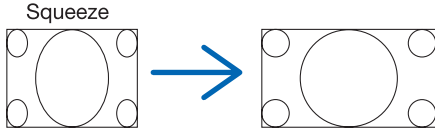
5. Using On-Screen Menu

Options	Function
NATIVE	<p>The projector displays the current image in its true resolution when the incoming computer signal has a lower or higher resolution than the projector's native resolution. (→ page 2)</p> <p>When the incoming computer signal has a higher resolution than the projector's native resolution, the center of an image will be displayed.</p> 
LETTER BOX	<p>The image of a letterbox signal (16:9) is stretched equally in the horizontal and vertical directions to fit the screen.</p> 
WIDE SCREEN	<p>The image of a squeeze signal (16:9) is stretched left and right in 16:9.</p> 
ZOOM	<p>The image of a squeeze signal (16:9) is stretched left and right in 4:3. Parts of the displayed image are cropped at the left and right edges and therefore not visible.</p> 
FULL	Project to full screen size.

TIP:

- Image position can be adjusted vertically using [POSITION] when the [16:9], [15:9], or [16:10] aspect ratios are selected.
- The term "letterbox" refers to a more landscape-oriented image when compared to a 4:3 image, which is the standard aspect ratio for a vide source.
The letterbox signal has aspect ratios with the vista size "1.85:1" or cinema scope size "2.35:1" for movie film.
- The term "squeeze" refers to the compressed image of which aspect ratio is converted from 16:9 to 4:3.

[INPUT RESOLUTION]

The resolution is assigned automatically when the resolution of the input signal from the computer video input terminal or BNC video input terminal (analog RGB) cannot be distinguished.

[VIDEO]

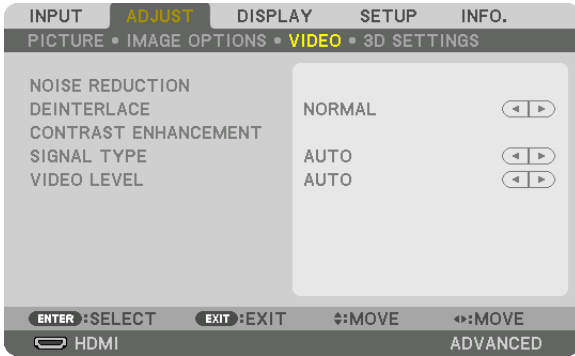

Using Noise Reduction [NOISE REDUCTION]

When projecting a video image, you can use the [NOISE REDUCTION] function to reduce the screen noise (roughness and distortion). This device is equipped with three types of noise reduction functions. Select the function according to the type of noise. Depending on the noise level, the noise reduction effect can be set to [OFF], [LOW], [MEDIUM] or [HIGH]. [NOISE REDUCTION] can be selected for SDTV, HDTV signal and component signal input.

- RANDOM NR Reduces flickering random noise in an image.
- MOSQUITO NR Reduces mosquito noise that appears around the edges of an image during Blu-ray playback.
- BLOCK NR Reduces block noise or mosaic-like patterns by selecting ON.

Selecting Interlaced Progressive Conversion Process Mode [DEINTERLACE]

This function allows you to select an interlaced-to-progressive conversion process for video signals.

- NORMAL..... Automatically distinguishes a moving image from a static image to create a distinct image. Please select [MOVIE] if there are any obvious jitter and noises.
- MOVIE Select when projecting moving images. This is suitable for signals with a lot of jitter and noise.
- STILL Select when projecting static images. The video will flicker when a moving image is projected.

NOTE: This function is not available with RGB signals.

[CONTRAST ENHANCEMENT]

Using the characteristics of the human eye, a picture quality with a sense of contrast and resolution is achieved.

- OFF Suite vision is switched off.
- AUTO Contrast and picture quality are automatically improved using the suite vision function.
- NORMAL..... Adjust the gain manually.

[SIGNAL TYPE]

Selection of RGB and component signals. Normally, this is set to [AUTO]. Please change the setting if the color of the image remains unnatural.

- AUTO Automatically distinguishes RGB and component signals.
- RGB Switches to the RGB input.
- COMPONENT Switches to the component signal input.

[VIDEO LEVEL]

Selection of the video signal level when connecting an external device to the HDMI IN terminal, DisplayPort input terminal, and HDBaseT input terminal of the projector.

- AUTO The video level is switched automatically based on the information from the device outputting the signal.
Depending on the connected device, this setting may not be made properly. In this case, switch to [NORMAL] or "ENHANCED" from the menu and view with the optimum setting.
- NORMAL This disables the enhanced mode.
- ENHANCED This improves the image's contrast, expressing the dark and light sections more dynamically.
- SUPER WHITE The video contrast is improved and the dark areas appear more dynamic.

[3D SETTINGS]

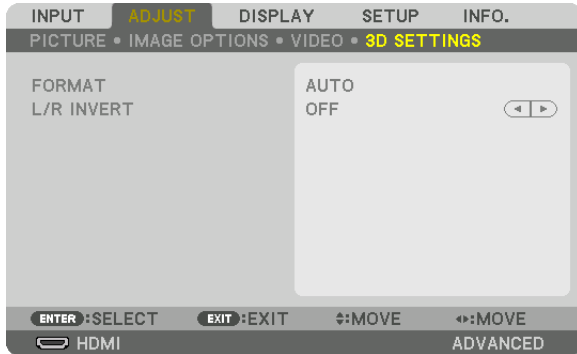

Please refer to “3-9 Projecting 3D videos” (→ page 38) for the operation.

FORMAT

Select the 3D video format (recording / transmission format). Select to match the 3D broadcast and 3D media. Normally, [AUTO] is selected. Please select the 3D input signal format when the 3D detection signal of the format cannot be distinguished.

L/R INVERT

Invert the display order of the left and right videos.

Select [ON] if you feel uncomfortable with the 3D display when [OFF] is selected.

⑥ Menu Descriptions & Functions [DISPLAY] [PIP/PICTURE BY PICTURE]

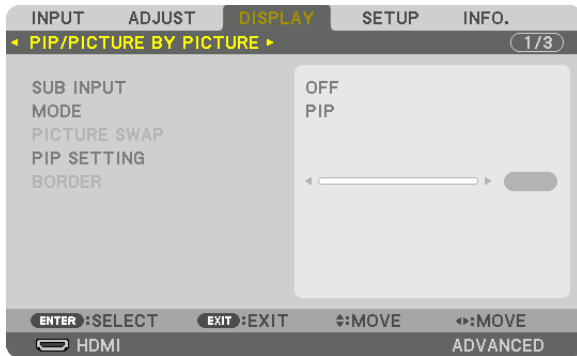

SUB INPUT

Select the input signal to be displayed in the sub-display.

Please refer to “4-2 Displaying Two Pictures at the Same Time” (→ page 52) for details on the operation.

MODE

Select either PIP or PICTURE BY PICTURE when switching to 2-screen display.

PICTURE SWAP

The videos in the main display and sub-display will be switched.

Please refer to “4-2 Displaying Two Pictures at the Same Time” (→ page 54) for details.

PIP SETTING

Select the display position, position adjustment and size of the sub-display in the PIP screen.

START POSITION... Selection of the display position of the sub-display when switching to the PIP screen.

HORIZONTAL POSITION

..... Adjust the display position of the sub-display in the horizontal direction. The respective corners will serve as reference points.

VERTICAL POSITION

..... Adjust the display position of the sub-display in the vertical direction. The respective corners will serve as reference points.

SIZE..... Select the display size of the sub-display.

TIP:

The horizontal position and vertical position are the amount of movement from the reference points. For example, when TOP-LEFT is adjusted, the position is displayed with the same amount of movement even if displayed with other starting positions. The maximum amount of movement is half the resolution of the projector.

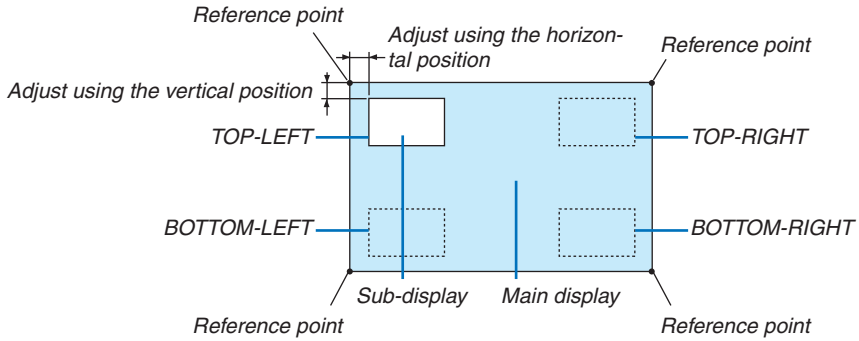

BORDER

Select the display boundary of the main display and sub-display of the [PICTURE BY PICTURE] screen.

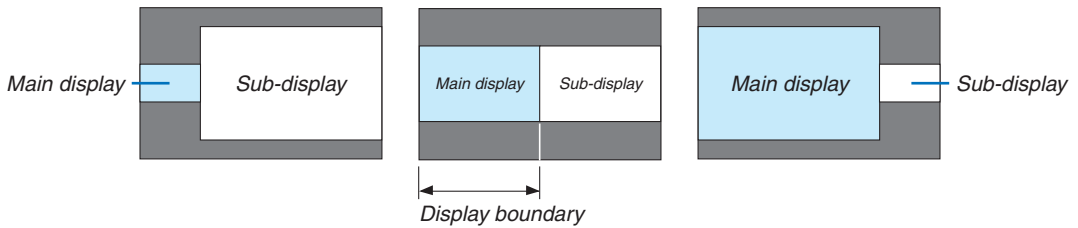

TIP:

- 6 steps can be selected on this projector.

[GEOMETRIC CORRECTION]

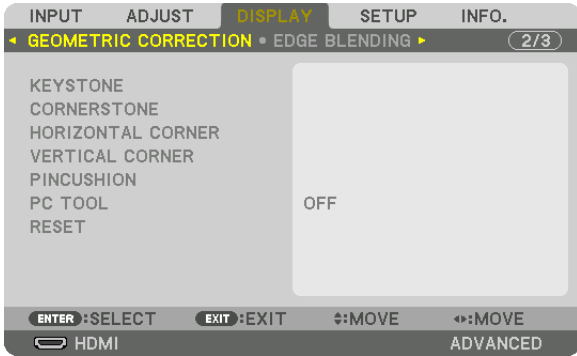

KEYSTONE

Display the trapezoid correction screen and adjust the trapezoidal distortion of the projection screen. To display the [KEYSTONE] screen, select → [DISPLAY] → [GEOMETRIC CORRECTION] → [KEYSTONE] in the on-screen menu. The [GEOMETRIC CORRECTION] screen can also be displayed by pressing the 3D REFORM button on the remote control.

HORIZONTAL..... Adjustments when projecting from a diagonal direction to the screen.

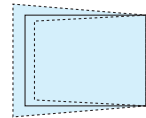

VERTICAL Adjustments when projecting from the top or bottom direction to the screen.

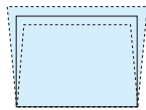

TILT Adjusts the distortion when performing trapezoidal correction with the screen moved in the vertical direction using the lens shift.

THROW RATIO..... Adjusts according to the projection ratio of the optional lens used.

Model name of lens unit	Adjustment range
NP34ZL	9–13
NP35ZL	12–17
NP36ZL	12–17
NP37ZL	15–31

NOTE:

- When power is supplied to the device, the adjustment value of the [KEYSTONE] used previously is retained even if the gradient of the device is changed.
- When clearing the adjustment value of [KEYSTONE], press the 3D REFORM button for 2 or more seconds.
- When setting other [GEOMETRIC CORRECTION] functions, the [KEYSTONE] menu cannot be selected. When performing trapezoidal correction, press the 3D REFORM button for 2 or more seconds to clear the adjustment value of [GEOMETRIC CORRECTION].
- As electrical correction is carried out by [KEYSTONE], the brightness may be reduced or the screen quality may deteriorate sometimes.

CORNERSTONE

Display the 4-point correction screen and adjust the trapezoidal distortion of the projection screen. Please refer to "Correcting Horizontal and Vertical Keystone Distortion [CORNERSTONE]" (→ page 32) for details on the operation.

HORIZONTAL CORNER/VERTICAL CORNER

Distortion correction for corner projection such as wall surfaces.

HORIZONTAL CORNER

..... Performs correction for projection onto a wall lying at an angle to the horizontal direction.

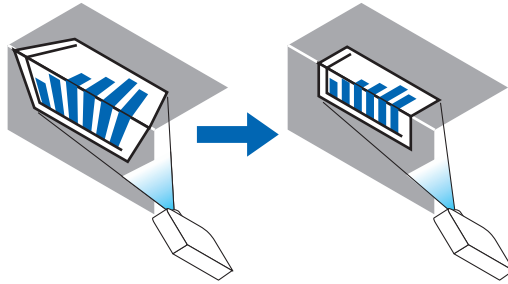

* Reverse angle correction is also possible.

VERTICAL CORNER

..... Performs correction for projection onto a wall lying at an angle to the vertical direction.

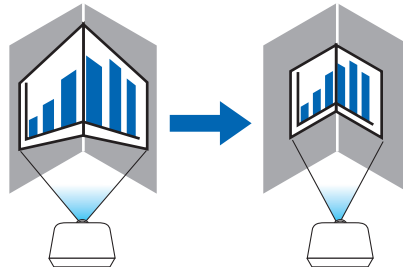

* Reverse angle correction is also possible.

NOTE:

- When the maximum adjustment range is exceeded, distortion adjustment is disabled. Set up the projector at an optimal angle as the deterioration in the image quality increases as the distortion adjustment volume gets larger.
 - Please note that the image will go out of focus due to the difference in the distance between the upper and lower or left and right sides and the center of the screen for projections cutting across corners. Lenses with short focal points are also not recommended for projections cutting across corners as the image will go out of focus.
-

Adjustment method

1. **Align the cursor with the [HORIZONTAL CORNER] or [VERTICAL CORNER] of the [GEOMETRIC CORRECTION] menu and then press the ENTER button.**
 - The adjustment screen will be displayed.
2. **Press the ▼▲◀▶ buttons to align the cursor (yellow box) with the target adjustment point and then press the ENTER button.**
 - The cursor will change into an adjustment point (yellow in color).
3. **Press the ▼▲◀▶ buttons to adjust the corners or sides of the screen and then press the ENTER button.**
 - The adjustment point will go back to being a cursor (yellow box).

Explanation of screen transition

- The adjustment points of the four corners (a, c, f and h in the drawing) will move independently.
- The following adjustment points differ at the [HORIZONTAL CORNER] and [VERTICAL CORNER].
HORIZONTAL CORNER: When Point b in the drawing is moved, and the upper side and Point g are moved, the lower side will move in a parallel manner.

VERTICAL CORNER: When Point d in the drawing is moved, and the left side and Point e are moved, the right side will move in a parallel manner.

[Adjustment points of the [HORIZONTAL CORNER] screen and movement points of the projection screen]

Point b will be displaced in a parallel manner at the same time as Points a, b, c

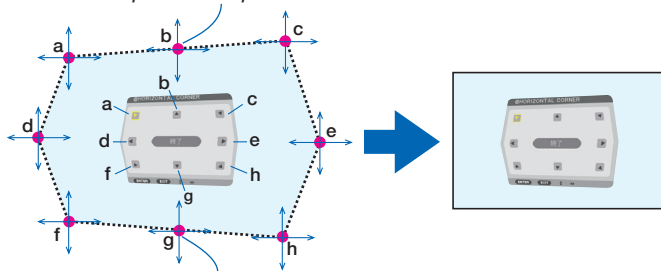

Point g will be displaced in a parallel manner at the same time as Points f, g, h

[Adjustment points of the [VERTICAL CORNER] screen and movement points of the projection screen]

Point d will be displaced in a parallel manner at the same time as Points a, d, f

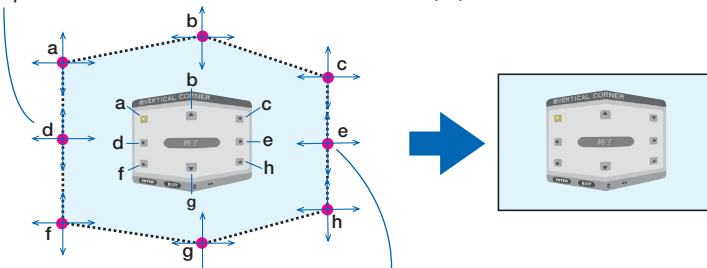

Point e will be displaced in a parallel manner at the same time as Points f, g, h

4. **Start from Step 2 onwards to adjust the other points.**
5. **When the adjustment is completed, press the ▼▲◀▶ buttons to align the cursor with the [EXIT] in the adjustment screen and then press the ENTER button.**
 - Switch to the [GEOMETRIC CORRECTION] menu screen.

PINCUSHION

Adjust the curve distortion of the projection screen.

- TOP..... Adjust the curve distortion of the upper edge of the projection screen.
- BOTTOM..... Adjust the curve distortion of the lower edge of the projection screen.
- LEFT Adjust the curve distortion of the left edge of the projection screen.
- RIGHT..... Adjust the curve distortion of the right edge of the projection screen.

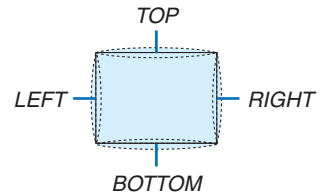

PC TOOL (For future support)

Recall the geometric correction data that is registered in the projector beforehand. There are three types of registered data.

NOTE:

- *KEYSTONE, CORNERSTONE, and PINCUSHION cannot be selected when setting the geometric correction using a PC tool.*
 - *To clear the [GEOMETRIC CORRECTION] data that has been set up, press the 3D REFORM button for 2 or more seconds.*
 - *As electrical correction is carried out in geometric correction, the brightness may be affected and the picture quality may be degraded.*
-

RESET

Reset the adjustment value that has been set up in GEOMETRIC CORRECTION (return to the initial value).

[EDGE BLENDING]

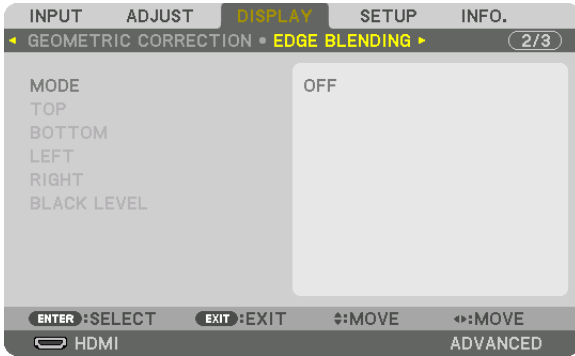

This adjusts the edges (boundaries) of the projection screen when projecting high resolution videos using a combination of several projectors in the up, down, left and right positions.

MODE

This enables or disables the EDGE BLENDING function. When MODE is set to ON, the TOP, BOTTOM, LEFT, RIGHT and BLACK LEVEL settings can be adjusted.

TOP/BOTTOM/LEFT/RIGHT

This selects the EDGE BLENDING locations on the left, right, top and bottom on the screen. The following settings can be adjusted when an item is selected. (→ page 57)

- CONTROL Enable TOP, BOTTOM, LEFT and RIGHT functions.
- MARKER..... Set whether to display marker or not when adjusting the range and display position. When turned on, a magenta marker for adjusting the range adjustment and a green marker for adjusting the display position will be displayed.
- RANGE..... Adjust the range (width) of the edge blending.
- POSITION Adjust the display position of the edge blending.

BLACK LEVEL

Divide the screen into nine parts and keep the black level uniform for each projector. The nine divisions screens are TOP-LEFT, TOP-CENTER, TOP-RIGHT, CENTER-LEFT, CENTER, CENTER-RIGHT, BOTTOM-LEFT, BOTTOM-CENTER and BOTTOM-RIGHT. (→ page 60)

[MULTI SCREEN]



WHITE BALANCE

This adjusts the white balance for each projector when projecting using a combination of several projectors. This can be adjusted when [MODE] is set to [ON].

- BRIGHTNESS W, BRIGHTNESS R, BRIGHTNESS G, BRIGHTNESS B
..... Adjusting the black color of the video.
- CONTRAST W, CONTRAST R, CONTRAST G, CONTRAST B
..... Adjusting the white color of the video.

PICTURE SETTING

This sets the division condition when projecting using a combination of several projectors. Please refer to “4. Multi-Screen Projection” (→ page 48) for details.

MODE	OFF	Use the projector in a standalone state.
	ZOOM	This adjusts the position and width of the video area that you wish to divide. The edge blending width will also be automatically set to that width.
	TILING	This assigns the divided screens to the projectors. The edge blending function will also be set automatically.
ZOOM	HORIZONTAL ZOOM	This magnifies the video area in the horizontal direction.
	VERTICAL ZOOM	This magnifies the video area in the vertical direction.
	HORIZONTAL POSITION	This shifts the video area in the horizontal direction.
	VERTICAL POSITION	This shifts the video area in the vertical direction.
TILING	WIDTH	This selects the number of projectors to be arranged horizontally.
	HEIGHT	This selects the number of projectors to be arranged vertically.
	HORIZONTAL POSITION	This selects the position of the projector starting from the left among those arranged horizontally.
	VERTICAL POSITION	This selects the position of the projector starting from the top among those arranged vertically.

Conditions for using tiling

- All the projectors need to fulfil the following conditions.
 - The panel size must be the same
 - The projection screen size must be the same
 - The left and right ends or top and bottom ends of the projection screen must be consistent.
 - The settings for the left and right edges of the edge blending are the same
 - The settings for the top and bottom edges of the edge blending are the same

If the tiling conditions are satisfied, the video screen of the projector at each installation position will be automatically extracted and projected.

If the tiling conditions are not satisfied, adjust the video screen of the projector at each installation position using the zoom function.

- Assign a unique control ID to each projector.
- Set the “Color Setting” and “DeepColor Setting” on your Blu-ray player or computer to “Auto”. Refer to the owner’s manual accompanying your Blu-ray player or computer for more information.

Connect the HDMI output of your Blu-ray player or computer to the first projector. Then connect to the HDMI IN input terminal of the second and subsequent tiled projectors.

Tiling setting example) Number of horizontal units = 2, Number of vertical units = 2

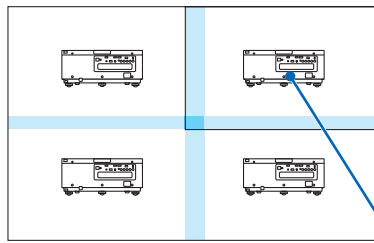

*Horizontal order = Second unit
Vertical order = First unit*

7 Menu Descriptions & Functions [SETUP]

[MENU]



Selecting Menu Language [LANGUAGE]

You can choose one of 29 languages for on-screen instructions.

NOTE: Your setting will not be affected even when [RESET] is done from the menu.

Selecting Menu Color [COLOR SELECT]

You can choose between two options for menu color: COLOR and MONOCHROME.

Turning On / Off Source Display [INPUT DISPLAY]

This option turns on or off input name display such as HDMI, DisplayPort, BNC, BNC(CV), BNC(Y/C), COMPUTER, HDBaseT to be displayed on the top right of the screen.

Turning messages on and off [MESSAGE DISPLAY]

This option selects whether or not to display projector messages at the bottom of the projected image. Even when "OFF" is selected, the security lock warning is displayed. The security lock warning turns off when the security lock is canceled.

Turning ON/OFF Control ID [ID DISPLAY]

ID DISPLAY This option turns on or off the ID number which is displayed when the ID SET button on the remote control is pressed. (→ page 105)

[3D CAUTION MESSAGE]

This selects whether to display a caution message or not when switching to a 3D video. The default condition when shipped from the factory is ON.

OFF The 3D caution message screen will not be displayed.

ON The 3D caution message screen will be displayed when switching to a 3D video. Press the ENTER button to cancel the message.

- The message will disappear automatically after 60 seconds or when other buttons are pressed. If it disappears automatically, the 3D caution message will be displayed again when switching to a 3D video.

Selecting Menu Display Time [DISPLAY TIME]

This option allows you to select how long the projector waits after the last touch of a button to turn off the menu. The preset choices are [MANUAL], [AUTO 5 SEC], [AUTO 15 SEC], and [AUTO 45 SEC]. The [AUTO 45 SEC] is the factory preset.

[INSTALLATION]

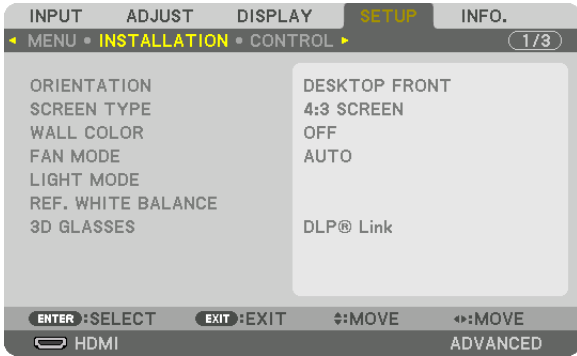

Selecting Projector Orientation [ORIENTATION]

This reorients your image for your type of projection. The options are: desktop front projection, ceiling rear projection, desktop rear projection, and ceiling front projection.

NOTE:

- Please consult the dealer if you require special installation services e.g. when mounting the projector to a ceiling. Never install the projector on your own. This may result in the projector falling down and causing injury to people.

AUTO This automatically detects and projects the DESKTOP FRONT and CEILING FRONT.

NOTE:

- The DESKTOP REAR and CEILING REAR will not be detected. Please select manually.

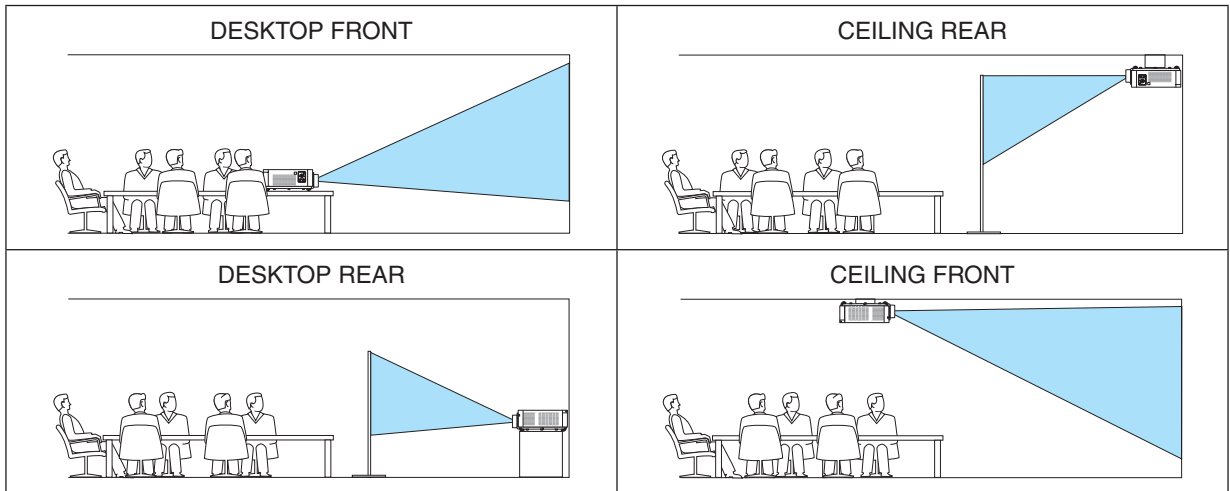

TIP:

- Check whether the automatic DESKTOP FRONT is installed within ± 10 degrees for floor installation and whether the CEILING FRONT is within ± 10 degrees for ceiling installation. Select manually when the projection screen is inverted.

Selecting Aspect Ratio and Position for Screen [SCREEN TYPE]

Screen type	Sets the aspect ratio of the projection screen.	
	FREE	The ratio of the liquid crystal panel is selected. Select this when projecting multi-screen and 17:9 screen (2K).
	4:3 screen	For a screen with a 4:3 aspect ratio
	16:9 screen	For a screen with a 16:9 aspect ratio
	16:10 screen	For a screen with a 16:10 aspect ratio

NOTE:

- After changing the screen type, check the setting of [ASPECT RATIO] in the menu. (→ page 80)

Using the Wall Color Correction [WALL COLOR]

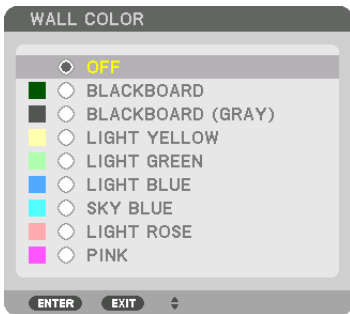

This function allows for quick adaptive color correction in applications where the screen material is not white.

Selecting Fan Mode [FAN MODE]

Fan Mode is used to set the speed of the internal cooling fan.

MODE Select three modes for fan speed: AUTO and HIGH.

AUTO: The built-in fans automatically run at a variable speed according to the internal temperature.

HIGH: The built-in fans run at a high speed. Select this option when using the projector at altitudes approximately 2500 feet/760 meters or higher.

NOTE:

- Make sure the speed is set to [HIGH] when you are using this device continuously for several days.
- Set [FAN MODE] to [HIGH] when using the projector at altitudes approximately 2500 feet/760 meters or higher.
- Using the projector at altitudes approximately 2500 feet/760 meters or higher without setting to [HIGH] can cause the projector to overheat and the protector could shut down. If this happens, wait a couple minutes and turn on the projector.
- Using the projector at altitudes approximately 2500 feet/760 meters or higher can shorten the life of optical components such as the light module.
- Your setting will not be affected even when [RESET] is done from the menu.

TIP:

- When [HIGH] is selected for [FAN MODE], a symbol icon  will be displayed at the bottom of the menu.

[LIGHT MODE]

Adjusting the energy savings settings and the brightness of each projector in multi-screen projection. For energy savings settings, see page 29 “3-6. Changing LIGHT MODE/Checking Energy-Saving Effect Using LIGHT MODE [LIGHT MODE]”.

LIGHT MODE	NORMAL	The light module luminance (brightness) will become 100% and the screen will turn bright.
	ECO1	By controlling the brightness and fan speed according to the selected setting, energy can be saved and motion noise and the power consumption can be lowered. Can be selected when [CONSTANT BRIGHTNESS] mode is set to [OFF].
	ECO2	
CONSTANT BRIGHTNESS	OFF	[CONSTANT BRIGHTNESS] mode will be canceled.
	ON	Maintains the brightness that is in effect at the time [ON] is selected. Unless [OFF] is selected, the same settings will remain in effect even when the projector is turned off. <ul style="list-style-type: none"> To re-adjust the brightness, first turn this setting OFF before making further adjustments. NOTE: <ul style="list-style-type: none"> [CONSTANT BRIGHTNESS] mode is a function used to maintain the brightness at a constant level. Color will not be fixed.
ADJUST		Brightness can be adjusted in 1% increments from 20 to 100%. When several projectors are used for multi-screen projection, the brightness can be adjusted individually on each projector. The adjustment is effective when [NORMAL] [LIGHT MODE] is selected and [CONSTANT BRIGHTNESS] mode is turned [OFF].

TIP:

- Brightness normally decreases with use, but by selecting [CONSTANT BRIGHTNESS] mode, sensors inside the projector detect brightness and automatically adjust the output, thereby maintaining a constant brightness throughout the life of the light module. However, if output is already at its maximum, brightness will decrease with use.
For this reason, when using multi-screen projection, it is recommended to adjust the brightness to a slightly lower level, then setting the [CONSTANT BRIGHTNESS] mode to [ON].

[REF. WHITE BALANCE]

This feature allows you to adjust the white balance for all signals.
The white and black levels of the signal are adjusted for optimum color reproduction.

CONTRAST R/CONTRAST G/CONTRAST B
..... These adjust the picture's white color.
BRIGHTNESS R/BRIGHTNESS G/BRIGHTNESS B
..... These adjust the picture's black color.

3D GLASSES

Select 3D glasses method.

- DLP® Link..... Select when using DLP® Link type 3D glasses.
- OTHERS..... Select when using a non 3D emitter type glasses. It is required to connect the 3D emitter to the 3D SYNC terminal of this projector. Please refer to page 40 about recommended items of 3D glasses and 3D emitter for this projector.

[CONTROL]

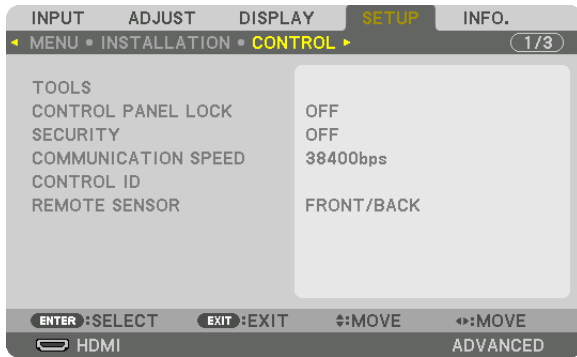

TOOLS

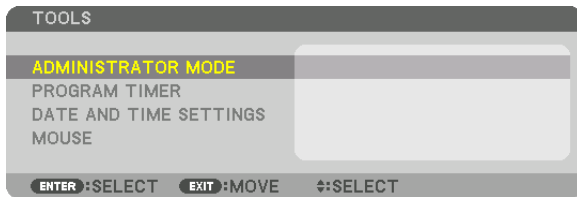

ADMINISTRATOR MODE

This allows you to select MENU MODE, save settings, and set a password for the administrator mode.

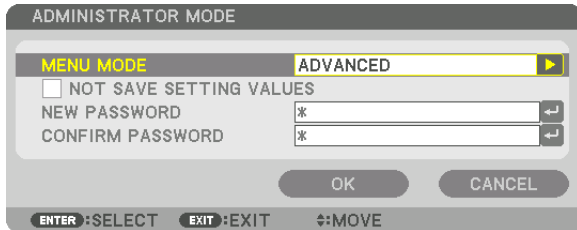

MENU MODE	Select either [BASIC] or [ADVANCED] menu. (→ page 64)	—
NOT SAVE SETTING VALUES	Placing a check mark will not save your projector settings. Clear this check box to save your projector settings.	—
NEW PASSWORD/ CONFIRM PASS- WORD	Assign a password for the administrator mode.	Up to 10 alphanumeric characters

PROGRAM TIMER

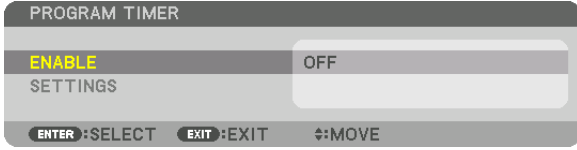

This option turns on/standby the projector and changes video signals, and selects ECO mode automatically at a specified time.

NOTE:

- Before using [PROGRAM TIMER], make sure that the [DATE AND TIME] feature is set. (→ page 103)
 Make sure that the projector is in the standby condition with the POWER cord connected.
 The projector has a built-in clock. The clock will keep working for about two weeks after the main power is turned off. If the main power is not supplied to the projector for two weeks or more, it requires to set [DATE AND TIME SETTINGS] feature again.

Setting a new program timer

1. On the PROGRAM TIMER screen, use the ▲ or ▼ button to select [SETTINGS] and press the ENTER button.

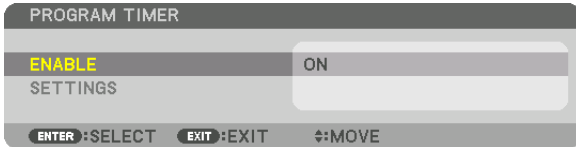

The [PROGRAM LIST] screen will be displayed.

2. Select a blank program number and press the ENTER button.

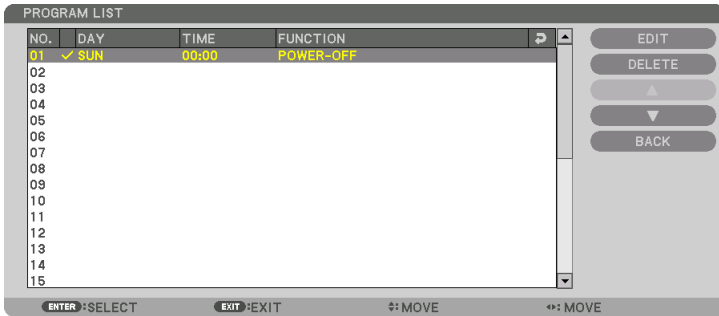

The [EDIT] screen will be displayed.

3. Make settings for each item as required.

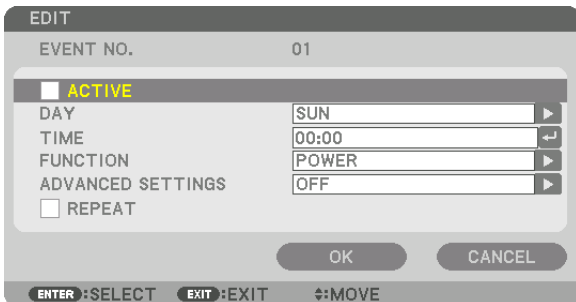

ACTIVE Place a check mark to enable the program.

DAY..... Select days of the week for the program timer. To execute the program from Monday to Friday, select [MON-FRI]. To execute the program in everyday basis, select [EVERYDAY].

5. Using On-Screen Menu

TIME Set the time to execute the program. Enter time in 24-hour format.

FUNCTION Select a function to be executed. Selecting [POWER] will allow you to turn on or off the projector by setting [ADVANCED SETTINGS]. Selecting [INPUT] will allow you to select a video source by setting [ADVANCED SETTINGS]. Selecting [LIGHT MODE] will allow you to select [LIGHT MODE] by setting [ADVANCED SETTINGS].

ADVANCED SETTINGS

..... Select power on/off, a type of video source, or LIGHT MODE for the selected item in [FUNCTION].

REPEAT..... Place a check mark to repeat the program continuing basis. To use the program this week only, clear the check mark.

4. Select [OK] and press the ENTER button.

This will complete the settings.

You will be returned to the [PROGRAM LIST] screen.

5. Select [BACK] and press the ENTER button.

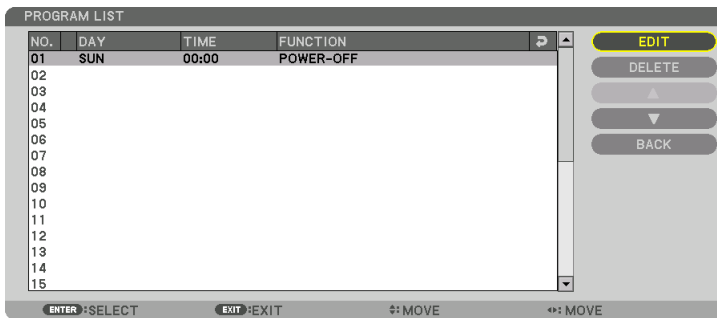

You will be returned to the [PROGRAM TIMER] screen.

6. Select [OK] and press the ENTER button.

You will be returned to the [TOOLS] screen.

NOTE:

- Up to 30 different timer settings can be programmed.
- When [PROGRAM TIMER] is turned on, the [STANDBY MODE] setting is ignored.
- The Program Timer is executed on a set time basis, not in a program basis.
- Once the program not marked with a check in [REPEAT] has been executed, the check mark in the [ACTIVE] check box will be cleared automatically and the program will be disabled.
- When the on-time and the off-time set for the same time, the off-time setting will take preference.
- Two different sources are set for the same time, the larger program number will take preference.
- The on-time setting will not be executed while the cooling fans are running or an error is occurring.
- If the off-time setting is expired under the condition in which the power off is not possible, the off-timer setting will not be executed until the power off becomes possible.
- Programs not marked with a check mark in [ACTIVE] of the [EDIT] screen will not be executed even if the Program Timer is enabled.
- When the projector is turned on by using the program timer and if you want to turn off the projector, set the off-time or do it manually so as not to leave the projector on for a long period of time.

Activating the program timer

1. Select **[ENABLE]** on the **[PROGRAM TIMER]** screen and press the **ENTER** button.

The selection screen will be displayed.

2. Press the **▼** button to align the cursor with **[ON]** and then press the **ENTER** button.

Return to the [PROGRAM TIMER] screen.

NOTE:

- When the effective settings of the **[PROGRAM TIMER]** have not been set to **[ON]**, the program will not be executed even if the **[ACTIVE]** items in the program list have been ticked.
 - Even when the effective settings of the **[PROGRAM TIMER]** are set to **[ON]**, the **[PROGRAM TIMER]** will not work until the **[PROGRAM TIMER]** screen is closed.
-

Changing the programmed settings

1. On the **[PROGRAM LIST]** screen, select a program you want to edit and press the **ENTER** button.

2. Change the settings on the **[EDIT]** screen.

3. Select **[OK]** and press the **ENTER** button.

The programmed settings will be changed.

You will be returned to the [PROGRAM LIST] screen.

Changing the order of programs

1. On the **[PROGRAM LIST]** screen, select a program whose order you want to change and press the **►** button.

2. Press the **▼** button to select **▲** or **▼**.

3. Press the **ENTER** button a few times to select a row to which you wish to move the program.

The order of the programs will be changed.

Deleting the programs

1. On the **[PROGRAM LIST]** screen, select a program number you want to delete and press the **►** button.

2. Press the **▼** button to select **[DELETE]**.

3. Press the **ENTER** button.

The confirmation screen will be displayed.

4. Select **[YES]** and press the **ENTER** button.

The program will be deleted.

This will complete deleting the program.

DATE AND TIME SETTINGS

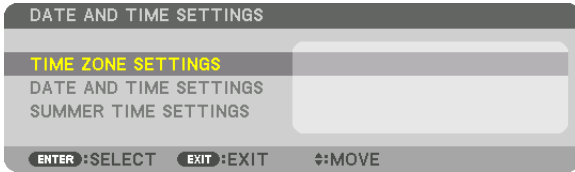

You can set the current time, month, date, and year.

NOTE: The projector has a built-in clock. The clock will keep working for about 2 weeks after the main power is turned off. If the main power is off for 2 weeks or more, the built-in clock will cease. If the built-in clock ceases, set the date and time again. The built-in clock will not cease while in the standby mode.

TIME ZONE SETTINGS..... Select your time zone.

DATE AND TIME SETTINGS Set your current date (MM/DD/YYYY) and time (HH:MM).

INTERNET TIME SERVER If you place a check mark, the projector's built-in clock will be synchronized with an Internet time server in every 24 hours and at the time of projector's startup.

UPDATE Synchronizes the projector's built-in clock immediately. The UPDATE button is not available unless the INTERNET TIME SERVER check box is turned on.

SUMMER TIME SETTINGS If you place a check mark, the clock for daylight saving will be enabled.

[MOUSE]

This function cannot be used in this device. It is used for future expansion purposes only.

Disabling the Cabinet Buttons [CONTROL PANEL LOCK]

This option turns on or off the CONTROL PANEL LOCK function.

NOTE:

- *How to cancel the [CONTROL PANEL LOCK]*
When the [CONTROL PANEL LOCK] is set to [ON], press the SOURCE button on the main body for about 10 seconds to cancel the [CONTROL PANEL LOCK].
-

TIP:

- *When the [CONTROL PANEL LOCK] is turned on, a key lock icon [] will be displayed at the bottom right of the menu.*
- *This CONTROL PANEL LOCK does not affect the remote control functions.*

Enabling Security [SECURITY]

This feature turns on or off the SECURITY function.

Unless the correct keyword is entered, the projector cannot project an image. (→ page 35)

NOTE: Your setting will not be affected even when [RESET] is done from the menu.

Selecting Communication Speed [COMMUNICATION SPEED]

This feature sets the baud rate of the PC Control port (D-Sub 9P). It supports data rates from 4800 to 115200 bps. The default is 38400 bps. Select the appropriate baud rate for your equipment to be connected (depending on the equipment, a lower baud rate may be recommended for long cable runs).

NOTE:

- *Select [38400bps] or less when using the supplied software programs.*
 - *Your selected communication speed will not be affected even when [RESET] is done from the menu.*
-

Setting ID to the Projector [CONTROL ID]

You can operate multiple projectors separately and independently with the single remote control that has the CONTROL ID function. If you assign the same ID to all the projectors, you can conveniently operate all the projectors together using the single remote control. To do so, you have to assign an ID number to each projector.

CONTROL ID NUMBER..... Select a number from 1 to 254 you wish to assign to your projector.

CONTROL ID..... Select [OFF] to turn off the CONTROL ID setting and select [ON] to turn on the CONTROL ID setting.

NOTE:

- When [ON] is selected for [CONTROL ID], the projector cannot be operated by using the remote control that does not support the CONTROL ID function. (In this case the buttons on the projector cabinet can be used.)
- Your setting will not be affected even when [RESET] is done from the menu.
- Pressing and holding the ENTER button on the projector cabinet for 10 seconds will display the menu for canceling the Control ID.

Assigning or Changing the Control ID

1. Turn on the projector.

2. Press the ID SET button on the remote control.

The CONTROL ID screen will be displayed.



If the projector can be operated with the current remote control ID, the [ACTIVE] will be displayed. If the projector cannot be operated with the current remote control ID, the [INACTIVE] will be displayed. To operate the inactive projector, assign the control ID used for the projector by using the following procedure (Step 3).

3. Press one of numeric keypad buttons while pressing and holding the ID SET button on the remote control.

Example:

To assign "3", press the "3" button on the remote control.

No ID means that all the projectors can be operated together with a single remote control. To set "No ID", enter "000" or press the CLEAR button.

TIP: The range of IDs is from 1 to 254.

4. Release the ID SET button.

The updated CONTROL ID screen will be displayed.

NOTE:

- The IDs can be cleared in a few days after the batteries are run down or removed.
- If one of buttons of the remote control without batteries is pressed accidentally, current specified ID will be cleared.

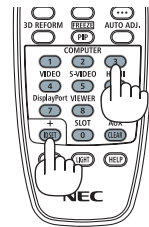

Turning On or Off Remote Sensor [REMOTE SENSOR]

This option determines which remote sensor on the projector is enabled in wireless mode. The options are: FRONT/BACK, FRONT, BACK, and HDBaseT.

NOTE:

- *The remote control of the projector will not be able to receive signals if the power supply of the HDBaseT transmission device connected to the projector is switched on when this has been set to "HDBaseT".*
-

TIP:

- *If the remote control system does not function when direct sunlight or strong illumination strikes the remote control sensor of the projector, change another option.*

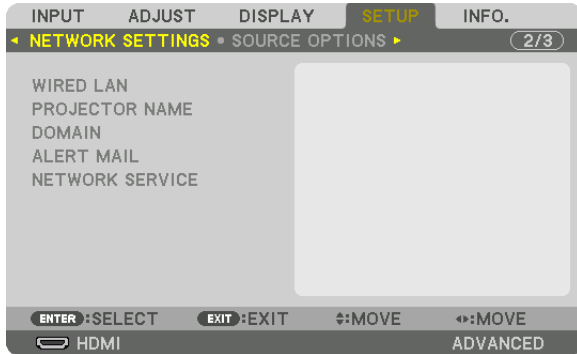
[NETWORK SETTINGS]*Important:*

- Consult with your network administrator about these settings.
- When using a wired LAN connection, connect a LAN cable (Ethernet cable) to the LAN port (RJ-45) of the projector. (→ page 133)

TIP: The network settings you make will not be affected even when [RESET] is done from the menu.

Hints on How to Set Up LAN Connection**To set up the projector for a LAN connection:**

Select [WIRED LAN] → [PROFILES] → [PROFILE 1] or [PROFILE 2].

Two settings can be set for wired LAN.

Next turn on or off for [DHCP], [IP ADDRESS], [SUBNET MASK], and [GATEWAY] and select [OK] and press the ENTER button. (→ page 108)

To recall LAN settings stored in the profile number:

Select [PROFILE 1] or [PROFILE 2] for wired LAN, and then select [OK] and press the ENTER button. (→ page 108)

To connect a DHCP server:

Turn on [DHCP] for wired LAN. Select [ON] and press the ENTER button. To specify IP address without using the DHCP server, turn off [DHCP]. (→ page 108)

To receive error messages via e-mail:

Select [ALERT MAIL], and set [SENDER'S ADDRESS], [SMTP SERVER NAME], and [RECIPIENT'S ADDRESS]. Last, select [OK] and press the ENTER button. (→ page 110)

WIRED LAN

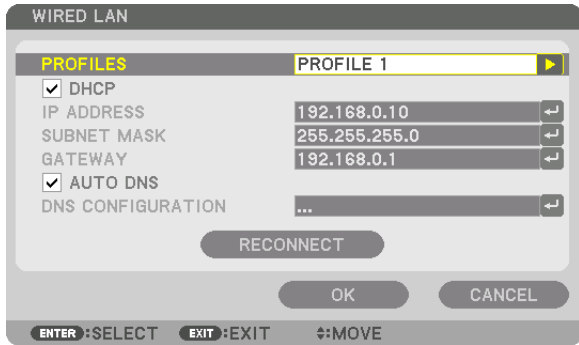

PROFILES	<ul style="list-style-type: none"> The settings for using the built-in Ethernet/HDBaseT port in the projector can be recorded in the projector memory in two ways. Select [PROFILE 1] or [PROFILE 2] and then do settings for [DHCP] and the other options. After doing this, select [OK] and press the ENTER button. This will store your settings in memory. To recall the settings from memory: After selecting [PROFILE 1] or [PROFILE 2] from the [PROFILES] list. Select [OK] and press the ENTER button. Select [DISABLE] when not connecting to a wired LAN 	—
DHCP	Place a check mark to automatically assign an IP address to the projector from your DHCP server. Clear this check box to register the IP address or subnet mask number obtained from your network administrator.	—
IP ADDRESS	Set your IP address of the network connected to the projector when [DHCP] is turned off.	Up to 12 numeric characters
SUBNET MASK	Set your subnet mask number of the network connected to the projector when [DHCP] is turned off.	Up to 12 numeric characters
GATEWAY	Set the default gateway of the network connected to the projector when [DHCP] is turned off.	Up to 12 numeric characters
AUTO DNS	Place a check mark to automatically assign the IP address of your DNS server connected to the projector from your DHCP server. Clear this check box to set the IP address of your DNS server connected to the projector.	Up to 12 numeric characters
DNS CONFIGURATION	Set the IP address of your DNS server on the network connected to the projector when [AUTO DNS] is cleared.	Up to 12 numeric characters
RECONNECT	Retry to connect the projector to a network. Try this if you have changed [PROFILES].	—

PROJECTOR NAME

PROJECTOR NAME	Set a unique projector name.	Up to 16 alphanumeric characters and symbols
----------------	------------------------------	--

DOMAIN

Set a host name and domain name of the projector.

HOST NAME	Set a host name of the projector.	Up to 15 alphanumeric characters
DOMAIN NAME	Set a domain name of the projector.	Up to 60 alphanumeric characters

ALERT MAIL

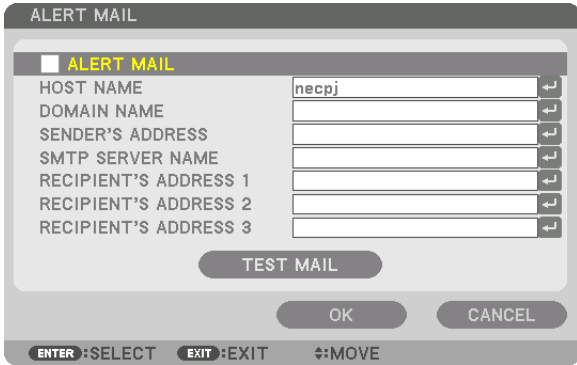

ALERT MAIL	<p>This option will notify your computer of error messages via e-mail when using wireless or wired LAN. Placing a checkmark will turn on the Alert Mail feature. Clearing a checkmark will turn off the Alert Mail feature.</p> <p>Sample of a message to be sent from the projector:</p> <div style="border: 1px solid black; padding: 5px;"> <p>Subject: [Projector] Projector Information THE COOLING FAN HAS STOPPED. [INFORMATION] PROJECTOR NAME: PX602UL Series LIGHT HOURS USED: 0000[H]</p> </div>	—
HOST NAME	Type in a host name.	Up to 15 alphanumeric characters
DOMAIN NAME	Type in a domain name of the network connected to the projector.	Up to 60 alphanumeric characters
SENDER'S ADDRESS	Specify the sender's address.	Up to 60 alphanumeric characters and symbols
SMTP SERVER NAME	Type in the SMTP server name to be connected to the projector.	Up to 60 alphanumeric characters
RECIPIENT'S ADDRESS 1, 2, 3	Type in your recipient's address.	Up to 60 alphanumeric characters and symbols
TEST MAIL	<p>Send a test mail to check if your settings are correct.</p> <p><i>NOTE:</i></p> <ul style="list-style-type: none"> • If you entered an incorrect address in a test, you may not receive an Alert mail. Should this happen, check if the Recipient's Address is correctly set. • Unless any one of the [SENDER'S ADDRESS], [SMTP SERVER'S NAME] or [RECIPIENT'S ADDRESS 1-3] is selected, [TEST MAIL] is not available. • Be sure to highlight [OK] and press the ENTER button before executing [TEST MAIL]. 	—

NETWORK SERVICE

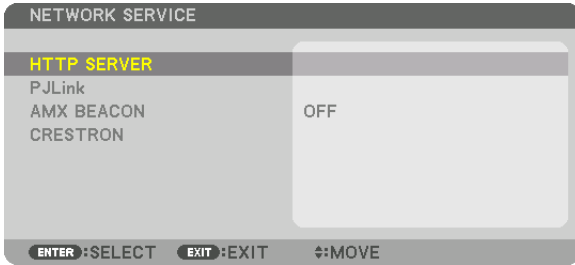

HTTP SERVER	Set a password for your HTTP server.	Up to 10 alphanumeric characters
PJLink	<p>This option allows you to set a password when you use the PJLink feature.</p> <hr/> <p>NOTE:</p> <ul style="list-style-type: none"> • Do not forget your password. However, if you forget your password, consult with your dealer. • What is PJLink? PJLink is a standardization of protocol used for controlling projectors of different manufacturers. This standard protocol is established by Japan Business Machine and Information System Industries Association (JBMA) in 2005. The projector supports all the commands of PJLink Class 1. • Setting of PJLink will not be affected even when [RESET] is done from the menu. 	Up to 32 alphanumeric characters
AMX BEACON	<p>Turn on or off for detection from AMX Device Discovery when connecting to the network supported by AMX's NetLinx control system.</p> <p>TIP: When using a device that supports AMX Device Discovery, all AMX NetLinx control system will recognize the device and download the appropriate Device Discovery Module from an AMX server.</p> <p>Placing a checkmark will enable detecting the projector from AMX Device Discovery. Clearing a checkmark will disable detecting the projector from AMX Device Discovery.</p>	—
CRESTRON	<p>ROOMVIEW: Turn on or off when controlling the projector from your PC. CRESTRON CONTROL: Turn on or off when controlling the projector from your controller.</p> <ul style="list-style-type: none"> • CONTROLLER IP ADDRESS: Enter your IP address of CRESTRON SERVER. • IP ID: Enter your IP ID of CRESTRON SERVER. 	Up to 12 numeric characters

TIP: The CRESTRON settings are required only for use with CRESTRON ROOMVIEW. For more information, visit <http://www.crestron.com>

[SOURCE OPTIONS]

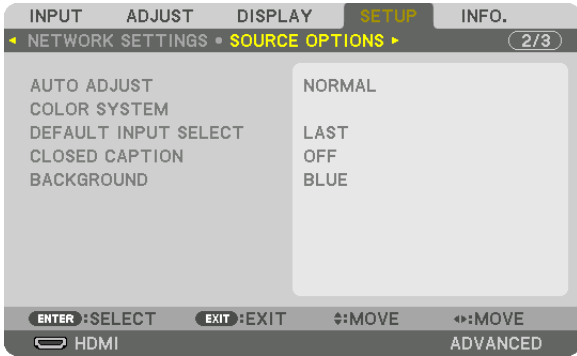

Setting Auto Adjust [AUTO ADJUST]

This feature sets the Auto Adjust mode so that the computer signal can be automatically or manually adjusted for noise and stability. You can automatically make adjustment in two ways: [NORMAL] and [FINE].

- OFF The computer signal will not be automatically adjusted. You can manually optimize the computer signal.
- NORMAL..... Default setting. The computer signal will be automatically adjusted. Normally select this option.
- FINE..... Select this option if fine adjustment is needed. It takes more time to switch to the source than when [NORMAL] is selected.

TIP:

- The default setting when shipped from the factory is [NORMAL].
- When the AUTO ADJ. button is pressed, the same [FINE] adjustment is carried out.

[COLOR SYSTEM]

This feature allows you to select the TV video signal, which differs from country to country (NTSC, PAL, etc.). This is set to [AUTO] by factory default. Set this if the projector cannot identify the signal automatically.

Selecting Default Source [DEFAULT INPUT SELECT]

You can set the projector to default to any one of its inputs each time the projector is turned on.

- LAST Set the projector to default to the previous or last active input each time the projector is turned on.
- AUTO Search for an active source in order of HDMI → DisplayPort → BNC → BNC(CV) → BNC(Y/C) → COMPUTER → HDBaseT → SLOT and displays the first found source.
- HDMI Display the digital source from the HDMI IN terminal every time the projector is turned on.
- DisplayPort..... Display the digital source from the DisplayPort IN terminal every time the projector is turned on.
- BNC Project the input signal from the BNC input terminal
- BNC(CV) Project the input signal from the BNC(CV) input terminal.
- BNC(Y/C) Project the input signal from the BNC(Y/C) input terminal.
- COMPUTER Display the computer signal from the COMPUTER 1 IN terminal every time the projector is turned on.
- HDBaseT..... Project the HDBaseT or WIRED LAN signal.
- SLOT..... Project the picture via the optional board (sold separately) inserted into the SLOT.

Setting Closed Caption [CLOSED CAPTION]

This option sets several closed caption modes that allow text to be superimposed on the projected image of Video or S-Video.

The subtitles and text will be displayed a short while after the on-screen menu disappears.

OFF This exits the closed caption mode.

CAPTION 1-4 Text is superimposed.

TEXT 1-4..... Text is displayed.

Selecting a Color or Logo for Background [BACKGROUND]

Use this feature to display a blue/black screen or logo when no signal is available. The default background is [BLUE].

NOTE:

- *Even when the background logo is selected, if two pictures are displayed in [PIP/PICTURE BY PICTURE] mode, the blue background is displayed without the logo when there is no signal.*
-

[POWER OPTIONS]

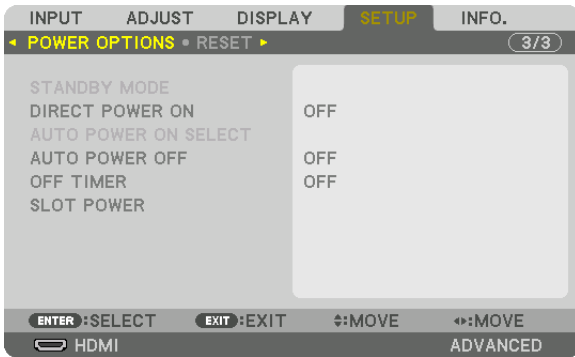

Selecting Power-saving in [STANDBY MODE]

Setting the power consumption in the standby mode.

- NORMAL..... In the standby mode, the power consumption of the projector is 0.5 W.
 In the standby mode, the POWER indicator lights up in red while the STATUS indicator will go off.
 - When set to [NORMAL], the following terminals and functions will be disabled. HDMI OUT terminals, Ethernet/HDBaseT port, LAN function, mail notification function

NETWORK STANDBY

- Compared to [NORMAL], the power consumption in the standby mode is higher but power can be supplied to the projector using a wired LAN.
 In the standby mode, the power indicator will light up in orange while the status indicator will be turned off.

Important:

- When [NETWORK STANDBY] is selected, [AUTO POWER OFF] will turn grey in color and be disabled and [0:15] will be selected automatically.
- In the following conditions, the [STANDBY MODE] setting will be disabled and the projector will go into the sleep mode. In the sleep mode, the fans in the projector rotate for the purpose of interior parts protection.
 - * Sleep mode refers to the mode whereby the functional restrictions due to the [STANDBY MODE] setting are removed.
 - When [ENABLE] is selected under [NETWORK SERVICE] → [AMX BEACON]
 - When [HDBaseT] is selected under [CONTROL] → [REMOTE SENSOR]
 - When a signal is being received from a HDBaseT transmission device
- When [NORMAL] is selected, the [AUTO POWER ON SELECT] display turns grey in color and is disabled, and [OFF] is automatically selected.

NOTE:

- When connecting to a HDBaseT transmission device sold commercially, if the transmission device is set to transmit remote control signals, the power consumption of the projector in the standby mode will increase.

TIP:

- Your setting will not be affected even when [RESET] is done from the menu.
- The power consumption in the standby mode will not be included in calculating CO₂ emission reduction.

Enabling Direct Power On [DIRECT POWER ON]

Turns the projector on automatically when the power cord is inserted into an active power outlet. This eliminates the need to always use the POWER button on the remote control or projector cabinet.

Turning On the Projector By Applying Computer Signal [AUTO POWER ON SELECT]

If set to [NETWORK STANDBY], the projector automatically detects the synchronizing signal input from the following selected terminals and projects the picture accordingly: Computer, HDMI, DisplayPort, HDBaseT, and SLOT.

OFF AUTO POWER ON SELECT function will be switch off.

HDMI, DisplayPort, COMPUTER, HDBaseT, SLOT

..... When a computer signal of a selected input terminal is detected, the power supply of the projector will be turned on automatically and the computer screen will be projected.

NOTE:

- If you want to activate the AUTO POWER ON SELECT function after powering OFF the projector, interrupt the signal from the input terminals or disconnect the computer cable from the projector and wait for at least 3 seconds before inputting the signal from the selected terminal. When the projector is turned off and enters NETWORK STANDBY mode, but signals from the computer continue to be sent the projector, the projector maintains NETWORK STANDBY mode and will not turn ON automatically. In addition, if signals from HDMI, DisplayPort or HDBaseT continue to be sent to the projector, depending on the settings of connected external devices, the projector may turn ON automatically even if it is powered off and NETWORK STANDBY mode is in effect.
- This function does not work when component signals come into COMPUTER 1 IN terminal or when computer signals are Sync on Green or Composite Sync.

Enabling Power Management [AUTO POWER OFF]

When this option is selected you can enable the projector to automatically turn off (at the selected time: 0:05, 0:10, 0:15, 0:20, 0:30, 1:00) if there is no signal received by any input or if no operation is performed.

NOTE:

- The power will not go off automatically when a signal from the Ethernet/HDBaseT port is being projected.
- [AUTO POWER OFF] appears in grey when the [STANDBY MODE] is set to [NETWORK STANDBY] and [0:15] will be set automatically.

Using Off Timer [OFF TIMER]

1. Select your desired time between 30 minutes and 16 hours: OFF, 0:30, 1:00, 2:00, 4:00, 8:00, 12:00, 16:00.
2. Press the ENTER button on the remote control.
3. The remaining time starts counting down.
4. The projector will turn off after the countdown is complete.

NOTE:

- To cancel the preset time, set [OFF] for the preset time or turn off the power.
- When the remaining time reaches 3 minutes before the projector is turned off, the [THE PROJECTOR WILL TURN OFF WITHIN 3 MINUTES] message will be displayed on the bottom of the screen.

Setting for the Optional Board [SLOT POWER]

When using the optional board installed in the slot, set the following options.

PROJECTOR ON This feature will turn on or off the power to the optional board.

OFF: Forcibly turn off the power to the optional board installed in the slot.

ON (Default): Turn on the power to the optional board installed in the slot.

PROJECTOR STANDBY..... This feature will automatically enable or disable the optional board installed in the slot when the projector is in standby.

DISABLE: Select this option to disable the optional board in the projector standby.

ENABLE (Default): Select this option to enable the optional board in the projector standby.

Returning to Factory Default [RESET]

The RESET feature allows you to change adjustments and settings to the factory preset for a (all) source (s) except the following:



[CURRENT SIGNAL]

Resets the adjustments for the current signal to the factory preset levels.

The items that can be reset are: [PRESET], [CONTRAST], [BRIGHTNESS], [COLOR], [HUE], [SHARPNESS], [ASPECT RATIO], [HORIZONTAL], [VERTICAL], [CLOCK], [PHASE], and [OVERSCAN].

[ALL DATA]

Reset all the adjustments and settings for all the signals to the factory preset.

All items can be reset **EXCEPT** [LANGUAGE], [BACKGROUND], [FILTER MESSAGE], [EDGE BLENDING], [MULTI SCREEN], [SCREEN TYPE], [GEOMETRIC CORRECTION], [REF. WHITE BALANCE], [ADMINISTRATOR MODE], [CONTROL PANEL LOCK], [SECURITY], [COMMUNICATION SPEED], [CONTROL ID], [STANDBY MODE], [FAN MODE], [LIGHT HOURS USED], [TOTAL CARBON SAVINGS], and [WIRED LAN].

[ALL DATA (INCLUDING ENTRY LIST)]

Reset all the adjustments and settings for all the signals to the factory preset except [LANGUAGE], [BACKGROUND], [FILTER MESSAGE], [EDGE BLENDING], [MULTI SCREEN], [SCREEN TYPE], [GEOMETRIC CORRECTION], [REF. WHITE BALANCE], [ADMINISTRATOR MODE], [CONTROL PANEL LOCK], [SECURITY], [COMMUNICATION SPEED], [CONTROL ID], [STANDBY MODE], [FAN MODE], [LIGHT HOURS USED], [TOTAL CARBON SAVINGS], and [WIRED LAN].

Also deletes all the signals in the [ENTRY LIST] and returns to the factory preset.

NOTE: Locked signals in Entry List cannot be reset.

8 Menu Descriptions & Functions [INFO.]

Displays the status of the current signal and light module usage. This item has nine pages. The information included is as follows:

TIP: Pressing the HELP button on the remote control will show the [INFO.] menu items.

[USAGE TIME]

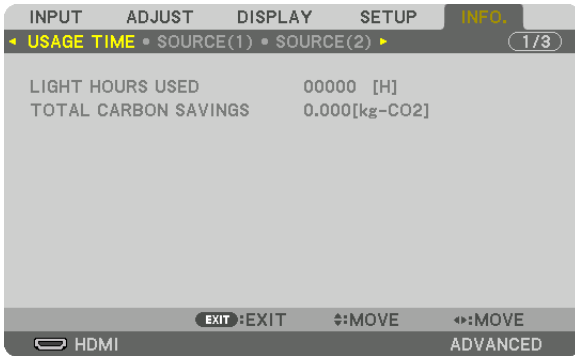

[LIGHT HOURS USED] (H)

[TOTAL CARBON SAVINGS] (kg-CO2)

- [TOTAL CARBON SAVINGS]

This displays the estimated carbon saving information in kg. The carbon footprint factor in the carbon saving calculation is based on the OECD (2008 Edition). (→ page 31)

[SOURCE(1)]

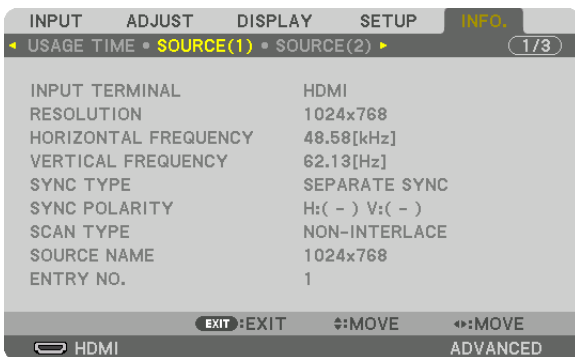

INPUT TERMINAL
 HORIZONTAL FREQUENCY
 SYNC TYPE
 SCAN TYPE
 ENTRY NO.

RESOLUTION
 VERTICAL FREQUENCY
 SYNC POLARITY
 SOURCE NAME

[SOURCE(2)]



SIGNAL TYPE
BIT DEPTH
LINK RATE
3D FORMAT

VIDEO TYPE
VIDEO LEVEL
LINK LANE

[SOURCE(3)]

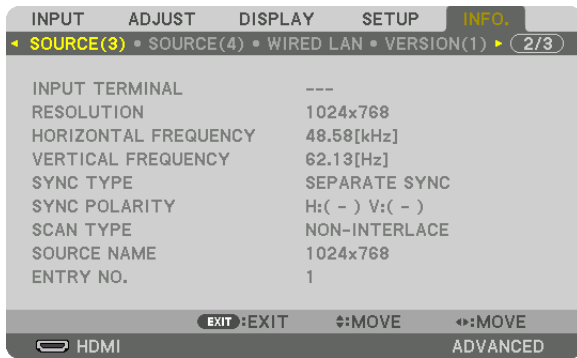

INPUT TERMINAL
HORIZONTAL FREQUENCY
SYNC TYPE
SCAN TYPE
ENTRY NO.

RESOLUTION
VERTICAL FREQUENCY
SYNC POLARITY
SOURCE NAME

[SOURCE(4)]

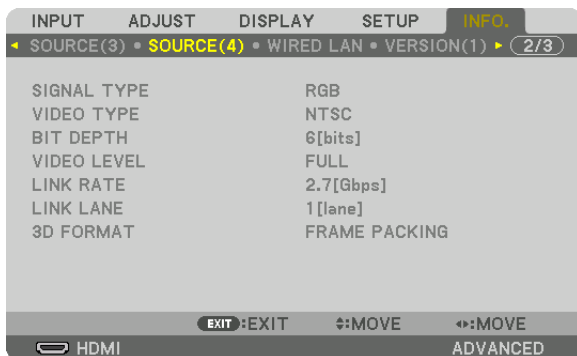

SIGNAL TYPE
BIT DEPTH
LINK RATE
3D FORMAT

VIDEO TYPE
VIDEO LEVEL
LINK LANE

[HDBaseT]

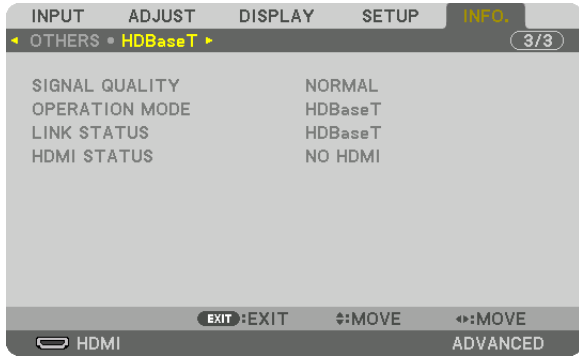

SIGNAL QUALITY
LINK STATUS

OPERATION MODE
HDMI STATUS

6. Connecting to Other Equipment

① Mounting a lens (sold separately)

This projector can be used with 3 kinds of optional lenses (sold separately). The chart below shows compatible lenses according to the projector model. The descriptions here are for the NP35ZL (standard zoom) lens. Mount other lenses in the same manner. See page 164 for lens options.

Projector (model name)	Lens (model)			
	NP34ZL Short focus zoom	NP35ZL Standard zoom	NP36ZL Standard zoom	NP37ZL Long focus zoom
PX602UL-WH/PX602UL-BK	Yes	Yes	No	Yes
PX602WL-WH/PX602WL-BK	Yes	Yes	Yes	Yes

Yes = can be mounted, No = cannot be mounted

⚠ WARNING:

(1) Turn off the power and wait for the cooling fan to stop, (2) turn off the main power switch, (3) disconnect the power cord and wait for the unit to cool before mounting or removing the lens. Failure to do so can result in eye injury, electric shock, or burn injuries.

NOTE:

- The projector and lenses are made of precision parts. Do not subject them to shock or excessive forces.
- Remove the separately sold lens when moving the projector. If not, the lens could be subject to shock while the projector is being moved, damaging the lens and the lens shift mechanism.
- When dismantling the lens from the projector, return the lens position to the home position before turning off the power. Failure to do so may prevent the lens from being mounted or dismounted because of narrow space between the projector and the lens.
- Never touch the lens surface while the projector is operating.
- Be very careful not to let dirt, grease, etc., on the lens surface and not to scratch the lens surface.
- Perform these operations on a flat surface over a piece of cloth, etc., to prevent the lens from getting scratched.
- When leaving the lens off the projector for long periods of time, mount the dust cap on the projector to prevent dust or dirt from getting inside. If the lens remains detached from the projector for long periods of time, dust may collect within the optical unit and damage the lens, causing deterioration of projected image.
- Other types of lenses cannot be mounted on this projector. The NP34ZL/NP35ZL/NP36ZL/NP37ZL series of lenses cannot be mounted onto other projector models.

Part Names of the Lens Mount

Attaching the Lens Mount

Rotate and align the 3 flanges on the lens with the 3 flange catches on the lens mount. The lens can be secured to the mount using a lock mechanism.

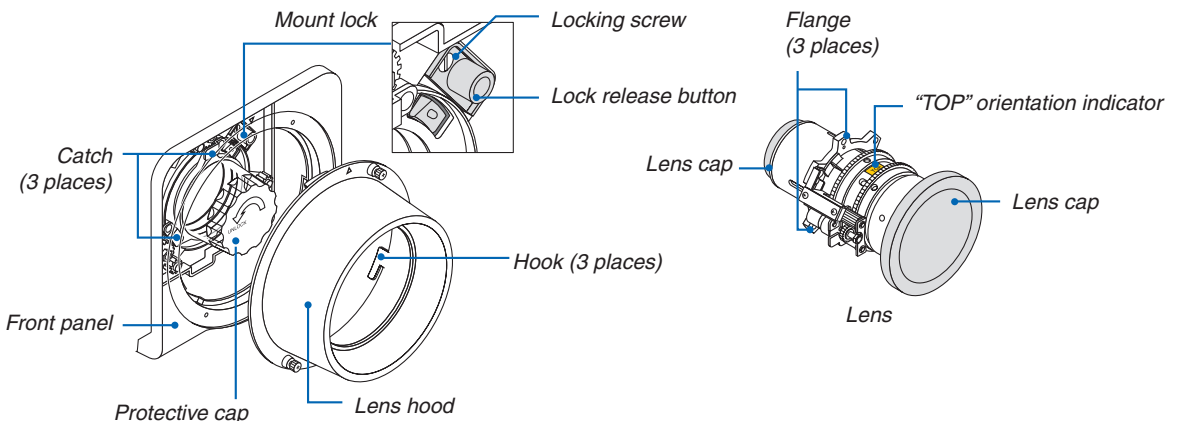

Using the lock mechanism

Release: Locking screw is tightened

The lens can be attached or detached (factory default setting).

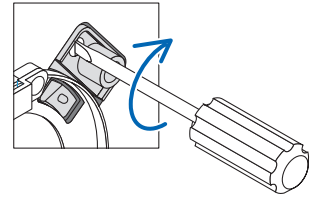

Lock: Locking screw is untightened

The lens cannot be attached or detached. Pressing the lock release button all the way in disables the lock mechanism and allows the lens to be attached or detached.

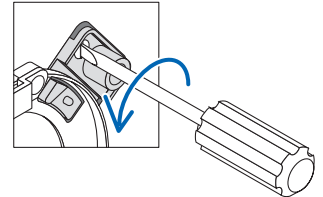

Mounting the lens

Preparation:

Prepare a flathead screwdriver.

* The illustration omits the projector cabinet.

1. Remove the lens hood.

(1) Loosen the 2 screws pinching and turning them counterclockwise by your fingers.

- The screws will remain to stay not be removed.

(2) Remove the lens hood by turning it counterclockwise. The hooks on the lens hood will disengage from the front panel.

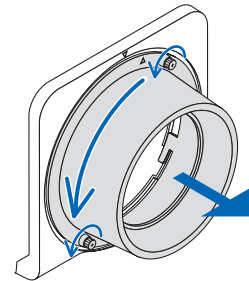

2. Remove the protective cap.

- The unit is shipped from the factory with the protective cap installed.

Turn the protective cap counterclockwise to release it from the catch. Remove the cap.

- Please store the protective cap in a safe place.

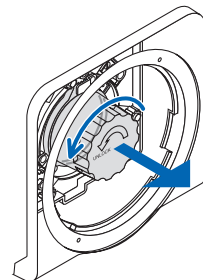

3. Remove the lens caps on either side of the lens.

- The NP35ZL lens unit is used as an example.
- Please store the lens cap in a safe place.

NOTE:

- Be sure to remove the lens cap. If the light source is turned on when the lens cap remains on the lens, it may be cause of malfunction.

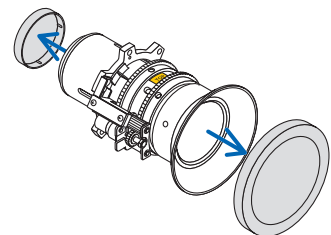

4. With the “TOP” orientation indicator facing upwards, insert the lens into the lens mount.

Align the flange on the upper portion of the lens with the catch on the left side of the lens mount.

NOTE:

- Insert the lens carefully to avoid it from damage by knocking against the lens mount.

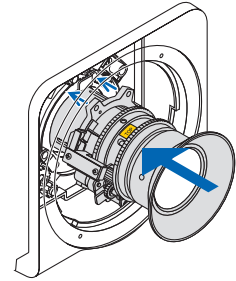

5. Turn the lens clockwise until it clicks into place.

The 3 flanges have now engaged with the 3 catches and the lens unit has been mounted.

- To lock the lens unit see “Using the lock mechanism” on the previous page.

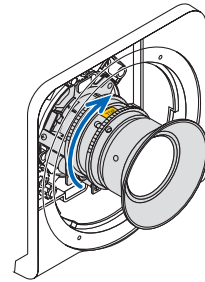

6. Mount the lens hood to the front panel.

(1) Align ▲ marked on the lens hood and the front panel top.

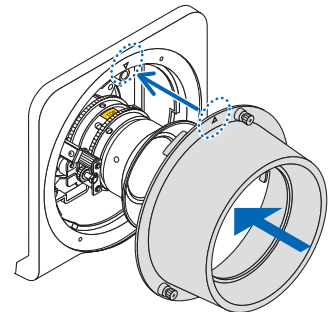

(2) Turn the lens hood clockwise.

The hooks in the rear will engage with the front panel flange.

(3) Tighten the 2 screws by your fingers.

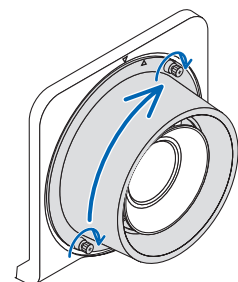

Removing the lens

Preparation:

Return the lens position to the home position. (→ page 19)

After the lens shift has moved, refer to the warning on page 19 and turn off the power.

1. Remove the lens hood.

Refer to Step 1 under “Mounting the lens”.

- If the lens unit is locked please see page 122 and follow the instructions under Using the Lock Function to unlock it.

2. Turn the lens counterclockwise to remove it from the catch, and slowly pull forward to remove.

- After removing the lens, mount the lens caps (front and back) included with the lens before storing the lens.
- To replace the lens, see Step 3 of “Mounting the lens”.

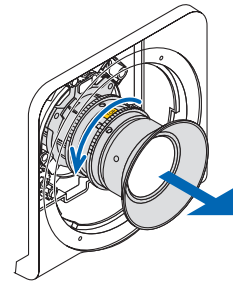

3. Mount the protective cap.

Align the flange on the protective cap to the left side of the catch and turn clockwise until it clicks into place.

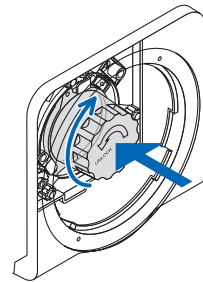

4. Mount the lens hood to the panel.

Refer to Step 7 under “Mounting the lens”.

② Making Connections

A computer cable, BNC cable (5-core type), HDMI cable, or a DisplayPort cable can be used to connect to a computer. The connection cable is not enclosed with the projector. Please get ready a suitable cable for the connection.

Analog RGB signal connection

- Connect the computer cable to the display output terminal (mini D-sub 15 pin) on the computer and the COMPUTER 1 IN terminal on the projector. Please use a computer cable attached with a ferrite core.
- When connecting the display output terminal (mini D-sub 15 pin) on the computer to the BNC input terminal, use a conversion cable to convert the BNC cable (5 core) to a mini D-sub 15 pin cable.

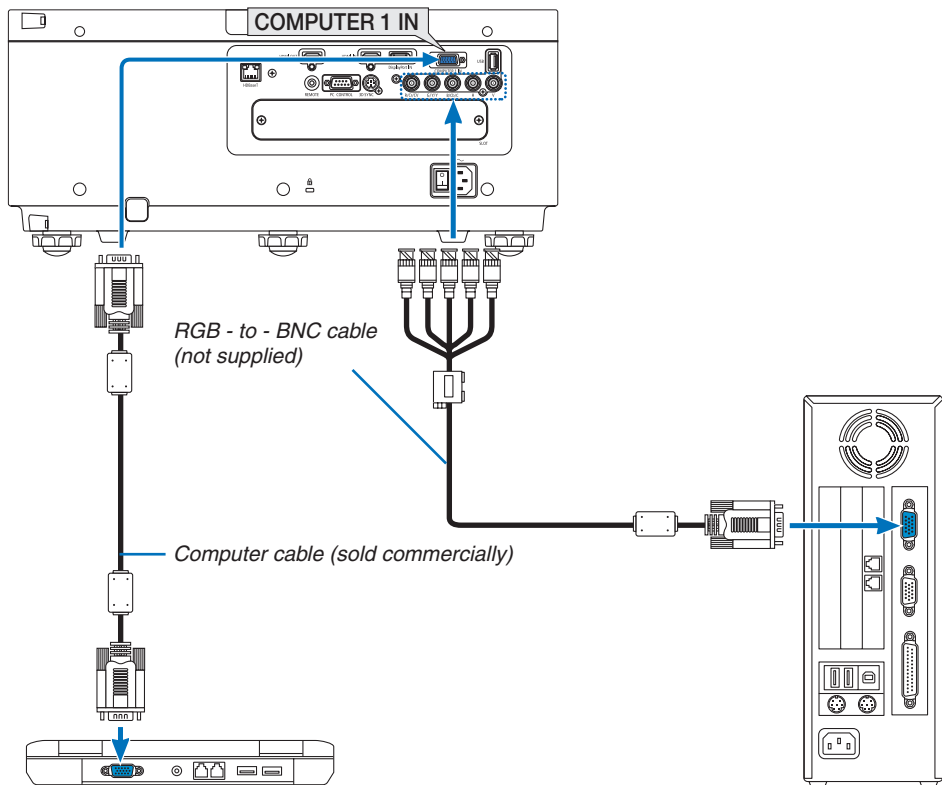

NOTE: Please check the operating manual of the computer as the name, position and direction of the terminal may differ depending on the computer.

- Select the source name for its appropriate input terminal after turning on the projector.



Input terminal	SOURCE button on the projector cabinet	Button on the remote control
COMPUTER 1 IN	COMPUTER	COMPUTER 1
BNC	×5 BNC	COMPUTER 2

Digital RGB signal connection

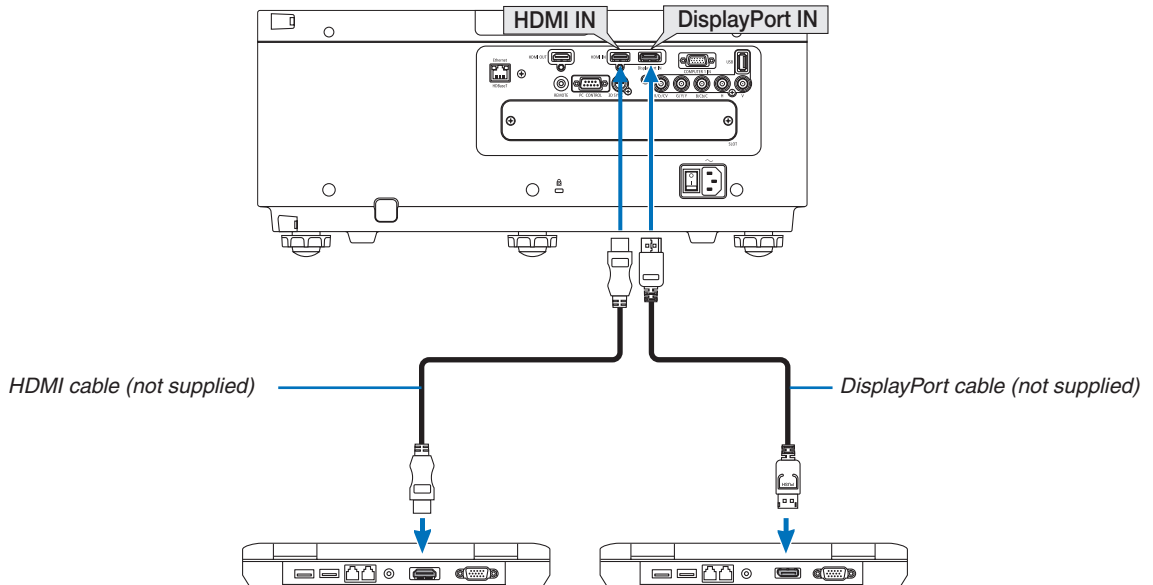
- Connect a commercially available HDMI cable between the computer's HDMI output terminal and the projector's HDMI IN terminal.
- Connect a commercially available DisplayPort cable between the computer's DisplayPort output terminal and the projector's DisplayPort IN terminal.



- Select the source name for its appropriate input terminal after turning on the projector.

Input terminal	SOURCE button on the projector cabinet	Button on the remote control
HDMI IN	 HDMI	HDMI
DisplayPort IN	 DisplayPort	DisplayPort

Cautions when connecting an HDMI cable

- Use a certified High Speed HDMI® Cable or High Speed HDMI® Cable with Ethernet.

Cautions when connecting a DisplayPort cable

- Use a certified DisplayPort cable.



- Depending on the computer, some time may be required until the image is displayed.
- Some DisplayPort cables (commercially available) have locks.
- To disconnect the cable, press the button on the top of the cable's terminal, then pull the cable out.
- Power can be supplied to the connecting device from the DisplayPort IN terminal (maximum of 1.65 W). However, power will not be supplied to the computer.
- When signals from a device that uses a signal converter adapter are connected to the DisplayPort IN terminal, in some cases the image may not be displayed.
- When the HDMI output of a computer is connected to the DisplayPort IN terminal, use a converter (commercially available).

Cautions when using a DVI signal

- When the computer has a DVI output terminal, use a commercially available converter cable to connect the computer to the projector's HDMI IN terminal (only digital video signals can be input).

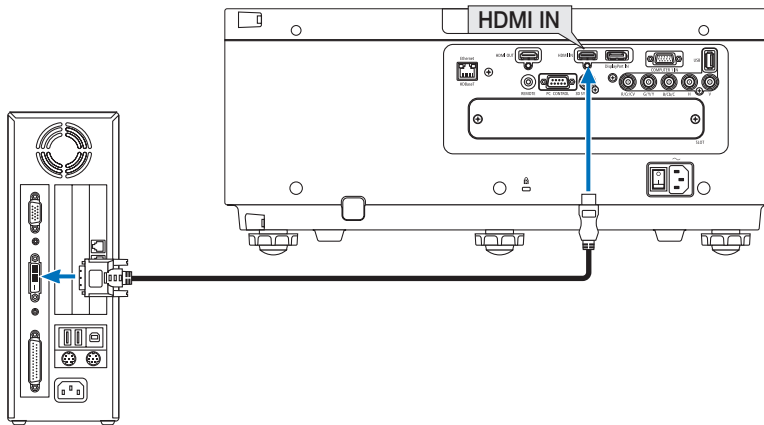

NOTE: When Viewing a DVI Digital Signal

- Turn off the power of the computer and projector before connecting devices.
 - When a video deck is connected via a scan converter, etc., the display may not be correct during fast-forwarding and rewinding.
 - Use a DVI-to-HDMI cable compliant with DDWG (Digital Display Working Group) DVI (Digital Visual Interface) revision 1.0 standard. The cable should be within 197'5 m long.
 - Turn off the projector and the PC before connecting the DVI-to-HDMI cable.
 - To project a DVI digital signal: Connect the cables, turn the projector on, then select the HDMI. Finally, turn on your PC. Failure to do so may not activate the digital output of the graphics card resulting in no picture being displayed. Should this happen, restart your PC.
 - Some graphics cards have both analog RGB (15-pin D-Sub) and DVI (or DFP) outputs. Use of the 15-pin D-Sub terminal may result in no picture being displayed from the digital output of the graphics card.
 - Do not disconnect the DVI-to-HDMI cable while the projector is running. If the signal cable has been disconnected and then reconnected, an image may not be correctly displayed. Should this happen, restart your PC.
 - The COMPUTER 1 IN terminals support Windows Plug and Play. The BNC input terminal does not support Windows Plug and Play.
 - A Mac signal adapter (commercially available) may be required to connect a Mac computer.
To connect a Mac computer equipped with a Mini DisplayPort to the projector, use a commercially available Mini DisplayPort → DisplayPort converter cable.
-

Connecting an External Monitor

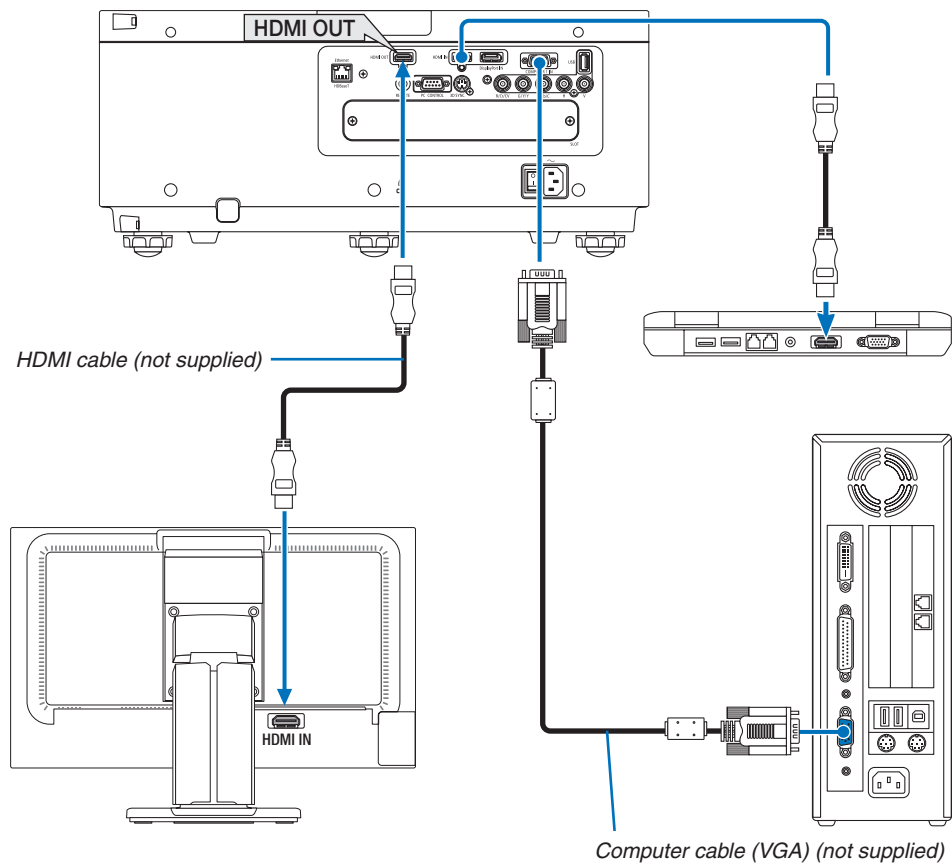

You can connect a separate, external monitor to your projector to simultaneously view on a monitor the computer analog image you're projecting.

- BNC(CV) component video signals and BNC(Y/C) S-video signals will not be output.
- Please refer to Page 52 when displaying the PIP/PBP screen.

NOTE:

- When outputting HDMI signals, turn on the power of the video device on the output side and keep it connected before inputting video signals into this device. The HDMI OUT terminals of the projector are equipped with repeater functions. When a device is connected to the HDMI OUT terminal, the resolution of the output signal is limited by the resolution supported by the connected device.
- In the case of the HDMI OUT terminal of the projector, the theoretical number of units that can be connected in a series is seven. The maximum number of units that can be connected may be reduced by the external environment and quality of the signal and cable, etc. The number of units that can be connected may differ depending on the HDCP version, restriction on the number of HDCP repeaters in the source device and the quality of the cable. The overall system needs to be checked in advance when building a system.
- When the [STANDBY MODE] is set to [NORMAL], video will not be output if the projector goes into the standby mode. Set the mode to [NETWORK STANDBY], turn on the power of the transmission device and keep it in a connected state.
- When the [STANDBY MODE] of this device is set to [NORMAL], HDMI signals will not be output. To output HDMI signals, set the [STANDBY MODE] to [NETWORK STANDBY], turn on the power supply of the transmission device and keep it connected.
- HDMI repeater function will not be functioned if switching terminals and putting in/pulling out the HDMI cable is performed on the 2nd projector and after.

Connecting Your Blu-ray Player or Other AV Equipment

Component video signal/S-video signal connection

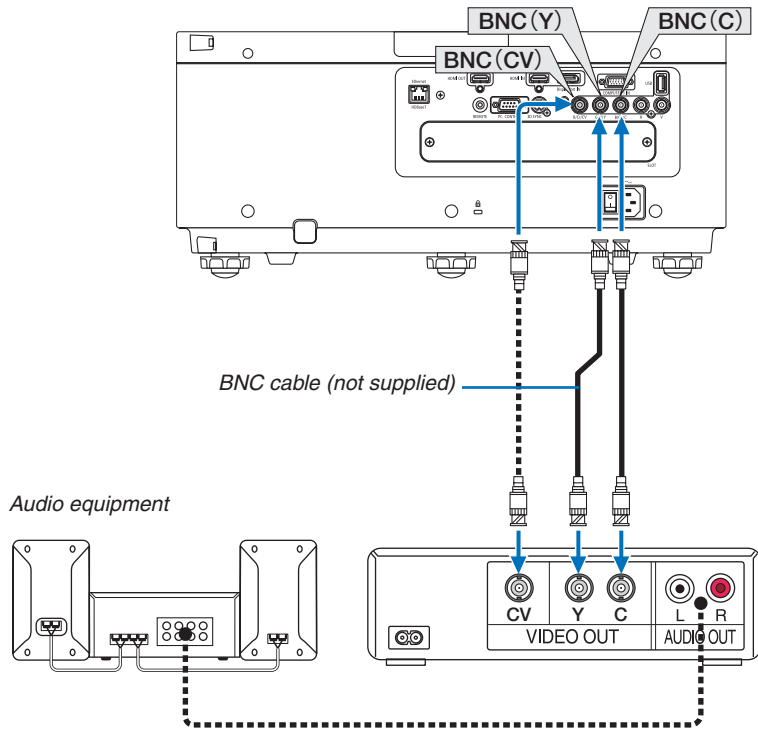

- Select the source name for its appropriate input terminal after turning on the projector.

Input terminal	SOURCE button on the projector cabinet	Button on the remote control
BNC(CV)	BNC(CV)	VIDEO
BNC(Y/C)	BNC(Y/C)	S-VIDEO

Connecting Component Input

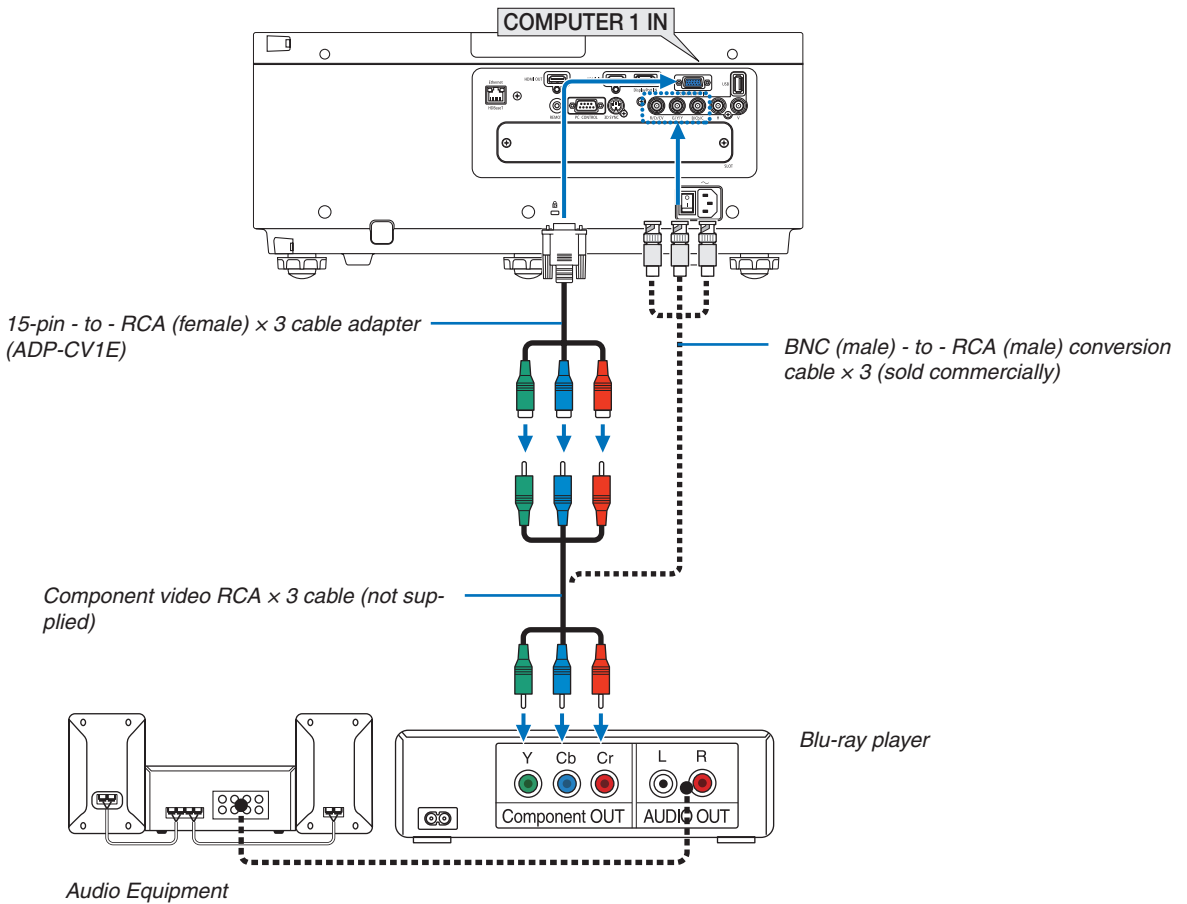

- Select the source name for its appropriate input terminal after turning on the projector.

Input terminal	SOURCE button on the projector cabinet	Button on the remote control
COMPUTER 1 IN	COMPUTER	COMPUTER 1
BNC	x5 BNC	COMPUTER 2

NOTE:

- When the signal format is set to [AUTO] (default factory setting when shipped), the computer signal and component signal are automatically distinguished and switched. If the signals cannot be distinguished, select [COMPONENT] under [ADJUST] → [VIDEO] → [SIGNAL TYPE] in the on-screen menu of the projector.
- To connect to a video device with a D terminal, use the sold separately D terminal converter adapter (model ADP-DT1E).

Connecting HDMI Input

You can connect the HDMI output of your Blu-ray player, hard disk player, or notebook type PC to the HDMI IN terminal of your projector.

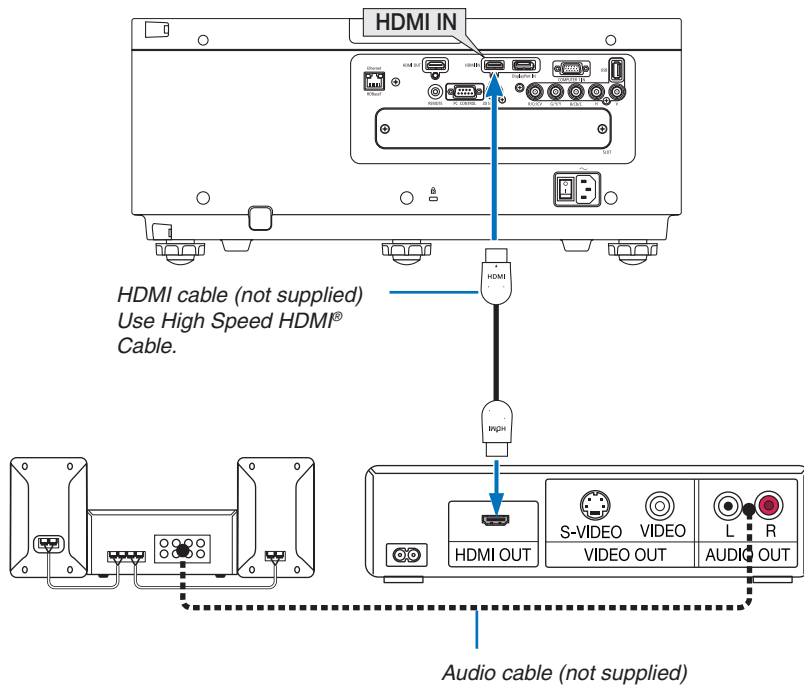

Input terminal	SOURCE button on the projector cabinet	Button on the remote control
HDMI IN	 HDMI	HDMI

TIP: For users of audio video equipment with an HDMI terminal:

Select "Enhanced" rather than "Normal" if HDMI output is switchable between "Enhanced" and "Normal".

This will provide improved image contrast and more detailed dark areas.

For more information on settings, refer to the instruction manual of the audio video equipment to be connected.

- When connecting the HDMI IN terminal of the projector to the Blu-ray player, the projector's video level can be made settings in accordance with the Blu-ray player's video level. In the menu select [ADJUST] → [VIDEO] → [VIDEO LEVEL] and make necessary settings.

Connecting to a Wired LAN

The projector comes standard with a Ethernet/HDBaseT port (RJ-45) which provides a LAN connection using a LAN cable.

To use a LAN connection, you are required to set the LAN on the projector menu. Select [SETUP] → [NETWORK SETTINGS] → [WIRED LAN]. (→ page 107).

Example of LAN connection

Example of wired LAN connection

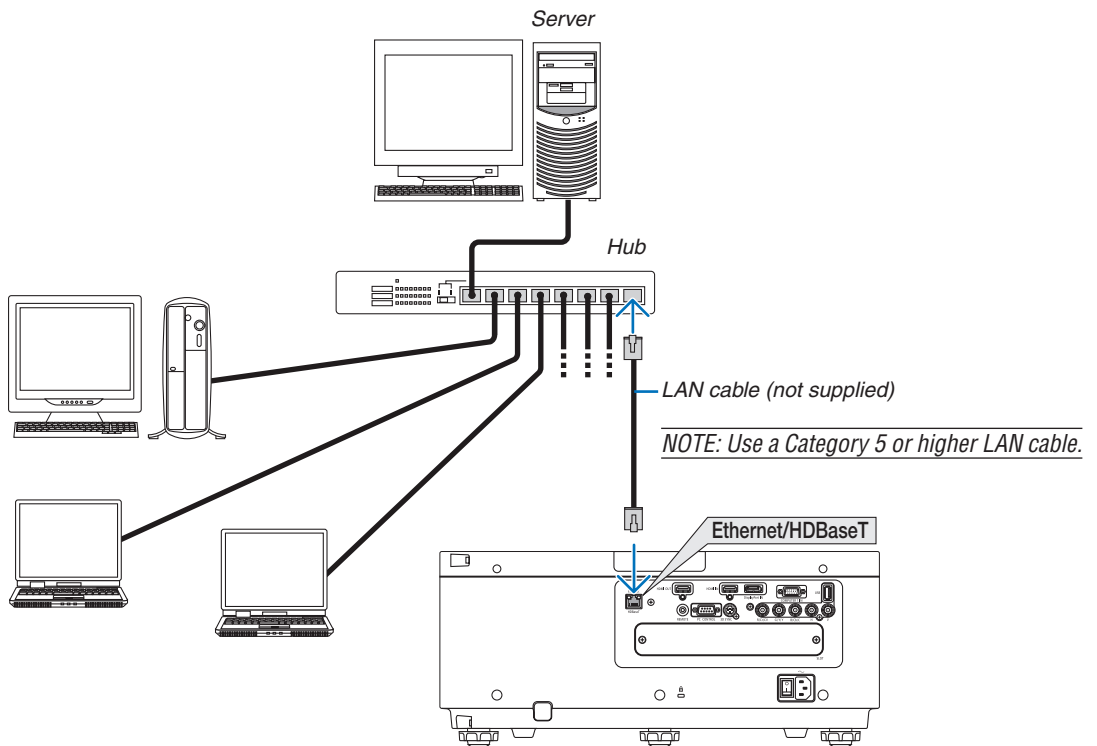

Connecting to a HDBaseT transmission device (sold commercially)

HDBaseT is a connection standard for home appliances that is established by the HDBaseT Alliance.

Use a LAN cable sold commercially to connect the Ethernet / HDBaseT port of the projector (RJ-45) to a HDBaseT transmission device sold commercially.

The Ethernet/HDBaseT port of the projector supports HDMI signals (HDCP) from transmission devices, control signals from external devices (serial, LAN) and remote control signals (IR commands).

Connection example

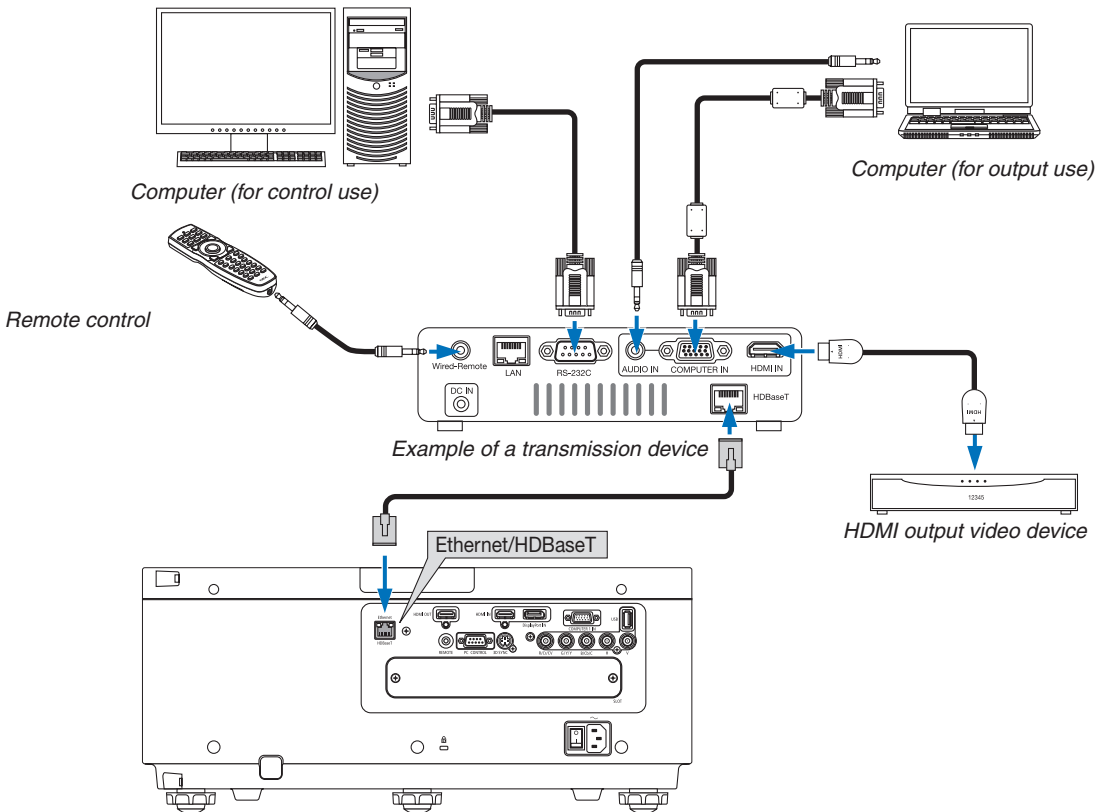

NOTE:

- Please use a shielded twisted pair (STP) cable of Category 5e or higher for the LAN cable (sold commercially).
- The maximum transmission distance over the LAN cable is 100 m. (the maximum distance is 70 m for a 4K signal)
- Please do not use other transmission equipment between the projector and transmission equipment. The picture quality may be deteriorated as a result.
- This projector is not guaranteed to work with all HDBaseT transmission devices sold commercially.

Portrait projection (vertical orientation)

By using a safety cover (sold separately), the projector can be mounted vertically to display computer images in portrait orientation.

If the safety cover is missing, the power will not turn on.

All screens, such as the on-screen menus, will be rotated in the counter-clockwise direction.

The projector is equipped with a sensor to automatically detect the installation state.

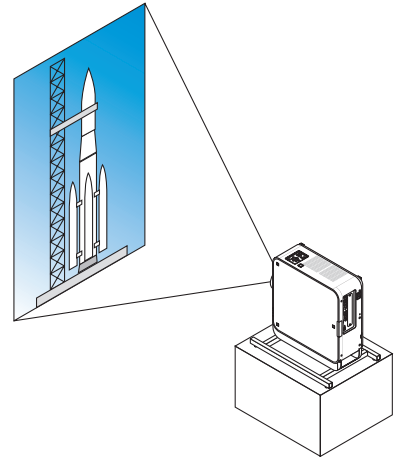

Precautions during installation

- Please do not install the projector in a vertical orientation on top of the floor or table on its own. If not, the projector may fall over, resulting in injury, damage or malfunction.
- For vertical installation, install the projector with the intake vent (safety cover) facing downwards. A stand for supporting the projector needs to be made for this purpose. In this case, the stand must be designed such that the center of gravity of the projector is located well within the legs of the stand. If not, the projector may fall over and result in injury, damage and malfunction.
- Do not obstruct the intake vent on the safety cover. The projector may otherwise overheat, causing fire and malfunction.

NOTE:

- *When using a safety cover, the power turns on only when the projector ventilation intake is facing down. If the intake vent faces any other direction, the power will not turn on.*
- *If the projector is mounted vertically without a safety cover, the power will not turn on.*

Design and manufacturing conditions for the stand

1. To display images in portrait orientation, use a safety cover (sold separately). (→ page 137)
 2. Please hire an installation service provider (for a fee) for the design and manufacture of a customized stand to be used for portrait projection. Please ensure that the design complies with the following conditions:
 - There is an intake vent opening on the safety cover. Do not obstruct this opening.
 - There are 2 ventilation holes at the bottom of the projector. These holes should remain unobstructed.
 - Use the 6 screw holes at the back of the projector to secure it to the stand.
Screw hole center dimension: 300×300 (pitch = 150) mm
Screw hole dimension on the projector: M4 with a maximum depth of 8 mm
3 of the legs can be unscrewed for removal.
 - Horizontal adjustment mechanism (for example, bolts and nuts in 4 places)
 - Please design the stand so that it does not easily topple over.
- * We recommend combining ceiling mounts (model NP15CM, sold separately) with an angle adjustment mechanism.

Reference drawings

* The drawing showing the dimensional requirements is not an actual stand design drawing.

(Unit: mm)

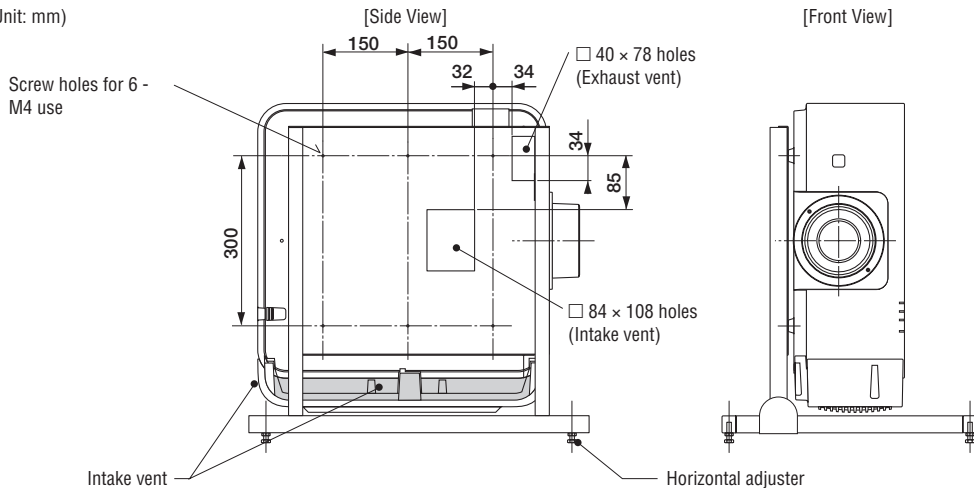

Mounting the safety cover (sold separately)

The projector is equipped a switch for changing to vertical mount portrait projection. Mount the safety cover and place vertically to change to vertical orientation mode.

1. *Insert and tighten the 7 screws (turning clockwise) to mount to the projector.*

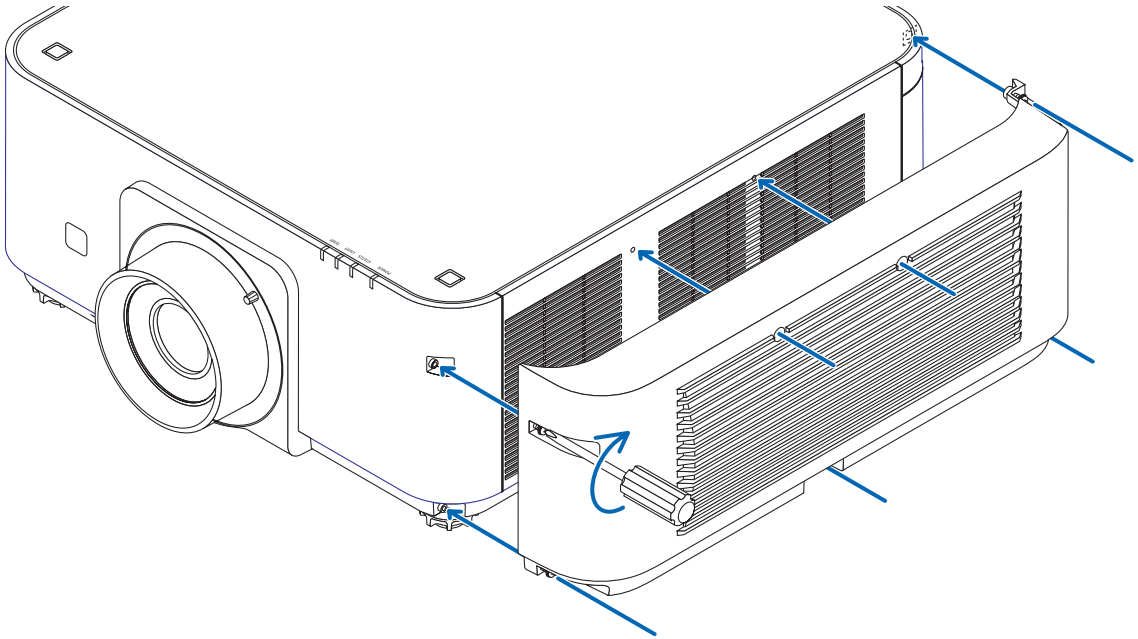

- * *If using in normal horizontal orientation, make sure to remove the safety cover. To remove, unscrew the 7 screws (turning counter-clockwise).*

Stacking projectors

The projected image brightness can be doubled by gravity stacking up to two projectors without external support. This is called “Stacking Projection”.

2 projectors can be stacked on top of each other for “Stacking” setup.

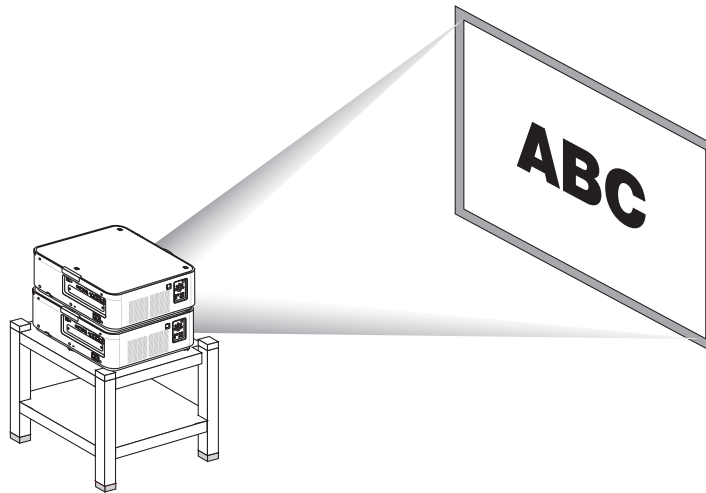

CAUTION:

A minimum of two persons are required to carry the projector. Otherwise the projector may tumble or drop, causing personal injury.

NOTE:

- Projectors with different model numbers cannot be gravity stacked.
 - Optional lenses with the same model numbers must be used for stacking projection.
- For stacking projectors, attach the supplied three stacking holders to the top of the lower projector. (→ [next page](#))
- It does not support overlay accuracy by stacked projectors. Precise images as small texts and detailed graphics can not be clearly read or seen.
- Use a commercially available distribution amplifier to both the primary (upper) and the secondary (lower) projectors to distribute signal to two outputs of the two projectors.
- Notes for stacking
 - Ask your service person for setting up and adjusting projectors.
 - Set up the projectors in a place or structure in a way with sufficient strength to support the combined weight of the two projectors. The single projector with a lens weighs up to approximately 20 kg/ 44 lbs.
 - To prevent the projectors from falling, fasten them in a way to withstand earthquakes.
 - Double stacking will cause room temperature to increase. Ventilate the room well.
 - Do not attempt to stack projectors on the ceiling. Gravity stacking cannot be done on the ceiling.
 - Warm up the projectors for one hour before the desired projection is obtained.
 - Make sure that the position of the upper projector does not exceed its specifications. When setting up the two projectors, adjustable height range for the tilt feet on the upper projector is added to the total adjustable range.
 - Set up the projectors so that the projected image shows as little geometric distortions as possible. The lens is different in geometric distortion between wide(+) and tele (-) for zoom.
 - Adjust the horizontal lens shift to the lens center.

Attaching Stacking Holders

Attach three stacking holders to three locations on the top of the lower projector.

Preparation:

Tools required are Phillips screwdriver (plus-head) and three stacking holders packaged with the projector. Loosen the tilt feet (three locations) of the projector.

1. Remove rubber caps and screws at three locations.

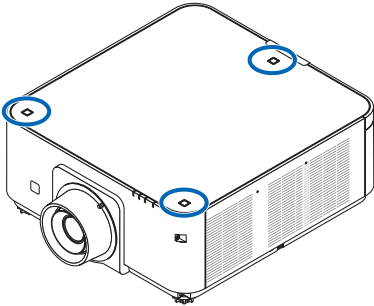

- (1) Use your tweezers or nail to pinch and pull up the rubber cap.
- (2) Remove the screw from a square hole.

(1)



(2)

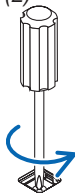

2. Attach the three stacking holders at three locations.

- (1) Place a stacking holder in a square hole.
- (2) Use the screw removed at Step 1 to fix the stacking holder in the square hole.
- (3) Put the rubber cap removed at Step 1 back into the square hole.
 - Snap the tabs on both of the rubber cap into the slits on both sides in the square hole.

(1)



(2)

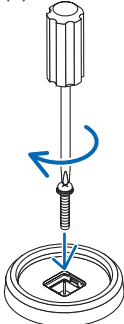

(3)

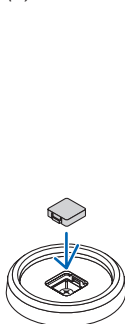

3. Put another projector on the first projector.

Put each tilt foot of the upper projector on the stacking holders (three locations).

- Each tilt foot has a rubber. Place each tilt foot rubber on stacking holders (three locations).

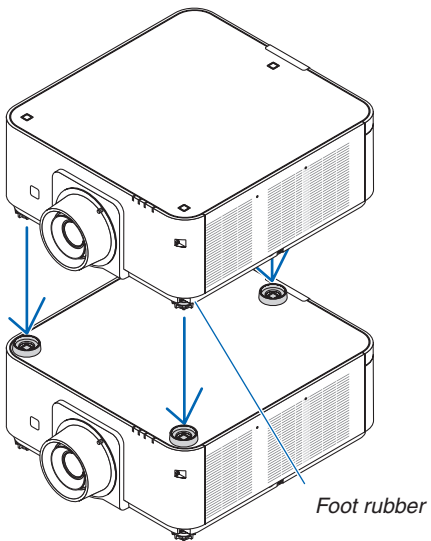

TIP:

- To remove the stacking holders, perform the above steps in reverse order.

7. Maintenance

① Cleaning the Lens

- Turn off the projector before cleaning.
- The projector has a plastic lens. Use a commercially available plastic lens cleaner.
- Do not scratch or mar the lens surface as a plastic lens is easily scratched.
- Never use alcohol or glass lens cleaner as doing so will cause damage to the plastic lens surface.

WARNING

- Please do not use a spray containing flammable gas to remove dust attached to the lens, etc. Doing so may result in fires.

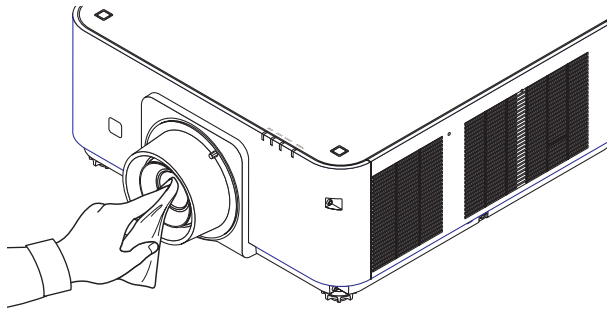

② Cleaning the Cabinet

Turn off the projector, and unplug the projector before cleaning.

- Use a dry soft cloth to wipe dust off the cabinet.
If heavily soiled, use a mild detergent.
- Never use strong detergents or solvents such as alcohol or thinner.
- When cleaning the ventilation slits or the speaker using a vacuum cleaner, do not force the brush of the vacuum cleaner into the slits of the cabinet.

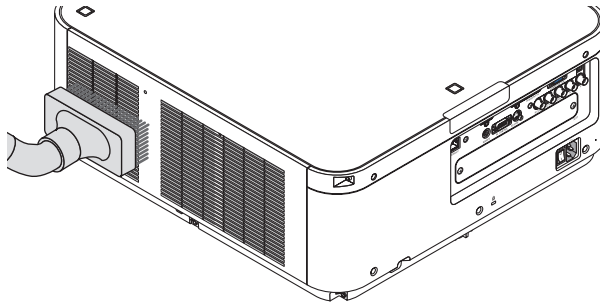

Vacuum the dust off the ventilation slits.

- Poor ventilation caused by dust accumulation in ventilation openings (intake, exhaust, also at the bottom of the projector) can result in overheating and malfunction. These areas should be cleaned regularly.
- Do not scratch or hit the cabinet with your fingers or any hard objects
- Contact your dealer for cleaning the inside of the projector.

NOTE: Do not apply volatile agent such as insecticide on the cabinet, the lens, or the screen. Do not leave a rubber or vinyl product in prolonged contact with it. Otherwise the surface finish will be deteriorated or the coating may be stripped off.

8. User Supportware

① Operating Environment for Software Included on CD-ROM

Names and Features of Bundled Software Programs

Name of software program	Features
Virtual Remote Tool (Windows only)	When the computer and projector are connected using a network (wired LAN), such operations as turning the projector's power on and off and switching the signal can be performed. It is also possible to send an image to the projector and register it as the background logo. Once the image is registered, it can be locked to prevent the logo from being overwritten.
PC Control Utility Pro 4 PC Control Utility Pro 5 (for Mac OS)	This is a software program used to operate the projector from the computer when the computer and the projector are connected with LAN. (→ page 133) • PC Control Utility Pro 4 can be used with a serial connection.

NOTE:

- To connect the projector to the network by using the Virtual Remote Tool, PC Control Utility Pro 4, PC Control Utility Pro 5, please configure the settings of [SETUP] → [NETWORK SETTINGS] in the on-screen menu (→ page 107).

Download service

For the update information about these software programs, visit our website:

URL: <http://www.nec-display.com/dl/en/index.html>

Operating Environment

[Windows]

Supported OS	Windows 8.1, Windows 8.1 Pro, Windows 8.1 Enterprise, Windows 8, Windows 8 Pro, Windows 8 Enterprise Windows 7 Home Basic, Windows 7 Home Premium, Windows 7 Professional, Windows 7 Ultimate, Windows 7 Enterprise Windows Vista Home Basic, Windows Vista Home Premium, Windows Vista Business, Windows Vista Ultimate, Windows Vista Enterprise Windows XP Home Edition (32-bit version) Service Pack 3 or later Windows XP Professional (32-bit version) Service Pack 3 or later
--------------	--

[Mac]

Supported OS	Mac OS X v10.6, v10.7, v10.8, v10.9
--------------	-------------------------------------

② Installing Software Program

Installation for Windows software

The software programs except PC Control Utility Pro 5 support Windows 8.1, Windows 8, Windows 7, Windows Vista, and Windows XP.

NOTE:

- To install or uninstall each software program, the Windows user account must have “Administrator” privilege (Windows 8.1, Windows 8, Windows 7, Windows Vista) or “Computer Administrator” privilege (Windows XP).
- Exit all running programs before installation. If another program is running, the installation may not be completed.
- To run Virtual Remote Tool or PC Control Utility Pro 4 on Windows 8.1, Windows 8, Windows XP Home Edition, and Windows XP Professional, “Microsoft .NET Framework Version 2.0” is required. The Microsoft .NET Framework Version 2.0, 3.0 or 3.5 is available from Microsoft’s web page. Download and install it on your computer.

1 Insert the accompanying NEC Projector CD-ROM into your CD-ROM drive.

The menu window will be displayed.



TIP:

If the menu window will not be displayed, try the following procedure.

For Windows 7

1. Click “start” on Windows.
2. Click “All Programs” → “Accessories” → “Run”.
3. Type your CD-ROM drive name (example: “Q:”) and “LAUNCHER.EXE” in “Name”. (example: Q:\LAUNCHER.EXE)
4. Click “OK”.

The menu window will be displayed.

2 Click a software program you wish to install on the menu window.

The installation will start.

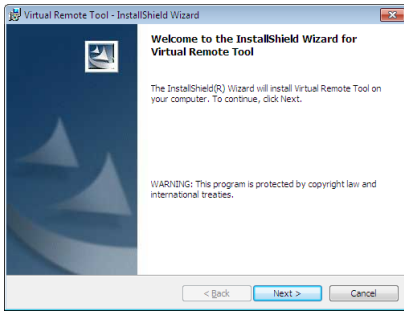

- Follow the instructions on the installer screens to complete the installation.

TIP:

Uninstalling a Software Program

Preparation:

Exit the software program before uninstalling. To uninstall the software program, the Windows user account must have “Administrator” privilege (Windows 8.1, Windows 8, Windows 7, and Windows Vista) or “Computer Administrator” privilege (Windows XP).

- **For Windows 8.1/Windows 8/Windows 7/Windows Vista**

- 1 Click “**Start**” and then “**Control Panel**”.

The Control Panel window will be displayed.

- 2 Click “**Uninstall a program**” under “**Programs**”

The “Programs and Features” window will be displayed.

- 3 Select the software program and click it.

- 4 Click “**Uninstall/Change**” or “**Uninstall**”.

- When the “User Account Control” windows is displayed, click “Continue”.

Follow the instructions on the screens to complete the uninstallation.

- **For Windows XP**

- 1 Click “**Start**” and then “**Control Panel**”.

The Control Panel window will be displayed.

- 2 Double-click “**Add / Remove Programs**”.

The Add / Remove Programs window will be displayed.

- 3 Click the software program from the list and then click “**Remove**”.

Follow the instructions on the screens to complete the uninstallation.

Using on Mac OS

Step 1: Install PC Control Utility Pro 5 on the computer.

1. **Insert the accompanying NEC Projector CD-ROM in your Mac CD-ROM drive.**
The CD-ROM icon will be displayed on the desktop.
2. **Double-click the CD-ROM icon.**
The CD-ROM window will be displayed.
3. **Double-click the “Mac OS X” folder.**
4. **Double-click “PC Control Utility Pro 5.pkg”.**
The installer will start.
5. **Click “Next”.**
“END USER LICENSE AGREEMENT” screen will be displayed.
6. **Read “END USER LICENSE AGREEMENT” and click “Next”.**
The confirmation window will be displayed
7. **Click “I accept the terms in the license agreement”.**
Follow the instructions on the installer screens to complete the installation.

TIP:

• Uninstalling a software program

1. **Put the “PC Control Utility Pro 5” folder to the Trash icon.**
 2. **Put the configuration file of PC Control Utility Pro 5 to the Trash icon.**
 - *The configuration file of PC Control Utility Pro 5 is located in “/Users/<your user name>/Application Data/NEC Projector User Supportware/PC Control Utility Pro 5”.*
-

③ Operating the Projector Via the LAN (Virtual Remote Tool)

This will help you perform operations such as projector's power on or off and signal selection via a LAN connection. It is also used to send an image to the projector and register it as the logo data of the projector. After registering it, you can lock the logo to prevent it from changing.

Control Functions

Power On/Off, signal selection, picture freeze, picture mute, audio mute, Logo transfer to the projector, and remote control operation on your PC.

Virtual Remote screen



Remote Control Window



Toolbar

This section provides an outline of preparation for use of Virtual Remote Tool.

For information on how to use Virtual Remote Tool, see Help of Virtual Remote Tool. (→ page 148)

NOTE:

- Logo data (graphics) that can be sent to the projector with Virtual Remote Tool has the following restrictions: (Only via serial or LAN connection)
 - * File size: Within 256 kilobytes
 - * Image size: Within the resolution of the projector
 - * File format: PNG (Full color)
- Logo data (image) sent using the Virtual Remote Tool will be displayed in the center with the surrounding area in black.
- To put the default "NEC logo" back in the background logo, you need to register it as the background logo by using the image file (PX602UL-WH/PX602UL-BK: \Logo\NEC_logo2011_WUXGA.png, PX602WL-WH/PX602WL-BK: \Logo\NEC_logo2011_1280x800.png) included on the supplied NEC Projector CD-ROM.

Connect the projector to a LAN.

Connect the projector to the LAN by following the instructions in “Connecting to a Wired LAN” (→ page 133) and “10. Controlling the Projector by Using an HTTP Browser” (→ page 42)

Start Virtual Remote Tool

Start using the shortcut icon

- Double-click the shortcut icon  on the Windows Desktop.

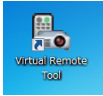

Start from the Start menu

- Click [Start] → [All Programs] or [Programs] → [NEC Projector User Supportware] → [Virtual Remote Tool] → [Virtual Remote Tool].

When Virtual Remote Tool starts for the first time, “Easy Setup” window will be displayed.

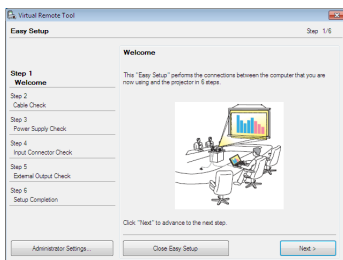

The “Easy Setup” feature is not available on this model. Click “Close Easy Setup”.

Closing the “Easy Setup” window will display the “Projector List” window.

Select your projector you wish to connect. This will display the Virtual Remote screen.



NOTE:

- When [NORMAL] is selected for [STANDBY MODE] from the menu, the projector cannot be turned on via network connection.

TIP:

- The Virtual Remote Tool screen (or Toolbar) can be displayed without displaying “Easy Setup” window. To do so, click to place a check mark for “ Do not use Easy Setup next time” on the screen.

Exiting Virtual Remote Tool

- 1 Click the Virtual Remote Tool icon  on the Taskbar.

The pop-up menu will be displayed.

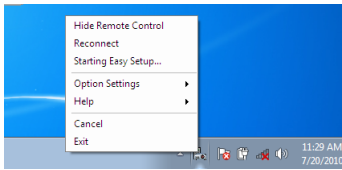

- 2 Click “Exit”.

The Virtual Remote Tool will be closed.

Viewing the help file of Virtual Remote Tool

- Displaying the help file using the taskbar

- 1 Click the Virtual Remote Tool icon  on the taskbar when Virtual Remote Tool is running.

The pop-up menu will be displayed.

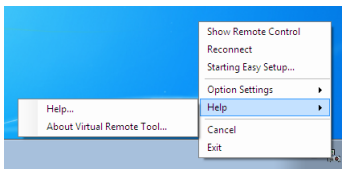

2. Click “Help”.

The Help screen will be displayed.

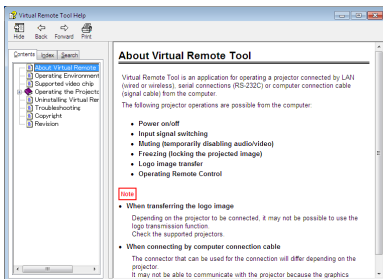

- Displaying the help file using the Start Menu.

1. Click “Start”. “All programs” or “Programs”. “NEC Projector User Supportware”. “Virtual Remote Tool”. and then “Virtual Remote Tool Help” in this order.

The Help screen will be displayed.

④ Controlling the Projector over a LAN (PC Control Utility Pro 4/Pro 5)

Using the utility software “PC Control Utility Pro 4” or “PC Control Utility Pro 5” included on the companion NEC Projector CD-ROM, the projector can be controlled from a computer over a LAN.

PC Control Utility Pro 4 is a program compatible with Windows. (→ this page)

PC Control Utility Pro 5 is a program compatible with Mac OS. (→ page 152)

Control Functions

Power On/Off, signal selection, picture freeze, picture mute, audio mute, adjusting, error message notification, event schedule.

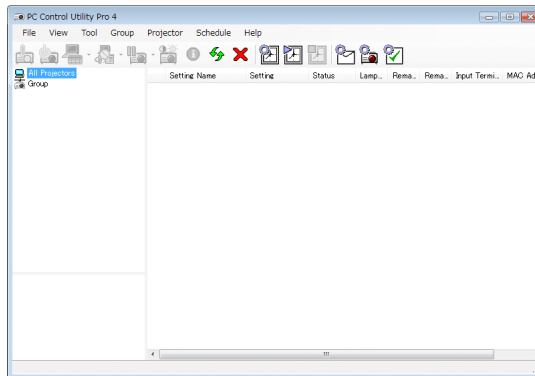

Screen of PC Control Utility Pro 4

This section provides an outline of preparation for use of PC Control Utility Pro 4/Pro 5. For information on how to use PC Control Utility Pro 4/Pro 5, see Help of PC Control Utility Pro 4/Pro 5. (→ page 151, 152)

Step 1: Install PC Control Utility Pro 4/Pro 5 on the computer.

Step 2: Connect the projector to a LAN.

Step 3: Start PC Control Utility Pro 4/Pro 5.

TIP:

- PC Control Utility Pro 4 can be used with a serial connection.

Using on Windows

Step 1: Install PC Control Utility Pro 4 on the computer

NOTE:

- To install or uninstall the program, the Windows user account must have [Administrator] privilege (Windows 8.1, Windows 8, Windows 7, Windows Vista and Windows XP)
- Exit all running programs before installation. If another program is running, the installation may not be completed.

1 Insert the accompanying NEC Projector CD-ROM into your CD-ROM drive.

The menu window will be displayed.

TIP:

If the menu window will not be displayed, try the following procedure.

For Windows 7:

- 1. Click “start” on Windows.**
- 2. Click “All Programs” → “Accessories” → “Run”.**
- 3. Type your CD-ROM drive name (example: “Q:\”) and “LAUNCHER.EXE” in “Name”. (example: Q:\LAUNCHER.EXE)**
- 4. Click “OK”.**
the menu window will be displayed.

2 Click “PC Control Utility Pro 4” on the menu window.

The installation will start.

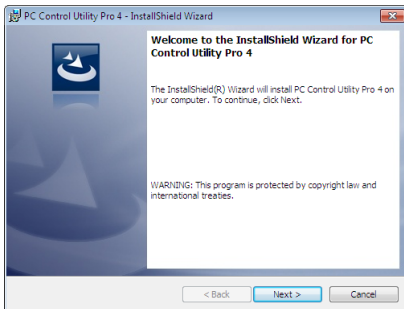

When the installation is complete, the Welcome window will be displayed.

3 Click “Next”.

“END USER LICENSE AGREEMENT” screen will be displayed.

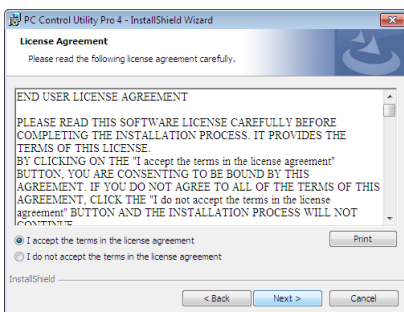

Read “END USER LICENSE AGREEMENT” carefully.

4 If you agree, click “I accept the terms in the license agreement” and then click “Next”.

- *Follow the instructions on the installer screens to complete the installation.*
- *When the installation is complete, you will return to the menu window.*

TIP:

- *Uninstalling PC Control Utility Pro 4*

To uninstall PC Control Utility Pro 4, do the same procedures stated as in “Uninstalling a Software Program”. (→ page 144, 145)

Step 2: Connect the projector to a LAN.

Connect the projector to the LAN by following the instructions in “Connecting to a Wired LAN” (→ page 133) and “10. Controlling the Projector by Using an HTTP Browser” (→ page 42)

Step 3: Start PC Control Utility Pro 4

Click “Start” → “All programs” or “Programs” → “NEC Projector User Supportware” → “PC Control Utility Pro 4” → “PC Control Utility Pro 4”.

NOTE:

- For the Schedule function of the PC Control utility Pro 4 to work, you must have your computer running and not in standby/sleep mode. Select “Power Options” from the “Control Panel” in Windows and disable its standby/sleep mode before running the scheduler.

[Example] For Windows 7:

Select “Control Panel” → “System and Security” → “Power Options” → “Change when the computer sleeps” → “Put the computer to sleep” → “Never”.

NOTE:

- When [NORMAL] is selected for [STANDBY MODE] from the menu, the projector cannot be turned on via the network (wired LAN) connection.
-

TIP:

Viewing the Help of PC Control Utility Pro 4

- **Displaying the Help file of PC Control Utility Pro 4 while it is running.**

Click “Help (H)” → “Help (H) ...” of window of PC Control Utility Pro 4 in this order.

The pop-up menu will be displayed.

- **Displaying the help file using the Start Menu.**

Click “Start” → “All programs” or “Programs” → “NEC Projector User Supportware” → “PC Control Utility Pro 4” → “PC Control Utility Pro 4 Help”.

The Help screen will be displayed.

Using on Mac OS

Step 1: Install PC Control Utility Pro 5 on the computer

1. **Insert the accompanying NEC Projector CD-ROM in your Mac CD-ROM drive.**

The CD-ROM icon will be displayed on the desktop.

2. **Double-click the CD-ROM icon.**

The CD-ROM window will be displayed.

3. **Double-click the “Mac OS X” folder.**

4. **Double-click “PC Control Utility Pro 5.pkg”.**

The installer will start.

5. **Click “Next”.**

“END USER LICENSE AGREEMENT” screen will be displayed.

6. **Read “END USER LICENSE AGREEMENT” and click “Next”.**

The confirmation window will be displayed

7. **Click “I accept the terms in the license agreement”.**

Follow the instructions on the installer screens to complete the installation.

Step 2: Connect the projector to a LAN

Connect the projector to the LAN by following the instructions in “Connecting to a Wired LAN” (→ page 133) and “10. Controlling the Projector by Using an HTTP Browser” (→ page 42)

Step 3: Start PC Control Utility Pro 5

1. **Open your Applications folder in Mac OS.**

2. **Click the “PC Control Utility Pro 5” folder.**

3. **Click the “PC Control Utility Pro 5” icon.**

PC Control Utility Pro 5 will start.

NOTE:

- For the Schedule function of the PC Control utility Pro 5 to work, you must have your computer running and not in sleep mode. Select “Energy Saver” from the “System Preferences” in Mac and disable its sleep mode before running the scheduler.
 - When [NORMAL] is selected for [STANDBY MODE] from the menu, the projector cannot be turned on via the network (wired LAN) connection.
-

TIP:

Viewing the Help of PC Control Utility Pro 5

- **Displaying the Help file of PC Control Utility Pro 5 while it is running.**
- **From the menu bar, click “Help” → “Help” in this order.**

The Help screen will be displayed.

- **Displaying the Help using the Dock**

1. **Open “Application Folder” in Mac OS.**

2. **Click the “PC Control Utility Pro 5” folder.**

3. **Click the “PC Control Utility Pro 5 Help” icon.**

The Help screen will be displayed.

9. Appendix

① Throw distance and screen size

This projector can be used with 3 kinds of optional lenses (sold separately). The chart below shows compatible lenses according to the projector model. Refer to the information on this page and use a lens suited for the installation environment (screen size and throw distance). For instructions on mounting the lens, see page 121.

Projector (model name)	Lens (model)			
	NP34ZL	NP35ZL	NP36ZL	NP37ZL
PX602UL-WH/PX602UL-BK	Yes	Yes	No	Yes
PX602WL-WH/PX602WL-BK	Yes	Yes	Yes	Yes

Yes = can be used, No = cannot be used

Lens types and throw distance

PX602UL-WH/PX602UL-BK

Screen size	Lens model name					
	NP34ZL		NP35ZL		NP37ZL	
	inch	m	inch	m	inch	m
50"	40 - 51	1.0 - 1.3	51 - 64	1.3 - 1.7	63 - 123	1.6 - 3.2
60"	48 - 62	1.2 - 1.6	62 - 77	1.6 - 2.0	76 - 148	2.0 - 3.8
80"	64 - 83	1.7 - 2.1	83 - 104	2.1 - 2.7	103 - 198	2.6 - 5.1
100"	81 - 104	2.1 - 2.6	104 - 130	2.7 - 3.3	129 - 248	3.3 - 6.3
120"	97 - 125	2.5 - 3.2	124 - 156	3.2 - 4.0	155 - 298	4.0 - 7.6
150"	122 - 157	3.1 - 4.0	156 - 195	4.0 - 5.0	194 - 373	4.9 - 9.5
200"	163 - 209	4.1 - 5.3	208 - 261	5.3 - 6.6	260 - 498	6.6 - 12.7
240"	195 - 251	5.0 - 6.4	250 - 313	6.4 - 8.0	312 - 598	7.9 - 15.2
300"	244 - 314	6.2 - 7.9	313 - 392	7.9 - 10.0	391 - 748	9.9 - 19.0

TIP

Calculation of the throw distance from the screen size

NP34ZL lens throw distance (inch/m) = $H \times 0.96$ to $H \times 1.23$: 40"/1.0 m (min.) to 314"/7.9 m (max.)

NP35ZL lens throw distance (inch/m) = $H \times 1.23$ to $H \times 1.54$: 51"/1.3 m (min.) to 392"/10.0 m (max.)

NP37ZL lens throw distance (inch/m) = $H \times 1.53$ to $H \times 2.94$: 63"/1.6 m (min.) to 748"/19.0 m (max.)

"H" (Horizontal) refers to the screen width.

* Figures differ by several % with the table above because the calculation is approximate.

Ex.: Throw distance when projecting on a 150" screen with the PX602UL-WH/PX602UL-BK using the NP35ZL lens:

According to the "Screen Size (for reference)" table (→ page 155), H (screen width) = 127.2"/323.1 cm.

The throw distance is $127.2"/323.1 \text{ cm} \times 1.23$ to $127.2"/323.1 \text{ cm} \times 1.54 = 156.5"/397.4 \text{ cm}$ to $195.9"/497.6 \text{ cm}$ (because of the zoom lens).

PX602WL-WH/PX602WL-BK

Screen size	Lens model name					
	NP34ZL		NP35ZL/NP36ZL		NP37ZL	
	inch	m	inch	m	inch	m
50"	42 - 54	1.1 - 1.4	54 - 68	1.4 - 1.7	67 - 129	1.7 - 3.3
60"	51 - 65	1.3 - 1.7	65 - 81	1.7 - 2.1	80 - 155	2.1 - 4.0
80"	68 - 87	1.7 - 2.2	87 - 109	2.2 - 2.8	108 - 208	2.8 - 5.3
100"	85 - 109	2.2 - 2.8	109 - 136	2.8 - 3.5	135 - 260	3.5 - 6.6
120"	102 - 131	2.6 - 3.3	131 - 164	3.3 - 4.2	163 - 313	4.2 - 8.0
150"	128 - 164	3.3 - 4.2	164 - 205	4.2 - 5.2	204 - 392	5.2 - 10.0
200"	171 - 219	4.4 - 5.6	219 - 274	5.6 - 6.9	273 - 523	6.9 - 13.3
240"	206 - 263	5.2 - 6.7	263 - 329	6.7 - 8.3	328 - 628	8.3 - 15.9
300"	257 - 330	6.5 - 8.3	330 - 411	8.3 - 10.4	411 - 786	10.4 - 19.9

TIP

Calculation of the throw distance from the screen size

NP34ZL lens throw distance (inch/m) = $H \times 1.01$ to $H \times 1.29$: 42"/1.1 m (min.) to 330"/8.3 m (max.)

NP35ZL/NP36ZL lens throw distance (inch/m) = $H \times 1.29$ to $H \times 1.61$: 54"/1.4 m (min.) to 411"/10.4 m (max.)

NP37ZL lens throw distance (inch/m) = $H \times 1.61$ to $H \times 3.08$: 67"/1.7 m (min.) to 786"/19.9 m (max.)

"H" (Horizontal) refers to the screen width.

* Figures differ by several % with the table above because the calculation is approximate.

Ex.: Throw distance when projecting on a 150" screen with the PX602WL-WH/PX602WL-BK using the NP36ZL lens:

According to the "Screen Size (for reference)" table (→ page 155), H (screen width) = 127.2"/323.1 cm.

The throw distance is 127.2"/323.1 cm \times 1.29 to 127.2"/323.1 cm \times 1.61 = 164.1"/416.8 cm to 204.8"/520.2 cm (because of the zoom lens).

Projection range for the different lenses

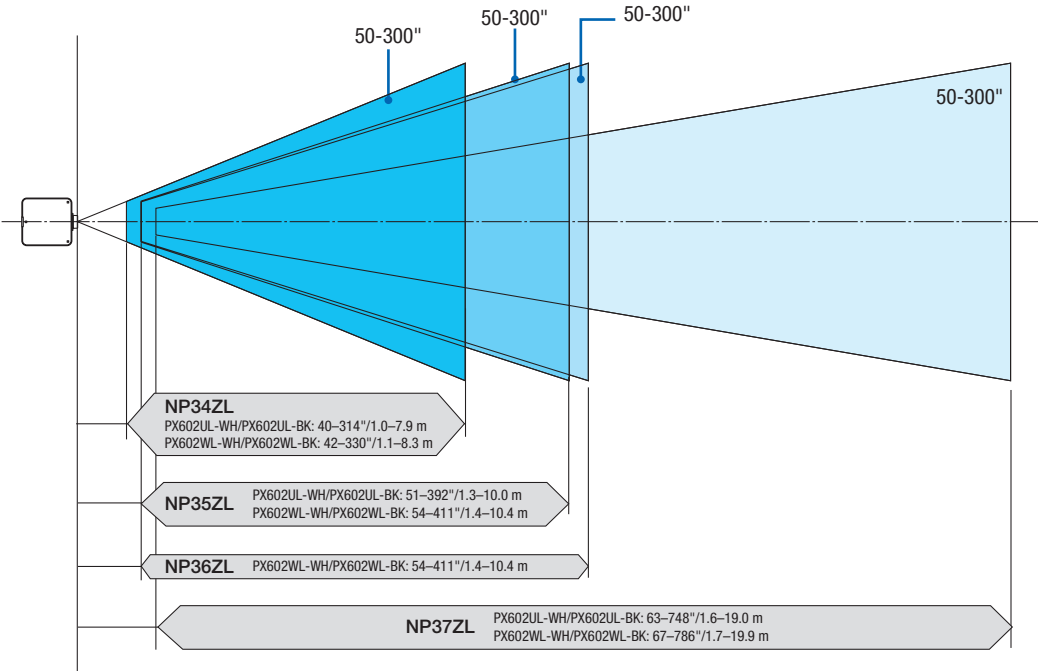

Tables of screen sizes and dimensions

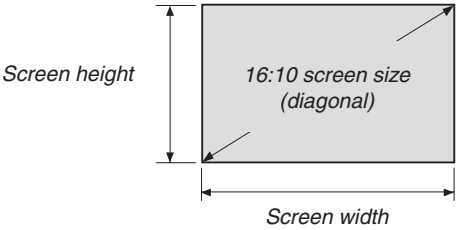

Size (inches)	Screen width		Screen height	
	(inches)	(cm)	(inches)	(cm)
50	42.4	107.7	26.5	63.7
60	50.9	129.2	31.8	80.8
80	67.8	172.3	42.4	107.7
100	84.8	215.4	53.0	134.6
120	101.8	258.5	63.6	161.5
150	127.2	323.1	79.5	201.9
200	169.6	430.8	106.0	269.2
240	203.5	516.9	127.2	323.1
300	254.4	646.2	159.0	403.9

Lens shifting range

This projector is equipped with a lens shift function for adjusting the position of the projected image by using the LENS SHIFT buttons (→ page 19). The lens can be shifted within the range shown below.

NOTE:

- Please do not use the lens shift function when projecting portrait images. Please use it with the lens in the center.

Legend: V “Vertical” refers to the screen height and H “Horizontal” refers to the screen width. The lens shift range is expressed as a ratio of height and width, respectively.

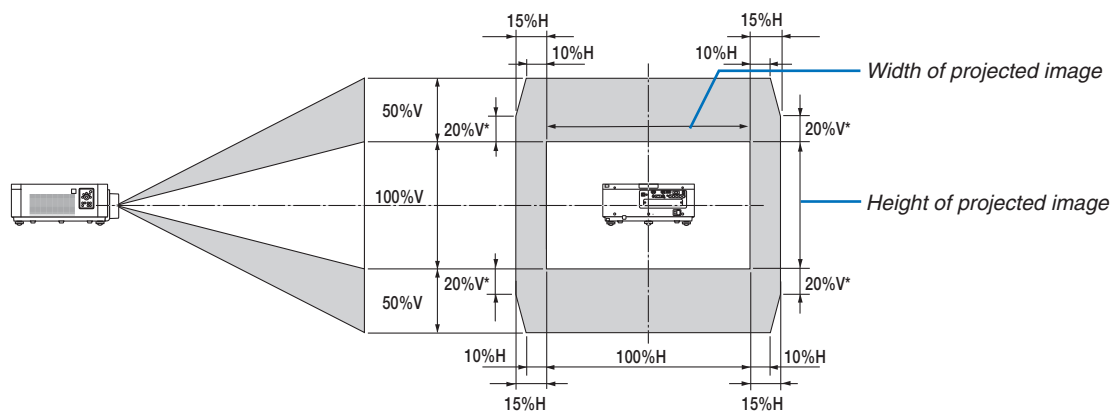

	Value of X
PX602UL-WH/PX602UL-BK	20%V
PX602WL-WH/PX602WL-BK	30%V

* The lens shift range is the same for ceiling installation.

(Example) When using to project on a 150" screen

According to the “Table of screen sizes and dimensions” (→ page 155), $H = 127.2"/323.1$ cm, $V = 79.5"/201.9$ cm.

Adjustment range in the vertical direction: the projected image can be moved upwards $0.5 \times 79.5"/201.9$ cm $\approx 39.8"/101$ cm, downwards approximately 39.8"/101 cm (when the lens is at the center position). Adjustment range in the horizontal direction: the projected image can be moved to the left $0.15 \times 127.2"/323.1$ cm $\approx 19.1"/48$ cm, to the right approximately 19.1"/48 cm.

* Figures differ by several % because the calculation is approximate.

② Mounting the Optional Board (sold separately)

CAUTION

Before mounting or removing the optional board, be sure to turn off the projector, wait for the fans to stop and turn off the main power switch.

Tool needed: Phillips screwdriver (plus-head)

1. Turn off the main power switch of the projector.

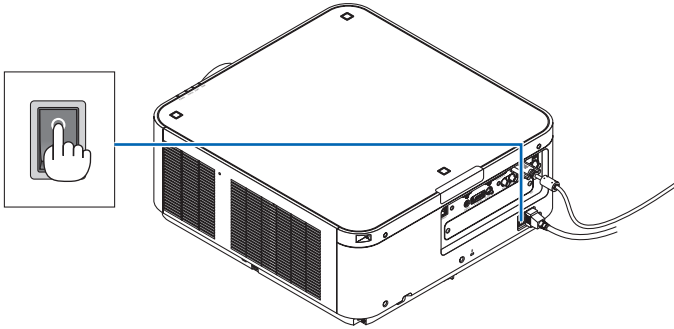

2. Loosen the two screws on the SLOT cover of the terminals.

Remove the two screws and the SLOT cover.

NOTE: Keep the two screws and the slot cover.

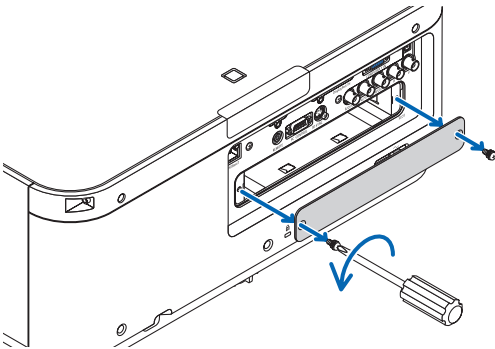

3. Insert the optional board into the slot.

Make sure that the board is inserted into the slot in the correct orientation.

Incorrect orientation may cause miscommunication between the optional board and projector.

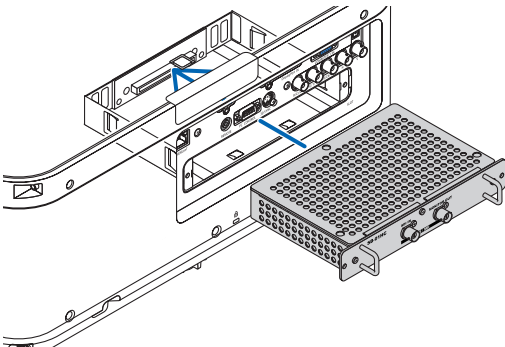

4. Tighten the two screws on both sides of the slot.

- Be sure to tighten the screws.

This will complete installation of the optional board.

To select the optional board source, select SLOT as the input.

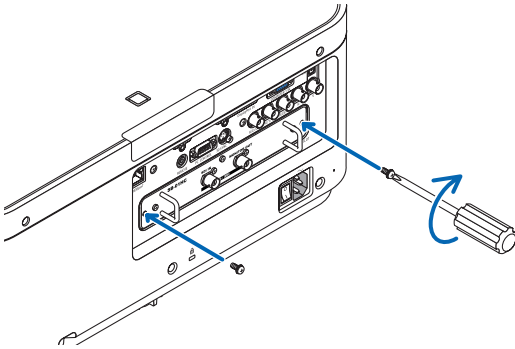

NOTE:

- Mounting the optional board may cause the fans to run in the standby mode for the purpose of cooling depending on the optional board. The fan speed may also increase in order to cool the projector properly. Both of these instances are considered normal and not a malfunction of the projector.
-

③ Compatible Input Signal List

Analog Computer Signal

Signal	Resolution (dots)	Aspect Ratio	Refresh Rate (Hz)
VGA	640 × 480	4 : 3	60/72/75/85/iMac
SVGA	800 × 600	4 : 3	56/60/72/75/85/iMac
XGA	1024 × 768	4 : 3	60/70/75/85/iMac
XGA+	1152 × 864	4 : 3	60/70/75/85
WXGA	1280 × 768 *1	15 : 9	60
	1280 × 800 *1	16 : 10	60
	1360 × 768 *2	16 : 9	60
	1366 × 768 *2	16 : 9	60
Quad-VGA	1280 × 960	4 : 3	60/75/85
SXGA	1280 × 1024	5 : 4	60/75/85
SXGA+	1400 × 1050	4 : 3	60/75
WXGA+	1440 × 900	16 : 10	60
WXGA++	1600 × 900	16 : 9	60
UXGA	1600 × 1200 *3	4 : 3	60/65/70/75
WSXGA+	1680 × 1050	16 : 10	60
WUXGA	1920 × 1200 *3	16 : 10	60 (Reduced Blanking)
2K	2048 × 1080	17 : 9	60
Full HD	1920 × 1080 *3	16 : 9	60
MAC 13"	640 × 480	4 : 3	67
MAC 16"	832 × 624	4 : 3	75
MAC 19"	1024 × 768	4 : 3	75
MAC 21"	1152 × 870 *4	4 : 3	75
MAC 23"	1280 × 1024	5 : 4	65

Component

Signal	Resolution (dots)	Aspect Ratio	Refresh Rate (Hz)
HDTV (1080p)	1920 × 1080	16 : 9	50/60
HDTV (1080i)	1920 × 1080	16 : 9	50/60
HDTV (720p)	1280 × 720	16 : 9	50/60
SDTV (480p)	720 × 480	4:3 / 16:9	60
SDTV (576p)	720 × 576	4:3 / 16:9	50
SDTV (480i)	720 × 480	4:3 / 16:9	60
SDTV (576i)	720 × 576	4:3 / 16:9	50

Composite Video/S-Video

Signal	Aspect Ratio	Refresh Rate (Hz)
NTSC	4 : 3	60
PAL	4 : 3	50
PAL60	4 : 3	60
SECAM	4 : 3	50

HDMI

Signal	Resolution (dots)	Aspect Ratio	Refresh Rate (Hz)
VGA	640 × 480	4 : 3	60
SVGA	800 × 600	4 : 3	60
XGA	1024 × 768	4 : 3	60
HD	1280 × 720 *1	16 : 9	60
WXGA	1280 × 768 *1	15 : 9	60
	1280 × 800 *1	16 : 10	60
	1366 × 768 *2	16 : 9	60
Quad-VGA	1280 × 960	4 : 3	60
SXGA	1280 × 1024	5 : 4	60
SXGA+	1400 × 1050	4 : 3	60
WXGA+	1440 × 900	16 : 10	60
WXGA++	1600 × 900	16 : 9	60
WSXGA+	1680 × 1050	16 : 10	60
UXGA	1600 × 1200 *3	4 : 3	60
Full HD	1920 × 1080 *3	16 : 9	60
WUXGA	1920 × 1200 *3	16 : 10	60 (Reduced Blanking)
2K	2048 × 1080	17 : 9	60
WQHD iMac 27"	2560 × 1440	16 : 9	60
WQXGA	2560 × 1600	16 : 10	60 (Reduced Blanking)
4K	3840 × 2160	16 : 9	23.98/24/25/29.97/30
	4096 × 2160	17 : 9	24
HDTV(1080p)	1920 × 1080	16 : 9	50/60
HDTV(1080i)	1920 × 1080	16 : 9	50/60
HDTV (720p)	1280 × 720	16 : 9	50/60
SDTV (480i/p)	720/1440 × 480	4:3 / 16:9	60
SDTV (576i/p)	720/1440 × 576	4:3 / 16:9	50

HDMI 3D

Signal Resolution (dots)	Refresh Rate (Hz)	Aspect Ratio	3D Format
1920 × 1080p	23.98/24	16 : 9	Frame Packing
	50		Top and Bottom
	59.94/60		Side By Side
1920 × 1080i	50		Side By Side
	59.94/60		Side By Side
	1280 × 720p		50
59.94/60		Side By Side	
		Top and Bottom	
		Frame Packing	
Side By Side			
Top and Bottom			

DisplayPort

Signal	Resolution (dots)	Aspect Ratio	Refresh Rate (Hz)
VGA	640 × 480	4 : 3	60
SVGA	800 × 600	4 : 3	60
XGA	1024 × 768	4 : 3	60
HD	1280 × 720	16 : 9	60
WXGA	1280 × 768 *1	15 : 9	60
	1280 × 800 *1	16 : 10	60
	1366 × 768 *2	16 : 9	60
	1280 × 960	4 : 3	60
Quad-VGA	1280 × 960	4 : 3	60
SXGA	1280 × 1024	5 : 4	60
SXGA+	1400 × 1050	4 : 3	60
WXGA+	1440 × 900	16 : 10	60
WXGA++	1600 × 900	16 : 9	60
WSXGA+	1680 × 1050	16 : 10	60
UXGA	1600 × 1200 *3	4 : 3	60
Full HD	1920 × 1080 *3	16 : 9	60
WUXGA	1920 × 1200 *3	16 : 10	60 (Reduced Blanking)
2K	2048 × 1080	17 : 9	60
WQHD iMac 27"	2560 × 1440	16 : 9	60
WQXGA	2560 × 1600	16 : 10	60 (Reduced Blanking)
4K	3840 × 2160	16 : 9	23.98/24/25/29.97/30
	4096 × 2160	17 : 9	24
HDTV(1080p)	1920 × 1080	16 : 9	50/60
HDTV (1080i)	1920 × 1080	16 : 9	50/60
HDTV (720p)	1280 × 720	16 : 9	50/60
SDTV (480i/p)	720/1440 × 480	4:3 / 16:9	60
SDTV (576i/p)	720/1440 × 576	4:3 / 16:9	50

DisplayPort 3D

Signal Resolution (dots)	Refresh Rate (Hz)	Aspect Ratio	3D Format
1920 × 1080p	23.98/24	16 : 9	Side By Side
			Top and Bottom
	25		Side By Side
			Top and Bottom
50	Side By Side		
	Top and Bottom		
59.94/60	Side By Side		
	Top and Bottom		
1920 × 1080i	50	Top and Bottom	
		Side By Side	
	59.94/60	Top and Bottom	
		Side By Side	
1280 × 720p	50	Side By Side	
		Top and Bottom	
	59.94/60	Frame Packing	
		Side By Side	
	59.94/60	Top and Bottom	

*1 Native resolution on WXGA model (PX602WL-WH/PX602WL-BK)

*2 The projector may fail to display these signals correctly when [AUTO] is selected for [ASPECT RATIO] in the on-screen menu. The factory default is [AUTO] for [ASPECT RATIO]. To display these signals, select [16:9] for [ASPECT RATIO].

*3 Native resolution on WUXGA model (PX602UL-WH/PX602UL-BK)

*4 The projector may fail to display these signals correctly when [AUTO] is selected for [ASPECT RATIO] in the on-screen menu. The factory default is [AUTO] for [ASPECT RATIO]. To display these signals, select [4:3] for [ASPECT RATIO].

- Signals exceeding the projector's resolution are handled with Advanced AccuBlend.
- With Advanced AccuBlend, the size of characters and ruled lines may be uneven and colors may be blurred.
- Upon shipment, the projector is set for signals with standard display resolutions and frequencies, but adjustments may be required depending on the type of computer.

4 Specifications

Model name		PX602UL-WH/PX602UL-BK/PX602WL-WH/PX602WL-BK
Method		Single DLP® chip
Specifications of main parts		
DMD panel	Size	PX602UL-WH/PX602UL-BK: 0.67" (aspect ratio: 16:10) PX602WL-WH/PX602WL-BK: 0.65" (aspect ratio: 16:10)
	Pixels ^(*)	PX602UL-WH/PX602UL-BK: 2,304,000 (1920 dots × 1200 lines) PX602WL-WH/PX602WL-BK: 1,024,000 (1280 dots × 800 lines)
Projection lenses	Zoom	Power zoom (zoom range depends on lens)
	Focus	Power focus
	Lens shifting	Power lens shift
Light source		3.5W Laser Diode
Optical device		Optical isolation by dichroic mirror, combining by dichroic prism
Light output ^(*) ^(*)		6,000 lm
Contrast ratio ^(*) (all white/all black)		10,000:1 with dynamic contrast
Screen size (throw distance)		50" to 300" (throw distance depends on lens)
Color reproducibility		10-bit color processing (approx. 1.07 billion colors)
Scanning frequency	Horizontal	Analog: 15 kHz, 24 to 100 kHz (24 kHz or greater for RGB inputs), conforming to VESA standards Digital: 15 kHz, 24 to 153 kHz, conforming to VESA standards
	Vertical	Analog: 48 Hz, 50 to 85 Hz, 100, 120 Hz conforming to VESA standards Digital: 24, 25, 30, 48 Hz, 50 to 85 Hz, 100, 120 Hz conforming to VESA standards
Main adjustment functions		Power zoom, power focus, power lens shift, input signal switching (HDMI/DisplayPort/BNC/BNC(CV)/BNC(Y/C)/COMPUTER/HDBaseT/SLOT), auto image adjustment, picture magnification, muting (video), power on/standby, on-screen display/selection, etc.
Max. display resolution (horizontal × vertical)		Analog: 1920 × 1200 (handled with Advanced AccuBlend) Digital: 4096 × 2160 (handled with Advanced AccuBlend)
Input signals		
R,G,B,H,V	RGB: 0.7Vp-p/75Ω	
	Y: 1.0Vp-p/75Ω (with Negative Polarity Sync)	
	Cb, Cr (Pb, Pr): 0.7Vp-p/75Ω	
	H/V Sync: 4.0Vp-p/TTL	
	Composite Sync: 4.0Vp-p/TTL Sync on G: 1.0Vp-p/75Ω (with Sync)	
Composite video		1.0Vp-p/75Ω
S-Video	Y: 1.0Vp-p/75Ω	
	C: 286Vp-p/75Ω	
Component	Y: 1.0Vp-p/75Ω (with Sync)	
	Cb, Cr (Pb, Pr): 0.7Vp-p/75Ω	
	DTV: 480i, 480p, 720p, 1080i, 1080p (60Hz) 576i, 576p, 720p, 1080i, 1080p (50Hz)	
	DVD: Progressive signal (50/60Hz)	
Input/output terminals		
Computer/Component	Video input	Mini D-Sub 15-pin × 1, BNC terminal × 5
HDMI	Video input	HDMI® Terminal type A × 1 Deep Color (color depth): 8-/10-/12-bit compatible Colorimetry: RGB, YcbCr444 and YcbCr422 compatible LipSync compatible, HDCP compatible ^(*) , Supports 4K and 3D
	Video output	Repeater
	Audio input	HDMI: Sampling frequency – 32/44.1/48 kHz, Sampling bits – 16/20/24 bits
HDBaseT	Video input	Deep Color (color depth): Support 8/10/12 bits Colorimetry: Support RGB, YCbCr444 and YCbCr422 Support LipSync, HDCP ^(*) , 4K, 3D
	Audio input	Sampling frequency: 32/44.1/48 kHz Sampling bit: 16/20/24 bit
DisplayPort	Video input	DisplayPort × 1 Data rate: 2.7Gbps/1.62Gbps No. lanes: 1 lane/2 lanes/4 lanes Color depth: 6-bit, 8-bit, 10-bit Colorimetry: RGB, YcbCr444 and YcbCr422 compatible HDCP compatible ^(*)
	Audio input	DisplayPort: Sampling frequency – 32/44.1/48 kHz, Sampling bits – 16/20/24 bits
BNC (CV)	Video input	BNC × 1
BNC (Y/C)	Video input	BNC × 2
PC control terminal		D-Sub 9-pin × 1

Model name		PX602UL-WH/PX602UL-BK/PX602WL-WH/PX602WL-BK	
USB port		USB type A × 1	
Ethernet/HDBaseT port		RJ-45 × 1, Supports BASE-TX	
Remote terminal		Stereo mini jack × 1	
3D SYNC output terminal		5 V / 10 mA, synchronized signal output for 3D use	
Usage environment		Operating temperature: 5 to 40°C ^{(*)5} Operating humidity: 20 to 80% (with no condensation) Storage temperature: -10 to 60°C ^{(*)5} Storage humidity: 20 to 80% (with no condensation) Operating altitude: 0 to 3000 m/10,000 feet (760 to 3000 m/2500 to 10,000 feet: Set [FAN MODE] to [HIGH])	
Power supply		100-240 V AC, 50/60Hz	
Power consumption	LIGHT MODE	NORMAL	590 W (100-130 V)/550 W (200-240 V)
		ECO1	460 W (100-130 V)/440 W (200-240 V)
		ECO2	280 W (100-130 V)/270 W (200-240 V)
	STAND-BY MODE	NORMAL	0.5 W
		NETWORK STANDBY	6.0 W
Rated input current		6.8 A-2.5 A	
External dimensions		19.1" (width) × 7.7" (height) × 20.0" (depth)/484.4 (width) × 195.0 (height) × 509.0 (depth) mm (not including the lens hood and protruding parts) 19.1" (width) × 8.5" (height) × 22.6" (depth)/484.4 (width) × 217.0 (height) × 574.8 (depth) mm (including the lens hood and protruding parts)	
Weight		40.8 lbs/18.5 kg (not including lens)	

*1 Effective pixels are more than 99.99%.

*2 This is the light output value that results from setting the [LIGHT MODE] to [NORMAL] and setting the [PRESET] to [HIGH-BRIGHT] while using the NP35ZL lens for NP-PX602UL-WHJD, or NP36ZL lens for NP-PX602WL-WHJD (sold separately). The light output value is lower when setting the [LIGHT MODE] to [ECO1] or [ECO2]. ([ECO1]: about 80%, [ECO2]: about 50%). If any other mode is selected as the [PRESET] mode, the light output value may drop slightly.

*3 Compliance with ISO21118-2005

*4 HDMI® (Deep Color, Lip Sync) with HDCP

What is HDCP/HDCP technology?

HDCP is an acronym for High-bandwidth Digital Content Protection. High bandwidth Digital Content Protection (HDCP) is a system for preventing illegal copying of video data sent over a High-Definition Multimedia Interface (HDMI).

If you are unable to view material via the HDMI input, this does not necessarily mean the projector is not functioning properly. With the implementation of HDCP, there may be cases in which certain content is protected with HDCP and might not be displayed due to the decision/intention of the HDCP community (Digital Content Protection, LLC).

Video: Deep Color; 8/10/12-bit, LipSync

Audio: LPCM; up to 2 ch, sample rate 32/44.1/48 KHz, sample bit; 16/20/24-bit

*5 The upper threshold of operating temperature is changed depends on the altitude.

0–760 m (0–2500 feet): 5–40°C

760–1500 m (2500–5000 feet): 5–35°C

1500–3000 m (5000–10000 feet): 5–30°C

35 to 40°C – “Forced eco mode”

• These specifications and the product’s design are subject to change without notice.

For additional information visit:

US: <http://www.necdisplay.com/>

Europe: <http://www.nec-display-solutions.com/>

Global: <http://www.nec-display.com/global/index.html>

For information on our optional accessories, visit our website or see our brochure.

Option lens (sold separately)**Option lens for PX602UL-WH/PX602UL-BK**

NP34ZL	Power lens shift, Power zoom, Power focus (Throw ratio 0.96–1.23:1, F 2.3–2.57, f = 0.55–0.71"/14.03–17.95 mm)
NP35ZL	Power lens shift, Power zoom, Power focus (Throw ratio 1.23–1.54:1, F 2.0–2.32, f = 0.71–0.89"/18.07–22.59 mm)
NP37ZL	Power lens shift, Power zoom, Power focus (Throw ratio 1.53–2.94:1, F 2.3–3.39, f = 0.89–1.69"/22.56–42.87 mm)

Option lens for PX602WL-WH/PX602WL-BK

NP34ZL	Power lens shift, Power zoom, Power focus (Throw ratio 1.01–1.29:1, F 2.3–2.57, f = 0.55–0.71"/14.03–17.95 mm)
NP35ZL	Power lens shift, Power zoom, Power focus (Throw ratio 1.29–1.61:1, F 2.0–2.32, f = 0.71–0.89"/18.07–22.59 mm)
NP36ZL	Power lens shift, Power zoom, Power focus (Throw ratio 1.29–1.61:1, F 2.0–2.32, f = 0.71–0.89"/18.07–22.59 mm)
NP37ZL	Power lens shift, Power zoom, Power focus (Throw ratio 1.61–3.08:1, F 2.3–3.39, f = 0.89–1.69"/22.56–42.87 mm)

5 Cabinet Dimensions

Unit: mm (inch)

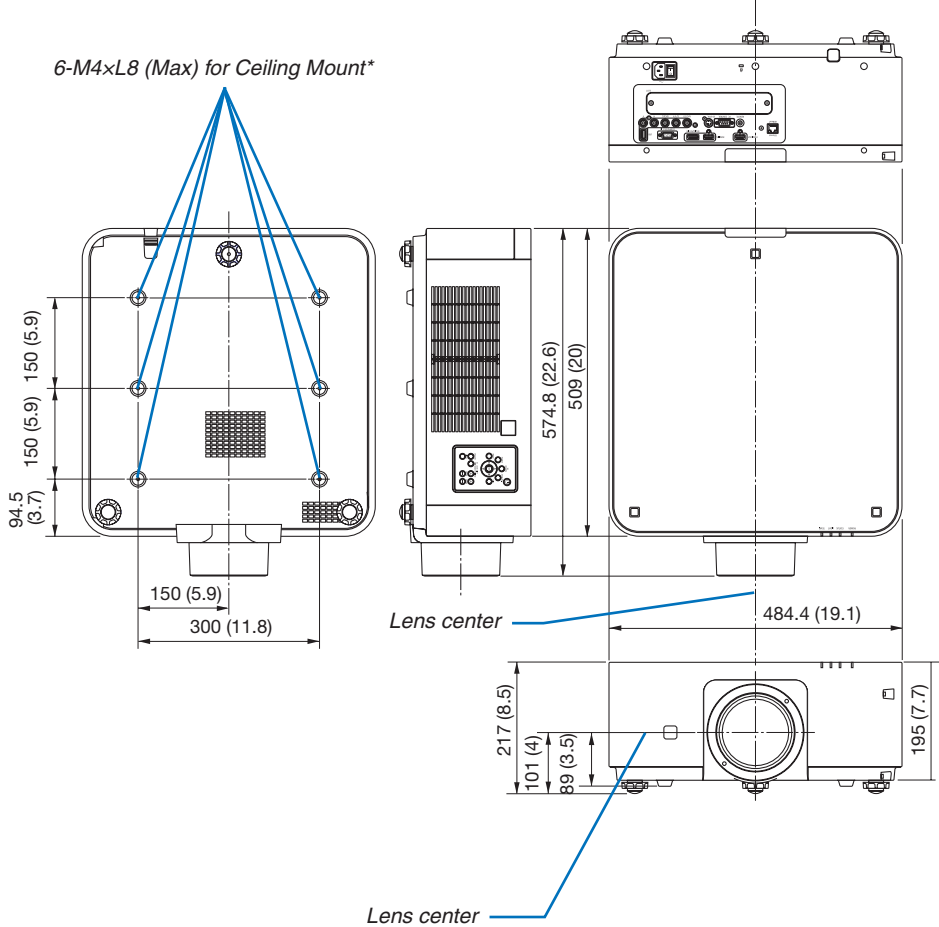

* The screws specifications for Ceiling Mount:
Screw type: M4
Maximum screw length: 8 mm (0.31")
Minimum screw length: 6 mm (0.24")

⚠ CAUTION:

Do not attempt to mount the projector on a ceiling yourself.
The projector must be installed by qualified technicians in order to ensure proper operation and reduce the risk of bodily injury.
In addition, the ceiling must be strong enough to support the projector and the installation must be in accordance with any local building codes. Please consult your dealer for more information.

⑥ Pin assignments and signal names of main terminals

COMPUTER 1 IN/ Component Input Terminal (Mini D-Sub 15 Pin)

Connection and signal level of each pin

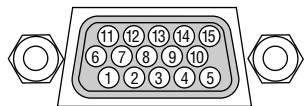

Signal Level

Video signal : 0.7Vp-p (Analog)

Sync signal : TTL level

Pin No.	RGB Signal (Analog)	YCbCr Signal
1	Red	Cr
2	Green or Sync on Green	Y
3	Blue	Cb
4	Ground	
5	Ground	
6	Red Ground	Cr Ground
7	Green Ground	Y Ground
8	Blue Ground	Cb Ground
9	No Connection	
10	Sync Signal Ground	
11	No Connection	
12	Bi-directional DATA (SDA)	
13	Horizontal Sync or Composite Sync	
14	Vertical Sync	
15	Data Clock	

HDMI IN Terminal (Type A)

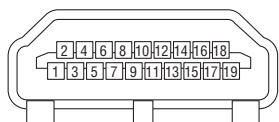

Pin No.	Signal	Pin No.	Signal
1	TMDS Data 2+	11	TMDS Clock Shield
2	TMDS Data 2 Shield	12	TMDS Clock-
3	TMDS Data 2-	13	CEC
4	TMDS Data 1+	14	Disconnection
5	TMDS Data 1 Shield	15	SCL
6	TMDS Data 1-	16	SDA
7	TMDS Data 0+	17	DDC/CEC grounding
8	TMDS Data 0 Shield	18	+5 V power supply
9	TMDS Data 0-	19	Hot plug detection
10	TMDS Clock +		

DisplayPort IN Terminal

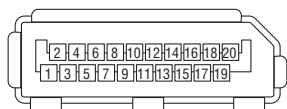

Pin No.	Signal	Pin No.	Signal
1	Main link lane 3-	11	Grounding 0
2	Grounding 3	12	Main link lane 0+
3	Main link lane 3+	13	Configuration 1
4	Main link lane 2-	14	Configuration 2
5	Grounding 2	15	Supplementary channel +
6	Main link lane 2+	16	Grounding 4
7	Main link lane 1-	17	Supplementary channel -
8	Grounding 1	18	Hot plug detection
9	Main link lane 1+	19	Return
10	Main link lane 0-	20	+3.3 V power supply

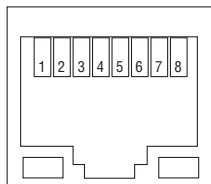
Ethernet/HDBaseT Port (RJ-45)

Pin No.	Signal
1	TxD+/HDBT0+
2	TxD-/HDBT0-
3	RxD+/HDBT1+
4	Disconnection/HDBT2+
5	Disconnection/HDBT2-
6	RxD-/HDBT1-
7	Disconnection/HDBT3+
8	Disconnection/HDBT3-

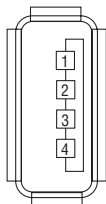
USB Port (Type A)

Pin No.	Signal
1	V _{BUS}
2	D-
3	D+
4	Grounding

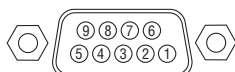
PC CONTROL Port (D-Sub 9 Pin)**Communications protocol**

Pin No.	Signal
1	Unused
2	RxD reception data
3	TxD transmission data
4	Unused
5	Grounding
6	Unused
7	RTS transmission request
8	CTS transmission allowed
9	Unused

7 Troubleshooting

This section helps you resolve problems you may encounter while setting up or using the projector.

Indicator Messages

POWER Indicator

Indicator display		Projector status	Procedure
Off		Power is off.	–
Flashing	Blue (short flashes)	Preparing to turn power on	Wait a while.
	Blue (long flashes)	Off timer (enabled) Program timer (off time enabled)	–
	Orange (short flashes)	Projector cooling	Wait a while.
	Orange (long flashes)	Program timer (on time enabled)	–
Lit	Blue	Power on	–
	Red	Standby mode (NORMAL)	–
	Orange	Standby mode (NETWORK STANDBY)	–

STATUS Indicator

Indicator display		Projector status	Procedure
Off		No problem, or STANDBY MODE - "NETWORK STANDBY"	–
Flashing	Red	The lens hood is not fixed on, or the safety cover (sold separately) is not fixed on during the portrait projection	Check fixing conditions of the lens hood and the safety cover.
	Red (cycle of 4 times flash)	Fan problem	The cooling fan has stopped turning. Contact an NEC projector customer support center for repairs.
Flashing	Orange	Network conflict	It is not possible to connect the projector's built-in LAN and wireless LAN simultaneously to the same network. To connect the projector's built-in LAN and wireless LAN simultaneously, connect them to different networks.
Lit	Green	STANDBY MODE in sleep mode*	–
	Orange	Button has been pressed while projector is in key lock mode	The projector's keys are locked. The setting must be canceled to operate the projector. (→ Page 104)
		Projector's ID number and remote control's ID number do not match	Check the control IDs. (→ Pages 105)

* Sleep mode refers to the state whereby the functional restrictions due to the standby mode setting are removed.

LIGHT Indicator

Indicator display		Projector status	Procedure
Off		The light module is turned off.	–
Lit	Green	Light module lit	–

TEMP. Indicator

Indicator display		Projector status	Procedure
Off		No problem	
Flashing	Red (cycles of 2)	Temperature problem	The temperature protector has been activated. If the room temperature is high, move the projector to a cool place. If the problem still persists, contact an NEC projector customer support center.
Lit	Orange	High surrounding temperature (Forced ECO Mode)	The surrounding temperature is high. Lower the room temperature.

If the temperature protector is activated

If the projector's internal temperature rises abnormally, the light module turns off and the temperature indicator flashes (repeatedly in cycles of 2).

It may happen that the projector's temperature protector is simultaneously activated and the projector's power turns off. If this happens, do the following:

- Unplug the power cord from the power outlet.
- If using in a place where the surrounding temperature is high, move the projector to a different, cool place.
- If there is dust in the ventilation holes, clean. (→ page 141)
- Wait as such about 1 hour for the projector's internal temperature to lower.

Common Problems & Solutions

(→ “POWER/STATUS/LIGHT Indicator” on page 168, 169.)

Problem	Check These Items
Does not turn on or shut down	<ul style="list-style-type: none"> • Check that the power cord is plugged in and that the power button on the projector cabinet or the remote control is on. (→ pages 13, 14) • Check to see if the projector has overheated. If there is insufficient ventilation around the projector or if the room where you are presenting is particularly warm, move the projector to a cooler location. • The light module may fail to light. Wait a full minute and then turn on the power again. • Set [FAN MODE] to [HIGH] when using the projector at altitudes approximately 760 m/2500 feet or higher. Using the projector at altitudes approximately 760 m/2500 feet or higher without setting to [HIGH] can cause the projector to overheat and the projector could shut down. If this happens, wait a couple minutes and turn on the projector. (→ page 97) If you turn on the projector immediately after the light module is turned off, the fans run without displaying an image for some time and then the projector will display the image. Wait for a moment. • In case it's hard to think the trouble is not caused on the above mentioned conditions, unplug the power cord from the outlet. Then wait 5 minutes before plugging it in again. (→ page 24)
Will turn off	<ul style="list-style-type: none"> • Ensure that the [OFF TIMER], [AUTO POWER OFF] or [PROGRAM TIMER] is off. (→ page 100, 115)
No picture	<ul style="list-style-type: none"> • Check if the appropriate input is selected. (→ page 16) If there is still no picture, press the SOURCE button or one of the source buttons again. • Ensure your cables are connected properly. • Use menu to adjust the brightness and contrast. (→ page 76) • Check that the SHUTTER (lens shutter) or AV MUTE (image off) buttons are not pressed. • Reset the settings or adjustments to factory preset levels using the [RESET] in the Menu. (→ page 116) • Enter your registered keyword if the Security function is enabled. (→ page 35) • If the HDMI IN or the DisplayPort IN signal cannot be displayed, try the following. <ul style="list-style-type: none"> - Reinstall your driver for the graphics card built in your computer, or use the updated driver. For reinstalling or updating your driver, refer to the user guide accompanied with your computer or graphics card, or contact the support center for your computer manufacturer. Install the updated driver or OS on your own responsibility. We are not liable for any trouble and failure caused by this installation. • Signals may not be supported depending on the HDBaseT transmission device. IR and RS232C cannot be used in certain cases as well. • Be sure to connect the projector and notebook PC while the projector is in standby mode and before turning on the power to the notebook PC. In most cases the output signal from the notebook PC is not turned on unless connected to the projector before being powered up. * If the screen goes blank while using your remote control, it may be the result of the computer's screen-saver or power management software. • See also the page 172.
Picture suddenly becomes dark	<ul style="list-style-type: none"> • Check if the projector is in the Forced ECO mode because of too high ambient temperature. If this is the case, lower the internal temperature of the projector by selecting [HIGH] for [FAN MODE]. (→ page 97)
Color tone or hue is unusual	<ul style="list-style-type: none"> • Check if an appropriate color is selected in [WALL COLOR]. If so, select an appropriate option. (→ page 97) • Adjust [HUE] in [PICTURE]. (→ page 77)
Image isn't square to the screen	<ul style="list-style-type: none"> • Reposition the projector to improve its angle to the screen. (→ page 18) • Use the Keystone correction function to correct the trapezoid distortion. (→ page 32)
Picture is blurred	<ul style="list-style-type: none"> • Adjust the focus. (→ page 21) • Reposition the projector to improve its angle to the screen. (→ page 18) • Ensure that the distance between the projector and screen is within the adjustment range of the lens. (→ page 153) • Has the lens been shifted by an amount exceeding the guaranteed range? (→ page 156) • Condensation may form on the lens if the projector is cold, brought into a warm place and is then turned on. Should this happen, let the projector stand until there is no condensation on the lens.
Image is scrolling vertically, horizontally or both	<ul style="list-style-type: none"> • Check the computer's resolution and frequency. Make sure that the resolution you are trying to display is supported by the projector. (→ page 159) • Adjust the computer image manually with the Horizontal/Vertical in the [IMAGE OPTIONS]. (→ page 79)

Problem	Check These Items
Remote control does not work	<ul style="list-style-type: none">• Install new batteries. (→ page 10)• Make sure there are no obstacles between you and the projector.• Stand within 22 feet (7 m) of the projector. (→ page 11)
Indicator is lit or blinking	<ul style="list-style-type: none">• See the POWER/STATUS/LIGHT Indicator. (→ page 168, 169)
Cross color in RGB mode	<ul style="list-style-type: none">• Press the AUTO ADJ. button on the projector cabinet or the remote control. (→ page 23)• Adjust the computer image manually with [CLOCK]/[PHASE] in [IMAGE OPTIONS] in the menu. (→ page 78)

For more information contact your dealer.

If there is no picture, or the picture is not displayed correctly.

- Power on process for the projector and the PC.

Be sure to connect the projector and notebook PC while the projector is in standby mode and before turning on the power to the notebook PC.

In most cases the output signal from the notebook PC is not turned on unless connected to the projector before being powered up.

NOTE: You can check the horizontal frequency of the current signal in the projector's menu under Information. If it reads "0kHz", this means there is no signal being output from the computer. (→ page 117 or go to next step)

- Enabling the computer's external display.

Displaying an image on the notebook PC's screen does not necessarily mean it outputs a signal to the projector. When using a PC compatible laptop, a combination of function keys will enable/disable the external display. Usually, the combination of the "Fn" key along with one of the 12 function keys gets the external display to come on or off. For example, NEC laptops use Fn + F3, while Dell laptops use Fn + F8 key combinations to toggle through external display selections.

- Non-standard signal output from the computer

If the output signal from a notebook PC is not an industry standard, the projected image may not be displayed correctly. Should this happen, deactivate the notebook PC's LCD screen when the projector display is in use. Each notebook PC has a different way of deactivate/reactivate the local LCD screens as described in the previous step. Refer to your computer's documentation for detailed information.

- Image displayed is incorrect when using a Mac

When using a Mac with the projector, set the DIPswitch of the Mac adapter (not supplied with the projector) according to your resolution. After setting, restart your Mac for the changes to take affect.

For setting display modes other than those supported by your Mac and the projector, changing the DIP switch on a Mac adapter may bounce an image slightly or may display nothing. Should this happen, set the DIP switch to the 13" fixed mode and then restart your Mac. After that, restore the DIP switches to a displayable mode and then restart the Mac again.

NOTE: A Video Adapter cable manufactured by Apple Computer is needed for a MacBook which does not have a mini D-Sub 15-pin terminal.

- Mirroring on a MacBook

* When using the projector with a MacBook, output may not be set to 1024 × 768 unless "mirroring" is off on your MacBook. Refer to owner's manual supplied with your Mac computer for mirroring.

- Folders or icons are hidden on the Mac screen

Folders or icons may not be seen on the screen. Should this happen, select [View] → [Arrange] from the Apple menu and arrange icons.

8 PC Control Codes and Cable Connection

PC Control Codes

Function	Code Data							
POWER ON	02H	00H	00H	00H	00H	02H		
POWER OFF	02H	01H	00H	00H	00H	03H		
INPUT SELECT HDMI	02H	03H	00H	00H	02H	01H	A1H	A9H
INPUT SELECT DisplayPort	02H	03H	00H	00H	02H	01H	A6H	AEH
INPUT SELECT BNC	02H	03H	00H	00H	02H	01H	02H	0AH
INPUT SELECT BNC(CV)	02H	03H	00H	00H	02H	01H	06H	0EH
INPUT SELECT BNC(Y/C)	02H	03H	00H	00H	02H	01H	0BH	13H
INPUT SELECT COMPUTER	02H	03H	00H	00H	02H	01H	01H	09H
INPUT SELECT HDBaseT	02H	03H	00H	00H	02H	01H	20H	28H
INPUT SELECT SLOT	02H	03H	00H	00H	02H	01H	ABH	B3H
PICTURE MUTE ON	02H	10H	00H	00H	00H	12H		
PICTURE MUTE OFF	02H	11H	00H	00H	00H	13H		

NOTE: Contact your local dealer for a full list of the PC Control Codes if needed.

Cable Connection

Communication Protocol

Baud rate38400 bps
 Data length8 bits
 ParityNo parity
 Stop bit.....One bit
 X on/off.....None
 Communications procedure.....Full duplex

NOTE: Depending on the equipment, a lower baud rate may be recommended for long cable runs.

PC Control Terminal (D-SUB 9P)

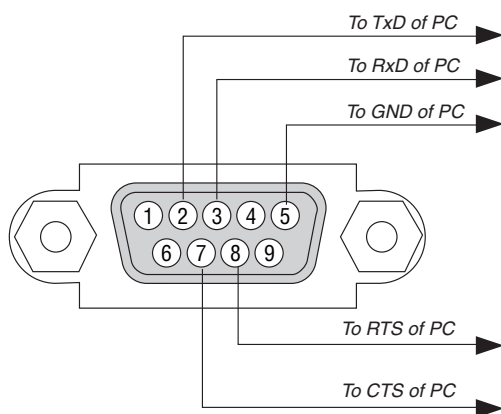

NOTE 1: Pins 1, 4, 6 and 9 are no used.

NOTE 2: Jumper "Request to Send" and "Clear to Send" together on both ends of the cable to simplify cable connection.

NOTE 3: For long cable runs it is recommended to set communication speed within projector menus to 9600 bps.

9 Troubleshooting Check List

Before contacting your dealer or service personnel, check the following list to be sure repairs are needed also by referring to the “Troubleshooting” section in your user’s manual. This checklist below will help us solve your problem more efficiently.

* Print this page and the next page for your check.

Frequency of occurrence always sometimes (How often? _____) other (_____)

Power

- No power (POWER indicator does not light blue). See also “Status Indicator (STATUS)”.
 - Power cord’s plug is fully inserted into the wall outlet.
 - No power even though you press and hold the POWER button.
 - The main power switch is in the “ON (I)” position.
- Shut down during operation.
 - Power cord’s plug is fully inserted into the wall outlet.
 - [AUTO POWER OFF] is turned off (only models with the [AUTO POWER OFF] function).
 - [OFF TIMER] is turned off (only models with the [OFF TIMER] function).

Video and Audio

- No image is displayed from your PC or video equipment to the projector.
 - Still no image even though you connect the projector to the PC first, then start the PC.
 - Enabling your notebook PC’s signal output to the projector.
 - *A combination of function keys will enable/disable the external display. Usually, the combination of the “Fn” key along with one of the 12 function keys turns the external display on or off.*
 - No image (blue or black background, no display).
 - Still no image even though you press the AUTO ADJUST button.
 - Still no image even though you carry out [RESET] in the projector’s menu.
 - Signal cable’s plug is fully inserted into the input terminal
 - A message appears on the screen.
(_____)
 - The source connected to the projector is active and available.
 - Still no image even though you adjust the brightness and/or the contrast.
 - Input source’s resolution and frequency are supported by the projector.
- Image is too dark.
 - Remains unchanged even though you adjust the brightness and/or the contrast.
- Image is distorted.
 - Image appears to be trapezoidal (unchanged even though you carry out the [KEYSTONE] adjustment).
- Parts of the image are lost.
 - Still unchanged even though you press the AUTO ADJUST button.
 - Still unchanged even though you carry out [RESET] in the projector’s menu.
- Image is shifted in the vertical or horizontal direction.
 - Horizontal and vertical positions are correctly adjusted on a computer signal.
 - Input source’s resolution and frequency are supported by the projector.
 - Some pixels are lost.
- Image is flickering.
 - Still unchanged even though you press the AUTO ADJUST button.
 - Still unchanged even though you carry out [RESET] in the projector’s menu.
 - Image shows flickering or color drift on a computer signal.
 - Still unchanged even though you change [FAN MODE] from [HIGH] to [AUTO].
- Image appears blurry or out of focus.
 - Still unchanged even though you checked the signal’s resolution on PC and changed it to projector’s native resolution.
 - Still unchanged even though you adjusted the focus.

Other

- Remote control does not work.
 - No obstacles between the sensor of the projector and the remote control.
 - Projector is placed near a fluorescent light that can disturb the infrared remote controls.
 - Batteries are new and are not reversed in installation.
- Buttons on the projector cabinet do not work (only models with the [CONTROL PANEL LOCK] function)
 - [CONTROL PANEL LOCK] is not turned on or is disabled in the menu.
 - Still unchanged even though you press and hold the SOURCE button for a minimum of 10 seconds.

In the space below please describe your problem in detail.

Information on application and environment where your projector is used

Projector

Model number:
 Serial No.:
 Date of purchase:
 Light module operating time (hours):
 Eco Mode: OFF ON
 Information on input signal:
 Horizontal synch frequency [] kHz
 Vertical synch frequency [] Hz
 Synch polarity H (+) (-)
 V (+) (-)
 Synch type Separate Composite
 Sync on Green
 STATUS Indicator:
 Steady light Orange Green
 Flashing light [] cycles
 Remote control model number:

Installation environment

Screen size: inch
 Screen type: White matte Beads Polarization
 Wide angle High contrast
 Throw distance: feet/inch/m
 Orientation: Ceiling mount Desktop
 Power outlet connection:
 Connected directly to wall outlet
 Connected to power cord extender or other (the number of connected equipment _____)
 Connected to a power cord reel or other (the number of connected equipment _____)

Computer

Manufacturer:
 Model number:
 Notebook PC / Desktop
 Native resolution:
 Refresh rate:
 Video adapter:
 Other:

Video equipment

VCR, Blu-ray player, Video camera, Video game or other
 Manufacturer:
 Model number:

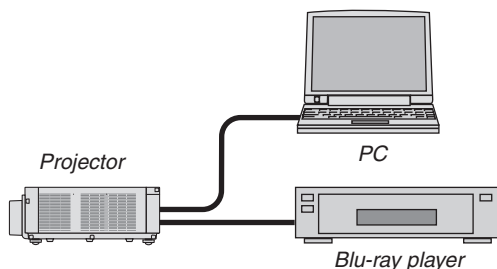

Signal cable

NEC standard or other manufacturer's cable?
 Model number: Length: inch/m
 Distribution amplifier
 Model number:
 Switcher
 Model number:
 Adapter
 Model number:

NEC