



OWNER'S MANUAL

LG Digital Signage (MONITOR SIGNAGE)

Please read this manual carefully before operating the your set and retain it for future reference.

55XF2B

55XS2B

TABLE OF CONTENTS

3 SAFETY PRECAUTIONS

- 3 Precautions In Installing the Product
- 4 Precautions to the AC Adapter and Electrical Power
- 5 Precautions In Moving the Product
- 5 Precautions In Using the Product
- 5 Mounting on a Wall

6 LICENSES

7 ASSEMBLY AND PREPARATION

- 7 Optional Accessories
- 8 Parts and Buttons
- 9 Portrait Layout
- 10 Attaching and removing the LG Logo Bracket
- 11 Installing on a Wall

13 REMOTE CONTROL

15 MAKING CONNECTIONS

- 15 Connecting to a PC
- 15 External Device Connection
- 16 Daisy Chain Monitors
- 17 - Using the Multi Display Mode Function
- 18 Using the Input List

18 ENTERTAINMENT

- 18 Using My Media
- 18 - Connecting USB Storage Devices
- 20 - Files Supported by My Media
- 23 - Viewing Videos

- 24 - Viewing Photos
- 24 - Listening to Music
- 24 - Settings
- 25 SuperSign Contents
- 25 Information
- 25 File Manager
- 26 PICTURE ID Settings

27 USER SETTINGS

- 27 Main Menu Settings
- 27 - Quick Settings
- 28 - Picture Settings
- 32 - Sound Settings
- 33 - Network Settings
- 35 - General Settings

37 TROUBLESHOOTING

40 PRODUCT SPECIFICATIONS

43 IR CODES

45 TO CONTROL MULTIPLE PRODUCTS

- 45 Connecting the Cable
- 45 RS-232C Configurations
- 45 Communication Parameter
- 46 Command Reference List
- 48 Transmission/Reception Protocol

Safety precautions

Please read these safety precautions carefully before using the product.

WARNING

If you ignore the warning message, you may be seriously injured or there is a possibility of accident or death.

CAUTION

If you ignore the caution message, you may be slightly injured or the product may be damaged.

WARNING

- Indoor Use Only. (Only for 5SXS2B model)

Precautions In Installing the Product

WARNING

- Keep away from heat sources like electrical heaters.
 - ▶ Electrical shock, fire, malfunction, or deformation may occur.
- Keep the packing anti-moisture material or vinyl packing out of the reach of children.
 - ▶ Anti-moisture material is harmful if swallowed. If swallowed by mistake, force the patient to vomit and visit the nearest hospital. Additionally, vinyl packing can cause suffocation. Keep it out of the reach of children.
- Do not put heavy objects on the product or sit upon it.
 - ▶ If the product collapses or is dropped, you may be injured. Children must pay particular attention.
- Do not leave the power or signal cable unattended on the pathway.
 - ▶ The passerby can trip or fall, which can cause electrical shock, fire, product breakdown, or injury.
- Install the product in a neat and dry place.
 - ▶ Dust or moisture can cause electrical shock, fire or product damage.
- If you can smell smoke or other odors or hear a strange sound unplug the power cord and contact the service center.
 - ▶ If you continue to use without taking proper measures, electrical shock or fire can occur.
- If you dropped the product or the case is broken, turn off the product and unplug the power cord.
 - ▶ If you continue to use without taking proper measures, electrical shock or fire can occur. Contact the service center.
- Do not drop an object on or apply impact to the product. Do not throw any toys or objects on the product screen.
 - ▶ It can cause injury to human, problem to product and damage the display.
- Do not let the product fall or drop when connecting it with an external device.
 - ▶ This may cause injury and/or damage to the product.
- When connecting it to a game device, keep a distance of four times

the diagonal measurement of the screen from the device.

- ▶ If the product falls because of the short cable, this may cause injury and/or damage to the product.
- Leaving a fixed image on the screen for a long time may cause damage to the screen and cause image burn-in. To use the product for a long period of time, use a screen saver on the PC or utilize the residual image prevention function on the product, and when the product is not used, turn off the power. Burn-in and related problems are not covered by the warranty on this product.
- Do NOT install this product on a wall where there is high risk of exposure to oil fumes or mist.
 - ▶ This may damage product and cause it to fail.

CAUTION

- Make sure the product ventilation holes are not blocked. Install the product in a suitably wide place (more than 10 cm from the wall)
 - ▶ If you install the product too close to the wall, it may be deformed or fire can break out due to internal heat.
- Do not block the ventilation hole of the product by a tablecloth or curtain.
 - ▶ The product can be deformed or fire can break out due to overheating inside the product.
- Install the product on a flat and stable place that has no risk of dropping the product.
 - ▶ If the product is dropped, you may be injured or the product may be broken.
- Install the product where no EMI occurs.
- Keep the product away from direct sunlight.
 - ▶ The product can be damaged.
- If you install the product in a place that does not meet the recommended conditions, this may cause serious damage to the product's picture quality, life cycle, and appearance. Please check with LG or a qualified installer before installing. This caution applies to a place where there is an abundance of fine dust or oil mist, chemical substances are used, the temperature is very high or low, the humidity is very high, or the product is likely to remain turned on for a long period of time (airport and train station). failure to do so will invalidate the warranty.
- Do not install the product in an area with poor ventilation (e.g. on a bookshelf, in a closet) or outside and avoid placing on cushions or carpets.
- In addition, do not install it where there are heating objects such as lighting equipment.

Precautions to the AC Adapter and Electrical Power

WARNING

- If water or any foreign substance goes inside the product (TV, monitor, power cord, or AC adapter), disconnect the power cord immediately and contact the service center.
 - ▶ Otherwise, this may cause a fire or electric shock due to damage to the product.
- Do not touch the power plug or AC adapter with wet hands. If the pins of the plug are wet or dusty, wipe and dry them before use.
 - ▶ Otherwise, this may cause a fire or electric shock.
- Make sure to completely insert the power cord into the AC adapter.
 - ▶ If loosely connected, the poor connection may cause a fire or electric shock.
- Be sure to use power cords and AC adapters provided or approved by LG Electronics, Inc.
 - ▶ The use of non-approved products may cause a fire or electric shock.
- When unplugging the power cord, always pull it by the plug. Do not bend the power cord with excessive force.
 - ▶ The power line can be damaged, which may cause electric shock or fire.
- Be careful not to step or place heavy objects (electronic appliances, clothing, etc.) on the power cord or AC adapter. Be careful not to damage the power cord or AC adapter with sharp objects.
 - ▶ Damaged power cords may cause a fire or electric shock.
- Never disassemble, repair or modify the power cord or AC adapter.
 - ▶ This may cause a fire or electric shock.
- Make sure to connect the power cable to the grounded current.
 - ▶ You may be electrocuted or injured.
- Use the rated voltage only.
 - ▶ The product can be damaged, or you may be electrocuted.
- In the presence of thunder and lightning, never touch the power cord and signal cable because it can be very dangerous.
 - ▶ It can cause electric shock.
- Do not connect several extension cords, electrical appliances, or electrical heaters to a single outlet. Use a power strip with a grounding terminal designed for exclusive use with the computer.
 - ▶ A fire can break out due to overheating.
- Do not touch the power plug with wet hands. Additionally, if the cord pin is wet or covered with dust, dry the power plug completely or wipe dust off.
 - ▶ You may be electrocuted due to excess moisture.
- If you don't intend to use the product for a long time, unplug the power cable from the product.
 - ▶ Covering dust can cause a fire, or insulation deterioration can cause electric leakage, electric shock or fire.
- Fix the power cable completely.
 - ▶ If the power cable is not fixed completely, a fire can break out.
- Do not insert a conductor (like a metal chopstick) into one end of the power cable while the other end is connected to the input terminal on the wall. Additionally, do not touch the power cable right after plugging into the wall input terminal.
 - ▶ You may be electrocuted.
- The appliance coupler is used as the disconnect device.
- Please make sure the device is installed near the wall outlet to which it is connected and that the outlet is easily accessible.

- As long as this unit is connected to the AC wall outlet, it is not disconnected from the AC power source even if the unit is turned off.

CAUTION

- Be sure to keep the outlet, AC adapter, and pins of the power plug clean from dust and etc.
 - ▶ This may cause a fire.
- Do not unplug the power cord while the product is in use.
 - ▶ Electrical shock can damage the product.
- Use only the power cord supplied with the unit. If you use another power cord, make sure that it is certified by the applicable national standards when not provided by the supplier. If the power cable is faulty in any way, please contact the manufacturer or the nearest authorized repair service provider for a replacement.

Precautions In Moving the Product

! WARNING

- Make sure to turn off the product.
 - ▶ You may be electrocuted or the product can be damaged.
- Make sure to remove all cables before moving the product.
 - ▶ You may be electrocuted or the product can be damaged.
- Make sure the panel faces forward and hold it with both hands to move. If you drop the product, the damaged product can cause electric shock or fire. Contact an authorized the service center for repair.
- Make sure the product is turned off, unplugged, and all cables have been removed. It may take 2 or more people to carry larger apparatus. Do not press against or put stress on the front panel of the apparatus.

! CAUTION

- Do not shock the product when moving it.
 - ▶ You may be electrocuted or the product can be damaged.
- Do not dispose the product-packing box. Use it when you move.

Precautions In Using the Product

! WARNING

- Do not disassemble, repair or modify the product at your own discretion.
 - ▶ Fire or electric shock accident can occur.
 - ▶ Contact the service center for check, calibration or repair.
- When the display is to be left unattended for an extended period of time, unplug it from the wall outlet.
- Keep the product away from water.
 - ▶ Fire or electric shock accident can occur.
- Do not shock or scratch the front and sides of the screen with metallic objects.
 - ▶ Otherwise, it may cause damage to the screen.
- Avoid high temperatures and humidity.

! CAUTION

- Do not put or store inflammable substances near the product.
 - ▶ There is a danger of explosion or fire due to careless handling of the inflammable substances.
- When cleaning the product, unplug the power cord and scrub gently with a soft cloth to prevent scratching. Do not clean with a wet cloth or spray water or other liquids directly onto the product. An electric shock may occur. (Do not use chemicals such as benzene, paint thinners, or alcohol)
- Take a rest from time to time to protect your vision.
- Keep the product clean at all times.
- Take a comfortable and natural position when working with a product to relax the muscles.
- Take a regular break when working with a product for a long time.
- Do not press strongly upon the panel with a hand or sharp object

- such as nail, pencil, or pen, or make a scratch on it.
- Keep the proper distance from the product.
 - ▶ Your vision may be impaired if you look at the product too closely.
- Set the appropriate resolution and clock by referring to the User's Guide.
 - ▶ Your vision can be impaired.
- Use authorized detergent only when cleaning the product. (Do not use benzene, thinner, or alcohol.)
 - ▶ Product can be deformed.
- Do not expose to dripping or splashing and do not place objects filled with liquids, such as vases, cups, etc. on or over the apparatus (e.g. on shelves above the unit).
- Batteries should not be exposed to excessive heat. For example, keep away from direct sunlight, open fireplace, and electric heaters.
- Do NOT place non-rechargeable batteries in charging device.
- Using headsets (earphones) for a long time or listening loudly can cause damage to your hearing.
- Spray water onto a soft cloth 2 to 4 times, and use it to clean the front frame; wipe in one direction only. Too much moisture may cause staining.

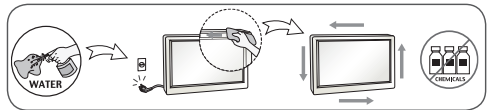

- Do not use products using high voltage around the Monitor. (e.g., a bug zapper)
 - ▶ Monitor may have malfunction as its electrical shock.

Mounting on a Wall

- Do NOT install this product by yourself as you may injure yourself or cause damage to product. Please contact service personnel authorised by manufacturer.

LICENSES

Supported licenses may differ by model. For more information of the licenses, visit www.lg.com.



The terms HDMI and HDMI High-Definition Multimedia Interface, and the HDMI logo are trademarks or registered trademarks of HDMI Licensing LLC in the United States and other countries.



This DivX Certified® device has passed rigorous testing to ensure it plays DivX® video. To play purchased DivX movies, first register your device at vod.divx.com. Find your registration code in the DivX VOD section of your device setup menu. DivX Certified® to play DivX® video up to HD 1080p, including premium content. DivX®, DivX Certified® and associated logos are trademarks of DivX, LLC and are used under license.

Covered by one or more of the following U.S. patents: 7,295,673; 7,460,668; 7,515,710; 7,519,274.



Manufactured under license from Dolby Laboratories. Dolby and the double-D symbol are trademarks of Dolby Laboratories.



For DTS patents, see <http://patents.dts.com>. Manufactured under license from DTS Licensing Limited. DTS, the Symbol, & DTS and the Symbol together are registered trademarks, and DTS 2.0 Channel is a trademark of DTS, Inc. © DTS, Inc. All Rights Reserved.

! NOTE

- The warranty will not cover any damage caused by using the product in an excessively dusty environment.

ASSEMBLY AND PREPARATION



CAUTION

- Always use genuine components to ensure safety and product performance.
- The product warranty will not cover damage or injury caused by the use of counterfeit components.



NOTE

- The accessories provided with your product may vary depending on the model or region.
- Product specifications or contents in this manual may be changed without prior notice due to upgrade of product functions.
- SuperSign Software & Manual
 - Downloading from the LG Electronics website.
 - Visit the LG Electronics website (www.lgcommercial.com/supersign) and download the latest software for your model.

Optional Accessories

Without prior notice, optional accessories are subject to change to improve the performance of the product, and new accessories may be added. The illustrations in this manual may differ from the actual product and accessories.

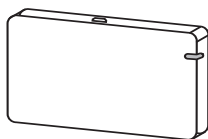

AN-WF500

Wi-Fi Dongle kit

(Only for **XS2B model)



NOTE

- Optional accessories are available for some models. If necessary, please purchase them separately.

Parts and Buttons

55XF2B

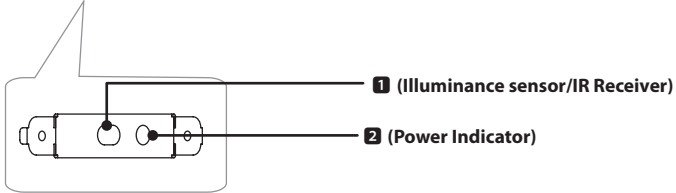
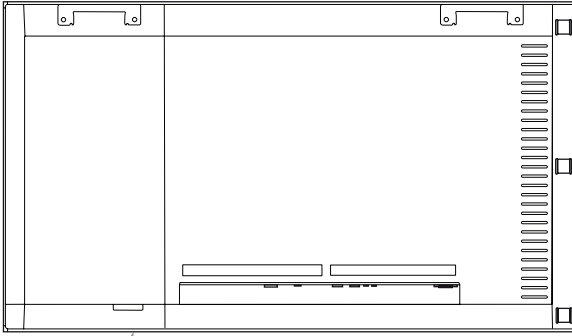

55XS2B

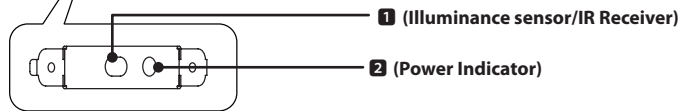
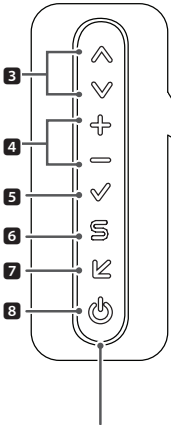
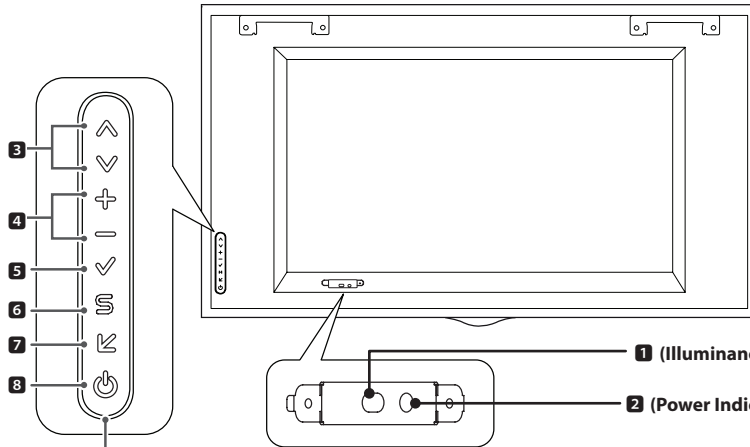

Screen Buttons

- **1 Illuminance sensor:** Adjusts the screen brightness by measuring the amount of light.
IR Receiver: This is where the unit receives signals from the remote control.
- **2 Power Indicator:** This Indicator lights up red when the display operates normally (on mode). If the display is in sleep mode (in Power Saving mode), this indicator changes color to amber.
- **3:** Adjusts up and down.
- **4:** Moves left and right.
- **5:** Change the input signal.
- **6:** Accesses the main menus, or saves your input and exits the menus.
- **7:** Change the input signal.
- **8:** Turns the power on or off.



NOTE

- You can set the status of the power indicator in **Installation** -> **Signage Setup**.
- You can adjust the volume by using the remote control.

Portrait Layout

When installing in a portrait layout, rotate the monitor clockwise 90 degrees (when facing the screen).

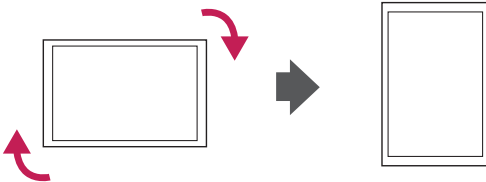

Attaching and removing the LG Logo Bracket

(Only for **XS2B model)

Removing the LG Logo

- 1 Lay a clean cloth on the floor, and then put the monitor on it with the screen face down. Using a screwdriver, remove the screw that secures the LG Logo Bracket to the bottom rear of the monitor.

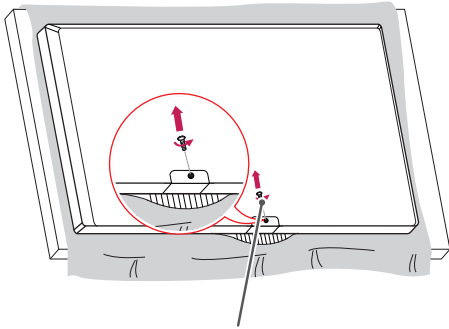

LG Logo Bracket

- 2 After removing the screw, remove the LG Logo. When re-attaching the LG Logo, repeat the process in reverse order.

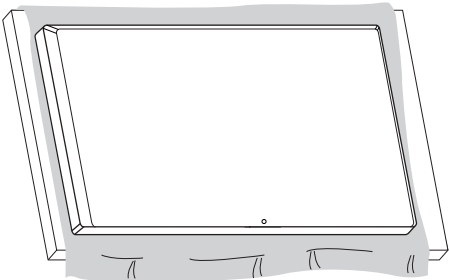

Attaching the LG Logo on the right side

- 1 Lay a clean cloth on the floor, and then put the monitor on it with the screen face down. Using a screwdriver, remove the screw that secures the LG Logo Bracket to the bottom rear of the monitor.

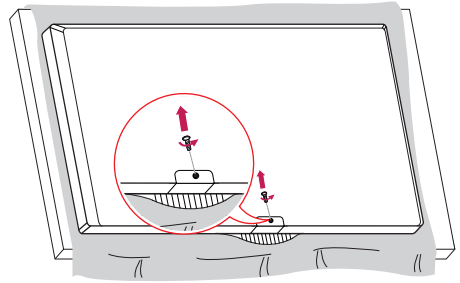

- 2 After removing the screw, remove the LG Logo. Align with the hole on the left side to attach the LG Logo Bracket with a screw.

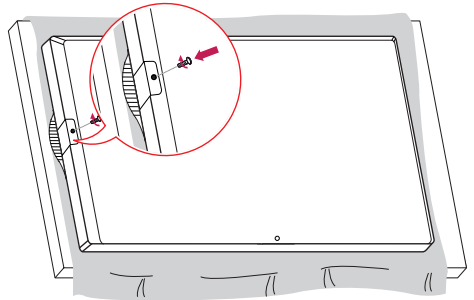

Installing on a Wall

(Only for **XS2B model)

For proper ventilation, allow a clearance of 100 mm on each side and from the wall. Detailed installation instructions are available from your dealer, see the optional Tilt Wall Mounting Bracket Installation and Setup Guide.

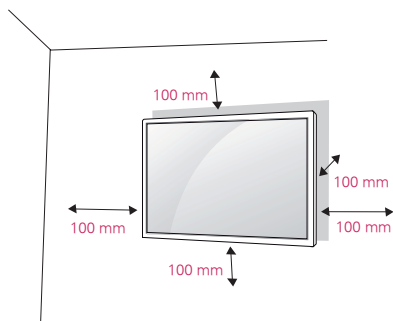

To install your monitor on a wall, attach a wall mounting bracket (optional part) to the back of the monitor.

Make sure that the wall mounting bracket is securely fixed to the monitor and to the wall.

- 1 Use only screws and wall mounting brackets that conform to VESA standards.
- 2 Screws which are longer than standard length may damage the inside of the monitor.
- 3 A non-VESA standard screw may damage the product and cause the monitor to fall. LG Electronics is not liable for any accidents related to the use of non-standard screws.
- 4 Please use VESA standard as below.

- 785 mm and above

* Fixing screws: Diameter 8.0 mm x Pitch 1.25 mm x Length 12 mm

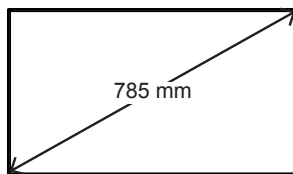

CAUTION

- Disconnect the power cord before moving or installing the monitor to avoid risk of electric shock.
- If you install the monitor on a ceiling or slanted wall, it may fall and result in injury. Use an authorized LG wall mount and contact your local dealer or qualified personnel to assist with the installation.
- Do not over tighten the screws as this may damage the monitor and void your warranty.
- Use only screws and wall mounting brackets that meet the VESA standard. Any damage or injuries caused by misuse or use of improper accessories are not covered by the warranty.
- To prevent injury, this apparatus must be securely attached to the wall in accordance with the installation instructions. (This pertains only to Australia and New Zealand.)



NOTE

- The wall mount kit includes the installation guide and all necessary parts.
- The wall mounting bracket is optional. You can obtain additional accessories from your local dealer.
- The length of screws required may differ depending on the wall mount. Be sure to use the correct length.
- For more information, please refer to the guide provided with the wall mount.

Securing the monitor to a wall (optional)

(Only for **XS2B model)

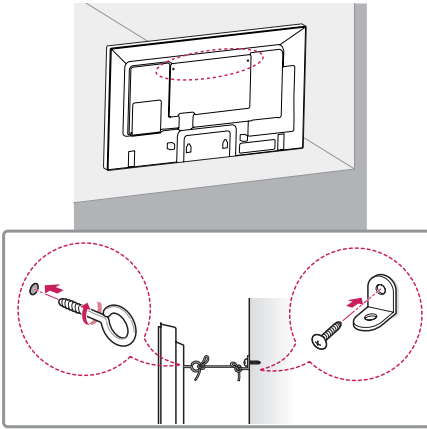

- 1 Insert and tighten the eyebolts, or brackets and bolts on the back of the monitor.
- If there are already bolts inserted in the eyebolts' position, remove the other bolts first.
- 2 Mount the wall brackets with the bolts to the wall. Match the location of the wall bracket and the eyebolts on the rear of the monitor.
- 3 Connect the eyebolts and wall brackets tightly with a sturdy cord.
Make sure the securing cord is horizontal with the flat surface.

! WARNING

- If the monitor is not positioned in a sufficiently stable location, there is a danger that it will fall. Many injuries, particularly to children, can be avoided by taking simple precautions such as:
 - » Using cabinets or stands recommended by the manufacturer.
 - » Only using furniture that can safely support the monitor.
 - » Ensuring the monitor is not overhanging the edge of the supporting furniture.
 - » Not placing the monitor on tall furniture (for example, cupboards or bookcases) without anchoring both the furniture and the monitor to a suitable support.
 - » Not placing cloth or other materials between the monitor and supporting furniture.
 - » Educating children about the dangers of climbing on furniture to reach the monitor or its controls.

! CAUTION

- Make sure that children do not climb on or hang from the monitor.

! NOTE

- Use a platform or cabinet that is large and strong enough to support the monitor securely.
- Brackets, bolts, and cords are sold separately. You can obtain additional accessories from your local retail store.
- The illustration shows a general example of installation and may look different from the actual product.

REMOTE CONTROL

The descriptions in this manual are based on the buttons on the remote control. Please read this manual carefully to use the monitor correctly.

To install batteries, open the battery cover, place batteries (1.5 V AAA) matching \oplus and \ominus terminals to the labels inside the compartment, and close the battery cover.

To remove the batteries, perform the installation actions in reverse. The illustrations may differ from the actual accessories.



CAUTION

- Do not mix old and new batteries, as this may damage the remote control.
- Be sure to point the remote control toward the remote control sensor on the monitor.

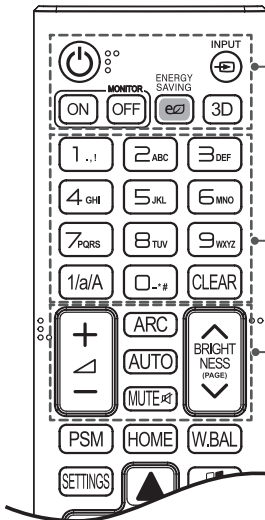
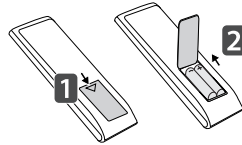

⏻ (POWER) Turns the monitor on or off.

MONITOR ON Turns the monitor on.

MONITOR OFF Turns the monitor off.

ENERGY SAVING (eZ) Reduces power consumption by adjusting peak screen brightness.

INPUT Selects the input mode.

3D This model does not support this.

1/a/A Toggles between numerical and alphabetical.

(Depending upon the model, this feature may not be supported.)

Number and Alphabet buttons

Enters numerical or alphabetical characters depending upon the setting.
(Depending upon the model, this feature may not be supported.)

CLEAR Deletes the entered numerical or alphabetical character.

(Depending upon the model, this feature may not be supported.)

Volume Up/Down Button Adjusts the volume.

ARC Selects the Aspect Ratio mode.

AUTO Automatically adjusts picture position and minimizes image instability (available for RGB input only). (Depending upon the model, this feature may not be supported.)

MUTE Mutes all sounds.

BRIGHTNESS Adjusts the brightness of the display. PAGE Function is not supported in the this model. (Depending upon the model, this feature may not be supported.)

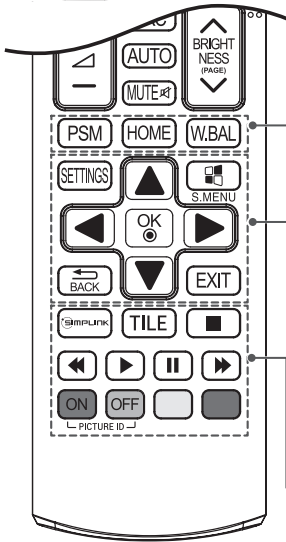

PSM Selects the Picture Mode.

HOME Activates the Launcher.

W.BAL This model does not support this.

SETTINGS Accesses the main menus or saves your input and exit menus.

S.MENU SuperSign menu key (Depending upon the model, this feature may not be supported.)

Navigation Buttons Scrolls through menus or options.

OK Selects menus or options and confirms your input.

BACK Allows you to move back one step in the user interaction function.

EXIT Quit all OSD tasks and applications.

SIMPLINK Allows you to control various multimedia devices to enjoy multimedia simply by using the remote control through the SimpLink menu. (Depending upon the model, this feature may not be supported.)

TILE This model does not support this.

PICTURE ID ON/OFF When the Picture ID number matches the Set ID number, you can control whichever monitor you want in multi-display format.

USB Menu Control Buttons Controls media playback.

MAKING CONNECTIONS

You can connect various external devices to your monitor. Change the input mode and select the external device you want to connect.

For more information about external device connections, see the user manual provided with each device.

Connecting to a PC

Some of the cables are not provided.

This monitor supports the Plug & Play* feature.

* Plug & Play: a feature that enables a PC to recognize devices attached by the user without device configuration or user intervention when powering up.

External Device Connection

Connect a HD receiver, DVD, or VCR player to the monitor and select an appropriate input mode.

Some of the cables are not provided. For the best picture and sound quality, connecting external devices to your monitor using HDMI cables is recommended.



NOTE

- For the best image quality, using the monitor with HDMI connection is recommended.
- To comply with the standard specifications of the product, use a shielded interface cable with a ferrite core, such as a DVI-D cable.
- If you turn the monitor on when the set is cold, the screen may flicker. This is normal.
- Sometimes red, green, or blue spots may appear on the screen. This is normal.
- Use a High Speed HDMI®/TM cable.
- Use a certified cable with the HDMI logo attached. If you do not use a certified HDMI cable, the screen may not display or a connection error may occur.
- Recommended HDMI Cable Types
 - High-Speed HDMI®/TM Cable
 - High-Speed HDMI®/TM Cable with Ethernet
- If you cannot hear any sound in HDMI mode please check your PC settings. Some PCs require you to manually change the default audio output to HDMI.
- If you want to use HDMI-PC mode, you must set your PC/DTV to PC mode.
- You may experience compatibility issues if you use HDMI-PC mode.
- Make sure the power cable is disconnected.
- If you connect a gaming device to the monitor, use the cable provided with the gaming device.
- It is recommended to use the speakers that are provided as optional accessories.
- High Speed HDMI®/TM cables transmit a HD signal up to 1080p and higher.



CAUTION

- Connect the signal input cable and tighten it by turning the screws clockwise.
- Do not press the screen with your finger for a prolonged period as this may result in temporary distortion on the screen.
- Avoid displaying static images on the screen for a long period of time to prevent image burn. Use a screensaver if possible.
- A wireless communication device near your monitor can affect the image.

Daisy Chain Monitors

To use different products connected to each other, connect one end of the signal input cable (DP Cable) to the DP Out connector of Monitor 1 and connect the other end to the DP In connector of the other product.

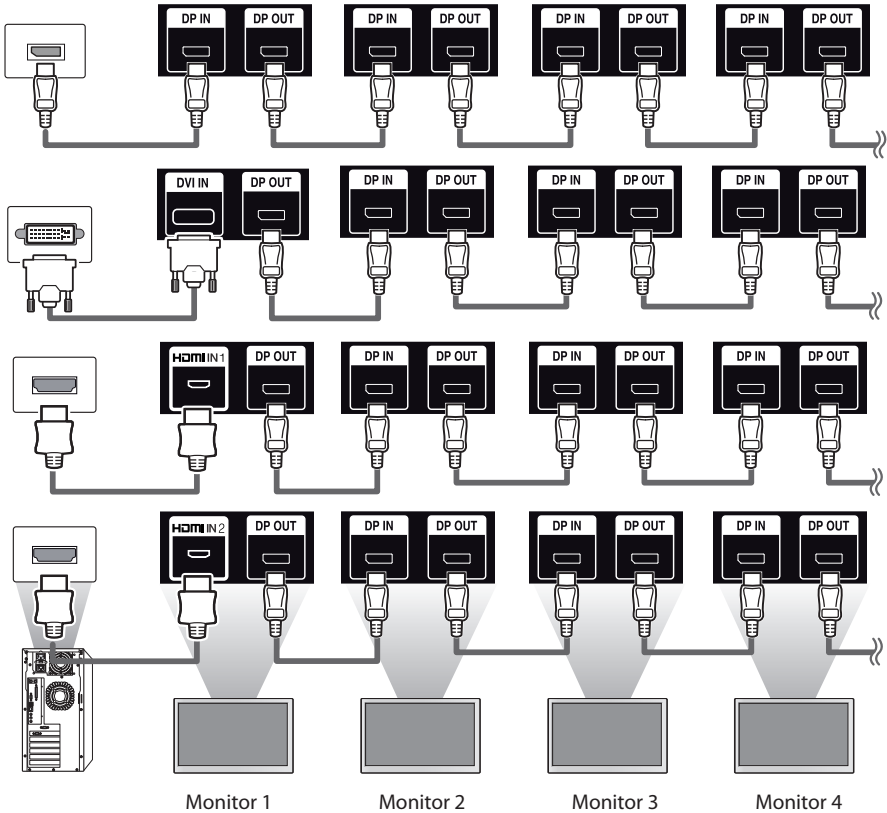

! NOTE

- If you set the tile mode using DVI-D or HDMI, you will not be able to watch HDCP-encrypted content.
- If the signal cable between the product and your PC is too long, make sure to use the Booster or optical cable.
- DP Cable - Use a DP cable that is certified to DP1.1a (SST), DP1.2 (MST) or higher. (Only for 55XF2B model)

Using the Multi Display Mode Function

(Only for 55XF2B model)

The **Multi Display Mode** function displays a video signal received from DP In either in single mode (SST: Single Stream Transport) or multi-mode (MST: Multi Stream Transport) through DP Out.

- This function can be configured in the **Installation Menu** (For more information, refer to the Installation Menu manual.)
- If it is **On**, the image of each display is displayed in multi-mode.
- If it is **Off**, the image of each display is displayed in single mode.
- The multi-mode is available in a PC supporting DISPLAYPORT 1.2.
- Multi-mode can connect as many as four monitors. (at the recommended resolution)
- When this function is used, your monitor may not work properly depending on the video card. Reboot the PC after setting the function to Off for stable screen output when not in use.
- In case of using DVI-D/HDMI Input to DP daisy chain, please set 'Multi Display mode function' to off.
- This feature is designed to be compatible with the MP700 Media player.

Using the Input List

HOME → 

- HDMI1 -> HDMI2 -> DISPLAYPORT -> DVI-D

ENTERTAINMENT

Using My Media

Connecting USB Storage Devices

Connect a USB storage device such as a USB flash memory or an external hard drive to the display and use multimedia features.



CAUTION

- Do not turn off the monitor or remove a USB storage device when the **My Media** screen is activated. This could result in loss of files or damage to the USB storage device.
- Back up files you have saved on a USB storage device frequently, as loss or damage to the files may be not covered by the warranty.

Tips for using USB storage devices

- Only a USB storage device can be recognized.
- A USB device does not work effectively when it is connected via a USB hub.
- A USB storage device using an automatic recognition program may not be recognized.
- A USB storage device using its own driver may not be recognized.
- The recognition speed of a USB storage device may depend on each device.
- Please do not turn off the display or unplug the USB storage device when the connected device is working. If the USB storage device is suddenly disconnected, the stored files or the device itself may be damaged.
- Please do not connect a USB storage device which was modified to work on a PC. The device may cause the monitor to malfunction or the content fail to be played. Use only a USB storage device which contains normal music, image or video files.
- A USB storage device formatted as a utility program not supported by Windows may not be recognized.
- A USB storage device (over 0.5 A) which requires an external power supply must be connected to a power supply separately. If it is not, the device may not be recognized.
- Please connect the USB storage device using the cable provided by the device manufacturer.
- Some USB storage devices may not be supported or operate smoothly.
- File alignment method of USB storage devices is similar to that of Window XP and filenames can recognize up to 100 English characters.
- Back up important files regularly as data stored on a USB storage device may be damaged. We will not be responsible for any data loss.
- If the USB HDD does not have an external power source, the USB device may not be detected. To ensure the device is detected, connect the external power source.
 - Use a power adapter for an external power source. We do not provide a USB cable for an external power source.
- If your USB storage device has multiple partitions, or if you use a USB multi-card reader, you can use up to four partitions or USB storage devices.
- If a USB storage device is connected to a USB multi-card reader, its volume data may not be detected.
- If the USB storage device does not work properly, disconnect and reconnect it.
- Detection speed differs from device to device.
- If the USB storage device is connected in Standby Mode, the specific hard disk will automatically be loaded when the display is turned on.
- The recommended capacity is 1 TB or less for a USB external hard drive and 32 GB or less for USB memory stick.
- Any device with more than the recommended capacity may not work properly.
- If a USB external hard drive with an "Energy Saving" function does not work, try turning the hard drive off and on again.
- USB storage devices below USB 2.0 are also supported but may not function correctly in the Videos.
- A maximum of 999 sub-folders or files can be recognized under one folder.

Files Supported by My Media

Supported External Subtitle Format

- *.smi, *.srt, *.sub (MicroDVD, SubViewer 1.0/2.0), *.ass, *.ssa, *.txt (TMPlayer), *.psb (PowerDivX), *.dcs (DLP Cinema)

To use Select Play,

HOME →  → Photos/ Videos/ Music → 

- **Play Selection:** plays back selected content.

To set Device Selection,

HOME →  → Photos/ Videos/ Music → 

- **Device Selection:** import contents from the selected device.

Supported Internal Subtitle Format

- FULL HD Video
1920 X 1080: XSUB (Supports internal subtitles generated from DivX6)

Supported Video Codec

Extension	Codec	
.asf .wmv	Videos	VC-1 Advanced Profile (excluding WMVA), VC-1 Simple and Main Profiles
	Audio	WMA Standard (excluding WMA v1/WMA Speech), WMA 9 Professional
.divx .avi	Videos	DivX3.11, DivX4, DivX5, DivX6, XVID (except 3 warp-point GMC), H.264/AVC, Motion Jpeg, MPEG-4
	Audio	MPEG-1 Layer I, II, MPEG-1 Layer III (MP3), Dolby Digital, Dolby Digital Plus, LPCM, ADPCM, DTS
.mp4 .m4v .mov	Videos	H.264/AVC, MPEG-4
	Audio	AAC, MPEG-1 Layer III (MP3)
.3gp .3g2	Videos	H.264/AVC, MPEG-4
	Audio	AAC, AMR-NB, AMR-WB
.mkv	Videos	MPEG-2, MPEG-4, H.264/AVC, VP8
	Audio	Dolby Digital, PCM, DTS, MPEG-1 Layer I, II, MPEG-1 Layer III (MP3), Vorbis, AAC
.ts .trp .tp .mts	Videos	H.264/AVC, MPEG-2
	Audio	MPEG-1 Layer I, II, MPEG-1 Layer III (MP3), Dolby Digital, Dolby Digital Plus, AAC, PCM
.mpg .mpeg .dat	Videos	MPEG-1, MPEG-2
	Audio	MPEG-1 Layer I, II, MPEG-1 Layer III (MP3)
.vob	Videos	MPEG-1, MPEG-2
	Audio	Dolby Digital, MPEG-1 Layer I, II, DVD-LPCM

Supported Audio File

File Format	Item	Information
.MP3	Bit rate	32 Kbps to 320 Kbps
	Sample freq.	16 KHz to 48 KHz
	Support	MPEG1, MPEG2, Layer2, Layer3
.wav	Support	PCM
.ogg	Support	Vorbis
.wma	Support	WMA

Supported Photo File

File Format	Format	Item
2D (jpeg, jpg, jpe)	JPEG	<ul style="list-style-type: none"> • Minimum : 64 x 64 • Maximum: Normal Type: 15360 (W) x 8640 (H) / Progressive Type: 1920 (W) x 1440 (H)
2D (png)	PNG	<ul style="list-style-type: none"> • Minimum : 64 x 64 • Maximum: 1920 (W) x 1080 (H)
2D (bmp)	BMP	<ul style="list-style-type: none"> • Minimum : 64 x 64 • Maximum: 1920 (W) x 1080 (H)

Viewing Videos

Play video files on display. All of the saved video files are shown in your display.

To play video files on display

HOME →  → Videos

Tips for Playing Video Files

- Some user-created subtitles may not work properly.
- Some special characters in subtitles are not rendered.
- HTML tags are not supported in subtitles.
- Subtitles in languages other than the supported languages are not available.
- The screen may suffer temporary interruptions (image stoppage, faster playback, etc.) when the audio language is changed.
- A damaged video file may not play correctly, or some player functions may not be usable.
- Video files produced with some encoders may not be played correctly.
- If the video and audio structure of a recorded file is not interleaved, either video or audio is outputted.
- Depending on the frame, HD videos with a maximum of 1920 x 1080 @ 25/30 P or 1280 x 720 @ 50/60P are supported.
- Depending on the frame, videos with resolutions higher than 1920 x 1080 @ 25/30 P or 1280 x 720 @ 50/60 P may not play correctly.
- Video files other than the specified types and formats may not play correctly.
- Maximum bit rate of playable video file is 20 Mbps. (Motion JPEG: 10 Mbps only)
- We cannot guarantee smooth playback of files encoded level 4.1 or higher in H.264 / AVC.
- Video files more than 30 GB in file size are not supported.
- A DivX video file and its subtitle file must be located in the same folder.
- A video file name and its subtitle file name must be identical for it to be displayed.
- Playing a video via a USB connection that does not support high-speed connection may not function correctly.
- Files encoded with GMC (Global Motion Compensation) may not be played.

! NOTE

- Option values changed in **Videos** do not affect the **Photos** and **Music**, and in turn are not affected by option values changed in **Photos** or **Music**.
- Option values changed in **Photos** and **Music** do affect each other.
- When restarting a video file after stopping it, you can play from the point at which it was stopped.
- Only 10,000 sync blocks can be supported within the subtitle file.
- When playing a video, you can adjust the picture size by pressing the **ARC** button.
- Korean subtitle is supported only when the OSD menu is in Korean.
- The code page options may be disabled depending on the language of the subtitle files.
- Select the appropriate code page for the subtitle files.

Viewing Photos

The displays on the screen may differ from the model.

Viewing image files









HOME →  → Photos

Listening to Music

Viewing music files

HOME →  → Music

NOTE

- Files with unsupported extensions are not displayed.
- If a file is invalid, a broken image and the message "unrecognizable file" are displayed.
- Damaged music files are displayed as 00:00 and will not be played.
- A music file downloaded from a paid service with copyright protection will not play, and incorrect information may be displayed during playback.
- You can use , , , ,  buttons on the remote control also in this mode.
- You can use the  button to select the next track and the  button to select the previous track.
- If you press the  button within 5 seconds after playing the song, you will return to the previous song; if you press the same button after 5 seconds, you will return to the start of the song.

Settings

You must register your product to play a DRM-protected DivX video.

In order to register/deregister purchased or rented DivX® VOD contents

HOME →  → Settings → DivX® VOD

In order to play purchased or rented DivX® VOD contents, you should register your device with 10 digit DivX registration code from your device at www.divx.com/vod.

- **Registration:** view the registration code of your display.
- **Deregistration:** cancel the registration.

NOTE

- While you are checking the registration code, some buttons may not work.
- If you use the DivX registration code of another device, you cannot play rented or purchased DivX files. Use only the DivX registration code assigned to your product.
- Video or audio files that are not converted using the standard DivX codec may be corrupted or not play.
- The DivX® VOD code allows you to activate up to 6 devices under one account.
- After deregistration, you must register your device again to see DivX® VOD contents.

SuperSign Contents

Plays stored files using the Export option in SuperSign Editor.

To play back the stored files using the Export option

HOME → 

Only contents distributed by SuperSign Manager are displayed and selectable.

! NOTE

- If there is an AutoPlay folder in the USB storage device and its files are in supported formats, they will be played back automatically when the USB storage device is connected to the monitor.

Information

To check the basic information of Signage Monitor

HOME → 

You can see the basic information on Signage Monitor.

File Manager

You can move, copy, or delete files.

To move, copy, or delete files

HOME → 

- You can move or copy files or folders from internal to external memory.
- You can move or copy files or folders from external to internal memory.
- You can delete files or folders from internal or external memory.

! NOTE

- This app is for managing files and therefore cannot play media files. To play media files, launch **My Media**.
- Those files bigger than internal remaining memory aren't allowed to be copied or moved to the internal memory.

PICTURE ID Settings

PICTURE ID is used to change the settings of a specific set (display) using a single IR receiver for multi-vision. Communication is possible between a monitor with an IR receiver and other monitors using RS-232C cables. Each monitor is identified by a **Set ID**. If you assign the **PICTURE ID** using the remote control, only displays with matching **PICTURE ID** and **Set ID** can be controlled remotely.

- 1 Assign the **Set ID** to the installed monitors as shown below.

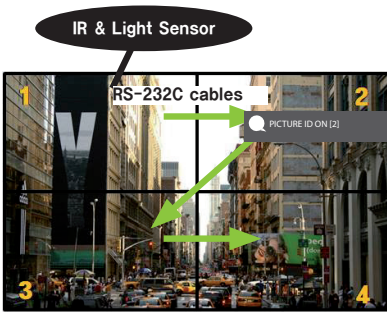

- 2 Press the red **ON** button on the remote control to assign the **PICTURE ID**.
- 3 Assign the **Set ID** to the selection of your choice.
 - A set with a different **Set ID** from the **PICTURE ID** cannot be controlled by IR signals.

! NOTE

- If **PICTURE ID** is set to 2, only the upper right monitor, which has a **Set ID** of 2, can be controlled by IR signals.
- If you press the green **OFF** button for **PICTURE ID**, the **PICTURE IDs** for all monitors are turned off. If you then press any button on the remote control, all monitors can be controlled by IR signals regardless of **Set ID**.
- With **PICTURE ID ON**, you can only increase the **PICTURE ID** by 1. You cannot decrease it.

User Settings

Main Menu Settings

Quick Settings

Configures frequently used settings menus.

To turn your monitor on or off automatically

SETTINGS → **Quick** → **On Timer/Off Timer**

You can set the On/Off Timer for your monitor. If you do not want to set the On/Off Timer, select **Off** in Repeat.

To set the backlight and contrast automatically

SETTINGS → **Quick** → **Smart Energy Saving**

According to picture brightness, the brightness of the monitor will be adjusted automatically to save energy.

- **Off**: disables the Smart Energy Saving function.
- **On**: enables the Smart Energy Saving function.

Picture Settings

To Select Picture Mode

SETTINGS → Picture → Picture Mode

Select the picture mode that is best suited to the video type.

- **Vivid:** adjusts the video image for a retail environment by enhancing the **contrast, brightness, and sharpness.**
- **Standard:** adjusts the video image for a normal environment.
- **APS:** APS (Auto power saving) mode reduces power consumption by dimming control.
- **Cinema:** optimizes the video image for watching movies.
- **Sports:** optimizes the video image for watching sports. Even fast actions such as kicking or throwing a ball are rendered clearly on the screen.
- **Game:** optimizes the video image for playing videogames.
- **Expert 1/Expert 2:** allows an expert, or anyone interested in high quality pictures, to manually tune the picture for the best picture quality.

NOTE

- Depending on the input signal, the available **picture modes** may differ.
- **Expert** is an option that allows a picture quality expert to fine-tune the picture quality using a specific image. Thus, it may not be effective for a normal picture.

To fine-tune the picture mode

SETTINGS → Picture → Picture Adjust

- **Backlight:** adjusts the brightness of the screen by controlling the LCD backlight. The closer the value is to 100, the brighter the screen is.
- **Contrast:** adjusts the difference between the light and dark areas of the picture. The closer the value is to 100, the greater the difference is.
- **Brightness:** adjusts the overall brightness of the screen. The closer the value is to 100, the brighter the screen is.
- **Sharpness:** adjusts the sharpness of the edges of objects. The closer the value is 50, the clearer and the sharper the edge becomes.
- **H Sharpness:** adjusts the sharpness of the contrast edges on the screen from a horizontal point of view.
- **V Sharpness:** adjusts the sharpness of the contrast edges on the screen from a vertical point of view.
- **Color:** softens or deepens the tints on the screen. The closer the value is 100, the deeper the colors become.
- **Tint:** adjusts the balance between red and green levels displayed on the screen. The closer the value is to Red 50, the deeper the color red becomes, and the closer the value is to Green 50, the deeper the color green becomes.
- **Color Temperature:** adjusts the tints of the screen to evoke feelings of warmth or coolness.
- **Advanced Control/Expert Control:** customizes the advanced options.
 - **Dynamic Contrast:** Optimizes the difference between the light and dark parts of the screen according to the brightness of the image.
 - **Super Resolution:** Sharpens the blurry or indistinguishable parts of the picture.
 - **Color Gamut:** Selects the range of colors to display.
 - **Dynamic Color:** Adjusts the tint and saturation of the image for a more vivid and lively display.
 - **Edge Enhancer:** Provides much sharper and clearer edges to the picture.
 - **Color Filter:** Accurately adjusts color and tint by filtering a specific color area of RGB space.
 - **Preferred Color:** Adjusts the skin tint, grass tint, and sky tint to your preference.
 - **Gamma:** Adjusts the medium brightness of the image.
 - **White Balance:** Adjusts the overall tint of the picture to your preference. In Expert mode, you can fine-tune the picture using the Method/Pattern options.
 - **Color Management System:** Experts use the color management system when they adjust the colors by using the test pattern. The color management system allows you to make an adjustment by selecting from among 6 different color spaces (Red/Yellow/Blue/Cyan/Magenta/Green) without affecting other colors. You may not see tints change in a normal picture even after adjustment.

- **Picture Options:** customizes the picture options.
 - **Noise Reduction:** Removes irregularly generated tiny dots for a clear picture.
 - **MPEG Noise Reduction:** Reduces the noise produced while creating digital video signals.
 - **Black Level:** Adjusts the black level of the picture to correct the brightness and contrast of the picture.
 - **Real Cinema:** Optimizes the video image for a cinematic look.
 - **LED Local Dimming:** Makes the light areas of the screen lighter and the dark areas darker for maximum contrast.
 - **Off:** Disables the LED Local Dimming feature.
 - **Low/Medium/High:** Adjusts the contrast of the screen.
 - **TruMotion:** Optimizes the video image for a cinematic look.
 - **Off:** Turns off the TruMotion.
 - **Smooth:** displays fast-moving pictures smoothly.
 - **Clear:** displays fast-moving pictures clearly.
 - **User:** set de-judder manually.
 - ***De-judder:** adjusts judder on the screen.
- **Reset:** resets the picture settings.

NOTE

- You can adjust advanced settings only in the **User** mode.
- Depending upon the input signal or the selected picture mode, the available options may differ.

To set the aspect ratio,

SETTINGS → Picture → Aspect Ratio

Changes the aspect ratio to view the image in its optimal size.

- **16:9:** displays the image with a 16:9 aspect ratio.
- **Just Scan:** displays the image in the original size without cutting off the edges.
Original is available in HDMI (720p or higher) mode.
- **Set By Program:** automatically changes the aspect ratio to 4:3 or 16:9 depending on the input video signal.
- **4:3:** displays the image with a 4:3 aspect ratio.
- **Zoom:** expands the image to fit to the width of the screen. The top and bottom of the image may be cropped.
- **Cinema Zoom:** enlarges the image to have a cinemascope ratio of 2.35:1 without distortion.

CAUTION

- If a fixed image is displayed on the screen for a long period of time, it will be imprinted and become a permanent disfigurement on the screen. This image burn or burn-in is not covered by the warranty.
- If the aspect ratio is set to **4:3** for a long period of time, image burn may occur on the letterboxed area of the screen.
- The options may differ depending on the model.
- Depending on the input signal, the available aspect ratio may differ.
- You can select only **4:3** and **16:9** aspect ratios in HDMI1-PC/ HDMI2-PC/ DISPLAYPORT-PC/ DVI-D(PC) input mode.

To use the Energy Saving function

SETTINGS → Picture → Energy Saving

Reduces power consumption by adjusting peak screen brightness.

- **Auto:** adjusts the brightness of the monitor according to ambient light. (This feature is available only with certain models.)
- **Off:** disables the Energy Saving mode.
- **Minimum/Medium/Maximum:** uses the Energy Saving according to the Energy Saving level specified for your monitor.
- **Screen Off:** turns off the screen. You will only hear audio. You can turn on the screen again by pressing any button on the remote control except the power button.

To use the Smart Energy Saving function

SETTINGS → Picture → Smart Energy Saving

According to picture brightness, the brightness of the monitor will be adjusted automatically to save energy.

- **Off:** disables the Smart Energy Saving function.
- **On:** enables the Smart Energy Saving function.

To use The Easy Brightness Control

SETTINGS → Picture → Easy Brightness Control

The backlight is adjusted according to your schedule.

- **Off:** disables the Easy Brightness Control function.
- **On:** enables the Easy Brightness Control function.

! NOTE

- When Easy Brightness Control is **On**, the **backlight** feature in **Picture Adjust** is disabled.
- When **Energy Saving** is set to **Maximum** or **Auto**, Easy Brightness Control is disabled.
- You can add up to six schedules, and they are sorted by time in ascending order.
- You can delete added items individually.
- Duplicate schedules are not added. However, the backlight value is updated.
- This feature may not be supported in certain models.

To run a Picture Test

SETTINGS → Picture → Picture Test

Run a Picture Test to check that picture signals are outputted normally, then solve any problems by selecting the relevant option on the screen. If there are no problems with the Test Picture, check connected external devices.

Sound Settings

To select a Sound Mode

SETTINGS → Sound → Sound Mode

The best sound quality will be selected automatically depending on the video type currently being watched.

- **Standard:** this sound mode works well for content of all types.
- **News:** optimizes sound for watching news.
- **Music:** optimizes sound for listening to music.
- **Cinema:** optimizes sound for watching movies.
- **Sports:** optimizes sound for watching sports.
- **Game:** optimizes sound for playing videogames.

To use the Sound Effects function

SETTINGS → Sound → Sound Effects

- **Clear Voice II:** enjoy clearer sound with the three-level adjustment.
- **Equalizer:** manually adjust sound by using the equalizer. .
- **Balance:** adjust the output volume for the left speaker and the right speaker.
- **Reset:** reset the sound settings.

To select a Volume Increase Rate,

SETTINGS → Sound → Volume Increase Rate

You can set the volume range by selecting any of **Low/ Medium/ High**.

To sync audio with video

SETTINGS → Sound → AV Sync. Adjust

- **Speaker:** adjusts the sync between video and audio coming from external speakers, such as those connected to the digital audio output port, LG audio equipment, or headphones. From the default value, the closer the value is to -, the faster the sound output becomes, and the closer the value is to +, the slower the sound output becomes.
- **Bypass:** audio coming from external devices without delay. Audio may be outputted earlier than video due to the processing time for video that is inputted into the monitor.

To Run a sound test

SETTINGS → Sound → Sound Test

Run a sound test to check that sound signals are outputted normally, then solve any problems by selecting the relevant option on the screen. If there are no problems with the Sound Test, check connected external devices.

Network Settings

To Set a Signage Monitor Name

SETTINGS → Network → Signage Name

You can set a name for Signage Monitor that will be used on the network by using the on-screen keyboard.

To Set Your Network

SETTINGS → Network → Wired Connection (Ethernet)

- **Connecting to a wired network:** Connect your monitor to a local area network (LAN) via the LAN port, and configure the network settings. Only wired network connections are supported. After making a physical connection, a small number of networks may require the display network settings to be adjusted. For most networks, the display will automatically make a connection without any adjustments. For detailed information, contact your Internet provider or consult your router manual.

Setting a Wireless Network (Only for **XS2B model)

SETTINGS → Network → Wi-Fi Connection

If you have set the monitor up for a wireless network, you can check and connect to the available wireless Internet networks.

- **Add a Hidden Wireless Network:** If you input the name of network directly, you can add a wireless network.
- **Connect via WPS PBC:** Connects easily when the button of a wireless AP supporting PBC is pressed.
- **Connect via WPS PIN:** Connects easily when the PIN of the wireless AP that you wish to connect to is entered in to the AP configuration webpage.
- **Advanced Settings:** If you input the information of network directly, you can enter a wireless network. If there is no wireless network available, click **Advanced Settings**. You can add a network.

Tips for Network Setting (Only for **XS2B model)

- Use a standard LAN cable (Cat5 or higher with a RJ45 connector) with this display.
- Many network connection problems during set-up can often be fixed by re-setting the router or modem. After connecting the display to the home network, quickly power off and/or disconnect the power cable of the home network router or cable modem, then power on and/or connect the power cable again.
- Depending on the Internet Service Provider (ISP), the number of devices that can receive Internet service may be limited by the applicable terms of service. For details, contact your ISP.
- LG is not responsible for any malfunction of the display and/or the Internet connection feature due to communication errors/malfunctions associated with your Internet connection, or other connected equipment.
- LG is not responsible for problems with your Internet connection.
- You may experience undesired results if the network connection speed does not meet the requirements of the content being accessed.
- Some Internet connection operations may not be possible due to certain restrictions set by the Internet Service Provider (ISP) supplying your Internet connection.
- Any fees charged by an ISP including, without limitation, connection charges are your responsibility.

NOTE

- If you want to access the Internet directly on your display, the Internet connection should always be on.
- If you cannot access the Internet, check the network conditions from a PC on your network.
- When you use Network Setting, check the LAN cable or check if DHCP in the router is turned on.
- If you do not complete the network settings, the network may not function correctly.

CAUTION

- Do not connect a modular telephone cable to the LAN port.
- Since there are various connection methods, please follow the specifications of your telecommunication carrier or Internet Service Provider.
- Network Setting menu will not be available until the display is connected to a physical network.

Tips for Wireless Network Setting (Only for **XS2B model)

- Wireless networks can be subject to interference from other devices operating at a frequency of 2.4 GHz (wireless phones, Bluetooth devices or microwave ovens). There may also be interference from devices with a frequency of 5 GHz, same as other Wi-Fi devices.
- The surrounding wireless environment can cause the wireless network service to run slowly.
- If you do not turn off the entire local home network, network traffic may occur on some devices.
- For an AP connection, an access point device that supports wireless connection is required and the wireless connection feature must be enabled on the device. Contact your service provider regarding availability of wireless connection on your access point.
- Check the SSID and security settings of the AP for AP connection. Refer to the appropriate documentation for SSID and security settings of the AP.
- Invalid settings on network devices (wired/wireless line sharer, hub) can cause the monitor to run slowly or not operate properly. Install the devices correctly according to the appropriate manual and set the network.
- Connection method may differ according to the AP manufacturer.

General Settings

To configure the language

SETTINGS → General → Menu Language

Select one of the languages on the menu displayed on the screen.

- **Menu Language:** sets a language for Signage.

To set the time/date

SETTINGS → General → Time & Date

You can check or change the time.

- **Time:** you can set the time manually.
- **Date:** you can set the date manually.

To apply Daylight Saving Time

SETTINGS → General → Daylight Saving Time

You can set the application period for Daylight Saving Time and enable or disable the function by selecting On/Off.

- **Start Time / End Time:** You can set the time by configuring month/Week/day/time settings.

NOTE

- When setting the Daylight Saving Time, configure the number of week and day of the week settings.
- For example, if the Daylight Saving Time starts on July 7th, 2014, Monday, set the time as July/ 1st/ Mon/ 00:00 since it is the first Monday of July, 2014.
- Depending on the month, either the fourth or fifth week can be Last.

To turn your monitor on or off automatically**SETTINGS → General → Timers**

You can set the On/Off Timer for your monitor.

- **On Timer:** you can set the time when your monitor turns on.
- **Off Timer:** you can set the time when your monitor turns off.
- **No Signal Power Off (15 minutes):** When there is no input source, the monitor will automatically turn off after 15 minutes. If you don't want it to turn off automatically, set No Signal Power Off to Off.
- **Auto Power Off :** When there is no key input, the monitor will automatically turn off.

**NOTE**

- On Time/Off Time can be saved for up to seven schedules; the monitor is turned on or off at the preset time in the schedule list. If multiple preset times are stored in the schedule list, this function works at the nearest time from the current time.
- Once the on or off time is set, these functions operate daily at the preset time.
- The scheduled power-off function works properly only when the device time is set correctly.
- When the scheduled power-on and power-off times are the same, the power-off time has priority over the power-on time if the set is turned on, and vice versa if the set is turned off.

To reset your monitor settings**SETTINGS → General → Reset to Initial Settings**

Resets all monitor settings.

TROUBLESHOOTING

No image is displayed

Problem	Action
Is the product power cord connected?	<ul style="list-style-type: none"> Check if the power cord is correctly plugged into the power outlet.
Does the "Invalid Format" message appear?	<ul style="list-style-type: none"> The signal from the PC (video card) is out of the vertical or horizontal frequency range of the product. Adjust the frequency range by referring to the Specifications in this manual. * Maximum resolution: 1920 x 1080 (60Hz)
Does the "No Signal" message appear?	<ul style="list-style-type: none"> The signal cable between PC and product is not connected. Check the signal cable. Press the INPUT menu in the remote Control to check the input signal.

The Unknown Product message appears when the product is connected.

Problem	Action
Did you install the driver?	<ul style="list-style-type: none"> Check if the Plug & Play function is supported by referring to the video card user manual.

The screen image looks abnormal.

Problem	Action
Is the screen position wrong?	<ul style="list-style-type: none"> Check if the video card resolution and frequency are supported by the product. If the frequency is out of range, set to the recommended resolution in the Control Panel Display Setting menu.
The screen is displayed abnormally.	<ul style="list-style-type: none"> The proper input signal is not connected to the signal port. Connect the signal cable that matches with the source input signal.

After-image appears on the product.

Problem	Action
After-image appears when the product is turned off.	<ul style="list-style-type: none"> If you use a fixed image for a long time, the pixels may be damaged. Use the screen-saver function. When a dark image is displayed on the screen after an image with high contrast (black and white or gray), this may cause image sticking. This is normal for LCD screen products.

The audio function does not work.

Problem	Action
No sound?	<ul style="list-style-type: none"> • See if the audio cable is connected properly. • Adjust the volume. • See if the sound is set properly.
Sound is too dull.	<ul style="list-style-type: none"> • Select the appropriate equalizer sound.
Sound is too low.	<ul style="list-style-type: none"> • Adjust the volume.

Screen color is abnormal.

Problem	Action
Screen has poor color resolution (16 colors).	<ul style="list-style-type: none"> • Set the number of colors to more than 24 bits (true color). Select Control Panel - Display - Settings - Color Table menu in Windows.
Screen color is unstable or mono-colored.	<ul style="list-style-type: none"> • Check the connection status of the signal cable. Or, re-insert the PC video card.
Do black spots appear on the screen?	<ul style="list-style-type: none"> • Several pixels (red, green, white, or black color) may appear on the screen, which can be attributable to the unique characteristics of the LCD panel. This is not a malfunction of the LCD.

The operation does not work normally.

Problem	Action
The power suddenly turned off.	<ul style="list-style-type: none"> • Is the Timer set? • Check the power control settings. Power interrupted.

 **NOTE**

- The software-related contents may be changed without prior notice due to upgrade of the product functions.



CAUTION

- Image sticking does not occur when using constantly changing images but may occur when using a fixed image for an extended period of time. Therefore, it is recommended that you use the instructions below to decrease the likelihood of image sticking occurring when using a fixed image. It is recommended that you change the screen at least once every **12 hours** at the very minimum; if done more frequently, the prevention of image sticking is more effective.

Recommended operating conditions

- 1 Change the background and the character colors using the same time interval.



When changing colors, using complementary colors helps to prevent image sticking.

- 2 Change the image using the same time interval.



Make sure that the characters or images before changing the image remain in the same location after changing the image.

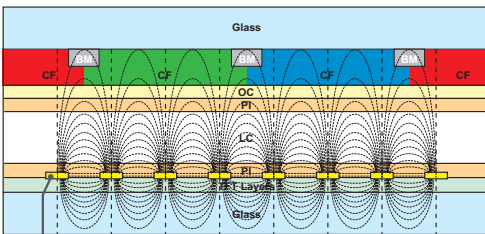

ITO or MoTi Pixel Layer

What is image sticking?

When the LCD panel displays a static image for an extended period of time, it can cause a voltage difference between the electrodes that operate the liquid crystals. When the voltage difference between the electrodes builds up over time, liquid crystals have a tendency to remain aligned in one direction. During this process, a previously displayed image remains visible. This phenomenon is referred to as image sticking.

PRODUCT SPECIFICATIONS

The product specifications below may be changed without prior notice due to upgrade of product functions.

~ refers to alternating current (AC), and = refers to direct current (DC).

LCD screen	Screen type	Thin Film Transistor (TFT) Liquid Crystal Display (LCD) Screen
	Pixel pitch	0.210 mm (H) x 0.630 mm (V)
Video signal	Maximum resolution	1920 x 1080 @ 60 Hz - This may not be supported on some OS or graphic card types.
	Recommended resolution	1920 x 1080 @ 60 Hz - This may not be supported on some OS or graphic card types.
	Horizontal frequency	HDMI / DVI-D / DISPLAYPORT: 30 kHz to 83 kHz
	Vertical frequency	HDMI / DVI-D / DISPLAYPORT: 56 Hz to 60 Hz
	Synchronization	Digital
Input ports	USB IN, DP IN, HDMI IN 1, HDMI IN 2, DVI-D IN, AUDIO IN, LAN, PIXEL SENSOR, RS-232C IN, EXT IR IN	
Output ports	DP OUT, SPEAKER OUT, RS-232C OUT	
Embedded battery	Applied	

55XF2B

Power	Rated power	AC 100-240 V~ 50/60 Hz 2.9 A
	Power consumption	On Mode 230 W (Typ.) Sleep Mode (DVI-D , HDMI) ≤ 1.0 W Sleep Mode(DISPLAYPORT) ≤ 0.7 W Off Mode ≤ 0.5 W
Environmental Conditions	Operating Temperature	0 °C to 50 °C
	Operating Humidity	10 % to 80 %
	Storage Temperature	-20 °C to 60 °C
	Storage Humidity	5 % to 95 %
Dimensions (Width x Height x Depth) / Weight		1235.4 mm x 709.4 mm x 106 mm / 27 kg

55XS2B

Power	Rated power	AC 100-240 V~ 50/60 Hz 2.7 A
	Power consumption	On Mode 220 W (Typ.) Sleep Mode (DVI-D , HDMI) ≤ 1.0 W Sleep Mode(DISPLAYPORT) ≤ 0.7 W Off Mode ≤ 0.5 W
Environmental Conditions	Operating Temperature	0 °C to 45 °C (without Direct Sunlight) 0 °C to 35 °C (Direct Sunlight)
	Operating Humidity	10 % to 80 %
	Storage Temperature	-20 °C to 60 °C
	Storage Humidity	5 % to 95 %
	Installation site	Indoor
Dimensions (Width x Height x Depth) / Weight		1238.4 mm x 712.4 mm x 89 mm / 25.6 kg

HDMI / DVI-D / DISPLAYPORT (PC) Support Mode

Resolution	Horizontal frequency (kHz)	Vertical frequency (Hz)
640 x 480	31.469	59.94
800 x 600	37.879	60.317
1024 x 768	48.363	60
1280 x 720	44.772	59.855
1366 x 768	47.7	60
1280 x 1024	63.981	60.02
1680 x 1050	65.290	59.954
1920 x 1080	67.5	60

! NOTE

- PC resolutions available for the Input Label option in HDMI / DVI-D / DISPLAYPORT input modes: 640 x 480/60 Hz, 1280 x 720/60 Hz, 1920 x 1080/60 Hz; 480p, 720p, and 1080p DTV resolutions.
- Vertical frequency: The product display functions by the screen image changing dozens of times every second like a fluorescent lamp. The vertical frequency or refresh rate is the number of image displays per second. The unit is Hz.
- Horizontal frequency: The horizontal interval is the time taken to display one horizontal line. When 1 is divided by the horizontal interval, the number of horizontal lines displayed every second can be tabulated as the horizontal frequency. The unit is kHz.











DTV mode

Resolution	HDMI / DISPLAYPORT (DTV)
480i	x
576i	x
480p	o
576p	o
720p (50 / 60 Hz)	o
1080i (50 / 60 Hz)	o
1080p (50 / 60 Hz)	o

IR CODES

All models do not support the HDMI/USB function.

Some key codes may not be supported depending on the model.

Code (Hex)	Function	Remarks
08	 POWER	Remote control button
C4	MONITOR ON	Remote control button
C5	MONITOR OFF	Remote control button
95	Energy Saving	Remote control button
0B	INPUT	Remote control button
10	Number Key 0	Remote control button
11	Number Key 1	Remote control button
12	Number Key 2	Remote control button
13	Number Key 3	Remote control button
14	Number Key 4	Remote control button
15	Number Key 5	Remote control button
16	Number Key 6	Remote control button
17	Number Key 7	Remote control button
18	Number Key 8	Remote control button
19	Number Key 9	Remote control button
02	Volume  (+)	Remote control button
03	Volume  (-)	Remote control button
E0	BRIGHTNESS  (Page Up)	Remote control button
E1	BRIGHTNESS  (Page Down)	Remote control button
DC	3D	Remote control button
32	1/a/A	Remote control button
2F	CLEAR	Remote control button
7E	 SIMPLINK	Remote control button
79	ARC(MARK) (Aspect Ratio)	Remote control button
4D	PSM (Picture Mode)	Remote control button
09	MUTE	Remote control button
43	SETTINGS (Menu)	Remote control button
99	Auto Config.	Remote control button
40	Up 	Remote control button
41	Down 	Remote control button
06	Right 	Remote control button
07	Left 	Remote control button
44	OK	Remote control button
28	BACK	Remote control button

Code (Hex)	Function	Remarks
7B	TILE	Remote control button
5B	EXIT	Remote control button
72	ID ON (RED)	Remote control button
71	ID OFF (GREEN)	Remote control button
63	YELLOW	Remote control Button
61	BLUE	Remote control button
B1	■	Remote control button
B0	▶	Remote control button
BA		Remote control button
8F	◀◀	Remote control button
8E	▶▶	Remote control button
5F	W.BAL	Remote control button
3F	S.MENU	Remote control button
7C	HOME	Remote control button

* Some key codes are not supported depending upon the model.

TO CONTROL MULTIPLE PRODUCTS

Use this method to connect several products to a single PC. You can control several products at a time by connecting them to a single PC.

In the Option menu, the Set ID must be between 1 and 1000 without being duplicated.

Connecting the Cable

Connect the RS-232C cable as shown in the picture.

The RS-232C protocol is used for communication between the PC and product. You can turn the product on or off, select an input source, or adjust the OSD menu from your PC.

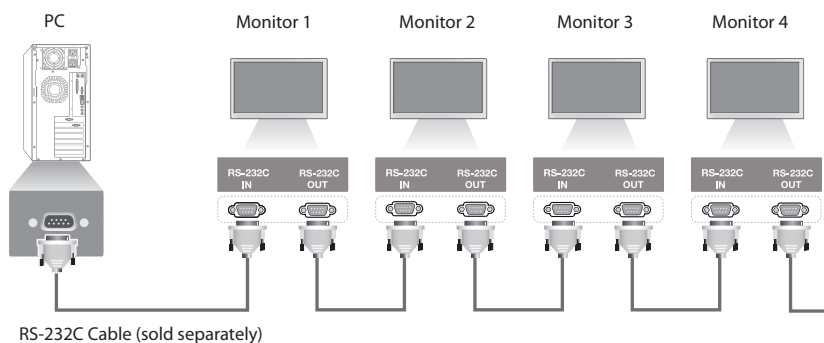

RS-232C Configurations

8-Wire Configurations (Standard RS-232C cable)

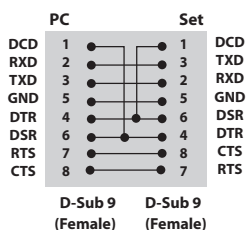

NOTE

- When using three-wire connections (non-standard), an IR daisy chain cannot be used.
- When monitors connected via Daisy Chain (that controls multiple monitors) are turned off and on successively, some monitors may not turn on. In this case, you can turn those monitors on by pressing the **MONITOR ON** button, not the **POWER** button.

Communication Parameter

Baud Rate: 9600 BPS

Data Length: 8 bit

Parity Bit: None

Stop Bit: 1 bit

Flow Control: None

Communication Code: ASCII code

Use a crossed (reverse) cable

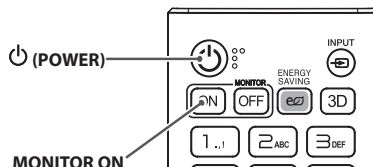

Command Reference List

		COMMAND		DATA (Hexadecimal)
		1	2	
01	Power	k	a	00 to 01
02	Select input	x	b	See Select Input
03	Aspect Ratio	k	c	See Aspect Ratio
04	Energy Saving	j	q	See Energy Saving
05	Picture Mode	d	x	See Picture Mode
06	Contrast	k	g	00 to 64
07	Brightness	k	h	00 to 64
08	Sharpness	k	k	00 to 32
09	Color	k	i	00 to 64
10	Tint	k	j	00 to 64
11	Color temperature	x	u	00 to 64
12	Balance	k	t	00 to 64
13	Sound Mode	d	y	See Sound Mode
14	Mute	k	e	00 to 01
15	Volume Control	k	f	00 to 64
16	Time 1 (year/month/day)	f	a	See Time 1
17	Time 2 (hour/minute/second)	f	x	See Time 2
18	Off time schedule	f	c	00 to 01
19	On Time Schedule	f	b	00 to 01
20	Off Timer (Repeat/Time)	f	e	See Off Timer
21	On Timer (Repeat/Time)	f	d	See On Timer
22	On Timer Input	f	u	Refer to On Timer Input.
23	No Signal Power Off (15 Min)	f	g	00 to 01
24	Auto Power Off (4 Hours)	m	n	00 to 01
25	Language	f	i	See Language
26	Reset	f	k	00, 02
27	Current Temperature	d	n	FF
28	Key	m	c	See Key
29	Time Elapsed	d	l	FF
30	Product Serial Number	f	y	FF
31	Software Version	f	z	FF
32	White Balance Red Gain	j	m	00 to FE
33	White Balance Green Gain	j	n	00 to FE
34	White Balance Blue Gain	j	o	00 to FE

		COMMAND		DATA (Hexadecimal)
		1	2	
35	White Balance Red Offset	s	x	00 to 7F
36	White Balance Green Offset	s	y	00 to 7F
37	White Balance Blue Offset	s	z	00 to 7F
38	Backlight	m	g	00 to 64
39	Screen off	k	d	00 to 01
40	Tile Mode	d	d	00 to FF
41	Check Tile Mode	d	z	FF
42	Tile ID	d	i	See Tile ID
43	Natural Mode	d	j	00 to 01
44	DPM Select	f	j	00 to 07
45	Power On Delay	f	h	00 to FA
46	Fail Over Select	m	i	00 to 02
47	Fail Over Input Select	m	j	See Auto Switch Input Select
48	Remote Controller Lock	t	p	00 to 02
49	Status Check	s	v	See 'Status Check'
50	Speakers	d	v	00 to 01
51	Daylight Saving Time	s	d	See Daylight Saving Time
52	Wake On Lan	f	w	00 to 01
53	Power Indicator	f	o	00 to 01
54	Fan Control	d	o	00 to 02
55	Fan Failure Check	d	w	FF
56	Luminance Value Read	m	u	00 to 01
57	BLU Maintenance	m	t	00 to 01
58	Easy Brightness Control Mode	s	m	00 to 01
59	Easy Brightness Control Schedule	s	s	See Easy Brightness Control Schedule'

* Note: Only the power and key commands can be used while media files are playing from a USB device or internal/external memory. The commands other than the power and key commands will be treated as NG. Some commands may not be supported depending on the model.

Transmission/Reception Protocol

Transmission

[Command1][Command2][][Set ID][][Data][Cr]

- * [Command1]: identifies between the factory setting and the user setting modes.
- * [Command2]: controls monitor sets.
- * [Set ID]: Used for selecting a set you want to control. A unique Set ID can be assigned to each set ranging from 1 to 1000(01H~3E8H) under Settings in the OSD menu.
Selecting '00H' for Set ID allows the simultaneous control of all connected monitors.
- * [Data]: Transmits command data.
Data count may increase depending on the command.
- * [Cr]: Carriage Return. Corresponds to '0x0D' in ASCII code.
- * []: White Space. Corresponds to '0x20' in ASCII code.

Acknowledgement

[Command2][][Set ID][][OK/NG][Data][x]

- * The Product transmits ACK (acknowledgement) based on this format when receiving normal data. At this time, if the data is FF, it indicates the present status data. If the data is in data write mode, it returns the data of the PC computer.
- * If a command is sent with Set ID '00' (=0x00), the data is reflected to all monitor sets and each monitor set does not send an acknowledgement (ACK).
- * If the data value 'FF' is sent in control mode via RS-232C, the current setting value of a function can be checked (only for some functions).
- * Some commands are not supported depending on the model.

01. Power (Command: k a)

Controls the power on/off of the set.

Transmission

[k][a][][Set ID][][Data][Cr]

Data 00: Off
01: On

Acknowledgement

[a][][Set ID][][OK/NG][Data][x]

*The acknowledgement signal is returned properly only when the monitor is fully powered on.

* There may be a delay between the transmission and acknowledgement signals.

02. Select Input (Command: x b)

Selects an input signal.

Transmission

[x][b][][Set ID][][Data][Cr]

Data 70: DVI-D (PC)
80: DVI-D (DTV)
90: HDMI1 (DTV)
A0: HDMI1 (PC)
91: HDMI2 (DTV)
A1: HDMI2 (PC)
C0: DISPLAYPORT (DTV)
D0: DISPLAYPORT (PC)

Acknowledgement

[b][][Set ID][][OK/NG][Data][x]

* Some input signals may not be supported depending upon the model.

03. Aspect Ratio (Command: k c)

Adjusts the aspect ratio.

Transmission

[k][c][][Set ID][][Data][Cr]

Data 01: 4:3
02: 16:9
04: Zoom
06: Set by Program
09: Just Scan (720p or higher)
10 to 1F: Cinema Zoom 1 to 16

* Available data types differ depending on the input signal. For more information, see the aspect ratio section of the owner's manual.

* The aspect ratio may differ depending upon the model's input configuration.

Acknowledgement

[c][][Set ID][][OK/NG][Data][x]

04. Energy Saving (Command: j q)

Sets the Energy Saving.

Transmission

[j][q][][Set ID][][Data][Cr]

Data 00: Off
01: Minimum
02: Medium
03: Maximum
04: Automatic
05: Screen off

Acknowledgement

[q][][Set ID][][OK/NG][Data][x]

** This may not be supported depending upon the model.

05. Picture Mode (Command: d x)

Selects a picture mode.

Transmission

[d][x][][Set ID][][Data][Cr]

Data 00: Vivid
01: Standard
02: Cinema
03: Sports
04: Game
05: Expert 1
06: Expert 2
08: APS

Acknowledgement

[x][][Set ID][][OK/NG][Data][x]

06. Contrast (Command: k g)

Adjusts the screen contrast.

Transmission

[k][g][][Set ID][][Data][Cr]

Data 00 to 64: Contrast 0 to 100

Acknowledgement

[g][][Set ID][][OK/NG][Data][x]

07. Brightness (Command: k h)

Adjusts the screen brightness.

Transmission

[k][h][][Set ID][][Data][Cr]

Data 00 to 64: Brightness 0 to 100

Acknowledgement

[h][][Set ID][][OK/NG][Data][x]

08. Sharpness (Command: k k)

Adjusts the screen sharpness.

Transmission

[k][k][][Set ID][][Data][Cr]

Data 00 to 32: Sharpness 0 to 50

Acknowledgement

[k][][Set ID][][OK/NG][Data][x]

09. Color (Command: k i)

Adjusts the screen color.

Transmission

[k][i][][Set ID][][Data][Cr]

Data 00 to 64: Color 0 to 100

Acknowledgement

[i][][Set ID][][OK/NG][Data][x]

10. Tint (Command: k j)

Adjusts the screen tint.

Transmission

[k][j][][Set ID][][Data][Cr]

Data 00 to 64: Tint red 50 to green 50

Acknowledgement

[j][][Set ID][][OK/NG][Data][x]

11. Color Temperature (Command: x u)

Adjusts the screen color temperature.

Transmission

[x][u][][Set ID][][Data][Cr]

Data 00 to 64: warm 50 to cool 50

Acknowledgement

[u][][Set ID][][OK/NG][Data][x]

12. Balance (Command: k t)

Adjusts the sound balance.

Transmission

[k][t][][Set ID][][Data][Cr]

Data 00 to 64: left 50 to right 50

Acknowledgement

[t][][Set ID][][OK/NG][Data][x]

13. Sound mode (Command: d y)

Selects a sound mode.

Transmission

`[d][y][][Set ID][][Data][Cr]`

Data 01: Standard
 02: Music
 03: Cinema
 04: Sports
 05: Game
 07: News

Acknowledgement

`[y][][Set ID][][OK/NG][Data][x]`**14. Mute (Command: k e)**

Mutes/unmutes the sound.

Transmission

`[k][e][][Set ID][][Data][Cr]`

Data 00: Mute
 01: Unmute

Acknowledgement

`[e][][Set ID][][OK/NG][Data][x]`**15. Volume Control (Command: k f)**

Adjusts the playback volume.

Transmission

`[k][f][][Set ID][][Data][Cr]`

Data 00 to 64: Volume 0 to 100

Acknowledgement

`[f][][Set ID][][OK/NG][Data][x]`**16. Time 1 (year/month/day) (Command: f a)**

Adjusts the Time 1 (year/month/day) value.

Transmission

`[f][a][][Set ID][][Data1][][Data2][][Data3][Cr]`

Data1 04~1B: year 2014 to 2037
 Data2 01 to 0C: January to December
 Data3 01 to 1F: 1st to 31st

* Enter "fa [Set ID] ff" to view the Time 1 (year/month/day) settings.

Acknowledgement

`[a][][Set ID][][OK/NG][Data1][Data2][Data3][x]`**17. Time 2 (hour/minute/second) (Command: f x)**

Adjusts the Time 2 (hour/minute/second) value.

Transmission

`[f][x][][Set ID][][Data1][][Data2][][Data3][Cr]`

Data1 00 to 17: 00 to 23 hours
 Data2 00 to 3B: 00 to 59 minutes
 Data3 00 to 3B: 00 to 59 seconds

* Enter "fx [Set ID] ff" to view the Time 2 (hour/minute/second) settings.

** This function is available only when Time 1 (year/month/day) is set.

Acknowledgement

`[x][][Set ID][][OK/NG][Data1][Data2][Data3][x]`**18. Off Time Schedule (Command: f c)**

Enables/disables the Off Time Schedule.

Transmission

`[f][c][][Set ID][][Data][Cr]`

Data 00: Off
 01: On

Acknowledgement

`[c][][Set ID][][OK/NG][Data][x]`**19. On Time Schedule (Command: f b)**

Enables/disables the On Time schedule.

Transmission

`[f][b][][Set ID][][Data][Cr]`

Data 00: Off
 01: On

Acknowledgement

`[b][][Set ID][][OK/NG][Data][x]`

20. Off Timer (Repeat/Time) (Command: f e)

Configures Off Timer (Repeat/Time) settings.

Transmission

[f][e][][Set ID][][Data1][][Data2][][Data3][Cr]

Data1

1. f1h to f7h (reading data)

F1: reads the 1st Off Timer data

F2: reads the 2nd Off Timer data

F3: reads the 3rd Off Timer data

F4: reads the 4th Off Timer data

F5: reads the 5th Off Timer data

F6: reads the 6th Off Timer data

F7: reads the 7th Off Timer data

2. e1h-e7h (delete one index), e0h (delete all indexes)

E0: erases all Off Timer settings

E1: erases the 1st Off Timer setting

E2: erases the 2nd Off Timer setting

E3: erases the 3rd Off Timer setting

E4: erases the 4th Off Timer setting

E5: erases the 5th Off Timer setting

E6: erases the 6th Off Timer setting

E7: erases the 7th Off Timer setting

3. 01h to 0Ch (sets the day of the week for the Off Timer)

01: Once

02: Daily

03: Mon - Fri

04: Mon - Sat

05: Sat - Sun

06: Every Sunday

07: Every Monday

08: Every Tuesday

09: Every Wednesday

0A: Every Thursday

0B: Every Friday

0C: Every Saturday

Data2 00 to 17:00 to 23 hours

Data3 00 to 3B:00 to 59 minutes

* To read or delete the Off Time Schedule list, [Data2][Data3] must be set to FFH.

Example 1: fe 01 f1 ff ff - reads the first index data in Off Timer.

Example 2: fe 01 e1 ff ff - deletes the first index data from Off Timer.

Example 3: fe 01 04 02 03 - sets Off Timer to 02:03 from Monday to Saturday.

* This function is available only when Time 1 (year/month/day) and Time 2 (hour/minute/second) are set.

Acknowledgement

[e][][Set ID][][OK/NG][Data1][Data2][Data3][x]

21. On timer (Repeat/Time) (Command: f d)

Configures On Timer (Repeat/Time) settings.

Transmission

[f][d][][Set ID][][Data1][][Data2][][Data3][Cr]

Data1

1. f1h to f7h (reading data)

F1: reads the 1st On Timer data

F2: reads the 2nd On Timer data

F3: reads the 3rd On Timer data

F4: reads the 4th On Timer data

F5: reads the 5th On Timer data

F6: reads the 6th On Timer data

F7: reads the 7th On Timer data

2. e1h-e7h (delete one index), e0h (delete all indexes)

E0: erases all On Timer settings

E1: erases the 1st On Timer setting

E2: erases the 2nd On Timer setting

E3: erases the 3rd On Timer setting

E4: erases the 4th On Timer setting

E5: erases the 5th On Timer setting

E6: erases the 6th On Timer setting

E7: erases the 7th On Timer setting

3. 01h to 0Ch (sets the day of the week for the On Timer)

01: Once

02: Daily

03: Mon - Fri

04: Mon - Sat

05: Sat - Sun

06: Every Sunday

07: Every Monday

08: Every Tuesday

09: Every Wednesday

0A: Every Thursday

0B: Every Friday

0C: Every Saturday

Data2 00 to 17:00 to 23 hours

Data3 00 to 3B:00 to 59 minutes

* To read or delete an On Time schedule list, [Data2][Data3] must be set to FFH.

Example 1: fd 01 f1 ff ff - reads the first index data from On Timer.

Example 2: fd 01 e1 ff ff - deletes the first index data from On Timer.

Example 3: fd 01 04 02 03 - sets On Timer to 02:03 from Monday to Saturday.

* This function is available only when Time 1 (year/month/day) and Time 2 (hour/minute/second) are set.

Acknowledgement

[d][][Set ID][][OK/NG][Data1][Data2][Data3][x]

22. On Timer Input (Command: f u)

Select an external input for the current On Time setting and add a new schedule.

Transmission

[f][u][][Set ID][][Data1][Cr]

[f][u][][Set ID][][Data1][][Data2][Cr]

Data (Add schedule)

70: DVI-D

90: HDMI1

91: HDMI2

C0: DISPLAYPORT

Data1 (Read schedule)

1. f1h to f7h (Read data)

F1: Select the 1st schedule input

F2: Select the 2nd schedule input

F3: Select the 3rd schedule input

F4: Select the 4th schedule input

F5: Select the 5th schedule input

F6: Select the 6th schedule input

F7: Select the 7th schedule input

Data2 (Read schedule)

FF

* To read the schedule input, enter FF for [Data2].

If no schedule is available for [Data1] when attempting to read the schedule data, the text 'NG' will be displayed and the operation will fail.

(Example 1: fu 01 90 - Move each schedule input down one row and save the 1st schedule input in HDMI mode.)

(Example 2: fu 01 f1 ff - Read the 1st schedule input.)

* This function is supported only when 1 (Year/Month/Day), 2 (Hour/Minute/Second), On Time (Repeat Mode/Time) are set.

** It may not be supported depending upon the model.

Acknowledgement

[u][][Set ID][][OK/NG][Data][x]

[u][][Set ID][][OK/NG][Data1][Data2][x]

23. No Signal Power Off (15Min) (Command: f g)

Configures the automatic standby settings.

Transmission

[f][g][][Set ID][][Data][Cr]

Data 00: Off

01: On

Acknowledgement

[g][][Set ID][][OK/NG][Data][x]

24. Auto Power Off (4 Hours) (Command: m n)

Configures the automatic off settings.

Transmission

[m][n][][Set ID][][Data][Cr]

Data 00: Off

01: 4 hours

Acknowledgement

[n][][Set ID][][OK/NG][Data][x]

25. Language (Command: f i)

Sets the OSD language.

Transmission

[f][i][][Set ID][][Data][Cr]

Data 00: Czech
01: Danish
02: German
03: English
04: Spanish (Europe)
05: Greek
06: French
07: Italian
08: Dutch
09: Norwegian
0A: Portuguese
0B: Portuguese (Brazil)
0C: Russian
0D: Finnish
0E: Swedish
0F: Korean
10: Chinese (Mandarin)
11: Japanese
12: Chinese (Cantonese)

Acknowledgement

[i][][Set ID][][OK/NG][Data][x]

26. Reset (Command: f k)

Performs the Picture and Factory Reset functions.

Transmission

[f][k][][Set ID][][Data][Cr]

Data 00: Picture Reset
02: Initial Settings (factory reset)

Acknowledgement

[k][][Set ID][][OK/NG][Data][x]

27. Current temperature (Command: d n)

Checks the inside temperature.

Transmission

[d][n][][Set ID][][Data][Cr]

Data FF: Check the status

Acknowledgement

[n][][Set ID][][OK/NG][Data1][Data2][Data3][x]

Data1 Temperature sensor at the exit (top).
Data2 Temperature sensor at the entrance (bottom).
Data3 Temperature sensor at the main board (main PCB)

* Temperature is displayed as a hexadecimal value.

* The number of data items differs depending on the model.

28. Key (Command: m c)

Sends a key code for the IR remote control.

Transmission

[m][c][][Set ID][][Data][Cr]

Data IR_KEY_CODE

Acknowledgement

[c][][Set ID][][OK/NG][Data][x]

For key codes, see IR Codes.

* Some key codes are not supported depending upon the model.

29. Time Elapsed (Command: d l)

Checks the elapsed time.

Transmission

[d][l][][Set ID][][Data][Cr]

Data FF: Read status

Acknowledgement

[l][][Set ID][][OK/NG][Data][x]

* The data received is shown as a hexadecimal value.

30. Product serial number (Command: f y)

Checks the serial number of the product.

Transmission

[f][y][][Set ID][][Data][Cr]

Data FF: Check product serial number

Acknowledgement

[y][][Set ID][][OK/NG][Data][x]

* Data is in ASCII code.

31. Software Version (Command: f z)

Checks the software version of the product.

Transmission

[f][z][][Set ID][][Data][Cr]

Data FF: Check software version

Acknowledgement

[z][][Set ID][][OK/NG][Data][x]

32. White balance red gain (Command: j m)

Adjusts the white balance red gain value.

Transmission

[j][m][][Set ID][][Data][Cr]

Data 00 to FE: Red Gain 0 to 254
FF: checks the red gain value

Acknowledgement

[m][][Set ID][][OK/NG][Data][x]

33. White Balance Green Gain (Command: j n)

Adjusts the white balance green gain value.

Transmission

[j][n][][Set ID][][Data][Cr]

Data 00 to FE: Green Gain 0 to 254
FF: checks the green gain value

Acknowledgement

[n][][Set ID][][OK/NG][Data][x]

34. White Balance Blue Gain (Command: j o)

Adjusts the white balance blue gain value.

Transmission

[j][o][][Set ID][][Data][Cr]

Data 00 to FE: Blue Gain 0 to 254
FF: checks the blue gain value

Acknowledgement

[o][][Set ID][][OK/NG][Data][x]

35. White Balance Red Offset (Command: s x)

Adjusts the white balance red offset value.

Transmission

[s][x][][Set ID][][Data][Cr]

Data 00 to 7F: Red Offset 0 to 127
FF: checks the red offset value

Acknowledgement

[x][][Set ID][][OK/NG][Data][x]

36. White Balance Green Offset (Command: s y)

Adjusts the white balance green offset value.

Transmission

[s][y][][Set ID][][Data][Cr]

Data 00 to 7F: Green Offset 0 to 127
FF: checks the green offset value

Acknowledgement

[y][][Set ID][][OK/NG][Data][x]

37. White Balance Blue Offset (Command: s z)

Adjusts the white balance blue offset value.

Transmission

[s][z][][Set ID][][Data][Cr]

Data 00 to 7F: Blue Offset 0 to 127
FF: checks the blue offset value

Acknowledgement

[z][][Set ID][][OK/NG][Data][x]

38. Backlight (Command: m g)

Adjusts the backlight brightness.

Transmission

[m][g][][Set ID][][Data][Cr]

Data 00 to 64: Backlight 0 to 100

Acknowledgement

[g][][Set ID][][OK/NG][Data][x]

39. Screen Off (Command: k d)

Turns the screen on or off.

Transmission

[k][d][][Set ID][][Data][Cr]

Data 00: turns the screen on

01: turns the screen off

Acknowledgement

[d][][Set ID][][OK/NG][Data][x]

40. Tile Mode (Command: d d)

Sets the Tile Mode and sets values for the tile rows and columns.

Transmission

[d][d][][Set ID][][Data][Cr]

Data 00 to FF: The first byte - tile column

The second byte - tile row

* 00, 01, 10, and 11 mean that the tile mode is off

Acknowledgement

[d][][Set ID][][OK/NG][Data][x]

41. Check Tile Mode (Command: d z)

Checks the tile mode.

Transmission

[d][z][][Set ID][][Data][Cr]

Data FF: checks the tile mode

Acknowledgement

[z][][Set ID][][OK/NG][Data1][Data2][Data3][x]

Data1 00: tile mode off

01: tile mode on

Data2 00 to 0F: tile column

Data3 00 to 0F: tile row

42. Tile ID (Command: d i)

Sets the tile ID value of the product.

Transmission

[d][i][][Set ID][][Data][Cr]

Data 01 to E1: Tile ID 1 to 225**

FF: checks the tile ID

** The data value cannot exceed the value of row x column.

Acknowledgement

[i][][Set ID][][OK/NG][Data][x]

When a data value that exceeds the value of row x column is entered (except 0xFF), ACK becomes NG.

43. Natural Mode (in Tile mode) (Command: d j)

When displaying the image naturally, the part of the image that would normally be displayed in the gap between the monitors is omitted.

Transmission

[d][j][][Set ID][][Data][Cr]

Data 00: Off

01: On

Acknowledgement

[j][][Set ID][][OK/NG][Data][x]

44. DPM Select (Command: f j)

To set the DPM (Display Power Management) function.

Transmission

[f][j][][Set ID][][Data][Cr]

Data 00: Off
 01: 5 seconds
 02: 10 seconds
 03: 15 seconds
 04: 1 minutes
 05: 3 minutes
 06: 5 minutes
 07: 10 minutes

Acknowledgement

[j][][Set ID][][OK/NG][Data][x]

45. Power On Delay (Command: f h)

Sets the schedule delay when the power turns on. (unit: seconds).

Transmission

[f][h][][Set ID][][Data][Cr]

Data 00 to FA: min. 0 to maximum 250 (seconds)

Acknowledgement

[h][][Set ID][][OK/NG][Data][x]

46. Fail Over Select (Command: m i)

Selects an input mode for auto switch.

Transmission

[m][i][][Set ID][][Data][Cr]

Data 00: Off
 01: Auto
 02: Manual

Acknowledgement

[i][][Set ID][][OK/NG][Data][x]

47. Fail Over Input Select (Command: m j)

Selects an input source for auto switch.

* This command is only available when the Fail Over (auto) mode is set to Custom.

Transmission

[m][j][][Set ID][][Data1][][Data2][][Data3][][Data4][Cr]

Data 1 to 4 (Input priority: 1 to 4)

70: DVI-D
 90: HDMI1
 91: HDMI2
 C0: DISPLAYPORT

Acknowledgement

[j][][Set ID][][OK/NG][Data1][Data2][Data3][Data4][x]

Data 1 to 4 (Input priority: 1 to 4)

70: DVI-D
 90: HDMI1
 91: HDMI2
 C0: DISPLAYPORT

48. IR Operation (Command: t p)

Configures the IR operation settings of the product.

Transmission

[t][p][][Set ID][][Data][Cr]

Data 00: locks off all of the keys
 01: locks on all of the keys except the Power key
 02: locks on all of the keys

Acknowledgement

[x][][Set ID][][OK/NG][Data][x]

49. Status check (Command: s v)

Check the current signal of the product.

Transmission

[s][v][][Set ID][][Data][][FF][Cr]

Data 02: Checks whether there is a signal

05: Checks whether luminance sensors 1 and 2 work properly.

06: Currently used luminance sensor

07: Checks whether the Top, Bottom, and Main temperature sensors are functioning normally.

08: The temperature of each temperature sensor when the monitor set was last powered off.

09: Fan Speed

Acknowledgement

[v][][Set ID][][OK/NG][Data][Data1][x]

Data: If the value is 02,

Data1 00: Signal absent

01: Signal present

Data: If the value is 05,

Data1 00: All sensors normal

01: BLU sensor 1 normal, BLU sensor 2 down

02: BLU sensor 1 down, BLU sensor 2 normal

03: All sensors down

Data: If the value is 06,

00: Luminance sensor 1 currently used

01: Luminance sensor 2 currently used

Data: If the value is 07,

Data1 00: All temperature sensors are faulty.

01: Top normal, Bottom faulty, Main faulty

02: Top faulty, Bottom normal, Main faulty

03: Top normal, Bottom normal, Main faulty

04: Top faulty, Bottom faulty, Main normal

05: Top normal, Bottom faulty, Main normal

06: Top faulty, Bottom normal, Main normal

07: All temperature sensors are normal

Data: If the value is 08,

Acknowledgement

[v][][SetID][][OK/NG][Data][Data1][Data2][Data3][x]

Data1 The temperature of the Top sensor when the monitor set is last powered off.

Data2 The temperature of the Bottom sensor when the monitor set is last powered off.

Data3 The temperature of the Main sensor when the monitor set is last powered off.

Data: if the value is 09,

Acknowledgement

[v][][SetID][][OK/NG][Data][Data1][Data2][x]

Data1 00-ff: The upper 1-byte of the fan speed

Data2 00-ff: The lower 1-byte of the fan speed

Fan speed: 0 to 2008 in hexadecimal and 0 to 8200 in decimal

** Depending upon the model, this feature may not be supported.

50. Speakers (Command: d v)

Sets the speakers feature.

Transmission

[d][v][][Set ID][][Data][Cr]

Data 00: Off

01: On

Acknowledgement

[v][][Set ID][][OK/NG][Data][x]

51. Daylight Saving Time (Command: s d)

Sets the Daylight Saving Time feature.

Transmission

[s][d][][Set ID][][Data1][][Data2][][Data3][][Data4][][Data5][Cr]

Data1 00: Off (Data2~5: FFH)

01: Start time

02: End time

Data2 01 to 0C: January to December

Data3 01 to 06: Weeks 1 to 6

* The maximum value of [Data3] may vary depending on the date.

Data4 00 to 06 (Sunday to Saturday)

Data5 00 to 17: 00th to 23th hour

* To read the start/end times, enter FFH in [Data2] through [Data5].

(Ex. 1: sd 01 01 ff ff ff - Checks the start time.

Ex. 2: sd 01 02 ff ff ff - Checks the end time.)

* This feature is only available when Clock 1 (year/month/day) and Clock 2 (hour/minute/second) are set.

Acknowledgement

[d][][Set ID][][OK/NG][Data1][Data2][Data3][Data4][Data5][x]

** Depending upon the model, this feature may not be supported.

52. Wake On Lan (Command: f w)

Selects whether to turn on/off Wake On Lan.

Transmission

[f][w][][Set ID][][Data][Cr]

Data 00: Wake On Lan On

01: Wake On Lan Off

Acknowledgement

[w][][Set ID][][OK/NG][Data][x]

** Depending upon the model, this feature may not be supported.

53. Power Indicator (Command: f o)

Sets the Power Indicator Settings.

Transmission`[f][o][][Set ID][][Data][Cr]`Data 00: Off
01: On**Acknowledgement**`[o][][Set ID][][OK/NG][Data][x]`

** Depending upon the model, this feature may not be supported.

54. Fan control (Command: d o)

Sets the fan mode.

Transmission`[d][o][][Set ID][][Data][Cr]`Data 00: Auto
01: On
02: Manual
03: Off**Acknowledgement**`[o][][Set ID][][OK/NG][Data][x]`

** Depending upon the model, this feature may not be supported.

55. Fan Failure Check (Command: d w)

Checks for fan failures.

Transmission`[d][w][][Set ID][][Data][Cr]`

Data FF: Status read

Acknowledgement`[w][][Set ID][][OK/NG][Data1][Data2][x]`Data 1 00: One or more fans are faulty.
01: All fans are normal.
02: The model has no fan.Data2 00: No fan is faulty (all fans are normal).
01: 1 fan is faulty.
02: 2 fans are faulty.
03: 3 fans are faulty.
04: 4 fans are faulty.
05: 5 fans are faulty.**56. Luminance Value Read (Command: m u)**

Reads luminance values.

Transmission`[m][u][][Set ID][][FF][Cr]`**Acknowledgement**`[u][][Set ID][][OK/NG][Data1][Data2][Data3][Data4][Data5][Data6][Data7][x]`Data1 00 to 64: The Backlight PWM value (0 to 100)
Data2 00 to ff: The upper 1-byte of the value measured by the CA-210.
Data3 00 to ff: The lower 1-byte of the value measured by the CA-210.

CA-210 measurement: 0000 to ffff in hexadecimal and 0 to 65535 in decimal.

Data4 00 to ff: The upper 1-byte of the value measured by BLU 1 sensor.

Data5 00 to ff: The lower 1-byte of the value measured by BLU 1 sensor.

Data6 00 to ff: The upper 1-byte of the value measured by BLU 2 sensor.

Data7 00 to ff: The lower 1-byte of the value measured by BLU 2 sensor.

BLU measurements: 0000 to ffff in hexadecimal and 0 to 65535 in decimal.

* During final assembly, a CA-210 measurement is entered through the calibration procedure. The default value, before calibration, is 0.

** Depending upon the model, this feature may not be supported.

57. BLU Maintenance (Command: m t)

Selects whether to turn on/off BLU Maintenance.

Transmission`[m][t][][Set ID][][Data][Cr]`Data 00: BLU Maintenance Off
01: BLU Maintenance On**Acknowledgement**`[t][][Set ID][][OK/NG][Data][x]`

** Depending upon the model, this feature may not be supported.

58. Easy Brightness Control Mode (Command: s m)

Selects whether to turn on/off Easy Brightness Control Mode.

Transmission`[s][m][][Set ID][][Data][Cr]`Data 00: Easy Brightness Control Off
01: Easy Brightness Control On**Acknowledgement**`[m][][Set ID][][OK/NG][Data][x]`

* This function does not work if the current time is not set.

** Depending upon the model, this feature may not be supported.

59. Easy Brightness Control Schedule (Command: s s)

Sets an Easy Brightness Control schedule.

Transmission

[s][s][][Set ID][][Data1][][Data2][][Data3][Cr]

Data 1

1. f1 to f6 (data reading)

F1: Reads the 1st data from the Easy Brightness Control

F2: Reads the 2nd data from the Easy Brightness Control

F3: Reads the 3rd data from the Easy Brightness Control

F4: Reads the 4th data from the Easy Brightness Control

F5: Reads the 5th data from the Easy Brightness Control

F6: Reads the 6th data from the Easy Brightness Control

2. FF: Reads all stored lists

3. e1-e6 (deletes one index); e0 (deletes all indexes)

E0: Deletes all Easy Brightness Controls

E1: Deletes the 1st Easy Brightness Control

E2: Deletes the 2nd Easy Brightness Control

E3: Deletes the 3rd Easy Brightness Control

E4: Deletes the 4th Easy Brightness Control

E5: Deletes the 5th Easy Brightness Control

E6: Deletes the 6th Easy Brightness Control

4. 00 to 17: 00th to 23th hour

Data2 00 to 3B: 00th to 59th minute

Data3 00 to 64: Backlight, 0 to 100

* If you want to read or delete the configured Easy Brightness Control lists, set [Data2][Data3] to FF.

* If you want to import all the configured Easy Brightness Control lists through FF, do not enter any values in [Data2] [Data3].

* When all the configured Easy Brightness Control lists are imported through FF, OK is acknowledged even if there is no stored list.

Example 1: ss 01 f1 ff ff - Reads the first index data from the Easy Brightness Control.

Example 2: ss 01 ff - Reads all index data from the Easy Brightness Control.

Example 3: ss 01 e1 ff ff - Deletes the first index data from the Easy Brightness Control.

Example 4: ss 01 07 1E 46 - Adds a schedule whose time is 07:30 and whose backlight is 70.

Acknowledgement

[s][][Set ID][][OK/NG][Data1][Data2][Data3][x]

** Depending upon the model, this feature may not be supported.



Make sure to read the Safety Precautions before using the product.

The model and serial numbers of the SET are located on the back and one side of the SET. Record it below should you ever need service.

WARNING -This is a class A product. In a domestic environment this product may cause radio interference in which case the user may be required to take adequate measures.

MODEL _____

SERIAL _____

To obtain the source code under GPL, LGPL, MPL, and other open source licenses, that is contained in this product, please visit <http://opensource.lge.com>. In addition to the source code, all referred license terms, warranty disclaimers and copyright notices are available for download.

LG Electronics will also provide open source code to you on CD-ROM for a charge covering the cost of performing such distribution (such as the cost of media, shipping, and handling) upon email request to opensource@lge.com. This offer is valid for three (3) years from the date on which you purchased the product.

Temporary noise is normal when powering ON or OFF this device.