

AVENTAGE

Blu-ray Disc Player

BD-A1060

EN

Owner's Manual

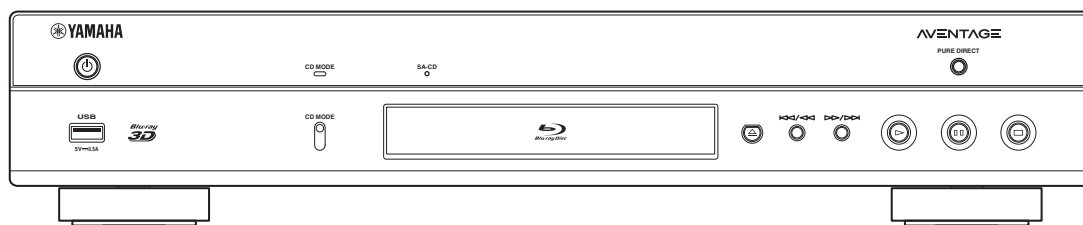

IMPORTANT SAFETY INSTRUCTIONS

Read these operating instructions carefully before using the unit. Follow the safety instructions on the unit and the applicable safety instructions listed below. Keep these operating instructions handy for future reference.

- 1 Read these instructions.
- 2 Keep these instructions.
- 3 Heed all warnings.
- 4 Follow all instructions.
- 5 Do not use this apparatus near water.
- 6 Clean only with dry cloth.
- 7 Do not block any ventilation openings. Install in accordance with the manufacturer's instructions.
- 8 Do not install near any heat sources such as radiators, heat registers, stoves, or other apparatus (including amplifiers) that produce heat.
- 9 Do not defeat the safety purpose of the polarized or grounding-type plug. A polarized plug has two blades with one wider than the other. A grounding-type plug has two blades and a third grounding prong. The wide blade or the third prong are provided for your safety. If the provided plug does not fit into your outlet, consult an electrician for replacement of the obsolete outlet.
- 10 Protect the power cord from being walked on or pinched particularly at plugs, convenience receptacles, and the point where they exit from the apparatus.
- 11 Only use attachments/accessories specified by the manufacturer.
- 12 Use only with the cart, stand, tripod, bracket, or table specified by the manufacturer, or sold with the apparatus. When a cart is used, use caution when moving the cart/apparatus combination to avoid injury from tip-over.
- 13 Unplug this apparatus during lightning storms or when unused for long periods of time.
- 14 Refer all servicing to qualified service personnel. Servicing is required when the apparatus has been damaged in any way, such as power-supply cord or plug is damaged, liquid has been spilled or objects have fallen into the apparatus, the apparatus has been exposed to rain or moisture, does not operate normally, or has been dropped.

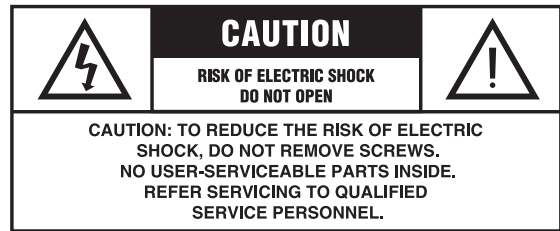

The lightning flash with arrowhead symbol, within an equilateral triangle, is intended to alert the user to the presence of uninsulated "dangerous voltage" within the product's enclosure that may be of sufficient magnitude to constitute a risk of electric shock to persons.



The exclamation point within an equilateral triangle is intended to alert the user to the presence of important operating and maintenance (servicing) instructions in the literature accompanying the appliance.

FCC INFORMATION (for US customers)

1 **IMPORTANT NOTICE: DO NOT MODIFY THIS UNIT!**

This product, when installed as indicated in the instructions contained in this manual, meets FCC requirements.

Modifications not expressly approved by Yamaha may void your authority, granted by the FCC, to use the product.

2 **IMPORTANT:** When connecting this product to accessories and/or another product use only high quality shielded cables. Cable/s supplied with this product **MUST** be used. Follow all installation instructions. Failure to follow instructions could void your FCC authorization to use this product in the USA.

3 **NOTE:** This product has been tested and found to comply with the requirements listed in FCC Regulations, Part 15 for Class "B" digital devices. Compliance with these requirements provides a reasonable level of assurance that your use of this product in a residential environment will not result in harmful interference with other electronic devices. This equipment generates/uses radio frequencies and, if not installed and used according to the instructions found in the users manual, may cause interference harmful to the operation of other electronic devices.

Compliance with FCC regulations does not guarantee that interference will not occur in all installations. If this product is found to be the source of interference, which can be determined by turning the unit "OFF" and "ON", please try to eliminate the problem by using one of the following measures:

Relocate either this product or the device that is being affected by the interference.

Utilize power outlets that are on different branch (circuit breaker or fuse) circuits or install AC line filter/s.

In the case of radio or TV interference, relocate/reorient the antenna. If the antenna lead-in is 300 ohm ribbon lead, change the lead-in to coaxial type cable.

If these corrective measures do not produce satisfactory results, please contact the local retailer authorized to distribute this type of product. If you can not locate the appropriate retailer, please contact Yamaha Corporation of America A/V Division, 6600 Orangethorpe Ave., Buena Park, CA 90620.

The above statements apply **ONLY** to those products distributed by Yamaha Corporation of America or its subsidiaries.

COMPLIANCE INFORMATION STATEMENT (DECLARATION OF CONFORMITY PROCEDURE)

Responsible Party: Yamaha Corporation of America
A/V Division
Address: 6600 Orangethorpe Avenue
Buena Park, CA 90620, USA
Telephone: 1-714-522-9011
Type of Equipment: Blu-ray Disc Player
Model Name: BD-A1060

- This device complies with Part 15 of the FCC Rules and RSS-Gen of IC Rules.
 - Operation is subject to the following two conditions:
 - 1) this device may not cause harmful interference, and
 - 2) this device must accept any interference received including interference that may cause undesired operation.
- See the "Troubleshooting" section at the end of this manual if interference to radio reception is suspected.

We Want You Listening For A Lifetime



Yamaha and the Electronic Industries Association's Consumer Electronics Group want you to get the most out of your equipment by playing it at a safe level. One that lets the sound come through loud and clear without annoying blaring or distortion - and, most importantly, without affecting your sensitive hearing.

Since hearing damage from loud sounds is often undetectable until it is too late, Yamaha and the Electronic Industries Association's Consumer Electronics Group recommend you to avoid prolonged exposure from excessive volume levels.

IMPORTANT

Please record the serial number of this unit in the space below.

MODEL:

Serial No.:

The serial number is located on the rear of the unit.

Retain this Owner's Manual in a safe place for future reference.

To obtain information about disposing unwanted, end-of-life products in USA, please visit <http://usa.yamaha.com/support/>

FCC WARNING

Change or modifications not expressly approved by the party responsible for compliance could void the user's authority to operate the equipment.

NOTICE

This equipment has been tested and found to comply with the limits for a Class B digital device, pursuant to part 15 of the FCC Rules. These limits are designed to provide reasonable protection against harmful interference in a residential installation.

This equipment generates, uses and can radiate radio frequency energy and, if not installed and used in accordance with the instructions, may cause harmful interference to radio communications. However, there is no guarantee that interference will not occur in a particular installation. If this equipment does cause harmful interference to radio or television reception, which can be determined by turning the equipment off and on, the user is encouraged to try to correct the interference by one or more of the following measures:

- Reorient or relocate the receiving antenna.
- Increase the separation between the equipment and receiver.
- Connect the equipment into an outlet on a circuit different from that to which the receiver is connected.
- Consult the dealer or an experienced radio/TV technician for help.

To satisfy FCC RF exposure requirements, a separation distance of 20 cm or more should be maintained between the antenna of this device and persons during device operation.

To ensure compliance, operations at closer than this distance is not recommended.

Under Industry Canada regulations, this radio transmitter may only operate using an antenna of a type and maximum (or lesser) gain approved for the transmitter by Industry Canada. To reduce potential radio interference to other users, the antenna type and its gain should be so chosen that the equivalent isotropically radiated power (e.i.r.p.) is not more than that necessary for successful communication.

This transmitter must not be co-located or operated in conjunction with any other antenna or transmitter.

FOR CANADIAN CUSTOMERS

To prevent electric shock, match wide blade of plug to wide slot and fully insert.

Caution: Read this before operating your unit.

- 1 To assure the finest performance, please read this manual carefully. Keep it in a safe place for future reference.
- 2 Install this sound system in a well ventilated, cool, dry, clean place—away from direct sunlight, heat sources, vibration, dust, moisture, and/or cold. For proper ventilation, allow the following minimum clearances.
Top : 10 cm (4 in)
Rear: 10 cm (4 in)
Side: 10 cm (4 in)
- 3 Locate this unit away from other electrical appliances, motors, or transformers to avoid humming sounds.
- 4 Do not expose this unit to sudden temperature changes from cold to hot, and do not locate this unit in an environment with high humidity (i.e. a room with a humidifier) to prevent condensation inside this unit, which may cause an electrical shock, fire, damage to this unit, and/or personal injury.
- 5 Avoid installing this unit where foreign object may fall onto this unit and/or this unit may be exposed to liquid dripping or splashing. On the top of this unit, do not place:
 - Other components, as they may cause damage and/or discoloration on the surface of this unit.
 - Burning objects (i.e. candles), as they may cause fire, damage to this unit, and/or personal injury.
 - Containers with liquid in them, as they may fall and liquid may cause electrical shock to the user and/or damage to this unit.
- 6 Do not cover this unit with a newspaper, tablecloth, curtain, etc. in order not to obstruct heat radiation. If the temperature inside this unit rises, it may cause fire, damage to this unit, and/or personal injury.
- 7 Do not plug in this unit to a wall outlet until all connections are complete.
- 8 Do not operate this unit upside-down. It may overheat, possibly causing damage.
- 9 Do not use force on switches, knobs and/or cords.
- 10 When disconnecting the power cable from the wall outlet, grasp the plug; do not pull the cable.
- 11 Do not clean this unit with chemical solvents; this might damage the finish. Use a clean, dry cloth.
- 12 Only voltage specified on this unit must be used. Using this unit with a higher voltage than specified is dangerous and may cause fire, damage to this unit, and/or personal injury. Yamaha will not be held responsible for any damage resulting from use of this unit with a voltage other than specified.
- 13 To prevent damage by lightning, keep the power cable disconnected from a wall outlet or this unit during a lightning storm.
- 14 Do not attempt to modify or fix this unit. Contact qualified Yamaha service personnel when any service is needed. The cabinet should never be opened for any reasons.
- 15 When not planning to use this unit for long periods of time (i.e. vacation), disconnect the AC power plug from the wall outlet.
- 16 Be sure to read the “Troubleshooting” section on common operating errors before concluding that this unit is faulty.
- 17 Before moving this unit, press  to set this unit to the standby mode, and disconnect the AC power plug from the wall outlet.
- 18 Condensation will form when the surrounding temperature changes suddenly. Disconnect the power cable from the outlet, then leave this unit alone.
- 19 When using this unit for a long time, this unit may become warm. Turn the power off, then leave this unit alone for cooling.
- 20 Install this unit near the AC outlet and where the AC power plug can be reached easily.
- 21 The batteries shall not be exposed to excessive heat such as sunshine, fire or the like.

Do not use this unit within 22 cm (9 inches) of persons with a heart pacemaker implant or defibrillator implant.

Radio waves may affect electro-medical devices. Do not use this unit near medical devices or inside medical facilities.

This unit is not disconnected from the AC power source as long as it is connected to the wall outlet, even if this unit itself is turned off by . This state is called the standby mode. In this state, this unit is designed to consume a very small quantity of power.

Where the mains plug or an appliance coupler is used as the disconnect device, the disconnect device shall remain readily operable.

WARNING

TO REDUCE THE RISK OF FIRE OR ELECTRIC SHOCK, DO NOT EXPOSE THIS UNIT TO RAIN OR MOISTURE.

LASER SAFETY

This unit employs a laser. Due to possible eye injury, only a qualified service person should remove the cover or attempt to service this device.

DANGER

This unit emits visible laser radiation when open. Avoid direct eye exposure to beam. When this unit is plugged into the wall outlet, do not place your eyes close to the opening of the disc tray and other openings to look into inside.

Contents

1

1. Introduction

What you can do with this Player	2
Wide variety of supported discs and file formats	2
Enhanced network features	2
Easy setup and operations	2
High-quality audio features	2
Supplied parts	2
About discs and files	3
Types of discs/files that can be used with this Player	3
Loading a disc	4
Disc precautions	5
Notice for watching 3D video images	5
Cinavia technology	5
Controls and functions	6
Front panel	6
Rear panel	7
Remote control	8

2. Connection

Video/audio connections	12
Connecting to a TV via an AV receiver	13
Connecting to a TV directly	13
Connecting to a TV and audio equipment	14
Network connection	16
Wireless connection	16
Wired connection	16
DLNA server setup	17
Other connections	18
Connecting Yamaha components that support remote connections	18
USB connection	19
Connecting the power cable	20

3. Playback

Initial settings	21
Setting with the Easy Setup	21
Wireless connection setting	21
Playing back video/music/photo	22
Playing back commercially available discs	22
Playing back video/music files	22
Viewing photos	23
Viewing VUDU contents	24
Enjoying high-quality sound	26
Enjoying music CD/SA-CD in high-quality sound (CD mode)	26
Enjoying music and movies with pure high fidelity sounds (Pure Direct)	26
Enjoying DLNA playback of mobile device contents via Wi-Fi Direct	27
Enjoying smartphone pictures and videos on the TV screen (Miracast™)	28
Operating this Player from mobile devices ...	29
Advanced playback operation	30
On Screen menu	30
Status menu	31
Program play	32
Using Search	32
Enjoying BONUSVIEW™ and BD-Live™	32
Using Picture in Picture function (secondary audio/video playback)	33
Using the feature of BD-Live™	33

4. Settings

SETUP menu	34
Example of SETUP menu operation	36
General Setting	37

Display Setting	40
Audio Setting	42
System Information	43
Video/audio output formats	44
Video output formats	44
Audio output formats	45
Software upgrade	46
Upgrading the software	46

5. Additional information

Troubleshooting	47
Power	47
Basic operation	47
Disc playback	47
Picture	48
Sound	48
Network	49
Messages on the screen	50
Glossary	51
Specifications	53
General	53
Audio performance	53
Input/output	53
Copyright	53
Index	55

New software that provides additional features or product improvements will be released as needed. We recommend upgrading the software of this Player to the latest version periodically. For details, refer to “Software upgrade” (p. 46).

■ About this manual

- This manual describes how to operate this Player using a remote control except when it is not available. Some of these operations are also available using the front panel buttons.
- Notes contain important information about safety and operating instructions. Hint(s) indicates a tip for your operation.
- This manual is printed prior to production. Design and specifications are subject to change in part as a result of improvements, etc. In case of differences between the manual and the product, the product has priority.

The icons used in this manual

Icons are used to indicate available buttons/functions for a particular format. For details on playable discs and formats, see page 3.

- BD** : BD-Video
- DVD** : DVD-Video, DVD-VR, DVD+VR
- CD** : Audio CD, Super Audio CD
- VIDEO** : Video files
- MUSIC** : Audio files
- PHOTO** : Photo files

2

3

4

5

What you can do with this Player

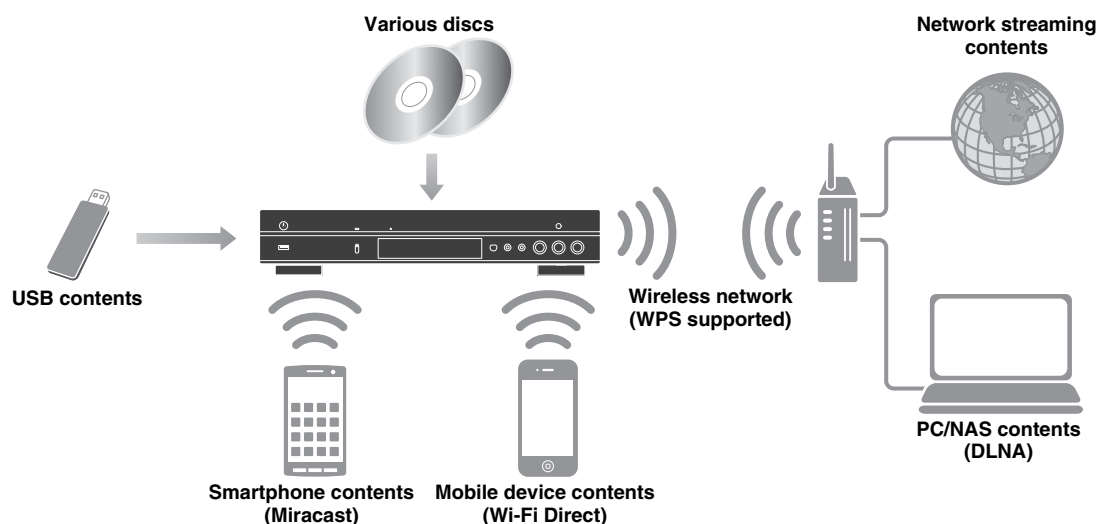

■ Wide variety of supported discs and file formats

- Blu-ray Disc™, DVDs, SA-CDs and CDs (p. 30)
- Blu-ray 3D™ (p. 12), BONUSVIEW™ and BD-Live™ (p. 32)
- Video, music and photo files on DVD-R/RW discs, CD-R/RW discs and USB memory devices (p. 22)

■ Enhanced network features

- Enjoying DLNA server (PC or NAS) contents (p. 17)
- Enjoying streaming contents on the network services (p. 24)
- Operating this player from mobile devices via network (AV CONTROLLER) (p. 29)
- Enjoying smartphone pictures and videos on the TV screen (Miracast™) (p. 28)
- Direct network connection to a mobile device (Wi-Fi Direct) (p. 27)

■ Easy setup and operations

- Quick and easy initial setup (p. 21)
- Automatic wireless setup with the WPS (Wi-Fi Protected Setup) (p. 21)
- Software upgrade via network or USB (p. 46)
- Sequential operations of the TV, AV receiver and this Player (HDMI Control) (p. 37)

■ High-quality audio features

- CD mode for hi-quality and accurate disc playback for audio CD and SA-CD (p. 26)
- Pure Direct mode for hi-quality audio for any audio sources (p. 26)
- Up to 192-kHz/24-bit audio file formats including WAV, FLAC and ALAC supported (p. 3)
- Super Audio CD (SA-CD) and DSD audio file (2.8/5.6 MHz) supported (p. 4)
- XLR balanced output jacks for transmitting high-quality audio to a power amplifier (p. 15)

Supplied parts

Make sure the following accessories are provided with the product.

Remote control



Batteries (x2)
(AAA, R03, UM-4)

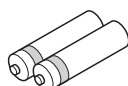

Power cable

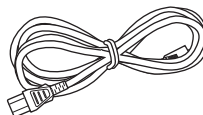

Types of discs/files that can be used with this Player

- 12 cm (5") and 8 cm (3") discs can be played back in this Player. Do not use an 8 cm (3") to 12 cm (5") adapter.
- Use discs that conform to compatible standards as indicated by the presence of official logos on the disc label. Playback of discs not complying with these standards is not guaranteed. In addition, the image quality or sound quality is not guaranteed even if the discs can be played back.

Media Type	Recording Format
BD-ROM/BD-R/ BD-RE	BD-Video/Data files
DVD-ROM	DVD-Video
DVD-R/DVD-R DL/DVD-RW	DVD-Video/DVD-VR/AVCHD/Data files
DVD+R/DVD+R DL/DVD+RW	DVD-Video/DVD+VR/AVCHD/Data files
CD-ROM	CDDA/HDCD
CD-R/CD-RW	CDDA/Data files
SA-CD	SA-CD
USB*	Data files
DLNA	Data files

* This Player is compatible with a USB memory device formatted with FAT 16/32 and NTFS.

Playable audio file formats MUSIC	Playable video file formats VIDEO	Playable photo file formats PHOTO
MP3 (.mp3) *1 WMA (.wma) *2 AAC (.aac/.m4a) WAV (.wav) *3 FLAC (.flac) *3 ALAC (.m4a) *3 DSDIFF (.dff) *4 DSF (.dsf) *4	MKV with H.264 (.mkv) MPEG PS (.mpeg/.mpg) MPEG TS (.ts) MPEG-4 (.mp4) VOB (.vob) AVI (.avi) ASF (.asf) WMV (.wmv) *5	JPEG (.jpeg/.jpg) GIF (.gif) PNG (.png)











- *1 Sampling frequency within 32-48 kHz (Stereo) and bitrate within 8-320 kbps
- *2 Sampling frequency within 32-48 kHz (Stereo) and bitrate within 32-192 kbps
- *3 Sampling frequency of up to 192 kHz/24 bit (LPCM/ Stereo)
- *4 Sampling frequency of 2.8/5.6 MHz
- *5 WMV9 (maximum resolution: 1,920 x 1,080)



Notes

- Playback of a file listed in the chart above is not guaranteed depending on methods of file creation or codecs used.
- Playback of all files on the disc, USB memory device and network is not guaranteed.
- A copyright protected file cannot be played back.
- When using DLNA, a file needs to meet the DLNA sever requirement.

Region management information for Blu-ray Disc/DVD videos

- Blu-ray Disc/DVD video players and discs have region codes, which dictate the regions in which a disc can be played. Verify the region code mark on the rear panel of this Player.
- For a Blu-ray Disc, the disc can be played back on this Player with the same region code mark, or the region code "ABC" mark.
- For a DVD disc, the disc can be played back on this Player with the same region code mark, or the region code "ALL" mark.

Region management information		
Destination	BD-Video	DVD-Video
U.S.A. and Canada	Region code "A" or "ABC" 	Region number "1" or "ALL" 
Europe	Region code "B" or "ABC" 	Region number "2" or "ALL" 
Asia and Taiwan	Region code "A" or "ABC" 	Region number "3" or "ALL" 
Central and South America	Region code "A" or "ABC" 	Region number "4" or "ALL" 
Australia	Region code "B" or "ABC" 	Region number "4" or "ALL" 

Region management information		
Destination	BD-Video	DVD-Video
Russia	Region code "C" or "ABC" 	Region number "5" or "ALL" 

Notes

- Blu-ray Disc/DVD video operations and functions may be different from the explanations in this manual and some operations may be prohibited due to disc manufacturer's settings.
- If a menu screen or operating instructions are displayed during playback of a disc, follow the operating procedure displayed.
- Playback for some of the discs may not be possible depending on the disc.
- Finalize all recording media that is played back in this Player.
- "Finalize" refers to a recorder processing a recorded disc so that it will play in other players/recorders as well as this Player. Only finalized discs can be played back in this Player. (This Player does not have a function to finalize discs.)

About Super Audio CD (SA-CD)

- Audio format based upon the current CD standards but includes a greater amount of information that provides higher quality sound. There are three types of discs: single layer, dual layer and hybrid discs. The hybrid disc can be played on existing CD players as well as Super Audio CD players since it contains both standard audio CD and Super Audio CD information.

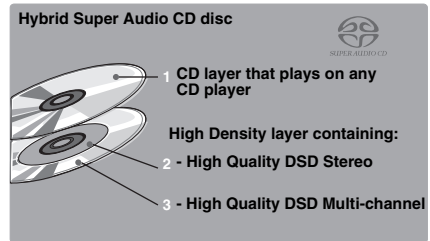
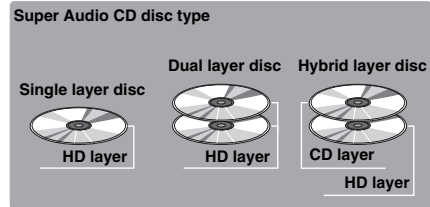

Hint

- You can select the output audio signals from DSD or PCM (p. 42).

Note

- This unit does not show the text data included in the discs on the front panel display.

Loading a disc

- Insert the disc with the label facing up.
- In case of the disc recorded on both sides, face down the side to play back.

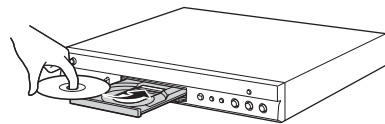

Notes





- Playback may begin automatically, depending on the disc and setting of this Player.
- The menu may be displayed first, depending on the disc.
- The disc load time may vary depending on the disc.

■ Disc precautions

Be careful of scratches and dust

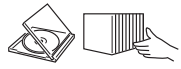
- Blu-ray Disc, DVD and CD discs are sensitive to dust, fingerprints and especially scratches. A scratched disc may not be able to be played back. Handle discs with care and store them in a safe place.

Proper disc storage

Place the disc in the center of the disc case and store the case and disc upright.	
Avoid storing discs in locations subject to direct sunlight, close to heating appliances or in locations of high humidity.	
Do not drop discs or subject them to strong vibrations or impacts.	
Avoid storing discs in locations where there are large amounts of dust or moisture.	

Handling precautions



- If the surface is soiled, wipe gently with a soft, damp (water only) cloth. When wiping discs, always move the cloth from the center hole toward the outer edge.



- Do not use record cleaning sprays, benzene, thinner, static electricity prevention liquids or any other solvent.

- Do not touch the surface.
- Do not stick paper or adhesive labels to the disc.
- If the playing surface of a disc is soiled or scratched, the Player may decide that the disc is incompatible and eject the disc tray, or it may fail to play the disc correctly. Wipe any dirt off the playing surface with a soft cloth.

Cleaning the pick up lens

- Never use commercially available cleaning discs. The use of these discs can damage the lens.
- Request the nearest service center approved by Yamaha to clean the lens.

■ Notice for watching 3D video images

- Some people may experience discomfort (such as eye strain, fatigue, or nausea) while watching 3D video images. We recommend that all viewers take regular breaks while watching 3D video images.
- If you experience any discomfort, stop watching the 3D video images until the discomfort subsides. Consult a doctor if you experience severe discomfort.
- Read the owner's manuals (Blu-ray Disc and TV) and/or the caution messages that appear on the TV carefully.
- The vision of young children (especially those under six years old) is still under development. Consult your doctor (such as a pediatrician or eye doctor) before allowing young children to watch 3D video images.
- Adults should supervise young children to ensure they follow the recommendations described above.

■ Cinavia technology

- Cinavia technology is a part of the content protection system included in your Blu-ray Disc Player.

Note

- The following messages may be displayed and playback stopped or audio outputs temporarily muted by your Blu-ray Disc player if you are playing an unauthorized copy of content that is protected by Cinavia technology.

These messages are displayed in English only.

Playback stopped. The content being played is protected by Cinavia® and is not authorized for playback on this device.

For more information, see <http://www.cinavia.com>. Message Code 1.

Audio outputs temporarily muted. Do not adjust the playback volume. The content being played is protected by Cinavia® and is not authorized for playback on this device.

For more information, see <http://www.cinavia.com>. Message Code 3.

Cinavia Notice

This product uses Cinavia technology to limit the use of unauthorized copies of some commercially-produced film and videos and their soundtracks. When a prohibited use of an unauthorized copy is detected, a message will be displayed and playback or copying will be interrupted. More information about Cinavia technology is provided at the Cinavia Online Consumer Information Center at <http://www.cinavia.com>. To request additional information about Cinavia by mail, send a postcard with your mailing address to: Cinavia Consumer Information Center, P.O. Box 86851, San Diego, CA, 92138, USA.

Controls and functions

■ Front panel

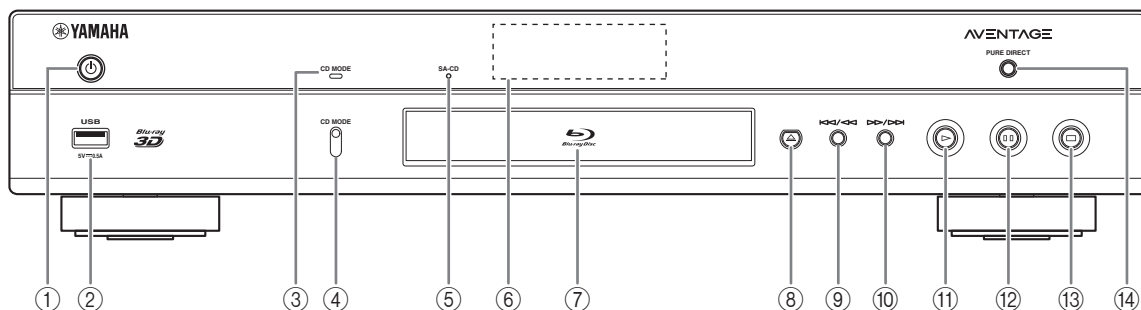

- ① **⏻ (On/Standby)**
Turns this Player on/Sets to standby mode.
Press and hold ⏻ on the front panel for more than 5 seconds to reset this Player (system reset).
- ② **USB connector (p. 19)**
- ③ **CD MODE indicator**
Lights up when the CD mode is enabled (p. 26).
- ④ **CD MODE**
Enables/disables the CD mode (p. 26).
- ⑤ **SA-CD indicator**
Lights up when an SA-CD is loaded and the SA-CD layer (p. 4) is selected.
- ⑥ **Front panel display**
Displays various information for operational status.
- ⑦ **Disc tray door**
- ⑧ **▲ (Eject)**
Opens/Closes the disc tray.
- ⑨ **⏮/⏮ (Search backward/Skip backward)**
Press to skip backward, and press and hold to search backward.
- ⑩ **⏭/⏭ (Search forward/Skip forward)**
Press to skip forward, and press and hold to search forward.
- ⑪ **▶ (Play)**
Starts a playback.
- ⑫ **■ ■ (Pause)**
Pauses a playback.
- ⑬ **■ (Stop)**
Stops a playback.
- ⑭ **PURE DIRECT**
Enables/disables the Pure Direct mode (p. 26).

Note

- Remove the protective film from the front panel before operating the Player.

■ Rear panel

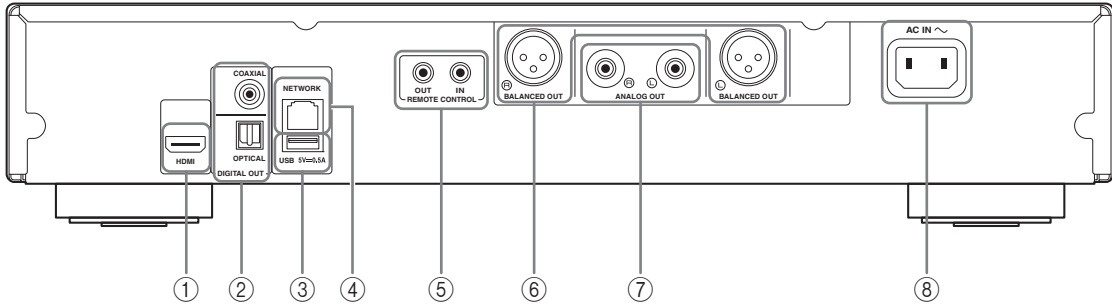





- ① **HDMI** (p. 12)
- ② **DIGITAL OUT (COAXIAL/OPTICAL)** (p. 14)
- ③ **USB** (p. 19)
- ④ **NETWORK** (p. 16)
- ⑤ **REMOTE CONTROL (IN/OUT)** (p. 18)
- ⑥ **BALANCED OUT (L/R)** (p. 15)
- ⑦ **ANALOG OUT (L/R)** (p. 14)
- ⑧ **AC IN** (p. 20)

Remote control

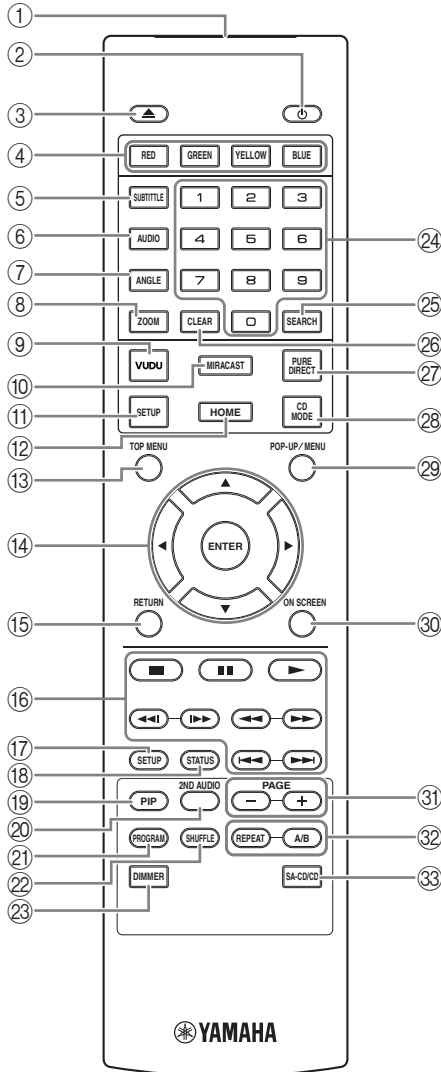
Note

-  will appear on the top left corner of the screen when the pressed button is not available.



- ① **Infrared signal transmitter:** Outputs infrared signal. Aim this window to the remote control sensor (p. 11).
- ② : Turns this Player on or sets it to standby mode.
- ③ : Opens/closes the disc tray.
- ④ **Color buttons** **BD**: Use these buttons according to on-screen instructions.
- ⑤ **SUBTITLE** **BD** **DVD** **VIDEO**: Changes subtitle languages (p. 52) if available. You can also select this item from On Screen menu (p. 30).
- ⑥ **AUDIO** **BD** **DVD** **VIDEO**: Changes the audio language or format. You can also select this item from On Screen menu (p. 30).
- ⑦ **ANGLE** **BD** **DVD**: Changes the camera angle if video is recorded with multiple angles. The Angle Mark () is displayed on the screen when this function is available. You can also select this item from On Screen menu (p. 30).

Note

- Angle Mark is displayed only when the Angle Mark is set to on (p. 38).
- ⑧ **ZOOM** **DVD** **VIDEO** **PHOTO**: Zooms in/out. The size of the screen will change each time you press the button (zoom in/out: 3 steps each).
 - ⑨ **VUDU**: Starts VUDU (p. 24).
 - ⑩ **MIRACAST**: Starts Miracast (p. 28).
 - ⑪ **SETUP**: Displays SETUP menu screen (p. 34).
 - ⑫ **HOME**: Displays the HOME menu screen (p. 22).
 - ⑬ **TOP MENU** **BD** **DVD**: Displays the top menu screen if the disc contains a menu. Select the desired item using ▲/▼/◀/▶ and **ENTER**.

Note

- Specific operations may be different depending on the disc. Follow the instructions of each menu screen.
- ⑭ **Cursor buttons** (▲/▼/◀/▶): Moves the focus in the menu screen.
ENTER: Selects the focused menu/item.
 - ⑮ **RETURN**: Returns to the previous menu or screen, etc.

⑩ Control buttons

BD DVD CD VIDEO MUSIC PHOTO

■: Stops playback.

■: Pauses playback.

▶: Plays back contents.

◀◀/▶▶: Skips backward/forward.

◀◀/▶▶

BD DVD CD VIDEO MUSIC :

Searches backward/forward. The search speed will change each time you press the button (search backward/forward: 5 steps each). Press ▶ to resume normal playback.

PHOTO : Changes the speed of a slide show (slower/faster: 3 steps).

◀◀/▶▶

BD DVD CD VIDEO MUSIC :

Press for instant search/replay. Instant search skips the content 30 seconds. Instant replay replays the content from 10 seconds before.

⑪ **SETUP:** Displays SETUP menu screen (p. 34).

⑫ **STATUS:** Displays the playback information (p. 31).

⑬ **PIP BD :** Turns on/off the Picture in Picture (p. 33).

PIP Mark () is displayed on the screen when this function is available. You can also select this item from On Screen menu (p. 30).

Note

– PIP Mark is displayed only when the PIP Mark is set to on (p. 38).

⑭ **2ND AUDIO BD :** Selects the secondary audio of the Picture in Picture (p. 33) or audio commentaries. The Secondary Audio Mark () is displayed on the screen when this function is available (p. 42). You can also select this item from On Screen menu (p. 30).

Note

– Secondary Audio Mark is displayed only when Secondary Audio Mark is set to on (p. 38).

⑮ **PROGRAM DVD CD :** Sets the order of playback (p. 32). You can set up to 15 tracks (for an audio disc) or titles/chapters (DVD-Video).

⑯ **SHUFFLE DVD CD VIDEO MUSIC PHOTO :** Selects shuffle play mode (p. 30).

⑰ **DIMMER:** Changes the brightness of the front panel display in four steps.

⑱ **Number buttons:** Enter numbers, or during playback, jump to the track/chapter corresponding to the number you input. These buttons may not be available depending on the disc type and playback condition.

⑲ **SEARCH BD DVD CD VIDEO MUSIC :** Jumps to a specified point during playback. For details on this function, refer to “Using Search” (p. 32). You can also select this item from status menu (p. 31).

⑳ **CLEAR:** Clears entered number/set item.

㉑ **PURE DIRECT:** Enables/disables the Pure Direct mode (p. 26).

㉒ **CD MODE:** Enables/disables the CD mode (p. 26).

㉓ **POP-UP/MENU BD DVD :** Displays pop-up menu. The menu contents displayed vary depending on the disc. For details on how to see and operate the pop-up menu, refer to the manual for the disc. The top menu screen may be displayed by pressing **POP-UP/MENU** depending on the DVD.

㉔ **ON SCREEN:** Displays On Screen menu (p. 30).

㉕ **PAGE (+/-) :** Moves to a previous/next page when you select an item on the content list menu.

Continued to the next page. ➔

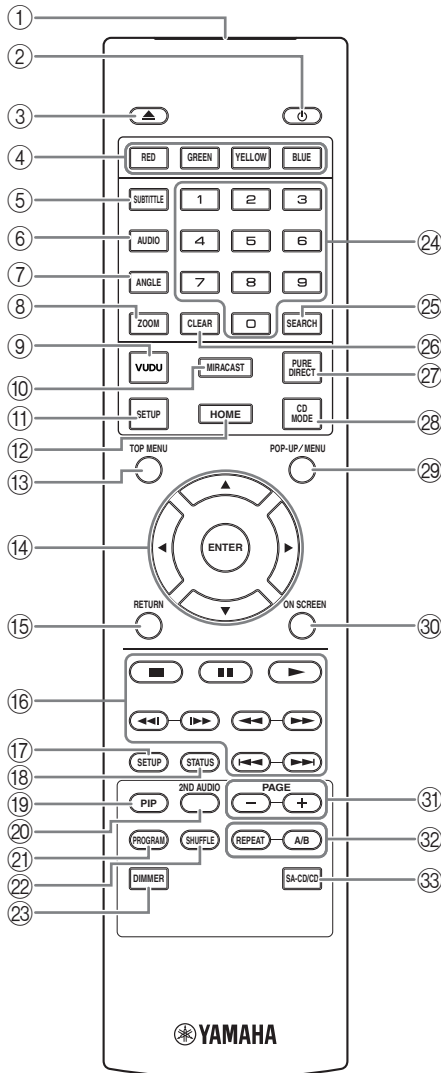

③② REPEAT **BD DVD CD VIDEO MUSIC**

PHOTO : Changes repeat mode. Repeat mode shown below will change each time you press the button.

: Repeats the title being played back.

: Repeats the chapter being played back.

: Repeats the folder being played back.

: Repeats all tracks/files on the disc.

: Repeats the track/file being played back.

A/B **BD DVD CD VIDEO MUSIC** : Plays back a specific part you want to repeat.

- 1 Press **A/B** at the scene where you want to set the start point. "A-" is displayed on the screen.
- 2 Press **A/B** again at the scene where you want to set the end point. "A-B" is displayed on the screen. Repeat playback starts.
- 3 To cancel the repeat playback, press **A/B**. "A-B" disappears and the repeat playback is finished.

Note

- This function cannot be performed depending on the specifications of the disc.

- ③③ **SA-CD/CD**: Selects the layer to be played when an SA-CD/CD hybrid disc (p. 4) is played back.

Hint

- The SA-CD indicator (p. 6) on the front panel lights up when an SA-CD is loaded and the SA-CD layer is selected.

Notes

- This operation is available only when no disc is loaded.
- Audio signals are not output from the COAXIAL or OPTICAL jack when the SA-CD layer is selected.

Loading the batteries in the remote control

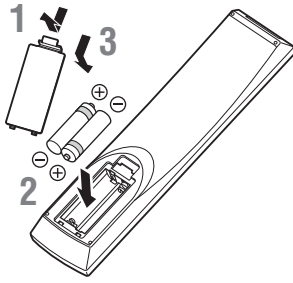

Notes

- Change both batteries when the operation range of the remote control decreases.
- Use AAA, R03, UM-4 batteries.
- Make sure that the polarities are correct. Refer to the illustration inside the battery compartment.
- Remove the batteries if the remote control is not to be used for an extended period of time.
- Do not use old batteries together with new ones.
- Do not use different types of batteries (such as alkaline and manganese batteries) together. Read the packaging carefully as these different types of batteries may have the same shape and color.
- If the batteries have leaked, dispose of them immediately. Avoid touching the leaked material or letting it come into contact with clothing, etc. Clean the battery compartment thoroughly before installing new batteries.
- Do not throw away batteries with general house waste; dispose of them correctly in accordance with your local regulations.
- Keep batteries away from children. If a battery is accidentally swallowed, contact your doctor immediately.
- When not planning to use the remote control for long periods of time, remove the batteries from the remote control.
- Do not charge or disassemble the supplied batteries.

Approximate operating range of remote control

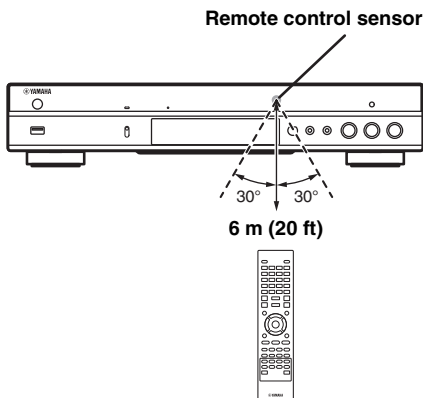

ID function

When using multiple Yamaha products, the remote control may work on another Yamaha product or another remote control may work on this Player. In this case, change the remote control ID to prevent unwanted operation. If you have changed the remote control ID, make sure that you select the same ID for the main unit. The default setting is ID1.

1 Remote control setting

To change the ID from ID1 to ID2, press and hold the red color button **2** of number button simultaneously for 7 seconds. To change the ID from ID2 to ID1, press and hold the red color button **1** of number button simultaneously for 7 seconds.

2 Main unit setting

Press and hold **◀◀◀/◀◀** and **▶▶/▶▶▶** on the front panel simultaneously for 2 seconds to display current ID when:

- No disc is inserted in this Player.
- The disc tray is closed.
- Playback is stopped.
- "NO DISC" is displayed on the front panel display.

Keep pressing and holding the keys for another 2 seconds to change the ID between ID1 and ID2.

Note

- If the remote control is without batteries for a few minutes or if exhausted batteries remain in the remote control, the remote control ID is automatically set to ID1. If you want to use the remote control in ID2 setting, install new batteries and set the remote control ID again.

Video/audio connections

Make the corresponding video/audio cable connections depending on the equipment you want to use.

Hints

- See page p. 44 for information on the video/audio output formats.
- Prepare commercially available cables required for connections. The type and number of cables you need vary depending on the equipment to be connected.

Enjoying video/audio using a TV and an AV receiver

Refer to “Connecting to a TV via an AV receiver” (p. 13).

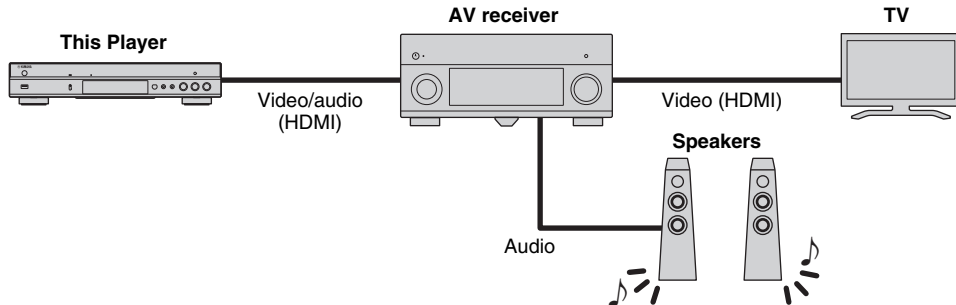

Enjoying video/audio using only a TV

Refer to “Connecting to a TV directly” (p. 13).

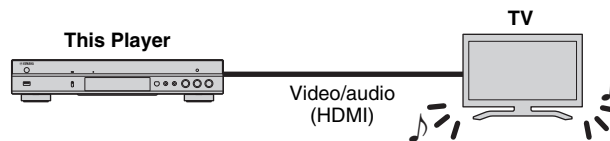

Enjoying video/audio using a TV and audio equipment

Refer to “Connecting to a TV and audio equipment” (p. 14).

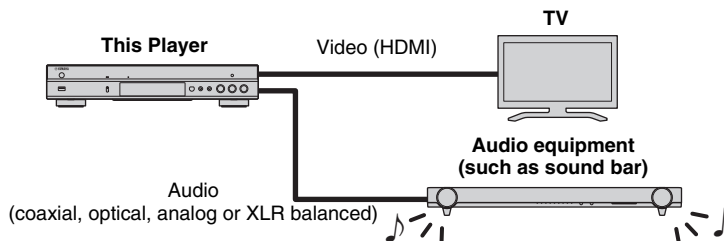

About HDMI

To enjoy high quality video and digital sound through the HDMI terminal, use commercially available HIGH SPEED HDMI cables that have the HDMI logo (as shown on the back cover).

Hints

- For information on the HDMI Control function, refer to “HDMI Control” (p. 37).
- To change the output mode of HDMI terminal, configure “HDMI” (p. 42) in Audio Setting.

Connection for the playback of Blu-ray 3D Discs

To enjoy Blu-ray 3D Discs on this Player, your system must meet the following conditions.

- Your TV and AV receiver (if available) must support the 3D feature.
- 3D Output in Display Setting (p. 40) is set to “Auto”.

■ Connecting to a TV via an AV receiver

Connect this Player to the AV receiver and the AV receiver to the TV with HDMI cables. For details on speaker connections, refer to the owner's manuals of the AV receiver and speakers.

Caution!

Do not connect the power cable of this Player until all connections are completed.

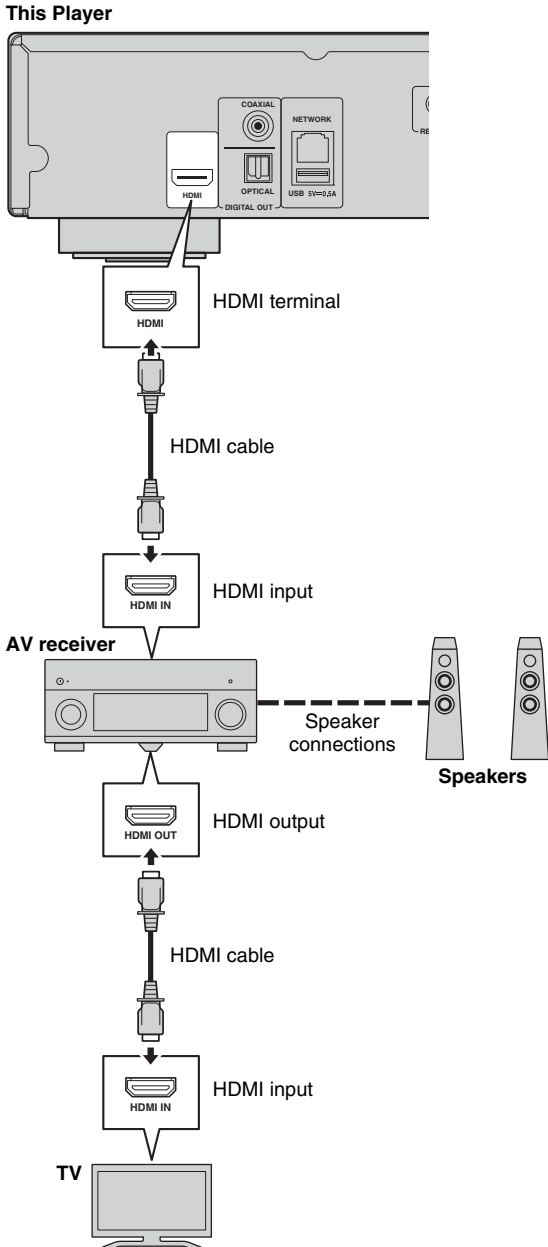

■ Connecting to a TV directly

Connect this Player to the TV with an HDMI cable.

Caution!

Do not connect the power cable of this Player until all connections are completed.

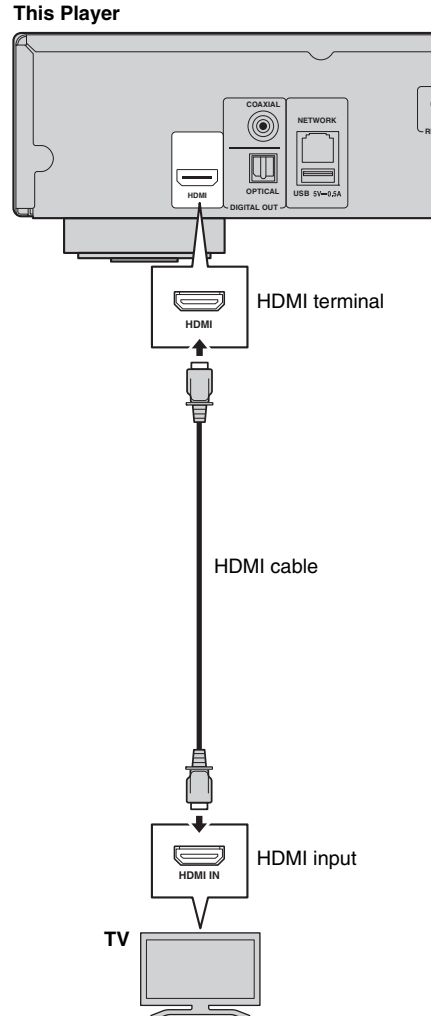

■ Connecting to a TV and audio equipment

Connect this Player to the TV with an HDMI cable, and this Player to the audio equipment with an audio cable (digital optical, digital coaxial or stereo pin cable).

Caution!

Do not connect the power cable of this Player until all connections are completed.

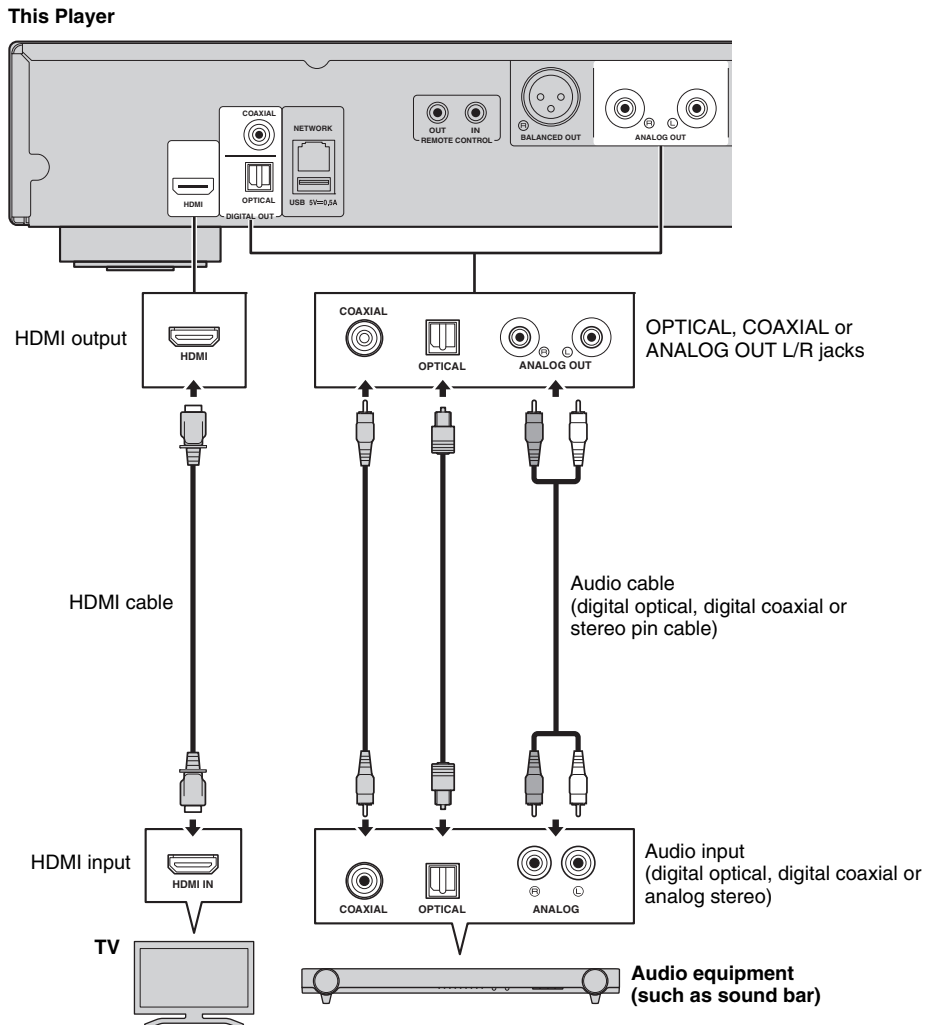

Hints

- To change the output mode of COAXIAL/OPTICAL jacks, configure “Coaxial / Optical” (p. 42) in Audio Setting.
- If the playback audio is output from both the TV speakers and audio equipment, set HDMI in Audio Setting to Off to disable the audio output to the TV.
- Audio signals of SACDs cannot be output from the COAXIAL or OPTICAL jack (p. 45).

XLR balanced connection

If your audio equipment is equipped with the XLR balanced input jacks, you can connect this player to the audio equipment (such as an AV receiver) with an XLR balanced cable.

For details on speaker connections, refer to the owner's manual of the audio equipment and speakers.

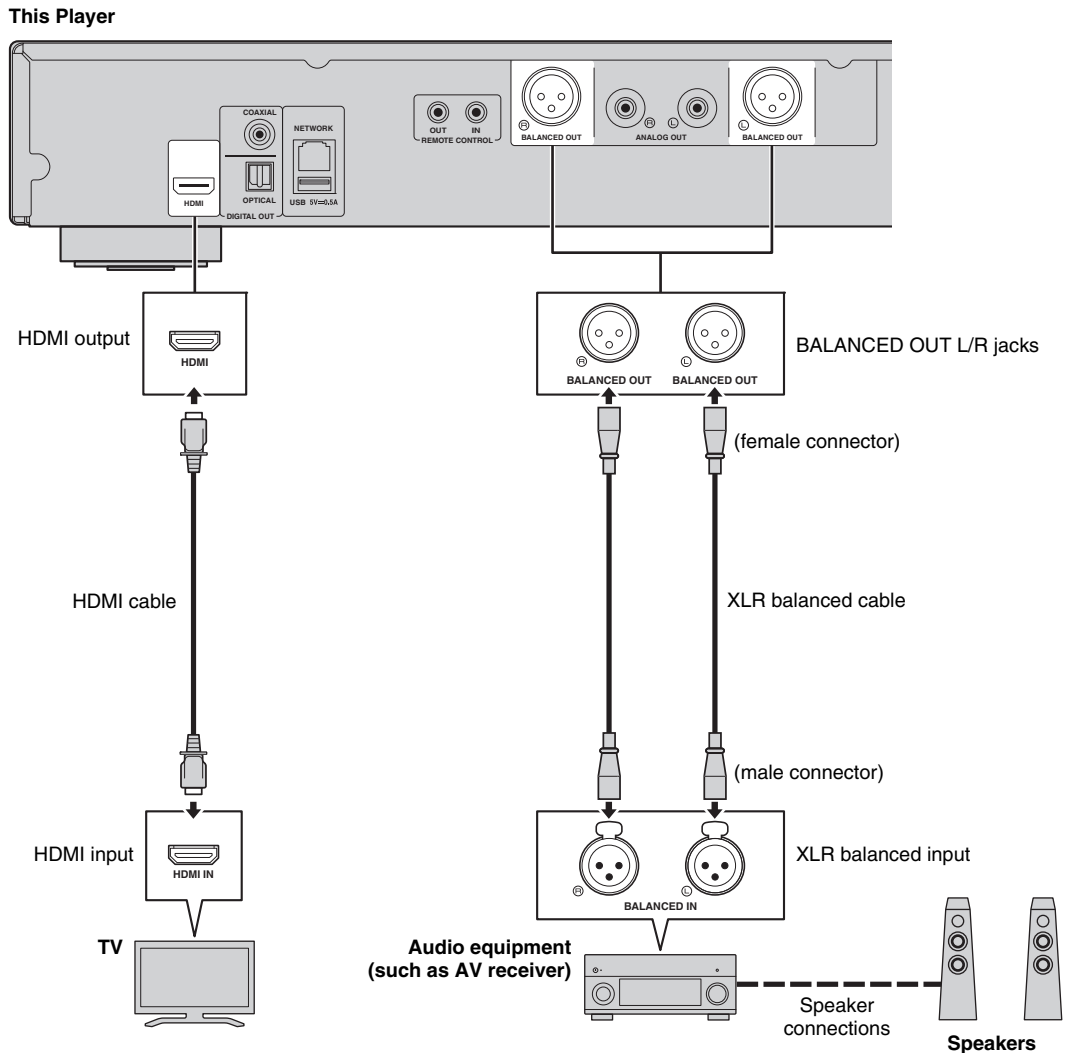

Note

- The pin assignments for the BALANCED OUT (L/R) jacks of this Player are shown below. Before connecting an XLR balanced cable, refer to the instruction manual of your device and verify that its XLR balanced input jacks are compatible with the pin assignments.

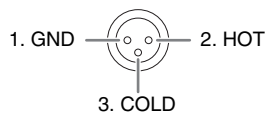

Network connection

By connecting this Player to the network (wireless or wired), you can use the following features.

- Playing back DLNA server (PC or NAS) contents (p. 22)
- Playing BD-Live compatible discs (p. 32)
- Operating this Player from mobile devices (AV CONTROLLER) (p. 29)

Notes

- To use the network services or BD-Live feature, a broadband internet connection is required.
- Refer to the operation manual of the equipment you have as the connected equipment and connection method may differ depending on your network environment.
- Use a network cable/router supporting 10BASE-T/100BASE-TX.

Hint

- If you are using a router that supports DHCP, you do not need to configure any network settings for this Player, as the network parameters (such as the IP address) will be assigned automatically to it. You only need to configure the network settings if your router does not support DHCP or if you want to configure the network parameters manually (p. 39).

■ Wireless connection

By using the Wi-Fi feature of this Player, you can connect this Player to your network (router) wirelessly. To use the Wi-Fi feature, refer to “Wireless connection setting” (p. 21) and configure the wireless connection setting.

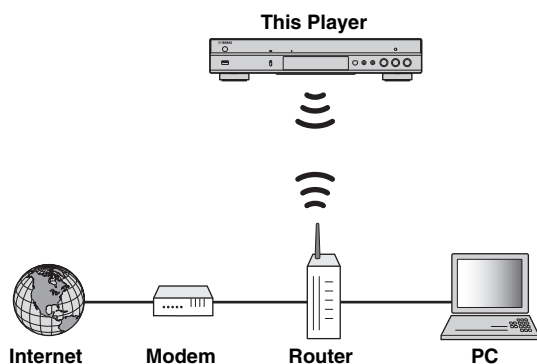

■ Wired connection

Connect this Player to your network (router) with a commercially available Shielded Twisted Pair (STP) network cable.

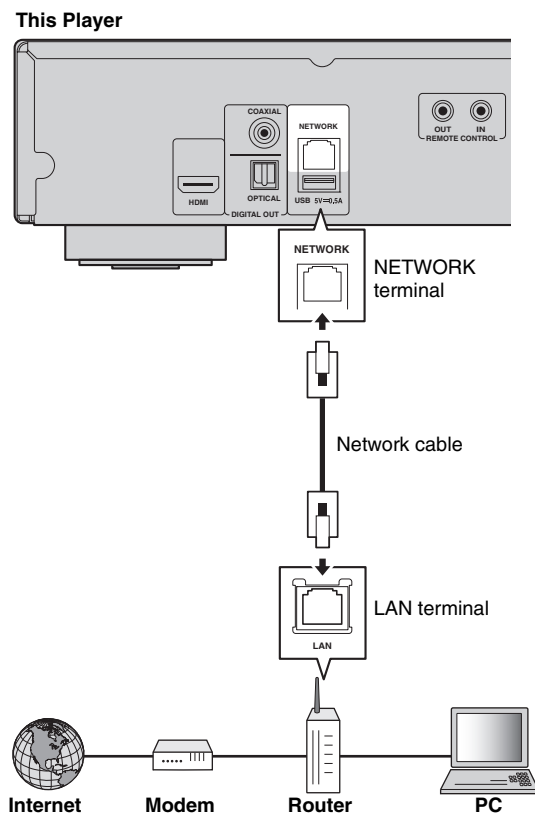

DLNA server setup

By using DLNA, you can share multimedia contents (such as videos, music and photos) stored on your DLNA server (PC or NAS) connected to your network, and enjoy those contents with this Player.

In addition, you can use your mobile device (such as a smartphone and a tablet) as a wireless controller to operate this Player through the network.

To use the DLNA features, perform the following DLNA server setup after making the network connection (p. 16).

Notes

- To use DLNA features, all the devices must be connected to the same network.
- To use a NAS as a DLNA server, the NAS must be compatible with DLNA.

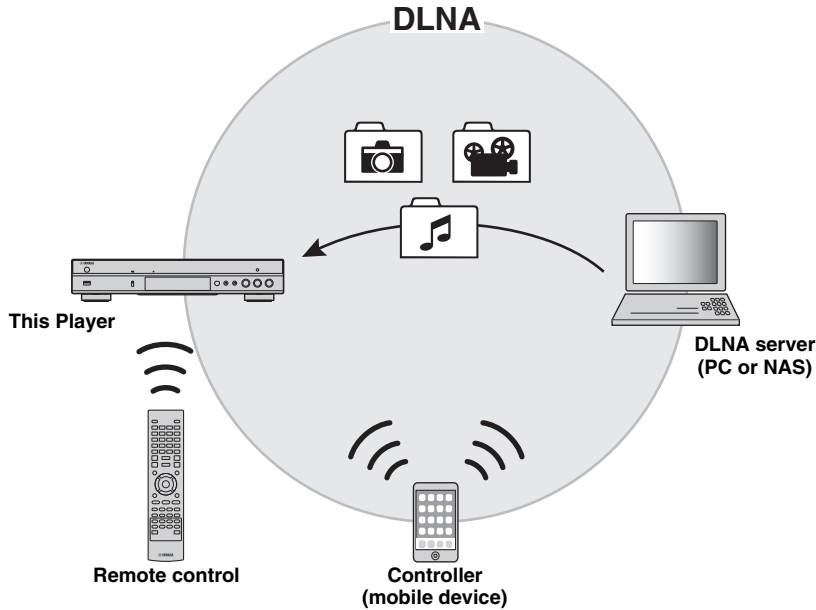

Media sharing setting on DLNA server

To play back multimedia contents stored on your DLNA server (PC or NAS), first you need to configure the media sharing setting on the DLNA server software installed on the DLNA server.

Hint

- For information about DLNA server setting or file formats supported by DLNA server, refer to the owner's manuals of your DLNA server and its software.

- 1 Turn on your DLNA server (PC or NAS) and this Player.
- 2 If you are using a PC as a DLNA server, check that DLNA server software (such as Windows Media Player 12) is installed on your PC.
- 3 On your DLNA server, enable media sharing and allow media to be shared with this Player. Now the DLNA server setting is complete. To enjoy the DLNA server contents on this Player, select a DLNA server and multimedia file from the HOME menu (p. 22).

Using a mobile device as a media controller

If you have a mobile device (such as smartphone and tablet) that supports the Digital Media Controller (DMC) feature, you can operate this Player from your smart phone or tablet through the network.

Hints

- To allow the mobile device to control this Player, set DMC Control (p. 39) in the SETUP menu to Enable (default).
- To use this function, a DMC application must be installed on your mobile device.

Using the Wi-Fi Direct function for DLNA

You can enjoy DLNA playback of mobile device contents via the Wi-Fi Direct function (p. 27).

Hint

- To use DLNA playback on the mobile device, a DLNA DMC/Server application must be installed on your mobile device.

Other connections

■ Connecting Yamaha components that support remote connections

If you are using Yamaha components that support remote connections, you can transmit remote control signals by connecting the REMOTE CONTROL (IN/OUT) jacks with monaural 3.5 mm mini-plug cables.

Caution!

Do not connect the power cable of this Player until all connections are completed.

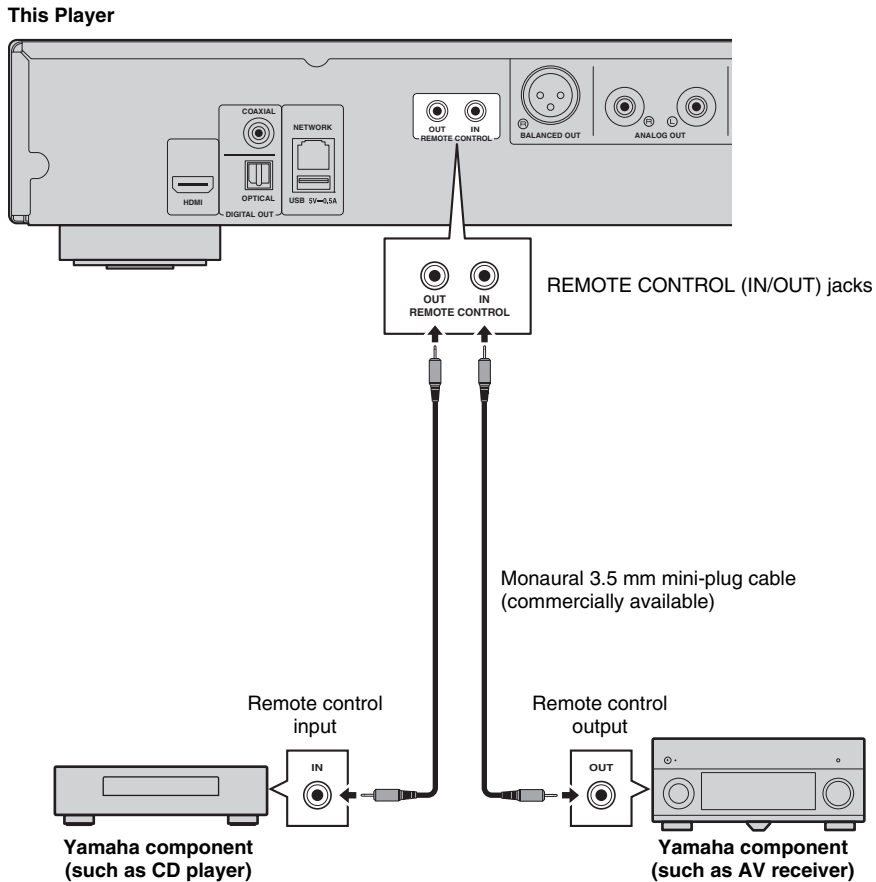

Hint

- If you use a Yamaha AV receiver that supports SCENE link (via remote control connection) playback, you can control playback of this Player in conjunction with AV receiver operations. For details, refer to the owner's manual of the AV receiver.

USB connection

By connecting a USB memory device to the USB connector on the front or the rear panel of this Player, you can play multi-media files stored on the USB memory device (p. 22).

Notes

- Yamaha cannot guarantee that all brands' USB memory devices will operate with this Player.
- Connect a USB memory device to one of the USB connectors (front/rear) of this Player when using BD-Live feature (p. 33).

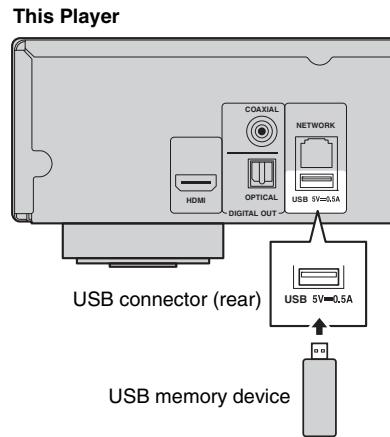
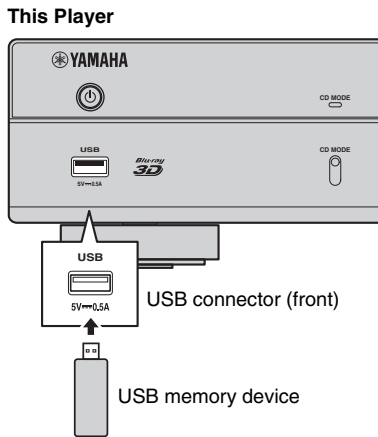

Connecting the power cable

After all connections are completed, plug the supplied power cable into the AC IN on the rear of the Player. Then plug into AC outlet.

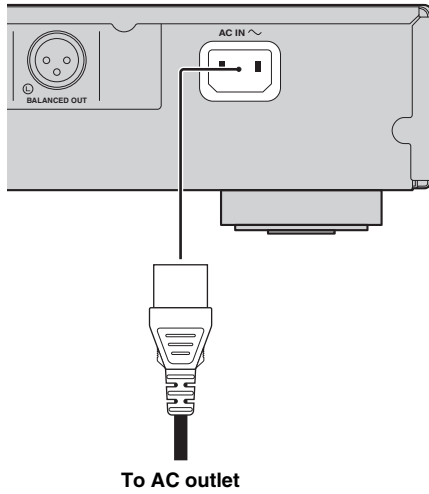

Initial settings

■ Setting with the Easy Setup

Easy Setup allows you to set language, resolution, and screen aspect ratio easily. Easy Setup screen is displayed when you turn this Player on for the first time after purchase. Same setting can be performed from SETUP menu → System → Easy Setup.

- 1 When Easy Setup screen is displayed, press **ENTER** to start Easy Setup.

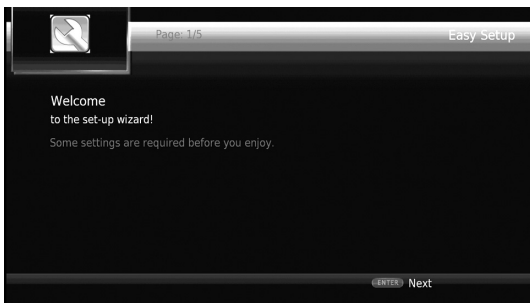

- 2 Set the language, resolution, and screen aspect ratio by following the on-screen messages.

Notes

- When no picture is displayed after Easy Setup is completed, refer to “Troubleshooting” (p. 48).
- A warning message concerning 3D video playback appears when this Player is turned on. Press **ENTER** to dismiss the message or **CLEAR** to disable it (p. 37).

■ Wireless connection setting

To connect this Player to your network (router) wirelessly, follow the procedure below to configure the wireless connection setting.

If your router (access point) supports the WPS (Wi-Fi Protected Setup) function, you can use the auto setup method to connect this Player to the router without entering network information (such as SSID) manually.

- 1 Press **SETUP** to display the SETUP menu screen.
- 2 Select General Setting → Network → Connection setting → Wireless.

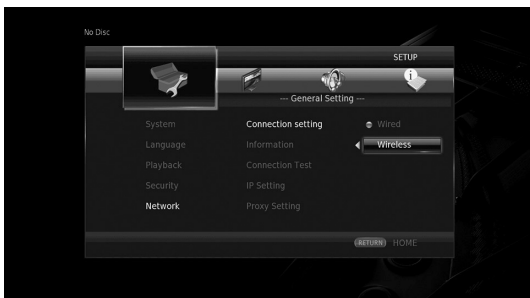

- 3 Press **◀▶** to select Yes, then press **ENTER**.



- 4 Press **◀▶** to select one of the following setup methods, then press **ENTER**.



Scan: Select this option to search for available wireless networks. When the network list is displayed, select the SSID to be connected and enter the password.

Manual: Select this option to enter the network information (such as SSID) manually.

Auto: Select this option to use the WPS function. Select PBC (Push Button Configuration) or PIN code method, then follow the on-screen messages.

Notes

- For details on operations of your router (access point), refer to the owner’s manual of it.
- When the WPS function does not work, select “Scan” or “Manual” to configure the wireless connection settings.
- Devices that use a 2.4 GHz frequency band, such as a microwave, or other wireless devices, may interrupt the wireless communication. Move this Player away from such devices, or turn off such devices.
- The speed of a wireless network connection depends on your network environment (router type, distance between the router and this Player, installation places, etc.). In case the sound or video is interrupted during playback, move this Player closer to the router or change the orientation of this Player or the antenna of the router.

Playing back video/music/photo

■ Playing back commercially available discs







You can enjoy commercially available Blu-ray discs, DVDs, and CDs.

- 1 Open the disc tray and load the disc.
Playback starts automatically.





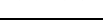

Hints

- If playback does not start automatically, press ► (playback).
- The top menu screen may be displayed when a Blu-ray disc or a DVD is loaded.
- Some functions may not work or work differently from the manual descriptions depending on the disc.
- For information on the supported discs, refer to “About discs and files” (p. 3).

Remote control buttons used for Blu-ray disc/DVD playback

Remote control buttons		Function
Control buttons		Stops playback.
		Pauses playback.
		Starts playback.
		Skips 10 seconds backward or 30 seconds forward.
		Searches backward or forward. The search speed changes each time the button is pressed.
		Skips to the beginning of the chapter (previous chapter if the button is pressed repeatedly) or next chapter.
Number buttons		Skips to the specified chapter during playback.
STATUS		Displays the playback information (p. 31).
Menu operation buttons	Cursor buttons	Selects an item (such as chapters).
	Cursor buttons	Confirms the selected item.
	RETURN	Returns to the previous menu or screen.
TOP MENU		Displays the top menu screen of the disc.
POP-UP/MENU		Displays the pop-up menu screen of the Blu-ray disc or disc menu screen of the DVD.

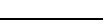
Remote control buttons used for CD playback

Remote control buttons		Function
Control buttons		Stops playback.
		Pauses playback.
		Starts playback.
		Skips 10 seconds backward or 30 seconds forward.
		Searches backward or forward. The search speed changes each time the button is pressed.
		Skips to the beginning of the track (previous track if the button is pressed repeatedly) or next track.
Number buttons		Skips to the specified track during playback.
STATUS		Displays the playback information (p. 31).

■ Playing back video/music files

You can enjoy video/music files stored on own discs (such as DVD-R/RWs), USB memory devices or DLNA servers (PC/NAS).

Hint

- For information on the supported files, refer to “About discs and files” (p. 3).

- 1 Perform the following operation according to your purpose.

To play back files on the disc:

Open the disc tray and load the disc.

To play back files on the USB memory device:

Connect the USB memory device to the USB connector.

To play back files on the DLNA server:

Check that the DLNA server is turned on and connected to the network.

- Press **HOME**.
The HOME menu screen is displayed.



Hint

- You cannot display the HOME menu screen during playback of a commercially available disc, DVD, or video files. To display the HOME menu screen, first stop playback.

- Use the cursor buttons (▲/▼) to select the desired item (disc, USB or DLNA) and press **ENTER**.

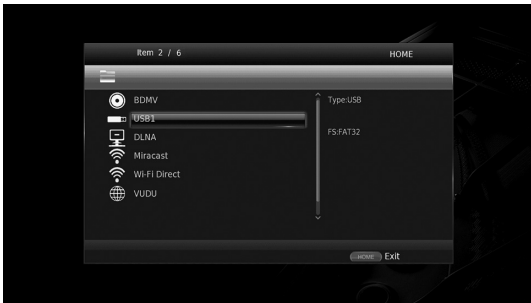

- Use the cursor buttons (▲/▼) to select “Music”, “Video” or “AVCHD”, and press **ENTER**.
If you selected “DLNA” in Step 3, select the desired DLNA server in Step 4.









Hints

- To return to previous screen, press **RETURN** or cursor key (◀), or select  in the menu screen.
- “AVCHD” is a file format for recording high-resolution videos on the recording discs (such as DVD-Rs).

- Use the cursor buttons (▲/▼) to select the desired file and press **ENTER**.
Playback of the file starts.

Remote control buttons used for file playback

Remote control buttons	Function
	Stops playback.
	Pauses playback.
	Starts playback.
	Skips 10 seconds backward or 30 seconds forward.
	Searches backward or forward. The search speed changes each time the button is pressed.
	Skips to the beginning of the file (previous file if the button is pressed repeatedly) or next file.
STATUS	Displays the playback information (p. 31).

3

Playback

■ Viewing photos

You can enjoy photos stored on own discs (such as DVD-R/RWs), USB memory devices or DLNA servers (PC/NAS).

Hint

- For information on the supported files, refer to “About discs and files” (p. 3).

- Refer to “Playing back video/music files” and follow Steps 1 to 3.

Hint

- If you load a commercially available photo DVD, slide show playback may start automatically. In this case, you do not need to perform the following steps.

- Use the cursor buttons (▲/▼) to select “Photo” and press **ENTER**.

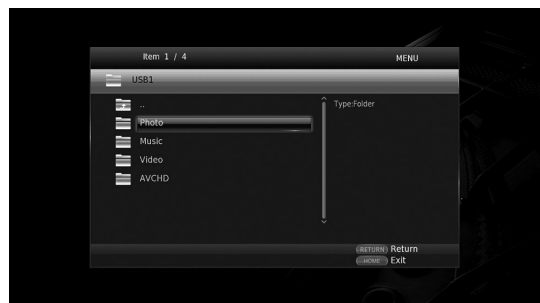

Hint







- To return to previous screen, press **RETURN** or cursor key (◀), or select  in the menu screen.

- Use the cursor buttons (▲/▼) to select the desired photo and press **ENTER**.
Slide show playback starts from the selected photo.

Hints

- If you select photos during playback of a CD or a music file, you can enjoy slide show while listening to music.
- You can use the slide show as the screen saver. When using the slide show as the screen saver, create the “autopic” folder under the root directory of the USB memory device and put photo files into the folder. When the USB memory device is connected to this Player, the screen saver will activate according to the Screen Saver settings (p. 41).

Remote control buttons used for photo playback

Remote control buttons	Function	
Control buttons		Stops playback.
		Pauses playback.
		Starts playback.
		Changes the speed of slide show playback.
		Skips to the previous photo or next photo.
Cursor buttons		Inverts the photo up-down or left-right.
		Rotates the photo 90 degrees to the left or right.
ZOOM	Zoom in/out the photo. When the photo size is larger than the screen, use the cursor buttons to move the viewing area.	
STATUS	Displays the playback information (p. 31).	

■ Viewing VUDU contents

You can enjoy VUDU contents on this Player.

Notes

- To use this function, this Player must be connected to the Internet. Access to some contents may require a high speed internet connection.
- The third party content services may be changed, suspended, interrupted, or discontinued at any time without notice and Yamaha disclaims any liability in connection with such occurrences.
- Some content may only be available for specific countries and may be presented in specific languages.

- Press **HOME**.
The HOME menu screen is displayed.



Hint

- To directly move to the VUDU menu screen, press **VUDU**.

- Use the cursor buttons (▲/▼) to select “VUDU”, and press **ENTER**.



- Use the cursor buttons to select the desired item and press **ENTER** to confirm the selection (or start playback).

Hints

- To return to previous screen, press **RETURN** or cursor key (◀), or select  in the menu screen.
- To exit from each network service, press **HOME**.

About VUDU™

VUDU is an online streaming movie service that allows you to rent or purchase individual movies or TV shows in either standard definition or high definition without a subscription,
More information at www.vudu.com

Note

- To deactivate the VUDU service, refer to “VUDU” (p. 38).

- MOVIES & TV -
VUDU

Enjoying high-quality sound

The CD mode and Pure Direct mode allow you to enjoy better quality sounds.

The CD mode allows you to play back music CDs or SA-CDs with accurate and high quality sound.

The Pure Direct mode allows you to enjoy pure high fidelity sound on any sources.

■ Enjoying music CD/SA-CD in high-quality sound (CD mode)

CD

If the CD mode is enabled when you play back a music CD or an SA-CD, this player operates in the following conditions and allows you to enjoy more enhanced quality sounds.

- Disables the electrical distribution to the circuitries for unused functions to reduce electrical noises from those circuitries.
- Limits HDMI video signal outputs to reduce electrical noises from the HDMI circuitry.
- Slows the disc rotation speed to reduce the negative effect of the electric current driving the motor to improve the sound quality (when playing back a music CD).

1 Press **CD MODE**.

Each time you press the button, the CD mode is enabled or disabled.

Notes

- During the CD mode, the auto-playback function does not work.
- The CD mode works on music CDs (CDDA) and SA-CDs only. If this Player is set to the CD mode during playback of other disc (such as a Blu-ray disc), playback stops and the disc will be automatically ejected.
- You cannot switch this player to the CD mode during playback of other media (USB, DLNA or network service). To switch to the CD mode, first stop the ongoing playback.

Hints

- You can also enable/disable the CD mode with the CD MODE switch on the front panel. When the CD mode is enabled, the CD MODE indicator on the front panel lights up.
- When connecting the AV receiver to the HDMI jack of this Player, set HDMI (CD Mode) (p. 42) in the SETUP menu to Audio Only (default). This setting disables HDMI video output during the CD mode in order to reduce the electrical noise from the circuitry.
- When connecting the AV receiver to the DIGITAL OUT, ANALOG OUT or BALANCED OUT jacks of this Player, set HDMI (CD Mode) (p. 42) in the SETUP menu to Off. This setting disables the HDMI circuitry (HDMI video/audio output) during the CD mode and allows you to enjoy a better quality sound.

■ Enjoying music and movies with pure high fidelity sounds (Pure Direct)

When the Pure Direct mode is enabled, this Player plays back the selected source with the least circuitry in order to reduce the electrical noise from other circuitry (such as the front display). It allows you to enjoy Hi-Fi sound quality.

1 Press **PURE DIRECT**.

Each time you press the button, the Pure Direct mode switches as follows.

Front panel display	Function
PDIRECT1	Enables the Pure Direct mode (mode 1). In this mode, the front panel display is turned off and HDMI video output is disabled. This mode is suitable for listening music with high quality sound.
PDIRECT2	Enables the Pure Direct mode (mode 2). In this mode, the front panel display is turned off. This mode is suitable for watching movies with high quality sound.
(no display)	Disables the Pure Direct mode.

Hints

- When the CD mode is enabled, the Pure Direct mode switches between on and off.
- You can also switch the Pure Direct mode with the PURE DIRECT button on the front panel. When the Pure Direct mode is enabled, the PURE DIRECT button on the front panel lights up.

Enjoying DLNA playback of mobile device contents via Wi-Fi Direct

By using the Wi-Fi Direct function, you can connect a mobile device directly to this Player without using a wireless router and enjoy DLNA playback of the mobile device contents on this Player.

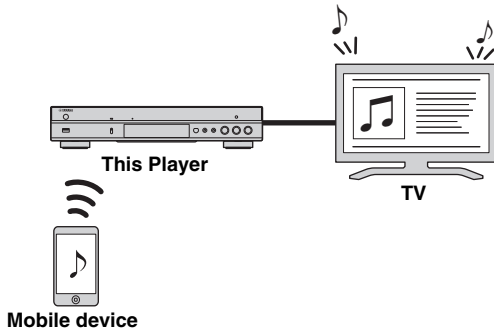

Notes

- To check if your device is Wi-Fi Direct compliant, refer to the owner's manual of the device. If your device is not Wi-Fi Direct compliant, follow the procedure below to make a manual connection.
 - When Wi-Fi Direct is enabled, playback of other network functions, discs and USB memory devices are not available.
- 1 If playback of other source is ongoing, stop the playback.
 - 2 Press **HOME**.
The HOME menu screen is displayed.
 - 3 Use the cursor buttons (▲/▼) to select "Wi-Fi Direct" and press **ENTER**.

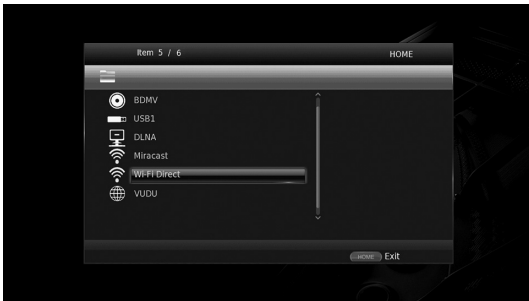

- 4 Perform the following operation to make a Wi-Fi Direct connection.

If your device is Wi-Fi Direct compliant:

- ① Within 2 minutes, operate your device to make a connection.

If your device is not Wi-Fi Direct compliant:

- ① Press **RED** to enter the manual connection mode.
The SSID information appears on the screen.
- ② On your device, open the Wi-Fi setup screen and enter the SSID information.

- 5 Press **ENTER** (or wait for 3 seconds) and use the DLNA-compatible player application to start playback on your mobile device.

Hint

- Select this Player as the renderer on the DLNA-compatible player application.

- 6 To exit from Wi-Fi Direct, press **HOME**.

Hint

- You can also exit from Wi-Fi Direct by pressing **SETUP** or **RETURN**.

Depending on the environment, audio/video may be interrupted or noise may appear on the TV screen. In this case, try the following solutions.

- Move the Wi-Fi Direct device closer to this Player.
- Turn off other wireless devices not in use.
- Move the Wi-Fi Direct device and this Player away from microwave ovens, or other wireless devices.

Enjoying smartphone pictures and videos on the TV screen (Miracast™)

By using the Miracast function, you can view the images displayed in the screen of your Miracast-compatible device (such as smartphone) on the TV screen like mirroring.

Notes

- To check if your device is Miracast compliant, refer to the owner's manual of the device.
- When Miracast is enabled on this Player, other network functions (such as DLNA) are not available.
- When using Miracast, you cannot operate the disc tray or playback of other sources.

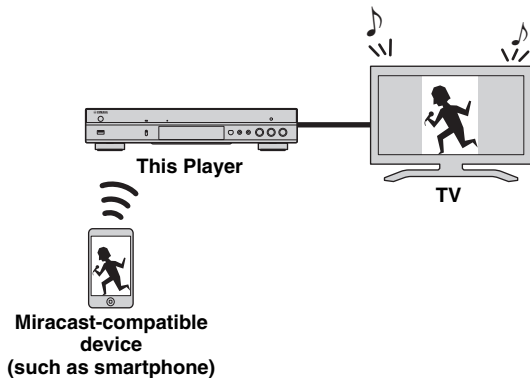

- 1 If playback of other source is ongoing, stop the playback.
- 2 Press **MIRACAST**.
- 3 Within 60 seconds, operate your smartphone to enable Miracast and select this Player as the device to be connected.
For details on operations of your smartphone, refer to the owner's manual of it.
- 4 To exit from Miracast, press **MIRACAST**.

Hint

- You can also exit from Miracast by pressing **HOME** or **RETURN**.

Depending on the environment, audio/video may be interrupted or noise may appear on the TV screen. In this case, try the following solutions.

- Move the Miracast device closer to this Player.
- Turn off other wireless devices not in use.
- Move the Miracast device and this Player away from microwave ovens, or other wireless devices.

Operating this Player from mobile devices

By using the following applications on your mobile device, you can use the mobile device as a remote control and operate this Player from it.



AV CONTROLLER

- You can control the basic functions of this Player such as Play, Pause, Skip, Power and cursor navigations.
- The application “AV CONTROLLER” is available in many languages.
- For more information about “AV CONTROLLER”, visit the Yamaha website.

Advanced playback operation

This chapter explains playback of commercially available Blu-ray Discs, DVDs, SA-CDs, CDs, and recorded DVD-RW/R discs.

Note

- For the basic playback operation, see page 8.

■ On Screen menu

To display On Screen menu, press **ON SCREEN**. After that, press **▲/▼/◀/▶** to select an item, then press **ENTER** to operate the desired function.

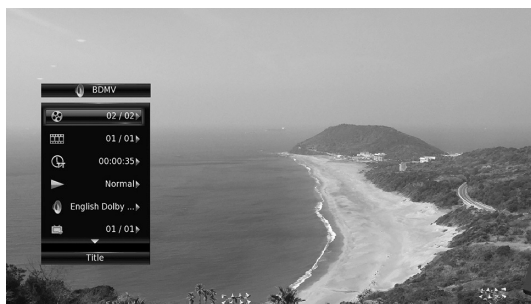

On Screen menu contains following items.

Title **BD** **DVD** **VIDEO** : Shows the title number being played back. You can skip to the desired title by selecting it from this item.

Chapter **BD** **DVD** **VIDEO** : Shows the chapter number being played back. You can skip to the desired chapter by selecting it from this item.

Track/File **CD** **VIDEO** **MUSIC** **PHOTO** : Shows track/file number being played back. You can skip to the desired track/file by selecting it from this item.

Time **BD** **DVD** **CD** **VIDEO** **MUSIC** : Shows the playback time. Select display type from the following:

- Elapsed playback time of the title, chapter, disc, track or file
- Remaining playback time of the title, chapter, disc, track or file

Mode/Play Mode

DVD **CD** **VIDEO** **MUSIC** **PHOTO** : Shows current playback mode. You can select playback mode from the following:

CD

- Normal: Normal playback.
- Shuffle: Random playback without repetition.
- Random: Random playback with repetition.

DVD

- Normal
- Shuffle CH (chapter)
- Shuffle TT (title)
- Shuffle All
- Random CH (chapter)
- Random TT (title)
- Random All

VIDEO MUSIC PHOTO

- Normal
- Shuffle F (folder)
- Random F (folder)

Audio **BD** **DVD** **VIDEO** : Shows audio language/signal of a Blu-ray Disc/DVD currently selected. You can select the desired type of audio.

Angle **BD** **DVD** : Shows the currently-selected angle number. If the video is recorded with multiple angles, you can change the angle.

Subtitle **BD** **DVD** **VIDEO** : Shows the currently-selected subtitle language when the subtitle is provided.

Subtitle Style **BD** : Shows the currently-selected subtitle style. This function is available only for Video-file external subtitle. You can select the desired text style of subtitle.

Bitrate **BD** **DVD** **CD** **VIDEO** **MUSIC** : Shows bitrate of the audio/video signal.

Second Video **BD** : Turns the PIP on/off (p. 9).

Second Audio **BD** : Turns the secondary audio on/off (p. 9).

Ins Search

BD **DVD** **CD** **VIDEO** **MUSIC** : Skips 30 seconds.

Ins Replay

BD **DVD** **CD** **VIDEO** **MUSIC** : Replays the content from 10 seconds before.

CC Select

BD **DVD** **VIDEO** : Sets the displayed closed caption.

Slide Show PHOTO :

Shows slide show speed. You can select the slide show speed from Slow/Medium/Fast.

Transition **PHOTO** : Shows how photo appears on the screen. You can select the transition type.

■ Status menu

This shows various settings, such as subtitles, angle settings and the title/chapter/track number currently played back. To display status menu, press **STATUS**. Status menu contains following menus.

BD DVD VIDEO

Example: Icons when playing a Blu-ray Disc

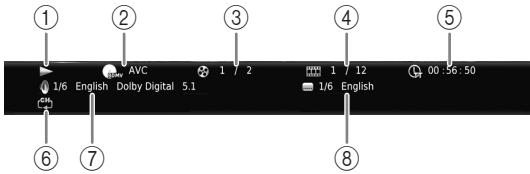

- ① **(Playback status)**
- ② **(Disc type/video file icon)**
- ③ **(Title number being played):** You can jump to specified title with **SEARCH** button (p. 9).
- ④ **(Chapter number being played) **BD DVD** :** You can jump to specified chapter with **SEARCH** button (p. 9).
- ⑤ **(Track/file number being played) **VIDEO** :** You can jump to specified track with **SEARCH** button (p. 9).
- ⑤ **(Elapsed playback time):** You can jump to specified point with **SEARCH** button (p. 9).
- ⑥ **(Repeat mode):** Shows current repeat mode (p. 10).
- ⑦ **(Audio currently selected):** You can change the audio language or format with **AUDIO** button.
- ⑧ **(Subtitle currently selected):** You can change the subtitle language with **SUBTITLE** button.

DVD CD MUSIC

Example: Icons when playing a music file

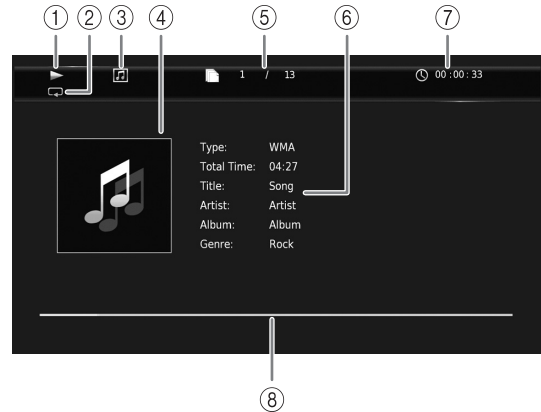

- ① **(Playback status)**
- ② **(Repeat mode):** Shows current repeat mode (p. 10).
- ③ **(Disc type/music file icon)**
- ④ **(Artwork) **MUSIC** :** Displays artwork if the file contains it.
- ⑤ **(Track/file number being played):** You can jump to specified track with **SEARCH** button (p. 9).
- ⑥ **(Information) **MUSIC** :** Displays music information if the file contains them.
- ⑦ **(Elapsed playback time):** You can jump to specified point with **SEARCH** button (p. 9).
- ⑧ **(Progress bar) **MUSIC** :** Shows progress status of current song.

PHOTO

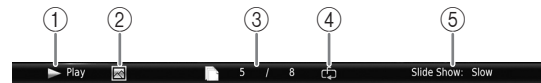

- ① **(Playback status)**
- ② **(Photo file icon)**
- ③ **(File number being displayed)**
- ④ **(Repeat mode):** Shows current repeat mode (p. 10).
- ⑤ **(Slide show speed)**

■ Program play **DVD** **CD**

This allows you to program playback order of audio disc tracks or DVD chapters.

Press **PROGRAM** during playback to display the **PROGRAM** window to program playback order.

You can program up to 15 tracks/chapters.

Note

- Program play is not available during the CD mode (p. 26).

Example: Programming the playback order of CD tracks

- 1 Press **PROGRAM** during playback.

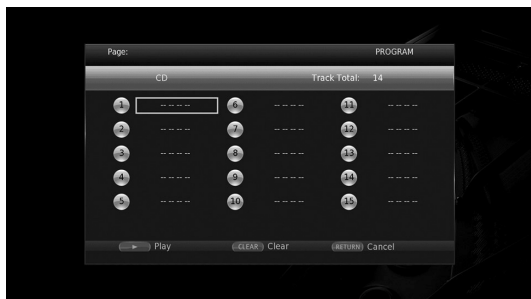

- 2 Press **ENTER** to program playback order. For audio disc, press **▲/▼** to select a desired track then press **ENTER**.

For DVD-Video disc, select a desired title (shown as TT) and chapter (shown as CH) instead of a track.

To clear a set track, select the track you want to clear, then press **CLEAR**.

Press **RETURN** to cancel the Program play.

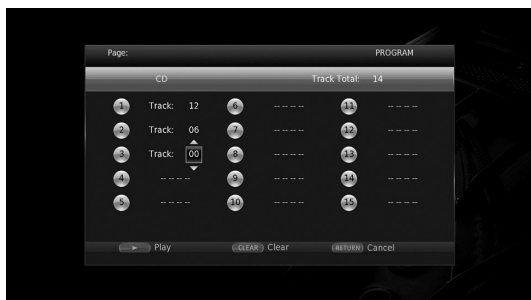

- 3 After programming is finished, press **▶** to set and start program playback.
- 4 To cancel program play, stop playback completely by pressing **■**.





■ Using Search

BD **DVD** **CD** **VIDEO** **MUSIC** **PHOTO**



This allows you to jump to the specified point during playback.

- 1 Press **SEARCH** during playback. Status bar appears.
- 2 Press **▲/▼/◀/▶** to select one of the item below, then press **ENTER**.

BD DVD :

- Title number (shown as )
- Chapter number (shown as )
- Elapsed title time (shown as )
- Elapsed chapter time (shown as )

CD :

- Track number (shown as )
- Elapsed track time (shown as )
- Elapsed disc time (shown as )

VIDEO MUSIC :





- File number (shown as )
- Chapter number (shown as )
- Elapsed file time (shown as )

PHOTO :

- File number (shown as )

- 3 Press **▲/▼** or number buttons to set/adjust the value of the focused item, and press **ENTER** to jump to the specified point.

- 4 To close the status bar, press **STATUS**.

■ Enjoying BONUSVIEW™ and BD-Live™

This Player supports BONUSVIEW (p. 51) (BD-ROM Profile 1 Version 1.1) and BD-Live (p. 51) (BD-ROM Profile 2) playback functions.



Note

- Functions and playback method vary depending on the disc. See the guidance on the disc or the supplied user's manual.

■ Using Picture in Picture function (secondary audio/video playback)

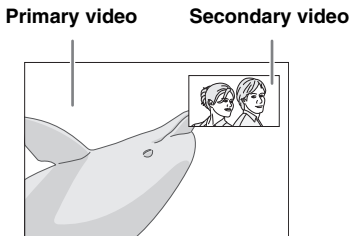
BD-Video that includes secondary audio and video compatible with Picture in Picture can be played back with secondary audio and video simultaneously as a small video in the corner.



While PIP Mark () or Secondary Audio Mark () is displayed, press PIP to turn the Picture in Picture function on/off.

Notes

- To listen to secondary audio, make sure that the Audio Output setting (Coaxial / Optical or HDMI) is set to PCM or Reencode (p. 42).
- Depending on the disc, to listen to secondary audio, you may need to set secondary audio to on from the top menu of the disc (p. 8).
- The secondary audio and video for Picture in Picture may automatically play back and be removed depending on the content. Also, playable areas may be restricted.

■ Using the feature of BD-Live™

1. Set the Network setting (p. 39).

2. Connect the USB memory device to this Player (p. 19).

BD-Live data is saved in a USB memory device connected to this Player. To enjoy these functions, connect a USB memory device supporting USB 2.0 High Speed (480 Mbit/s) to one of the USB connectors (front/rear) of this Player to use the USB memory device as Local Storage.

- Local Storage is used as an auxiliary memory when Blu-ray Disc is played back.
- Use a USB memory device with at least 2GB of free space.
- BUDA folder is created automatically in the USB memory device when necessary.
- If there is insufficient storage space, the data will not be copied/downloaded. Delete unneeded data or use a new USB memory device.
- Some time may be required for the data to load (read/write).

Notes

- Yamaha cannot guarantee that all brands' USB memory devices will operate with this Player.
- Do not use a USB extension cable when connecting a USB memory device to the USB connector of the Player. Using a USB extension cable may prevent the Player from performing correctly.

3. Play back the disc.

4. Run BD-Live according to the instructions on the disc.



Notes

- Do not remove the USB memory device or disconnect unplug the power cable during BD-Live operations.
- Regarding playback method of BD-Live contents, etc., perform the operations in accordance with the instructions in the Blu-ray Disc manual.
- To enjoy BD-Live functions, perform the network connection (p. 16) and Network settings (p. 39).
- Refer to “BD-Live Connection” (p. 39) regarding the setup to restrict access to BD-Live contents.
- The time required to download the provided programs into the USB memory device connected to this Player varies depending on the internet connection speeds and the data volume of the programs.
- BD-Live programs provided through the internet may not be able to display the connection depending on the status (upgrading) of the provider. In such cases, take out the disc and try again.
- If the BD-Live screen does not appear for a while after you select the BD-Live function in the Blu-ray Disc menu, the USB memory device may not have enough free space. In such cases, eject the disc from the Player, and then erase the data in the USB memory device using the “Format” menu in the “Local Storage” (p. 37).

SETUP menu

The SETUP menu enables various audio/visual settings and adjustments for functions using the remote control unit.

Menu/Submenu	Item	Function	Page	
 General Setting	System			
	Auto Power Standby	Sets the power-saving function to on/off.	37	
	HDMI Control	Sets this Player to receive control signal from the remote control of your TV/AV receiver.	37	
	Load Default	Resets all settings to the default setting except Security setting.	37	
	Upgrade	Performs upgrade of this Player.	37	
	Upgrade Notification	Selects whether to display the message on the screen when this Player detects newer software over the Internet.	37	
	3D Playback Message	Displays a warning message concerning 3D video playback when this Player is turned on.	37	
	Local Storage	Displays the free space of USB memory device connected to this Player, or formats the "BUDA" folder in the USB memory device.	37	
	Easy Setup	Sets language, resolution, screen aspect ratio.	37	
	Software License	Displays the software license information.	37	
	Language			
	OSD	Selects the language for On Screen Display.	38	
	Menu	Prioritizes the language for disc menu.	38	
	Audio	Prioritizes the language for audio.	38	
	Subtitle	Prioritizes the language for subtitle.	38	
	Playback			
	Disc Auto Playback	Sets this Player to start disc playback automatically.	38	
	Angle Mark	Sets to display the Angle Mark when Blu-ray Disc/DVD with multiple angles is played back.	38	
	PIP Mark	Sets to display the PIP Mark when Blu-ray Disc/DVD with Picture in Picture is played back.	38	
	Secondary Audio Mark	Sets to display the Secondary Audio Mark when Blu-ray Disc/DVD with secondary audio is played back.	38	
	Last Memory	Sets this Player to remember the last playback position of a disc (Blu-ray or DVD video) when it is set to standby mode or the disc tray is opened.	38	
	VUDU	Deactivates this Player from VUDU service.	38	
	Security			
	Change Password	Changes password for Parental Control and Country Code.	38	
	Parental Control	Sets the Parental Control depending on the disc content.	38	
	Country Code	Sets your Country Code.	38	
	Network			
	Connection setting	Sets a network connection method.	39	
	Information	Displays network information screen.	39	
	Connection Test	Performs the network connection test.	39	
	IP Setting	Sets the IP setting to Auto/Manual.	39	
	Proxy Setting	Sets the proxy setting.	39	
	Network Control	Selects whether this Player can be controlled from AV CONTROLLER.	39	
Network Standby	Selects whether this Player can be turned on from other network devices.	39		
DMC Control	Selects whether to allow DLNA-compatible Digital Media Controller (DMC) (p. 17) to control this Player.	39		
BD-Live Connection	Sets the BD-Live connection to Permitted/Partial Permitted/Prohibited.	39		

Menu/Submenu	Item	Function	Page			
 Display Setting	TV	3D Output	Selects 3D or 2D videos.	40		
		TV Screen	Sets the screen aspect ratio of the connected TV, and adjust the video output.	40		
		4K Upscaling	Enables/disables 4K upscaling for HDMI video output.	40		
		HDMI Resolution	Selects the HDMI video output resolution.	40		
		TV System	Selects the TV System from NTSC/PAL/Multi.	40		
		Color Space	Selects Color Space from YCbCr 4:4:4/YCbCr 4:2:2/Full RGB/RGB.	40		
		HDMI Deep Color	Selects HDMI Deep Color from 30 bits/36 bits/Off.	40		
		HDMI 1080p 24Hz	Sets HDMI 1080p 24Hz to Auto/Off.	41		
	Video Process	Noise Reduction	Sets the level of Noise Reduction.	41		
		De-interlacing Mode	Sets how to detect the video signal.	41		
	Screen Saver	Time	Sets the time to activate the screen saver (slide show).	41		
		SlideShow order	Enables/disables the shuffle function for the screen saver (slide show).	41		
		Transition	Selects the transition type for the screen saver (slide show).	41		
	Closed Caption	CC Attribute	Sets the appearance of closed captions.	41		
		Font color Font size Font style Font opacity Font edge Font edge color BG color BG opacity Window color Window opacity	Customize the font, background and window used for closed captions when CC Attribute is set to Custom.	41		
		CD Mode	HDMI	Selects whether to restrict HDMI output during the CD mode.	42	
			Audio Output	Coaxial / Optical	Selects the output mode of COAXIAL jack/OPTICAL terminal from Bitstream/PCM/Reencode/Off.	42
				HDMI	Selects the output mode of HDMI terminal from Bitstream/PCM/Reencode/Off.	42
				Downsampling	Selects the digital audio signal down sampling frequency from 48K/96K/192K.	42
DRC				Sets the DRC (Dynamic Range Control).	42	
SACD/DSD File Output	Output Priority		Selects the output jacks to be used for playing back SA-CDs.	42		
	Output Method	Selects the audio signal output from the HDMI jack when an SA-CD or a DSD file is played back.	42			
	SACD Area	Selects whether to play back 2-channel or multi-channel content when the SA-CD contains the both types of contents.	42			
Speaker Setting	2ch Downmix	Sets the audio output from the ANALOG OUT and BALANCED OUT jacks.	42			
Post Process	UpMix	Multi-channelizes the 2-channel audio signal.	43			
 System Information		Displays software version and MAC address (p. 52).	43			

■ Example of SETUP menu operation

You need to call up the SETUP menu screen to perform settings for this Player. The following is the explanation for basic operations of the SETUP menu.

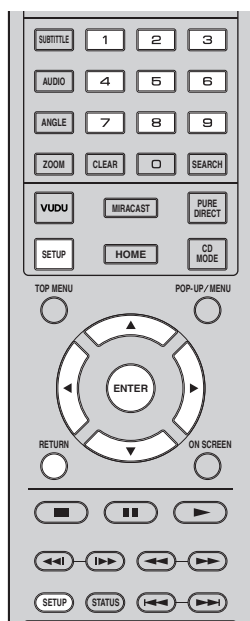

Example: Setting Disc Auto Playback

Note

- Some items cannot be set during playback. In this case, press  to stop playback completely before setting.

1. Display the SETUP menu screen.

Press **SETUP** to display the SETUP menu screen. Press **◀/▶** to select General Setting, then press **ENTER** or **▼**.

2. Select a Submenu.

Press **▲/▼** to select Playback, then press **ENTER** or cursor **▶**.

3. Select a menu item.

Press **▲/▼** to select Disc Auto Playback, then press **ENTER** or cursor **▶**.

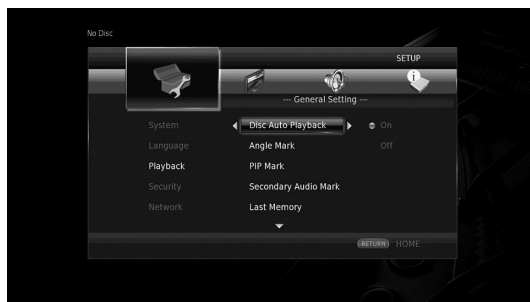

4. Select a desired setting.

Press **▲/▼** to select On or Off, then press **ENTER**.

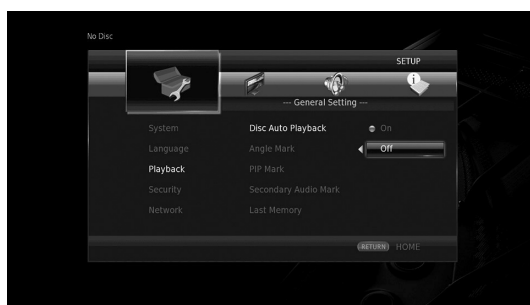

Hint

- You need to use the number buttons to enter numbers (such as password) for some menu items.

5. Exit the menu screen.

Press **◀** to return to the previous menu.

■ General Setting



The default settings are marked with “*”.

System

Auto Power Standby

Sets the power-saving function to on/off. When set to on, this Player will turn to standby mode after 20 minutes from the last operation without any playback.

Hint

- Before this Player turns to standby mode, the screen saver (p. 41) will activate.

On*, Off

HDMI Control

You can set the Player to receive control signal from a TV/AV receiver compatible with the HDMI Control function via an HDMI cable (p. 12).

On, Off*

Using HDMI Control function

Using the HDMI Control function, you can interactively operate this Player with your TV (HDMI Control function supported).

When you connect this Player to the TV compatible with the HDMI Control function using an HDMI cable and set HDMI Control in the SETUP menu to on (p. 37), you can perform the function listed below.

- Automatic input select function
When you start playback of this Player, the input selector of the TV (and an AV receiver if this Player is connected to the TV via the AV receiver) is switched to this Player automatically. TV Power is turned on automatically depending on the TV.
- Automatic power off function
When you turn off the TV while this Player is in stop mode and the SETUP menu screen is not displayed, the power of this Player is also turned off automatically.

Notes

- HDMI Control function may not work properly depending on the TV.
- Functions other than ones shown above may work depending on the TV or AV receiver.
- In order to make the HDMI Control function available, set up settings for the HDMI Control function on ALL components (this Player, TV, and AV receiver). Certain operation may also be required.
- Each function may be set independently to activate/deactivate depending on the TV.
- Refer to the operation manuals supplied with the TV and/or AV receiver for details regarding setup.
- When set to on, power consumption during standby mode increases due to HDMI Control function.

Load Default

You can reset all settings of this Player to default setting except Security setting (p. 38). For details on default settings, see pages 34-43.

Upgrade

You can upgrade the software manually from USB Storage or Network. For details on software upgrade, refer to “Software upgrade” (p. 46).

Upgrade Notification

You can select whether to display the message on the screen when this Player detects newer software over the Internet.

On*, Off

3D Playback Message

You can turn on or off a warning message concerning 3D video playback that appears on the TV when this Player is turned on.

On*, Off

Local Storage

You can check the free space of USB memory device connected to this Player, or format (empty) the “BUDA” folder in the USB memory device connected to this Player by selecting Format.

Hint

- To enjoy the BD-Live feature (p. 33), you need to connect a USB memory device (with at least 2GB of free space) to one of the USB connectors (front/rear) of this Player to use the USB memory device as Local Storage.

Easy Setup

You can perform Easy Setup (p. 21).

Software License

You can view the information about third party software license.

By using this product, you will be deemed to have accepted the terms and conditions.

Language

OSD

You can select the language for On Screen Display which is the messages or menu displayed on the screen such as SETUP menu.

English, Français, Español, Deutsch, Italiano, Svenska, Nederlandse, Polski, Русский, 中文

Menu

You can prioritize the language for disc menu.

English, Français, 中文, Español, Deutsch, Italiano, Nederlandse, Portuguese, Danish, Svenska, Finnish, Norwegian, Polski, Русский, Korean, Japanese, More

Audio

You can prioritize the audio language for Blu-ray Disc/DVD playback. For details on setting items, see “Menu” (p. 38).

Subtitle

You can prioritize the language for Subtitle.

English, Français, 中文, Español, Deutsch, Italiano, Nederlandse, Portuguese, Danish, Svenska, Finnish, Norwegian, Polski, Русский, Korean, Japanese, More, Off

(The default settings in [Language] differ depending on your model.)

Playback

Disc Auto Playback

You can set Disc Auto Playback to on/off. When set to on, a disc will play back automatically after loading.

On*, Off

Angle Mark

You can set to display the Angle Mark () when Blu-ray Disc/DVD with multiple angles is played back.

On*, Off

PIP Mark

You can set to display the PIP Mark () when Blu-ray Disc with picture in picture (p. 33) is played back.

On*, Off

Secondary Audio Mark

You can set to display the Secondary Audio Mark () when Blu-ray Disc with secondary audio is played back.

On*, Off

Last Memory

You can set whether this Player remembers the last playback position of a disc (Blu-ray or DVD video) when it is set to standby mode or the disc tray is opened.

On*, Off

Note

- Some discs are not compatible with this function.

VUDU

You can deactivate this Player from VUDU service (p. 24).

Security

Change Password

You can set the password for changing the Parental Control Level and Country Code. Refer to “Parental Control” (p. 38) and “Country Code” (p. 38).

Notes

- The default password is 0000.
- If you forget the password, refer to “Troubleshooting” (p. 47) and set all the Security settings to their default settings.

Parental Control

In some Blu-ray Discs/DVDs, a control level for disc viewing is set depending on the age of the viewer. You can set the Parental Control shown on the screen depending on the disc content.

The password (see “Change Password” on p. 38) needs to be entered before the Parental Control Levels is set. After you set the Parental Control, when you play back a disc with level higher than current Parental Control Level, or you want to change the Parental Control Level, a dialog box will pop up to ask you to enter the password.

Off*, 1–8

Country Code

You can set the Country Code you live in. The password (see “Change Password” on p. 38) needs to be entered before the Country Code is set. This setting may be used for rating of Parental Control and disc playback.

Network

Connection setting

You can select a network connection method.

- Wired*** Connects the network using Ethernet.
- Wireless** Connects the network using a wireless LAN. You can select settings for a wireless LAN connection. Follow the on-screen instructions to proceed.

Scan

Searches for an access point. You can connect the access point that is found.

Manual

You can manually set information for an access point.

Auto

If your access point supports the WPS (Wi-Fi Protected Setup) function, you can use the auto setup method to connect this Player to the access point without entering information manually. Select PBC (Push Button Configuration) or PIN code method.

Information

You can display network information screen. On this screen, you can view the information of Interface (Ethernet), Address Type, IP Address, Subnet Mask, Default Gateway, and DNS.

Connection Test

You can perform an internet connection test. If the test is failed, please check “IP Setting” (p. 39) and perform the test again.

IP Setting

You can configure the network settings.

- Auto*** Select to automatically configure the network settings of this Player with the DHCP server.
- Manual** Select to configure the network settings (IP Address, Subnet Mask, Default Gateway, and DNS) manually.

Hints

- **Numeric keys** Enters characters.
- **◀/▶** Moves the highlight.
- **CLEAR** Deletes a character.
- **ENTER** Saves the settings and exits from the menu.

Proxy Setting

You can set Proxy Setting. Set to Disable for normal use. Set to Enable to set the proxy setting.

- Disable*** Sets proxy server to disable. Select this item when proxy server is not used.
- Enable** Enables proxy host and proxy port setting.
- Proxy Host** Sets proxy host.
- Proxy Port** Sets proxy port.

Network Control

Selects whether this Player can be controlled from AV CONTROLLER. When On with filter is selected, you can specify the MAC addresses of the mobile devices (such as smartphones and tablet) that will be permitted access to this Player.

On*, On with filter, Off

Network Standby

You can select whether this Player can be turned on from other network devices such as “AV CONTROLLER” (p. 29).

On, Off*

Note

- This setting is available only when Network Control is enabled.

DMC Control

You can select whether to allow DLNA-compatible Digital Media Controller (DMC) (p. 17) to control this Player.

Enable*, Disable

BD-Live Connection

You can set access restriction to BD-Live contents.

- Permitted** Allows all BD-Live discs to connect the network.
- Partial Permitted*** Allows only discs with owner certification.
- Prohibited** Prohibits all BD-Live discs to connect the network.

■ Display Setting



The default settings are marked with “*”.

TV

3D Output

You can select 3D or 2D video output from this Player.

Auto* This Player automatically selects 3D or 2D videos.

Off This Player always selects 2D videos.

Note

- Even if you set “3D Output” to “Auto” and play back a Blu-ray 3D Disc, this Player selects 2D images depending on the setting of TV, etc.

TV Screen

You can set the screen aspect ratio of the connected TV, and adjust the video output.

If you switch your TV (i.e. because you have bought a new one) and the screen aspect ratio of the connected TV changes, you will have to change the TV Screen setting.

16:9 Full Select this when this Player is connected to a TV with a 16:9 screen. When a 4:3 aspect ratio video is played back, the video is displayed as shown below.

16:9 Normal* Select this when this Player is connected to a TV with a 16:9 screen. When a 4:3 aspect ratio video is played back, the video is displayed as shown below.

4:3 Pan Scan Select this when this Player is connected to a TV with a 4:3 screen. When a 16:9 aspect ratio video is played back, the video is displayed as shown below.

4:3 Letter Box Select this when this Player is connected to a TV with a 4:3 screen. When a 16:9 aspect ratio video is played back, the video is displayed as shown below.

Original image size	On 16:9 (wide screen) TV	
	16:9 Full	16:9 Normal
 4:3		

Original image size	On 4:3 TV	
	4:3 Pan Scan	4:3 Letter Box
 16:9		

4K Upscaling

Enables/disables 4K upscaling for HDMI video output. When set to on, you can set “HDMI Resolution” to “4K”.

On*, Off

HDMI Resolution

You can select the HDMI video output resolution. For more details on output formats, refer to “Video output formats” (p. 44).

When set to Auto, resolution is set to the maximum resolution according to the connected TV.

When set to Disc Native, the original resolution and video frequency, recorded in the Blu-ray Disc or DVD that is played back, are used. You can use a video up-converter function of an external device.

When other than a Blu-ray Disc or DVD is played back, the resolution and video frequency will work as Auto. If a Blu-ray Disc or DVD whose resolution and video frequency are not compatible with the connected TV, no image will be output. In this case, stop playback, and select an option other than Disc Native.

Auto*, Disc Native, 4K, 480i/576i, 480p/576p, 720p, 1080i, 1080p

Notes

- To output HD audio (Dolby TrueHD or DTS-HD Master Audio) from HDMI terminal, set HDMI Resolution to Auto or more than 720p.
- 4K is available only when 4K Upscaling is set to On.
- Auto is automatically selected when 4K Upscaling is set to Off while HDMI Resolution is set to 4K.

TV System

You can select TV System from PAL, NTSC and Multi. Set the same TV System as your TV set. For more details on output formats, refer to “Video output formats” (p. 44).

NTSC, PAL, Multi

(The default setting differs depending on your model.)

Color Space

You can select the Color Space (p. 51) output from HDMI. This function is available when this Player is connected with an HDMI cable.

YCbCr 4:4:4* Sets Color Space to YCbCr 4:4:4.

YCbCr 4:2:2 Sets Color Space to YCbCr 4:2:2.

Full RGB When RGB is set and white and black on the screen are too faint, select this item. This setting is effective when a connected component supports RGB 0–255 range.

RGB Outputs video signal at normal signal range.

Note

- This function is only available on TVs that support this function.

HDMI Deep Color

When your TV and/or AV receiver is compatible with Deep Color (p. 51), set this item according to your TV/AV receiver. This function is available when this Player is connected with an HDMI cable.

30 bits, 36 bits, Off*

HDMI 1080p 24Hz

This outputs the BD-Video encoded in 24Hz frame rate in HDMI 1080p 24Hz. Smoother video playback may be available with this function. This function is available when your TV/AV receiver support this function. For more details on output formats, refer to “Video output formats” (p. 44).

Auto*, Off

Note

- This setting is disabled when output resolution is other than 1080p.

Video Process

Noise Reduction

You can set the Noise Reduction to a level of 0 to 3. 0 is off, and 3 is the maximum level.

0, 1, 2*, 3

De-interlacing Mode

You can select how to detect the video signal. Set to Auto for normal use. When horizontal stripping noise appears on the screen, set this to Film/Video to remove the noise.

Auto*, Film, Video

Screen Saver

You can display the screen saver when you do not operate this Player for the specified time. You can select the built-in images or photo slide show.

Hints

- To use the slide show as the screen saver, create the “autopict” folder under the root directory of the USB memory device, put at 3 or more photo files (JPEG, GIF and PNG format files) into the folder, and connect the USB memory device to this Player.
- “SlideShow order” and “Transition” works when the slide show is used as the screen saver. These settings are synchronized with the photo slide show settings in the On Screen menu (p. 30).

Time

You can set the amount of time (minutes) to activate the screen saver. If you do not operate this Player for the specified time, the unit will automatically activate the screen saver.

1, 5*, 10

SlideShow order

You can enable/disable the shuffle function for the screen saver (slide show).

Normal* The photos are displayed in normal order.

Shuffle The photos are displayed in random order.

Transition

You can select the transition type for the screen saver (slide show).

None*, **Wipe left**, **Wipe right**, **Wipe up**, **Wipe down**, **Box in**, **Box out**, **Blending**, **Dissolve**, **Interlace H**, **Interlace V**, **Split in H**, **Split in V**, **Split out H**, **Split out V**

Closed Caption

CC Attribute

You can set the appearance of closed captions. When Auto is selected, digital closed captions will be displayed in default settings. When Custom is selected, you can customize the appearance of closed captions (Font color, Font size, etc.) manually.

Auto, Custom

Font color, **Font size**, **Font style**,
Font opacity, **Font edge**, **Font edge color**,
BG color, **BG opacity**, **Window color**,
Window opacity

Customize the font, background and window used for closed captions when CC Attribute is set to Custom.

■ Audio Setting



The default settings are marked with “*”.

CD Mode

HDMI

You can select whether to restrict HDMI output during the CD mode (p. 26).

Off Disables all the HDMI circuitries during the CD mode.

Audio Only* Disables HDMI video output (the black screen is displayed) and outputs audio only from the HDMI jack during the CD mode.

Audio Output

Coaxial / Optical

You can select the output mode of COAXIAL jack and OPTICAL terminal. For more details on output formats, refer to “Audio output formats” (p. 45).

Bitstream Outputs digital signal without any processing. Secondary Audio is not output.

PCM Outputs 2-channel PCM.

Reencode* Outputs Bitstream with Secondary Audio.

Off Mutes sound.

HDMI

You can select the output mode of HDMI terminal. For details on setting items, see “Coaxial / Optical” (p. 42). For more details on output formats, refer to “Audio output formats” (p. 45).

Bitstream*, PCM, Reencode, Off

Note

- To output HD audio (Dolby TrueHD or DTS-HD Master Audio) from HDMI terminal, set HDMI Resolution to Auto or more than 720p (p. 40).

Downsampling

You can select digital audio signal down-sample frequency. This function is effective for the audio signal output from the COAXIAL jack/OPTICAL terminal.

48K* The highest sampling rate of digital PCM output is 48 kHz.

96K The highest sampling rate of digital PCM output is 96 kHz.

192K The highest sampling rate of digital PCM output is 192 kHz.

DRC

You can set the DRC (Dynamic Range Control) (p. 51) to On/Off/Auto. When set to Auto, DRC is automatically turned on for a source with DRC information in Dolby TrueHD format. DRC makes the strong sound such as pliosive sound lower, and conversations more audible. It is useful when you watch movies in the night.

Off, On, Auto*

SACD/DSD File Output

Output Priority

You can select the output jacks to be used for playing back SA-CDs.

HDMI* SA-CD audio is output from the HDMI jack.

Analog SA-CD audio is output from the analog (ANALOG OUT and BALANCED OUT) jacks. (DSD stereo is automatically selected and the converted analog signals are output.)

Output Method

You can select the audio signal output from the HDMI jack when an SA-CD or a DSD file is played back.

DSD* DSD signals are output from the HDMI jack.

PCM PCM signals (decoded by this Player) are output from the HDMI jack.

Note

- When Output Priority is set to Analog, DSD signals are output from the HDMI jack.

SACD Area

You can select whether to play back 2-channel (stereo) or multi-channel content when the SA-CD contains the both types of contents.

Multi*, Stereo

Note

- When Output Priority is set to Analog, the stereo area of an SA-CD is always selected.

Speaker Setting

2ch Downmix

You can select down mix method to analog 2-ch from Stereo or Lt/Rt.

Stereo* Changes channel output to stereo, which only delivers sound from the two front speakers.

Lt/Rt Select this item if this unit is connected to a Dolby Pro Logic decoder. Sound from rear speakers is mixed to the 2-ch stereo sound.

Post Process

UpMix

You can multi-channelize the 2-channel audio signal. To multi-channelize, select DTS NEO:6, then select Cinema or Music mode.

Off*, DTS NEO:6

■ System Information



Software version and MAC address (p. 52) are displayed.

Video/audio output formats

■ Video output formats

When TV System is set to NTSC

Contents	HDMI Resolution (p. 40)							
	Auto	Disc Native	4K (*3)	1080p	1080i	720p	480p/576p	480i/576i
BD-Video with 1080p/24Hz content	*1	1080p 24Hz	4K (2160p) 24 Hz	1080p 24Hz/60Hz *4	1080i 60Hz	720p 60Hz	480p	480i
BD-Video without 1080p/24Hz content	*1	*2	4K (2160p) 30 Hz	1080p 60Hz	1080i 60Hz	720p 60Hz	480p	480i
DVD-Video	*1	*2	4K (2160p) 30 Hz	1080p 60Hz	1080i 60Hz	720p 60Hz	480p	480i
Others	*1	*1	4K (2160p) 30 Hz	1080p 60Hz	1080i 60Hz	720p 60Hz	480p	480i

When TV System is set to PAL

Contents	HDMI Resolution (p. 40)							
	Auto	Disc Native	4K (*3)	1080p	1080i	720p	480p/576p	480i/576i
BD-Video with 1080p/24Hz content	*1	1080p 24Hz	4K (2160p) 24 Hz	1080p 24Hz/50Hz *4	1080i 50Hz	720p 50Hz	576p	576i
BD-Video without 1080p/24Hz content	*1	*2	4K (2160p) 25 Hz	1080p 50Hz	1080i 50Hz	720p 50Hz	576p	576i
DVD-Video	*1	*2	4K (2160p) 25 Hz	1080p 50Hz	1080i 50Hz	720p 50Hz	576p	576i
Others	*1	*1	4K (2160p) 25 Hz	1080p 50Hz	1080i 50Hz	720p 50Hz	576p	576i

*1 The maximum resolution supported by the TV connected to this Player

*2 The resolution and frequency of the source disc

*3 Available only when 4K Upscaling (p. 40) is set to On

*4 1080 p 24 Hz (when the TV supports 1080p 24 Hz and HDMI 1080p 24Hz (p. 41) is set to Auto) or 1080p 50/60Hz

When TV System is set to Multi

When TV System is set to Multi, video signals are output with the video system (NTSC/PAL) of the source. Refer to the tables above for details on the resolution/frequency for each video system.

Notes

- To watch videos with each resolution, it must be supported by the TV.
- Regardless of the frequency of content, video signals are output with 60 Hz when TV System (p. 40) is set to NTSC and output with 50 Hz when set to PAL.

■ Audio output formats

Source format	HDMI jack			DIGITAL OUT (COAXIAL / OPTICAL) jacks			Analog (ANALOG OUT/ BALANCED OUT) jacks
	Bitstream (*1)	PCM (*1)	Reencode (*1)	Bitstream (*1)	PCM (*1)	Reencode (*1)	
PCM 2ch	PCM 2ch	PCM 2ch	PCM 2ch *2	PCM 2ch	PCM 2ch	PCM 2ch *2	2ch
PCM 5.1ch	PCM 5.1ch	PCM 5.1ch	PCM 5.1ch *2	PCM 2ch	PCM 2ch	PCM 2ch *2	2ch
PCM 7.1ch	PCM 7.1ch	PCM 7.1ch	PCM 7.1ch *2	PCM 2ch	PCM 2ch	PCM 2ch *2	2ch
Dolby Digital	Dolby Digital	PCM up to 5.1ch	Dolby Digital	Dolby Digital	PCM 2ch	Dolby Digital	2ch
Dolby Digital Plus	Dolby Digital Plus	PCM up to 7.1ch	Dolby Digital Plus *2	Dolby Digital	PCM 2ch	Dolby Digital	2ch
Dolby TrueHD	Dolby TrueHD	PCM up to 7.1ch	Dolby TrueHD *2	Dolby Digital	PCM 2ch	Dolby Digital	2ch
DTS	DTS	PCM up to 5.1ch *3	DTS *4	DTS	PCM 2ch *3	DTS *4	2ch *3
DTS-HD High Resolution Audio	DTS-HD High Resolution Audio	PCM up to 7.1ch *3	DTS-HD High Resolution Audio *5	DTS	PCM 2ch *3	DTS *4	2ch *3
DTS-HD Master Audio	DTS-HD Master Audio	PCM up to 7.1ch *3	DTS-HD Master Audio *5	DTS	PCM 2ch *3	DTS *4	2ch *3

*1 Up to the Audio Output settings (p. 42)

*2 Output with Dolby Digital when secondary audio, button click sounds or effect sounds are included

*3 Does not output audio when USB memory device, DLNA or network service content is played back

*4 Does not reencode when USB memory device, DLNA or network service content is played back (output audio will be same format as Bitstream)

*5 Output with DTS when secondary audio, button click sounds or effect sounds are included. However, the source will not be reencoded when USB memory device, DLNA or network service content is played back (output audio will be same format as Bitstream)

Audio output format for SA-CDs/DSD files

SACD/DSD File Output settings (p. 42)			HDMI jack	DIGITAL OUT (COAXIAL / OPTICAL) jacks	Analog (ANALOG OUT/ BALANCED OUT) jacks
Output Priority	Output Method	SACD Area			
HDMI	DSD	Multi	DSD up to 5.1ch	No output	2ch (DSD signal is converted)
		Stereo	DSD 2ch	No output	2ch (DSD signal is converted)
	PCM	Multi	PCM up to 5.1 ch	No output	2ch (PCM signal is converted)
		Stereo	PCM 2 ch	No output	2ch (PCM signal is converted)
Analog *6	DSD	Stereo	No output	No output	2ch (DSD signal is converted)

*6 When Output Priority is set to Analog, DSD signals are output from the HDMI jack and the stereo area of an SA-CD is always selected

Software upgrade

New software that provides additional features or product improvements will be released as needed. We recommend upgrading the software of this Player to the latest version periodically.

To check for the availability of a software upgrade, visit <http://download.yamaha.com/>

Note

- Do not remove the USB memory device, set this Player to standby mode or unplug the power cable/network cable while the software upgrade is being performed.

■ Upgrading the software

1. Prepare for the software upgrade.

When you upgrade the software from USB Storage:

- ① Save the upgrade file package to the appropriate folder on the USB memory device. For more details, refer to the procedure document attached with the upgrade file package.
- ② Connect the USB memory device.

When you upgrade the software from Network:

Confirm that this Player is connected to the network.

3. Upgrade the software by following the on-screen messages.

Upgrade is completed. The system will be reset.

2. Select the upgrade method and start upgrade from SETUP menu.

- ① Press **SETUP** to display SETUP menu screen.
- ② Select General Setting → System → Upgrade.
- ③ Select the item which contains the upgrade file package from USB Storage/Network.

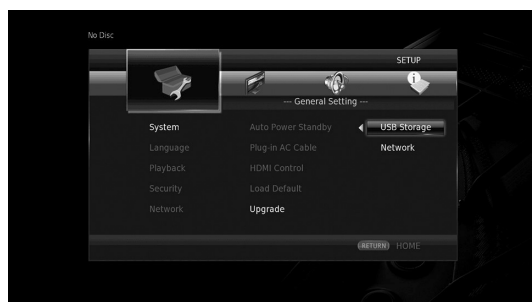

The system will search for upgrade file package.







Troubleshooting

Refer to the table below when this Player does not function properly. If the problem you are experiencing is not listed below or if the instruction below does not help, turn off this Player, disconnect the power cable, and contact the nearest authorized Yamaha dealer or service center.

■ Power

Problem	Possible causes and solutions
No power.	<ul style="list-style-type: none"> – Connect the AC power cable properly. – Press  on the front panel to turn on the power.
The Player power is turned off.	<ul style="list-style-type: none"> – This Player will be automatically turned off after 20 minutes of inactivity (no playback) when Auto Power Standby (p. 37) is set to on.





■ Basic operation

Problem	Possible causes and solutions
The remote control does not work.	<ul style="list-style-type: none"> – Use the remote control within its operating range (p. 11). – Replace the batteries (p. 11). – Check the ID settings for the main unit and the remote control. The remote control ID on the main unit may be changed after the main unit is reset. In this case, verify the remote control ID on the main unit, and set it again if needed (p. 11).
Buttons do not work.	<ul style="list-style-type: none"> – Turn on the TV connected to this Player and perform the initial settings (p. 21). – Press and hold  on the front panel for more than 5 seconds to reset this Player. – To completely reset this Player, unplug the power cable from the AC outlet for 30 seconds or more, plug the power cable to the AC outlet again, and then turn on this Player.
Password is forgotten.	<ul style="list-style-type: none"> – Press and hold , ,  and  on the front panel simultaneously when no disc is inserted and playback is stopped to set all the settings including Security settings (p. 38) of this Player to their default settings. After the power is turned off automatically, press  to turn on the power again.

■ Disc playback

Problem	Possible causes and solutions
The disc tray does not open or close.	<ul style="list-style-type: none"> – The disc tray is locked when any network service is selected. – The disc tray is locked when this Player is in the Miracast receiving mode. Press Miracast to exit from Miracast (p. 28).
The Player cannot play a disc.	<ul style="list-style-type: none"> – Take out the disc and clean it (p. 5). – Make sure that the disc is loaded properly (aligned in disc tray and label-side up) (p. 5). – Use a disc supported by the Player (p. 3). – Remove the disc and then check whether the Player supports the disc or not (p. 3). – Check the region code (p. 3). – Check whether the disc is defective by trying another disc. – The CD-R/RW, DVD+R/RW/R DL, and DVD-R/RW/R DL must be finalized (p. 3). – When this Player is in the CD-mode, discs other than music CDs and SA-CDs cannot be played (p. 26).
Video stops.	<ul style="list-style-type: none"> – The Player will stop if it senses shock or vibration.
The Player makes a snapping sound when starting playback or loading a disc.	<ul style="list-style-type: none"> – These sounds are not malfunctions of the Player but are normal operating conditions.
It takes time to start Blu-ray disc playback.	<ul style="list-style-type: none"> – This player searches for a USB memory device used as Local Storage for BD-Live feature (p. 33) when a Blu-ray disc is loaded. To reduce the waiting time, keep a USB memory device connected to the one of the USB connectors (front/rear) of this Player (p. 19).

Picture

Problem	Possible causes and solutions
No picture.	<ul style="list-style-type: none"> - Make sure that the cables are connected correctly (p. 12). - Make sure that the connected TV or the AV receiver is set to the correct input. - With no disc inserted, or playback stopped, press and hold  and  on the front panel simultaneously to set video resolution to the default value. If a picture is still not output, press and hold  on the front panel for approximately 5 seconds to switch NTSC/PAL. - When set to Disc Native, a signal that is not compatible with the connected TV is output. Change the setting to output a signal that is compatible with the connected TV (p. 40). - Make sure that the disc or file you are trying to play back is compatible with this Player (p. 3). - Disable the CD mode and Pure Direct mode (p. 26).
Screen freezes and operation buttons do not work.	<ul style="list-style-type: none"> - Press , then restart playback. - Turn off the power and turn on the power again. - Press and hold  on the front panel for more than 5 seconds to reset this Player.
Video is not output with the desired resolution.	<ul style="list-style-type: none"> - Set to the desired resolution (p. 40).
Wide-screen video appears vertically stretched, or black bands appear at the top and bottom of the screen. Or 4:3 video appears horizontally stretched.	<ul style="list-style-type: none"> - Change the aspect ratio of your TV (p. 40).
Square noise (mosaic) appears on the screen.	<ul style="list-style-type: none"> - Blocks in images may be visible in scenes with rapid movement due to the characteristics of digital image compression technology.

Sound

Problem	Possible causes and solutions
No sound, or sound is distorted.	<ul style="list-style-type: none"> - Check that the audio cable is connected correctly (p. 12). - Turn the volume of TV or AV receiver up. - There is no sound during still mode, fast forward, and fast reverse (p. 9). - Audio may not be output depending on the audio recording status, such as when audio other than an audio signal or non-standard audio is recorded for the audio content (p. 3). - Make sure that the disc or file you are trying to play back is compatible with this Player (p. 3). - If the sound is interrupted during playback in the CD mode, disable the CD mode (p. 26).
Left and right channels of audio are reversed, or sound comes out of only one side.	<ul style="list-style-type: none"> - Check the audio connection (p. 14).
Cannot hear the desired audio type and/or number of channels.	<ul style="list-style-type: none"> - Refer to Audio Output setting and "Audio output formats" (p. 42, p. 45).
Cannot hear the sound of PIP (secondary audio).	<ul style="list-style-type: none"> - Set Coaxial / Optical or HDMI to PCM/Reencode (p. 42). - To hear secondary audio, press 2ND AUDIO (p. 9). - Depending on the disc, you may need to set secondary audio on the top menu of the disc (p. 8).

■ Network

Problem	Possible causes and solutions
Cannot connect to the Internet.	<ul style="list-style-type: none"> - When connecting to the Internet by selecting Wired in Connection setting, connect the Network cable properly (p. 39). - Turn on the connected equipment, such as broadband router or modem. - Connect the broadband router and/or modem properly. - If Wireless is selected in Connection setting, and when you want to connect to the Internet using Ethernet, select Wired properly (p. 39). - Properly select Wireless in Connection setting when you want to connect to the Internet using a wireless LAN (p. 39).
Cannot download BD-Live contents.	<ul style="list-style-type: none"> - Verify that this Player can connect to the Internet normally. Refer to “Connection Test” (p. 39). - Connect USB memory device properly. Check that the USB memory device is connected to the USB connector of this Player (p. 19). - Check if the Blu-ray Disc supports BD-Live. - Connect the USB memory device formatted in FAT16, FAT32, or NTFS. - It is recommended to connect the USB memory device with at least 2 GB of free space. If there is not enough free space, format the USB memory device. (p. 37) - Refer to the supplied user’s manual of the disc or consult the disc manufacturer.
Cannot detect the DLNA server.	<ul style="list-style-type: none"> - Verify that this Player can connect to the network normally. Refer to “Connection Test” (p. 39). - Turn on the connected equipment, such as broadband router or the server. - Confirm the Player and the server are connected to the same router (or access point). - Depending on the DLNA server, the Player may need to be permitted from the server. - Depending on the DLNA server, it needs to change a firewall setting.
Cannot play the file on the DLNA server.	<ul style="list-style-type: none"> - Make sure the file is playable (p. 3). - Check your DLNA server’s setting. - The playback and operating quality may be affected by your home network condition.
Cannot connect to the Internet via Wireless LAN.	<ul style="list-style-type: none"> - Make sure that the wireless LAN router is turned on. - Depending on the surrounding environment, such as the wall material, radio wave receiving condition, or obstacles between the Player and the wireless LAN router, the communication distance may be shortened. Move the Player and the wireless LAN router closer to each other. - Devices that use a 2.4 GHz frequency band, such as a microwave, or wireless devices, may interrupt the communication. Move the Player away from such devices, or turn off such devices. - If the Internet connection using a wireless LAN is still not successful by the above solutions, try using Ethernet by selecting Wired in Connection setting (p. 39).
Wireless network is not found or distorted.	<ul style="list-style-type: none"> - Make sure that the wireless LAN router is turned on. - Move this Player closer to the router or change the orientation of this Player or the antenna of the wireless LAN router. - If the wireless connection cannot be configured using the WPS function, select another option (Scan or Manual) (p. 21). - Make sure that the wireless network is not disturbed by microwave ovens, digital cordless phones, or other neighboring Wi-Fi devices. - Microwave ovens, digital cordless phones or other wireless devices in your neighborhood might disturb the wireless network. Turn off these devices. - Make sure that the firewalls in your network allow access to the wireless connection of this Player. - If the wireless network does not work properly in your home, try the wired network connection.

■ Messages on the screen

- The following messages appear on the TV screen in case the disc you tried to play back is not appropriate or the operation is not correct.

Error message	Possible causes and solutions
Unsupported File	– The file is not supported with this Player. See “Types of discs/files that can be used with this Player” (p. 3).
Wrong region code!	– The disc is an incompatible region code. See “Region management information for Blu-ray Disc/DVD videos” (p. 3).
Network has FAILED.	– This Player cannot be connected to the network. Check connection (p. 16) and Network setting (p. 39).
Network is OK, proxy has FAILED.	– This Player cannot be connected to the proxy server. See “Proxy Setting” (p. 39).
BD-Live connection is prohibited in SETUP menu.	– BD-Live connection is prohibited. See “BD-Live Connection” (p. 39).
Upgrade has failed for some reason!	– Upgrade is failed. Check if the upgrade file is corrupted or unreadable.
IP Setting is not valid! Please reset...	– The IP Setting entered is not valid. Enter the correct information again.

Glossary

AVCHD

AVCHD is a new format (standard) for high definition video cameras that can be used to record and play high-resolution HD images.

BD-Live™

BD-Live is a Blu-ray Disc standard that utilizes a network connection, enabling this Player to go online to download promotional videos and other data.

BDMV

BDMV (Blu-ray Disc Movie) refers to one of the application formats used for BD-ROM which is one of the Blu-ray Disc specifications. BDMV is a recording format equivalent to DVD-Video of the DVD specification.

Blu-ray 3D™

Blu-ray 3D enables you to view full high definition 3D images.

BONUSVIEW™

BONUSVIEW compatible discs let you simultaneously enjoy video sub-channel for two screens, audio sub-channel and sub-titles. A small screen appears within the main screen during playback (Picture in Picture).

Closed Caption

Closed captions are kind of subtitle, and the difference between subtitles and captions is that subtitles are intended for hearing persons and captions are for the hearing impaired. Subtitles rarely show all of the audio. For example, captions show sound effects (e.g., “phone ringing” and “footsteps”), while subtitles do not. Before you select this setting, please ensure that the disc contains closed caption information.

Color Space

Color Space is a color range that can be represented. RGB is a color space based on the RGB color model (red, green and blue) and is typically used for PC monitors. YCbCr is a color space based on a luminance signal (Y) and two color difference signals (Cb and Cr).

Deep Color

Deep Color refers to the use of various color depths in displays, up from the 24-bit depths in previous versions of the HDMI specification. This extra bit depth allows HDTVs and other displays go from millions of colors to billions of colors and eliminate on-screen color banding for smooth tonal transitions and subtle gradations between colors. The increased contrast ratio can represent many times more shades of gray between black and white. Also Deep Color increases the number of available colors within the boundaries defined by the RGB or YCbCr color space.

DLNA

DLNA (Digital Living Network Alliance) provides easy sharing of digital media through network in the home, and you can enjoy digital contents stored on your DLNA-server-software-installed PC or other DLNA compatible device with your TV via this Player. To connect this Player to your DLNA servers, some settings for the DLNA server or device are required. For details, refer to your DLNA server software or DLNA device.

Dolby Digital

A sound system developed by Dolby Laboratories Inc. that gives movie theater ambience to audio output when the product is connected to a Dolby Digital processor or amplifier.

Dolby Digital Plus

A sound system developed as an extension to Dolby Digital. This audio coding technology supports 7.1 multi-channel surround sound.

Dolby TrueHD

Dolby TrueHD is a lossless coding technology that supports up to 8 channels of multi-channel surround sound for the next generation optical discs. The reproduced sound is true to the original source bit-for-bit.

DRC (Dynamic Range Control)

DRC lets you adjust the range between the loudest and softest sounds (dynamic range) for playback at average volume. Use this when it is hard to hear dialog, or during times when playback may disturb neighbors.

DTS

This is a digital sound system developed by DTS, Inc. for use in cinemas.

DTS-HD High Resolution Audio

DTS-HD High Resolution Audio is a new technology developed for the next generation high definition optical disc format.

DTS-HD Master Audio

DTS-HD Master Audio is a lossless audio compression technology developed for the next generation high definition optical disc format.

FLAC

FLAC (Free Lossless Audio Codec) is an open file format for lossless audio data compression. While inferior in compression rate to other lossy compressed audio formats, it can often provide higher audio quality.

HDMI

HDMI (High-Definition Multimedia Interface) is an interface that supports both video and audio on a single digital connection. The HDMI connection carries standard to high definition video signals and multi-channel audio signals to AV components such as HDMI equipped TVs, in digital form without degradation.

Letterbox (LB 4:3)

A screen size with black bars on the top and bottom of the image to allow viewing of wide-screen (16:9) material on a connected 4:3 TV.

Linear PCM Sound

Linear PCM is a signal recording format used for Audio CDs and on some DVD and Blu-ray Discs. The sound on Audio CDs is recorded at 44.1 kHz with 16 bits. (Sound is recorded between 48 kHz with 16 bits and 96 kHz with 24 bits on DVD discs and between 48 kHz with 16 bits and 192 kHz with 24 bits on Blu-ray Discs.)

Mac address

The Mac address is a unique value assigned to a network device for identification purposes.

Pan Scan (PS 4:3)

A screen size that cuts off the sides of the image to allow viewing of wide-screen (16:9) material on a connected 4:3 TV.

Subtitles

These are the lines of text appearing at the bottom of the screen which translate or transcribe the dialog. They are recorded on many DVDs and Blu-ray Discs.

x.v.Color

x.v.Color reproduces a greater range of color than before, showing almost all of the colors that the human eye can detect.

Specifications

■ General

Power supply	
[U.S.A. and Canada models]	AC 120 V, 60 Hz
[Europe, Russia and Australia models]	
	AC 110–240 V, 50 Hz
[Korea model]	AC 110–240 V, 60 Hz
Power consumption	20 W
Standby power consumption	
HDMI Control Off, Network Standby Off	0.4 W
HDMI Control On, Network Standby Off	0.5 W
HDMI Control Off, Network Standby On	
Wired	2.0 W
Wireless	2.3 W
HDMI Control On, Network Standby On	
Wired	2.0 W
Wireless	2.3 W
Dimensions (W × H × D, including protrusions)	435 × 86 × 262 mm (17-1/8 × 3-3/8 × 10-3/8 in)
Weight	3.8 kg (8.4 lbs.)

■ Audio performance

Audio output level (1 kHz, 0 dB)	
Blu-ray Disc/DVD/CD-DA	2 ± 0.3 V
Signal to noise ratio (IHF-A Network)	
Blu-ray Disc/DVD/CD-DA	115 dB or more
Dynamic range (IHF-A Network)	
Blu-ray Disc/DVD	110 dB or more
CD-DA	100 dB
Harmonic distortion (1 kHz)	
Blu-ray Disc/DVD/CD-DA	0.002% or less
Frequency Response	
Blu-ray Disc/DVD	4 Hz to 22 kHz (48 kHz Sampling) 4 Hz to 44 kHz (96 kHz Sampling)
CD-DA	4 Hz to 20 kHz

■ Input/output

HDMI output	Type A connector × 1 480i/576i/480p/576p/720p/1080i/1080p/1080p@24Hz/4K(2160p)@24Hz, Deep Color, x.v. Color support
Digital output	Optical × 1, Coaxial × 1
Analog audio output	Analog out (L/R) × 1, Balanced out (L/R) × 1
USB	Type A connector × 2
Wireless LAN	Standard: IEEE 802.11 b/g/n Frequency range: 2.4GHz band (channels: 1-11)
Other equipment	Remote IN/OUT × 1 Ethernet × 1

* The contents of this manual apply to the latest specifications as of the publishing date. To obtain the latest manual, access the Yamaha website then download the manual file.

■ Copyright

Note

– Audio-visual material may consist of copyrighted works which must not be recorded without the authority of the owner of the copyright. Refer to relevant laws in your country.



“Blu-ray Disc™”, “Blu-ray™”, “Blu-ray 3D™”, “BD-Live™”, “BONUSVIEW™”, and the logos are trademarks of the Blu-ray Disc Association.



DVD is a trademark of DVD Format/Logo Licensing Corporation.

DOLBY AUDIO

Manufactured under license from Dolby Laboratories. Dolby, Dolby Audio and the double-D symbol are trademarks of Dolby Laboratories.



For DTS patents, see <http://patents.dts.com>. Manufactured under license from DTS Licensing Limited. DTS, DTS-HD, the Symbol, & DTS and the Symbol together are registered trademarks, and DTS-HD Master Audio is a trademark of DTS, Inc. © DTS, Inc. All Rights Reserved.



“HDMI,” the “HDMI” logo and High-Definition Multimedia Interface are trademarks or registered trademarks of HDMI Licensing LLC in the United States and other countries.

x.v.Color™

“x.v.Color” and “x.v.Color” logo are trademarks of Sony Corporation.



“AVCHD” and the “AVCHD” logo are trademarks of Panasonic Corporation and Sony Corporation.

Continued to the next page. ➔



Java is a registered trademark of Oracle and/or its affiliates.



DLNA™ and DLNA CERTIFIED™ are trademarks or registered trademarks of Digital Living Network Alliance. All rights reserved. Unauthorized use is strictly prohibited.



The Wi-Fi CERTIFIED Logo is a certification mark of the Wi-Fi Alliance.

The Wi-Fi Protected Setup Identifier Mark is a mark of the Wi-Fi Alliance.

“Wi-Fi”, “Wi-Fi Protected Setup”, “Wi-Fi Direct” and “Miracast” are marks or registered marks of the Wi-Fi Alliance.

This product is licensed under the AVC patent portfolio license and VC-1 patent portfolio license for the personal and non-commercial use of a consumer to (i) encode video in compliance with the AVC Standard and VC-1 Standard (“AVC/VC-1 Video”) and/or (ii) decode AVC/VC-1 Video that was encoded by a consumer engaged in a personal and non-commercial activity and/or was obtained from a video provider licensed to provide AVC/VC-1 Video. No license is granted or shall be implied for any other use. Additional information may be obtained from MPEG LA, LLC. See <http://www.mpegla.com>.

This product is licensed under the MVC patent portfolio license for the personal use of a consumer or other uses in which it does not receive remuneration to (i) encode video in compliance with the MVC Standard (“MVC Video”) and/or (ii) decode MVC Video that was encoded by a consumer engaged in a personal activity and/or was obtained from a video provider licensed to provide MVC Video. No license is granted or shall be implied for any other use. Additional information may be obtained from MPEG LA, LLC. See <http://www.mpegla.com>

Windows Media Player is a registered trademark or trademark of Microsoft corporation in the United States and/or other countries

Copyright 2004-2012 Verance Corporation. Cinavia® is a Verance Corporation trademark. Protected by U.S. Patent 7,369,677 and worldwide patents issued and pending under license from Verance Corporation. All rights reserved.

Index

■ Numerics

2ch Downmix, SETUP menu	42
2ND AUDIO, remote control	9
3D Output, SETUP menu	40
3D Playback Message, SETUP menu	37

■ A

A/B, remote control	10
Angle Mark, SETUP menu	38
Angle, On Screen menu	30
ANGLE, remote control	8
Audio Output, SETUP menu	42
Audio Setting, SETUP menu	42
Audio, On Screen menu	30
AUDIO, remote control	8
Audio, SETUP menu	38
Auto Power Standby, SETUP menu	37
AV CONTROLLER	29

■ B

BD-Live	33
BD-Live Connection, SETUP menu	39
Bitrate, On Screen menu	30

■ C

CC Select, On Screen menu	30
CD Mode	26
Change Password, SETUP menu	38
Chapter, On Screen menu	30
CLEAR, remote control	9
Closed Caption, SETUP menu	41
Coaxial / Optical, SETUP menu	42
Color buttons, remote control	8
Color Space, SETUP menu	40
Connection Setting, SETUP menu	39
Connection Test, SETUP menu	39
Control buttons, remote control	9
Country Code, SETUP menu	38
Cursor buttons, remote control	8

■ D

De-interlacing Mode, SETUP menu	41
Digital Media Controller (DMC)	17
Disc Auto Playback, SETUP menu	38
Display Setting, SETUP menu	40
DLNA	17
Downsampling, SETUP menu	42
DRC, SETUP menu	42

■ E

Easy Setup, SETUP menu	37
ENTER, remote control	8

■ G

General Setting, SETUP menu	37
-----------------------------------	----

■ H

HDMI 1080p 24Hz, SETUP menu	41
HDMI Control function	37
HDMI Control, SETUP menu	37

HDMI Deep Color, SETUP menu	40
HDMI, SETUP menu	42
HOME, remote control	8

■ I

Information, SETUP menu	39
Ins Replay, On Screen menu	30
Ins Search, On Screen menu	30
IP Setting, SETUP menu	39

■ L

Language, SETUP menu	38
Last Memory, SETUP menu	38
Load Default, SETUP menu	37
Local Storage, SETUP menu	37

■ M

Menu, SETUP menu	38
Miracast	28
Mode/Play Mode, On Screen menu	30

■ N

Network Control, SETUP menu	39
Network, SETUP menu	39
Noise Reduction, SETUP menu	41
Number buttons, remote control	9

■ O

On Screen menu	30
ON SCREEN, remote control	9
OSD, SETUP menu	38

■ P

Parental Control, SETUP menu	38
PBC (Push Button Configuration)	39
Picture in Picture function	33
PIN code (WPS)	39
PIP Mark, SETUP menu	38
PIP, remote control	9
Playback, SETUP menu	38
POP UP/MENU, remote control	9
Post Process, SETUP menu	43
Program play	32
PROGRAM, remote control	9
Proxy Setting, SETUP menu	39
PURE DIRECT	9
Pure Direct	26

■ R

Remote control	8
Remote control (in/out)	18
REPEAT, remote control	10
RETURN, remote control	8

■ S

Search function	32
SEARCH, remote control	9
Second Audio, On Screen menu	30
Second Video, On Screen menu	30
Secondary Audio Mark, SETUP menu	38

Security, SETUP menu	38
SETUP menu	34
SETUP menu operation	36
SETUP, remote control	8, 9
SHUFFLE, remote control	9
Slide Show, On Screen menu	30
Software upgrade	46
Speaker Setting, SETUP menu	42
Status menu	31
STATUS, remote control	9
Subtitle Style, On Screen menu	30
Subtitle, On Screen menu	30
SUBTITLE, remote control	8
Subtitle, SETUP menu	38
System Information, SETUP menu	43
System, SETUP menu	37

■ T

Time, On Screen menu	30
Title, On Screen menu	30
TOP MENU, remote control	8
Track/File, On Screen menu	30
Transition, On Screen menu	30
TV Screen, SETUP menu	40
TV System, SETUP menu	40
TV, SETUP menu	40

■ U

Upgrade Notification	37
Upgrade of software	46
Upgrade, SETUP menu	37
UpMix, SETUP menu	43

■ V

Video Process, SETUP menu	41
VUDU	24

■ W

Wi-Fi Direct	27
WPS (Wi-Fi Protected Setup)	39

■ X

XLR balanced connection	15
-------------------------------	----

■ Z

ZOOM, remote control	8
----------------------------	---

The laser component in this product is capable of emitting radiation exceeding the limit for Class 1.

LASER Specification:

Class 1 LASER Product

Wave length: 790 nm (CDs)/658 nm (DVDs)/405 nm (BDs)

Laser output: max. 1 mW

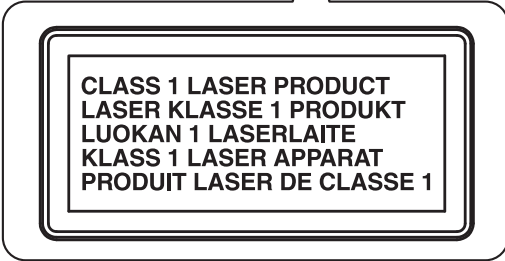

CAUTION

Use of controls or adjustments or performance of procedures other than those specified herein may result in hazardous radiation exposure.

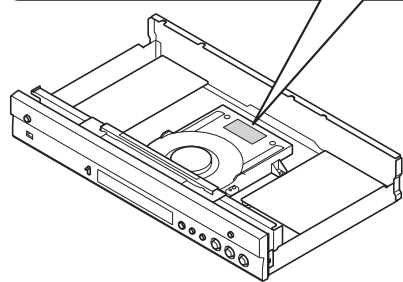
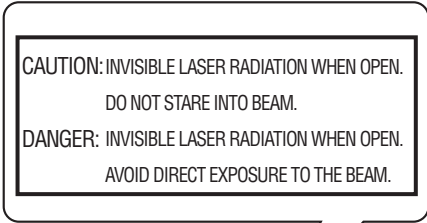



Yamaha Global Site
<http://www.yamaha.com/>
Yamaha Downloads
<http://download.yamaha.com/>

Manual Development Department
© 2016 Yamaha Corporation

Published 05/2016 AM-A0
Printed in China

BD-A1060/U