

*Pioneer Dj*

DJ controller

**DDJ-RR**

<http://pioneerdj.com/support/>  
<http://rekordbox.com/>

For FAQs and other support information for this product, visit the above site.

Operating Instructions

---

---

# Contents

## How to read this manual

- Thank you for buying this Pioneer DJ product.  
Be sure to read both this manual and the Operating Instructions (Quick Start Guide). Both contain important information that you should understand before using this product.  
For how to obtain the rekordbox Operating Instructions, see *Viewing the Operating Instructions of rekordbox* (p.5).
- In this manual, names of menus displayed on the product and on the computer screen, as well as names of buttons and terminals, etc., are indicated within brackets. (E.g.: **[File]**, **[CUE]** button, and **[PHONES]** output terminals)
- Please note that the screens and specifications of the software described in this manual as well as the external appearance and specifications of the hardware are currently under development and may differ from the final specifications.
- Please note that depending on the operating system version, web browser settings, etc., operation may differ from the procedures described in this manual.
- Please note that the language of the software screen described in this manual may differ from the actual language.

This manual consists mainly of explanations of functions of this unit as hardware. For detailed instructions on operating rekordbox dj, see the rekordbox software's manual.

## 08 Additional information

Troubleshooting .....	30
Using as a controller for other DJ software.....	32
About trademarks and registered trademarks .....	34
Cautions on copyrights .....	34

## 01 Before start

Features .....	3
What's in the box .....	4
About the AC adapter .....	4

## 02 Installing rekordbox

Minimum operating environment for rekordbox .....	5
Before installing rekordbox.....	5
About the installation procedure .....	6

## 03 Part names and functions

Top panel of unit .....	7
Rear panel .....	12
Front panel .....	12

## 04 Connections

Connecting input terminals.....	13
Connecting output terminals .....	14

## 05 Basic Operation

Connections .....	15
Starting the system.....	16
Quitting the system .....	18

## 06 Advanced Operation

Using the performance pads.....	19
Switching the mixer mode.....	22
Using the slip mode.....	22
Using the fader start function.....	23
Calling out a cue point or loop point stored in a track .....	24
Analyzing tracks.....	24
Using effects .....	24
Using recording functions.....	25
Using external inputs .....	26

## 07 Changing the settings

Launching utilities mode .....	27
Changing the settings with rekordbox.....	27
About the driver software and setting utility software.....	29

# Before start

## Features

This unit is a dedicated controller equipped with interfaces for the intuitive operation of various functions of rekordbox dj. The layout of the various operation interfaces such as "BIGJOG," "PERFORMANCE PADS," and "2-CHANNEL MIXER" which embody the design philosophy of Pioneer DJ professional equipment and the tuning implemented to achieve operation optimal for use in combination with rekordbox dj have facilitated high response performance to allow DJs to perform as they wish. Also, this unit is equipped with dedicated operation interfaces for controlling the "BEAT FX" and "SEQUENCER" functions so that original arrangements can be added to the music being played back. Furthermore, numerous input and output terminals support a variety of DJ styles. Featuring aluminum material for the top panel, the design makes this unit look high quality, which is appropriate in a variety of scenes such as events, home parties, etc.

- rekordbox  
rekordbox is a composite software that enables track management and DJ performances.
- rekordbox dj  
The DJ performance function of rekordbox is called rekordbox dj. Enter the license key shown on the rekordbox dj license key card included with this product to use rekordbox dj.

### BIG JOG & ON JOG INDICATOR

This unit is equipped with a "BIG JOG" that is of the optimum size and operation load for performing fast-forward and fast-reverse operations manually and playing scratch performances. The jog operation information can be sent to a computer more faithfully with low delay thanks to the adoption of an HID as the system for communication with rekordbox, which enables scratch performances with operation that feels even more like operation with analog records. Furthermore, the "ON JOG INDICATOR" positioned at the center allows the DJ to instantly know the deck performance state and mode selection state by lighting colors.

### "MULTI-COLOR PERFORMANCE PADS"

"MULTI-COLOR PERFORMANCE PADS", large rubber pads used to operate functions such as HOT CUE, PAD FX, and SAMPLER, are positioned at the front of the unit.

Music can be arranged by dynamic actions such as beating and rolling. Also, each pad has built-in multi-color illumination so you can instantaneously understand the information required for your performance from the color and lighting state of the pad.

### SAMPLER SEQUENCER

The "SEQUENCER" function that enables recording and playing sampler operation patterns can be intuitively operated from a dedicated operation interface on this unit.

The "SEQUENCER" function and dedicated operation interface can be used to easily create phrases using sampler sounds. Furthermore, a created phrase can be loaded into a deck by pressing the "LOAD" button. Loading a phrase into a deck allows arrangements to be added to music using the various functions of the deck such as scratching and reverse playback to create music performances with even greater originality.

### "BEAT FX" & "RELEASE FX"

BEAT FX which can add an effect linked to the tempo of the track being played and RELEASE FX which can turn off the music sound so that just the effect sound is output are operable from dedicated operation interfaces. This facilitates adding a new accent to music and use for effect sounds when mixing.

### 2-CHANNEL MIXER

This unit incorporates "2-CHANNEL MIXER," which retains the control panel layout of the Pioneer DJM series, the world standard in DJ mixers. A master level meter and channel level meter are each placed at the center of the mixer to allow the DJ to know each level in an instant.

### FLEXIBLE CONNECTIVITY

Two external input systems and one MIC input system are provided to connect to DJ players, analog players, etc.

The audio of external equipment can also be mixed. In addition, two MASTER OUT systems and one BOOTH OUT system are provided to also enable connections to various PA devices.

### NEEDLE SEARCH

Points can be searched for simply by touching the touch pad with a finger. This makes for intuitive, speedy searching with the sense of touching the music directly.

### PLUG AND PLAY USB PORT

A USB sound card is provided to connect this unit to a computer. All of the buttons and controls of this unit are set to be linked with "rekordbox dj" beforehand so that the DJ can begin performances immediately using "rekordbox dj" without having to make troublesome settings after simply connecting to a computer with a USB cable.

### HIGH SOUND QUALITY

The audio output circuitry uses a low-jitter clock and high performance DAC to reproduce the original sound faithfully and achieve clear club sound. In addition, the sound quality technology Pioneer has developed with its professional series is used to achieve the industry's highest level of sound quality for a DJ controller.

### PROFESSIONAL QUALITY DESIGN

Aluminum material on the top panel and jog plate provides a sense of high quality design.

This unit is an essential part of DJ performance in clubs and home party scenes.

---

---

## What's in the box

- AC adapter
- Power cord
- USB cable
- Warranty (for some regions)<sup>[1]</sup>
- Operating Instructions (Quick Start Guide)
- rekordbox dj license key card <sup>[2]</sup>

[1] The warranty is included for European region only.

- For the Japanese region, the corresponding information is provided on the back cover of the "Operating Instructions (Quick Start Guide)".
- For the North American region, the corresponding information is provided on the last page of both the English and French versions of the "Operating Instructions (Quick Start Guide)".

[2] The license key cannot be reissued. Be careful not to lose it.

---

---

## About the AC adapter

---

---

### Safety instructions

To ensure your personal safety and to maximize the full operating potential of your unit, read and follow these safety instructions.

#### Read & Retain Instructions

Read all operating and user information provided with this product.

#### Cleaning

Use a damp cloth to clean the exterior housing. Avoid using any fluids including liquid, aerosol or alcohol-based cleaning products.

#### Water or Moisture

Avoid operating or locating this product near water or other sources of fluid.

#### Accessories

Do not place this product on an unstable cart, stand, or table. The product may fall and be seriously damaged.

#### Ventilation

Do not block or cover this product in use. This unit should not be placed in a built-in installation unless properly ventilated.

#### Environment

Avoid placing this product in a location with exposure to large quantities of dust, high temperatures, high humidity, or subject to excessive vibrations or shocks.

#### Power Sources

Operate this product only from the recommended power sources. If you are unsure of the power source, consult an authorized Pioneer representative.

#### Power-Cord Protection

When unplugging the unit, pull on the plug – not on the cord. Do not handle the cord or plug with wet hands; doing so could cause an electric short or shock. Do not allow anything to pinch or rest on the power cord and do not place in a walkway.

#### Power

Turn OFF the system before installing this or any other hardware device.

#### Overloading

Avoid connecting too many devices to a single wall socket or power source as this can cause fires or short circuits.

#### Object & Liquid Entry

Never push inappropriate objects in to the device. Avoid spilling any liquids in to or on the outside of the drive.

#### Servicing

Opening or removing the cover exposes you to possible electrical shock or other danger. Contact a Pioneer authorized service representative for repairing this product (refer to the enclosed Service & Support Card).

### Damage Requiring Service

Unplug the unit and refer servicing to qualified service personnel in the following situations:

- When the power cord, plug, or chassis is damaged.
- If liquid has been spilled, or objects have fallen into the product.
- If the product has been exposed to rain or water.
- If the product does not operate normally when the operating instructions are followed. Adjust only those controls that are covered by the operating instructions. Improper adjustment of other controls may result in damage and can require extensive work by a qualified technician to restore the unit to its normal operation.
- When the product exhibits a distinct change in performance – this indicates a need for service.

If there are irregularities with the AC adapter or power plug, ask your nearest Pioneer authorized service center or your dealer to carry out repair work.

# Installing rekordbox

rekordbox is a composite software that enables track management and DJ performances.

The DJ performance function of rekordbox is called rekordbox dj. Enter the license key shown on the rekordbox dj license key card included with this product to use rekordbox dj.

## Minimum operating environment for rekordbox

Supported operating systems	CPU and required memory
Mac OS X: 10.11/10.10/10.9 (latest update)	Intel® processor Core™ i3/i5/i7, Intel® processor Core™ 2 Duo 4 GB or more of RAM
Windows: Windows 10/Windows 8.1/Windows 7 (latest service pack) 32-bit version, 64-bit version	Intel® processor Core™ i3/i5/i7, Intel® processor Core™ 2 Duo 4 GB or more of RAM

Others	
USB port	A USB 2.0 port is required to connect the computer with this unit.
Display resolution	Resolution of 1280 x 768 or greater
Internet connection	An Internet connection is required for registering the rekordbox user account and downloading the software.

- For information on the latest system requirements, compatibility, and supported operating systems of rekordbox, see **[System Requirements]** on the rekordbox product site below.  
<http://rekordbox.com/>
- Operation is not guaranteed on all computers, even if all the required operating environment conditions indicated here are fulfilled.
- Depending on the computer's power-saving settings, etc., the CPU and hard disk may not provide sufficient processing capabilities. For notebook computers in particular, make sure the computer is in the proper conditions to provide constant high performance (for example by keeping the AC power connected) when using rekordbox.
- Use of the Internet requires a separate contract with a provider offering Internet services and payment of provider fees.
- Use the latest version/service pack of the operating system.

## Before installing rekordbox

The rekordbox software is not included.

Access the rekordbox.com site and download the software.  
<http://rekordbox.com/>

- The user is responsible for preparing the computer, network devices and other elements of the Internet usage environment required for a connection to the Internet.
- If you are already using rekordbox 4, rekordbox dj can be used by updating the software to the latest version.

## Obtaining the rekordbox software

### 1 Access the rekordbox product site

<https://rekordbox.com/en/store/>

- The page content is subject to change without notice.

### 2 Check the Get Started guide and then click **[Free to Download]**.



### 3 Carefully read the Software End User License Agreement and select the **[Agree]** check box if you agree.

When you select the check box, **[Download]** becomes clickable.

### 4 Click **[Download]**.

Downloading of rekordbox starts.

## Viewing the Operating Instructions of rekordbox

Various instructions are sometimes provided as files in PDF format. Adobe® Reader® must be installed in order to view PDF format files.

### 1 Launch a web browser on the computer and access the rekordbox product site below.

<http://rekordbox.com/>

### 2 Click **[Support]**.

### 3 Click **[Manual]**.

### 4 Click the required language of the manual.

Download as necessary.

- For inquiries on rekordbox, see the rekordbox product site indicated above.

## About the installation procedure

The installation procedure depends on the operating system (OS) on the computer you are using.

Do not connect this unit and the computer until installation is completed.

- If any other programs are running on the computer, quit them.

## Installation procedure (Mac OS X)

1 Unzip the downloaded rekordbox software file.

2 Double-click the unzipped software file to launch the installer.

3 Read the terms of the license agreement carefully, and if you agree, click [Agree].

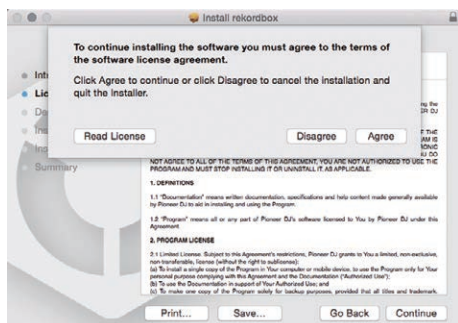

- If you do not agree to the contents of the license agreement, click [Disagree] to quit installation.

4 If the installation completion screen appears, click [Close] to close the rekordbox installer.

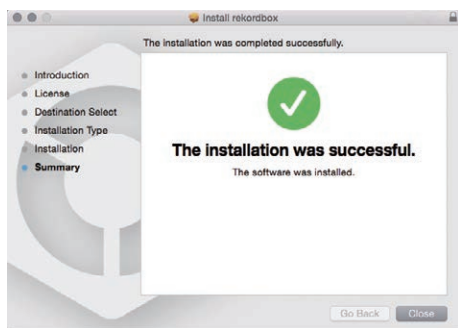

## Installation Procedure (Windows)

- Log on as the user which was set as the computer's administrator before installing.

1 Unzip the downloaded rekordbox software file.

2 Double-click the unzipped software file to launch the installer.

3 Read the terms of the license agreement carefully, and if you agree, select [Agree], then click [Next].

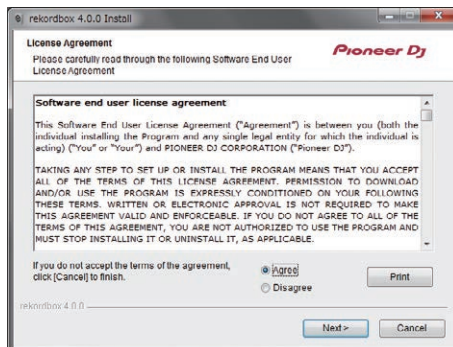

- If you do not agree to the contents of the license agreement, click [Cancel] to cancel installation.
- After the installation destination is specified, the installation starts. The message of successful installation appears once installation is completed.

4 Click [Finish] to quit the rekordbox installer.

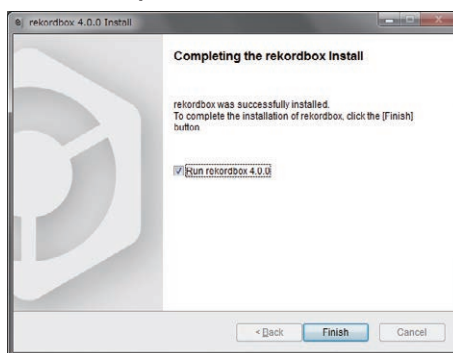

# Part names and functions

## Top panel of unit

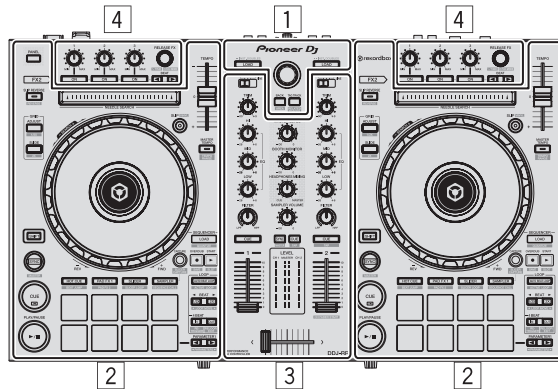

- 1 Browser section
- 2 Deck section
- 3 Mixer section
- 4 Effect section

## Browser section



### 1 LOAD button

Press:

The selected tracks are loaded to the respective decks.

- When the **[LOAD]** button is pressed twice, the tracks loaded in the deck on the opposite side are loaded into the deck on the side that the **[LOAD]** button was pressed. When this is done while a track is playing, the track is played from the same position. (Instant Double)

**[SHIFT]** + press:

Sorts the track list when one of the **[LOAD]** buttons is pressed.

: Sorts by BPM.

: Sorts by artist.

### 2 Rotary selector

Turn:

The cursor moves vertically.

**[SHIFT]** + turn:

Enlarges or reduces the enlarged waveform display of rekordbox dj.

Right turn enlarges the waveform display, and left turn reduces it.

Press:

Moves the cursor between the tree view and track list each time the rotary selector is pressed.

- When the playlist palette is displayed, the cursor moves between playlists in addition to the tree view and track list.
- The tree view, track list, and playlist palette are in the browse section of rekordbox dj. For details on the role of each of them, see the rekordbox Operating Instructions.

### 3 BACK button

Press:

Moves the cursor between the tree view and track list each time the button is pressed.

- When the playlist palette is displayed, the cursor moves between playlists in addition to the tree view and track list.
- The tree view, track list, and playlist palette are in the browse section of rekordbox dj. For details on the role of each of them, see the rekordbox Operating Instructions.

**[SHIFT]** + press:

Switches the display of the browse section of rekordbox dj.

### 4 TAG TRACK button

Press:

Adds tracks to the tag list.

- You can temporarily collect the music files to be played in the rekordbox tag list separately from the playlist.

**[SHIFT]** + press:

Displays the tracks whose BPM and key are similar to those of the track currently being played as the candidate to be played next on the screen.

## Deck section

This section is used to control the four decks. The buttons and controls for operating decks 1 and 3 are located on the left side of the controller, those for operating decks 2 and 4 are located on the right side of the controller.

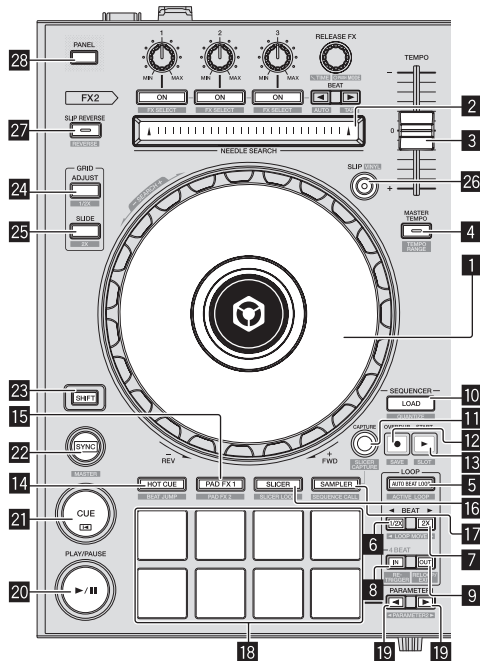

### 1 Jog dial

Turn top:  
When the vinyl mode is on, the scratch operation is possible.

Turn outer section:  
The pitch bend operation (adjustment of the playing speed) is possible.

[SHIFT] + Turn top:  
Skips the playback position.

### 2 NEEDLE SEARCH pad

By touching the pad during pause, you can jump to the desired position in the track loaded in the deck.

- It can jump to the desired position during playback depending on the [Preferences] of rekordbox.

### 3 TEMPO slider

Use this to adjust the track playing speed.

### 4 MASTER TEMPO button

Press:  
Turns the master tempo function on or off.

- When the master tempo function is on, the key does not change even when the audio speed is changed with the [TEMPO] slider. The sound is digitally processed, so the sound quality decreases.

[SHIFT] + press:  
The [TEMPO] slider's range of variation switches each time the button is pressed.

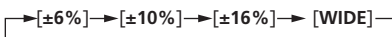

### 5 AUTO BEAT LOOP button

Press:  
Turns the auto beat loop function on and off.

- During loop playback, this operation cancels looping.

[SHIFT] + press:

Switches the loop saved in the track between active and non-active. (Active Loop)

- If you press the button while pressing the [SHIFT] button during playback, the loop set closest to the playback position among the loops saved in the track will be active.
- If you press the button while pressing the [SHIFT] button when a loop saved in the track is called out, the loop will be active or inactive.

### 6 LOOP 1/2X button

Press:  
Selects a beat for auto beat loop.  
Halves the loop playback length.

[SHIFT] + press:  
During loop playback, moves the loop to the left by the amount equal to its length. (Loop Move)

### 7 LOOP 2X button

Press:  
Selects a beat for auto beat loop.  
Doubles the loop playback length.

[SHIFT] + press:  
During loop playback, moves the loop to the right by the amount equal to its length. (Loop Move)

### 8 LOOP IN button

Press:  
Loop In Point is set.  
When this button is pressed during loop playback, the loop in point can be fine-adjusted using the jog dial.

[SHIFT] + press:  
The track returns to the set loop in point and loop playback continues.

Press for over 1 second:  
Turns the auto 4-beat loop on.

### 9 LOOP OUT button

Press:  
The loop out point is set, and loop playback begins.  
When this button is pressed during loop playback, the loop out point can be fine-adjusted using the jog dial.

[SHIFT] + press:  
Cancels loop playback. (Loop Exit)  
After loop playback is canceled, playback returns to the previously set loop in point and loop playback resumes. (Reloop)

### 10 LOAD SEQUENCE button

Press:  
Loads the currently playing sequence into the deck as a track.

[SHIFT] + press:  
Turns the quantize function on.  
For example, when the quantize function is turned on, the point is automatically set to the nearest beat position when a hot cue is set.

- The resolution of the quantized beat can be selected in the [Preferences] of rekordbox.

### 11 CAPTURE button

Press a performance pad while pressing the [CAPTURE] button to load the active loop to the sampler slot.

[SHIFT] + press:  
Loads the sections in the target area of slicer or slicer loop to separate sampler slots.

- For details on slicer and slicer loop, see *Using the Slicer function* on page 20 and the rekordbox Operating Instructions.

### 12 OVERDUB button

Press:  
Turns the sequencer on standby for recording.



Recording operation information (sequence) is started if the sampler is operated when the sequencer is on standby for recording. Press the button again to stop recording.

[SHIFT] + press:

Saves the recorded sequence to the sequencer slot.

### 13 START button

Starts the sequence playback when the sequence recording is stopped.  
Overdubs the new sequence onto the sequence being played back while recording a sequence.

[SHIFT] + press:

Selects the sequencer slot.

### 14 HOT CUE mode button

Sets the hot cue mode.

[SHIFT] + press:

Sets the beat jump mode.

### 15 PAD FX 1 mode button

Sets the pad FX mode 1.

[SHIFT] + press:

Sets the pad FX mode 2.

### 16 SLICER mode button

Sets the slicer mode.

[SHIFT] + press:

Sets the slicer loop mode.

- To cancel the slicer or slicer loop mode, press the [PAD FX 1] mode, [SAMPLER] mode or [HOT CUE] mode button.

### 17 SAMPLER mode button

Sets the sampler mode.

[SHIFT] + press:

Sets the sequence call mode.

### 18 Performance pads

Controls the "hot cue", "pad FX", "slicer", "sampler" and other functions.

➔ *Using the performance pads (p.19)*

### 19 PARAMETER◀ button, PARAMETER▶ button

Sets parameters for the "pad FX", "slicer", "sampler" and other functions.

➔ *Using the performance pads (p.19)*

### 20 PLAY/PAUSE ▶/II button

Use this to play/pause tracks.

### 21 CUE button

Press:

Sets, plays and calls out cue points.

- When the [CUE] button is pressed during pause, the cue point is set.
- When the [CUE] button is pressed during playback, the track returns to the cue point and pauses. (Back Cue)
- When the [CUE] button is pressed and held after the track returns to the cue point, playback continues as long as the button is pressed. (Cue Sampler)
- When the [PLAY/PAUSE ▶/II] button is pressed during Cue Sampler, playback continues from that point.

[SHIFT] + press:

Returns the playback position to the beginning of the track.

### 22 SYNC button

Press:

Synchronizes with the tempos (pitches) and beat grids of the deck set as the master for synchronization automatically.

[SHIFT] + press:

Sets the deck whose button is pressed as the master deck for synchronization.

### 23 SHIFT button

When another button is pressed while pressing the [SHIFT] button, a different function is called out.

### 24 GRID ADJUST button

When the jog dial is turned while pressing the [GRID ADJUST] button, the beat grid interval can be adjusted.

[SHIFT] + press:

The BPM value is divided by 1/2 (doubling the beat grid's spacing).

### 25 GRID SLIDE button

When the jog dial is turned while pressing the [GRID SLIDE] button, the overall beat grid can be slid to the left or right.

[SHIFT] + press:

The BPM value is multiplied by 2 (reducing the beat grid's spacing by 1/2).

### 26 SLIP button

Turns the slip mode on and off.

➔ *Using the slip mode (p.22)*

[SHIFT] + press:

Turns the vinyl mode on and off.

### 27 SLIP REVERSE button

Press:

(During normal operation)

Plays the track in the reverse direction while the [SLIP REVERSE] button is pressed, and resumes normal playback when the button is released.

Slip reverse play is automatically canceled after 8 beats have elapsed even if the [SLIP REVERSE] button is kept pressed. The playback returns to normal after reverting to the background.

(During standby status)

The standby mode is canceled.

- This is limited to the button on the left deck side.

[SHIFT] + press:

Starts reverse playback. When the [SHIFT] and [SLIP REVERSE] buttons are pressed again, reverse playback is canceled and normal playback resumes.

### 28 PANEL button

Displays or hides each panel of rekordbox.

## Mixer section

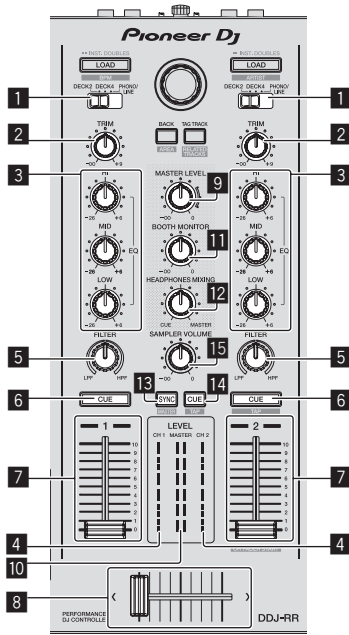

### 1 INPUT SELECT switch

Selects the input source of each channel from the components connected to this unit.

- **[DECK1-4]**: Select this to use the track loaded in the rekordbox deck.
- **[PHONO/LINE]**: Select this to use a line level output device (DJ player, etc.) connected to the **[PHONO/LINE]** input terminals on the rear panel.

### 2 TRIM control

Adjusts the individual channel output gain.

### 3 EQ (HI, MID, LOW) controls

Boosts or cuts frequencies for the different channels.

### 4 Channel Level Indicator

Displays the sound level of the respective channels before passing through the channel faders.

### 5 FILTER control

Applies the filter effect for the respective channel.

The original sound is output when the control is at the center position.

Turn counterclockwise: Gradually descends the low-pass filter's cut-off frequency.

Turn clockwise: Gradually rises the high-pass filter's cutoff frequency.

### 6 Headphones CUE button

Press:

The sound of channels for which the headphones **[CUE]** button is pressed is output to the headphones.

- When the headphones **[CUE]** button is pressed again, monitor output is canceled.

**[SHIFT]** + press:

The track's tempo can be set by tapping the button. (Tap function)

### 7 Channel fader

Move:

Adjusts the level of audio signals output in each channel.

**[SHIFT]** + move:

Use the channel fader start function.

- ➡ *Using the channel fader start function (p. 23)*

### 8 Crossfader

Outputs the sound assigned with the crossfader assign switch.

**[SHIFT]** + move:

Uses the crossfader start function.

- ➡ *Using the crossfader start function (p.23)*

### 9 MASTER LEVEL control

Adjusts the master sound level output.

### 10 Master level indicator

Displays the master output's audio level.

### 11 Booth monitor level control

Adjusts the audio level output from the **[BOOTH]** output terminal.

### 12 HEADPHONES MIXING control

Adjusts the balance of the monitor volume between the sound of the channels for which the headphones **[CUE]** button is pressed and the sound of the master channel.

### 13 SAMPLER SYNC button

Synchronizes the sampler deck's tempo with the master deck's tempo.

- Only a sampler slot with the PLAY mode set to **[Loop]** synchronizes the tempo with the master deck's tempo.

**[SHIFT]** + press:

Sets the sampler deck as the master for synchronization.

### 14 SAMPLER CUE button

Turns monitoring of the sampler deck's sound on or off.

**[SHIFT]** + press:

Sets the sampler deck's tempo by tapping the button.

- Only a sampler slot with the PLAY mode set to **[Loop]** will be the same tempo as the BPM value on the sampler panel.

### 15 SAMPLER VOLUME control

Adjusts the sampler's overall sound level.

## Effect section

The effect units consist of beat FX and release FX.

This section is used to control the two effect units (FX1 and FX2). There are controls and buttons for operating FX1 on the left side of the controller and FX2 on the right side of the controller. Furthermore, which channel to apply an effect can be set by the effect assign buttons in rekordbox.

- For details, see the rekordbox Operating Instructions.

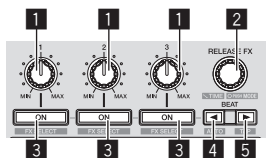

### 1 Effect parameter controls

Adjusts the beat FX parameter.

### 2 RELEASE FX control

Turn:

Switches the types of release FX.

Press:

The release FX is on while the control is pressed.

- If the release FX turns on, the beat FX in the same effect unit turns off.

[SHIFT] + turn:

Adjusts the beat FX time parameter.

[SHIFT] + press:

Switches the beat FX mode.

### 3 Effect parameter buttons

Press:

Turns the beat FX on and off or switches the parameters.

[SHIFT] + press:

Switches the types of beat FX.

### 4 BEAT◀ button

Decreases the beat fraction for synchronizing the beat FX effect sound each time the button is pressed.

[SHIFT] + press:

Sets the beat FX tempo mode to the BPM auto mode. The track's BPM value is used as the basis for the effect's tempo.

### 5 BEAT▶ button

Increases the beat fraction for synchronizing the beat FX effect sound each time the button is pressed.

[SHIFT] + press:

Sets the beat FX tempo mode to the BPM tap mode. The BPM value used as the basis for beat FX is calculated by the interval at which the button is tapped.

## Jog dial display section

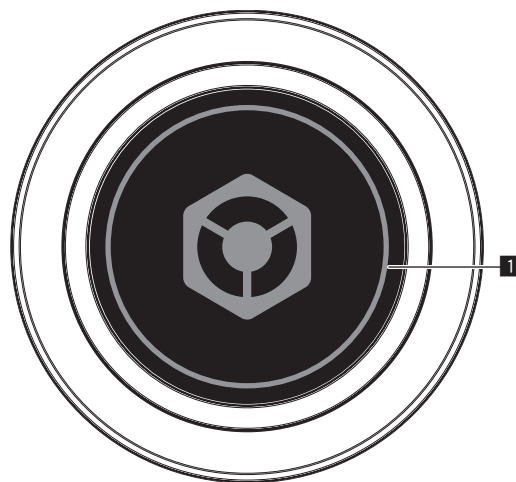

### 1 ON JOG INDICATOR

The display items can be changed on the [Deck] tab in [Preferences] of rekordbox.

The following settings are available.

**Deck selection indication:**

The deck selected with the [INPUT SELECT] switch is indicated by the lighting color of the jog.

- Lit in blue: When [DECK1] or [DECK2] is selected
- Lit in white: When [DECK3] or [DECK4] is selected
- Off: When [PHONO/LINE] is selected

**Hot Cue Countdown indication:**

The jog lights when become near the hot cue position set for the track being played.

The lighting color is the color set for the hot cue.

**Sync indication:**

The jog lights according to the SYNC setting of the deck.

- Lit in orange: When the deck is **MASTER**
- Lit in white: When the deck is **SYNC**
- Off: When the deck is neither **MASTER** nor **SYNC**

**Slip mode indication:**

The jog lights according to the slip mode state.

- Flashing in red: When the slip mode is on and slip playback
- Lit in red: When the slip mode is on and not slip playback
- Off: When the slip mode is off

**On Air indication:**

The jog lights according to the On Air state.

- Lit in red: When On Air state
- Off: When not On Air state

**Vinyl indication:**

The jog lights according to the [VINYL] mode state.

- Lit in blue: When the [VINYL] mode is on
- Off: When the [VINYL] mode is off

## Rear panel

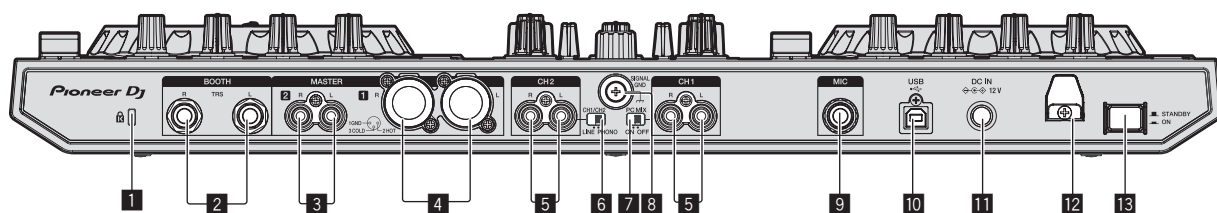

### 1 Kensington security slot

### 2 BOOTH output terminal

These are the output terminals for a booth monitor. Compatible with balanced or unbalanced output for 1/4" TRS connectors.

The master channel sound can be output from the [BOOTH] output terminals regardless of the audio level set for the master channel.

- The sound will be distorted if the level is raised too high when using unbalanced outputs.
- The booth monitor output is set to output the microphone sound by default. It is possible to set not to output the microphone sound in [Preferences] of rekordbox.

### 3 MASTER 2 terminals

Connect to a power amplifier, etc.

- Compatible with RCA pin-jack type unbalanced outputs.

### 4 MASTER 1 terminals

Connect powered speakers, etc., here.

- Compatible with XLR connector type balanced outputs.

### 5 PHONO/LINE input terminals

Connect a phono level (for MM cartridges) output device (analog player, etc.) or a line level output device (DJ player, etc.). Switch the input source according to the connected device using the [LINE/PHONO] switch on this unit's rear panel.

### 6 LINE/PHONO switch

Selects the input source of each channel from the components connected to this unit.

- [PHONO]: Select this to use a phono level (for MM cartridges) output device (analog player, etc.) connected to the [PHONO/LINE] input terminals.
- [LINE]: Select this to use a line level output device (DJ player, etc.) connected to the [PHONO/LINE] input terminals.

- Different input sources cannot be selected for both channels.

### 7 PC MIX switch

Switch the audio route of the external device connected to the [PHONO/LINE] input terminal or [MIC] input terminal of this device.

➔ *Using external inputs* (p.26)

### 8 SIGNAL GND terminal

Connects an analog player's ground wire here. This helps reduce noise when the analog player is connected.

### 9 MIC input terminal

Connects a microphone here. Compatible with a 1/4" TS jack.

### 10 USB terminal

Connect to a computer.

- Connect this unit and the computer directly using the included USB cable.
- A USB hub cannot be used.

### 11 DC IN terminal

Connect to a power outlet using the included AC adapter (with the included power cord connected).

- Connect the AC adapter after all the connections between devices have been completed.
- Only use the included AC adapter.

### 12 Cord hook

Catch the AC adapter's power cord and USB cable on this hook when using this unit.

- The sound will be interrupted if the AC adapter or USB cable is disconnected during playback.

### 13 STANDBY/ON switch

This switches this unit's power between on and standby.

## Front panel

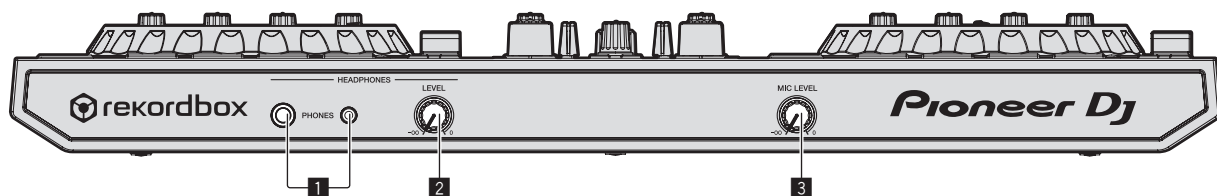

### 1 PHONES output terminals

Connect headphones here.

Compatible with a 1/4" TRS jack and 3.5 mm stereo mini jack.

- There are two input jacks, both a stereo phones jack and a mini phones jack, but do not use both simultaneously. If both are used simultaneously, when one is disconnected and/or connected, the volume of the other may increase or decrease suddenly.

### 2 HEADPHONES LEVEL control

Adjusts the level of audio output from the [PHONES] output terminals.

### 3 MIC LEVEL control

Adjusts the level of audio input to the [MIC] input terminals.

# Connections

- Connect the power cord after all the connections between devices have been completed.  
Be sure to set the unit to standby mode and unplug the power cord from the power outlet before making or changing connections between devices.
- Be sure to use the power cord and AC adapter included with this product.
- Power to this unit is supplied by the AC adapter or by USB bus power. Even without connecting the AC adapter, you can perform operation simply by connecting this unit to a computer using a USB cable.

- Do not pull out the AC adapter during operation. If the AC adapter is pulled out, this unit restarts by using USB bus power.
- Connect this unit and the computer directly using the included USB cable.
- A USB hub cannot be used.
- Refer to the operating instructions for the component to be connected.

## Notes on running this unit with USB bus power

- Function restrictions, such a reduction in the output level and reduction in the LED brightness, may apply depending on the computer used. In such a case, use the included AC adapter.

## Connecting input terminals

### Rear panel

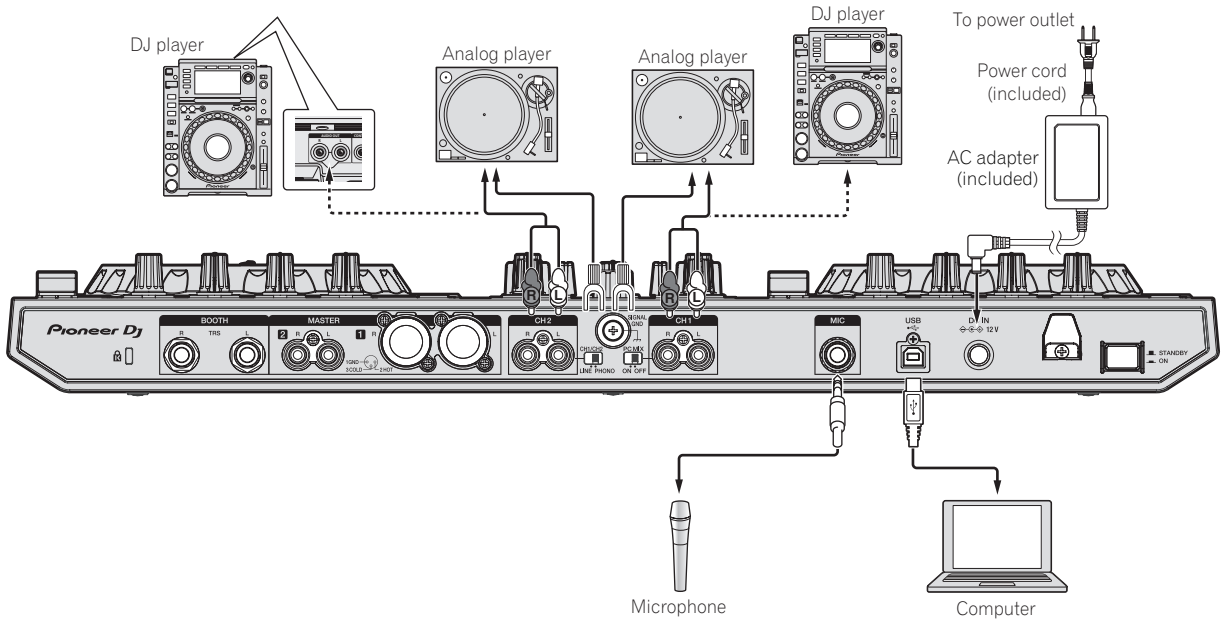

### Cord hook

#### Hook the USB cable in the top of the cord hook, the AC adapter's power cord in the bottom.

Fasten the AC adapter's power cord and USB cable in place by hooking them on the cord hook. This prevents the power cord and USB cable from being accidentally pulled and the plugs from being disconnected from the terminals.

- Do not fasten with the base of the AC adapter's power cord bent. If used continuously under these conditions, the power cord may be damaged, resulting in faulty contact.
- The sound will be interrupted if the AC adapter or USB cable is disconnected during playback.

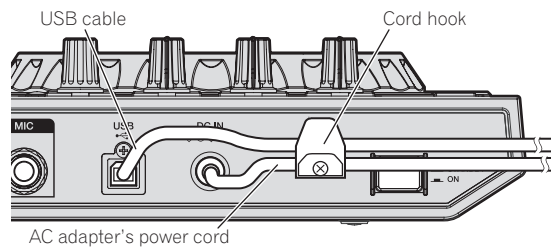

# Connecting output terminals

## Rear panel

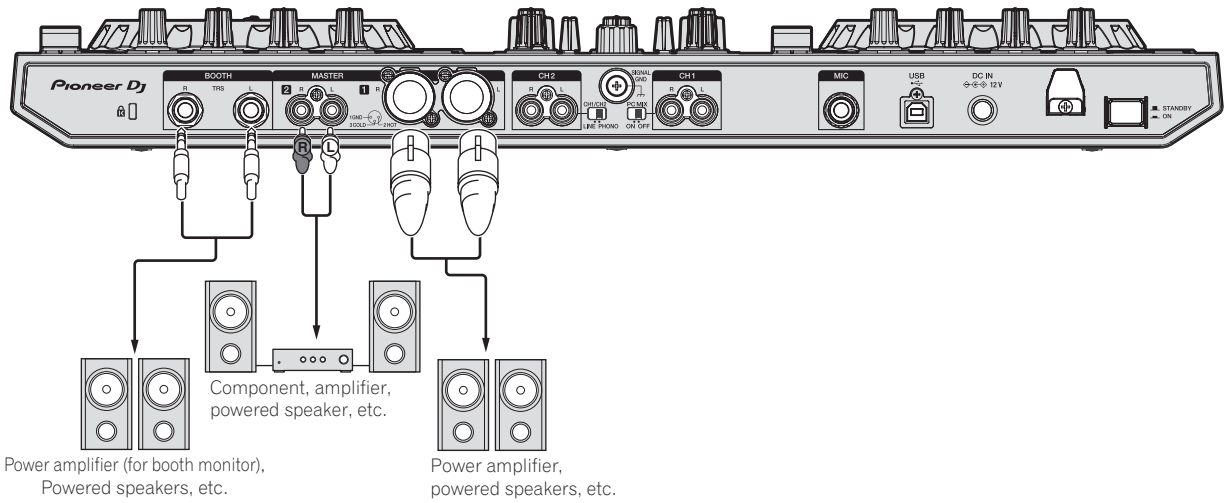

## Front panel

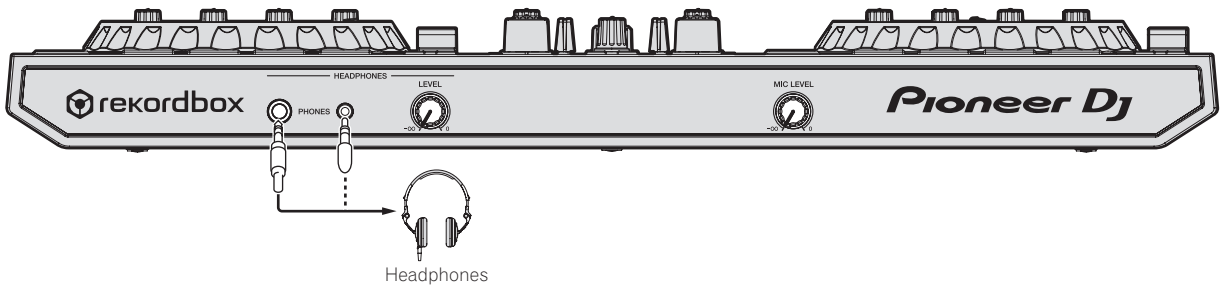

# Basic Operation

## Connections

### 1 Connect headphones to one of the [PHONES] output terminals.

Connect headphones with an impedance of  $32\ \Omega$  or higher. Headphones with an impedance less than  $32\ \Omega$  are not supported.

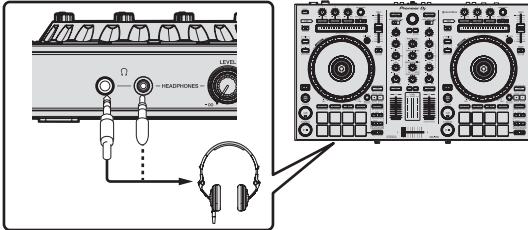

### 2 Connect devices such as powered speakers, a power amplifier, and components to the [MASTER 1] or [MASTER 2] output terminals.

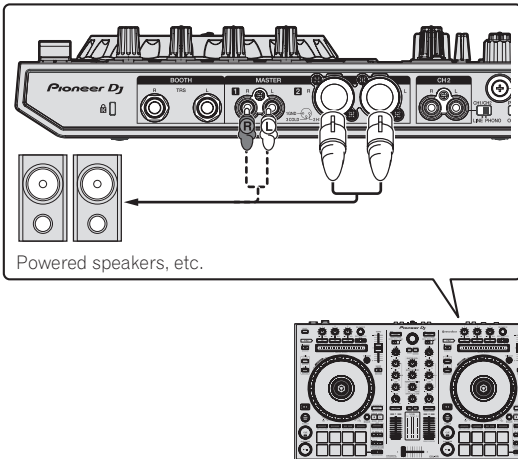

- To output the sound from the [BOOTH] output terminals, connect devices such as speakers to the [BOOTH] output terminals.

### 3 Connect this unit to your computer via a USB cable.

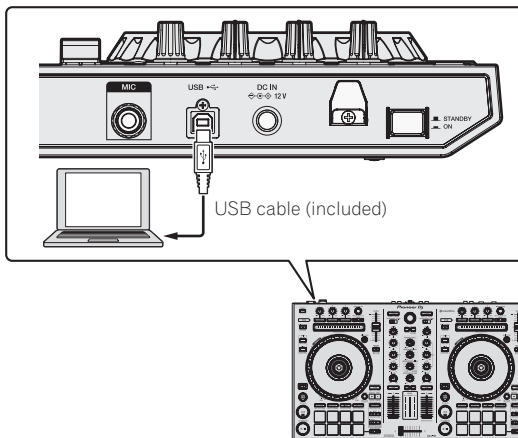

### 4 Turn on the computer's power.

### 5 Connect the AC adapter.

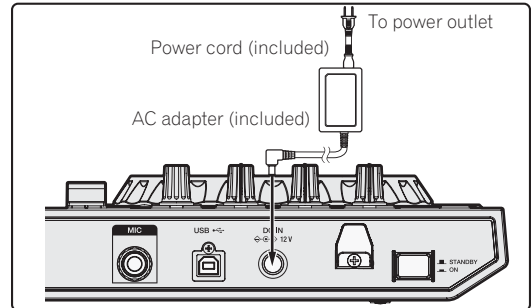

### 6 Press the [STANDBY/ON] switch on this unit's rear panel to turn this unit's power on.

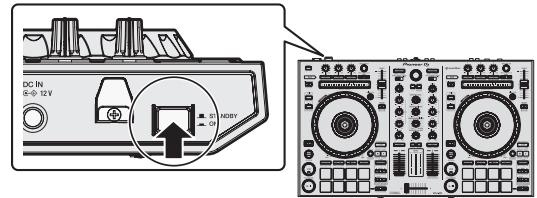

Turn on the power of this unit.

- For Windows users  
The message [Installing device driver software] may appear when this unit is first connected to the computer or when it is connected to a different USB port on the computer. Wait a while until the message [Your devices are ready for use] appears.

### 7 Turn on the power of the devices connected to the output terminals (powered speakers, power amplifier, components, etc.).

- When a microphone, DJ player or other external device is connected to input terminals, the power of that device also turns on.

# Starting the system

## Launching rekordbox

This manual consists mainly of explanations of functions of this unit as hardware. For detailed instructions on operating rekordbox dj, see the rekordbox software's manual.

When the rekordbox software is started up for the first time, enter the rekordbox dj license key and activate the software. Prepare the rekordbox dj license key included with this unit.

- There is no need for this product's users to purchase the rekordbox dj license key separately.

### 1 Click the [rekordbox] icon.

- For Mac OS X  
Open the [Applications] folder in Finder, then click the [rekordbox] icon.
- For Windows 10/8.1  
From [Apps view], click the [rekordbox] icon.
- For Windows 7  
From the Windows [Start] menu, click the [rekordbox X.X.X] icon under [All Programs] > [Pioneer] > [rekordbox X.X.X].

### 2 Enter the account information.

If you already have an account, enter the account information and then click [Setup].

If you do not have an account, click [Create an account] to go to the web page for creating an account and then create an account.

- For details on the account creation procedure, access the rekordbox product site below and see the rekordbox Operating Instructions in [Support].  
<http://rekordbox.com/>

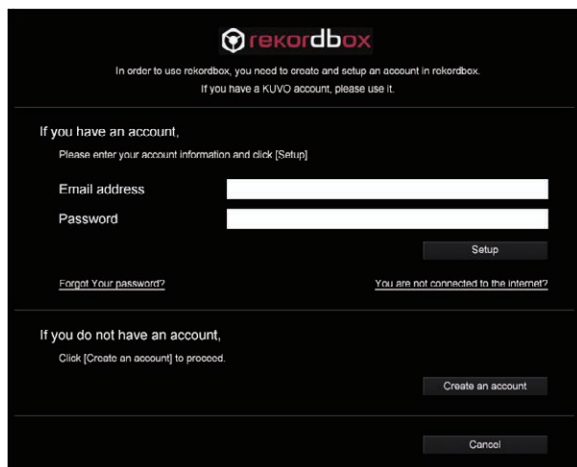

### 3 Select the usage method.

Click the [DJ performance] icon.

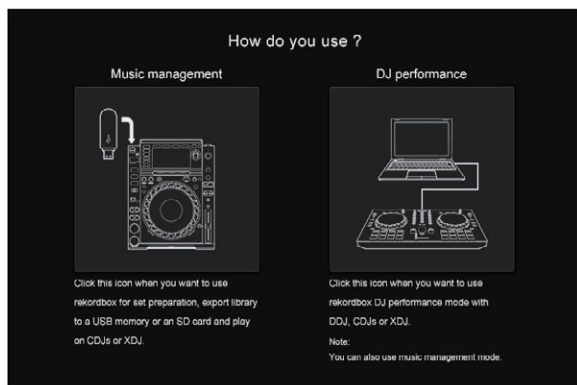

### 4 Enter the license key and activate the software.

Enter the license key shown on the rekordbox dj license key card included with this product and activate the software following the instructions on the screen.

- For details on the activation work procedure, access the rekordbox product site below and see the rekordbox operating instructions in [Support].  
<http://rekordbox.com/>

## Installing the driver software

This driver software is an exclusive driver for outputting audio signals from the computer.

### Select [DDJ-RR] from the pull-down menu and click [Install] in the audio driver installation screen.

- The USB cable needs to be disconnected from your computer at the time of installation.
- After installation completes, reconnect this unit and computer with the USB cable.

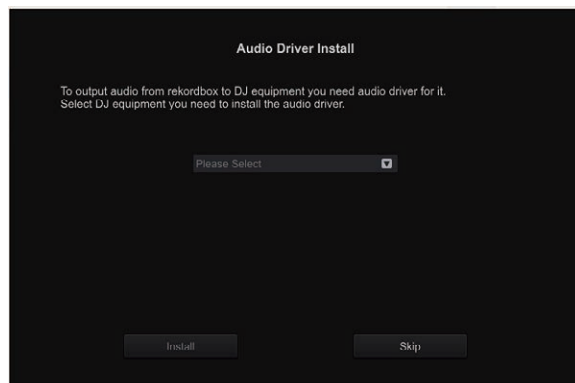

Install the audio driver following the instructions on the screen.

- Carefully read *Software end user license agreement* (page 32).

### ❖ Installation procedure (Mac OS X)

Do not connect this unit and the computer until installation is completed.

- If any other programs are running on the computer, quit them.

### 1 Check the details on the screen and click [Continue Anyway].

### 2 When the end user license agreement appears, read *Software end user license agreement* carefully, then click [Continue Anyway].

- If you do not consent to the provisions of the *Software end user license agreement*, click [Disagree] and stop installation.

### 3 Proceed with installation according to the instructions on the screen.



## ❖ Installation procedure (Windows)

Do not connect this unit and the computer until installation is completed.

- Log on as the user which was set as the computer's administrator before installing.
- If any other programs are running on the computer, quit them.

**1 Check the details on the screen and click [Continue Anyway].**

**2 Carefully read the *Software end user license agreement* and if you consent to the provisions, put a check mark in [I agree.] and click [OK].**

- If you do not consent to the provisions of the *Software end user license agreement*, click [Cancel] and stop installation.

**3 Proceed with installation according to the instructions on the screen.**

- If [Windows Security] appears on the screen while the installation is in progress, click [Install this driver software anyway] and continue with the installation.  
When the installation program is completed, a completion message appears.

## Confirm the sending of rekordbox customer usage conditions

You are asked to send usage conditions for the purpose of improving the quality and specifications of rekordbox.

Click [Yes] if you agree to the sending of usage conditions and [No] if you do not agree.

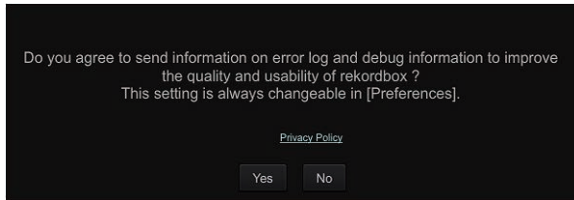

## Set the audio

Start rekordbox to display [Select Speaker] while this unit is connected. Select one of the options to match your audio environment and then click [OK].

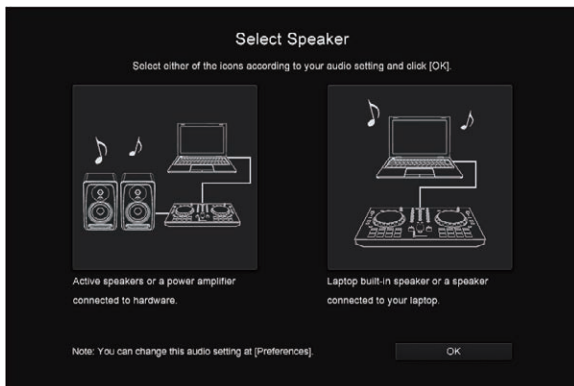

## Adding music files to [Collection]

[Collection] is a screen for displaying a list of the music files managed by rekordbox.

Registering the music files on the computer as the music collection of rekordbox and then analyzing them enables those tracks to be used with rekordbox.

**1 Click [Collection] in the tree view.**

A list of the tracks registered in [Collection] is displayed.

**2 Open Finder or Windows explorer, then drag and drop music files or folders including music files to the track list.**

The music files are added to the collection, and the waveform information analysis of the music files starts. Wait until the analysis of all the music files are finished.



## Loading a track into the deck

The following describes the procedure for loading tracks into deck 1 as an example.

**1 Turn the rotary selector to select a track in [Collection].**

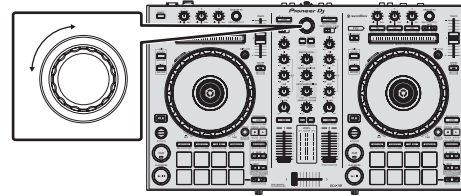

**2 Press the [LOAD] button of the left deck.**

The track is loaded into the deck.

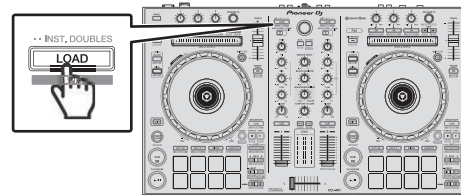

## Playing tracks and outputting the sound

The following describes the procedure for outputting the sound of deck 1 as an example.

- Set the volume of the devices (power amplifier, powered speakers, etc.) connected to the [MASTER 1] and [MASTER 2] output terminals to an appropriate level. Note that very loud sound will be output if the volume is set too high.

**1 Set the positions of the controls, etc., as shown below.**

Names of controls, etc.	Position
MASTER LEVEL control	Turned fully counterclockwise
TRIM control	Turned fully counterclockwise
EQ (HI, MID, LOW) controls	Center
FILTER control	Center
Channel fader	Moved forward
INPUT SELECT switch	[DECK1] position

2 Press the [PLAY/PAUSE▶/II] button to play the track.

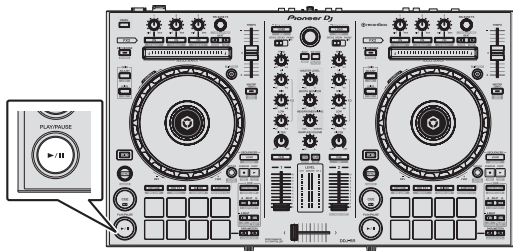

3 Move the channel fader away from you.

4 Turn the [TRIM] control.

Adjust [TRIM] so that the orange indicator on the channel level indicator lights at the peak level.

5 Turn the [MASTER LEVEL] control to adjust the audio level of the speakers.

Adjust the sound level output from the [MASTER 1] and [MASTER 2] terminals to an appropriate level.

- Sound is output from the speakers according to your audio environment.

---

## Monitoring sound with headphones

Set the positions of the controls, etc., as shown below.

Names of controls, etc.	Position
HEADPHONES MIXING control	Center
HEADPHONES LEVEL control	Turned fully counterclockwise

1 Press the headphones [CUE] button for the channel 1.

2 Turn the [HEADPHONES LEVEL] control.

Adjust the sound level output from the headphones to an appropriate level.

---

## Quitting the system

1 Quit rekordbox.

2 Press the [STANDBY/ON] switch on this unit's rear panel to set this unit's power to standby.

3 Disconnect the USB cable from your computer.

# Advanced Operation

The descriptions from this point on are for functions that are specific for when this unit and rekordbox dj are used in combination and are not described in the rekordbox Operating Instructions.

## Using the performance pads

Use the pad mode buttons ([HOT CUE] mode button, [PAD FX 1] mode button, [SLICER] mode button and [SAMPLER] mode button) to switch the functions.

## Using hot cues

Playback can be started instantaneously from the position at which a hot cue is set. In addition to hot cues, loops can be set and called out instantaneously.

- Up to eight hot cue points can be set and saved per track.

### ❖ Setting and calling out a hot cue

#### 1 Press the [HOT CUE] mode button.

Switches to hot cue mode.

#### 2 In the play or pause mode, press a performance pad to set the hot cue point.

The hot cue points are assigned to the respective performance pads as shown below.

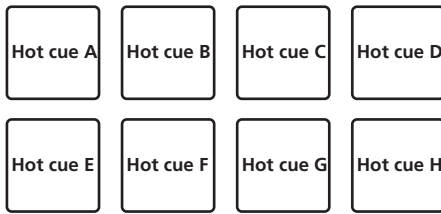

#### 3 Press the performance pad at which the hot cue point was set.

Playback starts from the hot cue point.

- Set hot cue points can be cleared by pressing a performance pad while pressing the [SHIFT] button.

### ❖ Setting and calling out an auto beat loop

#### 1 Press the [HOT CUE] mode button.

Switches to hot cue mode.

#### 2 Press the [LOOP 1/2X] or [LOOP 2X] button.

Selects a beat for auto beat loop.

#### 3 Press the [AUTO BEAT LOOP] button during playback.

A loop with the specified number of beats is set and loop playback starts.

#### 4 Press the performance pad to set a loop during loop playback.

#### 5 Press the performance pad at which the loop is set.

Loop playback starts from the loop in point of the set loop.

- The set loop can be cleared by pressing the performance pad while pressing the [SHIFT] button.

### ❖ Setting and calling out a manual loop

#### 1 Press the [HOT CUE] mode button.

Switches to hot cue mode.

#### 2 Press the [LOOP IN] button during playback, and then press the [LOOP OUT] button.

Loop playback starts.

#### 3 Press the performance pad to set a loop during loop playback.

#### 4 Press the performance pad at which the loop is set.

Loop playback starts from the loop in point of the set loop.

- The set loop can be cleared by pressing the performance pad while pressing the [SHIFT] button.

## Using the pad FX

A wide range of effect performances are possible with just the simple operation of pressing and releasing performance pads.

#### 1 Press the [PAD FX 1] mode button.

The mode switches to pad FX mode 1.

Effects are assigned to the performance pads as shown below.

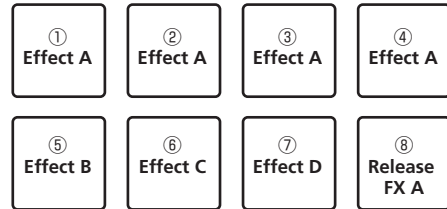

- If the [PAD FX 1] mode button is pressed while pressing the [SHIFT] button, the mode changes to pad FX mode 2.

Effects are assigned to the performance pads as shown below.

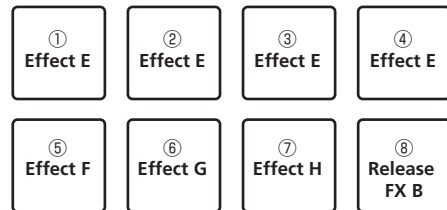

- Effects assigned to the performance pads can be customized (effects applied to pad 1 are also applied to the pads 2 to 4). For details, see the rekordbox Operating Instructions.
- The type of release FX assigned to pad 8 cannot be changed by turning the unit's [RELEASE FX] control. To change the release FX type assigned to pad 8, use rekordbox dj. For details, see the rekordbox Operating Instructions.

#### 2 Press and hold one of the performance pads.

The effect turns on according to the effect and number of beats settings assigned to the pad that was pressed.

#### 3 Press the [PARAMETER ◀] button or [PARAMETER ▶] button while pressing the performance pad.

The number of beats setting for the effect temporarily increases or decreases.

- Depending on the type of effect, changing the setting may not be possible even by pressing the button.

#### 4 Release your finger from the performance pad.

The effect turns off.

### ❖ Using the release FX of the pad FX

#### 1 Press and hold one of performance pads 1 to 7.

The effect turns on according to the effect and number of beats settings assigned to the pad that was pressed.

## 2 Press performance pad 8.

The pad FX effect that was on up until now turns off and the release FX effect is added.

---

## Using the Slicer function

The specified range is divided into eight equal sections, and these eight sliced sections are assigned to the respective performance pads. While one of the performance pads is pressed, the sound for the section assigned to that pad is played in a loop.

During loop playback of the pad's sound, normal playback with the original rhythm continues in the background. When the pad is released and loop playback ends, playback resumes from the position reached at that point.

### 1 Press the [SLICER] mode button.

Switches to slicer mode.

- While pressing the [SHIFT] button, pressing the [SLICER] mode button switches the mode to slicer loop mode.
  - ➔ *About slicer mode and slicer loop mode (p.20)*

### 2 Press the [PARAMETER◀] or [PARAMETER▶] button while pressing the [SHIFT] button.

Set the slicer's "SLICE LENGTH".

The setting value of SLICE LENGTH changes each time the button is pressed while pressing the [SHIFT] button.

Equally-divided eight sections of the range specified with "SLICE LENGTH" are assigned to the respective performance pads as shown below.

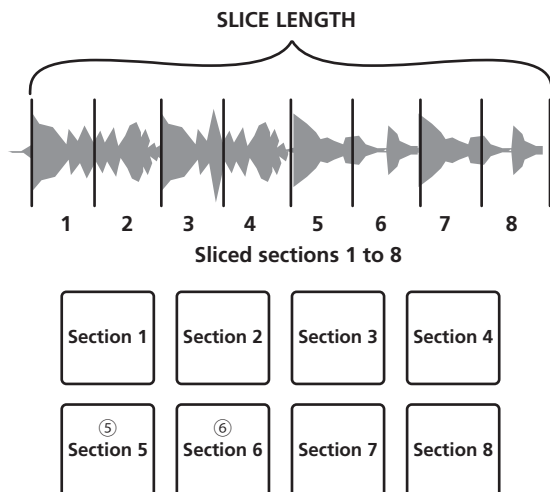

### 3 Press the [PARAMETER◀] or [PARAMETER▶] button.

Set slicer's "SLICE ROLL". The setting value of SLICE ROLL changes each time the button is pressed.

The loop playback length while the pad is pressed can be changed with the "SLICE ROLL" setting. For example, when "1/4" is set to "SLICE ROLL", only the first quarter of the section assigned to the pad is played in a loop.

### 4 Press pad 5 or pad 6 while pressing the [SHIFT] button.

If pad 5 is pressed while pressing the [SHIFT] button, the slicer's target area moves to the left.

Also, if pad 6 is pressed while pressing the [SHIFT] button, the slicer's target area moves to the right (slice shift).

### 5 Press and hold one of the performance pads.

When the pad is pressed and held, the sound is played in a loop.

- The loop playback length differs depending on the "SLICE ROLL" setting.
- When the pad is released, the track returns to the position that is playing in the background.

## ❖ About slicer mode and slicer loop mode

### Slicer mode

When the playback position advances to the end of the range that has been sliced into eight equal sections, the range shown on the display switches to the next eight sliced sections, and these sliced sections are assigned to the respective pads, replacing the previously assigned sections.

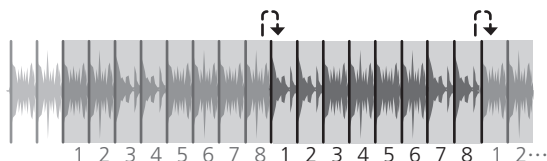

### Slicer loop mode

When the playback position advances to the end of the range that was sliced into eight equal parts, the playback position returns to the beginning of the range that was sliced into eight equal parts.

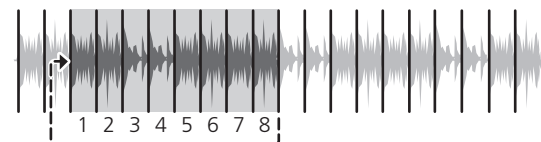

---

## Using the sampler function

This procedure can be used to play tracks loaded in the sampler's sampler slots using the performance pads.

## ❖ Preparing to use the sampler

### Press the [PANEL] button.

The [PANEL] button switches the panel displayed on the screen of rekordbox dj, so press it until the sampler panel appears.

A track, loop, and slicer target area can be loaded in sampler slots.

## ❖ Load the track in a sampler slot.

### 1 Press the [SAMPLER] mode button.

Switches to the sampler mode.

### 2 Press the rotary selector or [BACK] button to move the cursor to the track list.

### 3 Turn the rotary selector.

Select the track you wish to load in a sampler slot.

### 4 Press the performance pad while pressing the [SHIFT] button.

The selected track is loaded into the sample slot.

- Loading by overwriting an already loaded sampler slot may not be possible depending on the [Preferences] of rekordbox.

## ❖ Loading a loop in a sampler slot.

### 1 Press the [AUTO BEAT LOOP] button, or press the [LOOP IN] button and then the [LOOP OUT] button during track playback.

Loop playback starts.

### 2 Press a performance pad while pressing the [CAPTURE] button.

The pad mode is temporarily switched to the sampler mode and the loop is loaded in a sampler slot.

- Loading by overwriting an already loaded sampler slot may not be possible depending on the [Preferences] of rekordbox.

## ❖ Loading the slicer target area in sampler slots

### 1 Press the [SLICER] mode button while pressing the [SHIFT] button during track playback.

The mode switches to the slicer loop mode.

- Alternatively, press the [SLICER] mode button to switch to the slicer mode.

### 2 Press the [CAPTURE] button while pressing the [SHIFT] button.

Each of the sections of the slicer target area is loaded in a separate sampler slot.

- It is loaded to the sampler bank 4 by default.  
If there is even one sampler slot already loaded in sampler bank 4, loading may not be possible.

## ❖ Using the performance pads to play the sampler

### 1 Press the [SAMPLER] mode button.

Switches to the sampler mode.

### 2 Press the [PARAMETER◀] or [PARAMETER▶] button.

The sampler bank is switched. The sampler has four banks and each bank has sixteen slots.

### 3 Move the [SAMPLER VOLUME] fader to the far side.

### 4 Press a performance pad.

The sound for the slot assigned to the pad that was pressed is played.

- When the pad mode of deck 1 or deck 3 is the sampler mode, sampler slots are assigned to the respective performance pads as shown below. (The slots in parentheses are for when the pad mode of deck 2 or deck 4 is the sampler mode)

Slot 1 (slot 9)	Slot 2 (slot 10)	Slot 3 (slot 11)	Slot 4 (slot 12)
Slot 5 (slot 13)	Slot 6 (slot 14)	Slot 7 (slot 15)	Slot 8 (slot 16)

### 5 During playback, press a performance pad.

Playback continues by returning to the beginning.

### 6 Press a performance pad while pressing the [SHIFT] button during playback.

The sound of the slot that is currently playing stops.

## Using beat jump

The playback position can be moved instantaneously without breaking the rhythm of the track being played back.

### 1 Press the [HOT CUE] mode button while pressing the [SHIFT] button.

The mode switches to the beat jump mode.

### 2 Press the [PARAMETER◀] or [PARAMETER▶] button.

The movement amount (number of beats or number of bars) of the playback position assigned to the performance pad changes each time a button is pressed.

The following nine settings can be made. (The operations are the same as when the left/right buttons of [page\*] on the track deck screen are clicked.)

page1	FINE/1/8 beat/1/4 beat/1/2 beat
page2	1/8 beat/1/4 beat/1/2 beat/1 beat
page3	1/4 beat/1/2 beat/1 beat/2 beats
page4	1/2 beat/1 beat/2 beats/4 beats
page5	1 beat/2 beats/4 beats/8 beats
page6	2 beats/4 beats/8 beats/16 beats

page7	4 beats/8 beats/16 beats/8 bars
page8	8 beats/16 beats/8 bars/16 bars
page9	16 beats/8 bars/16 bars/32 bars

For example, when set to "1 beat from 1/8 beat", the pad's setting is as shown below.

① 1/8 beat (left direction)	② 1/8 beat (right direction)	③ 1/4 beat (left direction)	④ 1/4 beat (right direction)
⑤ 1/2 beat (left direction)	⑥ 1/2 beat (right direction)	⑦ 1 beat (left direction)	⑧ 1 beat (right direction)

### 3 Press the [PARAMETER◀] or [PARAMETER▶] button while pressing the [SHIFT] button.

The amount of movement (number of beats or number of bars) of the playback position assigned to the performance pad changes each time the [PARAMETER◀] or [PARAMETER▶] button is pressed while pressing the [SHIFT] button.

The following three settings can be made.

page1	FINE/1/8 beat/1/4 beat/1/2 beat
page5	1 beat/2 beats/4 beats/8 beats
page9	16 beats/8 bars/16 bars/32 bars

### 4 Press pad 1, pad 3, pad 5, or pad 7.

The playback position moves to the left by the number of beats or number of bars assigned to the pressed pad.

### 5 Press pad 2, pad 4, pad 6, or pad 8.

The playback position moves to the right by the number of beats or number of bars assigned to the pressed pad.

## Using the sequencer

Sampler performances can be recorded and played back.

The sequencer function can be used to achieve a variety of performances, such as superimposing an original rhythm loop or vocal loop created in advance on the track that is playing or changing the arrangement of an impromptu finger drum performance by adding sound using the overdund recording function or removing and adding sound using the mute function.

The following describes the basic operations of the sequencer. For sequencer application examples, see the rekordbox Operating Instructions.

## ❖ Preparing to use the sequencer

### 1 Press the [PANEL] button.

The [PANEL] button switches the panel displayed on the screen of rekordbox dj, so press it until the sampler panel appears.

### 2 Press the [SAMPLER] mode button.

The unit's pad mode switches to the sampler mode.

## ❖ Recording a sequence

### 1 Press the [PARAMETER◀] or [PARAMETER▶] button.

Select the bank of the sampler to be used for the performance.

### 2 Press the [START] button while pressing the [SHIFT] button.

Select the slot to save the sequence to.

### 3 Click the part indicated as [1 Bar] on the sampler panel of rekordbox dj.

Select a length for recording the sequence from 1 bar, 2 bars, and 4 bars in the pull-down menu that appears.

#### 4 Press the [OVERDUB] button.

The sequencer switches to the recording standby state.

#### 5 Create a performance using the performance pads.

Recording of the sequence begins.

- Only a sampler slot with the PLAY mode of the sampler set to [One Shot] can record a sequence.
- When [QUANTIZE] of the sampler panel is on, the operation timing of the performance pads is quantized and the sequence is recorded.

#### 6 Press the [OVERDUB] button while pressing the [SHIFT] button.

The recorded sequence is saved.

### ❖ Calling out and playing a saved sequence

#### 1 Press the [START] button while pressing the [SHIFT] button.

Select the sequence you wish to call out.

#### 2 Press the [START] button.

The sequence plays.

- If the [START] button is pressed again, the sequence stops.

### ❖ Using the sequence mute mode

In the sequence mute mode, you can control mute for each sampler slot with a performance pad.

This enables you to remove and add a kick, snare, or other drum sound to change the arrangement for a rhythm loop created with the sequencer.

#### 1 Call out and play a sequence.

➡ *Calling out and playing a saved sequence (p. 22)*

#### 2 Press and hold the [PARAMETER◀] button.

rekordbox dj remains in the sequence mute mode while the [PARAMETER◀] button is pressed.

- If the [PARAMETER◀] button is released, the sequence mute mode is canceled.

#### 3 Press a performance pad.

The sound of the slot assigned to the pad that was pressed is muted.

- If the same pad is pressed again, mute is canceled.

### ❖ Using the sequence erase mode

In the sequence erase mode, you can erase sequences on a sampler slot basis.

#### 1 Call out and play a sequence.

➡ *Calling out and playing a saved sequence (p. 22)*

#### 2 Press and hold the [PARAMETER▶] button.

rekordbox dj remains in the sequence erase mode while the [PARAMETER▶] button is pressed.

- If the [PARAMETER▶] button is released, the sequence erase mode is canceled.

#### 3 Press a performance pad.

The sequence of only the slot assigned to the pad that was pressed is erased.

### ❖ Loading a sequence into the deck

The sequence being played can be loaded into the deck to enable a DJ performance using the same deck operations as when a track is loaded.

#### 1 Start recording a sequence or call and play a saved sequence

➡ *Recording a sequence (p.21)*

➡ *Calling out and playing a saved sequence (p.22)*

#### 2 Press the [LOAD SEQUENCE] button.

The sequence being recorded or played is loaded into the deck.

---

## Using sequence calling

Up to eight saved sequences can be called and played directly from a pad.

#### 1 Press the [SAMPLER] mode button while pressing the [SHIFT] button.

The mode switches to the sequence call mode.

#### 2 Press a performance pad.

The sequence saved to the pressed pad plays.

The eight sequences are the same for the left and right pads.

For details on saving sequences, see *Recording a sequence* on page 21.

#### 3 During playback, press a performance pad.

Playback continues by returning to the beginning of the sequence.

#### 4 Press a performance pad while pressing the [SHIFT] button during playback.

The playing sequence stops.

---

## Switching the mixer mode

This unit can be switched to 2-channel mixer mode or 4-channel mixer mode in the setting items of rekordbox.

➡ *Changing the settings with rekordbox (p.27)*

### 2-channel mixer mode

This is a mode for fixing the mixer function to 2 channels to match the buttons and controls on this unit.

Preparing the next track to be played in advance enables a performance with quick switching to target tracks.

### 4-channel mixer mode

This is a mode for using the mixer functions with 4 channels to match rekordbox dj.

Up to four mixes are possible so you can create music mixes and performances with even greater originality.

- The software takeover function operates for the mixer function in 4-channel mixer mode.

---

## Using the slip mode

When the slip mode is turned on, normal playback with the original rhythm continues in the background during scratching, looping and hot cue playback. When scratching, looping or hot cue playback is canceled, normal playback resumes from the position reached up to the point at which the operation was canceled.

Various performances can be achieved without breaking the rhythm.

- By default, the [SLIP] button lights when you switch to the slip mode and flashes while playback is continuing in the background.

---

## Slip hot cue

#### 1 Press the [HOT CUE] mode button.

Set the hot cue mode.

#### 2 Set the hot cue.

Press a performance pad to set the hot cue.

#### 3 Press the [SLIP] button.

The mode switches to the slip mode.

#### 4 During playback, press and hold a performance pad.

Playback starts from the position at which the hot cue was set. Playback continues as long as the performance pad is pressed.

Normal playback continues in the background even while the hot cue is playing.

#### 5 Release your finger from the performance pad.

Playback starts from the position reached in the background.

- To cancel the slip mode, press the [SLIP] button again.

## Slip scratching

### 1 Check that VINYL mode is on.

While pressing the [SHIFT] button, check that the [SLIP] button lights.

### 2 Press the [SLIP] button.

The mode switches to the slip mode.

### 3 During playback, operate the top of the jog dial to scratch.

Normal playback continues in the background even while scratching.

### 4 Release your hand from the top of the jog dial.

Playback starts from the position reached in the background.

- To cancel the slip mode, press the [SLIP] button again.

### ❖ How to check VINYL mode on/off

By default, VINYL mode is on and scratch play is available. You can check the current status based on the lighting status of the [SLIP] button while the [SHIFT] button is pressed.

- When VINYL mode is on, the [SLIP] button lights while the [SHIFT] button is pressed.
- When VINYL mode is off, the [SLIP] button lights out while the [SHIFT] button is pressed.

To turn VINYL mode on/off, press the [SLIP] button while pressing the [SHIFT] button.

## Slip braking

### 1 Adjust the [VINYL SPEED ADJUST] - [TOUCH/BRAKE] setting in the [Deck] tab of rekordbox's [Preferences] > [CONTROLLER] menu.

The [VINYL SPEED ADJUST] setting adjusts the speed, etc. at which the track stops from the play mode.

When using slip braking, adjust the [TOUCH/BRAKE] control of [VINYL SPEED ADJUST] on the computer screen and set to stop the sound slowly.

### 2 Press the [SLIP] button.

The mode switches to the slip mode.

### 3 During playback, press the [PLAY/PAUSE ►/II] button.

Playback slowly stops. Normal playback continues in the background even while playback is slowly stopping.

### 4 Press the [PLAY/PAUSE ►/II] button again.

Playback starts from the position reached in the background.

- To cancel the slip mode, press the [SLIP] button again.

## Slip auto beat loop

### 1 Press the [SLIP] button.

The mode switches to the slip mode.

### 2 Press the [LOOP 1/2X] or [LOOP 2X] button.

Selects a beat for auto beat loop.

### 3 Press the [AUTO BEAT LOOP] button during playback.

A loop with the specified number of beats is set and loop playback starts. Normal playback continues in the background even during loop playback.

### 4 Press the [AUTO BEAT LOOP] button again.

Looping is canceled and playback starts from the position reached in the background.

- To cancel the slip mode, press the [SLIP] button again.

## Manual slip looping

### 1 Press the [SLIP] button.

The mode switches to the slip mode.

### 2 Press the [LOOP IN] button during playback, and then press the [LOOP OUT] button.

Loop playback starts.

Normal playback continues in the background even during loop playback.

### 3 Press the [LOOP OUT] button while pressing the [SHIFT] button.

Looping is canceled and playback starts from the position reached in the background.

- To cancel the slip mode, press the [SLIP] button again.

## Using the fader start function

### Using the channel fader start function

#### 1 Set the cue.

Pause at the position from which you want to start playback, then press the [CUE] button for the corresponding deck.

#### 2 While pressing the [SHIFT] button, move the channel fader from the position nearest you towards the back.

Playback of the track starts from the set cue point.

- When the channel fader is moved back to the position nearest you while pressing the [SHIFT] button during playback, the track moves instantaneously back to the set cue point and the pause mode is set. (Back Cue)

When the channel fader is moved from the back to the position nearest you while pressing the [SHIFT] button when standing by at a cue, track playback starts from the set cue.

### Using the crossfader start function

To use the crossfader start function, configure the crossfader assign switch setting for the channel you want to move in rekordbox dj.

#### 1 Set the cue.

Pause at the position from which you want to start playback, then press the [CUE] button for the corresponding deck.

#### 2 Move the crossfader to the left edge or right edge position.

Set to the edge opposite the side on which the channel you want to use with the fader start function is set.

#### 3 While pressing the [SHIFT] button, move the crossfader in the opposite direction from the left edge or right edge.

Playback of the track starts from the set cue point.

- When the crossfader is returned to the original position while pressing the [SHIFT] button during playback, the track moves instantaneously back to the set cue point and the pause mode is set (Back Cue).

When the crossfader is moved from the left edge to the right edge (or from the right edge to the left edge) while pressing the [SHIFT] button when standing by at a cue, track playback starts from the set cue point.

## Calling out a cue point or loop point stored in a track

**1 Load the track whose cue or loop points you want to call out.**

**2 Press the [HOT CUE] mode button.**

Switches to hot cue mode.

**3 Press the [PARAMETER◀] or [PARAMETER▶] button.**

To call out a cue point set before the current playback position, press the [PARAMETER◀] button. To call out a cue point set after the current playback position, press the [PARAMETER▶] button. The track cues to the called out point and pauses.

- Depending on the [Preferences] of rekordbox, a cue point or loop point cannot be called out even if the [PARAMETER◀] or [PARAMETER▶] button is pressed during track playback.

**4 Press the [PLAY/PAUSE] button.**

Normal or loop playback starts from the point that was called out.

## Analyzing tracks

Track analysis starts by dragging and dropping a track file or a folder including track files to the track list of rekordbox.

- Depending on the number of track files, some time may be required for analysis.
- If a track is loaded to a deck by pressing the [LOAD] button before the analysis is completed, it may take time to display BPM and waveform.

## Using effects

rekordbox dj has the two effect units FX1 and FX2. The effects can be applied to the selected decks. The following describes how to assign an effect unit to channel 1 with the operations of this unit.

### Screen display of rekordbox dj effect unit

Multi mode: Up to three beat FX and one release FX can be selected per effect unit, and each beat FX has one adjustable parameter.



Single mode: One beat FX and one release FX can be selected per effect unit, and beat FX has multiple adjustable parameters.

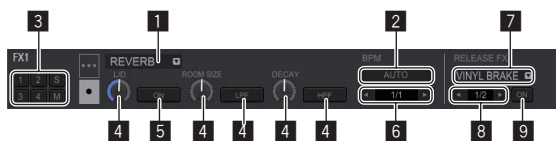

- Displays the beat FX type.
- Displays the tempo mode of beat FX.
- This displays the number of the deck to which the effect unit is assigned.
- Displays the parameter status of beat FX.
- Displays the on/off setting of beat FX.
- Displays the beat that beat FX effect synchronizes to or effect time.
- Displays the release FX type.
- Displays the beat that release FX synchronizes to.
- Displays the on/off setting of release FX.

## Operating beat FX in the multi mode

**1 Press the [RELEASE FX] control while pressing the [SHIFT] button to switch the FX mode of rekordbox dj to the multi mode.**

The mode switches between the multi mode and single mode each time this operation is performed.

**2 Press the effect parameter 1 button while pressing the [SHIFT] button to select the first beat FX type.**

To select the second beat FX type, press the effect parameter 2 button while pressing the [SHIFT] button.

To select the third beat FX type, press the effect parameter 3 button while pressing the [SHIFT] button.

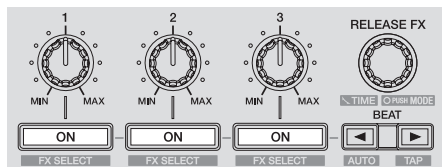

The currently selected beat FX type is displayed on the rekordbox dj screen.

**3 Press the effect parameter 1 button to turn the first beat FX on.**

Press the effect parameter 2 button to turn the second beat FX on.

Press the effect parameter 3 button to turn the third beat FX on.

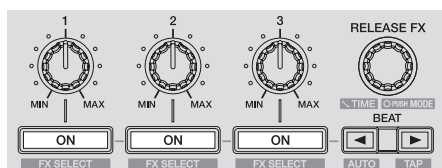

The [ON] key for the corresponding effect is highlighted on the rekordbox dj screen.

**4 Operate the effect parameter 1 control to adjust the parameter of the first beat FX.**

Operate the effect parameter 2 control to adjust the parameter of the second beat FX.

Operate the effect parameter 3 control to adjust the parameter of the third beat FX.

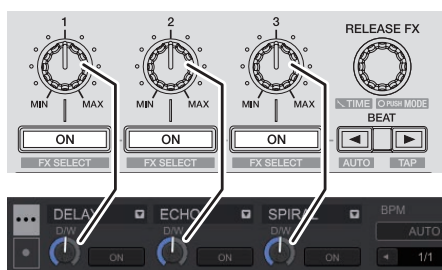

**5 Press the [BEAT◀] or [BEAT▶] button to adjust the beat fraction to synchronize the effect sound with.**

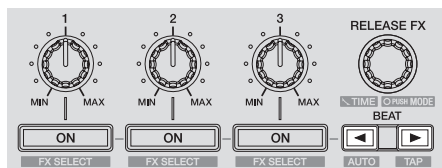

- Depending on the beat FX type, it can be specified using parameters instead of beat.
- It is also possible to set the BPM value used as the basis for the effect time with the interval at which the [BEAT▶] button is tapped while pressing the [SHIFT] button.

➤ *Switching the effect's tempo mode (p.25)*



## Operating beat FX in the single mode

**1 Press the [RELEASE FX] control while pressing the [SHIFT] button to switch the FX mode of rekordbox dj to the single mode.**

The mode switches between the multi mode and single mode each time the buttons are operated.

**2 Press the effect parameter 1 button while pressing the [SHIFT] button to select the beat FX type.**

The selected beat FX is displayed on the rekordbox dj screen.

**3 Press the effect parameter 1 button to turn beat FX on.**

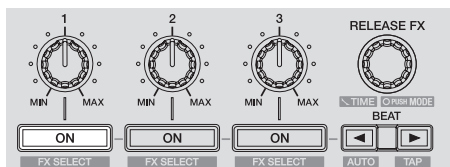

Beat FX turns on and off each time the button is pressed.

- The [ON] key for the effect is highlighted on the rekordbox dj screen.

**4 Operate the effect parameter 2 or effect parameter 3 button to switch the beat FX's parameters.**

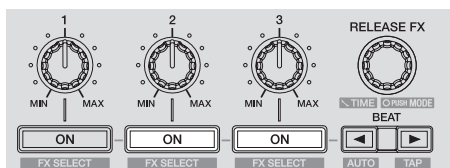

- Depending on the beat FX type, the button may not light when the button is operated.

**5 Operate the effect parameter control to adjust the beat FX's parameters.**

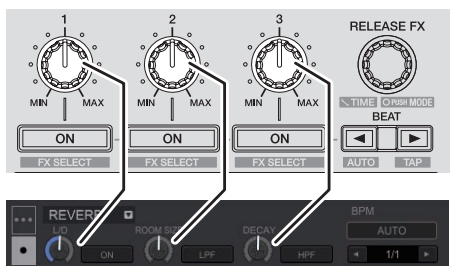

**6 Press the [BEAT◀] or [BEAT▶] button to adjust the beat fraction to synchronize the effect sound with.**

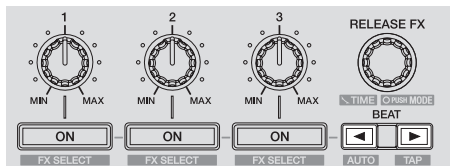

- Depending on the beat FX type, it can be specified using parameters instead of beat.
- It is also possible to set the BPM value used as the basis for the effect time with the interval at which the [BEAT▶] button is tapped while pressing the [SHIFT] button.
  - ➔ *Switching the effect's tempo mode* (p.25)

## Switching the effect's tempo mode

With rekordbox dj effects, there are two ways to set the beat FX tempo: with "BPM auto mode" and "BPM tap mode".

- By default, the BPM auto mode is set.

### ❖ BPM auto mode

The track's BPM value is used as the basis for the effect's tempo.

### ❖ BPM tap mode

The BPM used as the base value for the effect is calculated from the interval at which the [BEAT▶] button is tapped while pressing the [SHIFT] button.

### ❖ Switching to the BPM tap mode

**Press the [BEAT▶] button while pressing the [SHIFT] button.**

- If the [BEAT◀] button is pressed while pressing the [SHIFT] button, the mode switches to the BPM auto mode.

## Using the release FX

Release FX turns off the beat FX that was on up until then simultaneously with the addition of an effect.

The track being played and effect sound can be smoothly connected by using release FX.

One release FX can be used per effect unit in both the multi mode and single mode.

**1 Press the [FX1] button or [FX2] button of channel 1 to select the effect unit to assign.**

The number of the deck which the effect unit is assigned to is highlighted on the rekordbox dj screen.

**2 Turn the [RELEASE FX] control to select the release FX type.**

**3 Click the [◀] or [▶] button on the rekordbox dj screen to set the release FX beat.**

- The release FX beat can be set separately from the beat setting for beat FX.

**4 Press and hold the [RELEASE FX] control.**

The selected release FX turns on, and the beat FX in the same effect unit that was on up until then turns off.

**5 Release the [RELEASE FX] control.**

Release FX turns off.

## Using recording functions

rekordbox dj has recording functions and can record mixed sound. For detailed instructions on recording, see the rekordbox software manual.

**1 Click the [REC] button in the global section of rekordbox dj.**

The panel used for recording appears on the rekordbox dj screen.

**2 Click  on the recording panel of rekordbox dj to start recording.**

- If you click  again, recording stops.
- If the recording is completed, the file is automatically saved.
- The saving destination of the file can be changed in the [Preferences] > [Controller] > [Other] tab of rekordbox.

## Using external inputs

Two external input systems and one MIC input system are provided to connect to DJ players, analog players, etc.

The audio of these devices can be output from this unit via a computer or output from this unit not via a computer. The output method can be switched with the [PC MIX] switch on this unit's rear panel.

## Function differences depending on the [PC MIX] setting

The following shows the switch settings and the function differences depending on the setting. Change the setting to match your environment.

- [ON]: Outputs the audio of the external device from this unit via a computer. This enables performances using the mixer functions or effect functions of rekordbox for the audio of the external device.
  - For use with this setting, be sure to connect a computer and then start rekordbox.
- [OFF]: Outputs the audio of the external device from this unit not via a computer. This allows you to output the audio of an external device from this unit without connecting a computer.
  - With this setting, the volume can be adjusted using the channel fader and crossfader of this unit, but functions such as EQ and FILTER cannot be used.

Function name	PC MIX ON	PC MIX OFF
TRIM	Enabled	Enabled
EQ	Enabled	Disabled
FILTER	Enabled	Disabled
Headphones CUE	Enabled	Enabled
Channel fader	Enabled	Enabled
Crossfader	Enabled	Enabled
Crossfader curve	Enabled	Fixed <sup>[1]</sup>
Crossfader reverse	Enabled	[2]
Microphone maximum allowable input level	Enabled	[3]
Crossfader cut lag	Enabled	Enabled
Master peak limiter	Enabled	Disabled
Microphone low cut filter	Enabled	Disabled
Microphone peak limiter	Enabled	Disabled
Master output monaural/stereo selection	Enabled	Disabled
MASTER LEVEL	Enabled	Enabled
Booth output monaural/stereo selection	Enabled	Disabled
Booth monitor level	Enabled	Enabled
HEADPHONES LEVEL	Enabled	Enabled
HEADPHONES MIXING	Enabled	Enabled
Channel level indicator	Enabled	Enabled
Master level indicator	Enabled	Enabled

[1] Operation is with the same setting as when the selector control is turned fully clockwise for the crossfader curve in the preference settings of rekordbox.

[2] The setting is maintained when switched while connected with rekordbox, but becomes fixed to the off setting when this unit is started independently.

[3] The setting is maintained when switched while connected with rekordbox, but operation is with the setting fixed to [High] when this unit is started independently.



### Notes

- For details on each button and control, see *Part names and functions* (p.7).
- The functions below do not work with respect to external inputs.
  - Track tempo setting (pressing the headphones [CUE] button while pressing the [SHIFT] button)
  - Fader start function (while pressing the [SHIFT] button, move the channel fader or cross fader)

## Mixing the sound of the microphone

- 1 Connect the microphone to the [MIC] input terminal.
- 2 Operate the [MIC LEVEL] control to adjust the output audio level.
  - The functions that can be used differ depending on the setting of the [PC MIX] switch.

## Mixing the sound of a DJ player, etc.

- 1 Connect this unit to your computer with a USB cable.
- 2 Launching rekordbox
- 3 Connect a DJ player or other line level output device to the [PHONO/LINE] input terminals.
- 4 Set the [PHONO/LINE] selector switch on this unit's rear panel to [LINE].
- 5 Set the [INPUT SELECT] switch on this unit's top panel to [PHONO/LINE].
- 6 Operate the [TRIM] control and channel fader to adjust the sound level output from each channel.
  - The functions that can be used differ depending on the setting of the [PC MIX] switch.

## Mixing the sound of an analog turntable, etc.

- 1 Connect this unit to your computer with a USB cable.
- 2 Launching rekordbox.
- 3 Connect the analog player or other phono level (for MM cartridges) output device to the [PHONO/LINE] input terminals.
  - Make sure to connect the ground wire of an analog player to this unit's [SIGNAL GND] terminal.
- 4 Set the [PHONO/LINE] selector switch on the back of this unit to [PHONO].
- 5 Set the [INPUT SELECT] switch on this unit's top panel to [PHONO/LINE].
- 6 Operate the [TRIM] control and channel fader to adjust the sound level output from each channel.
  - The functions that can be used differ depending on the setting of the [PC MIX] switch.

# Changing the settings

## Launching utilities mode

If the utilities mode is launched while the unit and a computer are connected by a USB cable, the set status may not be displayed properly.

The “MIDI controller setting” can be set in the utilities mode. The unit automatically changes operation as follows depending on whether rekordbox is running.

- When rekordbox is running, controller operation depends on the rekordbox dj functions.
- When rekordbox is not running, the unit operates as a general MIDI controller.

Even though rekordbox is running, you can forcefully operate the unit as a general MIDI controller.

### 1 Disconnect the USB cable from your computer.

### 2 Press the [STANDBY/ON] switch on this unit's rear panel to set this unit's power to standby.

Set this unit's power to the standby mode.

### 3 While pressing both the [SHIFT] and [PLAY/PAUSE ►/II] buttons on the left deck, press the [STANDBY/ON] switch on this unit's rear panel.

Utilities mode is launched.

### 4 Press the [MASTER TEMPO] button on the left deck.

- [MASTER TEMPO] button off: Operation automatically changes depending on whether or not rekordbox is running.
- [MASTER TEMPO] button lit: Regardless of whether or not rekordbox is running, the unit is forcefully operated as a general MIDI controller.

### 5 Press the [STANDBY/ON] switch on this unit's rear panel to set this unit's power to standby.

To save the settings, set the [STANDBY/ON] switch on this unit's rear panel to standby and quit utilities mode.

## Changing the settings with rekordbox

The settings required for the DJ player can be changed with rekordbox. Change the setting items in [Controller] of [Preferences].

- The following settings can be changed only when rekordbox and this unit are connected.

### Setting items of [Deck] tab in [Controller]

#### ❖ On Jog Indicator

Sets the display target of the jog indicator of this unit deck section.

- Jog dial display section (p.11)

#### ❖ Back Spin Length

The back spin performed by this unit can be made to be longer than the actual jog dial rotation amount when the back spin operation of the jog dial is performed. The length of back spin can be selected from one of three types: short, normal, and long.

- Short: Sets a short back spin length
- Normal: Sets a normal back spin length
- Long: Sets a long back spin length

#### ❖ Slip mode flashing

Changes the slip mode flashing setting.

- Enable: The buttons that can be operated only while slip mode is on ([HOT CUE], [AUTO BEAT LOOP], etc.) flash.
- Disable: The buttons that can be operated only while slip mode is on do not flash.

#### ❖ [SLIP] button lighting setting for when slip mode is on

Sets the lighting operation of the [SLIP] button for when slip mode is on.

- On: The [SLIP] button is lit when slip mode is on and flashing during the slip mode operation.
- Flashing: The [SLIP] button is always flashing when slip mode is on.

### Setting items of [Mixer] tab in [Controller]

#### ❖ Mixer Mode setting

Changes the mixer mode setting.

- Switching the mixer mode (p.22)

#### ❖ Fader Start setting

Changes the fader start function setting.

When the [Enable FaderStart Function] check box is selected, the function is enabled.

#### ❖ Cross Fader Reverse setting

Switches the crossfader left/right operations.

- On: The left side of the crossfader is deck 2, and the right side is deck 1.
- Off: The left side of the crossfader is deck 1, and the right side is deck 2.

### ❖ Cross Fader Cut Lag setting

Adjust the play (cut lag) of both ends of the crossfader.  
Adjustment can be made from 0.3 mm to 5.5 mm in 0.1 mm increments.

- By default, the level is set to 1.0 mm.

### ❖ Output setting of microphone to Booth monitor

Change whether or not to output microphone sound to the booth output. If the [Mic Output On Booth] check box is cleared, microphone sound is output to the booth output. If it is selected, microphone sound is not output to the booth output.

### ❖ Mic Low Cut Filter setting

Set whether or not to apply a filter to attenuate sounds lower than the human voice to microphone sound. This low cut filter reduces input of background noise generated from speakers, etc. into the microphone.

- On: Enables the low cut filter of microphone sound.
- Off: Disables the low cut filter of microphone sound.

### ❖ Microphone maximum allowable input level setting

Change this setting when the microphone sound level is too low or too high even after adjusting it with the [MIC LEVEL] control on this unit.

- Low: Sets the microphone sound level to high.
- High: Sets the microphone sound level to low.

### ❖ Mic Talkover Mode setting

Switches the talkover mode.

- Advanced talk over mode: Sound other than the microphone channel is output with only the midrange attenuated per the talk over level setting.

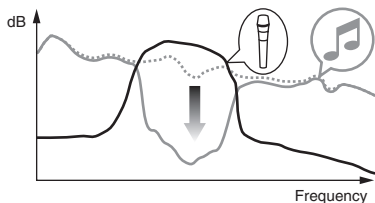

- Normal talk over mode: Sound other than the microphone channel is output attenuated per the talk over level setting.

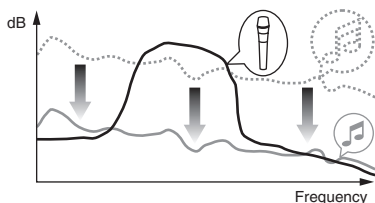

### ❖ Mic Talkover Level setting

Sets the talk over function's sound attenuation level.  
Setting values: -6 dB / -12 dB / -18 dB / -24 dB

## Setting items of [DDJ-RR] tab in [Controller]

### ❖ Master Attenuator Level setting

Sets the master output attenuator level.  
Setting values: 0 dB / -3 dB / -6 dB

### ❖ Master output monaural/stereo selection

Switches the setting for the sound output from the master output terminals between monaural and stereo.

- Monaural: Outputs the master sound in monaural.
- Stereo: Outputs the master sound in stereo.

### ❖ Booth Attenuator Level setting

Sets the booth output attenuator level.  
Setting values: 0 dB / -6 dB / -12 dB

### ❖ Booth output monaural/stereo selection

Switches the setting for the sound output from the booth output terminals between monaural and stereo.

- Monaural: Outputs the booth sound in monaural.
- Stereo: Outputs the booth sound in stereo.

### ❖ Master/booth output peak limiter setting

Lessens sudden, unpleasant digital clipping of the master/booth output.

- Enable: Enables the peak limiter of the master/booth output.
- Disable: Disables the peak limiter of the master/booth output.

### ❖ Microphone Output Peak Limiter setting

Lessens sudden, unpleasant digital clipping of the microphone output.

- Enable: Enables the peak limiter of the microphone output.
- Disable: Disables the peak limiter of the microphone output.

### ❖ Demo Mode Start Duration setting

Sets the duration to wait before starting demo mode. When this setting is other than Off, the demo mode starts if this unit is not operated within the set duration.

- 1 minute: Starts demo mode if this unit is not operated for 1 minute.
- 5 minute: Starts demo mode if this unit is not operated for 5 minute.
- 10 minute: Starts demo mode if this unit is not operated for 10 minute.
- Off: Does not start demo mode.

### ❖ Auto standby setting

Changes the auto standby function setting. When this setting is enabled, this unit enters the standby state automatically after 4 hours if any of the following conditions are met.

- None of this unit's buttons or controls are operated.
- No audio signal of -18 dB or greater is input to an input terminal of this unit.
- If the [SLIP REVERSE] button of the left side deck is pressed, the standby state is canceled.

---

---

## About the driver software and setting utility software

This unit functions as an audio device conforming to the ASIO standards.

---

---

### Using the settings utility software

This function can only be used by those using a Windows operating system.

#### ❖ Launching the settings utility software

##### For Windows 10/8.1

From [Apps view], click [Pioneer] > [DDJ\_RR ASIO Settings Utility].

##### For Windows 7

Click [All Programs] > [Pioneer] > [DDJ\_RR] > [DDJ\_RR ASIO Settings Utility] from the Windows [Start] menu.

#### ❖ Adjusting the buffer size

If the buffer size is made large, drops in audio data (breaks in the sound) occur less easily, but the time lag due to the delay in the transfer of the audio data (latency) increases.

---

---

### Checking the version of the driver software

#### ❖ For Mac OS X

- 1 Open the [Applications] folder in Finder.
- 2 Click [Pioneer] > [DDJ\_RR] > [DDJ\_RR Version Display Utility].

#### ❖ For Windows

- 1 Launching the settings utility software.
- 2 Click the [About] tab.
  - You can check the firmware version of this unit on the screen.
  - The firmware version is not displayed when this unit is not connected to the computer or when this unit and computer are not properly communicating.

# Additional information

## Troubleshooting

- If you think that there is something wrong with this unit, check the items below and access the Pioneer DJ site and check [FAQ] for the [DDJ-RR]. <http://www.pioneerdj.com/>  
Sometimes the problem may lie in another component. Inspect the other components and electrical appliances being used. If the problem cannot be rectified, ask your nearest Pioneer authorized service center or your dealer to carry out repair work.
- The player may not operate properly due to static electricity or other external influences. In such cases, normal operation may become possible if you turn the power off and then back on.

Problem	Check	Remedy
The power of the unit does not turn on.	Is the [STANDBY/ON] switch of the power on?	Turn the [STANDBY/ON] switch of the power on.
	Is the included AC adapter properly connected?	Connect the included AC adapter correctly.
This unit is not recognized.	Is the included USB cable properly connected?	Connect the included USB cable properly.
	Are you using a USB hub?	USB hubs cannot be used. Connect the computer and this unit directly using the included USB cable.
	Is the driver software properly set?	Set the driver software properly. (page 32)
	Is your computer recognizing the unit?	Windows: Check if the firmware version of this unit is displayed on the [About] tab of [DDJ_RR Settings Utility]. (page 29) Mac: Check if this unit is recognized by the computer in [System Information] of Mac OS.
	Are other applications running?	Quit other applications including screen savers and resident software. (When quitting antivirus security software, before doing so, disable the Internet connection to ensure the security of your computer.)
	Are USB devices other than this unit connected?	Remove external hard disks and the keyboard (for some models), etc. to check the status with only the built-in hard disk.
	—	If your computer has more than one USB terminal, check using a different USB terminal.
	Are multiple ASIO drivers for units other than this unit installed on the computer?	Uninstall unnecessary ASIO drivers. For details of how to uninstall ASIO drivers, check with the manufacturer of the respective ASIO driver.
The jog dial does not respond to touching.	Is the jog dial dirty?	An electrostatic system is used as the detection method in the jog dial of this unit. Therefore, if the jog dial is dirty or the user has hand cream on their hands, detection may not respond. When cleaning the jog dial, dry wipe with a soft cloth. If it is very dirty, prepare a 5:1 or 6:1 solution of water and neutral detergent, immerse a soft cloth in the solution and wring out well, then clean the jog dial and wipe with a dry cloth after that.
	Does the jog dial respond when touched while touching some other metal part of the unit?	If touching the jog dial while touching some other metal part of the unit makes it work, there is a possibility that the unit is affected by another device connected to the unit. Review the connection environment (setting location or ground connection status, etc.) of the devices (computer, amplifier, etc.) connected to the unit.
Recording is not possible.	Is the recording level low?	Adjust the recording adjustment control on the recording panel of rekordbox dj.
No sound or small sound.	Are the [TRIM] control, channel faders, crossfader, [INPUT SELECT] switch and [MASTER LEVEL] control set to the proper positions?	Set the [TRIM] control, channel faders, crossfader, [INPUT SELECT] switch and [MASTER LEVEL] control to the proper positions.
	Are the connected powered speakers, etc., properly set?	Properly set the external input selection, volume, etc., on the powered speakers, etc.
	Are the connection cables properly connected?	Connect the connection cables properly.
	Are the terminals and plugs dirty?	Clean the terminals and plugs before making connections.
	Is the driver software properly set?	Set the driver software properly. (page 32)
Distorted sound.	Is the [MASTER LEVEL] control set to the proper position?	Adjust the [MASTER LEVEL] control so that the master level indicator's orange indicator lights at the peak level.
	Is the [TRIM] control set to the proper position?	Adjust the [TRIM] control so that the channel level indicator's orange indicator lights at the peak level.
Sound being played is interrupted when using DJ software.	Is the buffer size (latency) value appropriate?	On a Windows system, use the setting utility to set an appropriate buffer size value. (page 29) On a Macintosh, set the appropriate buffer size (latency) value for the DJ software.
	Cannot output the sound of the external device.	Is the [INPUT SELECT] switch set to the proper position?

Problem	Check	Remedy
The indicator flashes and operation is strange.	—	Normal operation can be restored by disconnecting the AC adapter, waiting at least 1 minute, then reconnecting the AC adapter. If the same symptom persists, disconnect the AC adapter, then request repairs.
Operation of rekordbox dj becomes unstable.	Are you using softwares other than rekordbox at the same time?	Quit other applications to decrease the load on the computer. If operation continues to be unstable, try disabling the wireless network or other wireless connections, antivirus software, the screen saver, the low power mode, etc. (5Page)
	When other USB devices are connected to the computer.	Disconnect other USB devices from the computer. When another USB audio device is connected to the computer at the same time, it may not operate or be recognized normally.
	Are you using a USB hub?	USB hubs cannot be used. Connect the computer and this unit directly using the included USB cable.
	There is a problem with the USB port to which this unit is connected.	If your computer has multiple USB ports, try connecting this unit to a different USB port.
	Is this unit connected to a notebook computer running on its battery?	Supply power to the notebook computer from an AC power supply. (Depending on the notebook computer's settings, the low power mode may be set when the computer is running on its battery, automatically reducing the performance of the computer itself.) (5Page)
	The USB buffer size is too small.	Raise the USB buffer size. (page 29)
The fader start function does not work.	Is a cue set?	Set the cue.
The [TEMPO] slider does not work if the deck is switched.	In the utilities mode, is the unit set to be forcefully operated as a general MIDI controller?	In the utilities mode, set the mode with which the operation of the unit is automatically switched according to whether or not rekordbox is running.
Only one track deck is display on the screen. The platter is not displayed on the track deck.	Is rekordbox set to the [EXPORT] mode?	Click the area indicated by [EXPORT] at the upper left of the screen, and then select [PERFORMANCE].
	Has rekordbox dj been activated?	Enter the rekordbox dj license key included with this unit on the [Preferences] > [License] screen of rekordbox. For details on the activation method, see the rekordbox Operating Instructions.
There is not change even if a performance pad is pressed while pressing the [CAPTURE] button.	Is any loop active?	Set a loop using the [AUTO BEAT LOOP] button/[LOOP IN]/[LOOP OUT] buttons.
	Is the sampler slot that has been already loaded selected?	Clear the sampler slot by clicking the [EJECT] button on the sampler panel of rekordbox dj, or select the [SAMPLER] tab on the [Preferences] > [CONTROLLER] screen of rekordbox and unlock [Eject/Load Lock].
There is no change even if the [CAPTURE] button is pressed while pressing the [SHIFT] button.	Is the slicer or slicer loop mode set?	Press the [SLICER] mode button to set the slicer mode, or press the [SHIFT] and [SLICER] mode buttons to set the slicer loop mode.
	Is the sampler slot that has been already loaded selected?	Clear the sampler slot by clicking the [EJECT] button on the sampler panel of rekordbox dj, or select the [SAMPLER] tab on the [Preferences] > [CONTROLLER] screen of rekordbox and unlock [Eject/Load Lock].
The sampler deck's sound cannot be monitored with headphones.	Is [SAMPLER CUE] selected?	Press the [SAMPLER CUE] button to turn on the monitor of the sampler deck.
	Is the position of the [SAMPLER VOLUME] control fully turned counterclockwise?	Set the [SAMPLER VOLUME] control to an appropriate position.
The playback position does not move even if the [NEEDLE SEARCH] pad is touched.	Is [Needle Lock] of rekordbox dj enabled?	Unlock [Needle Lock] in the [DECK] tab on the [Preferences] > [CONTROLLER] screen of rekordbox. If [Needle Lock] is locked, the playback position can be moved using the [NEEDLE SEARCH] pad when track playback is paused or while touching the jog.

## Using as a controller for other DJ software

This unit also outputs the operating data for the buttons and controls in MIDI format. If you connect a computer with a built-in MIDI-compatible DJ software via a USB cable, you can operate the DJ software on this unit. The sound of music files being played on the computer can also be output from the DDJ-RR.

To use as a controller for operating DJ software other than the rekordbox software, also configure the DJ software audio and MIDI-related settings.

- For details, see your DJ software's operating instructions.

---

## About MIDI messages

For details on this unit's MIDI messages, see "List of MIDI Messages".

- "List of MIDI Messages" can be acquired from the following URL:  
<http://www.pioneerdj.com/>

---

## About the driver software

This driver software is an exclusive driver for outputting audio signals from a computer.

- Carefully read *Software end user license agreement* (page 32).

### ❖ Obtaining the driver software

#### 1 Launch a web browser on the computer and access the Pioneer DJ site below.

<http://www.pioneerdj.com/>

#### 2 Click the [Support] icon.

#### 3 Click the [FIND SOFTWARE & FIRMWARE UPDATES] icon.

#### 4 Click the [DDJ-RR] icon in the [CONTROLLER] category.

#### 5 After clicking [Drivers], download the latest driver software from the download page.

- Download the driver for either Windows or Mac from the download page.

### ❖ Installation procedure (Mac OS X)

Do not connect this unit and the computer until installation is completed.

- If any other programs are running on the computer, quit them.

#### 1 Double-click the file for Mac (DDJ-RR\_M\_X.X.X.dmg) downloaded in *Obtaining the driver software*.

The [DDJ-RR\_AudioDriver] menu screen appears.

#### 2 Double-click [DDJ-RR\_AudioDriver.pkg].

The driver software installation screen appears.

#### 3 Check the details on the screen and click [Continue Anyway].

#### 4 When the end user license agreement appears, read *Software end user license agreement* carefully, then click [Continue Anyway].

#### 5 If you consent to the provisions of the *Software end user license agreement*, click [Agree].

If you do not consent to the provisions of the *Software end user license agreement*, click [Disagree] and stop installation.

#### 6 Proceed with installation according to the instructions on the screen.

### ❖ Installation procedure (Windows)

Do not connect this unit and the computer until installation is completed.

- Log on as the user which was set as the computer's administrator before installing.
- If any other programs are running on the computer, quit them.

#### 1 Double-click the file for Windows (DDJ-RR\_VerX.X.X.exe) downloaded in *Obtaining the driver software*.

The driver software installation screen appears.

#### 2 Carefully read the *Software end user license agreement* and if you consent to the provisions, put a check mark in [I agree.] and click [OK].

If you do not consent to the provisions of the *Software end user license agreement*, click [Cancel] and stop installation.

#### 3 Proceed with installation according to the instructions on the screen.

If [Windows Security] appears on the screen while the installation is in progress, click [Install this driver software anyway] and continue with the installation.

When the installation program is completed, a completion message appears.

### ❖ Software end user license agreement

This Software End User License Agreement ("Agreement") is between you (both the individual installing the Program and any single legal entity for which the individual is acting) ("You" or "Your") and Pioneer DJ Corporation ("Pioneer DJ").

TAKING ANY STEP TO SET UP OR INSTALL THE PROGRAM MEANS THAT YOU ACCEPT ALL OF THE TERMS OF THIS LICENSE AGREEMENT. PERMISSION TO DOWNLOAD AND/OR USE THE PROGRAM IS EXPRESSLY CONDITIONED ON YOUR FOLLOWING THESE TERMS. WRITTEN OR ELECTRONIC APPROVAL IS NOT REQUIRED TO MAKE THIS AGREEMENT VALID AND ENFORCEABLE. IF YOU DO NOT AGREE TO ALL OF THE TERMS OF THIS AGREEMENT, YOU ARE NOT AUTHORIZED TO USE THE PROGRAM AND MUST STOP INSTALLING IT OR UNINSTALL IT, AS APPLICABLE.

#### 1 DEFINITIONS

- 1 "Documentation" means written documentation, specifications and help content made generally available by Pioneer DJ to aid in installing and using the Program.
- 2 "Program" means all or any part of Pioneer DJ's software licensed to You by Pioneer DJ under this Agreement.

#### 2 PROGRAM LICENSE

- 1 Limited License. Subject to this Agreement's restrictions, Pioneer DJ grants to You a limited, non-exclusive, non-transferable, license (without the right to sublicense):
  - a To install a single copy of the Program in Your computer or mobile device, to use the Program only for Your personal purpose complying with this Agreement and the Documentation ("Authorized Use");
  - b To use the Documentation in support of Your Authorized Use; and
  - c To make one copy of the Program solely for backup purposes, provided that all titles and trademark, copyright and restricted rights notices are reproduced on the copy.
- 2 Restrictions. You will not copy or use the Program or Documentation except as expressly permitted by this Agreement. You will not transfer, sublicense, rent, lease or lend the Program, or use it for third-party training, commercial time-sharing or service bureau use. You will not Yourself or through any third party modify, reverse engineer, disassemble or decompile the Program, except to the extent expressly permitted by applicable law, and then only after You have notified Pioneer DJ in writing of Your intended activities.
- 3 Ownership. Pioneer DJ or its licensor retains all right, title and interest in and to all patent, copyright, trademark, trade secret and other intellectual property rights in the Program and



Documentation, and any derivative works thereof. You do not acquire any other rights, express or implied, beyond the limited license set forth in this Agreement.

- 4 No Support. Pioneer DJ has no obligation to provide support, maintenance, upgrades, modifications or new releases for the Program or Documentation under this Agreement.

### 3 WARRANTY DISCLAIMER

THE PROGRAM AND DOCUMENTATION ARE PROVIDED "AS IS" WITHOUT ANY REPRESENTATIONS OR WARRANTIES, AND YOU AGREE TO USE THEM AT YOUR SOLE RISK. TO THE FULLEST EXTENT PERMISSIBLE BY LAW, PIONEER DJ EXPRESSLY DISCLAIMS ALL WARRANTIES OF ANY KIND WITH RESPECT TO THE PROGRAM AND DOCUMENTATION, WHETHER EXPRESS, IMPLIED, STATUTORY, OR ARISING OUT OF COURSE OF PERFORMANCE, COURSE OF DEALING OR USAGE OF TRADE, INCLUDING ANY WARRANTIES OF MERCHANTABILITY, FITNESS FOR A PARTICULAR PURPOSE, SATISFACTORY QUALITY, ACCURACY, TITLE OR NON-INFRINGEMENT.

### 4 EXPORT CONTROL AND COMPLIANCE WITH LAWS AND REGULATIONS

You may not use or otherwise export or re-export the Program except as authorized by United States law and the laws of the jurisdiction in which the Program was obtained. In particular, but without limitation, the Program may not be exported or re-exported (a) into any U.S.-embargoed countries or (b) to anyone on the U.S. Treasury Department's Specially Designated Nationals List or the U.S. Department of Commerce Denied Persons List or Entity List. By using the Program, you represent and warrant that you are not located in any such country or on any such list. You also agree that you will not use the Program for any purposes prohibited by United States law, including, without limitation, the development, design, manufacture, or production of nuclear, missile, or chemical or biological weapons.

### 5 U.S. GOVERNMENT RESTRICTED RIGHTS

The Program and Documentations are "commercial computer software" and "commercial computer software documentation" as those terms are defined in 48 C.F.R. §252.227-7014 (a) (1) (2007) and 252.227-7014 (a) (5) (2007). The U.S. Government's rights with respect to the Program and Documentations are limited by this license pursuant to 48 C.F.R. §12.212 (Computer software) (1995) and 48 C.F.R. §12.211 (Technical data) (1995) and/or 48 C.F.R. §227.7202-3, as applicable. As such, the Program and Documentations are being licensed to the U.S. Government end users: (a) only as "commercial items" as that term is defined in 48 C.F.R. §2.101 generally and as incorporated in DFAR 212.102; and (b) with only those limited rights as are granted to the public pursuant to this license. Under no circumstance will the U.S. Government or its end users be granted any greater rights than we grant to other users, as provided for in this license. Manufacturer is Pioneer DJ Corporation, 1-1 Shin-Ogura, Saiwai-ku, Kawasaki-shi, Kanagawa, 212-0031 Japan

### 6 DAMAGES AND REMEDIES FOR BREACH

You agree that any breach of this Agreement's restrictions would cause Pioneer DJ irreparable harm for which money damages alone would be inadequate. In addition to damages and any other remedies to which Pioneer DJ may be entitled, You agree that Pioneer DJ may seek injunctive relief to prevent the actual, threatened or continued breach of this Agreement.

### 7 TERMINATION

Pioneer DJ may terminate this Agreement at any time upon Your breach of any provision. If this Agreement is terminated, You will stop using the Program, permanently delete it from your computer or mobile device where it resides, and destroy all copies of the Program and Documentation in Your possession, confirming to Pioneer DJ in writing that You have done so. Sections 2.2, 2.3, 2.4, 3, 4, 5, 6, 7 and 8 will continue in effect after this Agreement's termination.

### 8 GENERAL TERMS

- 1 Limitation of Liability. In no event will Pioneer DJ or its subsidiaries be liable in connection with this Agreement or its subject matter, under any theory of liability, for any indirect, incidental, special, consequential or punitive damages, or damages for lost profits, revenue, business, savings, data, use, or cost of substitute procurement, even if advised of the possibility of such damages or if such damages are foreseeable. In no event will Pioneer

DJ's liability for all damages exceed the amounts actually paid by You to Pioneer DJ or its subsidiaries for the Program. The parties acknowledge that the liability limits and risk allocation in this Agreement are reflected in the Program price and are essential elements of the bargain between the parties, without which Pioneer DJ would not have provided the Program or entered into this Agreement.

- 2 The limitations or exclusions of warranties and liability contained in this Agreement do not affect or prejudice Your statutory rights as consumer and shall apply to You only to the extent such limitations or exclusions are permitted under the laws of the jurisdiction where You are located.
- 3 Severability and Waiver. If any provision of this Agreement is held to be illegal, invalid or otherwise unenforceable, that provision will be enforced to the extent possible or, if incapable of enforcement, deemed to be severed and deleted from this Agreement, and the remainder will continue in full force and effect. The waiver by either party of any default or breach of this Agreement will not waive any other or subsequent default or breach.
- 4 No Assignment. You may not assign, sell, transfer, delegate or otherwise dispose of this Agreement or any rights or obligations under it, whether voluntarily or involuntarily, by operation of law or otherwise, without Pioneer DJ's prior written consent. Any purported assignment, transfer or delegation by You will be null and void. Subject to the foregoing, this Agreement will be binding upon and will inure to the benefit of the parties and their respective successors and assigns.
- 5 Entire Agreement. This Agreement constitutes the entire agreement between the parties and supersedes all prior or contemporaneous agreements or representations, whether written or oral, concerning its subject matter. This Agreement may not be modified or amended without Pioneer DJ's prior and express written consent, and no other act, document, usage or custom will be deemed to amend or modify this Agreement.
- 6 You agree that this Agreement shall be governed and construed by and under the laws of Japan.

---

---

## About trademarks and registered trademarks

- "Pioneer DJ" is a trademark of PIONEER CORPORATION, and is used under license.
- rekordbox is a trademark or registered trademark of the Pioneer DJ Corporation.
- Windows is a registered trademark of Microsoft Corporation in the United States and other countries.
- Adobe and Reader are either registered trademarks or trademarks of Adobe Systems Incorporated in the United States and/or other countries.
- Mac, Mac OS, and Finder are trademarks of Apple Inc., registered in the U.S. and other countries.
- Intel and Intel Core are trademarks of Intel Corporation in the U.S. and/or other countries.
- ASIO is a trademark of Steinberg Media Technologies GmbH.

The names of companies and products mentioned herein are trademarks or registered trademarks of their respective owners.

---

---

## Cautions on copyrights

rekordbox restricts playback and duplication of copyright-protected music contents.

- When coded data, etc., for protecting the copyright is embedded in the music contents, it may not be possible to operate the program normally.
- When rekordbox detects that coded data, etc., for protecting the copyright is embedded in the music contents, processing (playback, reading, etc.) may stop.

Recordings you have made are for your personal enjoyment and according to copyright laws may not be used without the consent of the copyright holder.

- Music recorded from CDs, etc., is protected by the copyright laws of individual countries and by international treaties. It is the full responsibility of the person who has recorded the music to ensure that it is used legally.
- When handling music downloaded from the Internet, etc., it is the full responsibility of the person who has downloaded the music to ensure that it is used in accordance with the contract concluded with the download site.

© 2016 Pioneer DJ Corporation.

All rights reserved.

<DRI1367-B>