

Marshall Electronics

Model No. QVW-1708

17.3" Quad-Viewer Monitor with 4K Format Support

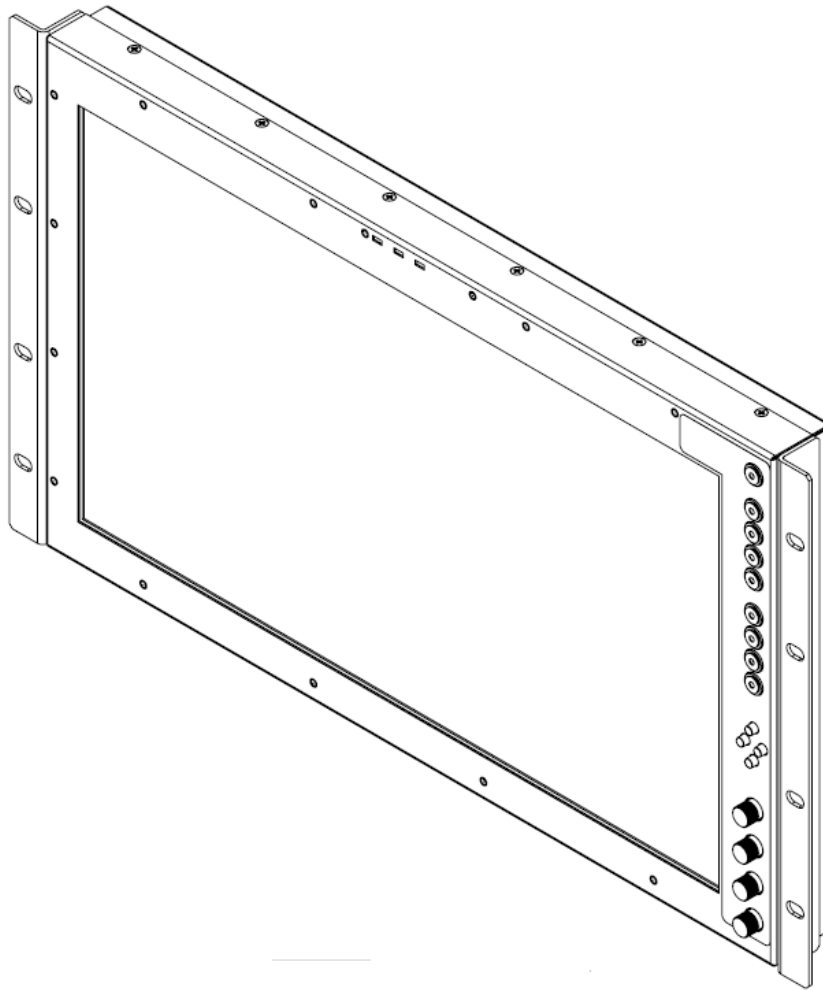

Operating Instructions

Table of Contents

Installation and Accessories.....	3
Monitor Front.....	4
Monitor Rear	4
Front Controls	5
Rear Inputs	6
Compatible Input Formats.....	7
Screen Layouts.....	8
On Screen Menu.....	10
Marker Setup Submenu	11
Video Configuration Submenu	12
Color Configuration Submenu.....	15
System Configuration Submenu	16
OSD Configuration Submenu.....	18
Audio Config Submenu	21
IMD Config Submenu.....	22
IMD Fixed Config Submenu	24
IP Config Submenu.....	25
Service Submenu.....	26
Monitor Specifications	27
Dimensions	28
Warranty	32

Installation and Accessories

Unpacking

Carefully unpack the QVW-1708 monitor and verify that the following items are included:

- QVW-1708 Monitor
- V-PS12V-5A-XLR Power Supply
- Operating Instructions

Accessories

The QVW-1708 supports VESA standard 75 mm hole pattern accessories. Additionally, a desktop stand is available for this product. Please contact Marshall Electronics for further information.

Monitor Front

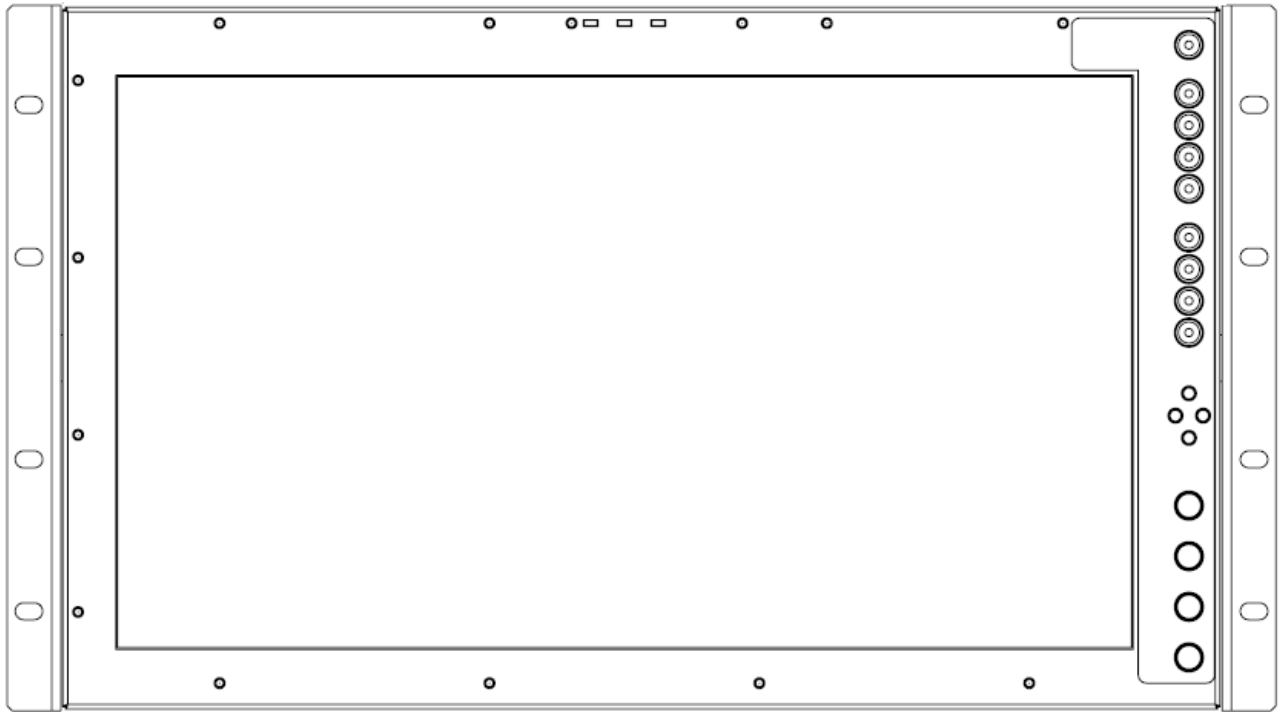

Monitor Rear

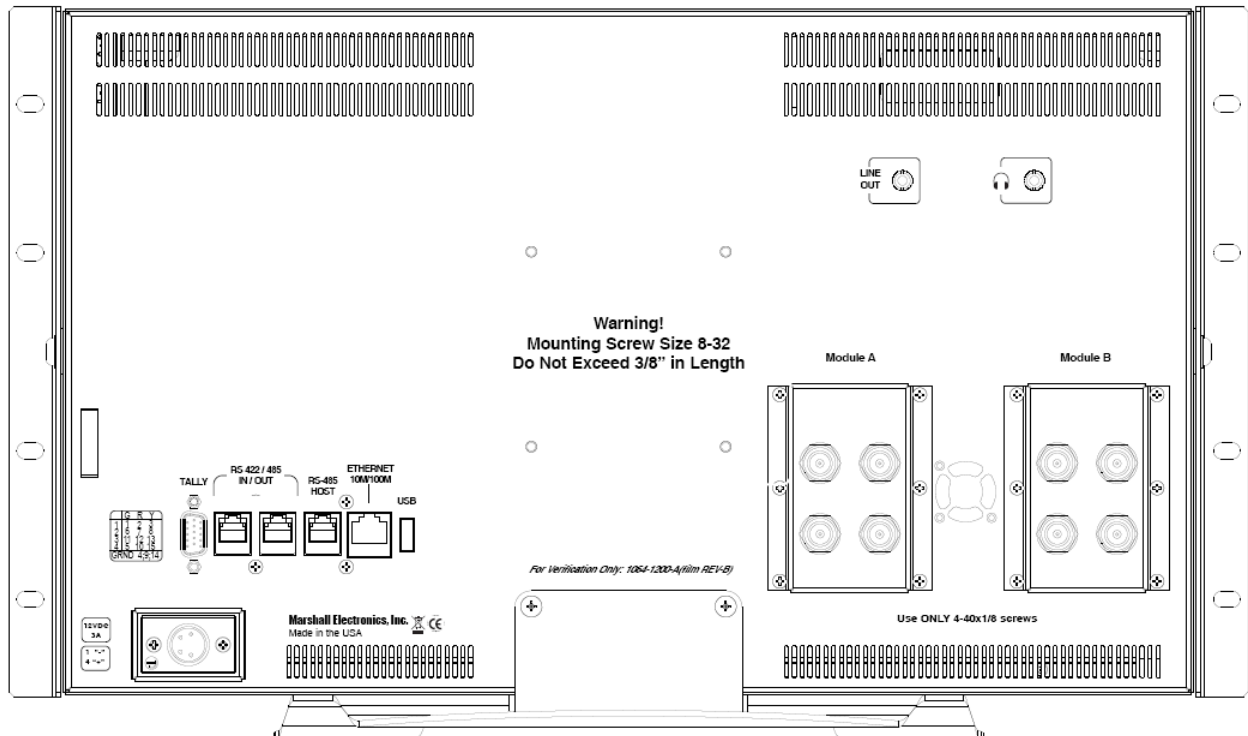

Front Controls

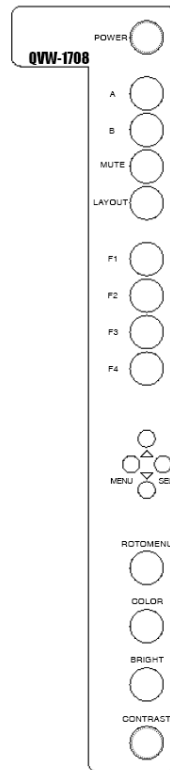

POWER

Control Power going to the front panel.

A – B (Input buttons)

Press the A or B to select which module input to display on the screen. Each press of an input button cycles between the available inputs on that module.

MUTE

Press the MUTE button to mute the output to the headphone jack.

Layout

Press the LAYOUT button to cycle between the available screen layouts.

F1 – F4 (Function buttons)

Press the F1, F2, F3 or F4 buttons to activate the selected functions. The function activated can be changed on the on screen menu.

MENU / ↑ / ↓ / SEL

As an alternative to the ROTOMENU™, these buttons provide the ability to navigate through the menu with the MENU / ↑ / ↓ / SEL buttons.

ROTOMENU™

The RotoMenu™ knob is an alternate means of accessing and navigating the main menu, using only a single control. See the Using the RotoMenu knob section for details on using the RotoMenu. Also, turning the RotoMenu™ knob before pressing it adjusts the Headphone volume on monitors with an available Headphone Jack.

COLOR, BRIGHT, CONTRAST (Image Adjustment Knobs)

Use the image adjustment knobs to adjust color saturation, brightness and contrast of the image. The status of each image adjustment parameter is shown on the bottom left of the screen, with values ranging from 0 to 100. Pressing a knob once displays the current value. Pressing a knob twice resets the corresponding adjustment to the default setting.

Rear Inputs

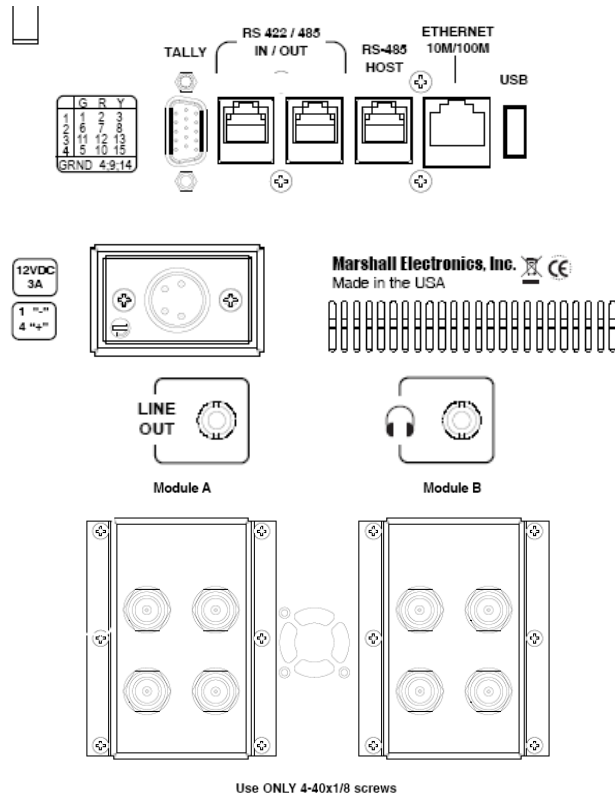

LINE OUT

The Line Out, 1/8", jack on the back of the monitor takes two channels of embedded SDI audio and provides a Line Level Output. The volume is constant and can **not** be adjusted via the VOLUME or MUTE functions on the monitor.

Headphone Jack

The Headphone, 1/8", jack on the front panel takes two channels of embedded SDI audio for your listening pleasure. The Headphone jack provides audio with adjustable levels via the ROTOMENU knob.

TALLY

OSD tally and GPI can be activated via the HD-15 connector by connecting the corresponding pin to ground via dry contact.

A variety of external devices can be used to perform the contact closure. No additional power should be supplied to the HD-15 port.

RS-422 / 485 IN / OUT

The RS-422/485 ports are used to remotely control the MEI Protocol features. (Note: Connector/pin-out may need to be adapted depending on protocol and controlling device used). Only one connection to either port is needed to control the monitor. The second port

can be used to loop multiple monitors in the same bus. See [IMD CONFIGURATION SUBMENU](#) for further details.

RS-485 HOST

Use the RS-485 HOST port to receive data input from Image Video or TSL protocols.

ETHERNET 10M / 100M

You can use the Ethernet port to access the MEI Remote Control page via a web browser such as IE or Firefox.

Network connectivity can be setup in the IP Config menu.

USB (Input port)

The USB port is used for field upgrades. Contact Marshall Electronics for further information.

Module A – Module B

Input slots can be pre-configured at the factory with a variety of modules. Contact Marshall Electronics for information on options.

Power Input

Connect the power input connector here. Power can be supplied from the included power supply, or from a variety of DC sources supplying the voltage and current listed on the silkscreen.

Compatible Input Formats

SDI / HDSI Formats

567i 50, 625i 59.94
720p 23.98, 24, 25, 29.97, 30, 50, 59.94, 60
1035i 59.94, 60
1080p 23.98, 23.98sF, 24, 24sF, 25, 29, 30
1080i 50, 59.94, 60

3G SDI Formats

Level A 1920 x 1080 p

50, 59.94, 60p
23.98, 23.98sF, 24, 24sF, 25, 25sF, 29.97, 29.97sF, 30, 30sF

Level A 1920 x 1080 i

50, 59.94, 60i

Level A 1280 x 720 p

50, 59.94, 60
23.98, 24, 25, 29.97, 30

Level A 2k x 1080 p

23.98, 23.98sF, 24, 24sF, 25, 25sF, 29.97, 29.97sF, 30, 30sF

Level B 1920 x 1080 p

50, 59.94, 60p
23.98, 23.98sF, 24, 24sF, 25, 25sF, 29.97, 29.97sF, 30, 30sF

Level B 1920 x 1080 i

50, 59.94, 60

Level B 2k x 1080 p

23.98, 23.98sF, 24, 24sF, 25, 25sF, 29.97, 29.97sF, 30, 30sF

4K Formats

4096 x 2160 p

4K 50, 59.94, 60
4K 23.98

3840 x 2160 p

4k 50, 59.94, 60
4k 23.98

Input formats that exceed the native display resolution (such as 4K inputs) will be scaled to fit. Best scaling performance occurs with Progressive "p" inputs vs. segmented-frame "sF" inputs.

Screen Layouts

The QVW-1708-Q can display 4 different input sources simultaneously. Each source is scaled and positioned to fit the desired layout. There are a total of 4 different layouts illustrated below. Each press of the Layout Button will switch to the next available layout.

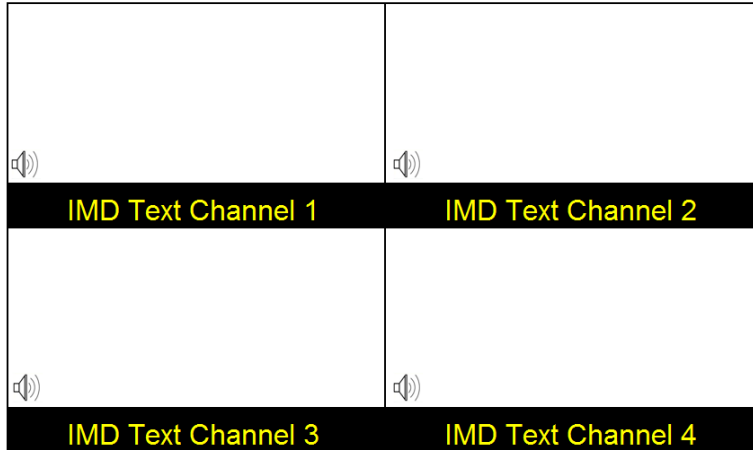

Default Quad Layout

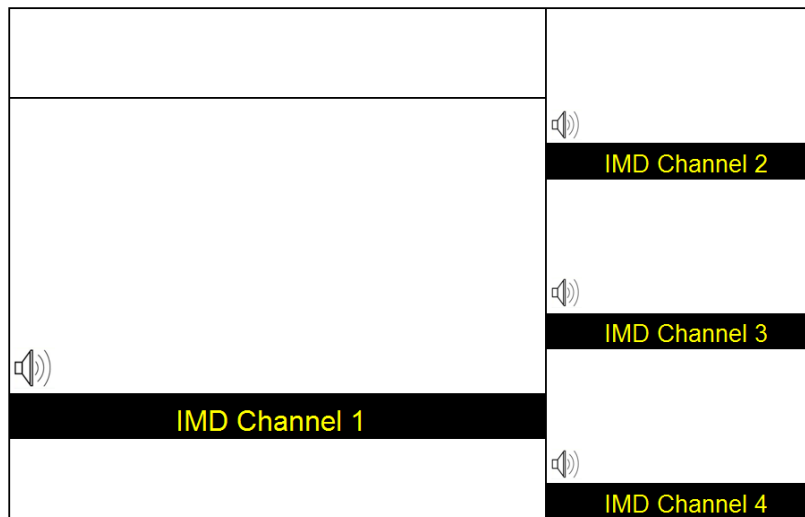

Quad Layout 2

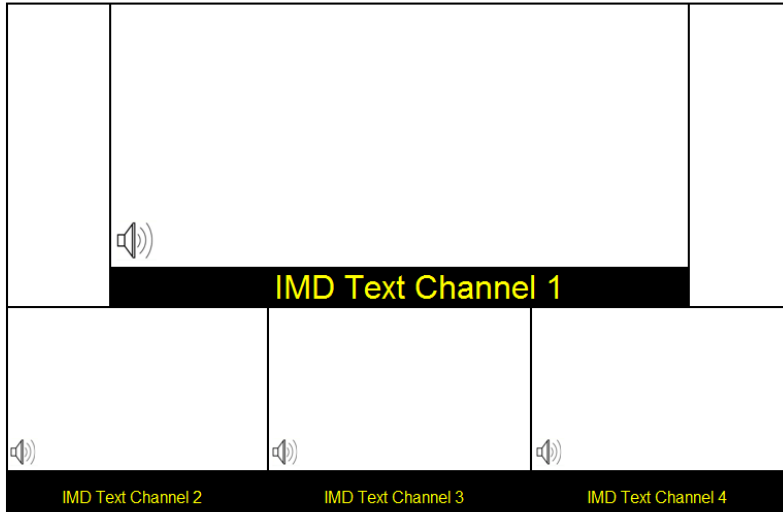

Quad Layout 3

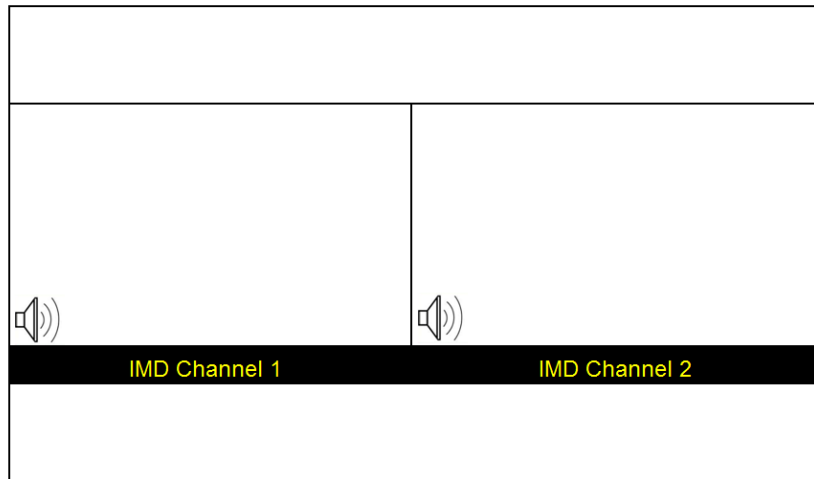

Layout 4

On Screen Menu

Access and navigate the main menu using the RotoMenu™ knob:

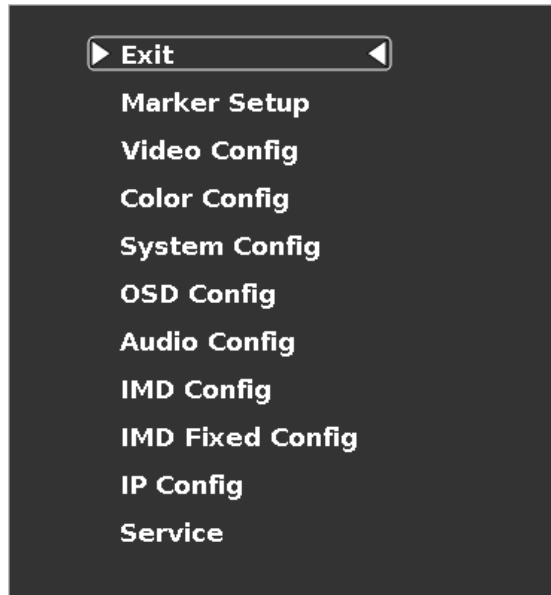

Main Menu

Using the RotoMenu knob

- Press the **RotoMenu™** knob to enter the main menu.
- Rotate the knob to scroll up or down in the main menu or each submenu.
- Press the **RotoMenu™** knob to enter a submenu or choose a setting.
- To return to main menu from submenu, select 'Back' and press the **RotoMenu™**.

The menu timeout can be set in the OSD Timeout section of the OSD Config submenu.

Making Changes to an Individual Channel

The Quad-Viewer RotoMenu allows for Video, Color, System, OSD and IMD Configuration changes to be made to individual channels in the Quad-Viewer system. Items in the menu that can be changed for each individual channel will have a A1, A2, B1, B2 indicator on the right side of the menu and a small white box for each individual channel, as shown below:

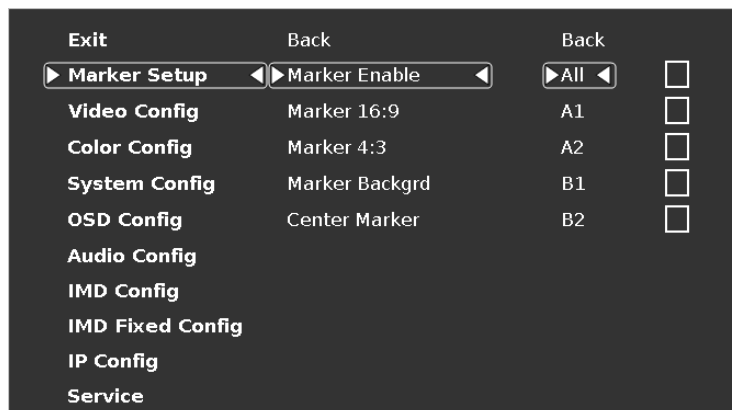

To modify a channel, enter a specific submenu (Marker Setup) and a specific function in that submenu (Marker Enable) by highlighting it with the RotoMenu and pressing the knob to confirm your selection.

Your current position in the menu is indicated by the white highlighted box. When you have selected the desired function, you are given the option of modifying one channel or All channels. Using the RotoMenu, you can select which channel you would like to modify.

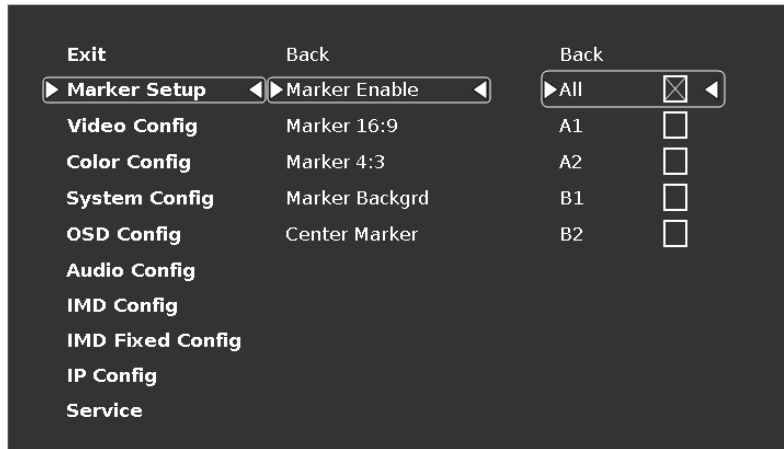

When you apply a change to the particular channel (or All channels), a white X will appear in your chosen channel box when the setting is active in the channel, and the white X will go away when the setting is inactive.

When modifying the A1 channel, the All option will simultaneously be highlighted. This is normal operation and is used by the system software internally to keep track of channel selection and modification.

Marker Setup Submenu

Use the Marker Setup submenu to select various on screen marker options and the opacity of the area surrounding the markers.

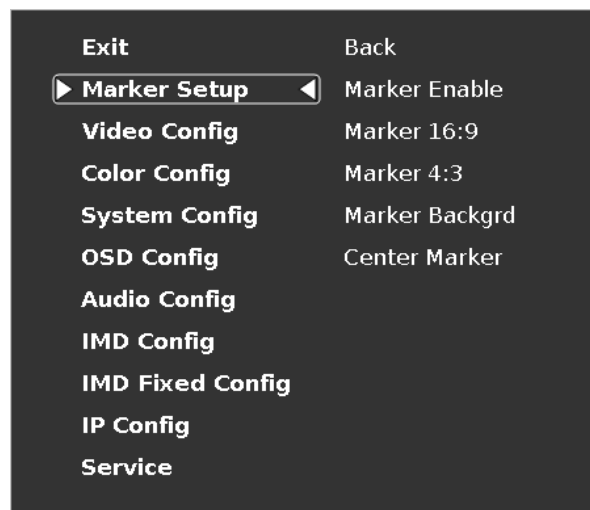

Marker Setup Submenu

■ **Marker Enable**

Enable or disable on screen markers for each individual channel.

■ **Marker 16:9, Marker 4:3**

The Marker 16:9 and Marker 4:3 functions allow you to adjust the screen markers for the 16:9 and 4:3 Aspect Ratios, respectively.

■ **Marker Backgrd**

Use this function to set the opacity of the area outside of the on screen markers. You can choose between Off, 50% and Black.

■ **Center Marker**

Enable or disable the Center Marker cross hairs for each individual channel.

Video Configuration Submenu

Use the Video Configuration submenu to select various video settings such as 4K Mode, Pixel to Pixel mode and other picture related functions.

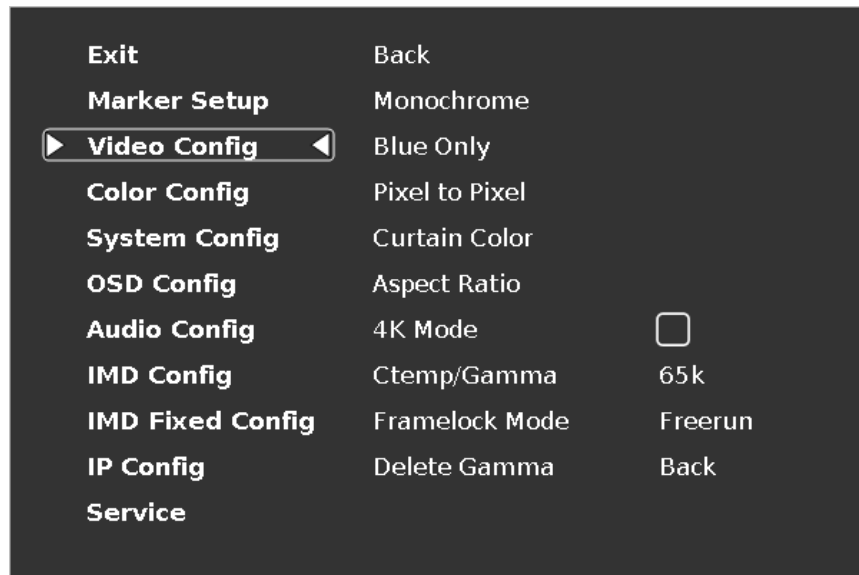

Video Configuration Submenu

■ **Monochrome Mode**

Use this setting to enable monochrome mode. Only the luminance of the image will be displayed as a grayscale picture.

■ **Blue-Only Mode**

Use this setting to enable Blue-Only mode. This mode displays only the blue color component of the image, switching off the red and green components. Use this mode when calibrating the monitor to SMPTE color bars with the following procedure:

1. Allow the monitor to warm up for at least 5-10 minutes.
2. Display SMPTE split-field color bars on the monitor using an external source.
3. Enable Monochrome mode.
4. Locate the pluge pattern (super black, black, and gray bars) at the lower-right corner of the screen. Adjust the Brightness knob until there is no visible difference between the super black and black bars, but the gray bar is still visible.
5. Adjust the Contrast knob until an even grayscale appears along the top bars.
6. Disable Monochrome mode.

Enable Blue-Only mode and adjust the Color knob so that the outermost bars (white and blue) appear to match in brightness.

■ ***Pixel-to-Pixel Mode***

Use this setting to enable Pixel-to-Pixel mode.

This mode bypasses the monitor's internal scaling function and displays images in their native resolution and aspect ratio, with a one-to-one mapping of incoming image pixels to screen pixels:

- For incoming formats smaller than the native resolution of the window (or selected aspect ratio), the image will be displayed in the center of the window using only the necessary LCD pixels. For example, 480i images will only occupy exactly 640x480 pixels in a particular channel window in Quad mode, or if the channel is selected full screen, it will occupy exactly 640x480 pixels in the center of the screen. The surrounding screen area will be black.

■ ***Curtain Color***

Use this setting to choose the default color displayed on the screen when no video input is present. Available colors are red, green, white, black and blue.

■ ***Aspect Ratio Settings***

Use this menu option to switch between several aspect ratio settings.

- In 4:3 mode, images are scaled up or down to fill the maximum 4:3 portion of the screen. IMD text and time code are superimposed on the lower portion of the image. The audio presence indicator and on-screen tally are displayed at the bottom of the screen, outside the image.
- In Scaled 4:3 mode, images are scaled to a smaller 4:3 portion of the screen, leaving space for IMD text, tally, and audio presence indicator to be displayed below or around the image. Time code is superimposed on the lower portion of the image.
- In 16:9 mode, images are scaled to fill the maximum 16:9 portion at the top of the screen. In this mode, IMD text and on-screen tally are displayed below the image. Time code and the audio presence indicator are superimposed on the lower portion of the image.
- In Full Screen mode, images are scaled to fill the entire screen. In this mode, all OSD features are superimposed on the image.

The diagrams on the following page show how IMD text, timecode, and the audio monitor icon are simultaneously displayed on the screen in each aspect ratio setting. The white area represents the video image.

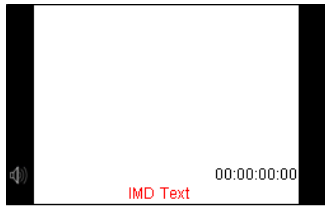

4:3

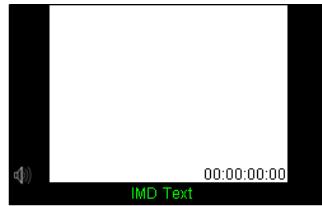

Scaled 4:3

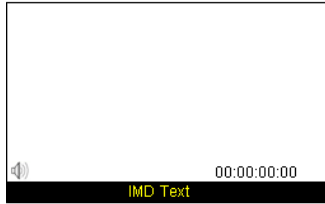

16:9

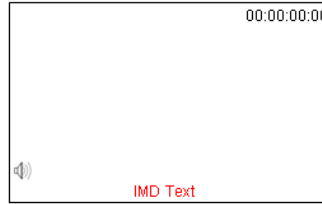

Full Screen (16:10)

■ **4K Mode**

Use this setting to enable the 4K Mode, which synchronizes all four inputs to allow the monitor to display a 4K signal. When in 4K mode, all functions in the menu will be available, and controls for COLOR, BRIGHTNESS and CONTRAST will work on all four quadrants simultaneously.

■ **Ctemp/Gamma**

Use this setting to choose one of three color temperature / gamma presets or to remove gamma settings:

- Linear (No gamma applied)
- 55K
- 65K
- 93K
- Custom Gamma 1-4

If a custom Gamma table has been loaded, it will appear in this section of the menu. Up to 4 Gamma tables can be stored CalMAN 5.2.0.1355 software or above

■ **Delete Gamma**

Use this function to delete gamma tables that have been stored on the monitor via CalMan 5.2.0.1355 software, or other compatible software.

Color Configuration Submenu

Use the Color Configuration submenu to adjust the Red, Green and Blue Offset and Gain values of all four input channels.

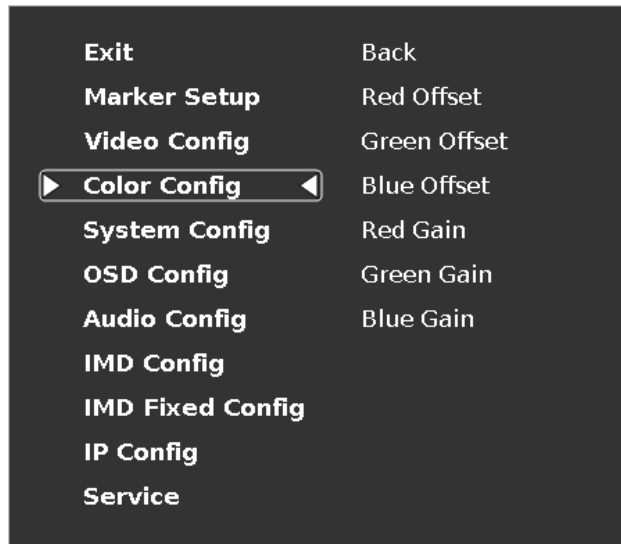

■ ***Red, Green, and Blue Offset***

Use the offset controls for red, green, and blue to adjust the color temperature of the display. Each setting adjusts the offset, or brightness, of each individual color component. These settings will affect whichever color temperature preset is selected.

- Red (0-100)
- Green (0-100)
- Blue (0-100)

■ ***Red, Green, and Blue Gain***

Use the gain controls for red, green, and blue to adjust the color temperature of the display. Each setting adjusts the gain, or contrast, of each individual color component. These settings will affect whichever color temperature preset is selected.

- Red (0-100)
- Green (0-100)
- Blue (0-100)

System Configuration Submenu

Use the System Configuration submenu to control various system parameters such as GPI, function button settings and User definable presets.

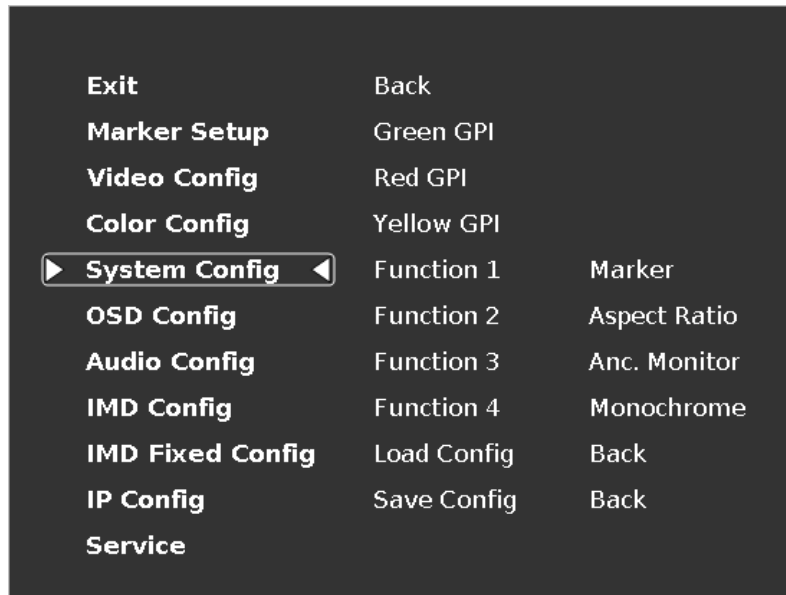

System Configuration Submenu

■ Green, Red and Yellow GPI

Use the Green, Red and Yellow GPI menu items to set a certain action when the Green, Red or Yellow tally connector is activated through dry contact on the tally connector on the back of the unit. The following options are available for each input:

- | | |
|------------------------|---|
| •Tally | Activate the Green, Red or Yellow On Screen Tally |
| •Monochrome | Activate Monochrome mode |
| •Blue Only | Active Blue Only mode |
| •Pixel to Pixel | Activate Pixel to Pixel |
| •Anc. Monitor | Activate the Ancillary data monitor |
| •OSD Tally | Activate the OSD Tally |
| •IMD State | Activate IMD Text Strings on the screen |
| •CTemp / Gamma | Toggle through the different CTemp settings |
| •Layout | Toggle through the available screen Layouts |
| •Aspect Ratio | Toggle through the available Aspect Ratios |
| •Anc. Timecode | Toggle through the Ancillary Timecode options |
| •Marker Level | Toggle through the available Marker background options |
| •Monochrome (L) | Activate the Monochrome function when the Tally pin is set to LOW (dry contact) |
| •Markers (L) | Toggle through the available Markers when the Tally pin is set to LOW (dry contact) |
| •Marker Mask 50% (L) | Activate the 50% Marker Mask when the Tally pin is set to LOW (dry contact) |
| •Marker Mask Black (L) | Activate the Black Marker Mask when the Tally pin is set to LOW (dry contact) |
| •Marker Center (L) | Activate the Center Marker when the Tally pin is set to LOW (dry contact) |

■ **User-Definable Function Buttons**

Use the Function 1 – Function 4 menu items to define each function button on the front panel of the monitor. The following options are available for each button:

•Marker	Enable and rotate amongst marker settings (choices depend on aspect ratio setting)
•Center Marker	Enable/disable center marker
•Marker Enable	Enable/disable screen markers
•Marker Backgrd	Rotate amongst marker backgrounds
•IMD	Display/hide IMD text
•Anc. Time Code	Display/hide time code
•OSD Tally	Rotate amongst types of OSD Tally
•Anc. Monitor	Display/hide ancillary data presence indicator
•User 1-6	Load any of the 6 User Customizable presets
•Aspect Ratio	Toggle between 4:3 and 16:9 aspect ratios
•Pixel to Pixel	Toggle input scaling on or off
•CTemp / Gamma	Load any of the 6 User Customizable presets
•Blue Only	Toggle the Blue only mode on or off
•Monochrome	Toggle Monochrome on or off

■ **Saving and Loading User Presets**

Use the SAVE CONFIG and LOAD CONFIG menus to save current settings to one of 6 presets, or load a preset. Each Preset saves all monitor settings except for IMD configuration.

- Use the LOAD CONFIG menu to load one of presets USR1 – USR6. Factory default settings can also be loaded by selecting MFG. (Factory defaults cannot be overwritten.)
- Use the SAVE CONFIG menu to save the current settings to a preset from USR1- USR6.

OSD Configuration Submenu

Use the OSD Configuration submenu to select a variety of information to be displayed on the screen.

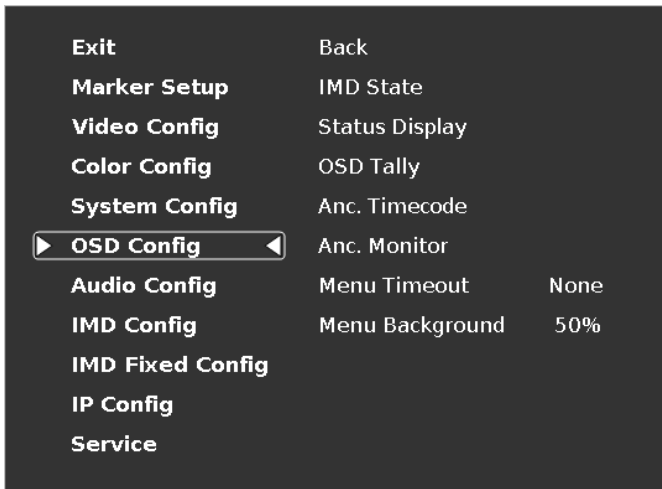

OSD Configuration Submenu

■ **IMD State**

Use this setting to enable or disable the IMD text display. This setting affects both the fixed string (entered through display menus) and remote IMD text commands.

■ **Status Display**

Use this setting to enable or disable status display. When enabled, the current video input standard is displayed on the top left of the screen. When disabled, status is only displayed for 2 seconds when the monitor is powered on, when an input is applied, or when the input video standard changes. The status display reads “No Input” when no video input is present.



Status Display

■ OSD Tally

Use this setting to choose how tally is displayed on the screen. The available OSD Tally options depend on the Tally Source selected in the IMD Configuration submenu.

When the Tally Source is set to Standard (contact closure), OSD Tally can be set to **Off**, **RGY**, **RG**, or **GR**:

- **Off** On-screen tally is disabled
- **RGY** Red, yellow, or green tally signals are indicated at both the bottom left and bottom right corners of the screen. Two or three colors are shown simultaneously by subdividing each tally indicator
- **RG** Red tally is shown at the bottom left of the screen, and green is shown at the bottom right.
- **GR** Green tally is shown at the bottom left of the screen, and red is shown at the bottom right.

The following diagrams show RGY, RG, and GR OSD Tally modes:

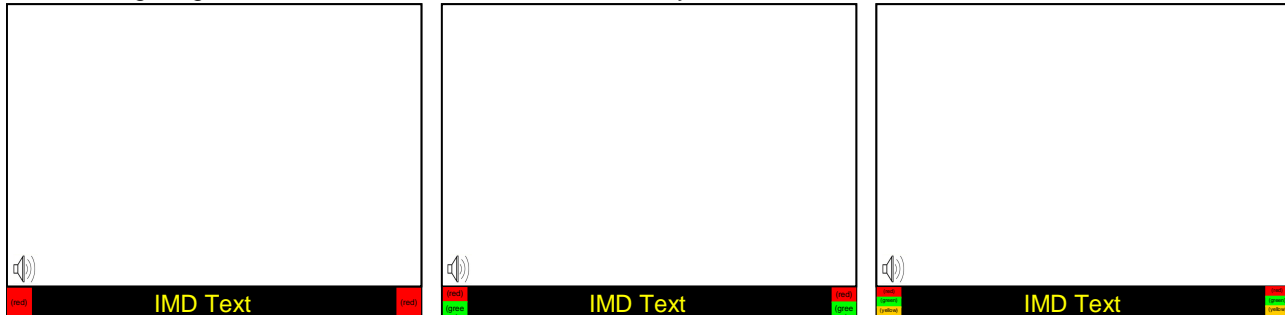

RGY mode: single color activated

RGY mode: two colors activated

RGY mode: three colors activated

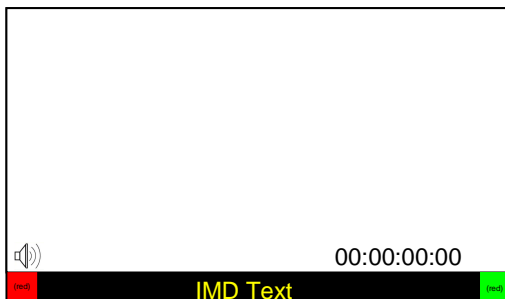

RG Mode: both colors activated

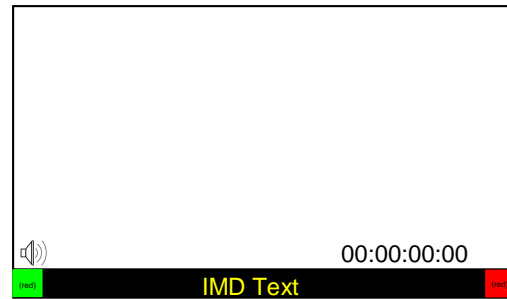

GR Mode: both colors activated

When the Tally Source is set to TSL/MEI 422, OSD Tally can be set to **Off** or **IMD**:

- **Off** On-screen tally is disabled
- **IMD** Red, yellow, and green tally is displayed according to the protocol commands. Green, red, and yellow colors are shown individually on either the bottom left or right of the screen.

■ Anc. Time Code

Use this setting to enable time code display on the screen. Time code is de-embedded from the vertical ancillary data (VANC) within the HD/SDI signal. Two types of time code can be selected to display on the screen: **LTC (linear time code)** or **VITC (vertical interval time code)**.

The position of the time code display varies based on the aspect ratio setting and presence of IMD text



■ **Anc. Monitor**

Use the Ancillary Monitor menu option to enable or disable on screen audio, closed caption and timecode presence indicators. When enabled, Audio, CC608, CC708, LTC and VITC indicators are shown on the screen. A green circle will appear next to each data type if it is present in the SDI stream.



*Ancillary Monitor with input signal
with no ancillary data*



*Ancillary Monitor with input signal
with Audio, 608 CC and LTC
timecode.*

■ **Menu Timeout**

Select how long the Menu will remain active on the screen. Choose between **None** (no Menu timeout) to **30 Seconds** in 5 second increments.

■ **Menu Background**

Select the transparency of the Menu Background. Choose between **Off** (Menu background is completely transparent), **50%** or **Solid** (video behind the menu cannot be seen).

Audio Config Submenu

Use the Audio Configuration submenu to configure Audio channel selection for the headphone jack, audio level and on screen audio display.

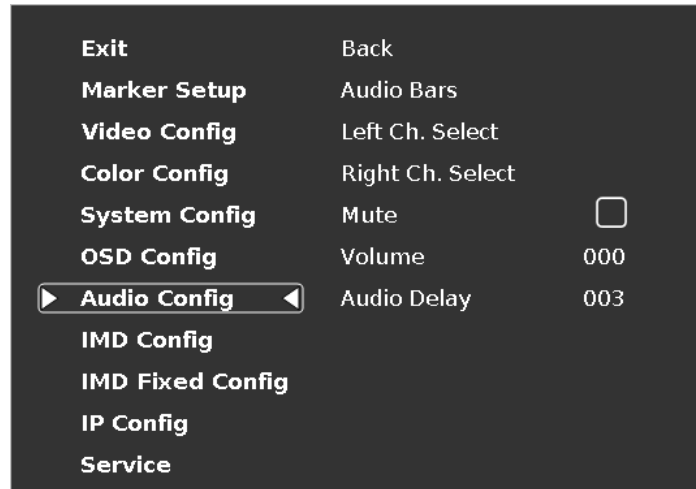

Audio Configuration Submenu

■ Audio Bars

This monitor provides audio level indicators for SDI streams with embedded audio. Support for up to 16 channels (labeled as Groups 1, 2, 3 and 4) is provided.

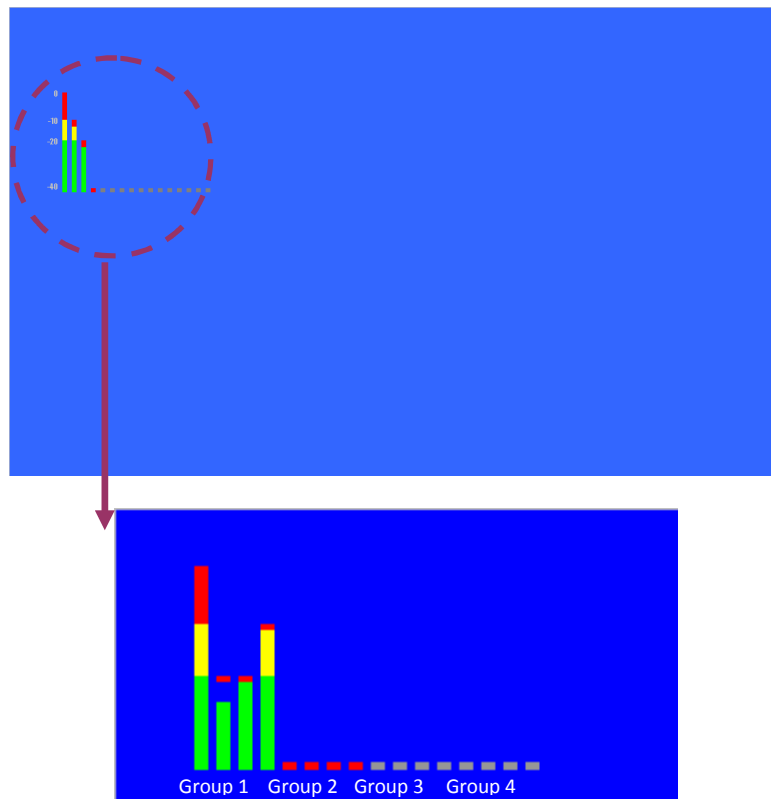

Audio groups 1-4 shown on the screen

■ **Left Ch. Select**

Use this setting to select which of the 16 possible channels you would like to monitor on the **Left** side of the stereo output.

■ **Right Ch. Select**

Use this setting to select which of the 16 possible channels you would like to monitor on the **Right** side of the stereo output.

■ **Mute**

The Mute function disables audio output from Headphone output on the monitor. *This will **NOT** control the Line Out level of the monitor, only the Headphone output.*

■ **Volume**

The Volume control determines the output level for the Headphone out on the monitor. *This will **NOT** control the Line Out level of the monitor, only the Headphone output.*

■ **Audio Delay**

The Audio Delay function applies a delay to the Audio Metering and audio output. Use the function to select a delay between 000 and 015 (in terms of fields, or frames if the signal is progressive).

IMD Config Submenu

The QVW-1708-Q features an In-Monitor Display (IMD) with the ability to display on-screen text and tally in three colors. IMD text, color, and alignment can be assigned to each input locally using menu options (see below).

Alternately, IMD text and tally can be remotely controlled via the RS-422/485 serial interface using several industry-standard protocols, including TSL v4.0 and Image Video. Multiple QVW-1708-Q monitors can be looped together and each addressed individually via the protocol. All menu features of the QVW-1708-Q can also be controlled via the embedded MEI Remote page.

Use the IMD Configuration submenu to configure various IMD parameters as described below. IMD State can be enabled / disabled through the OSD Config submenu.

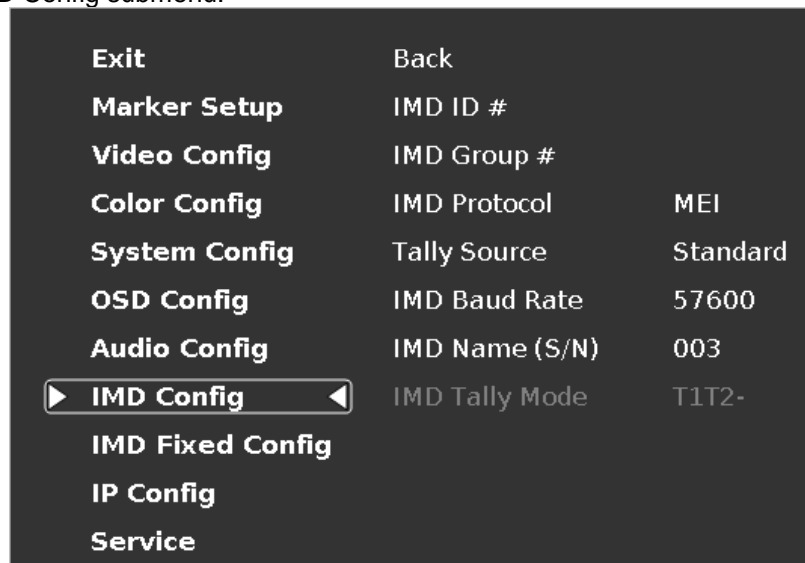

IMD Configuration Submenu

■ **IMD ID #**

The IMD ID # identifies each screen to the controlling device. When using the TSL protocol, the ID # of each screen should be manually set in conjunction with the controlling device. When using the Image Video protocol, the ID # may be set automatically by the controlling device, after each IMD is initially identified by IMD Name. Available ID #s are **000-254**.

■ **IMD Group #**

Each screen can be assigned an IMD Group # when using the Marshall protocol. Available Group #s are **01-254**.

■ **IMD Protocol**

Use the IMD Protocol menu option to choose the protocol with which the QVW-1708-Q receives remote commands. Currently, four protocols are available. Contact Marshall Electronics for the latest protocol compatibility.

MEI

Use the MEI protocol setting when controlling the QVW-1708-Q using the Marshall Network Controller box. This protocol allows remote control of all features on the QVW-1708-Q, including marker setup, video configuration, system configuration, and image adjustments (brightness, contrast, etc.). The **IMD #**, **IMD Group #**, and **Baud Rate** parameters must be set in conjunction with the Network Controller Box.

TSL v4.0

Use the TSL v4.0 protocol setting when controlling the IMD from a TSL tally controller, or other controlling device which utilizes the TSL v4.0 protocol. The **IMD #** must be set for each screen in conjunction with the controlling device.

Image Video

Use the Image Video protocol setting when controlling the IMD from an Image Video tally controller (e.g. TSI-1000) or other controlling device which utilizes the Image Video protocol. The **IMD #**, **IMD Name(S/N)**, and **Baud Rate** parameters must be set for each screen in conjunction with the controlling device.

■ **Tally Source**

The QVW-1708-Q OSD tally can be controlled in a variety of different ways. Use the Tally Source setting to choose how tally is controlled:

Standard

Use the Standard setting to control tally via contact closure on the HD-15 tally interface.

Image Video HW

Use the Image Video HW setting to control Image Video tally states via contact closure on the HD-15 tally interface. Contact closure of the **Red** pin corresponds to **Image Video Tally 1**, and the **Green** pin maps to **Image Video Tally 2**. Contact closure (ground) corresponds to a LOW state, and open circuit corresponds to a HIGH state. This mode requires the IMD Tally Mode parameter to be set. Consult Image Video documentation for further information.

Image Video 422

Use the Image Video 422 setting to control Image Video tally states via the Image Video serial protocol. OSD tally will be disabled in this mode, as Image Video tally states are manifested in the text color and other parameters. This mode requires the IMD Tally Mode parameter to be set. Consult Image Video documentation for further information.

Standard + IV422

Use the Image Video 422 setting to control Image Video tally states via the Image Video serial protocol, while controlling OSD tally using contact closure on the HD-15 tally interface. This mode requires the IMD Tally Mode parameter to be set. Consult Image Video documentation for further information.

TSL/MEI 422

Use the TSL/MEI 422 setting to control OSD tally via the TSL or Marshall serial protocols.

■ **IMD Baud Rate**

Use this setting to choose the baud rate. The baud rate must be set in conjunction with the controlling device. Available baud rates are **300, 600, 1200, 2400, 4800, 9600, 19200, 38400, 57600, 115200**. The TSL v4.0 protocol is fixed at 38400 bauds for correct functionality, but this can be changed on the monitor for custom purposes.

■ **IMD Name (S/N)**

Use this setting to assign a name to each screen when using the Image Video or Marshall-IV protocols. The IMD name is equivalent to the Image Video serial number and is used by the Image Video controlling device to identify each screen. The default IMD Name(S/N) is "M00000." It is recommended to maintain this naming scheme in order to avoid serial number conflicts with other Image Video devices on the same serial bus. Each name can be up to 16 ASCII characters.

Press RotoMenu™ knob to edit the IMD Name. Rotate the RotoMenu™ knob to move the cursor. Press the RotoMenu™ knob with the cursor on the character to be changed, then rotate the knob to scroll through the character set. Press the RotoMenu™ knob to choose a character.

■ **IMD Tally Mode**

Use this setting when using Image Video tally control. Choose one of the following settings, in conjunction with the Image Video controlling device. **T1, T2, T1T2, T2T1, T1-, T2-, T1T2-, T2T1-**. Consult Image Video documentation for further information.

IMD Fixed Config Submenu

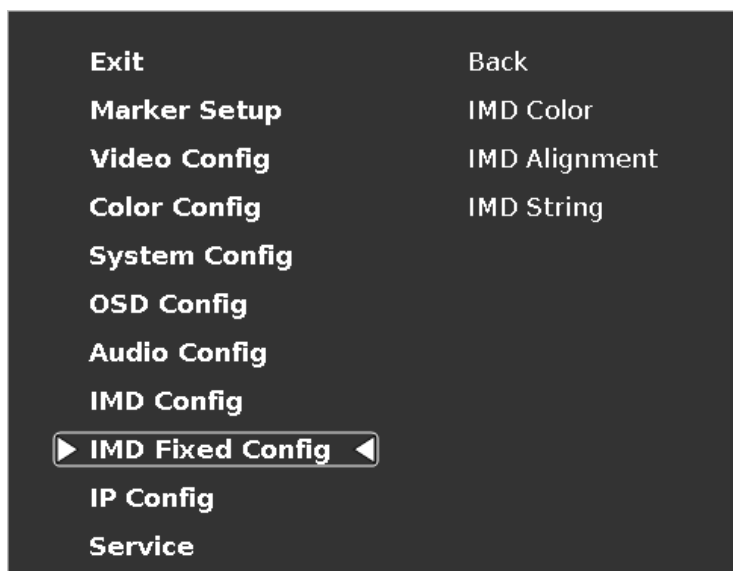

IMD Fixed Configuration Submenu

■ **IMD Color**

Use this setting to choose the color of the IMD Fixed String text (see below). Available colors are red, green, and yellow. This setting does not affect text color when using IMD text via the Image Video or TSL v4.0 protocols (text color is set via the protocols).

■ **IMD Alignment**

Use this setting to choose the horizontal alignment of the IMD text. IMD text can be justified on the left, center or right of the screen. This setting is overridden when using IMD text via the Image Video protocol (alignment is set via Image Video protocol).

■ **IMD String**

Use this setting to display static IMD text on the screen. This setting is used to enter IMD text locally, when a serial protocol is not used for remote control. The IMD Fixed String is saved after power cycle. *The IMD Fixed String will be overridden by serial protocol commands.*

IP Config Submenu

The IP CONFIGURATION submenu is intended to configure settings for access to the embedded Network Control Platform on the QVW monitor series. Please consult with your network administrator to ensure compatibility with your network.

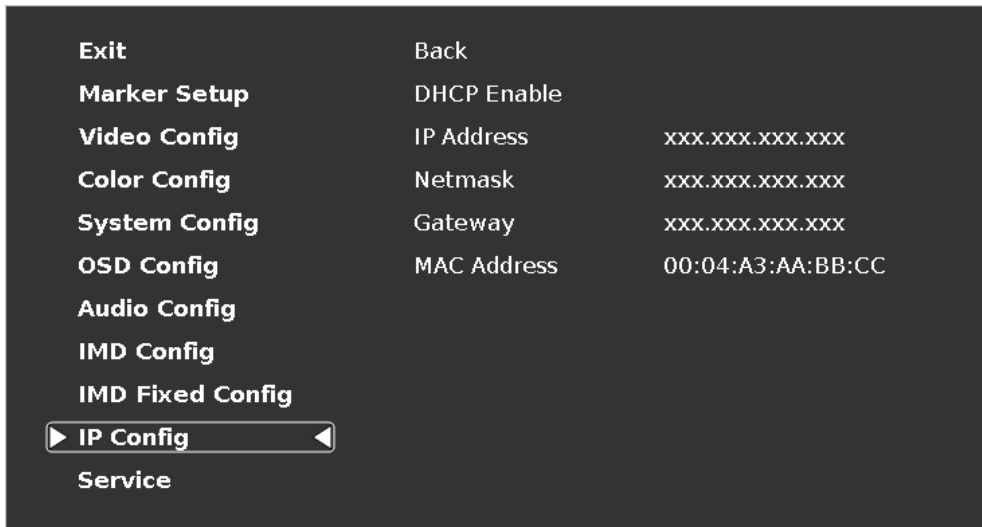

IMD Fixed Configuration Submenu

■ **DHCP Enable**

Use DHCP to set the IP Address, Netmask and Gateway automatically.

■ **IP Address**

Use this field to manually set an IP Address for a particular monitor. If you enable DHCP, this will be automatically set for you based on your current Network settings.

■ **Netmask**

Use this field to set the appropriate Netmask compatible with your network. If you enable DHCP, this will be automatically set for you based on your current Network settings.

■ **Gateway**

Use this field to set the appropriate Gateway compatible with your network. If you enable DHCP, this will be automatically set for you based on your current Network settings.

■ **MAC Address**

The MAC address is an internal fixed address for each individual monitor. You may wish to refer to this value when setting up your network.

Service Submenu

■ **Software Version Display**

This submenu will give you access to Software versions for each of the key components of the system.

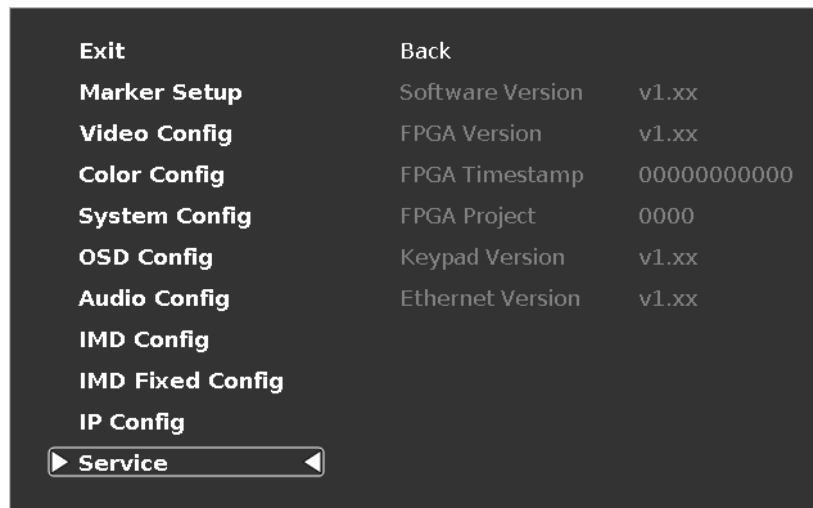

Service Menu

Monitor Specifications

Panel Specifications

Screen Size	17.3"
Screen Resolution	1920 x 1080
Brightness	400 cd/m²
Contrast Ratio	600:1

Burn-In Warning

The QVW-1708-Q uses a high quality LCD panel. However, if a static image is left on the screen for 48 hours, there may be a 10 to 20 minute recovery period for the panel. During recovery, a very faint image may be retained on the display. Put up a white image for 30 minutes to eliminate the retained image.

Connectors

Modular Inputs
2 x Input Module Slots

Video Inputs / Outputs
Optional Modules Available – 3G-SDI (2 x Input / Output)

Power Input
4-Pin XLR

Tally / GPI Interface
HD-15 Female connector

RS-422/485 Interface
2 x RJ12 (Modular 6P6C)
1 x RJ12 (Host port)

Ethernet (Remote Control Page)
1 x RJ45

Electrical

Voltage Requirement	12 VDC
Power Consumption	5.0 A
Included Power Supply	V-PS12V-5A-XLR

Tally / GPI Connector

	G	R	Y
1	1	2	3
2	6	7	8
3	11	12	13
4	5	10	15
GRND 4;9;14			

Connect the corresponding pins (under G,R,Y), and execute a dry contact closure by connecting it to either of the GRND pins listed.

Mechanical

Weight	9.35 Lbs
Operating Temperature	0° C – 35° C
Storage Temperature	-10° C – 50° C

Dimensions

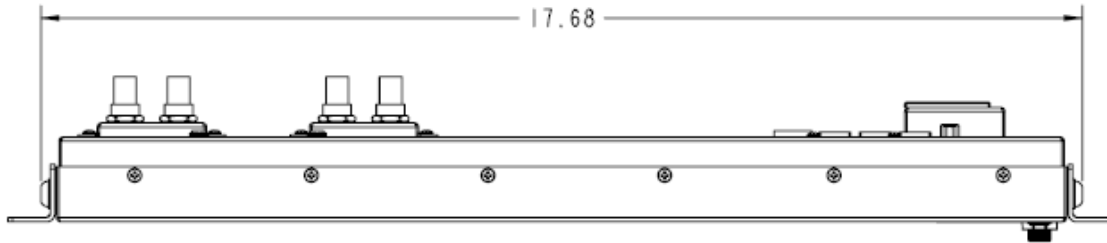
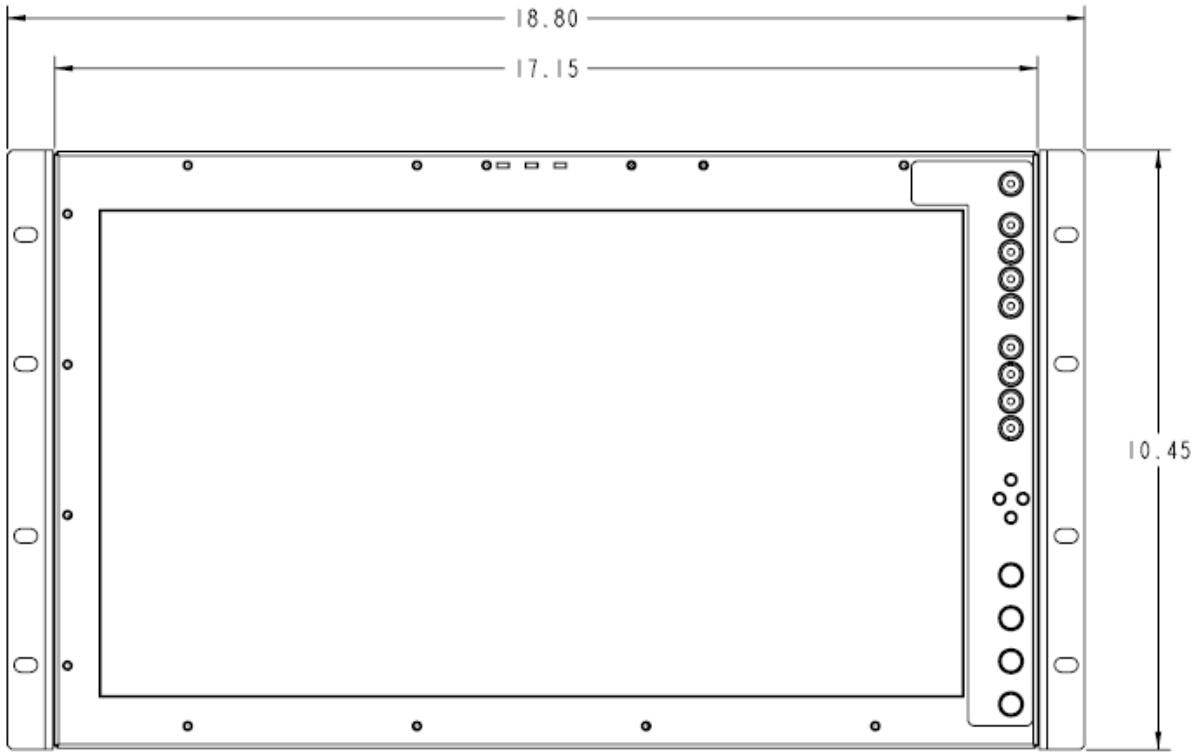

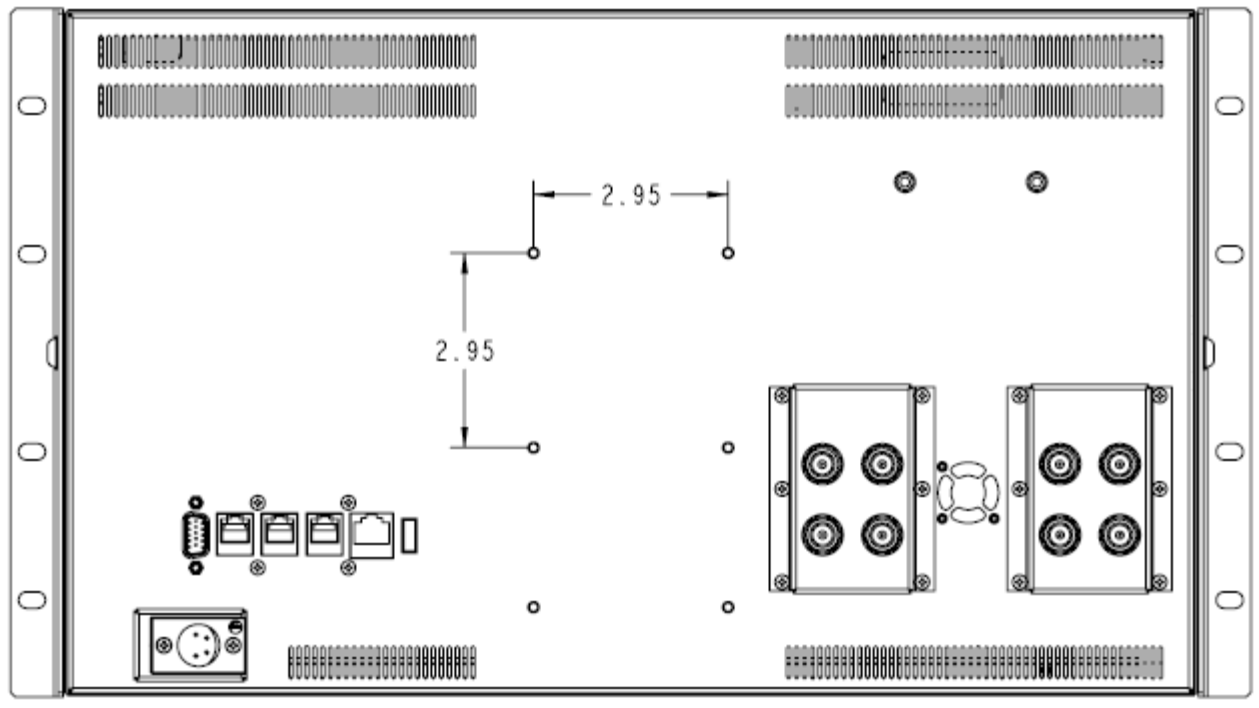
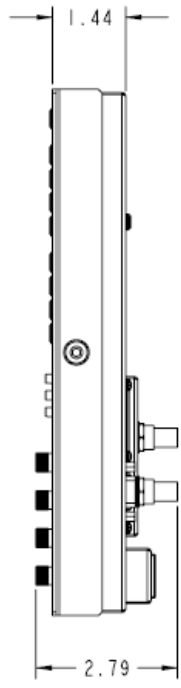

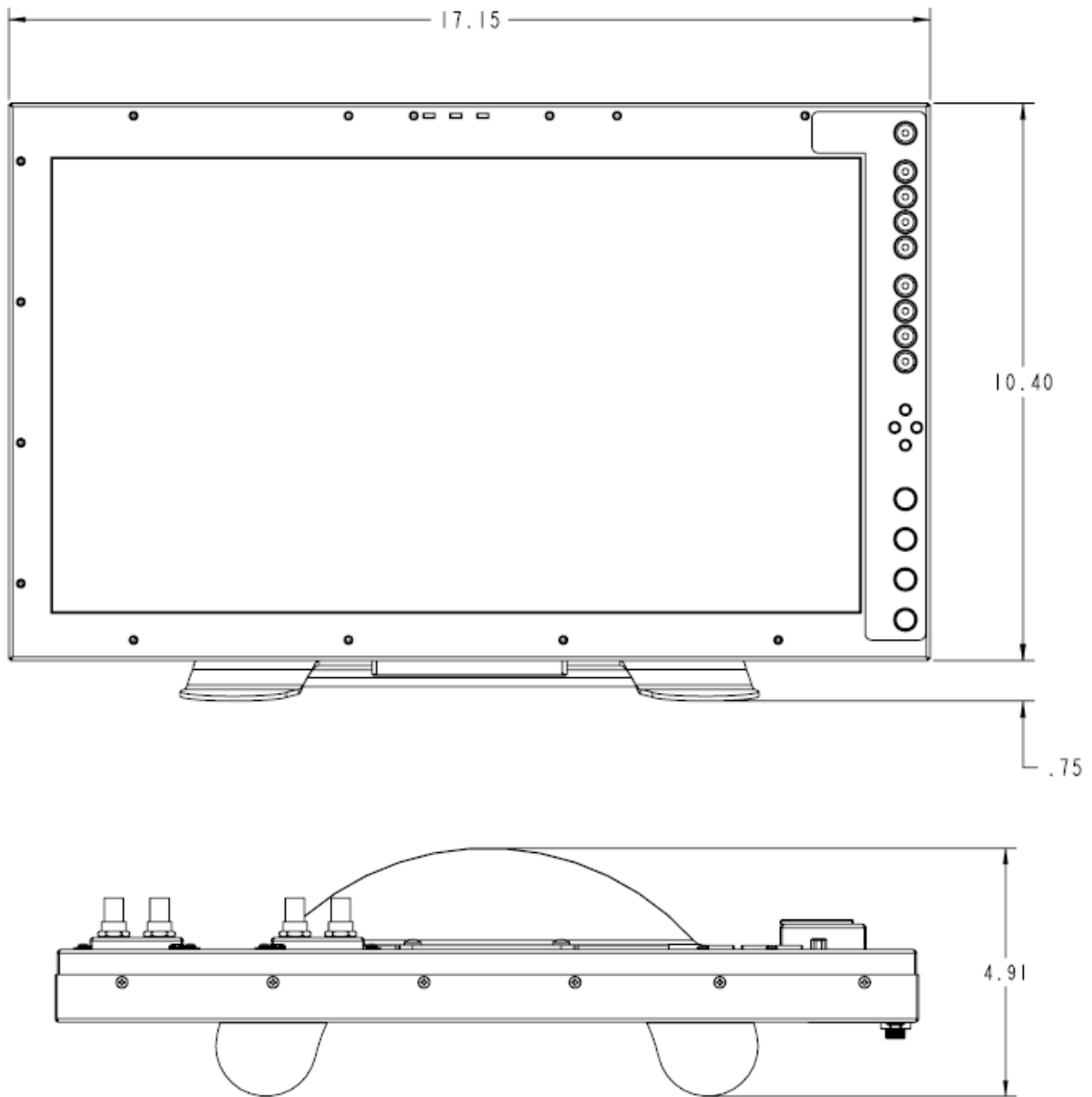

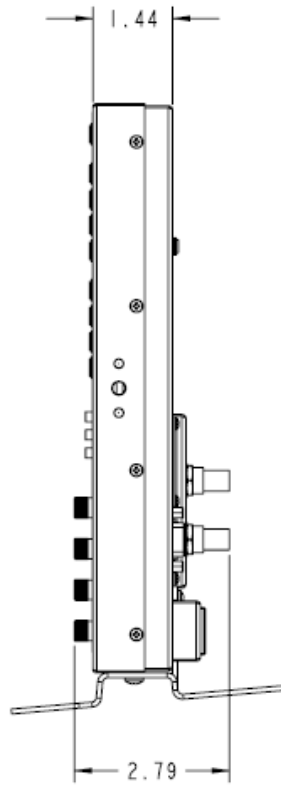

Warranty

Marshall Electronics warrants to the first consumer that this QVW-1708 LCD monitor will, under normal use, be free from defects in workmanship and materials, when received in its original container, for a period of one year from the purchase date. This warranty is extended to the first consumer only, and proof of purchase is necessary to honor the warranty. If there is no proof of purchase provided with a warranty claim, Marshall Electronics reserves the right not to honor the warranty set forth above. Therefore, labor and parts may be charged to the consumer. This warranty does not apply to the product exterior or cosmetics. Misuse, abnormal handling, alterations or modifications in design or construction void this warranty. It is considered normal for a minimal amount of pixels, not to exceed three, to fail on the periphery of the display active viewing area. Marshall Electronics reserves the option to refuse service for display pixel failure if deemed unobtrusive to effective use of the monitor by our technicians. No sales personnel of the seller or any other person is authorized to make any warranties other than those described above, or to extend the duration of any warranties on behalf of Marshall Electronics, beyond the time period described above. Due to constant effort to improve products and product features, specifications may change without notice.