

Welcome!

We greatly appreciate your purchase of a UT Series. We are sure you will find it reliable and simple to use. Superior performance for the right price, backed by solid technical and customer support is what ALTINEX has to offer.

We are committed to providing our customers with Signal Management Solutions® to the most demanding audiovisual installations at competitive pricing and we welcome you to join the ranks of our many satisfied customers throughout the world.

1. Precautions and Safety Warnings

Please read this manual carefully before using your UT-Series Interconnect. Keep this manual handy for future reference. These safety instructions are to ensure the long life of your UT-Series Interconnect and to prevent fire and shock hazards. Please read them carefully and heed all warnings.

1.1 General

- There are no user serviceable parts inside. Qualified ALTINEX service personnel must perform all service on the UT-Series.

1.2 Handling

- To prevent fire or shock, do not expose this unit to water or moisture. Do not place the UT-Series in direct sunlight, near heaters, or heat-radiating appliances, or near any liquid. Exposure to direct sunlight, smoke, or steam can harm internal components.
- Handle the unit carefully. Dropping or jarring can cause damage.
- Do not pull any cables that are attached to the UT-Series.
- Do not place heavy objects on top of the UT-Series.

2. Installation Procedures

The UT Series can be installed horizontally or vertically as shown. Typically, units are installed under a tabletop, but in some cases, it may be desirable to install a unit inside a desk opening, or on the back of a desk or podium.

- Step 1. Locate the best position for the UT Interconnect, but do NOT mount it to the surface until cables are ready.
- Step 2. Prepare the mating cables using high-quality cables for best results and durability. Make sure the cables are long enough to allow for a service-loop and so the cables can be neatly routed beneath the table to their destinations.
- Step 3. Prepare network cables using the CAT-6 (RJ-45) connectors provided with the unit.* The connectors are high-quality snap-in connectors and do not require any tools for installing them into the UT interconnect.

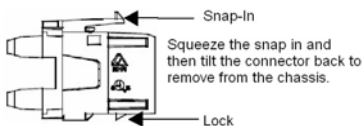

Note: Connectors are provided but do not include cables. ALTINEX recommends a telecommunications contractor wire the network connectors and verify operation before installing the UT interconnect.

- Step 4. Secure the unit under the table using the metal screws provided with the unit.
- Step 5. Make any necessary connections to the snap-in connectors.
- Step 6. Use cable-ties to secure the cables to the mounting shelf. Insert the ties through the holes on the bottom of the unit.
- Step 7. Use the cable clamps provided to secure the cables to the bottom of the table/desk.

* Not all units include network connections. Please visit our website: www.altinex.com for information related to the pin out of the cables.

3. Limited Warranty/Return Policies

Please see the ALTINEX website at www.altinex.com for details on warranty and return policies.

1.3 Cleaning

- Unplug the UT-Series before cleaning.
- Clean only with a dry cloth. Never use strong detergents or solvents such as alcohol or thinner. Do not use a wet cloth or water to clean the unit. Do not open the unit to clean.

1.4 FCC Notice

- This device complies with Part 15 of the FCC Rules. Operation is subject to the following two conditions: (1) This device may not cause harmful interference, and (2) this device must accept any interference received, including interference that may cause undesired operation.
- This equipment has been tested and found to comply with the limits for a Class A digital device, pursuant to Part 15 of the FCC Rules. These limits are designed to provide reasonable protection against harmful interference when the equipment is operated in a commercial environment. This equipment generates, uses, and can radiate radio frequency energy and if not installed and used in accordance with instructions found herein, may cause harmful interference to radio communications. Operation of this equipment in a residential area is likely to cause harmful interference in which case the user will be required to correct the interference at his own expense.
- Any changes or modifications to the unit not expressly approved by ALTINEX, Inc. could void the user's authority to operate the equipment.

Installation Options

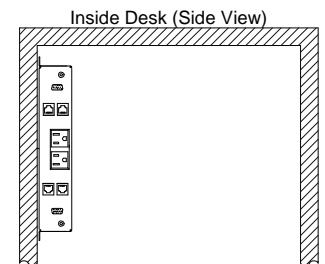
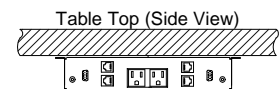

Back of Desk/Podium (Top View)

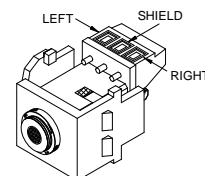
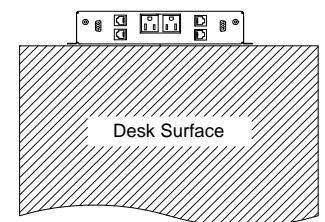

UT240-278 Audio Wiring

4. Technical Specifications

Specifications are subject to change. See www.altinex.com for up-to-date information.

Features/Description	UT240-300 Series		
Pass-Through	<i>(front to back)</i>		
AC Power	NEMA Receptacle to plug <i>9-10 ft (2.7-3.0 m) cord</i>		
Audio, Stereo Cable	3.5 mm F-F <i>8 in (200 mm) cable</i>		
Audio, Stereo TB	3.5 mm F to Term Block		
Audio, Stereo RCA	RCA bulkhead F-F		
Network (CAT-6)	Snap-in RJ-45 connector <i>(no cable)</i>		
Modem/phone	Snap-in RJ-11 connector <i>(no cable)</i>		
Video, Analog	15-pin HD bulkhead, F-F		
Video, Digital	19-pin HDMI bulkhead, F-F		
Video	BNC bulkhead F-F		
Communication	USB Type A F-F		
Models	<i>(options)</i>		
UT240-278 (U.S.)	CAT-6 (RJ-45) F	(1)	
	Modem (RJ-11) F	(1)	
	AC receptacle	(1)	
	15-pin HD F-F	(1)	
	3.5mm F to Term Block	(1)	
	BNC F-F	(1)	
UT240-311 (U.S.)	CAT-6 (RJ-45) F	(4)	
	AC receptacle	(2)	
UT240-313 (U.S.)	15-pin HD F-F	(2)	
	24-pin DVI F-F	(2)	
	3.5mm F-F	(2)	
	CAT-6 (RJ-45) F	(4)	
UT240-310 (U.S.)	15-pin HD F-F	(2)	
	AC receptacle	(2)	
UT240-411 (EUR)	CAT-6 (RJ-45) F	(4)	
UT240-451 (ENG)	3.5mm F-F	(2)	
UT240-511 (AUS)	AC receptacle	(2)	
UT240-551 (UNIV)	CAT-6 (RJ-45) F	(4)	
	AC receptacle	(4)	
	15A Circuit Breaker	(1)	

Continued...

UT240-121S (U.S.)	CAT-6 (RJ-45) F	(1)
	Modem (RJ-11) F	(1)
	AC Power	(1)
	15-pin HD F-F	(1)
UT240-125S (U.S.)	3.5mm F to Term Block	(1)
	CAT-6 (RJ-45) F	(1)
	USB Type A F-F	(1)
	AC Power	(1)
UT240-128S (U.S.)	15-pin HD F-F	(1)
	3.5mm F to Term Block	(1)
	CAT-6 (RJ-45) F	(1)
	Digital Vid (HDMI) F-F	(1)
UT240-325S (U.S.)	AC Power	(1)
	15-pin HD F-F	(1)
	3.5mm F to Term Block	(1)
	CAT-6 (RJ-45) F	(2)
UT240-328S (U.S.)	Digital Vid (HDMI) F-F	(2)
	AC Power	(2)
	3.5 mm Stereo Cable	(2)
	CAT-6 (RJ-45) F	(2)
Agency Approvals		
UL/CUL Listed (File E254082)	UT240-278/-310/-311/-312/-313	
Accessories Included		
Hardware	Mounting hardware	

Table 1. UT240-300 Series General

Mechanical	UT240-300 Series
Dimensions	See Application Diagrams
Maximum Shipping Weight*	3.5 lb. (1.6 kg)
T° Operating [T° Maximum]	10°C-35°C [50°C]
Humidity	90% non-condensing

Table 2. UT Series Mechanical

Electrical	UT240-300 Series
Pass-Through Signals	All standard audio, video, network, and modem signals are acceptable.
Pass-Through AC	12 A, 1440 W max. (total through all receptacles)

Table 3. UT Series Electrical

* Shipping weights range from 2.1 lb. for the UT240-278 up to 3.5 lb. for the UT240-550 (1.0 kg to 1.6 kg).

Packaging material is approximately 0.5 lb. or 0.23 kg.

5. About Your UT Interconnect

The ALTINEX UT-Series of Under-the-Table AV Interconnects provide a wide variety of options for routing computer audiovisual signals, network connections, and AC power. Under-the-table options are ideal for situations where it is too expensive or impractical to install the routing interface directly into the furniture.

The UT240-300 Series are available in both U.S. and international versions. U.S. versions provide standard NEMA 5-15R receptacles; international units include AC receptacles for Europe, England, and Australia. The UT240-550 and UT240-551 include universal AC receptacles that accept various types of AC plugs. U.S. and international models UT240-312, UT240-410, UT240-450, UT240-510, and UT240-550 also include a push-to-reset 15A circuit breaker.

Each unit comes standard with 1 or more AC receptacles and 1 or more RJ-45 connectors. The UT240s connect to standard AC power outlets through a single 9-10 ft (2.7 to 3.0 m) power cord that is permanently attached to the unit. The CAT-6 (RJ-45) connectors are snap-in style connectors that attach to a support bracket inside the faceplate. The connectors must be "snapped" out of the bracket, wired to the CAT-5/6 cable, and then "snapped" back.

The UT240-300 Series units with audio inputs have 3.5 mm female inputs on the front of the unit and 3.5 mm female inputs on the back via an 8 in (200 mm) cable. The audio receiving devices attach to the cable on the back of the unit. The Under-the-Table units with model numbers ending in 121S, 125S, 128S, and 278 have a 3.5 mm female input on the front and a terminal block connector with captive screws on the back of the unit.

Units with video connectors have female-to-female bulkhead connectors for HDMI, 15-pin HD, and 24-pin DVI types. The video receiving devices attach to the bulkhead connectors accessible on the back of the unit.



UT240-313 shown here.

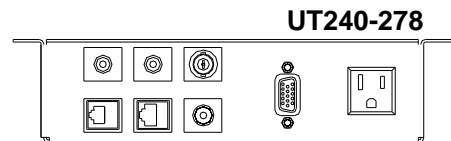

UT240-278
AC (1) RCA (2) Audio (1)
Phone/modem (1) Net (1) VGA (1) BNC (1)

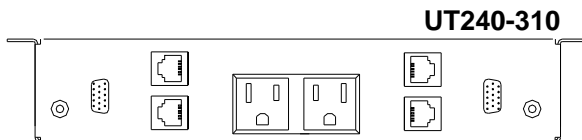

UT240-310
UT240-411 Europe UT240-451 England
UT240-511 Australia UT240-551 Universal
AC (2) VGA (2)
Net (4) Audio (2)

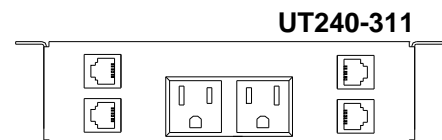

UT240-311

AC (2)
Net (4)

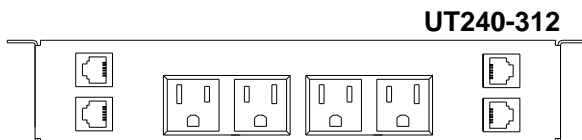

UT240-312
UT240-410 Europe UT240-450 England
UT240-510 Australia UT240-550 Universal
* The circuit breaker is located on the inside of the left-hand side
of each unit as viewed from the front. (see Diagram 14)
AC (4)
Net (4)
Circuit Breaker (1)

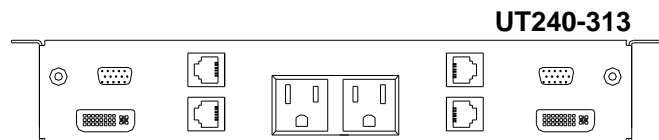

UT240-313

AC (2) DVI-I (2)
Net (4) Audio (2)
VGA (2)

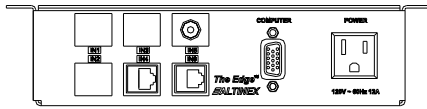

AC (1) **UT240-121S** VGA (1)
Blank (3)
Phone/Modem (2)

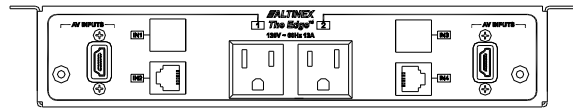

AC (2) **UT240-325S** HDMI (2)
Net (2) Blank (2) Audio (2)

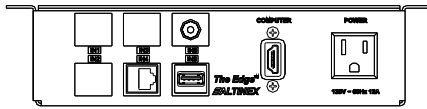

AC (1) **UT240-125S** HDMI (1)
Blank (3) USB Type A (1)
Phone/Modem (1) Audio (1)

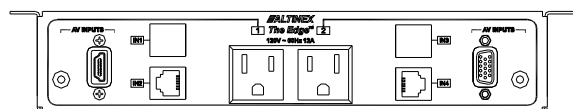

AC (2) **UT240-328S** HDMI (1)
Net (2) Blank (2) VGA (1)
Audio (2)

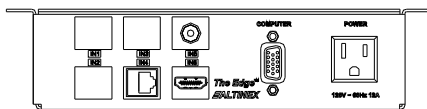

AC (1) **UT240-128S** HDMI (1)
Audio (1) VGA (1)
Blank (3) Phone/Modem (1)

6. Application Diagrams

Diagram 1: Typical Setup

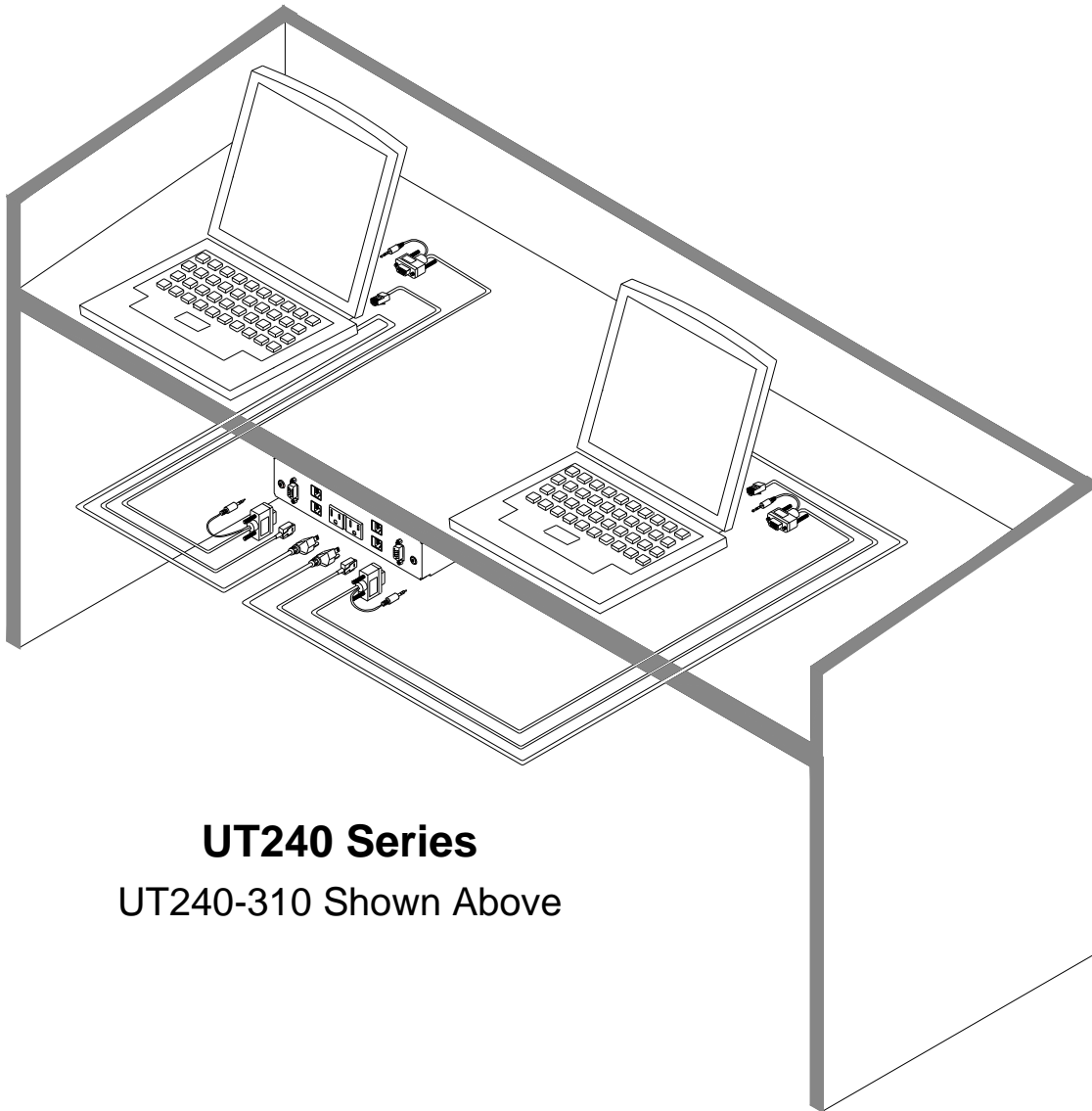

UT240 Series
UT240-310 Shown Above

Diagram 2: UT240-310/UT240-325S/UT240-328S U.S./Canada

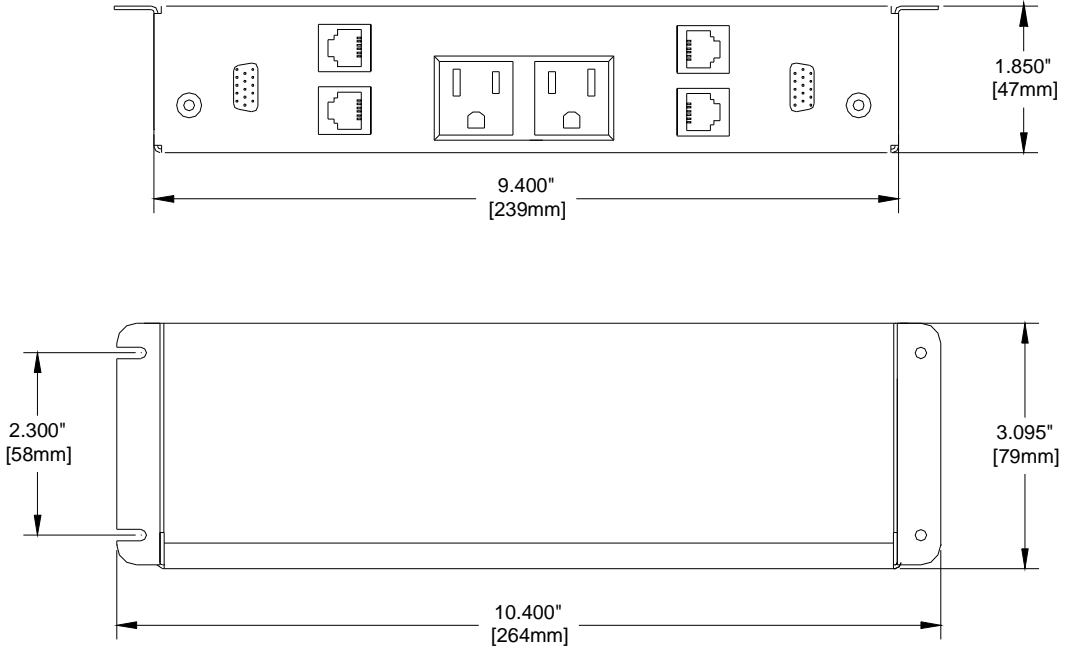

Diagram 3: UT240-311 U.S./Canada

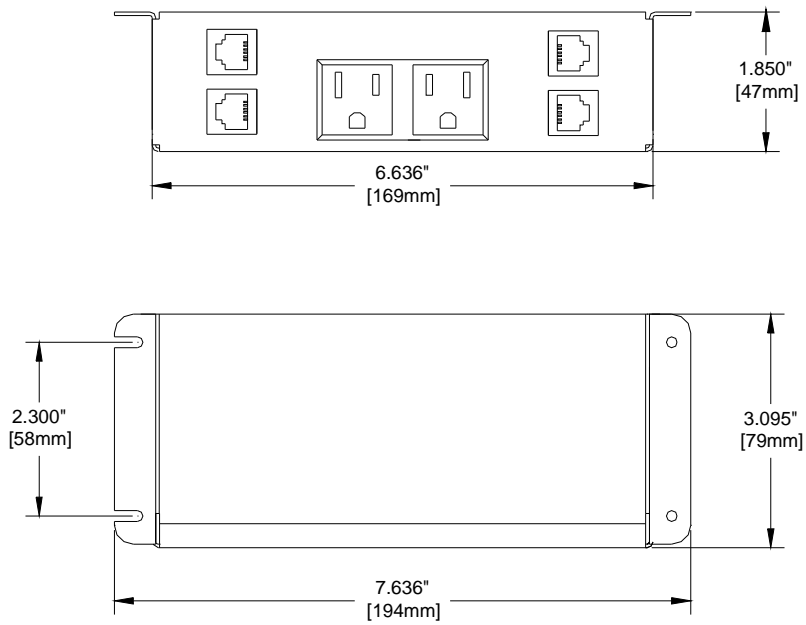

Diagram 4: UT240-312 U.S./Canada

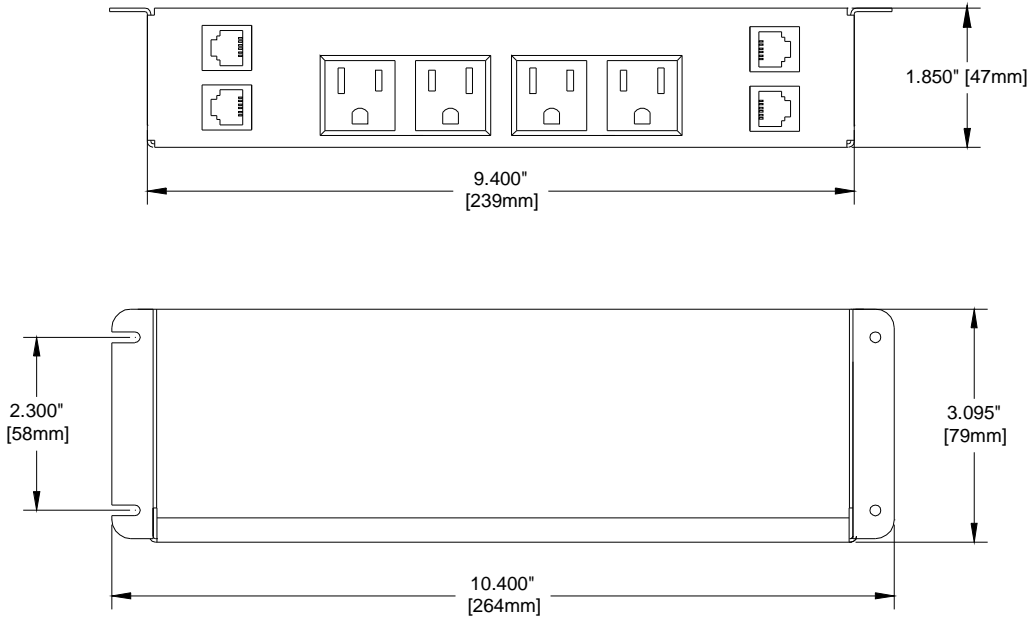

Diagram 5: UT240-313 U.S./Canada

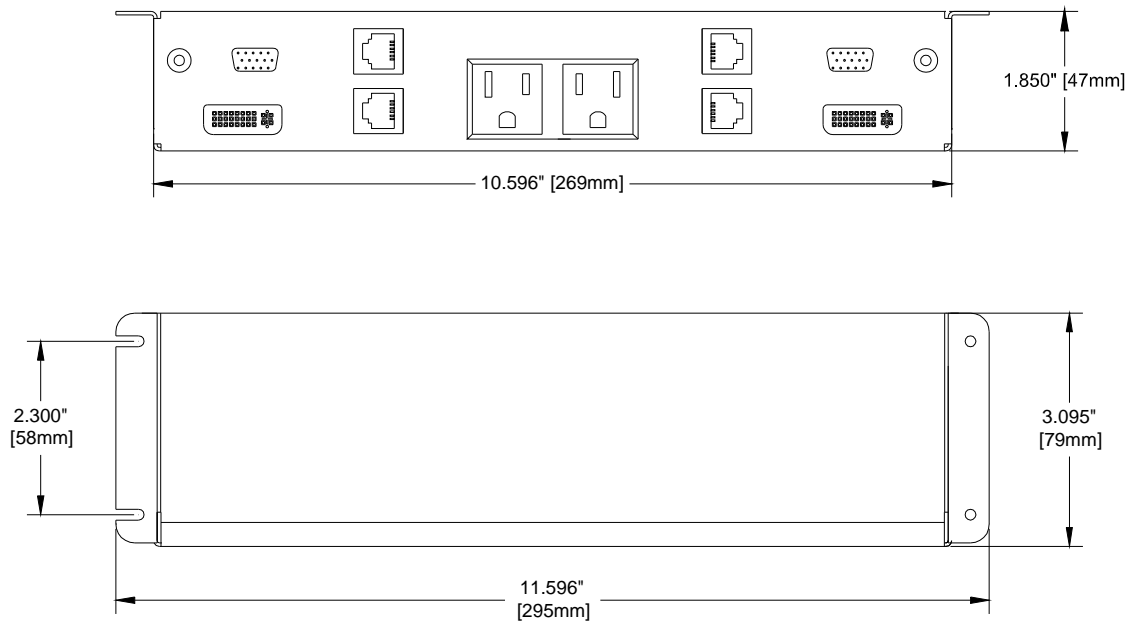

Diagram 6: UT240-410 Europe

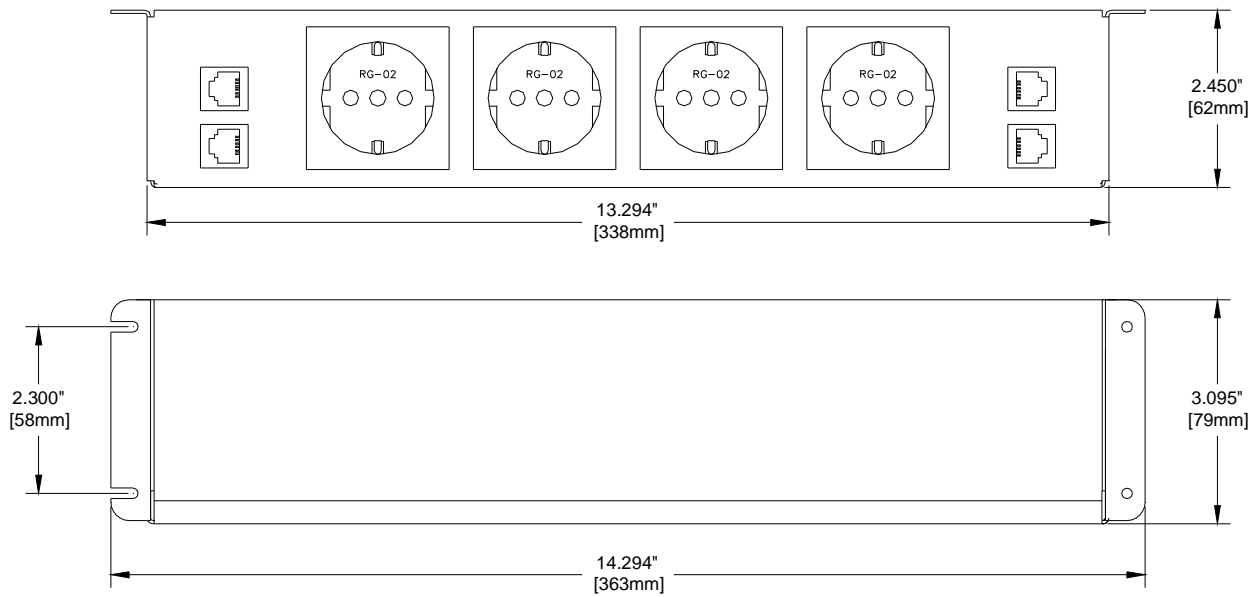

Diagram 7: UT240-411 Europe

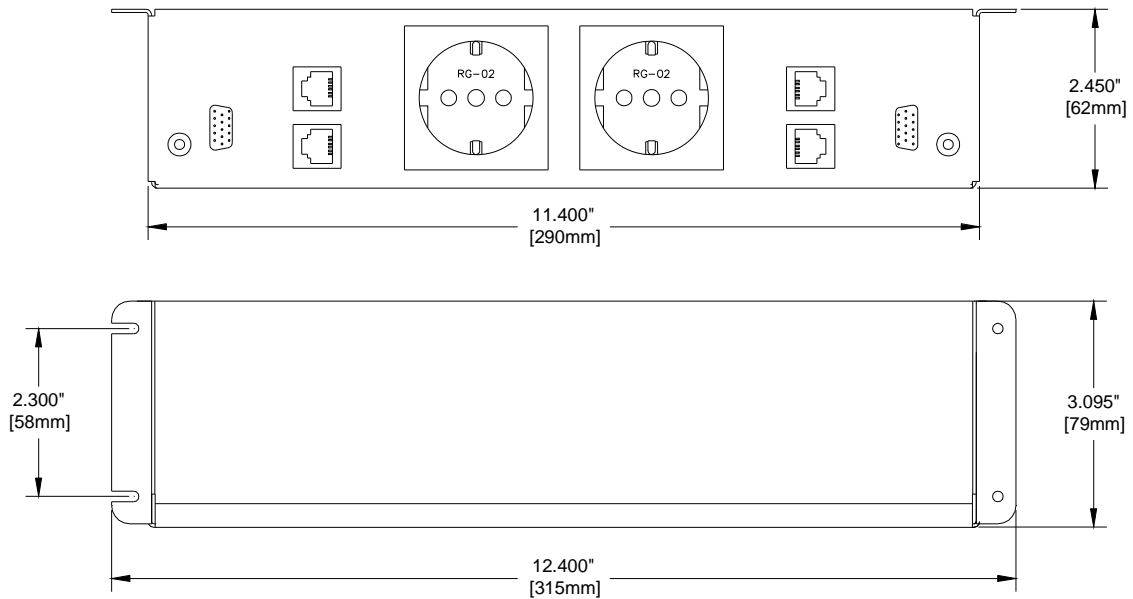

Diagram 8: UT240-450 England

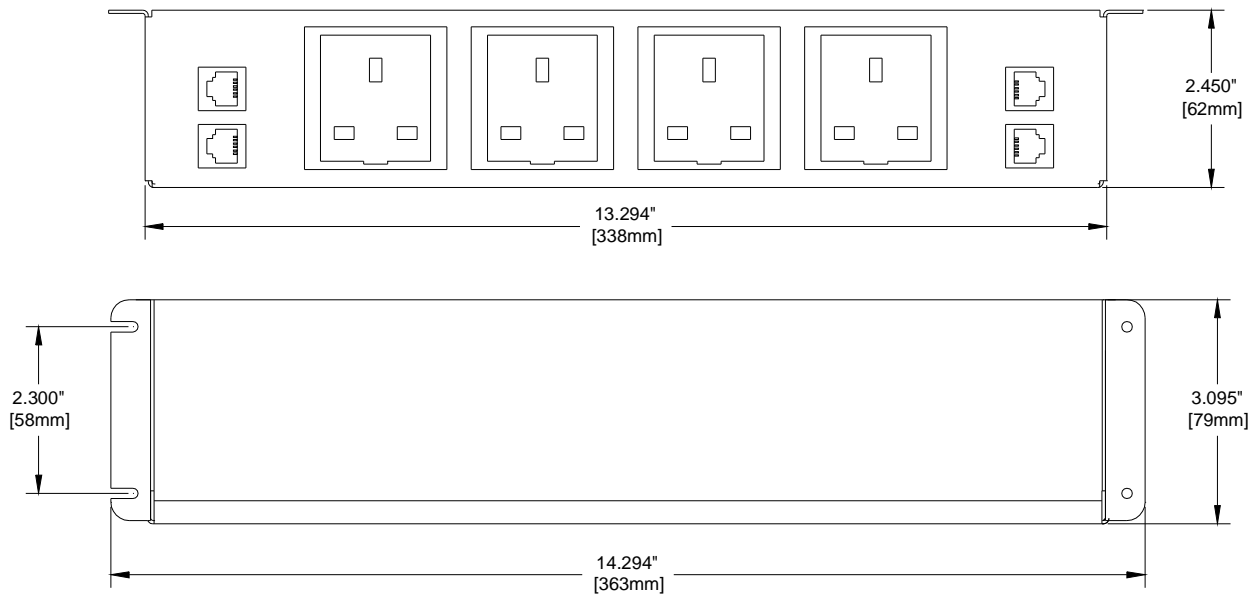

Diagram 9: UT240-451 England

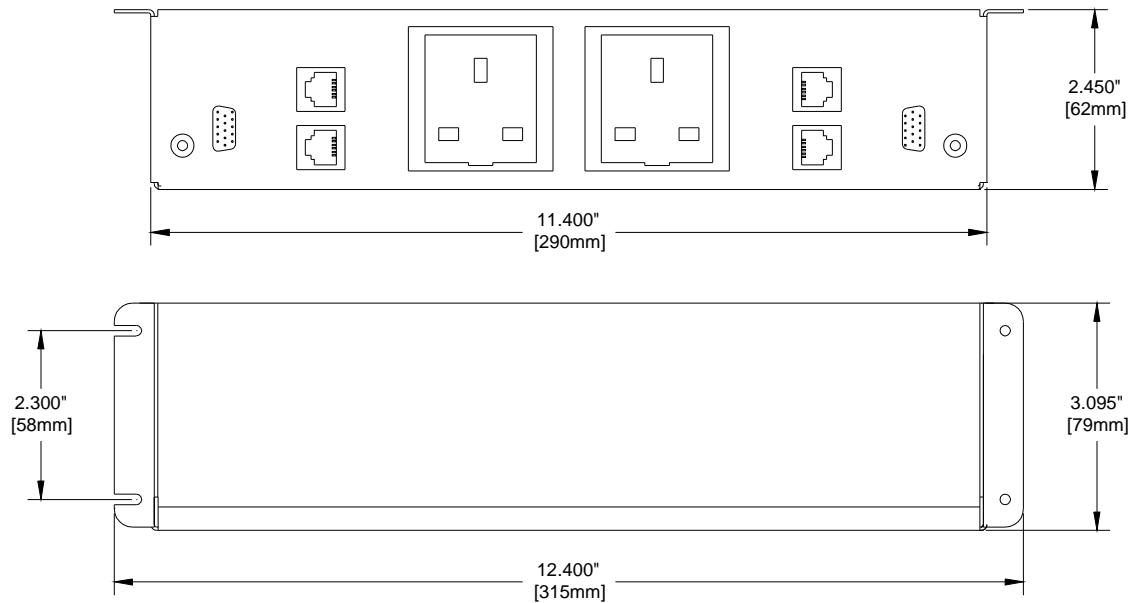

Diagram 10: UT240-510 Australia

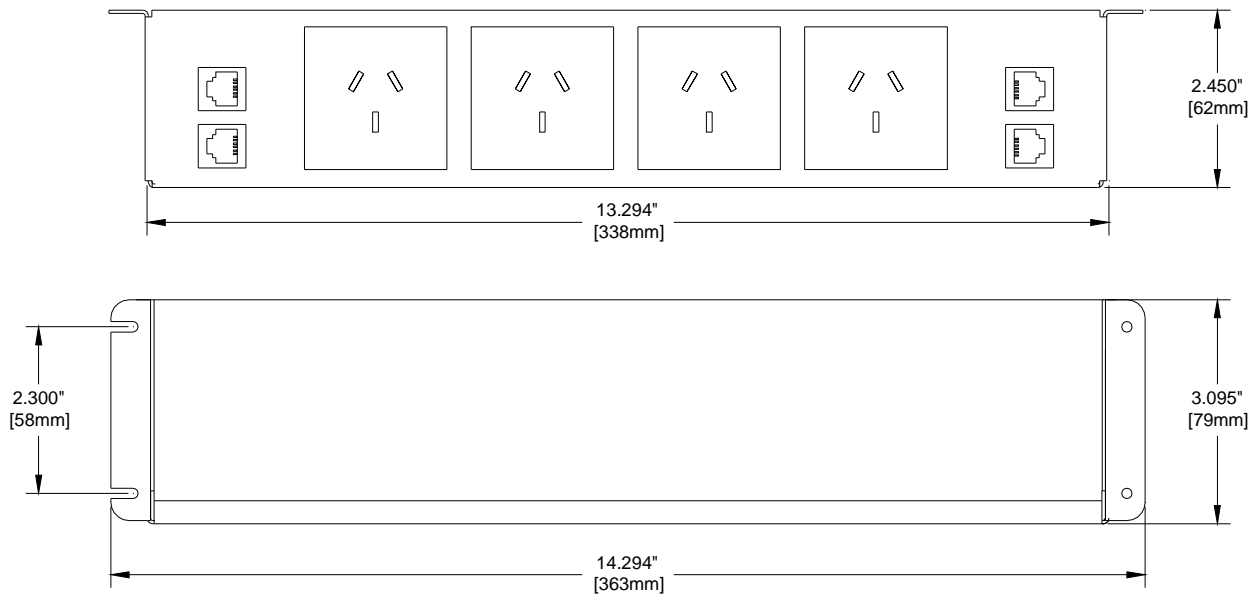

Diagram 11: UT240-511 Australia

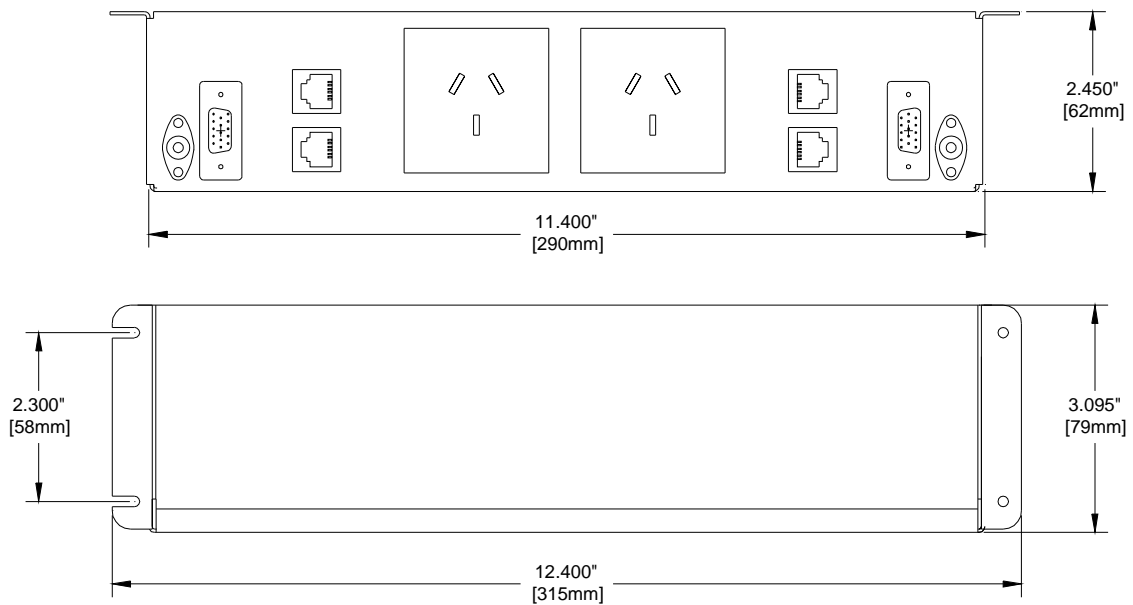

Diagram 12: UT240-550 Universal

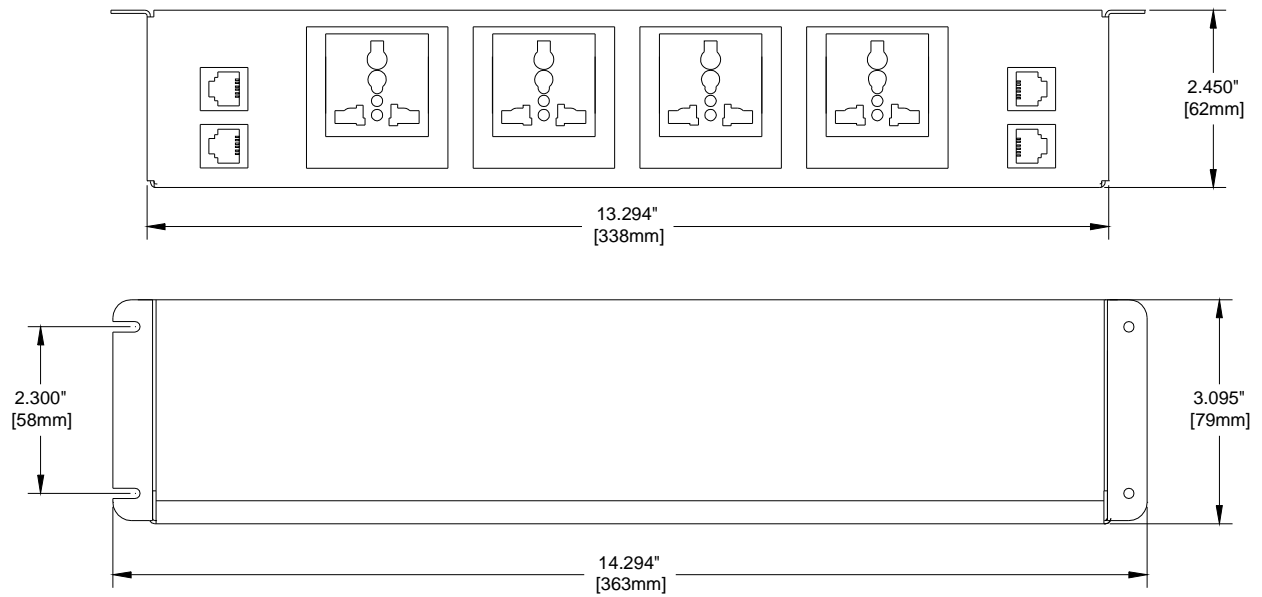

Diagram 13: UT240-551 Universal

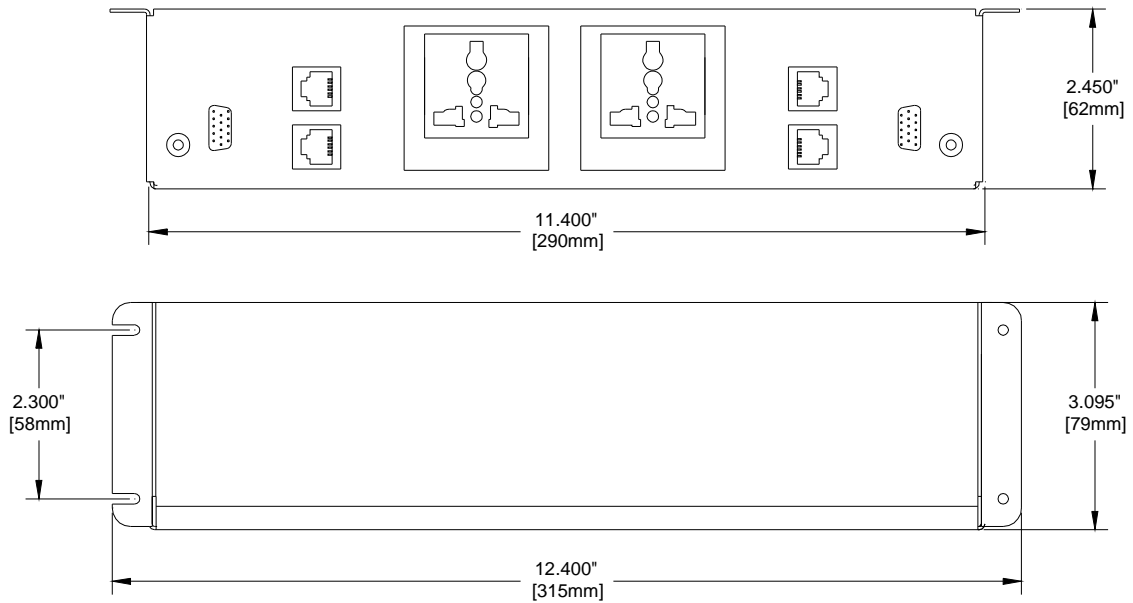

Diagram 14: UT240-278 US/UT240-121S/UT240-125S/UT240-128S US/Canada

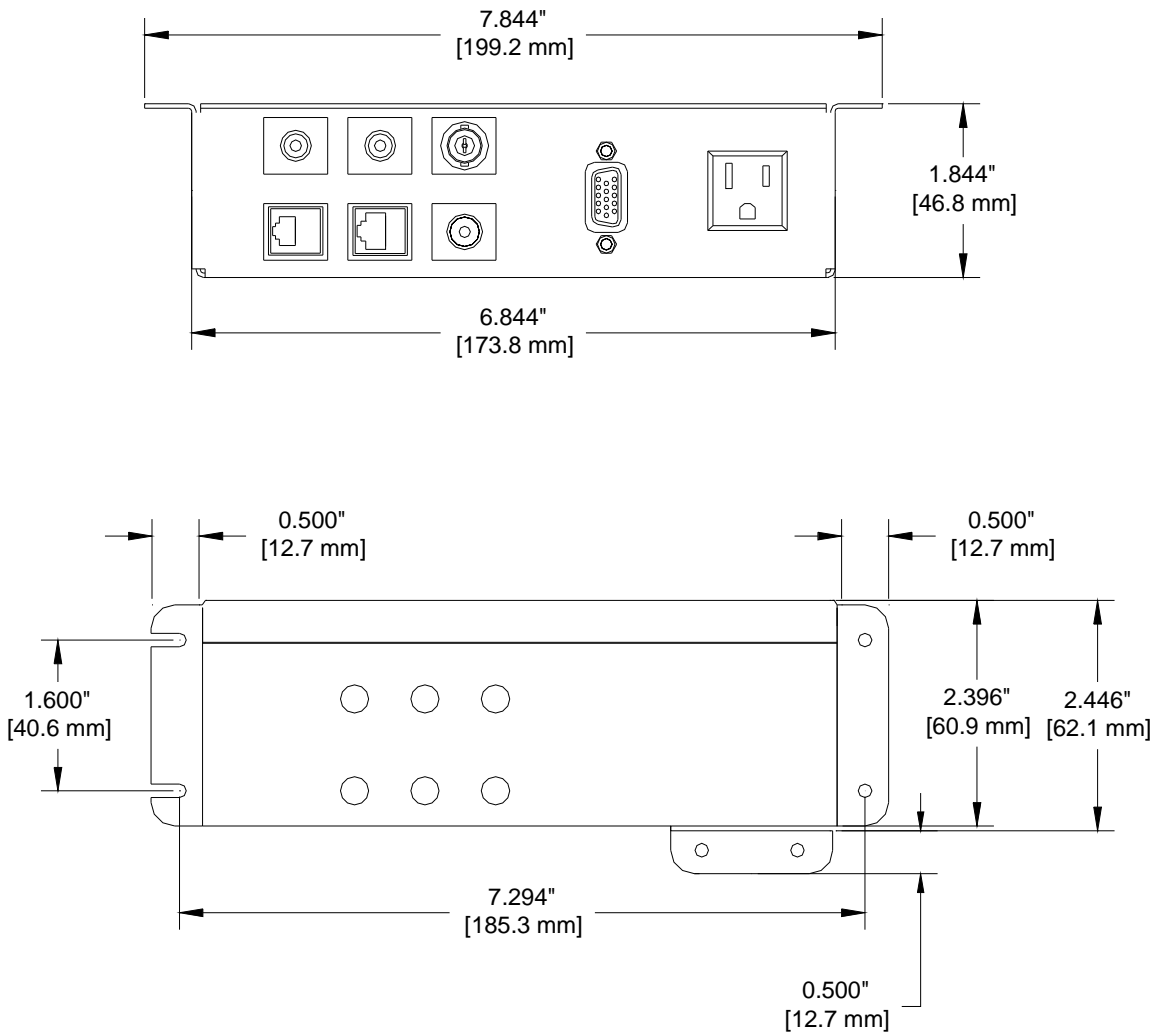

Diagram 15: Circuit Breaker

Model numbers UT240-312, UT240-410, UT240-450, UT240-510, and UT240-550 include a 15A circuit breaker. The circuit breaker is located in the same location for each model. The UT240-312 is shown here.

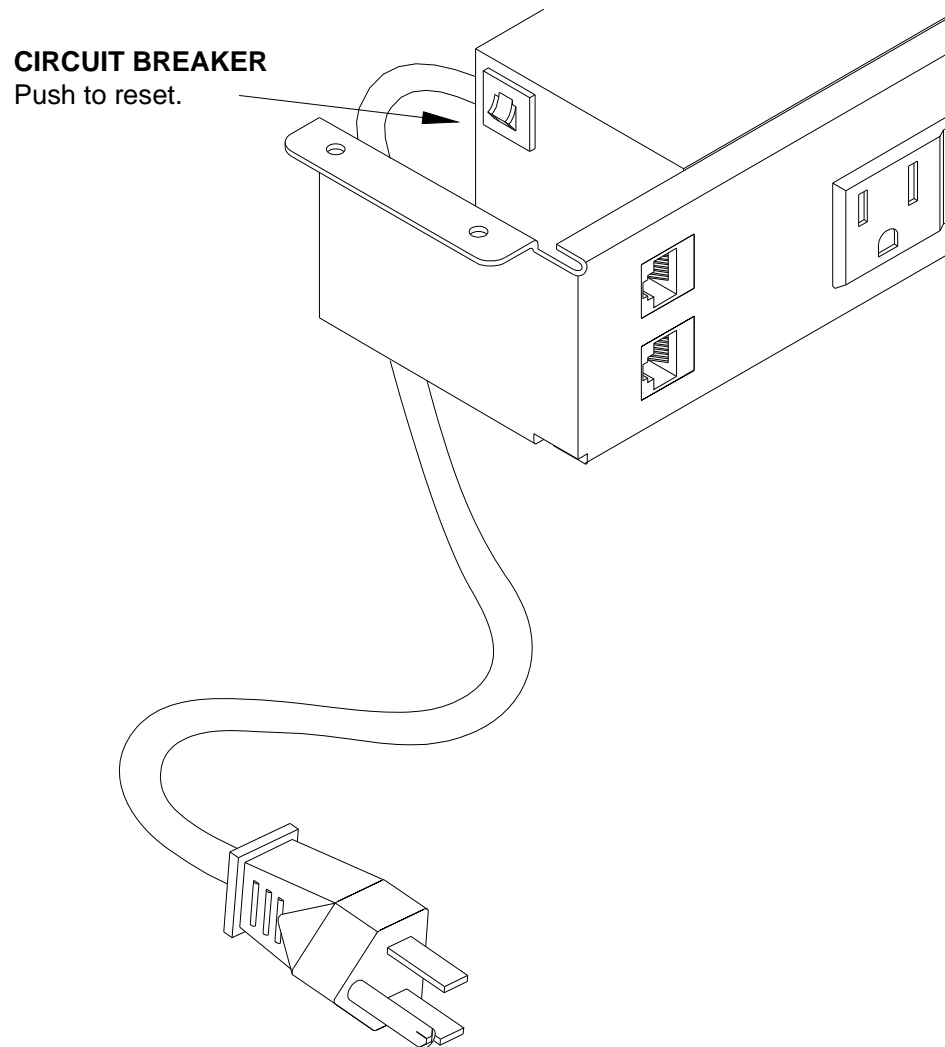
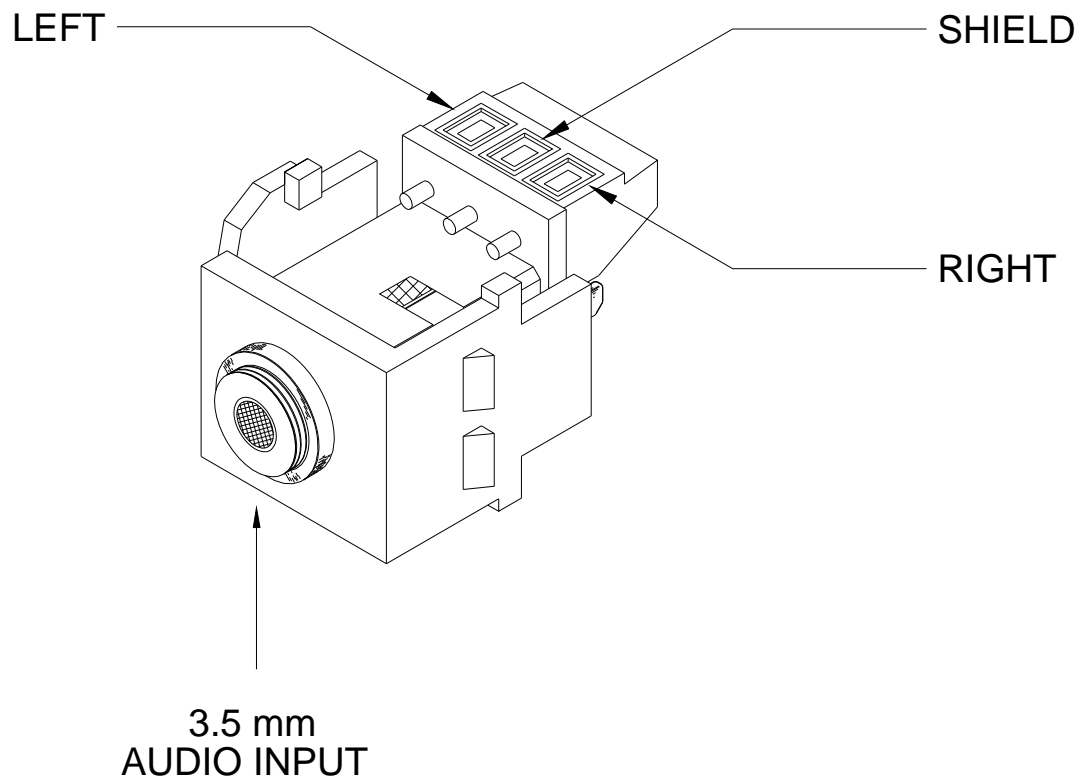

Diagram 16: Audio Wiring (terminal block)



7. Operation

The UT-Series requires no adjustments for performance. Once set-up, the UT-Series will work trouble-free without user intervention.

7.1 Circuit Breaker Reset

The UT240-312, UT240-410, UT240-450, UT240-510, and UT240-550 include a push-to-reset 15A circuit breaker. The circuit breaker is accessible from the left-hand side of the unit as viewed from the front. In the event the circuit breaker is tripped, do the following:

- Disconnect all AC devices from the UT240
- Turn off the power switch of each AC device
- Push the circuit breaker reset button back in
- Reconnect the AC devices
- One at a time, turn on the AC devices

WARNING

If the circuit breaker trips again, find the device that is drawing excessive current. Check the ratings for each of the devices connected to the UT240. If a device requires a significant amount of power, it should be plugged into its own supply circuit.

8. Troubleshooting Guide

We have carefully tested and found no problems in the supplied UT-Series; however, if you experience any problems or have questions, call ALTINEX at (714) 990-2300.