

# SHARP®

PN-V600A  
PN-V601A

ULTRA-SLIM BEZEL LED DISPLAYS

## World's Slimmest Bezel 60" LED Displays\* For Virtually Seamless Multi-Screen Video Walls

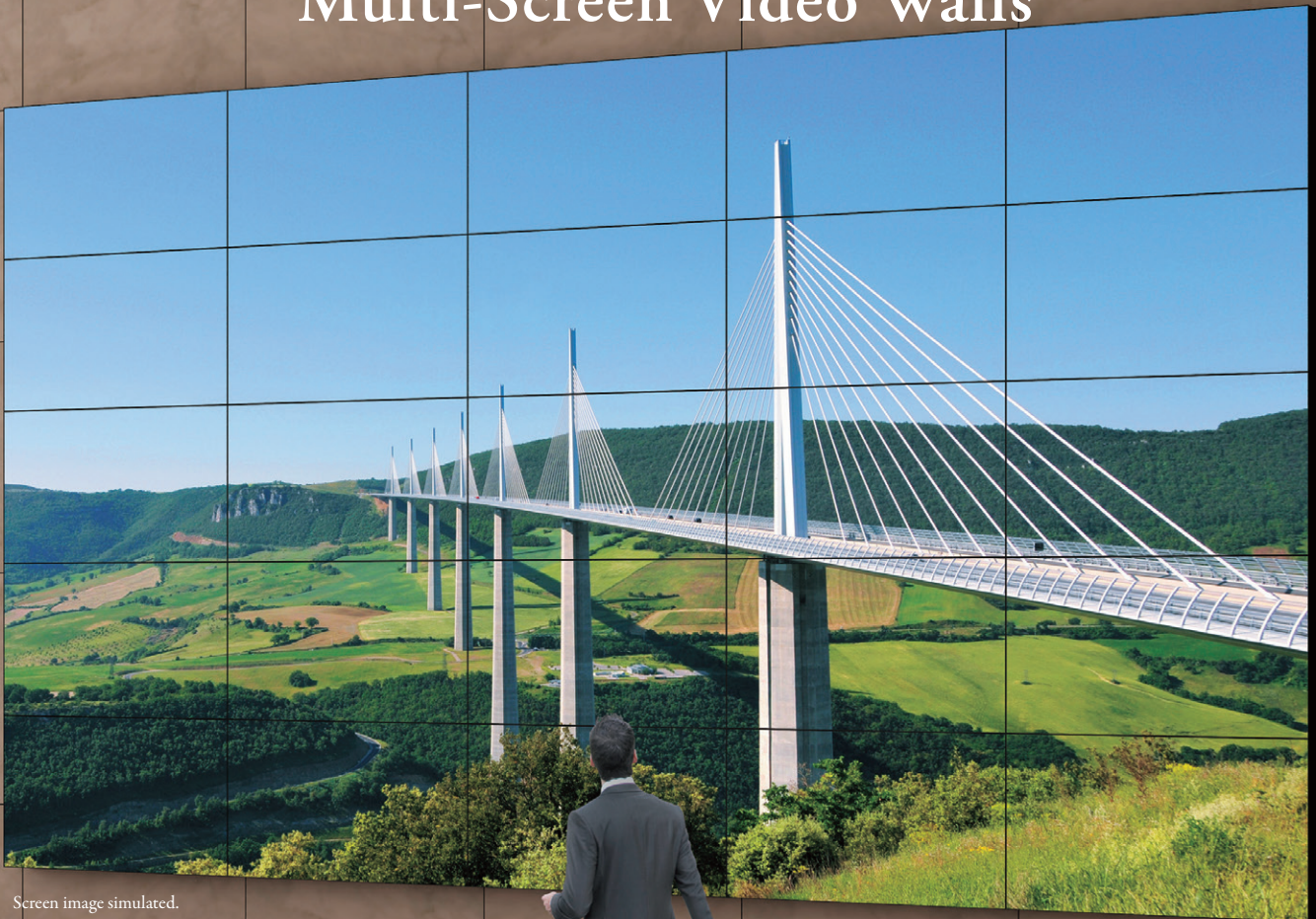

Screen image simulated.

With the slimmest bezel in the 60" diagonal class\*, the PN-V600A/PN-V601A is the new standard for multi-screen video wall displays. Portrait and landscape compatibility, full array LED backlighting and virtually seamless borders help you create high impact video walls in almost any size and format.

\*Based on published information as of August 1, 2012.





Screen image simulated.

# Sharp Ultra-Slim Bezel LED Displays Open New Opportunities

The PN-V600A/PN-V601A are the ideal choice for exciting, virtually seamless multi-screen video wall configurations. With professional design, high image quality and 24/7 certified reliability, the PN-V600A/PN-V601A brings almost limitless digital signage and display possibilities to shopping malls, airports, museums, stadiums, control centers and more.

## ● Enlarge (Zoom) Display Mode (for up to 25 Monitors)

The Enlarge (Zoom) Display mode can spread one image across up to 25 monitors (in a 5 x 5 configuration) from a PC. The Frame Width Adjustment function virtually eliminates misalignment and boldly enhances the enlarged image on a multi-screen display.

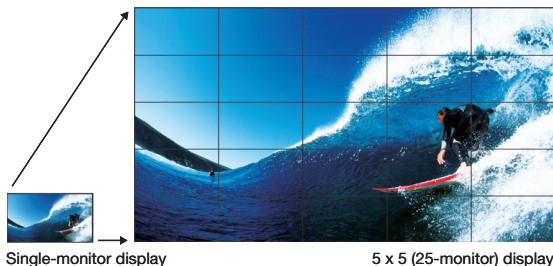

## ● Full-Array LED Backlight

To give the PN-V600A/PN-V601A more uniform brightness than conventional CCFL\* backlighting can offer, Sharp has positioned LED elements across the entire panel directly behind the liquid crystal layers, helping ensure that Sharp multi-screen displays are bright, beautiful and uniform.



(Image)

\* Cold Cathode Fluorescent Lamp

## ● PN-ZR01 Control Kit (sold separately)

When one of the monitors in a multi-screen configuration is fitted with a remote control sensor box, all of the monitors can be conveniently operated through one remote control unit. And to help with overall energy savings, a brightness sensor automatically adjusts the brightness of the backlight to match the ambient lighting. (UPC: 074000069022)





## Almost Limitless Display Possibilities

Thanks to the PN-V600A/PN-V601A's ultra-slim bezel, the borders between neighboring monitors are a virtually seamless 6.5 mm<sup>1</sup> wide (2.4 mm on the right and bottom; 4.1 mm on the left and top).<sup>\*2</sup> When used in a video wall configuration, this enables the display of crisp and high impact images of almost any size and format. With 24/7 certified reliability and 3-year onsite parts and labor limited warranty, the PN-V600/PN-V601 is designed to be both exceptionally reliable and environmentally friendly.

\*1: Does not include the gap between the monitors. \*2: Non-display area for neighboring monitors is 7.1 mm.

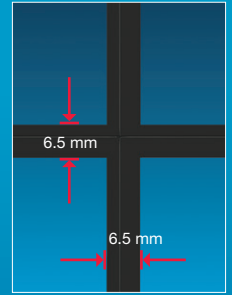

## Create Dynamic Video Walls

Units: cm (measurements are approximations that include the bezel width)

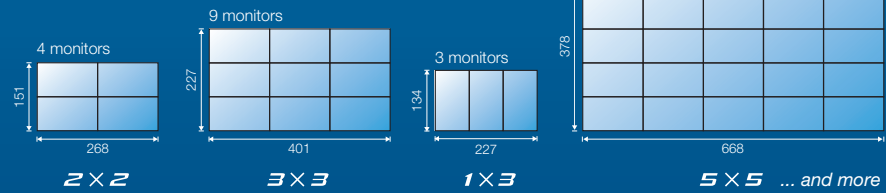

Almost any number of PN-V600A/PN-V601A monitors may be joined together to create high impact multi-screen video walls. These configurations may be controlled through RS-232C or over a network.\* Their ease of control and ease of integration help simplify the design and installation of sophisticated video wall displays of most any size and shape.

\* PN-ZB02 input/output expansion board is required for network control.

## Professional Quality And 24/7 Durability

Because business never stops, neither do the PN-V600A/V601A Video Wall Monitors. These professional-grade products are rugged enough for continuous 24/7 operation in the most demanding professional applications. As with all Sharp Professional Displays, the PN-V600A/PN-V601A is backed by an outstanding 3 year limited warranty covering parts and labor.

## Full Range of Connectivity

The PN-V600A/PN-V601A feature extensive interface capability. Add the optional input/output expansion board (PN-ZB02) for even more ways to connect your video wall installation to the content source your project requires.

## Choose the Model That Suits Your Needs

For environments with fewer ambient light sources, the PN-V600A is the lower-brightness alternative to the PN-V601A. It also consumes less power, which helps conserve energy and reduce operating costs.

## Create a 4K2K Ultra-High Resolution Experience

When placed in a 3x3 video wall configuration, the PN-V600A/PN-V601A standard resolution multiplies by three, creating a total resolution of up to 4098 x 2304 pixels for ultra-high resolution/ultra-high impact images.

## Mirror Frames (option)

In multi-screen configurations, mirror frames minimize the lines between slim-bezel PN-V600A/PN-V601A monitors by reflecting mirror images from the display content.

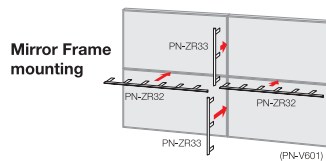

PN-ZR32  
Long Mirror Frame

PN-ZR33  
Short Mirror Frame

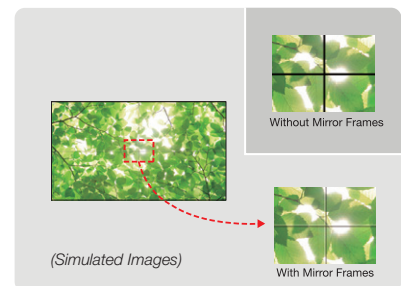



# Specifications

Model Name		PN-V600A	PN-V601A	Model Name	PN-V600A	PN-V601A
Installation		Landscape / Portrait		Output Terminals	Standard	Audio: RCA pin (L/R) x 1, RS-232C D-sub 9-pin x 1
LCD Panel		60-inch widescreen (152.4 cm diagonal), UN2A LCD		Input/Output Terminals	Via Optional PN-ZB02 Board	PC digital: DVI-D 24 pin x 1, External speaker 10W + 10W (6 Ω)
	Max. Resolution	1,366 x 768 pixels			LAN port	
	Max. Display Colors (approx.)	16.77 million colors		Power Supply/Power Consumption	100V-240V AC, 50/60 Hz/310 W	100V – 240V AC, 50/60 Hz/480W
	Pixel Pitch (H x V)	0.973 x 0.973 mm		Standby Power Consumption	1.0W (standby mode in Standard) 0.5W (standby mode in Low Power)	1.8W (standby mode in Standard) 0.5W (standby mode in Low Power)
	Max. Brightness*	450 cd/m <sup>2</sup>	700 cd/m <sup>2</sup>	Mounting	VESA (6 points), 7 7/8" pitch VESA (4 points), 7 7/8" pitch	
	Contrast Ratio	4,000:1		Environmental Conditions	Operating Temperature	0°C to 40°C
	Viewing Angle (H/V)	176°/176° (CR ≥ 10)			Operating Humidity	20% to 80% RH (no condensation)
	Active Screen Area (W x H)	52 5/8" x 29 7/16" (1,328.8mm x 747.1mm)		Dimensions (W x D x H) (approx.)	52 3/8" x 5 7/8" x 29 3/4" (Display section only, not including protrusions)	
	Response Time	6 ms (gray to gray, avg.)		Packing Dimensions (W x D x H) (approx.)	62 1/4" x 15" x 36 3/4"	
Computer Input	Video	Analog RGB (0.7 Vp-p) [75 Ω], Digital (conforms to DVI 1.0 standards)		Weight (not including PN-ZB02) (approx.)	41 kg (90 lbs.)	44 kg (96.9 lbs.)
	Synchronization	Horizontal/vertical separation (TTL: positive/negative) Sync-on-green, Composite sync (TTL: positive/negative)		Packing Weight (approx.)	52 kg (114 lbs.)	55 kg (121.25 lbs.)
	Plug & Play	VESA DDC2B		Main Accessories	AC power code (approx. 3m.), operation manual, CD-ROM, stand hole protection cover	
	Power Management	VESA DPMS, DVI DMPM		UPC	074000069527	074000069510
Video Color System		NTSC (3.58 [NTSC-M]) / NTSC (4.43) / PAL / PAL60 / SECAM				
Input Terminals	Standard	PC analog: Mini D-sub 15-pin x 1, HDMI® x 1, 3.5 mm-diameter mini stereo jack x 1, RS-232C D-sub 9-pin x 1, Control Kit terminal x 1				
	Via Optional PN-ZB02 Board	PC digital: DVI-D 24 pin x 1, PC analog: BNC x 1 Video: BNC x 1, S-Video x 1, Component video: BNC (Y, Cb/Pb, Cr/Pr) x 1, Audio: RCA pin (L/R) x 2				

\* Brightness will depend on input mode and other picture settings. Brightness level will decrease over time. Due to the nature of the source equipment, it is not possible to precisely maintain a constant level of brightness.

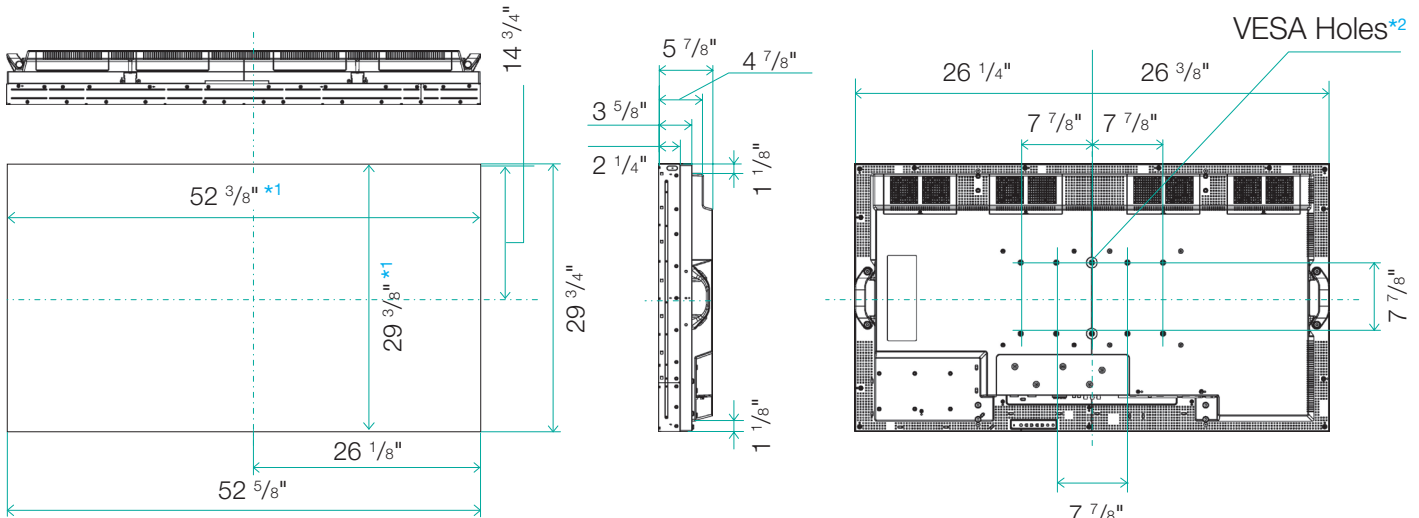

Units: inch

\*1 Screen dimensions

\*2 To use the VESA-standard mounting bracket, use M6 screws that are 8 to 10 mm plus the thickness of the bracket.

## Input/Output Terminals (standard)

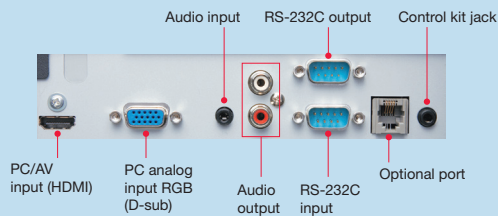

## PN-ZB02 Interface Expansion Board (option) 074000047068

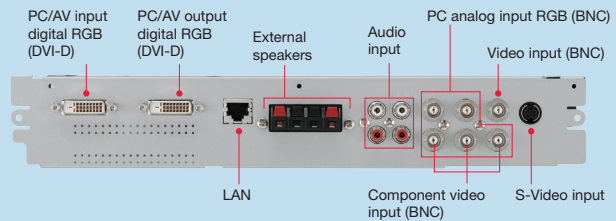

Design and specifications subject to change without prior notice.

Sharp and related trademarks are trademarks or registered trademarks of Sharp Corporation and/or its affiliated entities. Microsoft, Windows, Microsoft Windows Server 2003/2008, Windows XP, Windows Vista, Windows 7, Internet Explorer, PowerPoint and Windows Media are trademarks or registered trademarks of Microsoft in the United States and/or other countries. Pentium and Celeron are trademarks or registered trademarks of Intel Corporation in the U.S. and other countries. Adobe, Flash and Adobe Flash Player are trademarks or registered trademarks of Adobe Systems Inc. QuickTime is a trademark of Apple Computer Inc. HDMI is a registered trademark of HDMI Licensing LLC. All other trademarks are the property of their respective owners.



SHARP ELECTRONICS CORPORATION  
Professional Display Division  
Sharp Plaza, Mahwah, NJ 07495-1163  
For more information call 1-877-PRO-ADV1 (1- 877-776-2381)  
www.sharppusa.com/monitors

© 2013 Sharp Electronics Corporation. All rights reserved. 11/13

PDD-13-005

