

HERO+
LCD

QUICK START GUIDE

GoPro
Be a HERO. 

CONGRATULATIONS
on your
new **HERO+**
LCD

This Quick Start Guide will show you the basics of capturing life's most incredible moments with your GoPro.



To download the full User Manual, visit gopro.com/getstarted

SET UP

- 1 Unlatch and open the backdoor.
(The camera cannot be removed from the housing.)
- 2 Insert a microSD card.
(Requires at least a Class 10 or UHS-I microSD card up to 64GB, sold separately.)
- 3 Charge using the included USB cable.
(The battery cannot be removed from the camera.)

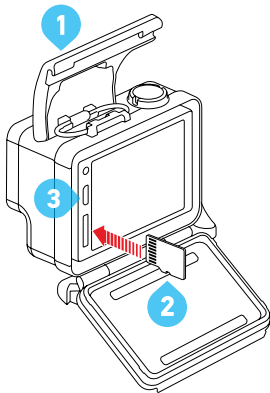

POWERING ON + RECORDING

- 1 Short press the **Power/ Mode** button.
- 2 On the touch display, tap the mode icon and then select a video or photo mode.
- 3 Press the **Shutter/Select** button to start/stop recording.

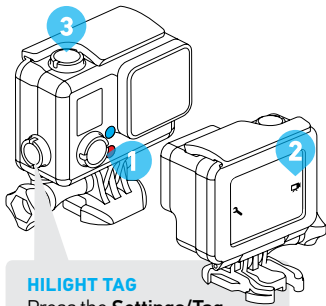

HIGHLIGHT TAG

Press the **Settings/Tag** button to tag key moments while recording or playing back video to quickly find the highlights later.

MODES



VIDEO

Capture video.



PHOTO

Capture a single photo.



BURST

Capture photo bursts.



TIME LAPSE

Capture a series of photos at set time intervals.



PLAYBACK

Play back videos and photos.



SETUP

Adjust general camera settings.

For full details about all modes, resolutions and settings, download the User Manual at gopro.com/getstarted

ADJUSTING SETTINGS

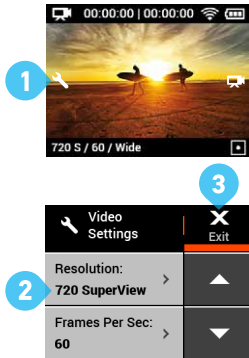

- 1 On the touch display, tap the settings icon to open the settings for the current mode.
- 2 Tap the setting you want to change, then select an option for that setting.
- 3 Tap Exit to close the settings menu.

MOUNTING YOUR CAMERA

Mount your GoPro to helmets, gear and more with the included Curved + Flat Adhesive Mounts and hardware.

FLAT SURFACE MOUNTING

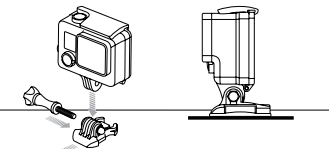

CURVED SURFACE MOUNTING

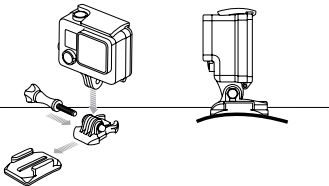

TIP: Apply adhesive mounts to clean, smooth surfaces at room temperature only, at least 24 hours before use. To remove, heat with a hair dryer then peel off mount.

HOUSING BACKDOORS

Your HERO+ LCD camera comes with three backdoors, each designed for different uses and environments.

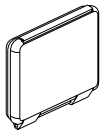

STANDARD BACKDOOR

Provides waterproof protection to 131' (40m). Use when shooting under water or in wet, damp or dirty conditions.

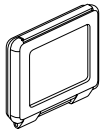

TOUCH BACKDOOR

Enables access to the touch display. Provides waterproof protection to 10' (3m).

(To prevent damage to the touch display, do not exceed this depth when using this backdoor. Touch functionality is not available under water.)

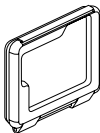

SKELETON BACKDOOR

Not waterproof—use in dry, dirt-free environments only. Enables access to the touch display, provides enhanced cooling and allows more direct access to the microphone.

SWAPPING BACKDOORS

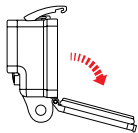

1

Open the housing so the backdoor hangs downward.

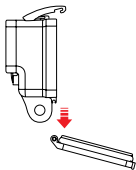

2

Pull down on the backdoor until it snaps free from the hinge.

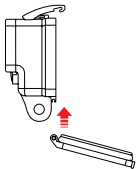

3

Align the new backdoor with the hinge.

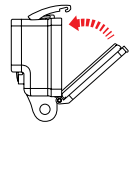

4

Push up on the backdoor until it clicks into place.

VIEWING, EDITING AND SHARING



GOPRO APP

Use the free GoPro App to view your photos and videos and share your favorites via text, email and social networks.

GOPRO STUDIO

GoPro Studio software is the best way to import, play back and edit your GoPro videos. You can download it for free at gopro.com/getstarted.

CONNECTING TO THE GOPRO APP

1. Download the GoPro App and open it on your smartphone or tablet.
2. Follow the app's on-screen instructions to connect your camera.

(If needed, the default password for your camera is goprohero.)

For complete pairing instructions, visit gopro.com/support.



HELP AND RESOURCES

UPDATE YOUR CAMERA

Get the most out of your GoPro with updated features and performance.

CREATE A GOPRO ACCOUNT

Receive updates, enter contests and more.

DOWNLOAD THE USER MANUAL

Find detailed info on settings, modes and more.

CONTROL. VIEW. SHARE

Learn more about the GoPro App.

WATCH TUTORIAL VIDEOS

Learn tips + tricks from the pros.

CONTACT CUSTOMER SUPPORT

Get help and find answers to frequently asked questions.



VISIT
[GOPRO.COM/
GETSTARTED](http://GOPRO.COM/GETSTARTED)

JOIN THE GOPRO MOVEMENT

Find inspiration in the millions of GoPro photos and videos shared by our customers around the world. Then share yours and join the movement.

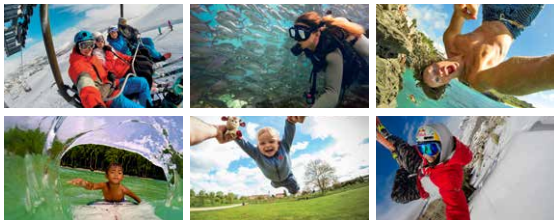

Before using your GoPro camera, please read all of the precautions in the Important Product + Safety Information included with your camera.



To see the complete list of country certifications, refer to the Important Product + Safety Information included with your camera.