

Panasonic®

Basic Owner's Manual

4K Video Camera

Model No. **HC-X1000**

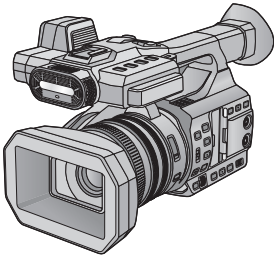

Please read these instructions carefully before using this product, and save this manual for future use.

More detailed owner's manual are available in "Owner's Manual (PDF format)". To read it, download it from the website.

<https://www.pavc.panasonic.co.jp/hdw/oi/X1000/index.html>

- Click the desired language.

* You will need Adobe Reader to browse or print the Owner's Manual (PDF format).

You can download and install a version of Adobe Reader that you can use with your OS from the following website. (As of September 2014)

<http://www.adobe.com/products/acrobat/readstep2.html>

AVCHD™
Progressive

HDMI

SDXC™ U3 I

DOLBY DIGITAL

**LEICA
DICOMAR**

**WiFi®
CERTIFIED**



Register online at www.panasonic.com/register (U.S. customers only)

If you have any questions, visit :

U.S.A. : www.panasonic.com/support

Canada : www.panasonic.ca/english/support

Dear Customer,

Thank you for choosing Panasonic!

You have purchased one of the most sophisticated and reliable products on the market today. Used properly, we're sure it will bring you and your family years of enjoyment. Please take time to fill in the information on the right.

The serial number is on the tag located on the bottom of your camera. Be sure to **retain this manual** as your convenient camera information source.

Date of Purchase _____

Dealer Purchased From _____

Dealer Address _____

Dealer Phone No. _____

Model No. _____

Serial No. _____

Safety Precautions

WARNING:

To reduce the risk of fire, electric shock or product damage,





- Do not expose this unit to rain, moisture, dripping or splashing.
- Do not place objects filled with liquids, such as vases, on this unit.
- Use only the recommended accessories.
- Do not remove covers.
- Do not repair this unit by yourself. Refer servicing to qualified service personnel.

CAUTION!

To reduce the risk of fire, electric shock or product damage,

- Do not install or place this unit in a bookcase, built-in cabinet or in another confined space. Ensure this unit is well ventilated.
- Do not obstruct this unit's ventilation openings with newspapers, tablecloths, curtains, and similar items.
- Do not place sources of naked flames, such as lighted candles, on this unit.

The following mark and symbols are located on the bottom of the battery charger.

	CAUTION RISK OF ELECTRIC SHOCK DO NOT OPEN		
CAUTION: TO REDUCE THE RISK OF ELECTRIC SHOCK, DO NOT REMOVE SCREWS. NO USER-SERVICEABLE PARTS INSIDE. REFER SERVICING TO QUALIFIED SERVICE PERSONNEL.			

The lightning flash with arrowhead symbol, within an equilateral triangle, is intended to alert the user to the presence of uninsulated "dangerous voltage" within the product's enclosure that may be of sufficient magnitude to constitute a risk of electric shock to persons.

The exclamation point within an equilateral triangle is intended to alert the user to the presence of important operating and maintenance (servicing) instructions in the literature accompanying the appliance.

THE FOLLOWING APPLIES ONLY IN THE U.S.A.

FCC Note:

This equipment has been tested and found to comply with the limits for a Class B digital device, pursuant to Part 15 of the FCC Rules. These limits are designed to provide reasonable protection against harmful interference in a residential installation. This equipment generates, uses, and can radiate radio frequency energy and, if not installed and used in accordance with the instructions, may cause harmful interference to radio communications. However, there is no guarantee that interference will not occur in a particular installation. If this equipment does cause harmful interference to radio or television reception, which can be determined by turning the equipment off and on, the user is encouraged to try to correct the interference by one or more of the following measures:

- Reorient or relocate the receiving antenna.
- Increase the separation between the equipment and receiver.
- Connect the equipment into an outlet on a circuit different from that to which the receiver is connected.
- Consult the dealer or an experienced radio/TV technician for help.

FCC Caution: To assure continued compliance, follow the attached installation instructions and use only shielded interface cables with ferrite core (USB cable) when connecting to computer or peripheral devices.

Any changes or modifications not expressly approved by the party responsible for compliance could void the user's authority to operate this equipment.

Declaration of Conformity

Trade Name: Panasonic
Model No.: HC-X1000
Responsible Party: Panasonic Corporation of North America
Two Riverfront Plaza, Newark, NJ 07102-5490
Support Contact: <http://www.panasonic.com/contactinfo>

This device complies with Part 15 of the FCC Rules. Operation is subject to the following two conditions: (1) This device may not cause harmful interference, and (2) this device must accept any interference received, including interference that may cause undesired operation.



THE FOLLOWING APPLIES ONLY IN CANADA.

CAN ICES-3(B)/NMB-3(B)

AC adaptor

This AC adaptor operates on AC between 110 V and 240 V.

But

- In the U.S.A. and Canada, the AC adaptor must be connected to a 120 V AC power supply only.
- When connecting to an AC supply outside of the U.S.A. or Canada, use a plug adaptor to suit the AC outlet configuration.
- When connecting to a supply of greater than AC 125 V, ensure the cord you use is suited to the voltage of the AC supply and the rated current of the AC adaptor.
- Contact an electrical parts distributor for assistance in selecting a suitable AC plug adaptor or AC cord set.

Battery charger

This battery charger operates on AC between 100 V and 240 V.

But

- In the U.S.A. and Canada, the battery charger must be connected to a 120 V AC power supply only.
- When connecting to an AC supply outside of the U.S.A. or Canada, use a plug adaptor to suit the AC outlet configuration.
- When connecting to a supply of greater than AC 125 V, ensure the cord you use is suited to the voltage of the AC supply and the rated current of the battery charger.
- Contact an electrical parts distributor for assistance in selecting a suitable AC plug adaptor or AC cord set.

The power plug is the disconnecting device. Install this unit so that the power plug can be unplugged from the socket outlet immediately.

-If you see this symbol-

Information on Disposal in other Countries outside the European Union



This symbol is only valid in the European Union.
If you wish to discard this product, please contact your local authorities or dealer and ask for the correct method of disposal.

IMPORTANT SAFETY INSTRUCTIONS

Read these operating instructions carefully before using the unit. Follow the safety instructions on the unit and the applicable safety instructions listed below. Keep these operating instructions handy for future reference.

- 1) Read these instructions.
- 2) Keep these instructions.
- 3) Heed all warnings.
- 4) Follow all instructions.
- 5) Do not use this apparatus near water.
- 6) Clean only with dry cloth.
- 7) Do not block any ventilation openings. Install in accordance with the manufacturer's instructions.
- 8) Do not install near any heat sources such as radiators, heat registers, stoves, or other apparatus (including amplifiers) that produce heat.
- 9) Do not defeat the safety purpose of the polarized or grounding-type plug. A polarized plug has two blades with one wider than the other. A grounding-type plug has two blades and a third grounding prong. The wide blade or the third prong are provided for your safety. If the provided plug does not fit into your outlet, consult an electrician for replacement of the obsolete outlet.
- 10) Protect the power cord from being walked on or pinched particularly at plugs, convenience receptacles, and the point where they exit from the apparatus.
- 11) Only use attachments/accessories specified by the manufacturer.
- 12) Use only with the cart, stand, tripod, bracket, or table specified by the manufacturer, or sold with the apparatus. When a cart is used, use caution when moving the cart/apparatus combination to avoid injury from tip-over.
- 13) Unplug this apparatus during lightning storms or when unused for long periods of time.
- 14) Refer all servicing to qualified service personnel. Servicing is required when the apparatus has been damaged in any way, such as power-supply cord or plug is damaged, liquid has been spilled or objects have fallen into the apparatus, the apparatus has been exposed to rain or moisture, does not operate normally, or has been dropped.



■ Concerning the battery

Battery pack (Lithium ion battery pack)

- Use the specified unit to recharge the battery pack.
- Do not use the battery pack with equipment other than the specified unit.
- Do not get dirt, sand, liquids, or other foreign matter on the terminals.
- Do not touch the plug terminals (+ and -) with metal objects.
- Do not disassemble, remodel, heat or throw into fire.

If any electrolyte should come into contact with your hands or clothes, wash it off thoroughly with water.

If any electrolyte should come into contact with your eyes, never rub the eyes. Rinse eyes thoroughly with water, and then consult a doctor.

Warning

Risk of fire, explosion and burns. Do not disassemble, heat above 60 °C (140 °F) or incinerate.

CAUTION

- Danger of explosion if battery is incorrectly replaced. Replace only with the type recommended by the manufacturer.
- When disposing of the batteries, please contact your local authorities or dealer and ask for the correct method of disposal.

■ Product identification marking

Product	Location
4K Video Camera	Bottom
Battery charger	Bottom
AC adaptor	Bottom

Conforms to UL STD 60065.

Certified to CAN/CSA STD C22.2 No.60065.

U.S.A./CANADA CONSUMERS: ATTENTION:



A lithium ion battery that is recyclable powers the product you have purchased. Please call 1-800-8-BATTERY for information on how to recycle this battery.

THE FOLLOWING APPLIES ONLY IN THE U.S.A.

Contains FCC ID: VPYLBVX532

This device complies with Part 15 of FCC Rules. Operation is subject to the following two conditions:

- (1) this device may not cause harmful interference, and
- (2) this device must accept any interference received, including interference that may cause undesired operation.

FCC WARNING

Changes or modifications not expressly approved by the party responsible for compliance could void the user's authority to operate the equipment.

This transmitter must not be co-located or operated in conjunction with any other antenna or transmitter.

This equipment complies with FCC radiation exposure limits set forth for an uncontrolled environment and meets the FCC radio frequency (RF) Exposure Guidelines in Supplement C to OET65.

This equipment has very low levels of RF energy that are deemed to comply without testing of specific absorption ratio (SAR).

THE FOLLOWING APPLIES ONLY IN CANADA.

Contains IC: 772C-LBVX604

This device complies with RSS-210 of the IC Rules.

Operation is subject to the following two conditions:

- (1) This device may not cause harmful interference,
- (2) This device must accept any interference received, including interference that may cause undesired operation of the device.

This equipment complies with IC radiation exposure limits set forth for an uncontrolled environment and meets RSS-102 of the IC radio frequency (RF) Exposure rules.

This equipment has very low levels of RF energy that are deemed to comply without testing of specific absorption ratio (SAR).

■ Cautions for use

The unit and the SD card become warm during use. This is not a malfunction.

Keep this unit as far away as possible from electromagnetic equipment (such as microwave ovens, TVs, video games etc.).

- If you use this unit on top of or near a TV, the pictures and/or sound on this unit may be disrupted by electromagnetic wave radiation.
- Do not use this unit near cell phones because doing so may result in noise adversely affecting the pictures and/or sound.
- Recorded data may be damaged, or pictures may be distorted, by strong magnetic fields created by speakers or large motors.
- Electromagnetic wave radiation generated by microprocessors may adversely affect this unit, disturbing the pictures and/or sound.
- If this unit is adversely affected by electromagnetic equipment and stops functioning properly, turn this unit off and remove the battery or disconnect AC adaptor. Then reinsert the battery or reconnect AC adaptor and turn this unit on.

Do not use this unit near radio transmitters or high-voltage lines.

- If you record near radio transmitters or high-voltage lines, the recorded pictures and/or sound may be adversely affected.

About connecting to a PC

- Do not use any other USB cables except the supplied one.

About using a headphone

- Excessive sound pressure from earphones and headphones can cause hearing loss.
- Listening at full volume for long periods may damage the user's ears.

About using external microphones

- Keep the microphone holder screw and INPUT terminal cap out of reach of children to prevent swallowing.

-
- Make sure to use the supplied cords and cables. If you use optional accessories, use the cords and the cables supplied with them.
 - Do not extend the cords and the cables.

- Do not spray insecticides or volatile chemicals onto the unit.
- Before cleaning, detach the battery or pull the AC cable from the AC outlet, and then wipe the unit with a soft, dry cloth.
- If the unit is very dirty, dip a cloth in water and squeeze firmly, and then wipe the unit with the damp cloth. Next, dry the unit with a dry cloth.
- Use of benzine, paint thinner, alcohol, or dishwashing liquid may alter the camera body or peel the surface finish. Do not use these solvents.
- When using a chemical dust cloth, follow the instructions that came with the cloth.
- When storing the unit in a cupboard or cabinet, it is recommended that you place a desiccant (silica gel) in with it.
- The battery used in this unit is a rechargeable lithium-ion battery. It is susceptible to humidity and temperature and the effect increases the more the temperature rises or falls.
- If the operating time is very short even after the battery has been recharged, the battery has worn out. Please purchase a new battery.
- When the card access lamp is lit, do not:
 - Remove the SD card
 - Turn the unit off
 - Insert and remove the USB cable
 - Expose the unit to vibrations or shock

■ About the recording method for recording motion pictures

This unit can record motion pictures using four different recording methods, including MOV (LPCM), MP4 (LPCM), MP4 and AVCHD*1. (→ 31)

*1 AVCHD Progressive (1080/60p, 1080/50p) supported.

MOV (LPCM)*2, MP4 (LPCM)*2, 3:

This recording method is suitable for editing images. Audio is recorded in linear PCM.

MP4*2, 3:

This recording method is suitable for playback and editing on a PC. Audio is recorded in AAC.

*2 Those methods are not compatible with motion pictures recorded in AVCHD format.

*3 Those methods can record motion pictures in formats that support 4K. 4K motion pictures offer a resolution four times higher than that of full high-definition motion pictures.

AVCHD:

This recording method is suitable for playback on a high-definition TV or storage on a disc.

Audio is recorded in Dolby® Digital.

■ Regarding system frequencies

The NTSC/PAL standard setting of this unit can be switched in [SYSTEM FREQ]. (→ 30)

- To use this unit in regions where the TV broadcasting system is NTSC, set it to [59.94Hz(NTSC)]. To use this unit in regions where the TV broadcasting system is PAL, set it to [50Hz(PAL)]. (Playback is not possible on TVs and other devices with a standard that differs from the system frequency setting of this unit.)
- If you record an AVCHD scene on the SD card, it cannot be used with a different system frequency. Use another SD card when you change the system frequency.

■ Indemnity about recorded content

Panasonic does not accept any responsibility for damages directly or indirectly due to any type of problems that result in loss of recording or edited content, and does not guarantee any content if recording or editing does not work properly. Likewise, the above also applies in a case where any type of repair is made to the unit.

■ About Condensation (When the lens, the viewfinder or LCD Monitor is fogged up)

Condensation occurs when there is a change in temperature or humidity, such as when the unit is taken from outside or a cold room to a warm room. Please be careful, as it may cause the lens, the viewfinder or LCD monitor to become soiled, moldy, or damaged.

When taking the unit to a place which has a different temperature, if the unit is accustomed to the room temperature of the destination for about one hour, condensation can be prevented. (When the difference in temperature is severe, place the unit in a plastic bag or the like, remove air from the bag, and seal the bag.) When condensation has occurred, remove the battery and/or the AC adapter and leave the unit like that for about one hour. When the unit becomes accustomed to the surrounding temperature, fogginess will disappear naturally.

■ About security

Be careful about the possibility of theft or loss of the unit, and be careful not to leave the unit unattended. Please note that Panasonic does not accept any responsibility for the compromise, manipulation, and loss of information caused by these events.

■ Caution regarding laser beams



The lens may suffer damage if struck by a laser beam. Make sure that laser beams do not strike the lens when shooting in an environment where laser devices are used.

■ Cards that you can use with this unit

SDHC Memory Card and SDXC Memory Card

- 4 GB or more Memory Cards that do not have the SDHC logo or 48 GB or more Memory Cards that do not have the SDXC logo are not based on SD Memory Card Specifications.
- Refer to page 23 for more details on SD cards.

■ For the purposes of these owner's manual

- The battery pack is referred to as the "Battery".
- SDHC Memory Card and SDXC Memory Card are referred to as the "SD card".
- The smartphone and tablet are indicated as "smartphone".
- Function that can be used for Recording Mode: 
Function that can be used for Playback Mode: 

- Scene(s) recorded with [REC MODE] set to [MOV (LPCM)], [MP4 (LPCM)] or [MP4]: "MOV/MP4 scene(s)".
- Scene(s) recorded with [REC MODE] set to [AVCHD]: "AVCHD scene(s)".
- The correct value for 60p/60i/30p/24p is 59.94p/59.94i/29.97p/23.98p (except C4K).
- Pages for reference are indicated by an arrow, for example: → 00

■ Installing HD Writer XE 2.0

Check the website below to download/install the software.
http://panasonic.jp/support/global/cs/soft/download/f_xe20.html

Brazil Only Brasil Apenas

<Manuseio de baterias usadas>



BRASIL

Após o uso, as pilhas e/ou baterias deverão ser entregues ao estabelecimento comercial ou rede de assistência técnica autorizada.

Cobrir os terminais positivo (+) e negativo (-) com uma fita isolante adesiva, antes de depositar numa caixa destinada para o recolhimento. O contato entre partes metálicas pode causar vazamentos, gerar calor, romper a blindagem e produzir fogo.

Não desmonte, não remova o invólucro, nem amasse a bateria. O gás liberado pela bateria pode irritar a garganta, danificar o lacre do invólucro ou o vazamento provocar calor, ruptura da blindagem e produzir fogo devido ao curto circuito dos terminais. Não incinere nem aqueça as baterias, elas não podem ficar expostas a temperaturas superiores a 100°C (212°F). O gás liberado pela bateria pode irritar a garganta, danificar o lacre do invólucro ou o vazamento provocar calor, ruptura da blindagem e produzir fogo devido ao curto circuito dos terminais provocado internamente. Evite o contato com o líquido que vazar das baterias. Caso isto ocorra, lave bem a parte

afetada com bastante água. Caso haja irritação, consulte um médico.

Para remover a bateria

Bateria Principal de Energia

Pressione o botão para liberar a bateria.

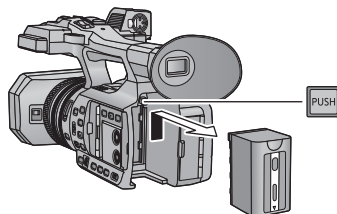

Contents

Accessories	12
-------------------	----

Preparation

Names and Functions of Main Parts	13
Power supply	20
Charging the battery	20
Inserting/removing the battery.....	21
Charging and recording time.....	21
Connecting to the AC outlet	22
Preparation of SD cards	23
Cards that you can use with this unit.....	23
Inserting/removing an SD card.....	24
Turning the unit on/off	25
Selecting a mode	25
Using the LCD monitor/Viewfinder	26
Using the LCD monitor.....	26
How to use the touch screen	27
Viewfinder adjustment.....	27
Setting date and time	28
Using the menu screen	29
Formatting cards	29
System frequency Selection.....	30
Language Selection	30

Recording

Selecting a media to record	30
Recording motion pictures	31
Recording still pictures	31
Using the zoom	32
Intelligent Auto Mode/ Manual Mode	32
Manual Recording	33
Focus	33
White Balance	33
Iris/Gain adjustment	34
Manual shutter speed	34
USER button	35
Setting the USER button	35
Using the USER button	35
Functions of the USER button	36

Playback

Motion picture/Still picture playback	37
Watching Video/Pictures on your TV	38

Wi-Fi

Wi-Fi® function	39
Install the “Image App”	39
Using remote operation with a direct connection.....	40
If the Wi-Fi connection cannot be established.....	41

Others

Troubleshooting	42
About copyright	43
Specification	44
Optional accessories	47
Accessory Order Form (For USA Customers)	48
Limited Warranty (ONLY FOR U.S.A.)	49
Warranty (For Canadian Customers)	51
Useful Information (Only For Latin American Countries)	52

Accessories

Check the accessories before using this unit.

Keep the accessories out of reach of children to prevent swallowing.

Product numbers correct as of Sep. 2014. These may be subject to change.

Battery pack

VW-VBD58



Battery charger

DE-A88B

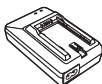

AC adaptor

VSK0725



AC cable

(A) for AC adaptor
K2CB2YY00106

(B) for Battery charger
K2CA2CA00025

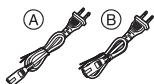

Microphone holder

screws

VYC1144

12 mm length (0.47")

(2 screws)



Lens hood*2

SYK0438



*1 The INPUT terminal caps are supplied with the microphone holder.

*2 The lens hood is attached to this unit at the time of purchase.

Eye cup

SYA0019



USB cable

K2KYYYY00245



HDMI cable

K1HY19YY0024



Shoulder strap

VFC4897



SYA0021

Microphone holder

VYC1146



INPUT terminal cap
(2 caps)*1

VJF1468



Names and Functions of Main Parts

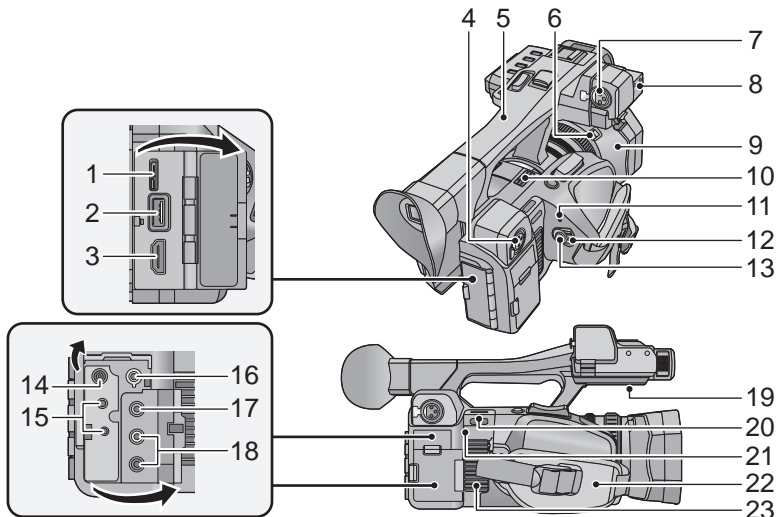

- 1 USB terminal [USB 3.0 DEVICE]
 - 2 USB terminal [USB 3.0 HOST]
 - 3 HDMI connector [HDMI] (→ 38)
 - 4 Audio input terminals 2 (XLR 3 pin) [AUDIO INPUT2] (→ 19)
 - 5 Handle
 - 6 Lens hood release button
 - 7 Audio input terminals 1 (XLR 3 pin) [AUDIO INPUT1] (→ 19)
 - 8 Microphone holder attachment part (→ 18)
 - 9 Lens hood
 - 10 Exhaust opening (cooling fan)
 - 11 Status indicator (→ 25)
 - 12 Power switch (→ 25)
 - 13 Recording start/stop button (→ 31)
 - 14 DC input terminal [DC IN] (→ 22)
- Do not use any other AC adaptors except the supplied one.
- 15 Camera remote jack [CAM REMOTE] (3.5 mm (0.14 ") mini jack)
It is possible to adjust the focus or iris by connecting a remote control (commercially-available).

- It is not possible to use the remote control (commercially-available) in the Intelligent Auto Mode.

[ZOOM S/S] (2.5 mm (0.1 ") super mini jack)

It is possible to operate zoom operation or recording start/stop connecting with the remote control (commercially-available).

- Do not connect any equipment except the remote control (commercially-available) to the camera remote jack. Brightness of the image may change or it may not focus when an equipment other than the remote control (commercially-available) is connected.

- 16 Headphone terminal [Ω]
- 17 Video output connector [VIDEO OUT] (→ 38)
- 18 Audio output connector [AUDIO OUT] (→ 38)
- 19 Speaker
- 20 Shoulder strap fixture (→ 18)
- 21 Wi-Fi Transmitter
- 22 Grip belt (→ 17)
- 23 Inlet (cooling fan)

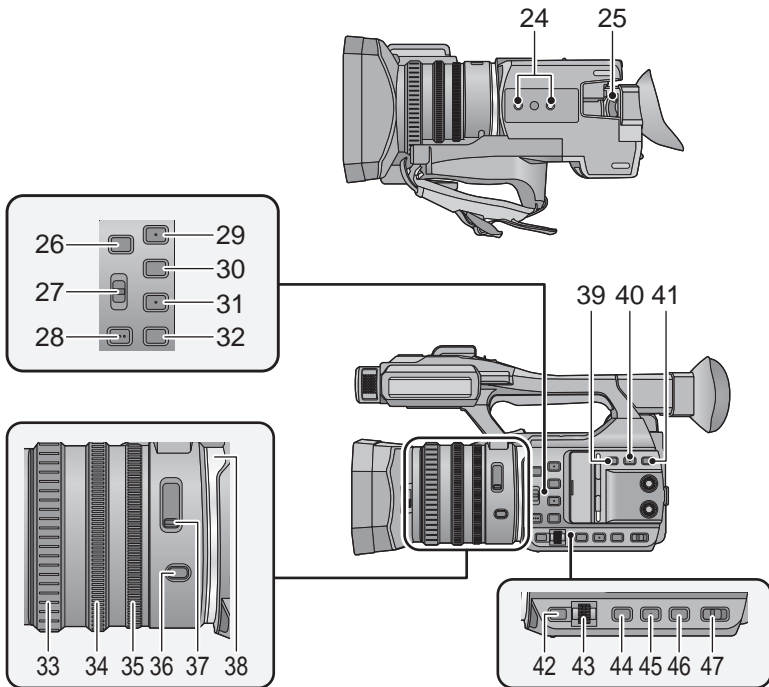

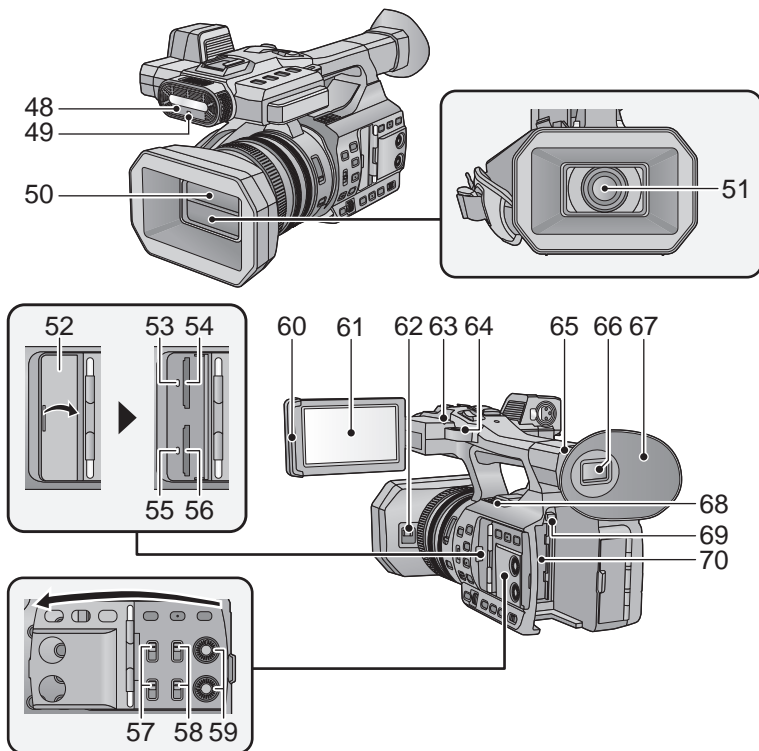

- 24 Tripod receptacle (→ 19)
- 25 Eyepiece corrector lever (→ 27)
- 26 User 5 buttons [USER5]/[FOCUS ASSIST] (→ 35)
- 27 Focus auto/Manual/∞ switch [FOCUS A/M/∞] (→ 33)
- 28 Push AF buttons [PUSH AF]
- 29 User 1 buttons [USER1] (→ 35)
- 30 User 2 buttons [USER2] (→ 35)
- 31 User 3 buttons [USER3] (→ 35)
- 32 User 4 buttons [USER4] (→ 35)
- 33 Focus ring (→ 33)
- 34 Zoom ring (→ 32)
- 35 Iris ring (→ 34)
- 36 Iris button [IRIS] (→ 34)
- 37 ND filter switch [ND FILTER]
- 38 Ring LED
- 39 Optical Image Stabilizer button [O.I.S.]
- 40 Zebra button [ZEBRA]
- 41 Display/Mode check button [DISP/MODE CHK]
- 42 Menu button [MENU] (→ 29)
- 43 Multi-function dial [SEL/PUSH SET] (→ 33, 34)
- 44 Gain button [GAIN] (→ 34)
- 45 White Balance button [W.B.] (→ 33)
- 46 Shutter speed button [SHUTTER] (→ 34)
- 47 Intelligent auto/Manual switch [iA/MANU] (→ 32)

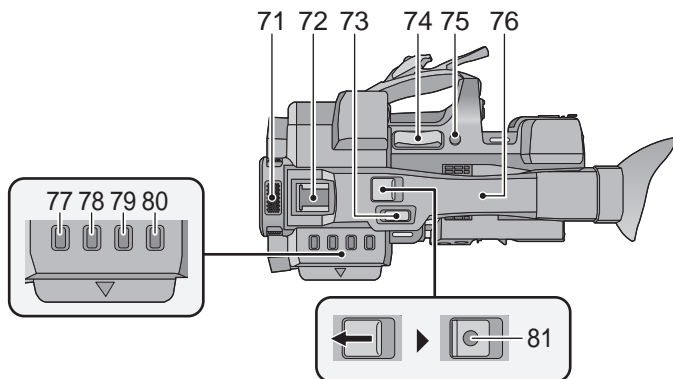

- 48 Infrared light
- 49 Recording lamp (Front)
- 50 Lens cover (→ 17)
- 51 Lens (LEICA DICOMAR) (→ 17)
- 52 SD Card slot cover (→ 24)
- 53 Access lamp (card 1) (→ 24)
- 54 Card slot 1 (→ 24)
- 55 Access lamp (card 2) (→ 24)
- 56 Card slot 2 (→ 24)
- 57 INPUT 1, 2 switches [INPUT1, INPUT2]
- 58 CH1, CH2 switches [CH1, CH2]
- 59 Audio control knobs [CH1, CH2]
- 60 LCD monitor extract part (→ 26)
- 61 LCD monitor (Touch screen) (→ 27)
- 62 Lens cover open/close lever (→ 17)
- 63 Recording lamp (Rear)
- 64 Shoulder strap fixture (→ 18)
- 65 Eye cup attachment part (→ 17)
- 66 Viewfinder (→ 27)
- 67 Eye cup (→ 17)
- 68 Exhaust opening (cooling fan)
- 69 Battery release button [PUSH] (→ 21)
- 70 Battery holder (→ 21)



- 71 Internal microphones**
- 72 Accessory shoe**
- 73 Sub zoom lever (→ 32)**
 - This lever functions in the same manner as the zoom lever.
- 74 Zoom lever [T/W] (In Recording Mode) (→ 32)**
 - Volume lever [+VOL-]/Thumbnail display switch [Q / **
- 75 User 6 buttons [REC CHECK] (→ 35)**
- 76 NFC touch area [**
- 77 Thumbnail button [THUMBNAIL]**
- 78 Counter button [COUNTER]**
- 79 Counter reset button [RESET]**
- 80 Color Bar Screen button [BARS]**
- 81 Sub recording start/stop button**
 - This button functions in the same manner as the recording start/stop button.

■ Opening/closing the lens cover

You can open/close the lens cover by sliding the lens cover open/close lever.

- When this unit is not in use, close the lens cover to protect the lens.

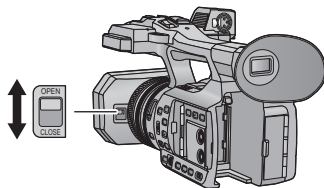

- Do not press the lens cover hard. This may damage the lens or the lens cover.
- Depending on the various filters or the MC protector attached to the front side of this unit's lens, you may not be able to open/close the lens cover or attach the lens hood.

■ Adjust the length of the grip belt so that it fits your hand.

Adjust the grip belt according to the size of your hand.

- If you find it difficult to fasten the buckle **B**, move the pad **A** towards you, and fasten the buckle **B** again.

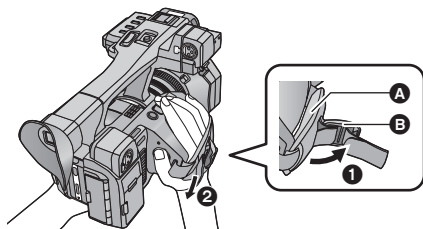

- 1 Open the buckle.
- 2 Pull the end of the belt.

■ Attaching the eye cup

Attach by aligning the notch of the eye cup attachment part with the protrusion at the inside of the eye cup.

- The illustration below is an example of attaching the eye cup to use it with your right eye. If you rotate the eye cup to the left by 180° before attaching it, you can use it with your left eye.

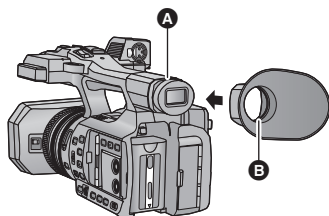

- A Notch
- B Protrusion

■ Attaching the Shoulder strap

We recommend that you attach the shoulder strap (supplied) before going out of doors to record so as to avoid dropping this unit.

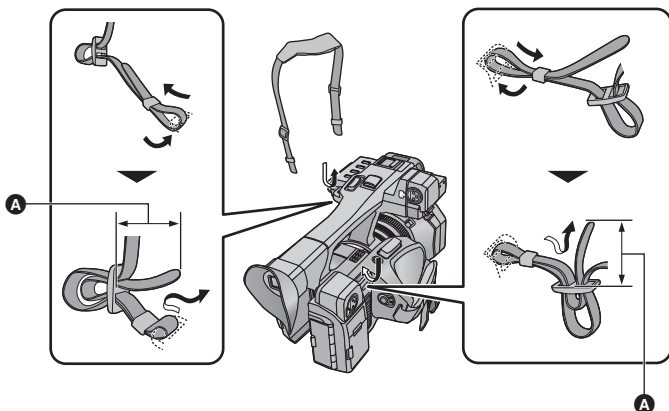

A 20 mm (0.8 ") or longer

■ Attaching the front microphone

- The microphone holder is set up so that a 21 mm (0.83 ") external microphone (AG-MC200G: optional) can be attached. Check in advance whether the microphone you wish to use can be attached.

1 Attach the microphone holder to the microphone holder attachment part.

- Attach by using a commercially available screw driver.
- When attaching the microphone holder, be sure to tighten the screws firmly even though you might hear a squeaking sound.

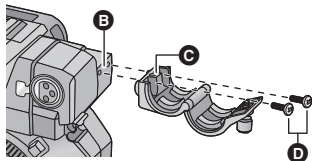

- B** Microphone holder attachment part
- C** Microphone holder
- D** Microphone holder screws

- 2 Attach an external microphone (optional) to the microphone holder, and tighten the microphone holder screws.
 - 3 Connect the external microphone to the AUDIO INPUT1 terminal (XLR 3 pin).
- When wiring the microphone cable, use the cable clamper of this unit.

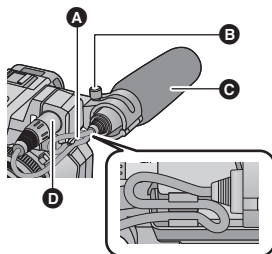

- A Microphone cable clamper
- B Microphone holder screws
- C External microphone (optional)
- D AUDIO INPUT1 terminal (XLR 3 pin)

■ Attaching the INPUT terminal cap

Attach the INPUT terminal cap while the audio input terminals 1, 2 (XLR 3 pin) is not used.

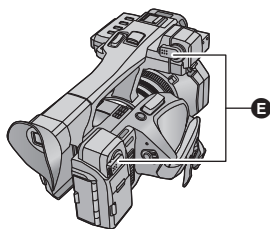

- E INPUT terminal cap

■ Attaching the tripod

- There are tripod receptacle that are compatible with 1/4-20UNC screws.
- Attaching a tripod with a screw length of 5.5 mm (0.22 ") or more may damage the unit.

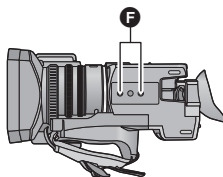

- F Tripod receptacle

Power supply

■ About batteries that you can use with this unit

(For the U.S.A. and Canada)

The battery that can be used with this unit is VW-VBD58/CGA-D54.

(For Areas other than the U.S.A. and Canada)

The battery that can be used with this unit is VW-VBD58/CGA-D54s.

It has been found that counterfeit battery packs which look very similar to the genuine product are made available to purchase in some markets. Some of these battery packs are not adequately protected with internal protection to meet the requirements of appropriate safety standards. There is a possibility that these battery packs may lead to fire or explosion. Please be advised that we are not liable for any accident or failure occurring as a result of use of a counterfeit battery pack. To ensure that safe products are used we would recommend that a genuine Panasonic battery pack is used.

Charging the battery

When this unit is purchased, the battery is not charged. Charge the battery fully before using this unit for the first time.

Important:

- Do not use the AC cable with any other equipment as it is designed only for this unit. Also, do not use the AC cable from other equipment with this unit.
- It is recommended to charge the battery in a temperature between 10 °C and 30 °C (50 °F and 86 °F). (The battery temperature should also be the same.)

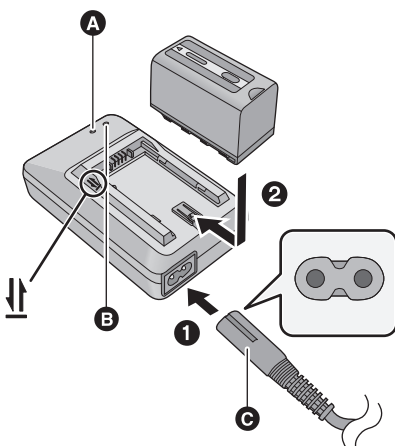

Charging lamp [CHARGE] **A**

Lights up:

Charging (Battery charging time: → 21)

Goes off:

Charging completed

Flashing:

Be sure to connect the unit correctly

Power lamp **B**

- This will light up when the AC cable is connected.

C AC cable (K2CA2CA00025; supplied)

- Insert the plugs as far as they will go.

1 Connect the AC cable to the battery charger and the AC outlet.

- Use the AC cable (K2CA2CA00025; supplied) dedicated for the battery charger.

2 Insert the battery into the battery charger by aligning the arrows.

- We recommend using Panasonic batteries (→ 12, 20, 21, 47).
- If you use other batteries, we cannot guarantee the quality of this product.
- Do not heat or expose to flame.
- Do not leave the battery(ies) in a car exposed to direct sunlight for a long period of time with doors and windows closed.

Inserting/removing the battery

Install the battery by inserting it in the direction shown in the figure.

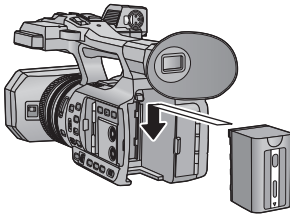

Insert the battery until it clicks and locks.

Removing the battery

Make sure that the power switch is set to OFF and the status indicator is turned off, and then remove by holding onto it taking care not to drop. (→ 25)

While pressing the battery release button, remove the battery.

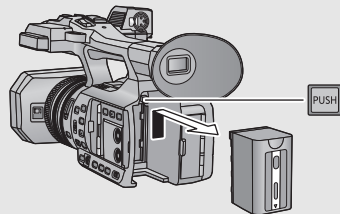

Charging and recording time

Charging/Recording time

- Temperature: 25 °C (77 °F)/humidity: 60%RH
- When using the viewfinder (times in parentheses are when using the LCD monitor)



Battery model number [Voltage/Capacity (minimum)]	Charging time	Recording mode	Recording format	Maximum continuously recordable time	Actual recordable time
Supplied battery/ VW-VBD58 (optional) [7.2 V/5800 mAh]	6 h 20 min	MP4 (LPCM)	[4K/60p 150M]	4 h 30 min (4 h 15 min)	2 h 20 min (2 h 15 min)

- Please refer to “Owner’s Manual (PDF format)” for details.

- “h” is an abbreviation for hour, “min” for minute and “s” for second.
- These times are approximations.
- **The indicated charging time is for when the battery has been discharged completely. Charging time and recordable time vary depending on the usage conditions such as high/low temperature. Recordable time also varies depending on the [REC FORMAT] setting.**

- The actual recordable time refers to the recordable time when repeatedly starting/stopping recording, turning the unit on/off, moving the zoom lever etc.
- The batteries heat up after use or charging. This is not a malfunction.

Battery capacity indication

- The display changes as the battery capacity reduces.  If the battery discharges, then  will flash red.

Connecting to the AC outlet

The unit is in the standby condition when the AC adaptor is connected. The primary circuit is always “live” as long as the AC adaptor is connected to an electrical outlet.

Important:

- **Use the supplied AC adaptor. Do not use the AC adaptor of another device.**
- **Do not use the AC cable with any other equipment as it is designed only for this unit. Also, do not use the AC cable from other equipment with this unit.**

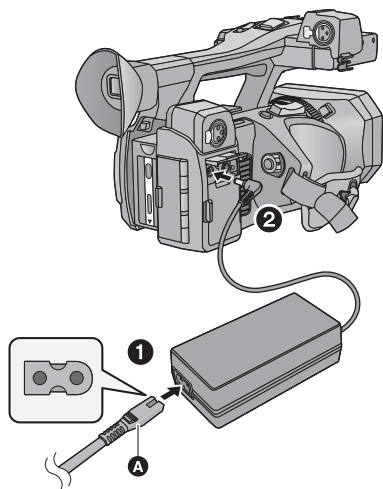

- **A** AC cable (K2CB2YY00106; supplied)
- Insert the plugs as far as they will go.

1 Connect the AC cable to the AC adaptor and the AC outlet.

- Use the AC cable (K2CB2YY00106; supplied) dedicated for the AC adaptor.

2 Connect the AC adaptor to the DC input terminal [DC IN].

- Make sure to set the power switch to OFF and the status indicator is turned off when disconnecting the AC adaptor. (→ 25)

- Even when you use the AC adaptor for recording images, keep the battery connected. This allows you to continue the recording even if a power failure occurs or the AC adaptor is unplugged from the AC outlet by accident.

Preparation of SD cards





The unit can record motion pictures or still pictures to an SD card.

This unit (an SDXC compatible device) is compatible with SDHC Memory Cards and SDXC Memory Cards. When using an SDHC Memory Card/SDXC Memory Card with other equipment, check the equipment is compatible with these Memory Cards.

Cards that you can use with this unit

■ About the Speed Class ratings for recording motion pictures

- Depending on [REC MODE] and [REC FORMAT], the required card differs.
Use a card that meets the following ratings of the SD Speed Class or UHS Speed Class.
Use of a non-compatible card may cause recording to stop suddenly.
- SD Speed Class and UHS Speed Class are the speed standards regarding continuous writing. To check the class, see the labelled side, etc. of the card.

Recording modes	Bit rates in [REC FORMAT]	Speed Class ratings	Label examples
MOV (LPCM)/ MP4 (LPCM)/ MP4	100 Mbps or more	UHS Speed Class3	
	50 Mbps	UHS Speed Class1 or more	
		Class10 or more	
AVCHD	All	Class4 or more	

- Keep the Memory Card out of reach of children to prevent swallowing.

Inserting/removing an SD card

When using a non Panasonic SD card for the first time, or one which was previously used on another equipment, it is necessary to format the SD card. (→ 29) When the SD card is formatted, all of the recorded data is deleted. Once the data is deleted, it cannot be restored.

Caution:

Check that the access lamp has gone off.

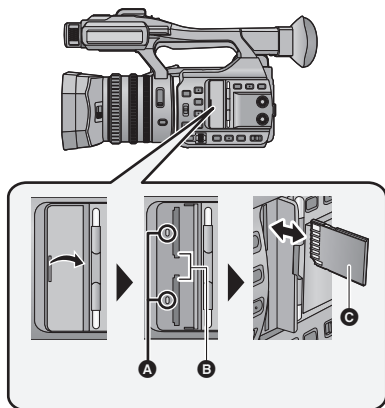

Access lamp **A**

- When this unit is accessing the SD card, the access lamp lights up.

1 Open the SD card slot cover and insert (remove) the SD card into (from) the card slot **B**.

- One SD card can be inserted into each of the card slot 1 and the card slot 2.
- Face the terminal side **C** in the direction shown in the illustration and press it straight in as far as it will go.
- Press the center of the SD card and then pull it straight out.

2 Securely close the SD card slot cover.

Turning the unit on/off

Set the power switch to ON while pressing the lock release button **B** to turn on the unit.

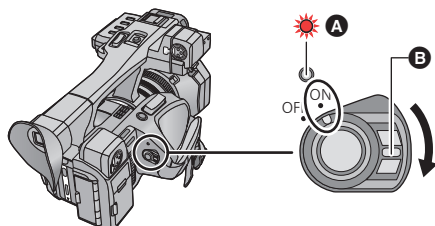

To turn off the unit

Set the power switch to OFF while pressing the lock release button. The status indicator goes off.

A The status indicator lights on.

- To turn on the unit again after the [ECONOMY (BATT)] or [ECONOMY (AC)] is activated, set the power switch to OFF once, and then to ON again.

Selecting a mode

Press the THUMBNAIL button to change the mode to Recording Mode or Playback Mode.

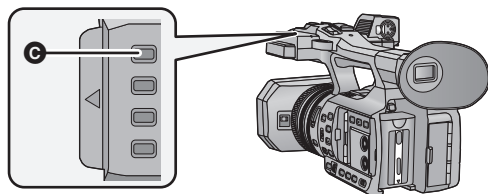

C THUMBNAIL button

Recording Mode (→ 31)	The recording screen is displayed. You can record motion pictures and still pictures.
Playback Mode (→ 37)	The thumbnail screen for playback is displayed. You can play back motion pictures and still pictures.

- When you turn on this unit, it starts up in Recording Mode.
- If you press the recording start/stop button or sub recording start/stop button in Playback Mode, the mode will be switched to Recording Mode and recording will start.

Using the LCD monitor/Viewfinder

The viewfinder is turned off and the LCD monitor is turned on when the LCD monitor is extracted.
The viewfinder is turned on when the LCD monitor is retracted.

Using the LCD monitor

1 Extract the LCD monitor in the direction as indicated in the figure.

- Hold the LCD monitor extract part **A**, and extract the LCD monitor until it clicks into position.

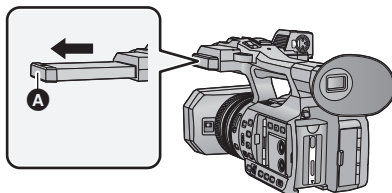

2 Rotate to the position that is easy to view.

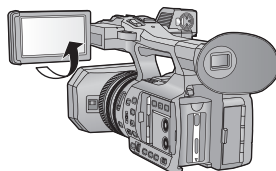

To retract the LCD monitor

Retract as shown in the figure with the LCD facing downward.

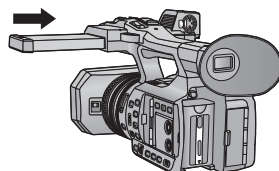

Range of rotation of the LCD monitor

- It can rotate up to 270° **B** towards the lens.

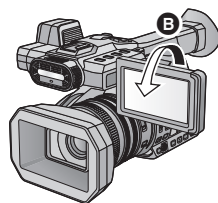

How to use the touch screen

You can operate by directly touching the LCD monitor (touch screen) with your finger.

■ Touch

Touch and release the touch screen to select icon or picture.

- Touch the center of the icon.
- Touching the touch screen will not operate while you are touching another part of the touch screen.

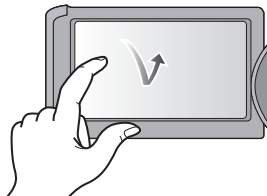

■ Slide while touching

Move your finger while pressing on the touch screen.

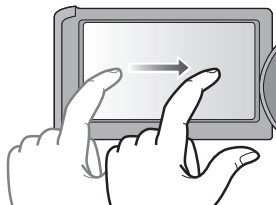

■ About the operation icons



Touch when changing a page or performing settings.



- Do not touch the LCD monitor with hard pointed tips, such as ball point pens.

Viewfinder adjustment

Adjusting the field of view

This setting will not affect the images actually recorded. It adjusts the field of view to show the viewfinder clearly.

1 Adjust the viewfinder to suit your vision so that you can see the display images clearly.

- Be careful not to trap your fingers when moving the viewfinder.
- The viewfinder can be lifted vertically up to approximately 90°.
- Retract the LCD monitor and turn on the viewfinder.

2 Adjust the focus by operating the eyepiece corrector lever.

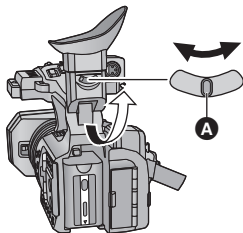

A Eyepiece corrector lever

Setting date and time

When this unit is turned on, the message [SET TIME ZONE AND DATE/TIME] may appear. To make these settings, select [YES], and follow the instructions from Step 2-3 of the time zone setting procedure.

1 Select the menu. (→ 29)

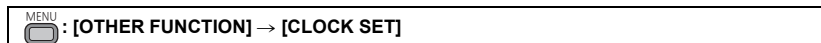

2 Touch the date or time to be set, then set the desired value using ▲/▼.

- The year can be set between 2000 and 2039.

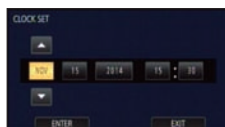

3 Touch [ENTER].

4 Touch [EXIT] to complete the setting.

- The date and time function is driven by a built-in lithium battery.
- If the time display becomes [- -], the built-in lithium battery needs to be charged. To recharge the built-in lithium battery, connect the AC adaptor or attach a charged battery to this unit. Leave the unit as it is for approx. 24 hours and the battery will maintain the date and time for approx. 6 months. (The battery is still being recharged even if the unit is off.)
- The way that time is displayed can be changed in the menu settings. [DISP SETUP] → [DATE/TIME] or [DATE FORMAT]

Time zone

Time difference from the Greenwich Mean Time can be set.

1 Select the menu. (→ 29)

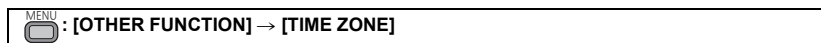

2 Touch ◀/▶ and set the region to record.

3 Touch [ENTER].

- If the [CLOCK SET] screen appears, perform [CLOCK SET].

4 Touch [EXIT] to complete the setting.

- When the time zone setting is changed, the date/time setting of the unit also changes automatically.

Using the menu screen

- You can select menu items by operating the multi-function dial.

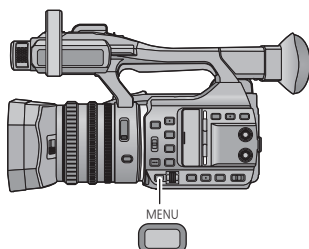

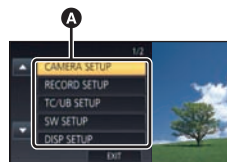

1 Press the MENU button .

2 Touch the top menu **A**.



3 Touch the submenu **B**.

- Next (Previous) page can be displayed by touching  / .

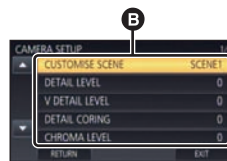

4 Touch the desired item to enter the setting.

5 Touch [EXIT] to exit the menu setting.

Formatting cards

If you use the SD cards for the first time for recording with this unit, format the cards. Please be aware that if a medium is formatted, then all the data recorded on the medium will be erased and cannot be restored. Back up important data on a PC etc.

- When using two SD cards, format both SD cards.

Select the menu.

 : [OTHER FUNCTION] → [FORMAT MEDIA] → [SD CARD 1] or [SD CARD 2]

- Do not format a SD card using any other equipment such as a PC. The card may not be used on this unit.

System frequency Selection

Set the system frequency of this unit. Change the setting when creating a motion picture that has a broadcasting system different from that of your region.

Select the menu.

 : [OTHER FUNCTION] → [SYSTEM FREQ] → [59.94Hz(NTSC)] or [50Hz(PAL)]

- After you have changed the system frequency, this unit will be restarted.
- By default, the system frequency is set to the broadcasting system of the region where this product was purchased.
- This function's default setting is [59.94Hz(NTSC)].

Language Selection

You can select the language on the screen display and the menu screen.

1 Select the menu.

 : [OTHER FUNCTION] → [LANGUAGE]

2 Touch the desired setting language.

Recording 

Selecting a media to record

[SD CARD 1] and [SD CARD 2] can be selected separately to record motion pictures or still pictures.

1 Select the menu.

 : [RECORD SETUP] → [MEDIA SELECT]

2 Touch the media to record motion pictures or still pictures.

- The media is selected separately for motion pictures or still pictures and is then highlighted in yellow.

3 Touch [ENTER].





Recording motion pictures

- Before turning on this unit, open the lens cover. (→ 17)

1 Change the mode to Recording Mode. (→ 25)

- Extract the LCD monitor.

2 Press the recording start/stop button **B** to start recording.

- Recording will stop when you press the recording start/stop button again.

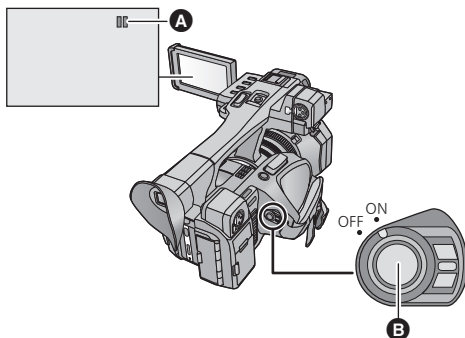

A When you begin recording, changes to .



Recording still pictures

- Before turning on this unit, open the lens cover. (→ 17)
- Register [CAPTURE] to a USER button. (→ 35)

1 Change the mode to Recording Mode. (→ 25)

- Extract the LCD monitor.

2 Press the USER button to which [CAPTURE] is registered or touch the applicable USER button icon to record a still picture.

- For information on the locations of the USER buttons and information on USER button icons, refer to page 35.
- When still pictures are being recorded, the remaining recordable number of still pictures and the still picture indication are displayed.



Using the zoom

It can be zoomed up to 20×.

- (When the picture size of [REC FORMAT] is 1920×1080 or below)
It can zoom up to 40× when the [i.Zoom] is set to [ON].
- Zoom magnification can be checked in the screen display of Z00 to Z99. The value gets larger when zoomed in, and the value gets smaller when zoomed out. **Z99** is displayed during the i.Zoom.

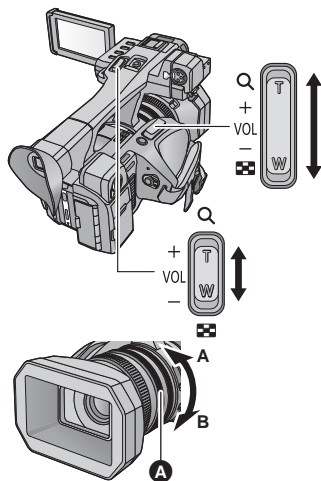

Zoom lever/Sub zoom lever

T side:

Close-up recording (zoom in)

W side:

Wide-angle recording (zoom out)

Ring Zoom

A side:

Wide-angle recording (zoom out)

B side:

Close-up recording (zoom in)

A Zoom ring



Intelligent Auto Mode/Manual Mode

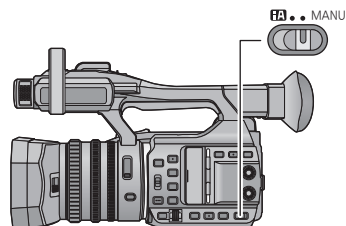

iA/MANU switch

Slide the switch to change the Intelligent Auto Mode/Manual Mode.

- **MNL** is displayed in the Manual Mode.
- The modes appropriate for the condition are set just by pointing the unit to what you want to record in the Intelligent Auto Mode.



Manual Recording

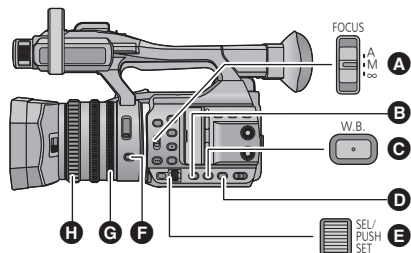

- A** FOCUS A/M/∞ switch
- B** GAIN button
- C** W.B. button
- D** SHUTTER button
- E** Multi-function dial
- F** IRIS button
- G** Iris ring
- H** Focus ring

Focus

Perform focus adjustments using the focus ring. If auto focusing is difficult due to the conditions, then use Manual Focus.

- Switch to Manual Mode. (→ 32)

1 Set the FOCUS A/M/∞ switch to [M] to enable Manual Focus.

- It will switch to MF from AF.

2 Adjust the focus by rotating the focus ring.

White Balance

Automatic White Balance function may not reproduce natural colors depending on the scenes or lighting conditions. If so, you can adjust the White Balance manually.

- Use the multi-function dial to change the settings.

- Switch to Manual Mode. (→ 32)

1 Press the W.B. button to switch to the Manual White Balance Mode.

- The White Balance mode will switch to the one you set previously.

2 Rotate the multi-function dial to switch the White Balance mode.



Iris/Gain adjustment

When recording a scene that is too dark (or bright) or a scene in a similar situation, manually adjust the iris and gain.

■ Iris adjustment

- Switch to Manual Mode. (→ 32)

1 Press the IRIS button to switch to Manual Iris Mode.

- [STD] disappears.

2 Adjust the iris by rotating the iris ring.

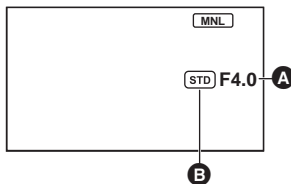

- A** Iris value
 - B** Auto iris icon *
- * It is displayed in Auto Iris Mode.

■ Gain adjustment

- Use the multi-function dial to change the settings.
- Switch to Manual Mode. (→ 32)

1 Press the GAIN button to switch to Manual Gain Mode.

- The gain value will be displayed in dB.

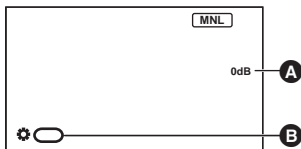

- A** Gain value
- In Auto Gain Mode, AGC is displayed; in Manual Gain Mode, the gain value is displayed in dB.
- B** [GAIN]

2 Adjust the gain by rotating the multi-function dial.



Manual shutter speed

Adjust the shutter speed when recording fast-moving subjects.

- Use the multi-function dial to change the settings.
- Switch to Manual Mode. (→ 32)

1 Press the SHUTTER button to switch to Manual Shutter Mode.

2 Adjust the shutter speed by rotating the multi-function dial.





USER button

Each of the USER button can register one function from the 24 available functions.

- There are six USER buttons (USER1 to USER6) on the main body and four USER button icons (USER7 to USER10) displayed on the LCD monitor.

Setting the USER button

1 Select the menu.

MENU : [SW SETUP] → [USER BUTTON SETUP]

2 Touch the USER button you wish to set.

- The USER button number and currently set function name are displayed. (For example, a display of 1. [DRS] means that [DRS] has been assigned to USER1 button.)



3 Touch the item to register.

- For the functions of the USER button that can be registered, refer to page 36.
- Touch [INH] (Inhibit) if not registering.
- Next (Previous) page can be displayed by touching ▲ / ▼.
- To continuously set other USER buttons, repeat Steps 2-3.

4 Touch [EXIT] to complete the setting.

Using the USER button

To use the set USER button, press USER1 to USER6 button or touch the USER7 to USER10 button icon displayed when you touch the LCD monitor.

(When you use the USER1 to USER5 button)

(When you use the USER6 button)

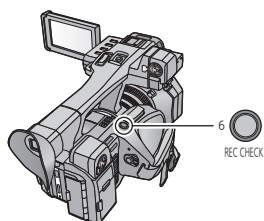
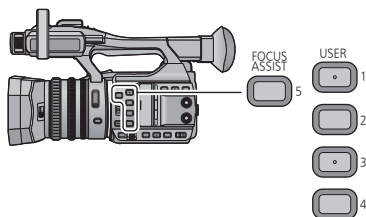

(When you use the USER7 to USER10 button)

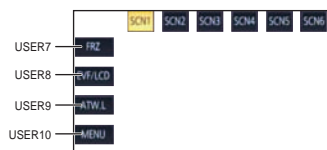

Functions of the USER button

■ List of USER button function

Icon	Item	Function
[FA]	[FOCUS ASSIST]	Focus Assist
[B.Light]	[BACKLIGHT]	Backlight Compensation
[S.Light]	[SPOTLIGHT]	Spotlight
[B.FD]	[BLACK FADE]	Black Fade
[W.FD]	[WHITE FADE]	White Fade
[EVF/LCD]	[EVF/LCD DETAIL]	EVF/LCD detail
[ATW.L]	[ATW LOCK]	ATW Lock
[D.ZM]	[D.ZOOM]	Digital Zoom
[HIST]	[HISTOGRAM]	Histogram
[REC.C]	[REC CHECK]	Recording Check
[LstDel]	[LAST SCN DEL]	Last Scene Delete
[DRS]	[DRS]	DRS*
[FRZ]	[FRZ FRAME]	Freeze Frame
[S.Gain]	[SUPER GAIN]	Super Gain*
[AREA]	[AREA]	Area Mode*
[F.Tran]	[FOCUS TRANS]	Focus Transition*
[Capture]	[CAPTURE]	Capture
[Wi-Fi]	[Wi-Fi]	Wi-Fi
[IR Light]	[IR LIGHT]	Infrared light*
[Level]	[LEVEL GAUGE]	Level Gauge
[Backgr]	[BACKGROUND]	Background
[FBC]	[FLASH BAND]	Flash band compensation*
[MENU]	[MENU]	Menu

* These functions are not available in Intelligent Auto Mode.

• The following USER button function can also be set from the menu.

- [HISTOGRAM]
- [DRS]
- [IR LIGHT]
- [LEVEL GAUGE]
- [EVF/LCD DETAIL]
- [FLASH BAND]



Motion picture/Still picture playback

1 Set this unit to playback mode. (→ 25)

2 Touch the play mode select icon **A**.

3 Select the media **C** you wish to play back.

4 (To set this unit to Motion Picture Playback Mode)

Touch the desired recording mode **D** and recording format **E** for playback.

- The available recording format options differ depending on [SYSTEM FREQ] (→ 30) or the recording mode option you have touched.

- Touch [ENTER].

- A recording mode icon **B** will be displayed on the thumbnail display. (/ / /)

- (If you have touched the recording mode option [MOV (LPCM)], [MP4 (LPCM)] or [MP4])

After you have touched a recording format option, one of the following icons will be displayed on each thumbnail. The icon to be displayed differs depending on the size of recording format.

– Scenes recorded in C4K (4096×2160):

– Scenes recorded in 4K (3840×2160):

– Scenes recorded in FHD (1920×1080):

- (If you have touched the recording mode option [AVCHD])

After you have touched a recording format option, one of the following icons will be displayed on each thumbnail.

– Scenes recorded in [PS 1080/60p]/[PS 1080/50p]:

– Scenes recorded in [PH 1080/60i]/[PH 1080/50i]:

– Scenes recorded in [HA 1080/60i]/[HA 1080/50i]:

– Scenes recorded in [HE 1080/60i]/[HE 1080/50i]:

– Scenes recorded in [PM 720/60p]/[PM 720/50p]:

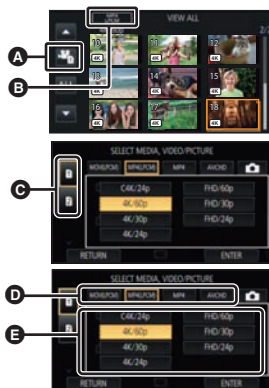

(To set this unit to Still Picture Playback Mode)
Touch the still picture **F**.

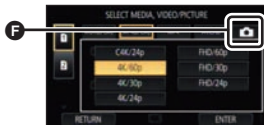

5 Touch the scene or the still picture to be played back.

- Next (Previous) page can be displayed by touching **▲** / **▼**.

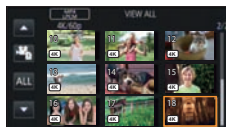

6 Select the playback operation by touching the operation icon.

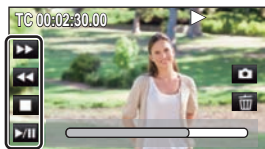

G Operation icon

- If you touch the screen while an operation icon is being displayed or do not touch the icon for a certain period, it will disappear. To display again, touch the screen.

Watching Video/Pictures on your TV

Connect this unit to a TV using an HDMI cable (supplied) or an AV cable (commercially-available).

- 1 HDMI connector
 - 2 Video output connector
 - 3 Audio output connector
- Do not use any other HDMI cables except the supplied one.

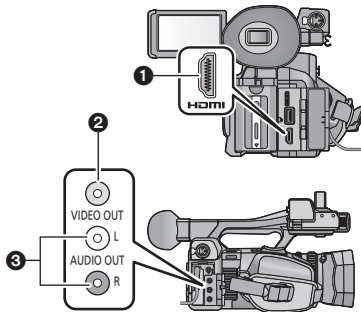

Wi-Fi[®] function

To provide a Wi-Fi connection example, these basic owner's manual describe the procedures from setting up a direct connection between this unit and a smartphone to getting them ready for remote operation.

- Please refer to the owner's manual (PDF format) of this unit for details about the setting/operating of this unit.
- Please refer to the operating instructions of the device in use for details about the setting/operating of the wireless access point or smartphone.

■ This unit is NFC-compatible



Using the NFC (Near Field Communication) function, you can easily transfer data necessary for a Wi-Fi connection between this unit and the smartphone.

This function can be used with the NFC compatible device with Android™ (OS version 2.3.3 or later). (Except for some models)

Install the “Image App”

About the “Image App”

The “Image App” is an application provided by Panasonic.

	For Android apps	For iOS apps
OS	Android 2.3.3 or later*	iOS 6.0 or later* (iPhone 3GS is not supported.)
Installation procedure	<ol style="list-style-type: none"> 1 Connect your Android device to a network. 2 Select “Google Play™ Store”. 3 Enter “Panasonic Image App” into the search box. 4 Select “Panasonic Image App” and install it. <ul style="list-style-type: none"> • The icon will be added to the menu. 	<ol style="list-style-type: none"> 1 Connect your iOS device to a network. 2 Select “App StoreSM”. 3 Enter “Panasonic Image App” into the search box. 4 Select “Panasonic Image App” and install it. <ul style="list-style-type: none"> • The icon will be added to the menu. 

* The supported OS versions are current as of September 2014 and subject to change.

- Use the latest version.
- Refer to [Help] in the “Image App” menu about function of Image App.
- The service may not be able to be used properly depending on the type of smartphone being used. For information on the “Image App”, check the support website below.

http://panasonic.jp/support/global/cs/e_cam

(This Site is English only.)

- When downloading the app on a mobile network, high packet communication fees may be incurred depending on the details of your contract.

Using remote operation with a direct connection

■ Preparations before using remote operation

- 1 Install the smartphone application “Image App” on your smartphone. (→ 39)
- 2 Check if the smartphone is an Android (NFC-compatible), Android (non-NFC-compatible), or iOS device.
 - If your smartphone is NFC-compatible, a message asking you to touch the NFC mark on the device will be displayed when starting up the “Image App”.
- 3 Register [Wi-Fi] to a USER button. (→ 35)

■ If the device is Android (NFC-compatible)

- Set the NFC function of the smartphone to ON.

1 Start up the smartphone application “Image App”.

2 Touch the smartphone on  of this unit.

- Touch the NFC mark while a message asking you to touch the NFC mark on the device is displayed on the smartphone screen.
- If this is the first time the smartphone is connecting to this unit, touch [YES] on the screen of this unit, and then touch the smartphone on  of this unit again.
- If the unit is not recognized even when touching the smartphone, change positions and try again.
- When the connection is complete, the image of this unit will be displayed on the smartphone screen.

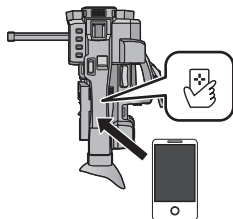

■ If the device is Android (non-NFC-compatible) or iOS

1 Press the USER button to which [Wi-Fi] is registered, and turn on the Wi-Fi function.

-  is displayed

2 Select the menu.

 : [Wi-Fi Setup] → [Direct Connection]

3 Touch [Change connection type].

4 Touch [QR code].

- QR code is displayed on the screen of this unit.

5 Start up the smartphone application “Image App”.

6 On the smartphone, select [QR code], and scan the QR code displayed on the screen of this unit.

- When using an Android device, the smartphone and this unit are connected directly, allowing you to use remote operations.

- When using an iOS device, perform the following operations:
 - 1 Select the option that allows you to install the app on the profile screen of the "Image App", and follow the on-screen instructions to complete the installation.
 - 2 Press the home button to close the displayed screen.
 - 3 After selecting the network name (SSID) of this unit from the Wi-Fi setup of the smartphone, start up the "Image App".
- When the connection is complete,  will be displayed on the screen of this unit, and the image of this unit will be displayed on the smartphone screen.

If the Wi-Fi connection cannot be established

- Please refer to the operating instruction of the device in use for details about the setting of the wireless access point or smartphone.

Problem	Check points
The Wi-Fi connection is not possible between this unit and a smartphone.	<ul style="list-style-type: none"> • Make sure the smartphone is properly connected to this unit by checking the Wi-Fi settings of the smartphone. • Make sure the smartphone is not connected to the wireless access point. If it is connected to the wireless access point, change the Wi-Fi access point using the smartphone's Wi-Fi set up.
It takes long time every time to connect to a smartphone.	<ul style="list-style-type: none"> • It may take longer time to connect depending on the Wi-Fi connection setting of the smartphone, but it is not a malfunction.
This unit is not displayed in the Wi-Fi setting screen of the smartphone.	<ul style="list-style-type: none"> • Try switching the on/off of the Wi-Fi function in the Wi-Fi settings of the smartphone.
The Wi-Fi connection is disconnected immediately.	<ul style="list-style-type: none"> • If there is a setting for avoiding poor connections in the Wi-Fi setting menu of the Android device 4.0 or later version, turn it off.
Cannot be connected using NFC.	<ul style="list-style-type: none"> • Make sure your smartphone is compatible with NFC. This unit can be used with NFC-compatible terminals via Android (OS version 2.3.3 or later). • Make sure the NFC function of your smartphone is on. • Make sure this unit is not turned off with the power switch. • Some smartphones cannot be easily checked simply by touching. If this unit is not recognized even after touching, change positions and try again by touching slowly. • Touch again if it does not connect after touch. If a connection still cannot be established, close the Image App, turn off this unit, and try establishing a connection again. • If the amount of time this unit is in contact with the smartphone is too short, this unit may not recognise the smartphone. Touch and hold the smartphone.

Troubleshooting

■ It is not a malfunction in following cases

The lens, the viewfinder or LCD monitor fog up.	<ul style="list-style-type: none"> ● This is due to condensation. It is not a malfunction. Please refer to page 9.
Object seems to be warped.	<ul style="list-style-type: none"> ● Object seems to be warped slightly when the object moves across the image very fast, but this is because the unit is using MOS for the image sensor. This is not a malfunction.

Problem	Check points
<p>This unit cannot be turned on.</p> <p>This unit does not stay on long enough.</p> <p>Battery runs down quickly.</p>	<ul style="list-style-type: none"> ● Charge the battery again to ensure it is sufficiently charged. (→ 20) ● In cold places, the battery using time becomes shorter. ● The battery has a limited life. If the operating time is still too short even after the battery is fully charged, the battery has worn out and needs to be replaced.
<p>This unit cannot be operated though it is turned on.</p> <p>This unit does not operate normally.</p>	<ul style="list-style-type: none"> ● Remove the battery or AC adaptor, wait about 1 minute and then reconnect the battery or AC adaptor. Then about 1 minute later, turn on the unit again. (Conducting the above operation while the media is being accessed may damage the data on the media.) ● If normal operation is still not restored, detach the power connected, and consult the dealer who you purchased this unit from.
The unit arbitrarily stops recording.	<ul style="list-style-type: none"> ● Use an SD card that can be used for motion picture recording. (→ 23) ● The recordable time may have shortened due to the deterioration of the data writing speed or repeated recording and deletion. Using the unit, format the SD card. (→ 29)
<p>Color or brightness of the image changes, or you may see horizontal bars in the image.</p> <p>The LCD monitor flickers indoors.</p>	<ul style="list-style-type: none"> ● Color or brightness of the image may change, or you may see horizontal bars in the image when the object is recorded under fluorescent light, mercury light or sodium light, etc., but this is not a malfunction. ● Record images in Intelligent Auto Mode or adjust the shutter speed to 1/50, 1/60 or 1/100. ● Adjust the Synchro Scan shutter speed.

Please refer to “Owner’s Manual (PDF format)” for details.

About copyright

■ Carefully observe copyright laws

Whatever you have recorded and created can be used for your personal entertainment only. Under copyright laws, other materials cannot be used without obtaining permission from the holders of the copyrights.

■ Licenses

- SDXC Logo is a trademark of SD-3C, LLC.
- "AVCHD", "AVCHD Progressive" and the "AVCHD Progressive" logo are trademarks of Panasonic Corporation and Sony Corporation.
- Manufactured under license from Dolby Laboratories. Dolby and the double-D symbol are trademarks of Dolby Laboratories.
- HDMI, the HDMI Logo, and High-Definition Multimedia Interface are trademarks or registered trademarks of HDMI Licensing LLC in the United States and other countries.
- LEICA is a registered trademark of Leica Microsystems IR GmbH and DICOMAR is a registered trademark of Leica Camera AG.
- App Store is a service mark of Apple Inc.
- Android and Google Play are trademarks or registered trademarks of Google Inc.
- The Wi-Fi CERTIFIED™ Logo is a certification mark of Wi-Fi Alliance®.

- The Wi-Fi Protected Setup™ Identifier mark is a certification mark of Wi-Fi Alliance®.
- "Wi-Fi®" is a registered trademark of Wi-Fi Alliance®.
- "Wi-Fi Protected Setup™", "WPA™", and "WPA2™" are trademarks of Wi-Fi Alliance®.
- The N-Mark is a trademark or registered trademark of NFC Forum, Inc. in the United States and in other countries.
- QR Code is a registered trademark of DENSO WAVE INCORPORATED.
- Other names of systems and products mentioned in these instructions are usually the registered trademarks or trademarks of the manufacturers who developed the system or product concerned.

This product is licensed under the AVC patent portfolio license for the personal and non-commercial use of a consumer to (i) encode video in compliance with the AVC Standard ("AVC Video") and/or (ii) decode AVC Video that was encoded by a consumer engaged in a personal and non-commercial activity and/or was obtained from a video provider licensed to provide AVC Video. No license is granted or shall be implied for any other use. Additional information may be obtained from MPEG LA, LLC. See <http://www.mpegla.com>.

This product incorporates the following software:

- (1) the software developed independently by or for Panasonic Corporation,
- (2) the software owned by third party and licensed to Panasonic Corporation,
- (3) the software licensed under the GNU General Public License, Version 2.0 (GPL V2.0),
- (4) the software licensed under the GNU LESSER General Public License, Version 2.1 (LGPL V2.1), and/or
- (5) open source software other than the software licensed under the GPL V2.0 and/or LGPL V2.1.

The software categorized as (3) - (5) are distributed in the hope that it will be useful, but WITHOUT ANY WARRANTY, without even the implied warranty of MERCHANTABILITY or FITNESS FOR A PARTICULAR PURPOSE. For details, refer to the licence information described in the supplied leaflet "Open Source Software Information".

At least three (3) years from delivery of this product, Panasonic will give to any third party who contacts us at the contact information provided below, for a charge no more than our cost of physically performing source code distribution, a complete machine-readable copy of the corresponding source code covered under GPL V2.0 or LGPL V2.1, as well as the respective copyright notice thereof.

Contact Information: oss-cd-request@gg.jp.panasonic.com

The source code and the copyright notice are also available for free in our website below.
<http://panasonic.net/avc/oss/index.html>

Specification

4K Video Camera

Information for your safety

Power source:	DC 12 V (When using AC adaptor) DC 7.2 V (When using battery)
Power consumption:	15.4 W (When using the LCD monitor) 14.3 W (When using the viewfinder)

Recording format:

[MOV(LPCM)]/[MP4(LPCM)]/[MP4]/

AVCHD version 2.0

(AVCHD Progressive)

Motion picture compression:

MPEG-4 AVC/H.264

Audio compression:

[MOV(LPCM)]/[MP4(LPCM)]; Linear PCM

[MP4]; AAC

[AVCHD]; Dolby Digital

Recording mode and transfer rate:

[MOV(LPCM)];

(When [SYSTEM FREQ] set to [59.94Hz(NTSC)])

[FHD/60p ^{ALL-I}/_{200M}]/[FHD/30p ^{ALL-I}/_{200M}]/

[FHD/24p ^{ALL-I}/_{200M}]; Average 200 Mbps (VBR)

[FHD/60p 100M]; Average 100 Mbps (VBR)

[FHD/60p 50M]/[FHD/30p 50M]/

[FHD/24p 50M]; Average 50 Mbps (VBR)

(When [SYSTEM FREQ] set to [50Hz(PAL)])

[FHD/50p ^{ALL-I}/_{200M}]/[FHD/25p ^{ALL-I}/_{200M}];

Average 200 Mbps (VBR)

[FHD/50p 100M]; Average 100 Mbps (VBR)

[FHD/50p 50M]/[FHD/25p 50M];

Average 50 Mbps (VBR)

[MP4(LPCM)];

[C4K/24p 100M]; Average 100 Mbps (VBR)

(When [SYSTEM FREQ] set to [59.94Hz(NTSC)])

[4K/60p 150M]; Average 150 Mbps (VBR)

[4K/30p 100M]/[4K/24p 100M];

Average 100 Mbps (VBR)

[FHD/60p ^{ALL-I}/_{200M}]/[FHD/30p ^{ALL-I}/_{200M}]/

[FHD/24p ^{ALL-I}/_{200M}]; Average 200 Mbps (VBR)

[FHD/60p 100M]; Average 100 Mbps (VBR)

[FHD/60p 50M]/[FHD/30p 50M]/

[FHD/24p 50M]; Average 50 Mbps (VBR)

(When [SYSTEM FREQ] set to [50Hz(PAL)])

[4K/50p 150M]; Average 150 Mbps (VBR)

[4K/25p 100M]; Average 100 Mbps (VBR)

[FHD/50p ^{ALL-I}/_{200M}]/[FHD/25p ^{ALL-I}/_{200M}];

Average 200 Mbps (VBR)

[FHD/50p 100M]; Average 100 Mbps (VBR)

[FHD/50p 50M]/[FHD/25p 50M];

Average 50 Mbps (VBR)

[MP4];

(When [SYSTEM FREQ] set to [59.94Hz(NTSC)])

[4K/30p 100M]; Average 100 Mbps (VBR)

[FHD/60p 50M]; Average 50 Mbps (VBR)

(When [SYSTEM FREQ] set to [50Hz(PAL)])

[4K/25p 100M]; Average 100 Mbps (VBR)

[FHD/50p 50M]; Average 50 Mbps (VBR)

[AVCHD];

(When [SYSTEM FREQ] set to [59.94Hz(NTSC)])

[PS 1080/60p]; Maximum 28 Mbps (VBR)

[PH 1080/60i]; Maximum 24 Mbps (VBR)

[HA 1080/60i]; Average 17 Mbps (VBR)

[HE 1080/60i]; Average 5 Mbps (VBR)

[PM 720/60p]; Average 8 Mbps (VBR)

(When [SYSTEM FREQ] set to [50Hz(PAL)])

[PS 1080/50p]; Maximum 28 Mbps (VBR)

[PH 1080/50i]; Maximum 24 Mbps (VBR)

[HA 1080/50i]; Average 17 Mbps (VBR)

[HE 1080/50i]; Average 5 Mbps (VBR)

[PM 720/50p]; Average 8 Mbps (VBR)

Refer to the Owner's Manual (PDF format) for the picture size and recordable time of a motion picture.

Still picture recording format:

JPEG corresponding (Design rule for Camera File system, based on Exif 2.2 standard)

Refer to the Owner's Manual (PDF format) for picture size of a still picture and number of recordable pictures.

Recording media:

SDHC Memory Card/SDXC Memory Card;
UHS-I supported

Refer to page 23 for details on SD cards usable in this unit.

Image sensor:

1/2.3" MOS image sensor

Total; Approx. 18910 K

Effective pixels;

Motion picture/Still picture;

Approx. 8290K (16:9/3840×2160),

Approx. 8850K (17:9/4096×2160)

Lens:

Auto Iris optical zoom (Full range AF)
IR ON/OFF (Infrared recording supported)
F value (focal length)

F1.8 to F3.6 (Focal length; 4.08 mm to
81.6 mm)

35 mm equivalent;

Motion picture/Still picture;

30.8 mm to 626.0 mm (16:9/3840×2160)/

29.5 mm to 600.0 mm (17:9/4096×2160)

Minimum focus distance;

Approx. 3.0 cm (1.2") (Wide)/

Approx. 1.5 m (4.9 feet) (Tele)

Filter diameter:

49 mm

ND Filter:

OFF, 1/4, 1/16, 1/64

Zoom:

20× optical zoom, 40× i.Zoom^{*1},

2×/5×/10× digital zoom

*1 When the picture size of

[REC FORMAT] is 1920×1080 or
below

Image stabilizer function:

When the picture size of [REC FORMAT] is
1920×1080 or below:

Optical (with 5-Axis Hybrid O.I.S.)

When [REC FORMAT] is set to a setting with
a size of C4K (4096×2160) or 4K
(3840×2160):

Optical (with Power O.I.S.)

Monitor:

3.5" wide LCD monitor

(Approx. 1152 K dots)

Viewfinder:

0.45" wide EVF

(Approx. 1226 K dots equivalent)

Microphone:

Stereo microphone

Minimum required illumination:

Approx. 4 lx (1/30 with super gain 30 dB)

In Infrared recording;

Approx. 0 lx

Video output:**HDMI Type A connector video output level;**

HDMI™ 2160p/1080p/1080i/720p/576p/480p

AV connector video output level;

1.0 Vp-p, 75 Ω

Audio output:**HDMI Type A connector audio output level;**

Linear PCM

AV connector audio output level (Line);

2 ch

Headphone output;

3.5 mm stereo mini jack

Camera remote terminal:

2.5 mm super mini jack ×1 (ZOOM S/S)

3.5 mm mini jack ×1 (FOCUS/IRIS)

XLR audio input terminals:

XLR (3 pin) ×2 (INPUT1/INPUT2)

LINE; 0 dBu/+4 dBu/ (switch with the menu)

MIC; -40 dBu/-50 dBu/-60 dBu (switch with
the menu)

USB:

Super Speed USB (USB 3.0),

[DEVICE]; USB terminal Type Micro B, Reader
function (No copyright protection support),

[HOST]; USB terminal Type A, USB host
function (for USB HDD^{*2}), bus power
supported

*2 USB HDDs with a capacity of 32 GB or
below or a capacity above 2 TB cannot
be used

Dimensions:

160 mm (W)×170 mm (H)×315 mm (D)

[6.30" (W)×6.69" (H)×12.4" (D)]

(including projecting parts and eye cup)

Mass (Weight):

Approx. 1550 g (Approx. 3.42 lbs.)
[without battery (supplied) and an SD card
(optional)]

Mass (Weight) in operation:

Approx. 1780 g (Approx. 3.92 lbs.)
[with battery (supplied) and an SD card
(optional)]

Operating temperature:

0 °C to 40 °C (32 °F to 104 °F)

Operating humidity:

10%RH to 80%RH

Battery operation time:

See page 21

Wireless transmitter:

Compliance standard; IEEE802.11b/g/n
Frequency range used;
Central frequency 2412 MHz to 2462 MHz [11ch]
Encryption method; Wi-Fi compliant WPA™/
WPA2™/WEP
Access method; Infrastructure mode

NFC:

Compliance standard; ISO/IEC 18092 NFC-F
(Passive Mode)

AC adaptor

Information for your safety

Power source:	AC 110 V to 240 V, 50/60 Hz
----------------------	--------------------------------

Power consumption:	42 W
DC output:	DC 12 V, 2.5 A

Dimensions:

115 mm (W)×37 mm (H)×57 mm (D)
[4.53 " (W)×1.46 " (H)×2.24 " (D)]

Mass (Weight):

Approx. 210 g (Approx. 0.46 lbs.)

Battery charger

Information for your safety

Power source:	AC 100 V to 240 V, 50/60 Hz
----------------------	--------------------------------

Power consumption:	0.4 A
DC output:	DC 8.4 V, 1.2 A

Dimensions:





70 mm (W)×44.5 mm (H)×116 mm (D)
[2.76 " (W)×1.75 " (H)×4.57 " (D)]

Mass (Weight):

Approx. 160 g (Approx. 0.35 lbs.)

Optional accessories

Some optional accessories may not be available in some countries.

Accessory No.	Figure	Description
AG-MC200G		Unidirectional microphone
AG-B23		Battery charger
VW-VBD58*		Rechargeable Lithium Ion Battery Pack
VW-LED1PP		LED Video Light

* Please refer to page 21, concerning the battery charging time and available recording time.

NOTE:

Accessories and/or model numbers may vary by country. Please consult your local dealer. Product numbers correct as of Sep. 2014. These may be subject to change.

Accessory Order Form (For USA Customers)

Please photocopy this form when placing an order.

1. Model # _____

2. Items Ordered

Accessory #	Description	Price Each	Quantity	Total Price

Shipping & Handling \$6.95

Subtotal

Your State & Local Sales Tax

Total

3. Method of payment (check one)

American Express

VISA Credit Card # _____

MasterCard Expiration Date _____

Discover Customer Signature _____

(Please do not send cash)

4. Shipping information (UPS delivery requires complete street address)

Ship To:

Mr.

Mrs.

Ms.

First Last

Phone#:

Day () _____

Street Address

Night () _____

City State Zip

TO OBTAIN ANY OF OUR ACCESSORIES YOU CAN DO ANY OF
THE FOLLOWING:
VISIT YOUR LOCAL PANASONIC DEALER
OR
YOU MAY CONTACT US DIRECTLY AT: 1-800-237-9080 (FAX ONLY)
OR
MAIL THIS ORDER TO: PANASONIC NATIONAL PARTS CENTER
20421 84th Avenue South, Kent, WA 98032

In CANADA, please contact your local Panasonic dealer for more information on Accessories.

Limited Warranty (ONLY FOR U.S.A.)

Panasonic Products Limited Warranty

Limited Warranty Coverage (For USA Only)

If your product does not work properly because of a defect in materials or workmanship, Panasonic Corporation of North America (referred to as "the warrantor") will, for the length of the period indicated on the chart below, which starts with the date of original purchase ("warranty period"), at its option either (a) repair your product with new or refurbished parts, (b) replace it with a new or a refurbished equivalent value product, or (c) refund your purchase price. The decision to repair, replace or refund will be made by the warrantor.

Product or Part Name	Parts	Labor
4K Video Camera	1 Year	90 Days
All included Accessories (Except Non-Rechargeable Batteries)	90 Days	Not Applicable
Only Non-Rechargeable Batteries	10 Days	Not Applicable

During the "Labor" warranty period there will be no charge for labor. During the "Parts" warranty period, there will be no charge for parts. This Limited Warranty excludes both parts and labor for non-rechargeable batteries, antennas, and cosmetic parts (cabinet). This warranty only applies to products purchased and serviced in the United States. This warranty is extended only to the original purchaser of a new product which was not sold "as is".

Mail-In Service--Online Repair Request

Online Repair Request

To submit a new repair request and for quick repair status visit our Web Site at www.panasonic.com/repair.

When shipping the unit, carefully pack, include all supplied accessories listed in the Owner's Manual, and send it prepaid, adequately insured and packed well in a carton box. When shipping Lithium Ion batteries please visit our Web Site at www.panasonic.com/BatteryHandling as Panasonic is committed to providing the most up to date information. Include a letter detailing the complaint, a return address and provide a daytime phone number where you can be reached. A valid registered receipt is required under the Limited Warranty.

IF REPAIR IS NEEDED DURING THE WARRANTY PERIOD, THE PURCHASER WILL BE REQUIRED TO FURNISH A SALES RECEIPT/PROOF OF PURCHASE INDICATING DATE OF PURCHASE, AMOUNT PAID AND PLACE OF PURCHASE. CUSTOMER WILL BE CHARGED FOR THE REPAIR OF ANY UNIT RECEIVED WITHOUT SUCH PROOF OF PURCHASE.

Limited Warranty Limits And Exclusions

This warranty ONLY COVERS failures due to defects in materials or workmanship, and DOES NOT COVER normal wear and tear or cosmetic damage. The warranty ALSO DOES NOT COVER damages which occurred in shipment, or failures which are caused by products not supplied by the warrantor, or failures which result from accidents, misuse, abuse, neglect, mishandling, misapplication, alteration, faulty installation, set-up adjustments, misadjustment of consumer controls, improper maintenance, power line surge, lightning damage, modification, introduction of sand, humidity or liquids, commercial use such as hotel, office, restaurant, or other business or rental use of the product, or service by anyone other than a Factory Service Center or other Authorized Servicer, or damage that is attributable to acts of God.

THERE ARE NO EXPRESS WARRANTIES EXCEPT AS LISTED UNDER "LIMITED WARRANTY COVERAGE".

THE WARRANTOR IS NOT LIABLE FOR INCIDENTAL OR CONSEQUENTIAL DAMAGES RESULTING FROM THE USE OF THIS PRODUCT, OR ARISING OUT OF ANY BREACH OF THIS WARRANTY.

(As examples, this excludes damages for lost time, travel to and from the servicer, loss of or damage to media or images, data or other memory or recorded content. The items listed are not exclusive, but for illustration only.)

ALL EXPRESS AND IMPLIED WARRANTIES, INCLUDING THE WARRANTY OF MERCHANTABILITY, ARE LIMITED TO THE PERIOD OF THE LIMITED WARRANTY.

Some states do not allow the exclusion or limitation of incidental or consequential damages, or limitations on how long an implied warranty lasts, so the exclusions may not apply to you.

This warranty gives you specific legal rights and you may also have other rights which vary from state to state. If a problem with this product develops during or after the warranty period, you may contact your dealer or Service Center. If the problem is not handled to your satisfaction, then write to the warrantor's Consumer Affairs Department at the addresses listed for the warrantor.

PARTS AND SERVICE, WHICH ARE NOT COVERED BY THIS LIMITED WARRANTY, ARE YOUR RESPONSIBILITY.

Customer Services Directory (United States)

Obtain Product Information and Operating Assistance; locate your nearest Dealer or Service Center; purchase Parts and Accessories; or make Customer Service and Literature requests by visiting our Web Site at:

<http://www.panasonic.com/support>

or, contact us via the web at:

<http://www.panasonic.com/contactinfo>

For hearing or speech impaired TTY users, TTY: 1-877-833-8855

Accessory Purchases (United States)

Purchase Parts, Accessories and Owner's Manual online for all Panasonic Products by visiting our Web Site at:

<http://www.pstc.panasonic.com>

Or, send your request by E-mail to:

npcparts@us.panasonic.com

You may also contact us directly at:

1-800-237-9080 (Fax Only)

(Monday-Friday 9am-9pm EST)

Panasonic National Parts Center

20421 84th Avenue South, Kent, WA 98032

(We accept Visa, MasterCard, Discover Card, American Express)

For hearing or speech impaired TTY users, TTY: 1-866-605-1277

As of April 2014

Warranty (For Canadian Customers)

Panasonic Canada Inc.

5770 Ambler Drive, Mississauga, Ontario L4W 2T3

PANASONIC PRODUCT – LIMITED WARRANTY

Panasonic Canada Inc. warrants this product to be free from defects in material and workmanship under normal use and for a period as stated below from the date of original purchase agrees to, at its option either (a) repair your product with new or refurbished parts, (b) replace it with a new or a refurbished equivalent value product, or (c) refund your purchase price. The decision to repair, replace or refund will be made by Panasonic Canada Inc.

Camcorder Products - One (1) year, parts and labour

This warranty is given only to the original purchaser, or the person for whom it was purchased as a gift, of a Panasonic brand product mentioned above sold by an authorized Panasonic dealer in Canada and purchased and used in Canada, which product was not sold "as is", and which product was delivered to you in new condition in the original packaging.

IN ORDER TO BE ELIGIBLE TO RECEIVE WARRANTY SERVICE HEREUNDER, A PURCHASE RECEIPT OR OTHER PROOF OF DATE OF ORIGINAL PURCHASE, SHOWING AMOUNT PAID AND PLACE OF PURCHASE IS REQUIRED

LIMITATIONS AND EXCLUSIONS

This warranty **ONLY COVERS** failures due to defects in materials or workmanship, and **DOES NOT COVER** normal wear and tear or cosmetic damage. The warranty **ALSO DOES NOT COVER** damages which occurred in shipment, or failures which are caused by products not supplied by Panasonic Canada Inc., or failures which result from accidents, misuse, abuse, neglect, mishandling, misapplication, alteration, faulty installation, set-up adjustments, misadjustment of consumer controls, improper maintenance, improper batteries, power line surge, lightning damage, modification, introduction of sand, humidity or liquids, commercial use such as hotel, office, restaurant, or other business or rental use of the product, or service by anyone other than an Authorized Servicer, or damage that is attributable to acts of God.

Dry cell batteries are also excluded from coverage under this warranty. Rechargeable batteries are warranted for ninety (90) days from date of original purchase.

THIS EXPRESS, LIMITED WARRANTY IS IN LIEU OF ALL OTHER WARRANTIES, EXPRESS OR IMPLIED, INCLUDING ANY IMPLIED WARRANTIES OF MERCHANTABILITY AND FITNESS FOR A PARTICULAR PURPOSE. IN NO EVENT WILL PANASONIC CANADA INC. BE LIABLE FOR ANY SPECIAL, INDIRECT OR CONSEQUENTIAL DAMAGES RESULTING FROM THE USE OF THIS PRODUCT OR ARISING OUT OF ANY BREACH OF ANY EXPRESS OR IMPLIED WARRANTY. (As examples, this warranty excludes damages for lost time, travel to and from the Authorized Servicer, loss of or damage to media or images, data or other memory or recorded content. This list of items is not exhaustive, but for illustration only.)

In certain instances, some jurisdictions do not allow the exclusion or limitation of incidental or consequential damages, or the exclusion of implied warranties, so the above limitations and exclusions may not be applicable. This warranty gives you specific legal rights and you may have other rights which vary depending on your province or territory.

WARRANTY SERVICE

For product operation, repairs and information assistance, please visit our Support page:

www.panasonic.ca/english/support

IF YOU SHIP THE PRODUCT TO A SERVICENTRE

Carefully pack and send prepaid, adequately insured and preferably in the original carton.
Include details of the defect claimed, and proof of date of original purchase.

Useful Information (Only For Latin American Countries)

Customer Service

Customer Service Directory

Obtain product information and operative assistant; localize the closer distributor or Service Center; buy spare parts and accessories by our web site to Latin American:

<http://www.lar.panasonic.com>

Also you may contact us directly by our Contact Center:

Panama	800-PANA (800-7262)
Colombia	01-8000-94PANA (01-8000-947262)
Ecuador	1800-PANASONIC (1800-726276)
Costa Rica	800-PANA737 (800-7262737)
El Salvador	800-PANA (800-7262)
Guatemala	1-801-811-PANA (1-801-811-7262)
Chile	800-390-602 From a cell phone: 797-5000
Venezuela	800-PANA-800 (800-7262-800)
Uruguay	0-800-PANA (0-800-7262)
Peru	0-800-00-PAN(0-800-00726)
Argentina	0800-333-PANA (0800-333-7262) 0810-321-PANA (0810-321-7262)
Paraguay	0800-11-PANA (0800-11-7262)
Dominican Republic	809-200-8000

Mexico Service

To obtain information in the Republic of Mexico contact us at:

[email: atencion.clientes@mx.panasonic.com](mailto:atencion.clientes@mx.panasonic.com)

Or you may contact us in the next following phones numbers:

**01800-VIP-PANA (01800-847-7262) - Interior
(55) 5000-1200 - Mexico D.F. and Metropolitan Area**

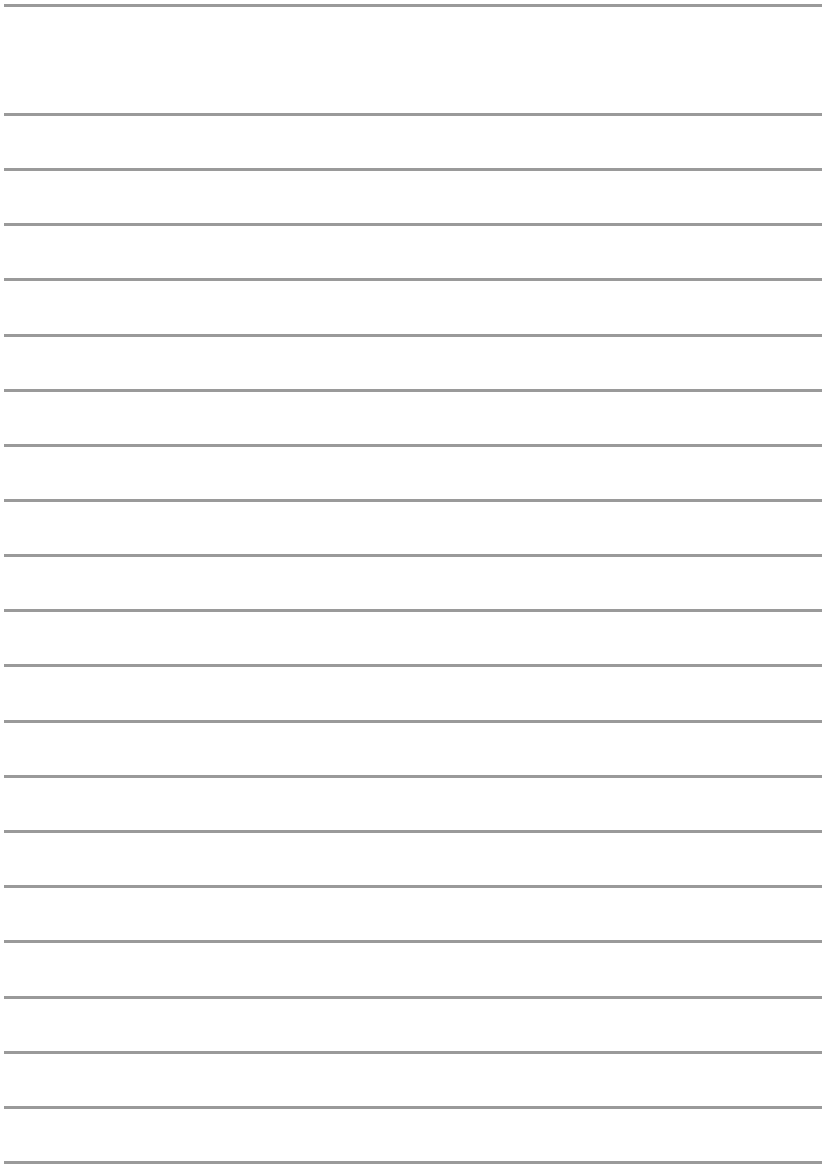

Panasonic Corporation

Web site: <http://www.panasonic.com>

Panasonic Corporation of North America

Two Riverfront Plaza, Newark, NJ 07102-5490

<http://www.panasonic.com>

Panasonic Canada Inc.

5770 Ambler Drive, Mississauga, Ontario, L4W 2T3

www.panasonic.com

© Panasonic Corporation 2014

Printed in Japan

SQT0477

F0914TC0