

ELMO

INSTRUCTION MANUAL

VISUAL PRESENTER P100HD

Please read this instruction manual carefully before using this product and keep it for future reference

IMPORTANT SAFEGUARDS

■ Read Instructions

All the safety and operating instructions should be read before the appliance is operated.

■ Retain Instructions

The safety and operating instructions should be retained for future reference.

■ Heed Warnings

All warnings on the product and in the operating instructions should be adhered to.

■ Follow Instructions

All operating and use instructions should be followed.

■ Cleaning

Unplug this product from the wall outlet before cleaning. Do not use liquid cleaners or aerosol cleaners. Use a damp cloth for cleaning.

■ Attachments

Do not use attachments not recommended by the product manufacturer as they may cause hazards.

■ Water and Moisture

Do not use this product near water - for example, near a bath tub, wash bowl, kitchen sink, or laundry tub, in a wet basement, or near a swimming pool, and the like.

■ Placement

Do not place this product on an unstable cart, stand, tripod, bracket, or table. The product may fall, causing serious injury to a child or adult, and serious damage to the product. Use only with a cart, stand, tripod, bracket, or table recommended by the manufacturer, or sold with the product. Any mounting of the product should follow the manufacturer's instructions, and should use a mounting accessory recommended by the manufacturer.

■ Ventilation

Slots and openings in the cabinet are provided for ventilation and to ensure reliable operation of the product and to protect it from overheating, and these openings must not be blocked or covered. The openings should never be blocked by placing the product on a bed, sofa, rug, or other similar surface. This product should not be placed in a built-in installation such as a bookcase or rack unless proper ventilation is provided or the manufacturer's instructions have been adhered to.

- **Power Sources**

This product should be operated only from the type of power source indicated on the marking label. If you are not sure of the type of power supply to your home consult your appliance dealer or local power company. For products intended to operate from battery power, or other sources, refer to the operating instructions.

- **Grounding or Polarization**

This product may be equipped with either a polarized 2-wire AC line plug (a plug having one blade wider than the other) or a 3-wire grounding type plug, a plug having a third (grounding) pin. The 2-wire polarized plug will outlet, try reversing the plug. If the plug still fails to fit, contact your electrician to replace your obsolete outlet. Do not defeat the safety purpose of the polarized plug. The 3-wire grounding type plug will fit into a grounding type power outlet. This is a safety feature. If you are unable to insert the plug into the outlet, contact your electrician to replace your obsolete outlet. Do not defeat the safety purpose of the grounding type plug.

- **Power-Cord Protection**

Power-supply cords should be routed so that they are not likely to be walked on or pinched by items placed upon or against them, paying particular attention to cords at plugs, convenience receptacles, and the point where they exit from the product.

- **Lightning**

For added protection for this product during a lightning storm, or when it is left unattended and unused for long periods of time, unplug it from the wall outlet and disconnect the antenna or cable system. This will prevent damage to the product due to lightning and power-line surges.

- **Overloading**

Do not overload wall outlets, extension cords, or integral convenience receptacles as this can result in a risk of fire or electric shock.

- **A product and cart combination should be moved with care. Quick stops, excessive force, and uneven surfaces may cause the product and cart combination to overturn.**



- **Object and Liquid Entry**

Never push objects of any kind into this product through openings as they may touch dangerous voltage points or short-out parts that could result in a fire or electric shock. Never spill liquid of any kind on the product.

- **Servicing**

Do not attempt to service this product yourself as opening or removing covers may expose you to dangerous voltage or other hazards. Refer all servicing to qualified service personnel.

■ Damage Requiring Service

Unplug this product from the wall outlet and refer servicing to qualified service personnel under the following conditions:

- When the power-supply cord or plug is damaged.
- If liquid has been spilled, or objects have fallen into the product.
- If the product has been exposed to rain or water.
- If the product does not operate normally by following the operating instructions. Adjust only those controls that are covered by the operating instructions as an improper adjustment of other controls may result in damage and will often require extensive work by a qualified technician to restore the product to its normal operation.
- If the product has been dropped or damaged in any way.
- When the product exhibits a distinct change in performance - this indicates a need for service.

■ Replacement Parts

When replacement parts are required, be sure the service technician has used replacement parts specified by the manufacturer or have the same characteristics as the original part. Unauthorized substitutions may result in fire, electric shock or other hazards.

■ Safety Check

Upon completion of any service or repairs to this product, ask the service technician to perform safety checks to determine that the product is in proper operating condition.

■ Heat

The product should be situated away from heat sources such as radiators, heat registers, stoves, or other products (including amplifiers) that produce heat.

- This product includes a Fluorescent Lamps component that contains mercury. Please consult your state and local regarding proper disposal or recycling, and do not place in the trash.

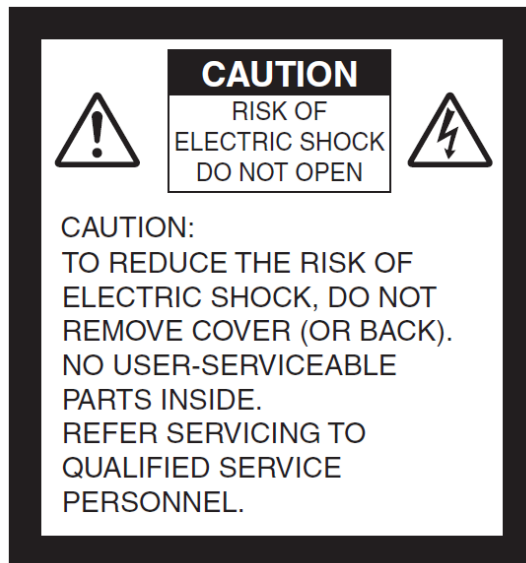

SA 1965

The lightning flash with arrowhead symbol, within an equilateral triangle, is intended to alert the user to the presence of uninsulated “dangerous voltage” within the product’s enclosure that may be of sufficient magnitude to constitute a risk of electric shock to persons.



SA 1966

The exclamation point within an equilateral triangle is intended to alert the user to the presence of important operating and maintenance (servicing) instructions in the literature

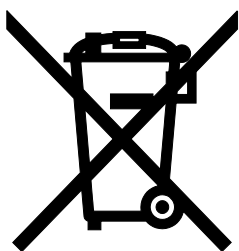

This symbol [crossed-out wheeled bin WEEE Annex IV] indicates separate collection of waste electrical and electronic equipment in the EU countries.

Please do not throw the equipment into the domestic refuse.

Please use the return and collection systems available in your country for the disposal of this product.

WARNING:

TO REDUCE THE RISK OF FIRE OR ELECTRIC SHOCK, DO NOT EXPOSE THIS PRODUCT TO RAIN OR MOISTURE.

The connection of a non-shielded equipment interface cable to this equipment will invalidate the FCC Certification or Declaration of this device and may cause interference levels which exceed the limits established by the FCC for this equipment. It is the responsibility of the user to obtain and use a shielded equipment interface cable with this device. If this equipment has more than one interface connector, do not leave cables connected to unused interfaces. Changes or modifications not expressly approved by the manufacturer could void the user's authority to operate the equipment.

FOR UNITED STATES USERS:

INFORMATION

This equipment has been tested and found to comply with the limits for a Class A digital device, pursuant to Part 15 of the FCC Rules. These limits are designed to provide reasonable protection against harmful interference when the equipment is operated in a commercial environment.

This equipment generates, uses, and can radiate radio frequency energy and, if not installed and used in accordance with the instruction manual, may cause harmful interference to radio communications. Operation of this equipment in a residential area is likely to cause harmful interference in which case the user will be required to correct the interference at his own expense.

USER-INSTALLER

CAUTION:

Your authority to operate this FCC verified equipment could be voided if you make changes or modifications not expressly approved by the party responsible for compliance to Part 15 of the FCC rules.

THIS IS A CLASS A PRODUCT. IN A DOMESTIC ENVIRONMENT THIS PRODUCT MAY CAUSE RADIO INTERFERENCE IN WHICH CASE THE USER MAY BE REQUIRED TO TAKE ADEQUATE MEASURES.

BEFORE YOU USE

- The power cord and AC adapter that come with this product are for this product only. Do not use them with another product.
- Be sure to use the power cord applicable to your local power specifications.
- When storing the product, do not leave it under direct sunlight or by heaters. It may become discolored, deformed, or damaged.
- Do not place this product in any humid, dusty, salt bearing wind, or vibrating locations.
 - Only use it under the following environmental conditions:
 - Temperature: 0°C - 40°C (32°F - 104°F)
 - Humidity: 30% - 85% (No condensation)
- Do not move the camera column or the lamp column while your finger is being placed between the camera column and the lamp column. Otherwise, your finger may be pinched and injured.
- In handling (including setting up and storing) or carrying the camera, be meticulously careful not to give an impact on the camera head.
- Use a soft, dry cloth for cleaning.
 - Do not use any volatile solvent such as thinner or benzene.
- Do not point the camera lens directly at the sun. It may be damaged and you may not be able to take pictures.
- Luminescent and Black Spots
 - There may be some pixels that do not properly operate due to the use of CMOS Area Image Sensors made-up of many pixels.
 - Though luminescent or black spots may be found on the screen, it is a phenomenon peculiar to the CMOS Area Image Sensors and is not a malfunction.
- To prevent damage during transport, a protection sheet has been put on the touch panel screen.
 - Please be sure to remove it before use.
 - Do not press the panel strongly by finger or sharp objects.
 - This can cause damage or malfunction.
- Follow the guidelines below to prevent the unit from dropping or overturning.
 - Use the product on a stable base, desk, or table. Do not place the product on an unstable base or slanted surface.
 - Place or wire the unit to prevent the AC adapter cord or video cable from pulling.
- Carry the product by holding the lower part of the main unit in both hands. Never hold the product by the column or the camera head.
- Pay careful attention when using (including setting-up and storing) or transferring the product to prevent the camera head from receiving any shocks.
- Do not look directly into the LED light. If you look directly into it at point-blank range, your eyes may be injured.
- Some type of SD card/USB flash drive can be used.

-
- Transfer the data from the SD card onto a device such as a PC to save a backup copy. Malfunction of the product or repairs to it may cause the data saved in the SD card to be deleted.
 - If this product is used for longer than the warranty period, its performance and quality may deteriorate due to the lifetime of its parts. To purchase replacement parts, consult the dealer from whom you purchased this product or our branch/office near your location.
 - Battery precautions:
 - If this product is not going to be used for a long time, take the batteries out of the remote control.
 - Do not use rechargeable batteries (e.g., Ni-Cd (NiCad batteries)).
 - Do not use new and old batteries or batteries of different types together.
 - Do not try to recharge or short-circuit the batteries.
 - When disposing of used batteries, follow the instructions of your local government.
 - Insert from one side and pay particular attention to the polarity (+/- directions).
 - Be sure to use AAA batteries.
 - If any liquid from a battery leaks onto your skin or clothes, flush the area with clean water immediately. If it gets into your eye, flush immediately with clean water and then contact a doctor.
 - Do not burn, disassemble, change nor dispose of in fire. Doing so damages the insulation materials which may cause heat generation, leakage, bursting or a fire.
 - Do not damage nor peel off the resin film on the surface of the battery.

■ About using microphones

Connecting microphones other than electret condenser microphones (microphones for PCs and so on) could cause a malfunction to occur. If you are concerned about this product's operating noise when using the built-in microphone, we recommend using an external microphone.

■ About the audio input port

Do not connect any audio line-output devices such as a CD/MP3 player to the audio input port when the Audio Selector is set to "Mic-in." Audio input is a dual purpose port (microphone/line-in) which supplies power when "Mic-in" is selected, adding external output devices (CD/MP3) may damage them.

■ About the MIC IN/ AUDIO OUT cable

Before connecting the cable with the product, attach the ferrite core that is supplied with the product to the cable as close to the connector of the product as possible.

(Example: Looping a cable through the ferrite core 2 times)

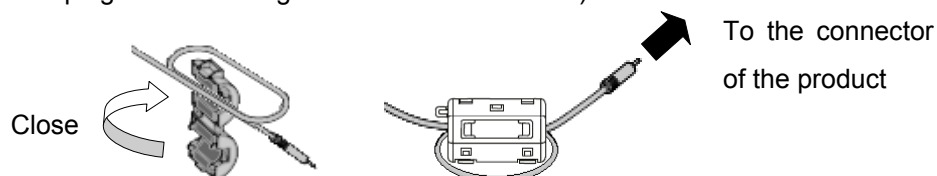

■ Menu / Icon

Some functions may not be set or operated depending on the mode or the menu / Icon settings being used.

■ Record/Play

- Before recording an important scene, make sure to do a test recording to confirm that the camera is working properly.
- The maximum file size of the continuous recording is 2GB. (The maximum recording length varies depending on other factors such as resolution and recording quality.)
- Movie files that are recorded with this camera or converted by the proprietary software can only be played with this camera.
- Pay attention to operation by the touch panel during recording the movie because a sound of operation may be recorded.

■ Network function

This function does not guarantee the normal operation when this camera system is connected directly to the Internet. Shut down any communication not routed via packet filter or the like in a router or the like.

■ Copyright

Do not commercially use or transfer movies or audio files recorded with the camera without the permission of the copyright holder except for personal use.

Do not use the camera in locations where recording movies or audio files are prohibited.

CONTENTS

IMPORTANT SAFEGUARDS	2
BEFORE YOU USE.....	7
CONTENTS.....	11
1 BUNDLED ITEMS.....	13
2 BASIC OPERATIONS	14
2-1 Document Camera	14
■ Part Names	14
■ Touch panel	15
■ Rear panel and cable connection	16
■ Side panel	20
■ Moving Parts of the Document Camera	21
2-2 Supplied Accessories	22
■ Remote Control.....	22
■ Remote Control Strap	23
■ Image Mate CD-ROM	23
■ Preparation	24
2-3 Shooting Images	27
■ Setting up the main unit.....	27
■ Turning the power ON/OFF	28
■ Operating the touch panel	29
■ Adjusting the size.....	31
■ Auto focus (AF)	31
■ Adjusting the brightness	32
■ Turning the illumination ON/OFF	34
■ Image selection.....	35
■ Details of Each Function.....	38
■ Icon descriptions	45
3 ADVANCED OPERATIONS.....	62
3-1 Using an SD card/USBflash drive	62
■ Saving images	64
■ Displaying the stored data	69
3-2 Outputting a different image to RGB OUT and HDMI OUT	78
3-3 Saving data stored on an SD card to PC via USB cable	79
3-4 Presentation using a USB-connected PC with the supplied software	81
3-5 Displaying the Video Image through Network Connection	83
3-6 Using [MIC IN] and [AUDIO IN].....	88
3-7 Using the ELMO Wireless Slate/Tablet (CRA-1) with the equipment.....	89
■ Connecting the ELMO Wireless Slate/Tablet (CRA-1)	89
■ Basic operations	90
■ Selecting how to use the pen tablet from the tablet menu	92

■ Writing to camera images	93
■ Using as a whiteboard	97
■ Using the SD card	99
3-8 Shooting off the stage	105
3-9 About RS-232C	106
4 TROUBLE SHOOTING	107
4-1 Symptoms and Confirmation	107
5 SPECIFICATIONS	111
5-1 General	111
5-2 Main Camera	112
5-3 Illumination Device	113
5-4 Trademarks and License	114

1

BUNDLED ITEMS

The items below are included with this product. If any item is missing, contact the dealer from whom you purchased this product.

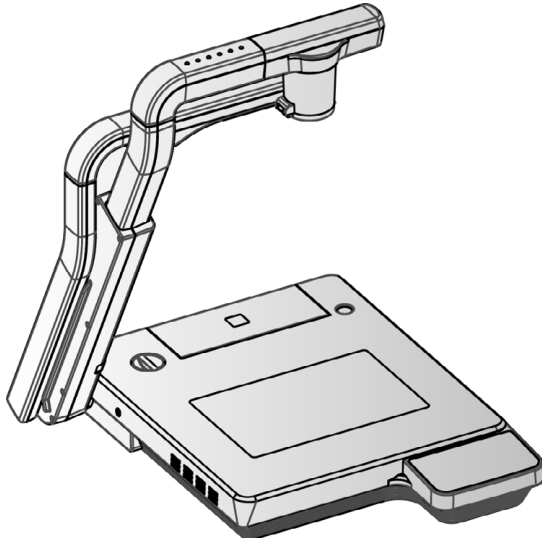

Document camera P21

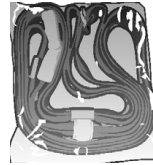

Strap (for Remote control) P23



Remote control P22

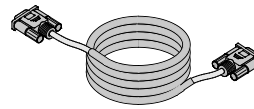

RGB cable P17

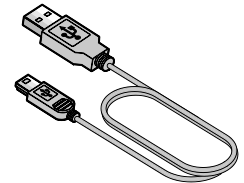

USB cable (for Connecting to PC) P18

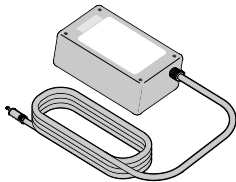

AC adapter P27

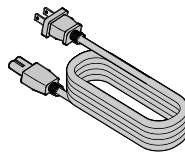

AC cord P27

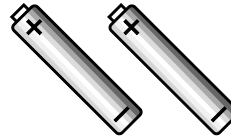

AAA batteries (for Remote control) P22

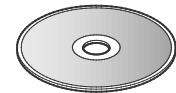
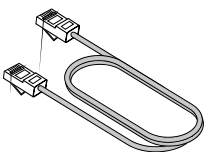

Image Mate/Instruction Manual CD-ROM P23



LAN cable P18



Ferrite core (for Mic IN / AUDIO OUT cable) P18 P20

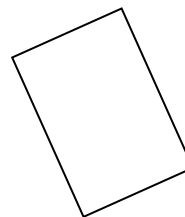

Warranty (US/JAPAN Only)

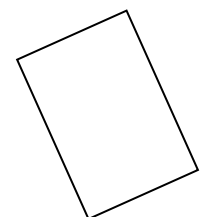

IMPORTANT SAFEGUARDS

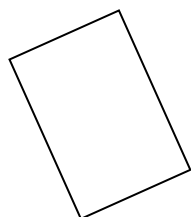



Image Mate Installation Manual

2





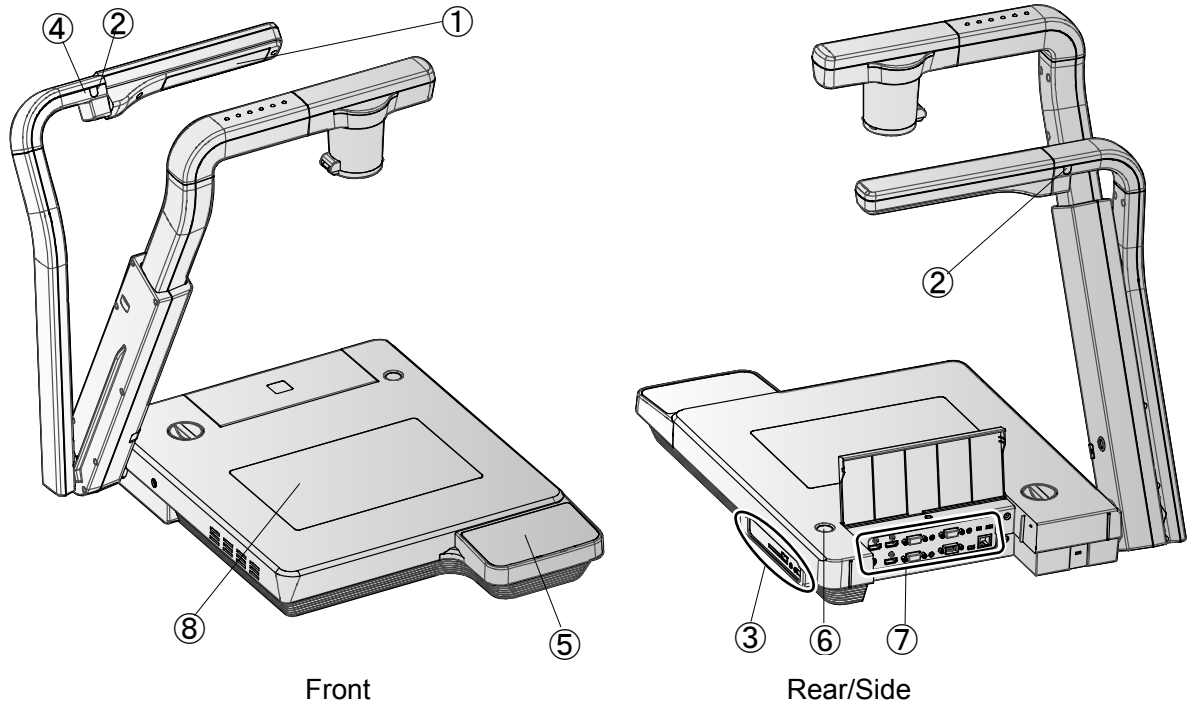

BASIC OPERATIONS

2-1 Document Camera

Part Names

Operation of the main unit:  P21



	Name	
①	Upper light	 P34
②	Remote control sensor	 P22
③	Side panel	 P20
④	Built-in mic	
⑤	Touch panel	 P29
⑥	Main switch	 P28
⑦	Rear panel	 P16
⑧	Base light	 P34

■ Touch panel

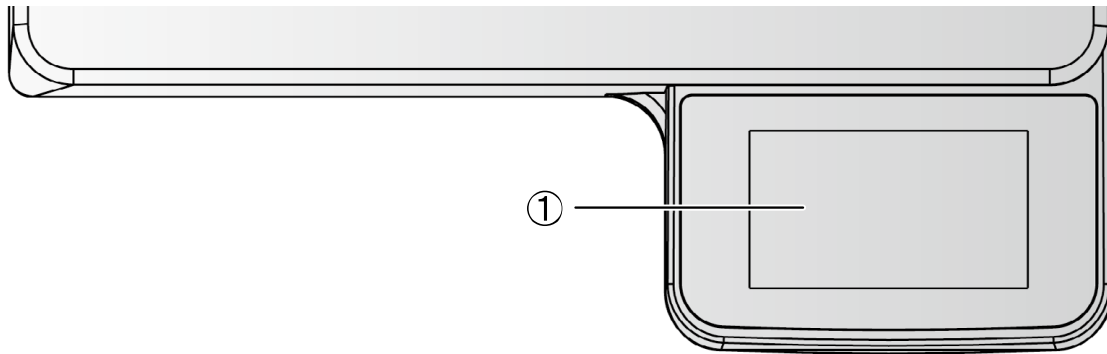

	Name	Function
①	Touch panel	Output image and icons are displayed. With these icons, various settings can be made.

P29

CAUTION

- Do not press the panel strongly by finger or sharp objects.
This can cause damage or malfunction.
- To prevent damage during transport, a protection sheet has been put on the touch panel screen. Please be sure to remove it before use.

The touch panel is made of glass. Pay attention to the followings to avoid glass breakage and injury.

- Do not rub or press the panel with a sharp object such as a knife.
- Do not press the panel strongly by finger or do not apply weight to the panel.
- Do not rub the panel with a hard object.
- Do not hit the panel with a hard object or do not drop it onto the panel.
- Do not put an object on the panel.
- Gently wipe the surface with a soft cloth to remove dirt.

Pay attention to the followings in order to maintain the performance of the touch panel.

- Do not stick adhesive tape on the panel.
- A protection sheet is attached to the surface of the touch panel to avoid scratches during transportation. Remove the sheet gently before use.

■ Rear panel and cable connection

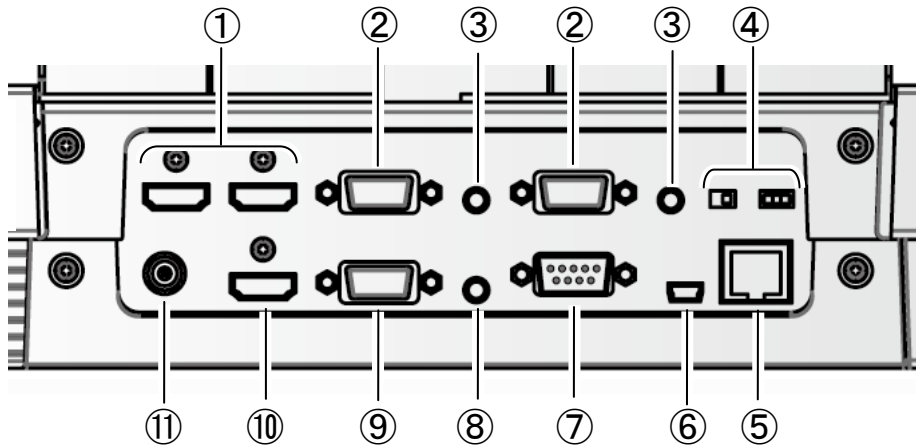

	Name	Function																		
①	HDMI IN 1 HDMI IN 2	To input HDMI images and audio. (HDMI cable is not supplied with the product.)																		
②	RGB IN 1 RGB IN 2	To input RGB image. (RGB cable is supplied with this product.) In the stand-by mode, the image input to the [RGB IN 1] terminal is output from the [RGB OUT] terminal.																		
③	AUDIO IN 1 AUDIO IN 2	To input audio line .(An audio cable is not supplied with this product.)																		
④	Resolution	To change the display resolution of output terminal. Select the display resolution with the switch. <table border="1" style="margin: 10px auto;"> <thead> <tr> <th>Resolution</th> <th>Left switch</th> <th>Right switch</th> </tr> </thead> <tbody> <tr> <td>1080P (1920 × 1080)</td> <td></td> <td></td> </tr> <tr> <td>720P (1280 × 720)</td> <td></td> <td></td> </tr> <tr> <td>SXGA (1280 × 1024)</td> <td></td> <td></td> </tr> <tr> <td>WXGA (1280 × 800)</td> <td></td> <td></td> </tr> <tr> <td>XGA (1024 × 768)</td> <td></td> <td></td> </tr> </tbody> </table>	Resolution	Left switch	Right switch	1080P (1920 × 1080)			720P (1280 × 720)			SXGA (1280 × 1024)			WXGA (1280 × 800)			XGA (1024 × 768)		
Resolution	Left switch	Right switch																		
1080P (1920 × 1080)																				
720P (1280 × 720)																				
SXGA (1280 × 1024)																				
WXGA (1280 × 800)																				
XGA (1024 × 768)																				
⑤	Ethernet terminal [100BASE/10BASE]	To enable the image transfer or the main unit control over the LAN. (LAN cable is supplied with this product.)																		

	Name	Function
⑥	USB	To connect to a PC. (USB cable is supplied with this product.)
⑦	RS-232C	To control the unit from a PC through an RS-232C cable. (RS-232C cable is not supplied with this product.)
⑧	AUDIO OUT	To output audio line. (Audio cable is not supplied with this product.)
⑨	RGB OUT	To output analog RGB images. (Analog RGB cable is supplied with this product.)
⑩	HDMI OUT	To output digital images. (HDMI cable is not supplied with this product.)
⑪	DC IN 12V	Plug-in for the AC adapter. (A cable is supplied with this product.)

① To connect the product to a device with an HDMI output terminal.

Connect a commercially available HDMI cable to the [HDMI IN] terminal on the rear panel.



Note

- Cable must conform to the HDMI standard.
- Elmo does not guarantee operation for all HDMI-compatible monitors.

② To connect the product to a device with an analog RGB output terminal.

Connect the RGB cable to the [RGB IN] terminal on the rear panel.

Only 1 RGB cable is supplied with the product.

■ Specifications of the [RGB IN] terminal

Signal allocation

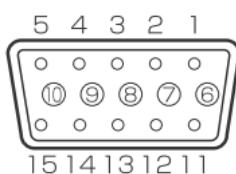

Video signal	Analog	0.7V (p-p) 75Ω terminated
Horizontal synchronized signal	TTL level	(Positive/negative polarity)
Vertical synchronized signal	TTL level	(Positive/negative polarity)

DSUB 15P shrink terminal

Pin No.	Name
1	Video signal (Red)
2	Video signal (Green)
3	Video signal (Blue)
4	N.C
5	GND

Pin No.	Name
6	GND (Red)
7	GND (Green)
8	GND (Blue)
9	N.C
10	GND

Pin No.	Name
11	GND
12	N.C
13	Horizontal synchronized signal
14	Vertical synchronized signal
15	N.C

③ To connect the unit to a device (audio amplifier etc) with an audio line output terminal.

Connect a commercially available audio cable to the [AUDIO IN] terminal on the rear panel.

④ To switch the output image type.

Change the output image type.

⑤ To connect the unit to a device with Ethernet terminal.

Connect the supplied LAN cable to the [Ethernet terminal] terminal on the rear panel.

Explanation of the Ethernet terminal LED

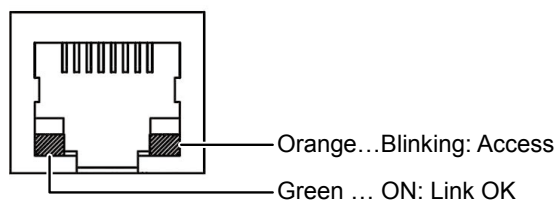

⑥ To connect a PC with the USB cable.

Connect the supplied USB cable to the [USB] terminal on the rear panel.

⑦ To connect the unit to a device with an RS-232C port.

The unit can be controlled from a PC through an RS-232C cable by using [RS-232C] terminal on the rear panel.

⑧ To connect the unit to a device (speaker with amplifier etc) with an audio line input terminal.

Connect a commercially available audio cable to the [AUDIO OUT] terminal on the rear panel after looping the audio cable 2 times around the ferrite core that is supplied with this product.

⑨ To connect the unit to a device with an analog RGB input terminal.

Connect the RGB cable to the [RGB OUT] terminal on the rear panel.

Only 1 RGB cable is supplied with the product.

⑩ To connect the unit to a device with an HDMI input terminal.

Connect a commercially available HDMI cable to the [HDMI OUT] terminal on the rear panel.



Note



- Please use the monitor corresponding to the input of the image (resolution) or 720p or more. It will not operate with a cable that doesn't conform to the HDMI standard.
- Elmo does not guarantee operation for all HDMI-compatible monitors.

⑪ To connect the AC adapter.

Before inserting the AC adapter in an outlet, connect the DC plug of the supplied AC adapter to the [DC IN 12V] terminal on the rear panel.





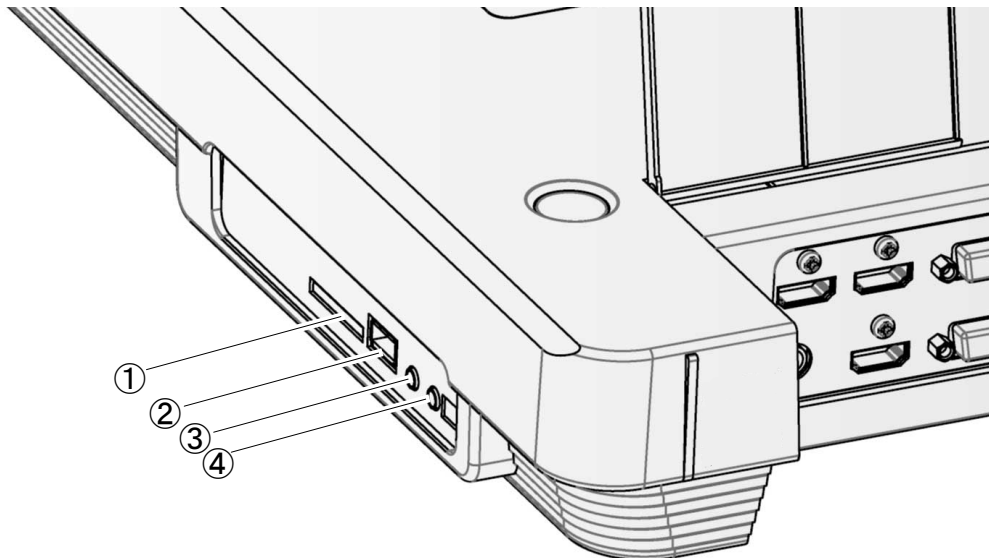

Note

- If the displayed image is off-center, adjustment of the horizontal and vertical position should be made from the connected device.
- In some cases, vertical stripes may appear on the display device. This can be reduced by adjusting the "clock phase" function of the connected device.
- When using a PC with external output mode switching, tap [ (Signal select)] > [] on the touch panel after setting the PC to the external output mode.
- When selecting the image in [Signal select (Normal)], output same image (resolution) to [RGB OUT] and [HDMI OUT].
- When the HDMI monitor is connected, the output image (resolution) is automatically changed based on information from the connected monitor. Even if [RGB OUT] is selected, it is not reflected.
- We recommend that you change the output image (resolution) with the power supply turned off (standby status).
We do not guarantee proper operation when the output image (resolution) was changed in any other condition than specified above.
- We recommend using a USB 2.0 compliant USB cable.
- If you plug into the USB cable with the power on, the PC may not recognize the device.
- Depending on the PC's USB environment or the peripheral equipment using the USB 2.0 compliant cable, image transfer may be disrupted.
- Operation is not guaranteed for all environments.

■ Side panel



	Mark	Function
①		To insert an SD card (commercially available). Push the card again to remove the SD card.
②		To connect a wireless pen Tablet (commercially available)  or a USB flash drive (commercially available). 
③	MIC IN	To connect an audio line-output device after looping the cable 3 times around the ferrite core that is supplied with this product. Audio input is a dual purpose port (microphone/line-in). When using a microphone, make sure to connect a commercially available electret condenser microphone.
④	MIC OUT	To output audio signal input to the “MIC IN” terminal. (An audio cable is not supplied with this product.)



Note

- Connecting microphones other than electret condenser microphones (microphones for PCs and so on) could cause a malfunction to occur.

■ Moving Parts of the Document Camera

This unit can be moved as shown below.

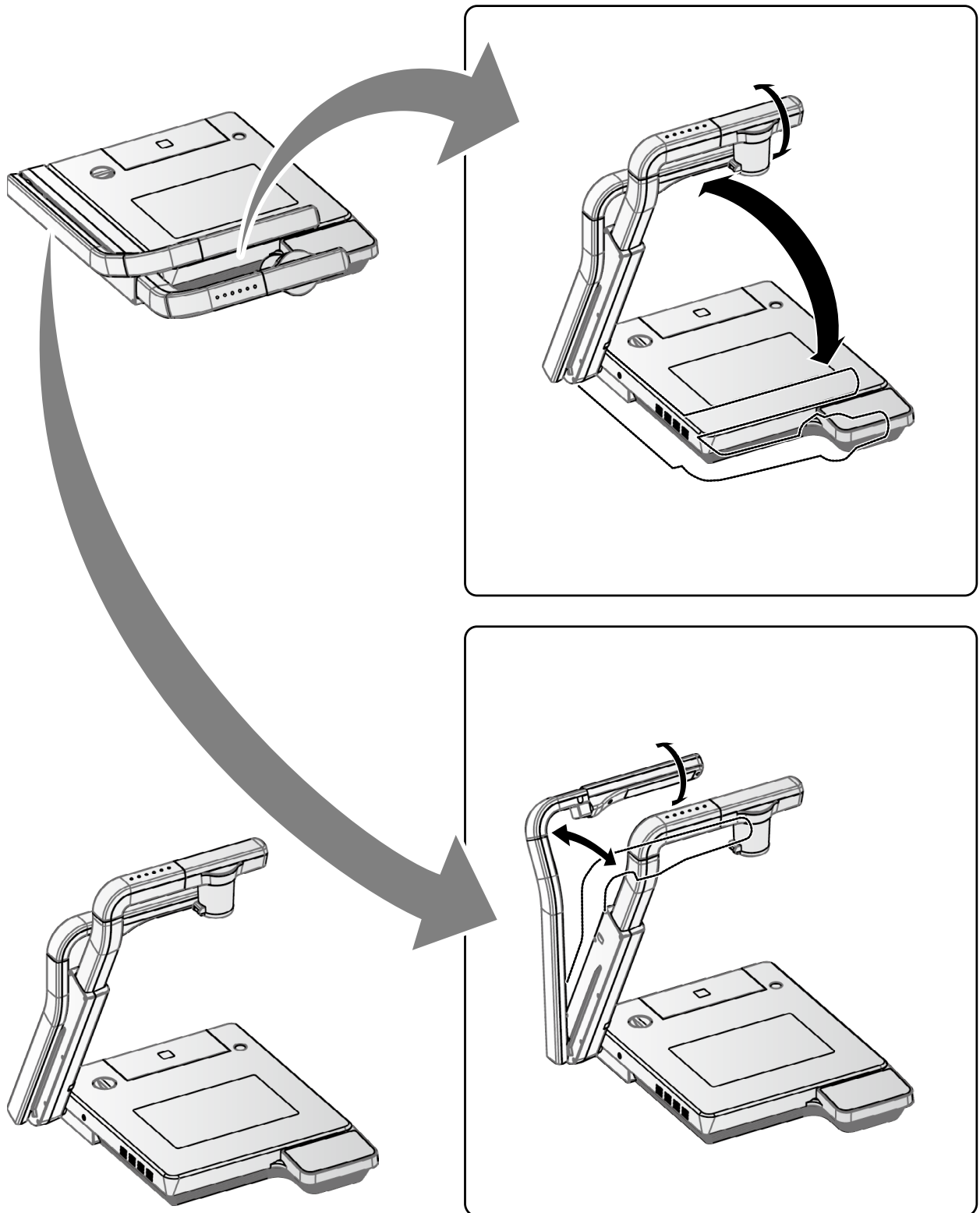

2-2 Supplied Accessories

■ Remote Control

Preparation of Remote Control

Remove the battery case cover at the back of the remote control and install 2 batteries. (TYPE AAA)

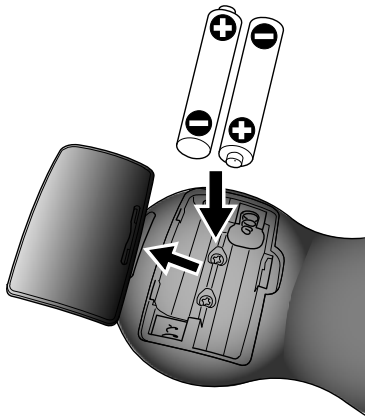

WARNING

Children may ingest small batteries: always keep batteries safe and out of reach.

If a battery is swallowed, consult a doctor immediately as this could result in asphyxiation or be an obstacle to digestion, etc.

Operation of the remote control

When a camera image is displayed

P31

When data in an SD card/USB flash drive is displayed

P62



Receiving signal from the remote control

Point the infrared light emitting part of the remote control at the infrared sensor, and press the button of the desired function.

Receivable range

Distance: Within approx. 7m from the front of the infrared sensor

Angle: Within 30° up, down, left, and right of the infrared sensor

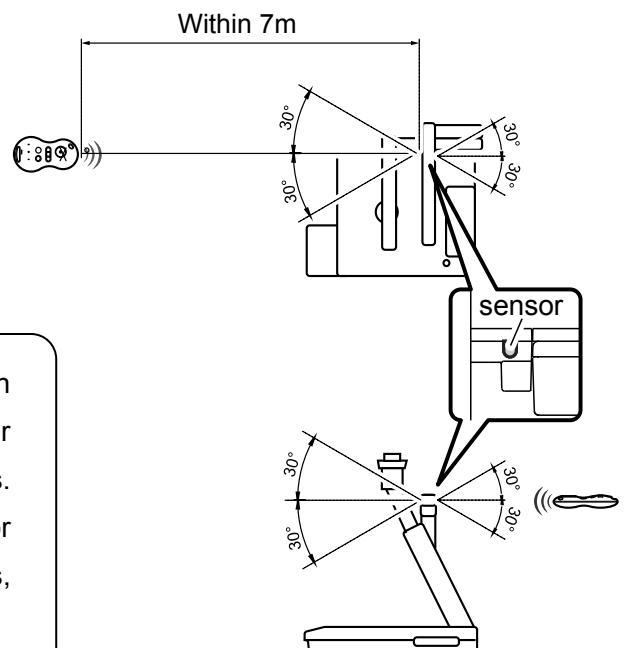

Note

The receivable range may be reduced when the main unit is placed in direct sunlight, near an inverter fluorescent light or in any other unfavorable conditions. Depending on the light source conditions, the sensor may fail to receive any infrared light. In such cases, relocate the main unit or shield the light source.

■ Remote Control Strap

The strap can be fastened to the remote control as shown below.

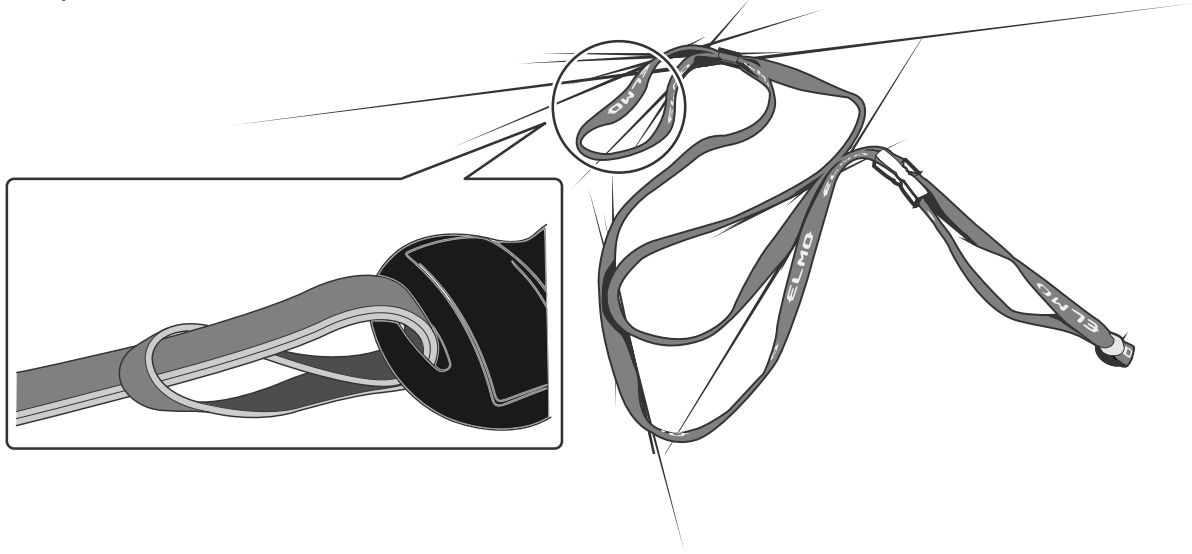

■ Image Mate CD-ROM

The CD-ROM contains the software for connecting to a PC and the Instruction Manual. For software installation, follow the instructions of the Image Mate Installation Manual.

■ Preparation

Setting Up

- ① Release the camera column lock by turning the security lock knob.

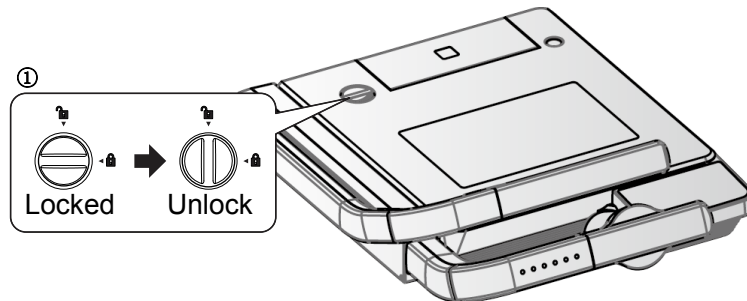

- ② As shown in the right figure, hold the setup grip and raise the camera column. At this time, the camera head slides up in conjunction with the rise of the camera column. The lamp column will also rise.

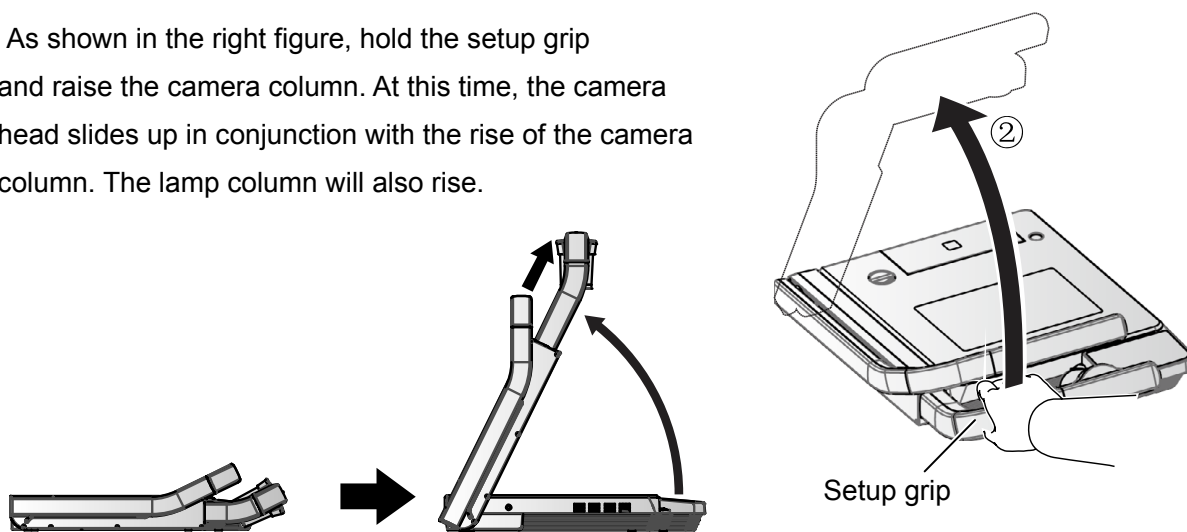

- ③ If necessary, move the lamp column and the lamp head to an appropriate position as shown in the right figure.

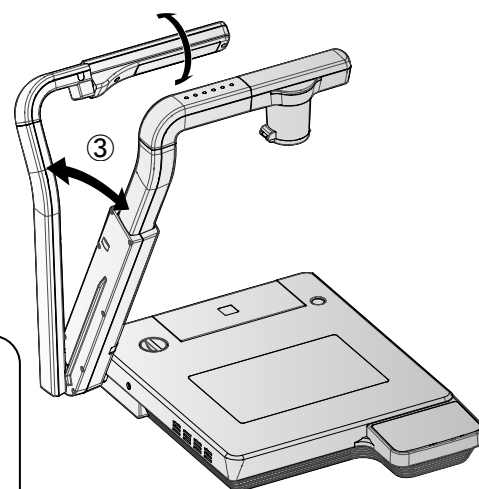

Note

When using a glossy paper, the document could reflect the illumination to disable normal display. In this case, adjust the lamp position to a position in which such reflection can be avoided.



Note

If the camera column is pulled or pushed forcedly, the camera might be pushed out of position, and the camera image might be displaced from the display center. In this case, initialize the camera position as follows:

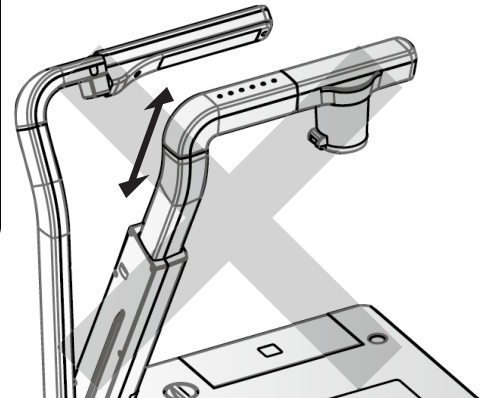

- (1) Fold the camera column on the stage. When the camera column is folded in the storage position, the camera position is initialized.

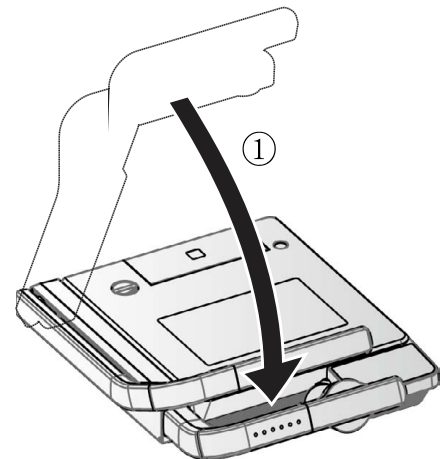

- (2) Then, raise the camera column.

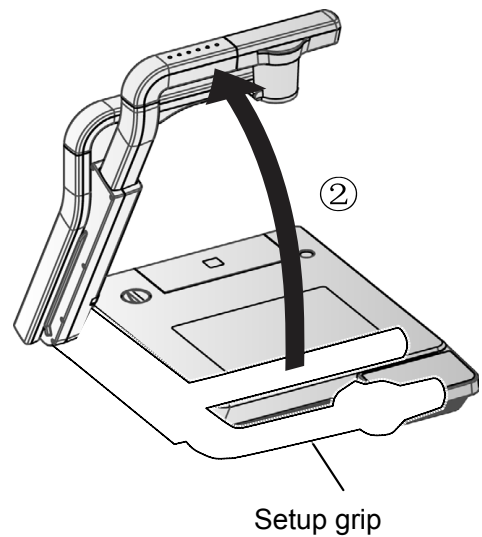

STORING

- ① Return the lamp to the original position. Then, hold the setup grip of the camera column and fold the camera column. At this time, the camera head slides down and the lamp column also folds.



Note

Turn OFF the power switch before the storing.

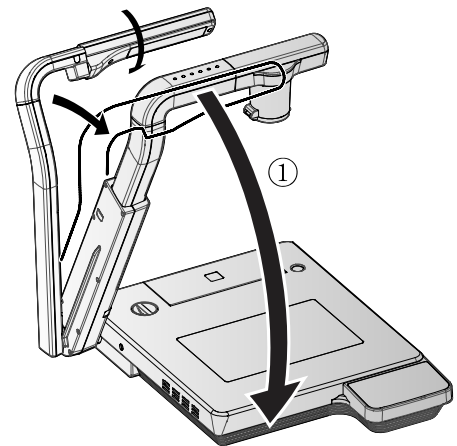

- ② Lock the camera column and the lamp column by turning the security lock.

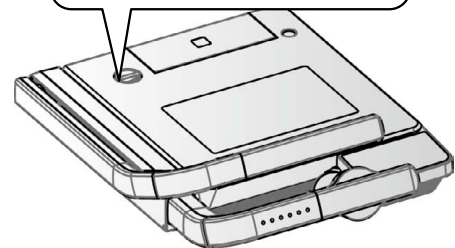
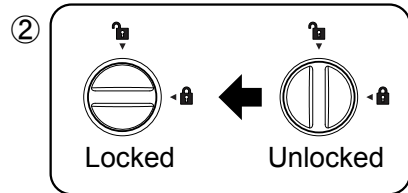

Note

Do not force down the camera column and the lamp column when folding them.



Note

Do not fold the camera column when the close-up lens holder remains open, or the close-up lens could be damaged.

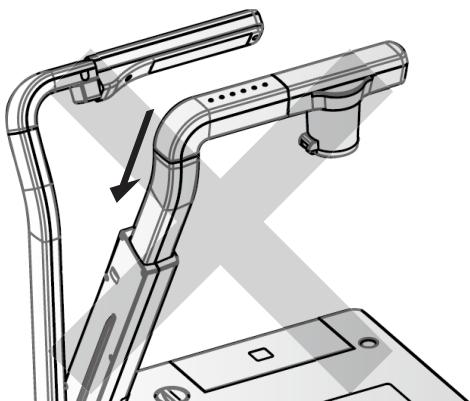

Note

When this camera system is not in use, unplug the power cord and the AC adapter from the plug socket.

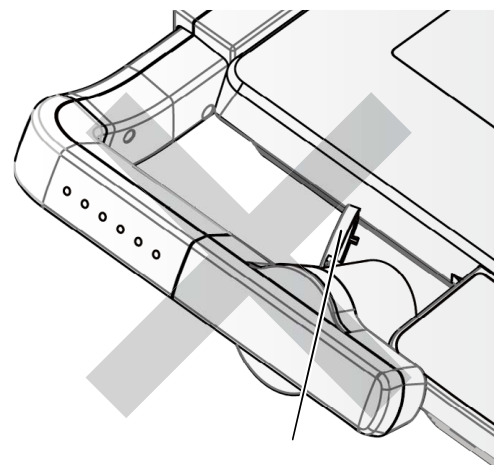

Close-up lens holder

2-3 Shooting Images

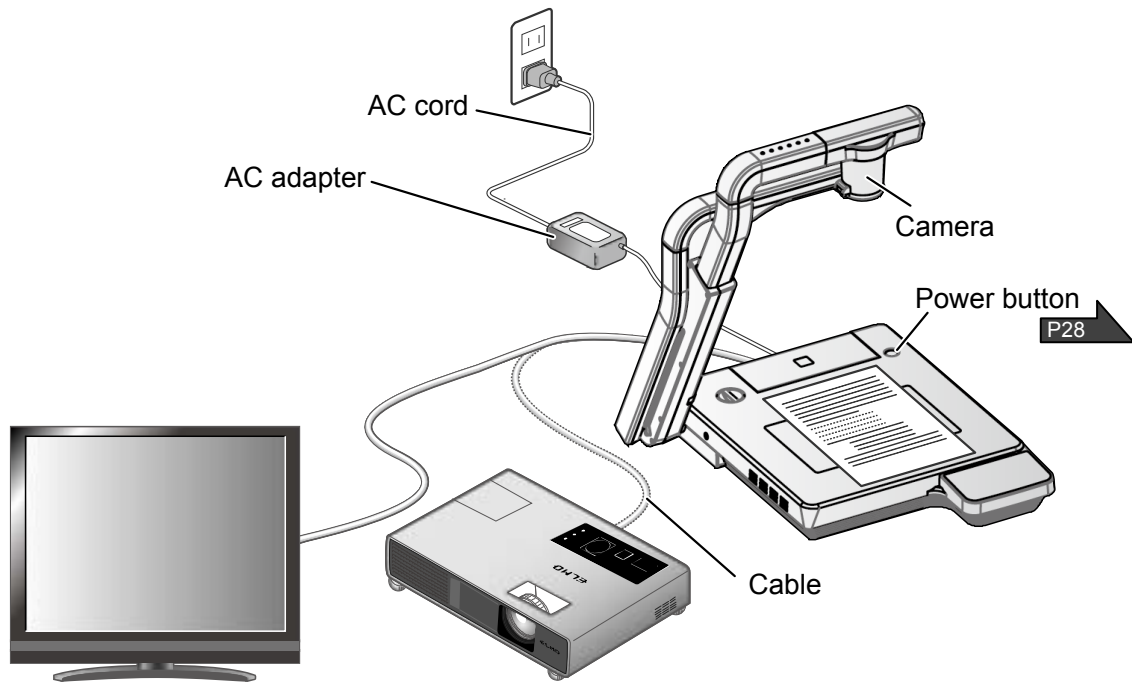

■ Setting up the main unit

Set up the main unit as shown in the figure above. Then connect the main unit to a projector or a PC monitor, and turn on the power of the main unit. **P28**

Connecting the AC cord

Connect the AC cord and the AC adapter. Then connect the AC adapter to the [DC IN 12V] terminal at the rear panel of the document camera, and insert the AC cord into an outlet.

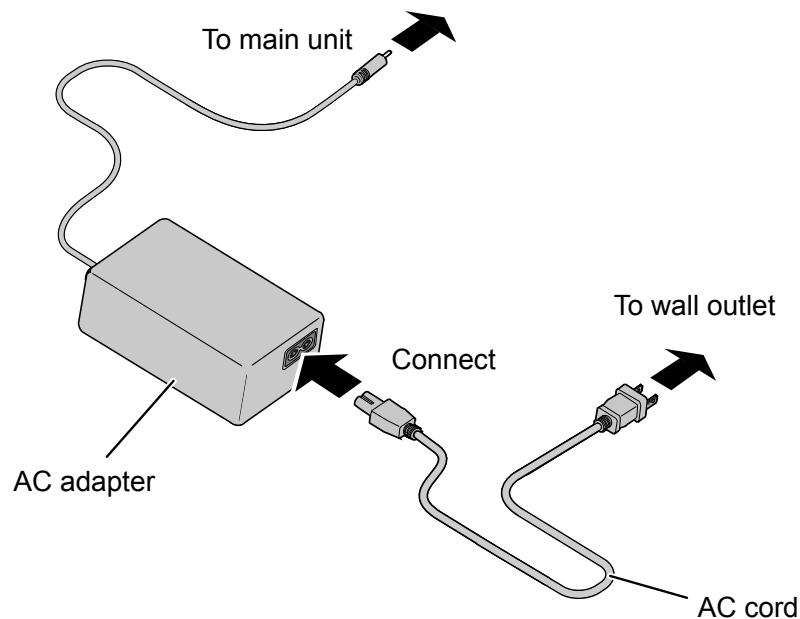

Connecting the video cable

Connect the document camera to the display device with a video cable corresponding to the display device.

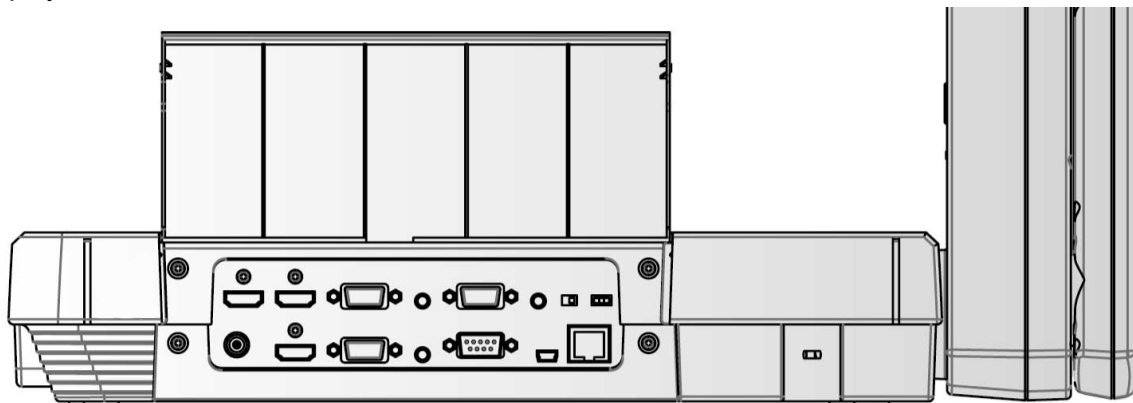



CAUTION

Before connecting the main unit to other devices, be sure to turn OFF the power for all of the devices.



Set the resolution corresponding to the display device.

■ Turning the power ON/OFF

- Press the [] button on the main unit or the []

button on the remote control to turn the power ON.

(After the [] button flashes blue, it is illuminated a few seconds later.)

- Press the [] button on the main unit or the []

button on the remote control to turn the power OFF.

You need to hold down the button for two seconds or more for the button on the main unit.

(The LED of the [] button is illuminated in red.)



Note

- Do not operate this device while it is flashing.

■ Operating the touch panel

You can control the unit with the touch panel..

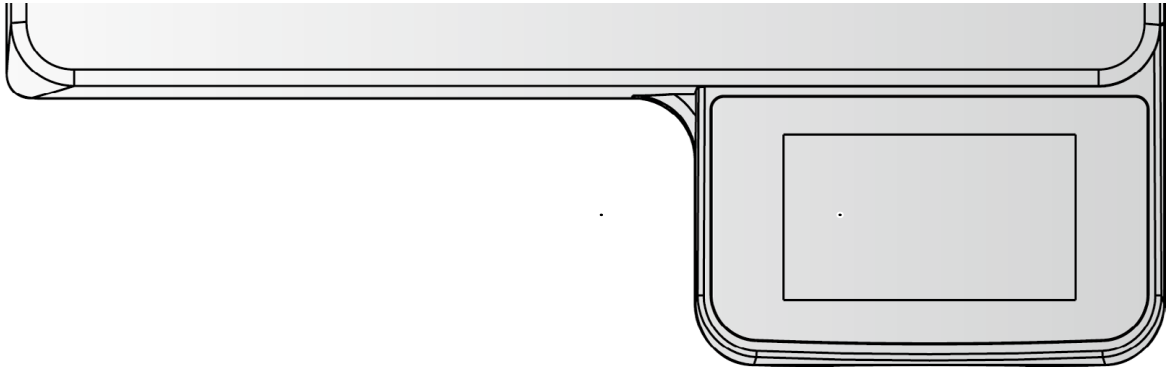

Startup screen

The startup screen will appear on the touch panel when the product is turned on.



Main menu

The main menu is displayed by tapping the menu icon at the top right of the startup screen



How to operate the touch panel

① Tap

By tapping an icon on the touch panel, you can select a function and operate.



② Drag

By sliding your finger across the touch panel surface while touching the item, you can move it. When the Presentation features (Highlight, Mask, Scroll) are in use, you can move the area.







Note

The touch panel in the P100HD is a “Resistive Touchscreen” which is different than “Capacitive Touchscreen” typically found in consumer tablets. To operate, firmly press a selected icon or drag a selected area to initiate a command.

CAUTION

- To prevent damage during transport, a protection sheet has been put on the touch panel screen. Please be sure to remove it before use.
- Do not press the panel strongly by finger or sharp objects.
This can cause damage or malfunction.
- Please do not put a thing on a screen.

■ Adjusting the size

To adjust the display area of the document, tap [Startup screen] > [ / ] on the touch panel or press the [ / ] button on the remote control.

 ZOOM-IN

: The object can be shown in large size.

 ZOOM-OUT

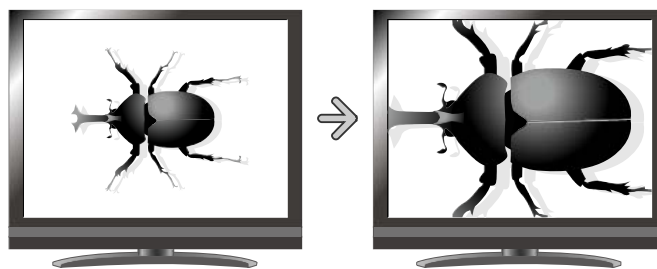
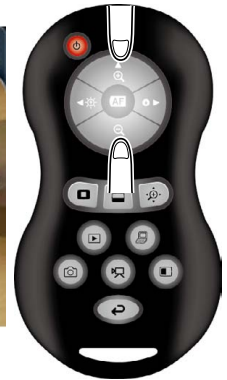

: The object can be shown in small size.



Note

- Zoom ratio: Optical 16x, Digital 8x
- When the optical zoom reaches 16x, it automatically shifts to digital zoom.
- Within the digital zoom range, the image quality is degraded.
- ON/OFF of the digital zoom can be set from the setting menu.
- When you choose the external input in Signal select, you can not operate to zoom.



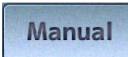

■ AF (Auto focus)



([ (Setting)] > [ (AF mode)] > [] on the touch panel)

To auto focus only once when [Startup screen] > the image area on the touch panel or the [] button on the remote control is pressed.





■ Adjusting the brightness

To adjust the brightness of the image, tap [ (Main menu)] > [] on the touch panel or press the [ / ] buttons on the remote control.

The following two adjustment modes are available for this adjustment. Each mode can be set by tapping [ (Setting)] > [] on the touch panel.



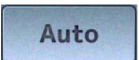

Automatic brightness adjustment

([ (Setting)] > [ (Brightness)] > [] on the touch panel)

To ensure a constant degree of brightness, the brightness of the image changes automatically according to the brightness



of the shooting environment. Tap [ (Main menu)] > [] or press the

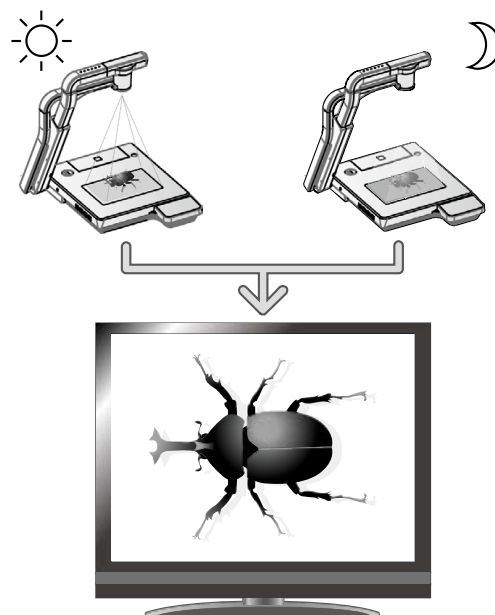
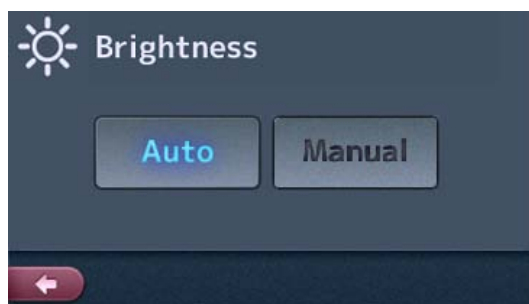



[ / ] buttons on the remote control to change the level of the automatic brightness adjustment.



Brightness of the screen is the same

Manual brightness adjustment



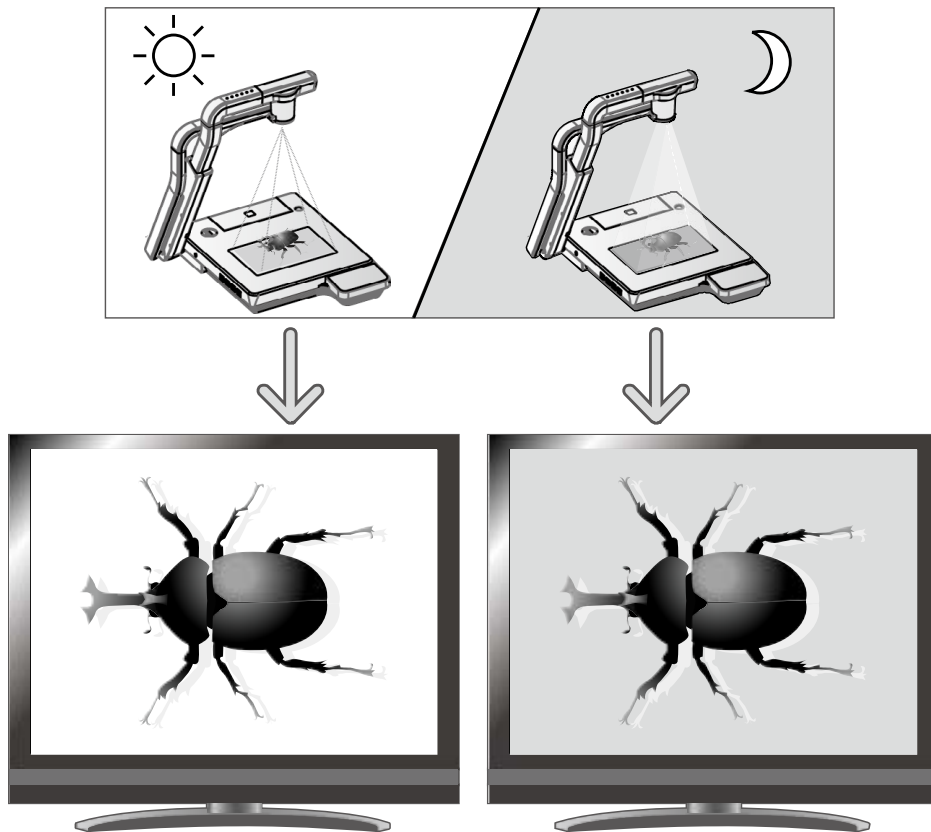

([ (Setting)] > [ (Brightness)] > [**Manual**] on the touch panel)

To change the brightness manually, tap [ (Main menu)] > [] or press the [ / ] buttons on the remote control. The image brightness does not automatically change in response to the brightness of the shooting environment.





Brightness of the screen is different

Note

- Factory setting is set to [Auto].
- To return to the factory settings, tap [ (Main menu)] > [ **Reset**] on the touch panel.
- In places where the object is exposed to bright sunlight (e.g. near a window), or extremely bright lights, the brightness of the screen may not dim sufficiently, even by tapping [ (Main menu)] > [] or pressing the [] button on the remote control. In such cases, close the curtains or move the object away from the light to adjust the amount of light.
- When you choose the external input in Signal select, you can not adjust the brightness.

■ Turning the illumination ON/OFF





The upper light and the base light can be turned ON/OFF by tapping [ (Main menu)] > [] [] on the touch panel.

CAUTION

- When you take a picture of a person, turn off the upper light.
- Make sure that the light from the upper light does not shine directly into your eyes.
- This product is equipped with a high-brightness LED light. You can safely use the light to light up objects, however its brightness will gradually diminish with long-term use. This is not a malfunction of the light, but a feature of LED performance.
- Do not touch the upper light while it is on as it may become very hot.



■ Image selection

You can switch the input source either with the remote control or from the Signal select screen

displayed by tapping [ (Main menu)] > [] on the touch panel.



Camera image:

[ (Signal select)] > [] on the touch panel



[] button on the remote control

Image input from the RGB IN1, RGB IN2, HDMI IN1, HDMI IN2 terminal:

[ (Signal select)] > [] on the touch panel





[] button on the remote control. (Only RGB IN1 is selected.)



Image stored on the SD card/USB flash drive:

[ (Signal select)] > [] on the touch panel

[] button on the remote control



Note

- When using a PC with external output mode switching, set it using the following procedures.
 1. Connect the PC to this unit.
 2. Change the PC to the external output mode.
 3. Tap [ (Signal select)] > [] on the touch panel or pressing the [] button on the remote control.
- When selecting the image in [Signal select (Normal)], output same image (resolution) to [RGB OUT] and [HDMI OUT].
- When selecting external input image, do not change the resolution of the input image.

The following image signals can be input to the RGB input terminal.

The image signals specified as "Video" in the following table can be input to the HDMI input terminal.

Resolution (dot)	Frequency		Polarity of synchronized signal (P: Positive, N: Negative)	Standard
	Horizontal (kHz)	Vertical (Hz)	HS/VS	
640×480	31.469	59.940	N/N	VESA
800×600	37.879	60.317	P/P	VESA
1024×768	48.363	60.004	N/N	VESA
1280×800	49.702	59.810	N/P	VESA
1280×1024	63.981	60.020	P/P	VESA
480p	31.500	60.000	N/N	Video
576p	31.250	50.000	N/N	Video
720p	37.500	50.000	P/P	Video
720p	45.000	60.000	P/P	Video
1080p	56.250	50.000	P/P	Video
1080p	67.500	60.000	P/P	Video



■ Details of Each Function

Highlight Function

This is a function to highlight a particular section of the image.



Use this function to draw attention to a section.

Highlight operations

When you tap [ (Presentation)] > [] on the touch panel or the [] button on the remote control while the camera image, the external input or the still image is displayed, the highlight function works with the darkness and size set previously.

You can move the highlighted area by dragging it on the touch panel or with [] buttons on the remote control.

The highlight function is released by tapping [Highlight] >

[] on the touch panel or by pressing the []

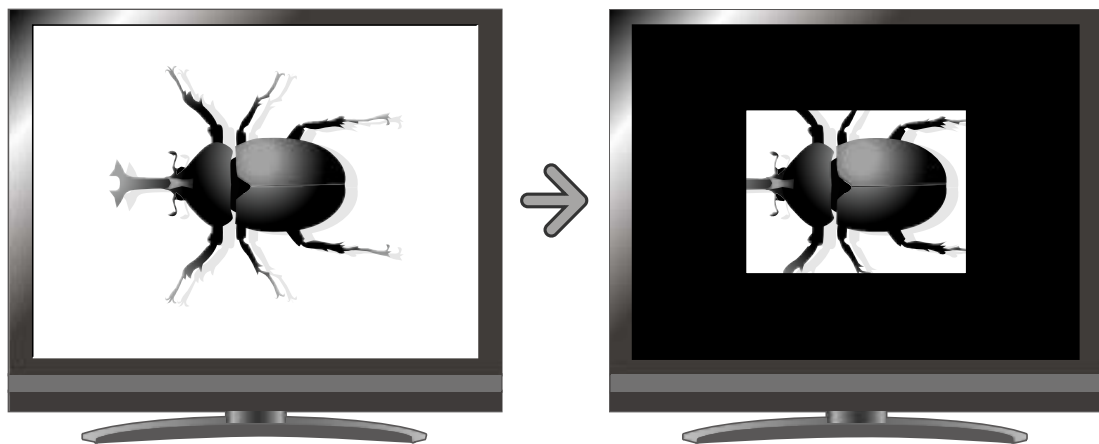

button on the remote control again.



Note

- Highlighted image cannot be captured.

Setting operations

You can change the darkness of the highlighted area by tapping [Highlight] > [] [] while the highlight function is activated.

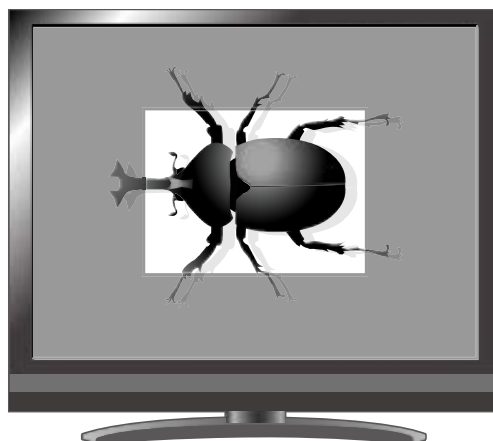



Also, by dragging the edge of the highlighted area on the touch panel, you can change the size of the highlighted area.





Mask Function

This is a function to mask a section of an image.

Mask operations

When you tap [ (Presentation)] > [] on the touch panel or the [] button on the remote control while the camera image or the external input or the still image is displayed, the mask effect is applied with the darkness set previously.

You can move the masked area by dragging it on the touch panel or with [] buttons on the remote control.

The mask function is released by tapping [Mask] > [] on the touch panel or by pressing the [] button on the remote control again.

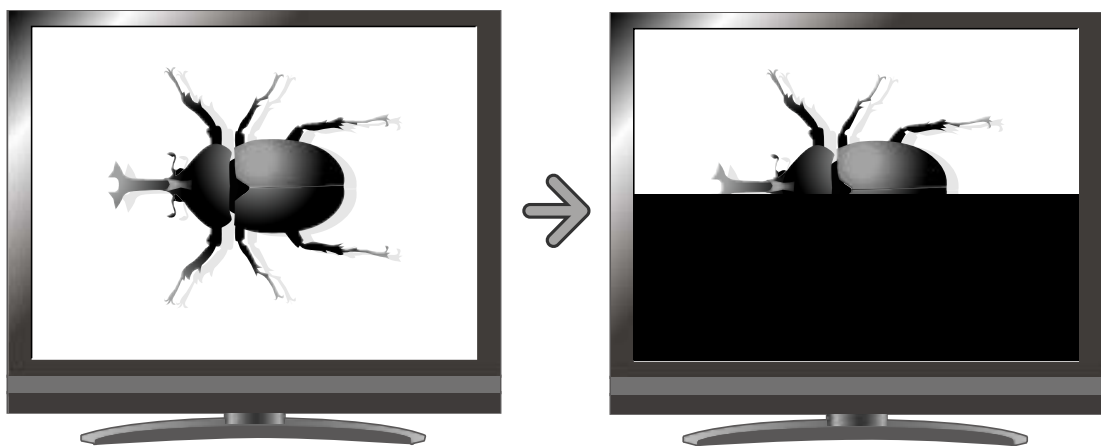



Note

- Masked image cannot be captured.



Scroll Function

The image expands to the digital zoom set previously, and the enlarged screen can be scrolled.

Scroll operations



When you tap [ (Presentation)] > [] on the touch panel or the [] button on the remote control while the camera image or the still image is displayed, the digital zoom works with the magnification set previously.

You can scroll the enlarged image by dragging the scroll area on the touch panel or with [] buttons on the remote control.

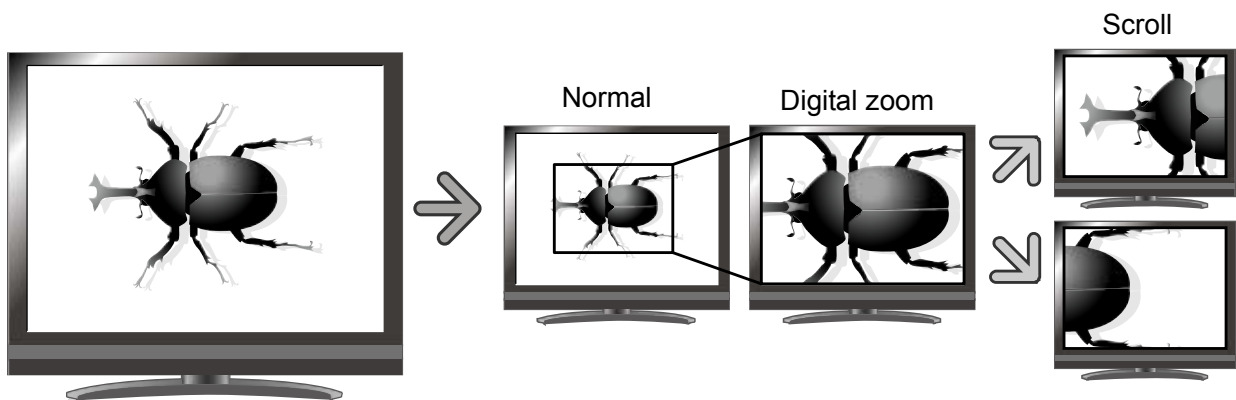

The digital zoom is released by tapping [Scroll] > [] on the touch panel or by pressing the [] button on the remote control again.



Note

- When digital zoom has already been performed from the [Startup screen] > [ / ] on the touch panel or zoom buttons on the remote control, digital zoom is released and the scroll function works at the magnification ratio currently set.
- Zoom cannot be used while scrolling.
- Digital zoom may cause image quality deteriorates.

Digital zoom setting operations

You can change the digital zoom ratio to either x2, x3, or x4 by tapping [Scroll] > [] [], or [] on the touch panel while the scroll function is working.



Compare Picture Function

To display the live camera image and a picture stored on the SD card/USB flash drive together.

Compare Picture operations

When operating by the touch panel





Tap the touch panel [ (Presentation)] >

[] to display the Input signal select screen.

Tap the [] to display the input source.



Left side of the screen : Camera image

Right side of the screen : Selected input source [] [] [] or []

Also the following information will be displayed if [] is tapped:

Left side of the screen : Camera image

Right side of the screen : Still images that are stored in the USB memory or the SD card

When operating by the remote control

When the camera image is displayed, press the [] button on the remote control to display the input source.

Left side of the screen : Camera image

Right side of the screen : RGB 1



Also the following information will be displayed if the [] button on the remote control is pressed while a still picture is displayed:

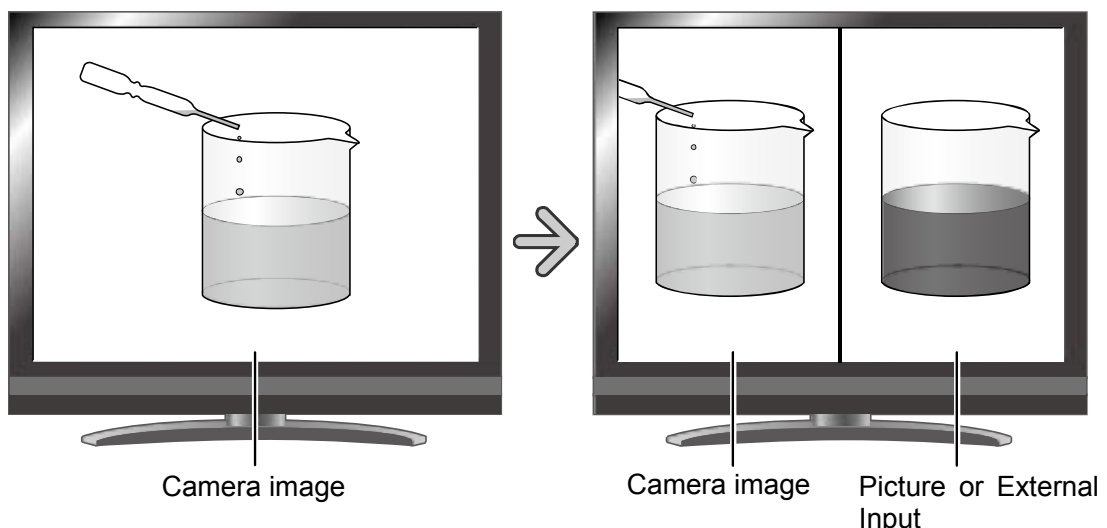

Left side of the screen : Camera image

Right side of the screen : Still images that are stored in the USB memory or the SD card



Operating the camera image

When you tap [Compare picture] > [ / ]

on the touch panel or the [ / ]



button on the remote control while the Compare picture function is working, you can adjust the display area of the document.



When setting manual in the AF mode, tap the part except the icon on the screen left side to adjust the focus.



Changing the still image

You can change the still image displayed on the screen to other still image stored on the SD card /USB flash drive by tapping [Compare Picture] >

[] [] on the touch panel or pressing

[ / ] buttons on the remote control

while the Compare Picture function is working.

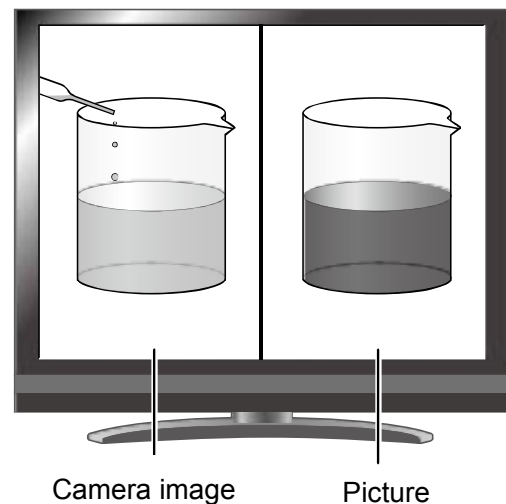

Releasing compare pictures function

Tap the touch panel [Compare picture] > [] or press the [] button on the remote control again. The compare picture function is released.





Note

- When using the Compare Picture function, the image cannot be captured.

Mosaic Function

To apply a mosaic effect to the image. You can change the extent of mosaic.



Mosaic Operations

When you tap [ (Presentation)] > [] on the touch panel while the camera image, the external input or the still image is displayed, the mosaic effect is applied.

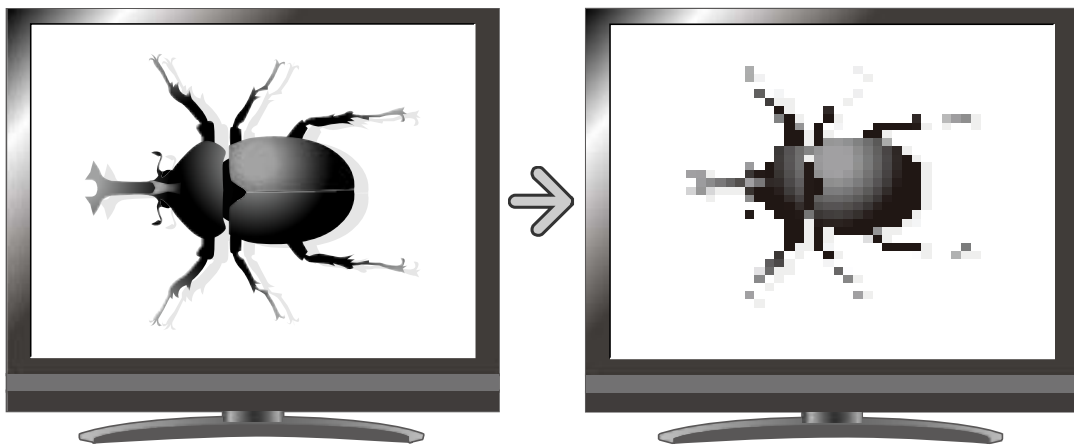
The mosaic effect is released by tapping [Mosaic] > [] on the touch panel.



Mosaic setting Operations

You can change the degree of mosaic by tapping [Mosaic] > [] [] on the touch panel while the mosaic function is working.

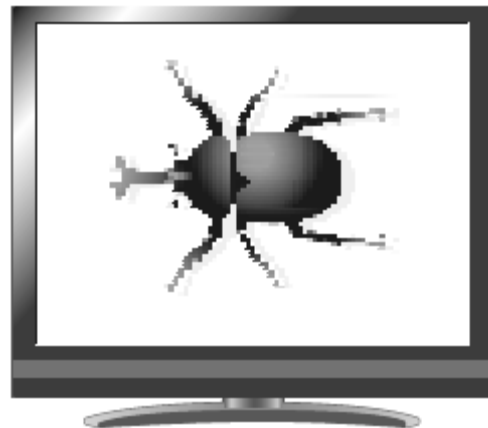





Note

- When using the Mosaic function, the image cannot be captured.

Icon descriptions





Startup screen









Icon	Name	Function
	Zoom In	Object can be shown in larger size.
	Zoom Out	Object can be shown in smaller size.
	Screen	Focus on the image when tapped while the AF mode is set to manual.
	Menu	Move to Main menu.

Main menu











Icon	Name	Function
	Main menu	Display the operation menu for camera image.
	Presentation	Display the Presentation screen.
	Signal select	Display the Signal select screen. ※ Normal settings and Advanced settings are available.
	Setting	Display the Setting screen.

	Capture	Save the still image on the SD card/USB flash drive.
	Rec	Save the video on the SD card/USB flash drive.
	Pause	Pause the camera image. Press this button again to restart.
	Adjust Brightness	Adjust brightness the camera image.
	Reset Brightness	Return to the factory settings of brightness.
	Lighting switch	Turn ON/OFF of the material illumination or the base illumination .
	Preview	Return to the Start-up screen when tapped.

Presentation







Icon	Name	Function
	Highlight	Highlight part of the image you want to emphasize.
	Mask	Mask part of the image.
	Scroll	Enlarge the image to the size you specify, allowing you to move within the enlarged area.
	Compare Picture	Display the live image and the still image or image from the external input together. Display the Compare Picture Input Settings screen.

	Mosaic	Apply mosaic effect to the image.
	Image Rotation	Rotate camera image by 180°.
	Color/B&W	Display an image in color or black & white.
	Posi / Nega	Output a positive or negative image.

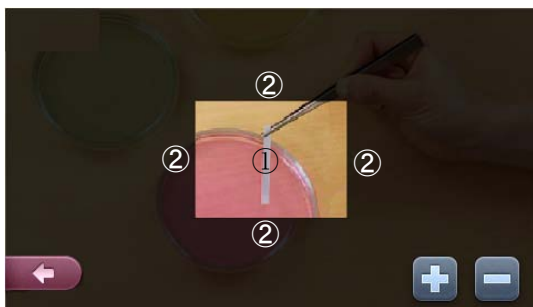
Presentation Settings

Highlight



Icon	Name	Function
①	Highlighted area	Move the Highlighted area by dragging.
②	Around the Highlighted area	Change the size of the Highlighted area by dragging the outside of the highlighted area.
	Darken	Make the dark area less transparent and harder to see through.
	Lighten	Make the dark area more transparent and easier to see through.
	Exit	Return to the Presentation screen.

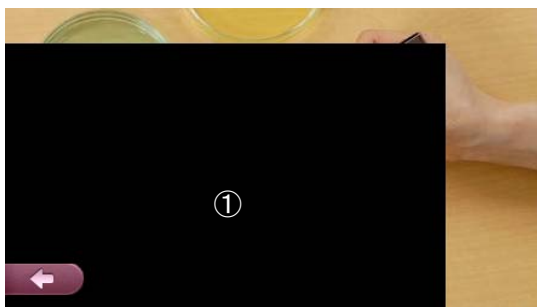

Mask



Icon·Area	Name	Function
①	Mask area	Move the Mask area by dragging.
	Exit	Return to the Presentation screen.





Scroll



Icon·Area	Name	Function
①	Enlargement	Scroll the enlarged area by dragging.
	Magnification setting	Set the digital zoom magnification to x2 ,x3 or x4.
	Exit	Return to the Presentation screen.







Compare Picture Input Settings



Icon	Name	Function
	Camera image/External input	Compare the camera image and the image from the external input.
	Camera image/still image	Compare the camera image and the still image.
	External input selection	Select the external input to compare with the camera image.
	Exit	Return to the Presentation screen.

Compare Picture



Icon /Area	Name	Function
	Zoom In	Object can be shown in large size.
	Zoom Out	Object can be shown in small size.
	Screen	Focus on the image when tapped while the AF mode is set to manual.
	Prev Picture	Show the previous picture. This icon is only shown during comparing still image.
	Next Picture	Show the next picture. This icon is only shown during comparing still image.
	Exit	Return to the Compare Picture Input Settings screen

Mosaic







Icon	Name	Function
	Coarse	Make the mosaic pattern coarser.
	Fine	Make the mosaic pattern finer.
	Exit	Return to the Presentation screen.



Image Rotation

Icon	Name	Function
	Image Rotation	Rotate a camera image by 180°.
	Exit	Return to the Presentation screen.

Color/B&W

Icon	Name	Function
	Color/B&W	Display an image in color or black & white.
	Exit	Return to the Presentation screen.

Posi/Nega

Icon	Name	Function
	Posi/Nega	Output a positive or negative image.
	Exit	Return to the Presentation screen.

Signal select (Normal)



Icon	Name	Function
	Advance mode	Move to the Advance mode.
	Camera	Select the camera image.
	Thumbnail	Select the thumbnail.
	External input	Select the external input. Same image is output to RGB output and HDMI output. You can not select the Advance mode while selecting the external input.

Signal select (Advance)



Icon	Name	Function
	Normal	Return to the normal mode.
	External input	Select the external input that you want to output from RGB output. When this is selected, the camera image is output from HDMI output.

Setting



Tap the icon that want to set.

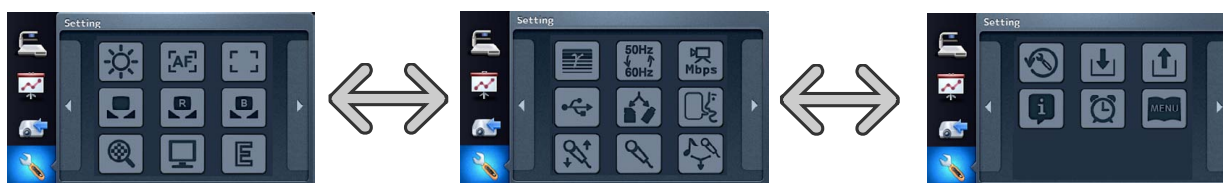

Icon	Name	Function
	Prev Page	Move to the previous page.
	Next Page	Move to the next page.



Brightness



Icon	Name	Default	Function
	Auto		Maintain constant brightness of the image, the brightness of the image changes automatically according to the brightness of the shooting environment. Tap [(Main menu)] > [] on the touch panel or press the [/] buttons on the remote control to change the level of the automatic brightness adjustment.
	Manual		To change the brightness manually, tap [(Main menu)] > [] on the touch panel or press the [/] buttons on the remote control. The image brightness does not automatically change in response to the brightness of the shooting environment.
	Exit		Return to the Setting screen.



AF Mode

★ What is AF?

A function to automatically focus the camera.

Icon	Name	Default	Function
	Auto		Focus automatically. You do not need to tap the touch panel or press the [] button on the remote control. The focus changes automatically as the object changes.
	Manual	↓	De-activate the auto focus once when tapped or the [] button on the remote control is pressed.
	Zoom Sync		Auto focus only once after zooming.
	Exit		Return to the Setting screen.



Focus

Icon	Name	Function
	Near	Focus manually.
	Far	
	Exit	Return to the Setting screen.

★ What is White Balance?

A function to adjust any area of white color and ensure it is projected accurately as white. This allows colors to be seen naturally according to the characteristics of the object.



White Balance

Icon	Name	Default	Function
	Auto	↓	Adjust the white balance automatically. The white balance is adjusted automatically to ensure a more natural color according to the characteristics of the object.
	Manual		Manually adjust the [R-Gain] and the [B-Gain].
	One-Push		Automatically adjust the white balance only once when this setting is selected.
	Exit		Return to the Setting screen.



R-Gain

Icon	Name	Function
	Up	To adjust the R-Gain of the camera image when the white balance is set to Manual. Use [Up] or [Down] to increase or decrease the red color.
	Down	
	Exit	Return to the Setting screen.



B-Gain

Icon	Name	Function
	Up	To adjust the B-Gain of the camera image when the white balance is set to Manual. Use [Up] or [Down] to increase or decrease the blue color.
	Down	
	Exit	Return to the Setting screen.



Digital Zoom

Icon	Name	Default	Function
	Valid	↓	Set the digital zoom to Valid/Invalid.
	Invalid		
	Exit		Return to the Setting screen.



Image Mode

★ What is Image Mode?
A special effect to project a clear image.

Icon	Name	Default	Function
	Text1	↓	Clearly reproduce black & white documents including such features as characters and lines. The effect intensifies as the number increases.
	Text2		
	Text3		
	Graphic1		Clearly reproduce photographs and color documents.
	Graphic2		Image could be improved if used with a DLP projector. (The effect depends on the projector used.)
	Exit		Return to the Setting screen.



Edge Effect

Icon	Name	Default	Function
	Low	↓	Emphasize the outline of images. Enabled only when [Graphic1] is selected for the Image Mode
	Medium		
	High		
	Exit		Return to the Setting screen.



Gamma

★ What is Gamma?

An image characteristic unique to image I/O devices.

Icon	Name	Default	Function
	Low		Change the characteristics of the image. Enabled only when [Graphic1] is selected for the Image Mode.
	Medium	↳	
	High		
	Exit		Return to the Setting screen.



Flicker Rate

Icon	Name	Default	Function
	50Hz	Others	Reduce fluorescent light flickering due to the power supply frequency.
	60Hz	Japan/U.S.	Select the same value as used for the power supply frequency.
	Exit		Return to the Setting screen.



Movie Quality



Icon	Name	Default	Function
	Low		Set the quality of the movie to record.
	Medium		
	High	↳	
	Exit		Return to the Setting screen.



USB Mode

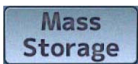
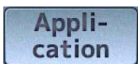

★What is USB Mode?

Functions described below can be used by connecting the document camera to a PC with the USB cable.

Icon	Name	Default	Function
	Mass Storage		Send the data on the SD card loaded in the device to the PC.
	Application	↳	Control this device from a PC using special software.
	Exit		Return to the Setting screen.



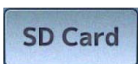

Select Memory

Icon	Name	Default	Function
	SD Card	↳	Select where to save still images/movies, when both SD card and USB flash drive are inserted.
	USB Flash Drive		
	Exit		Return to the Setting screen.



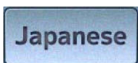
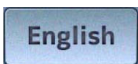

Language

Icon	Name	Default	Function
	Japanese	Japan	Display the menu in Japanese.
	English	Others	Display the menu in English.
	Exit		Return to the Setting screen.



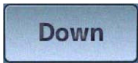

Volume

Icon	Name	Function
	Up	Set the volume of the audio line output and the HDMI output.
	Down	
	Exit	Return to the Setting screen.



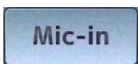
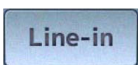

Audio Selector

Icon	Name	Default	Function
	Built-in mic	↓	Select the source of the audio input.
	Mic-in		
	Line-in		
	Exit		Return to the Setting screen.

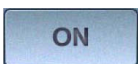
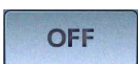

Mic Mixer

Icon	Name	Default	Function
	ON		Mix MIC IN with AUDIO IN of the back panel to output AUDIO OUT.
	OFF	↓	Output the signal input from AUDIO IN in the back panel from AUDIO OUT.
	Exit		Return to the Setting screen.



Reset All

Icon	Name	Function
	Yes	Reset various settings to factory settings.
	Exit	Return to the Setting screen.



Save Presets

★Saved Items
Zoom, Brightness, Mode, Brightness Level, White Balance,
R-Gain, B-Gain,

Icon	Name	Function
	1	Save the current setting as the preset setting of the selected number.
	2	
	3	
	Exit	Return to the Setting screen.





Load Presets

Icon	Name	Function
	1	Call the setting saved for the selected number.
	2	
	3	
	Exit	Return to the Setting screen.





Guide

Icon	Name	Default	Function
	ON	↓	Display device's operating status and an explanation of the icons on the screen.
	OFF		Turn off display of device's operating status and an explanation of icons on the screen.
	Exit		Return to the Setting screen.



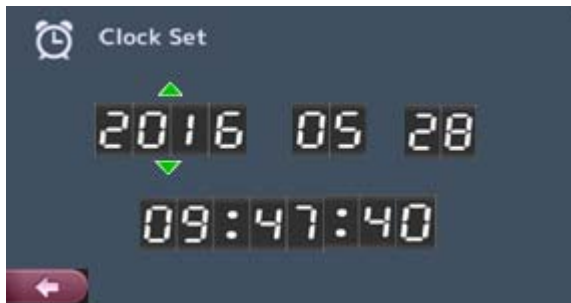

Clock Set



Icon	Name	Function
		Move the arrow by tapping just above year, month, day, hour, minute or second that you want to change. Then tap the arrow to change the value..
	Exit	Return to the setting screen after setting the date and time.

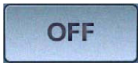

Startup menu display

Icon	Name	Default	Function
	ON	↓	Display the menu on the startup screen.
	OFF		Display the Main menu icon only on the startup screen.
	Exit		Return to the Setting screen.

3

ADVANCED OPERATIONS

3-1 Using an SD card/USB flash drive

With this equipment, you can save a camera image as a picture or movie on an SD card or USB flash drive.

You can also display the data stored on the SD card or USB flash drive on the screen.

Before you begin, insert a commercially available SD card or USB flash drive into the corresponding slot on the side panel.

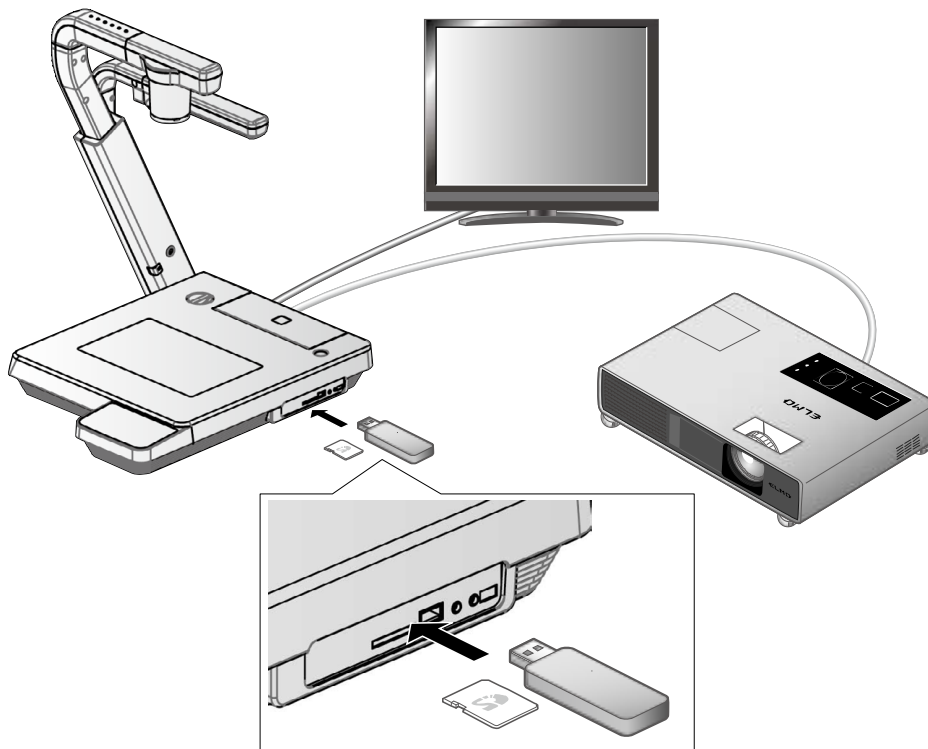

Note



- SD card
 - A SDXC card cannot be used.
 - Formatting the SD card with this product before you use is recommended.
 - Using an SD card to record movies is recommended.
 - Using an SD card class 6 or higher is recommended.
- USB flash drive
 - Supports USB flash drive up to 32GB.
 - Formatting the USB flash drive with this product before you use is recommended.
- It may take some time to recognize the memory card after inserting it or to save images to the memory card.
- Please do not remove the memory card while recording, playing or using education support function when the main unit is accessing the memory card.







Note

- Formatting the SD card/USB flash drive.

When you need to format the SD card/USB flash drive, insert it into this product and execute formatting.

① Tap [ (Signal select)] > [] on the touch panel to switch the output image to the Playback image.

② Tap [] located in the right of the menu to change the thumbnail icon. Then select [].



③ Tap [] to start formatting. If you do not want to format, select [].

■ Saving images

Picture

Basic operations

When operating by the touch panel

- ① Tap the [ (Main menu)] > [] on the touch panel.



- ② Saving begins when [] appears on the preview screen of the touch panel.



When operating by the remote control

① Press the [] button on the remote control.



② Press the [] button on the remote control.



③ Saving begins when [] appears on the screen.





- Saving -

Movie



Basic operations

When operating by the touch panel



- ① Tap [ (Main menu)] > [] to switch to the recording screen.
- ② Tap [Recording] > [] to stop the recording.



When operating by the remote control

- ① Press the [] button on the remote control.
- ② Press the [] button on the remote control.





- ③ Recording begins when [] appears at the top left of the screen. When you press the [] button again on the remote control, recording stops and [] disappear.



- Recording -

Note





- Even if the output image is set to HDMI and the resolution is set to 1080p, video is recorded in 720p.
- To prevent deterioration of image quality , use a memory card with a faster read/write speed (SD card: Class 6 or better).
- How to select the destination to save when both SD card and USB flash drive are inserted.

Tap [ (Setting)] > [] > [**SD Card**] [**USB Flash Drive**] on the touch panel to select [SD Card] or [USB Flash Drive].



Recording display





Icon	Name	Function
	Zoom In	Object can be shown in large size. This icon is not shown when selecting the external input in the Signal select.
	Zoom Out	Object can be shown in small size. This icon is not shown when selecting the external input in the Signal select.
	Screen	Focus on the image when tapped while the AF mode is set to manual. This icon is not shown when selecting the external input in the Signal select.
	Adjust Brightness	Adjust brightness the camera image. This icon is not shown when selecting the external input in the Signal select.
	Stop	Return to the Main menu after stopping recording.

■ Displaying the stored data

Thumbnail display (list of pictures/movies)

Basic operations

When operating by the touch panel

① Tap [ (Signal select)] > [] on the touch panel to display the thumbnails.



Thumbnail icon

In the thumbnail icon,

If [] is selected, the list of pictures.

If [] is selected, the list of recorded movies appears.

② Select the picture/movie you want to display full-screen.

(1) Tap the thumbnail of the touch panel to move the cursor.



(2) Tap the selected thumbnail again to display the picture/movie full-screen. The movie automatically starts to play.

Picture

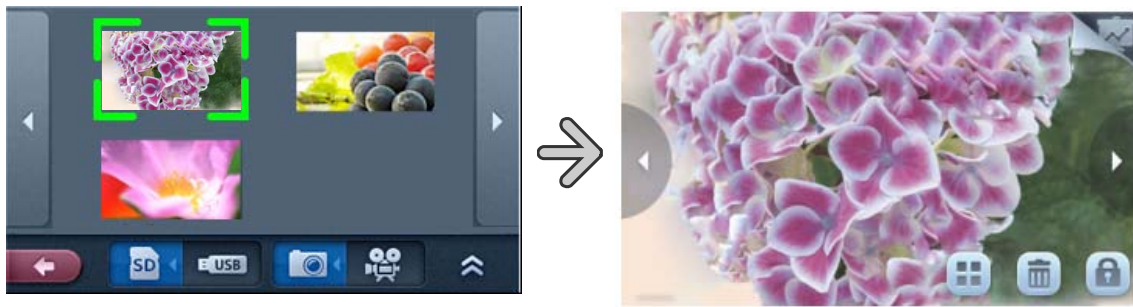

Movie

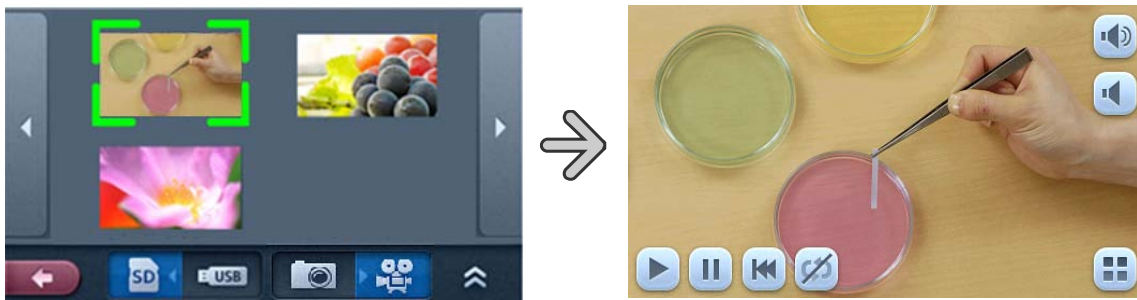

(3) Tap [Thumbnails] > [◀] [▶] to move between thumbnail pages.

③ To return to the thumbnail display, tap the [4x4 grid icon] on the touch panel.

When operating by the remote control

① Press the [play button] button on the remote control to display the thumbnails (list of pictures/movies).
The current selection is displayed in the right bottom of the screen.

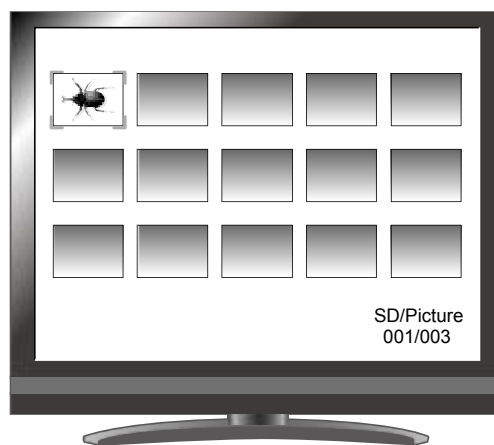

< Thumbnail images >

Press the [play button] button on the remote control to navigate the list of pictures and movies.

② Select the picture/movie you want to display full-screen.

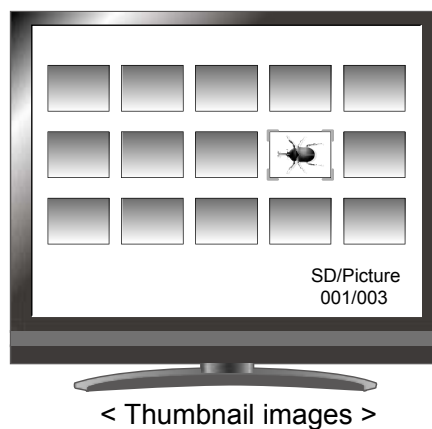

Press the [] button on the remote control to move the cursor.





③ Select the picture/movie to display full-screen.

Press the [] button on the remote control to display the selected picture/movie full-screen.

The movie automatically starts to play.

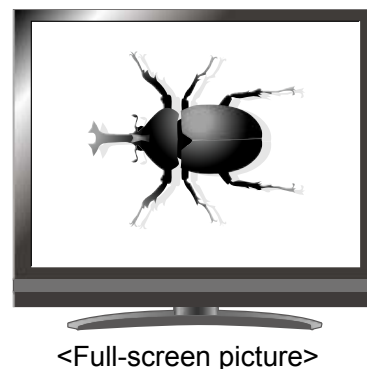
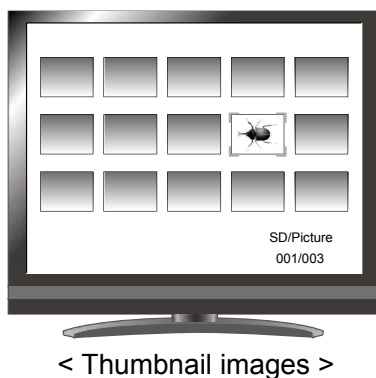
Press the [ / ] button on the remote control to display another image in the thumbnail list.



④ To return to the thumbnail display, press the [] button on the remote control.

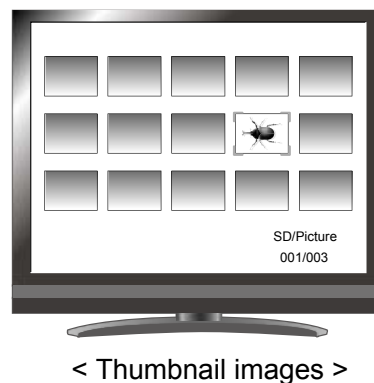
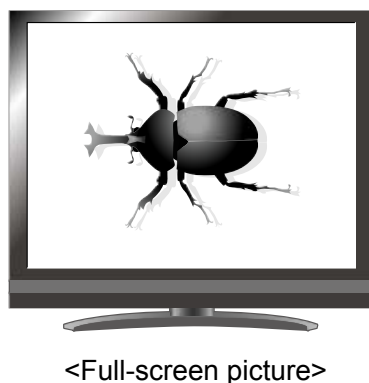



Changing settings

Tap the thumbnail icon to change the settings.



Thumbnail icon

If you tap [] [], the next set of icons appears.



Thumbnail icon

CAUTION

You can not operate the menu from the remote control.

Icon descriptions









Thumbnail display1



Icon	Name	Function
	Prev Page	Move to the previous thumbnail page.
	Next Page	Move to the next thumbnail page.
	Thumbnail cursor	Move the cursor by tapping the thumbnail which you want to choose.
	Thumbnail	Move to the Picture display / Movie play screen when the thumbnail of the selected picture / movie is tapped.
	SD Card	Switch between the memory from which images are displayed.
	USB Flash Drive	It can be switched with the [] button on the remote control too.
	Picture	Switch the data displayed as thumbnails between movies and pictures.
	Movie	It can be switched with the [] button on the remote control too.
	Next Menu	Move to the next menu page.
	Exit	Return to Signal select.



Thumbnail display2



Icon	Name	Function
	Lock/Unlock	Lock (set as protected) or unlock (set as unprotected) the selected image. Can be switched with the [] button on the remote control as well.
	Lock All	Lock (set as protected) all thumbnail images.
	Unlock All	Unlock (set as unprotected) all thumbnail images.
	Delete	Move to Delete screen.
	Format	Move to Format screen.
	Prev Menu	Move to the previous menu page.
	Exit	Return to Signal select.

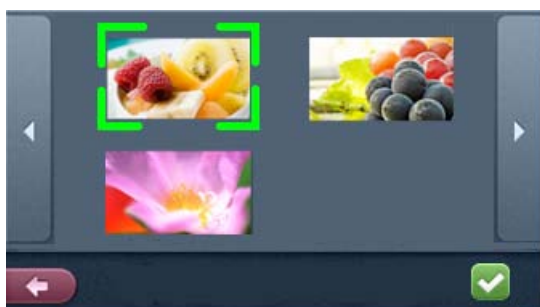

Delete

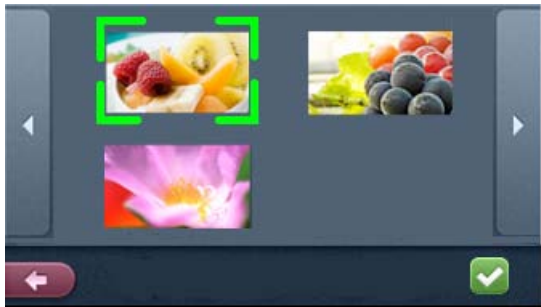

Icon	Name	Function
	Yes	Delete the selected image.
	Exit	Return to thumbnail display.

Format







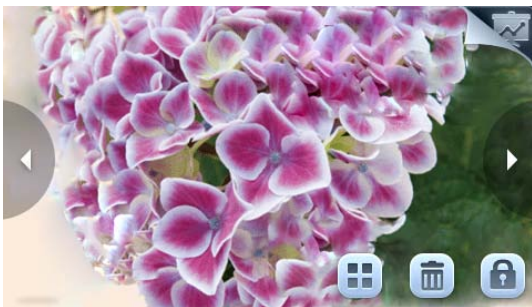

Icon	Name	Function
	Yes	Format the USB flash drive or SD card.
	Exit	Return to thumbnail display.

Picture Display Menu



Note

The icons disappear after about ten seconds from showing the display. If you want to operate the icons, you will tap any place on the screen. The icons show again.

Icon	Name	Function
	Prev Picture	Move to the next picture page.
	Next Picture	Move to the prev picture page.
	Thumbnail	Return to thumbnail display.
	Delete	Move to Delete screen.
	Memory Lock	Lock (set as protected) or unlock (set as unprotected) the selected image.
	Presentation	Move to Presentation screen.

Movie Play Menu









Note

The icons disappear after about ten seconds from showing the display. If you want to operate the icons, you will tap any place on the screen. The icons show again.

Icon	Name	Function
	Play	Play/stop/cue the movie.
	Pause	
	Cueing	
	Repeat On	Play the movie on loop.
	Repeat Off	
	Up	Set the output audio volume.
	Down	
	Thumbnail	Return to thumbnail display.

Presentation screen (Picture display)



Icon	Name	Function
	Highlight	Highlight and draw attention to a particular section of the image.
	Mask	Mask a section of the image.
	Scroll	Expand to a set size and allow scrolling of the enlarged section.
	Compare Picture	Display a still image and live image together.
	Mosaic	Apply a mosaic effect to the image.
	Image Rotation	Rotate the image by 0°, 90°, 180°, 270°.
	Exit	Return to Picture display.



Note



- You may not be able to display image data not saved by this product or converted using the conversion function of the software supplies.
- File Converter cannot convert movies.
- You cannot display pictures other than DCF system compliant files and file structures.
- Movie files that have the file name other than "MVI_****.MP4" cannot be displayed.
- Only picture files and movie files that are saved under the folder ¥DCIM¥100_ELMO on the SD card/USB memory will be available for playback.
- Many, but not all Images taken by other digital cameras can be displayed (viewed) on this product (examples of images that cannot be displayed: images larger than 4092 X 4092 pixels in size, 4:1:1 image file formats, etc.).
- Use the File Converter of the supplied Image Mate software to convert the image files taken with a digital camera to the files viewable with the unit.

3-2 Outputting a different image to RGB OUT and HDMI OUT

This unit can output a different image to RGB_OUT and HDMI_OUT.

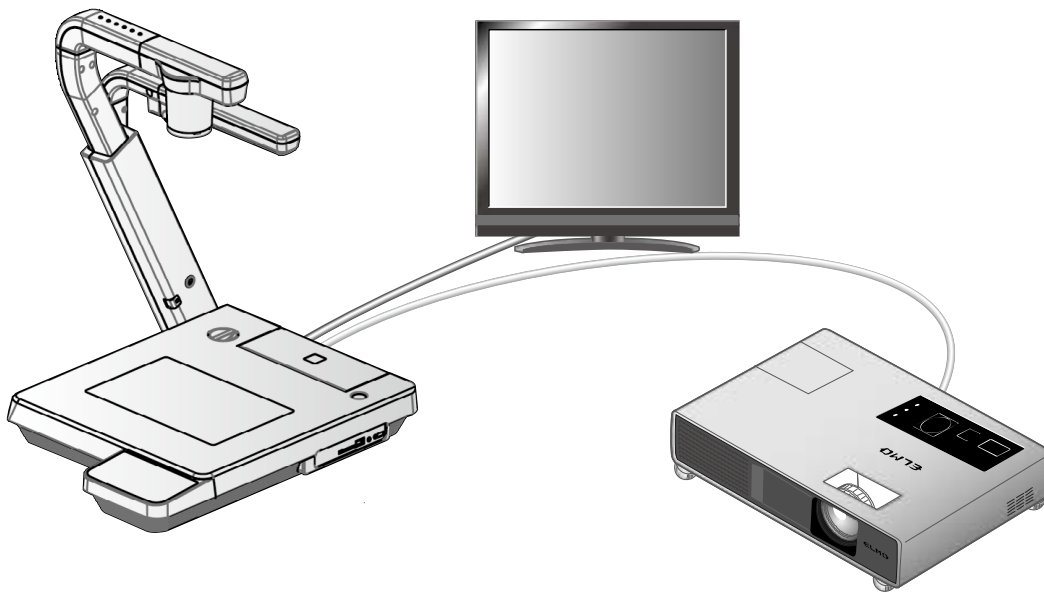
While outputting a camera image to HDMI output terminal, this unit can output the image of one of either HDMI IN1, HDMI IN2, RGB IN1, or RGB IN2 to RGB output terminal.



① Tap the [ (Signal select)] > [ Normal] on the touch panel, and tap [].

② Tap the [ (Signal select)] > [ Advance] on the touch panel.



③ Tap one of [HDMI1], [HDMI2], [RGB1] or [RGB2] that belongs to the output terminal that you want to output.

The selected input image is output to RGB output terminal in resolution of selected input image.

The camera image is output to HDMI output terminal.





Note

- When selecting external input image, do not change the resolution of the input image.

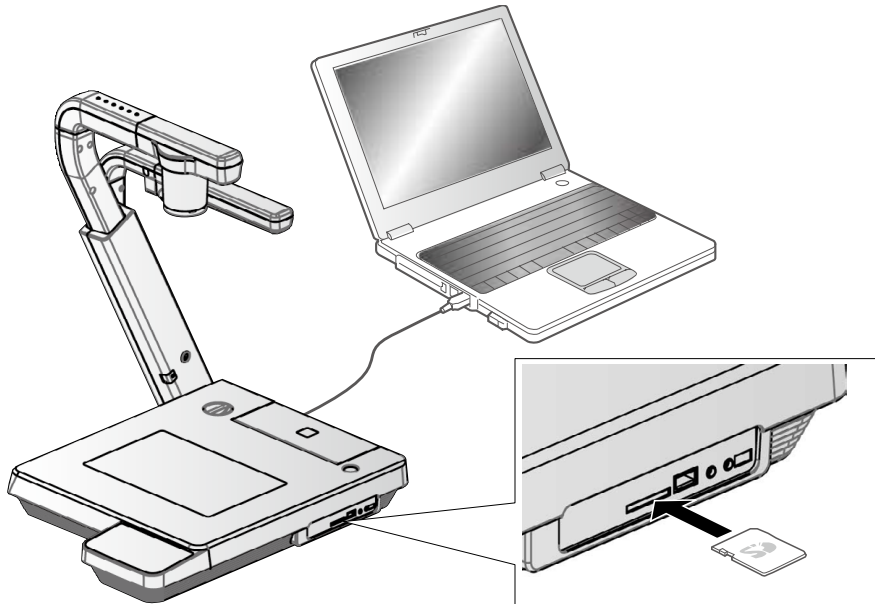
3-3 Saving data stored on an SD card to PC via USB cable



CAUTION

- Tap [ (Settings)] > [] on the touch panel to set to [Mass Storage].
- Insert the SD card with the label facing up. Forcing it into the slot with the wrong side up may cause a malfunction.

By connecting this equipment to a PC via USB, you can save the image data stored on the SD card to the PC.

The operating system (OS) for the connected PC should be Microsoft Windows XP (SP2 or later), Windows Vista, Windows 7 or Windows 8.

- ① Turn on the equipment and the PC.
- ② Connect the equipment to the PC with the supplied USB cable.



Note



- When you connect the equipment to the PC for the first time, the required drivers are installed automatically using the plug-and-play function of Windows. From the second time and thereafter, the drivers are not installed again.

③ The equipment is recognized as a removable disk. You can view the image data on the SD card with the viewer software of the PC.

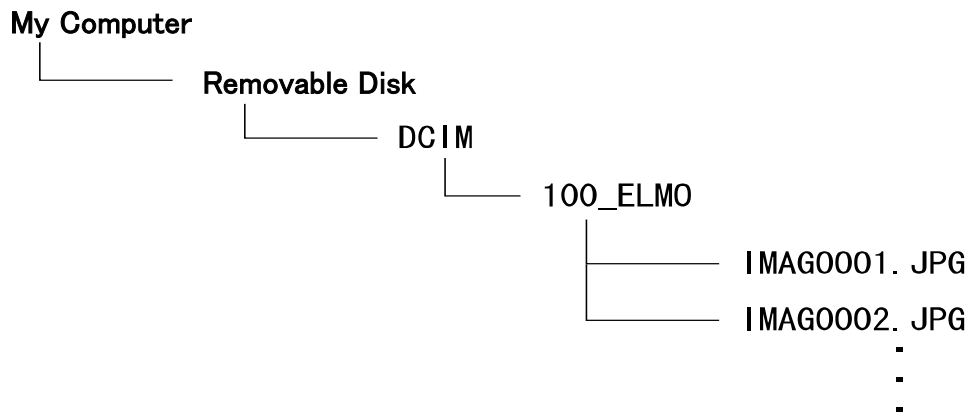
- The image data is stored as JPEG files or MP4 files in the following folders:



CAUTION

- You can not save, delete, lock, unlock, or format the images from the PC.
- The image files are saved with the correct date and time from [Clock setting] .
- Do not connect/disconnect the USB cable while operating the product using the touch panel or remote control. This may cause a malfunction.
- While the product is in the USB-connection mode, do not switch [USB Mode] to another mode by tapping [ (Settings)] > [] on the touch panel.
- We recommend using a USB 2.0-compliant USB cable.





Note

- Depending on the USB environment used by the PC or any peripheral devices, image transfer may be disrupted.
- Operation is not guaranteed for all environments.
- If [USB Mode] has been set to [Mass Storage] and the equipment is connected to the PC, you can not save, delete, lock or unlock the pictures and movies in the SD card or format the SD card using the equipment. (You can do above operations to the files in the USB flash drive).
- Make sure to disconnect the USB cable before switching [USB Mode] from the touch panel.

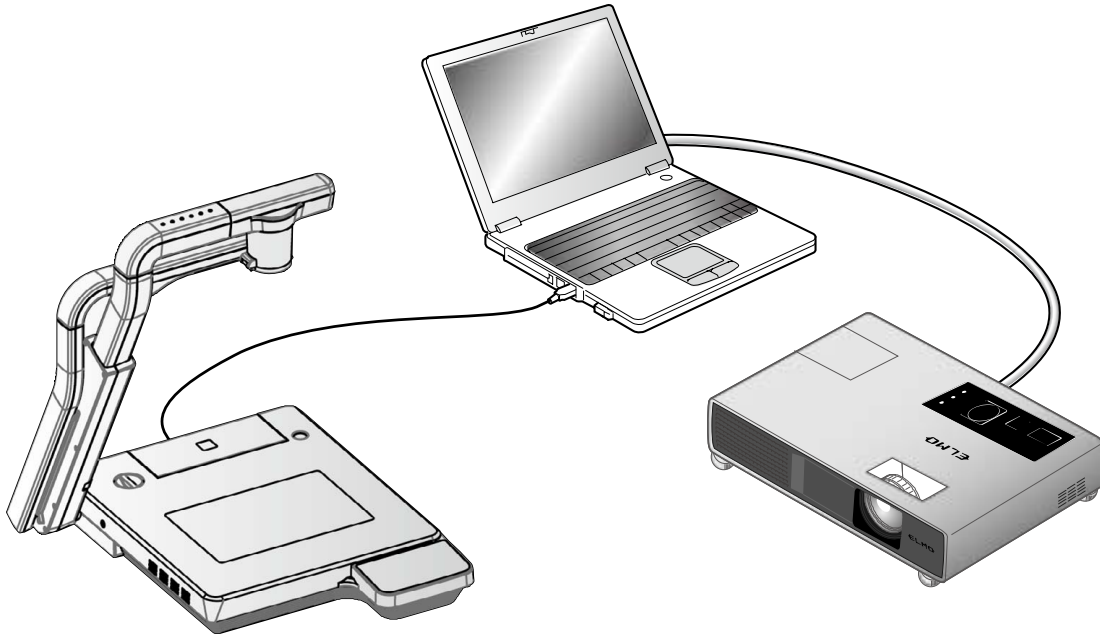
3-4 Presentation using a USB-connected PC with the supplied software



Note

- Tap [ (Settings)] > [] on the touch panel to set to [Application].

“Image Mate” is available from the supplied CD-ROM.

By using the “Image Mate” software for controlling this equipment included in the CD-ROM, you can perform the following tasks:

- Transfer movie/picture data to the PC
- Operate the product from the PC

For information on the requirements of the connected PC, OS types and the software guides, see the “Image Mate” installation manual and the “HELP folder” on the CD-ROM.

CAUTION

- Do not connect/disconnect the USB cable while operating the equipment using the touch panel or remote control. This may cause a malfunction.
- We recommend using a USB 2.0-compliant USB cable.



Note

- Depending on the USB environment used by the PC or any peripheral device, image transfer may be disrupted.
- Operation is not guaranteed for all environments.
- Make sure to disconnect the USB cable before switching [USB Mode] from the touch panel.

3-5 Displaying the Video Image through Network Connection

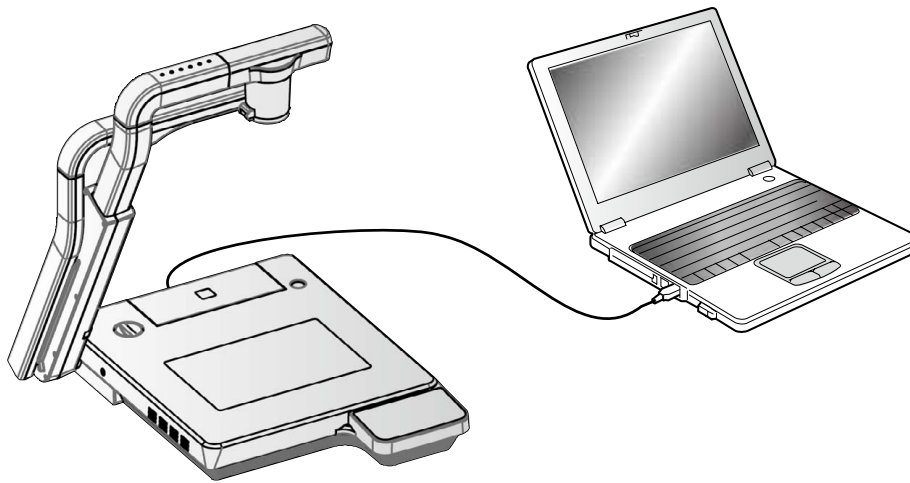

When connection is made to <http://192.168.0.100> on the browser, the device's top page opens. When [50%], [75%] or [100%] of [LIVE] is clicked, the video image is displayed. When [CAPTURE] is clicked, the still image is displayed.

Top page

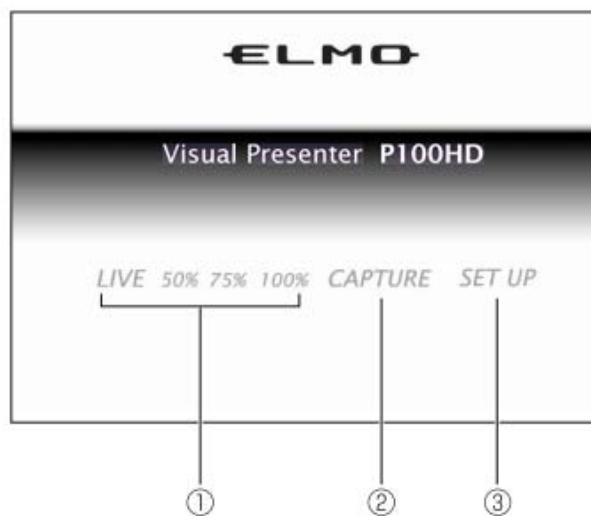

	Name	Function
①	LIVE (Video image display)	To display the video image at 50%, 75% or 100% scale.
②	CAPTURE	To display the still image.
③	SETUP (Ethernet setting)	To display the configurations page.

Live



	Name	Function
①	CONTROL (WEB remote control)	To display the WEB remote control when this item is clicked.

CAUTION

- The Live and Capture can not be displayed during the recording.
- The Live and Capture can not be displayed during the playing movie.
- The Live and Capture can not be displayed while the Compare Picture function is in operation.

WEB remote control

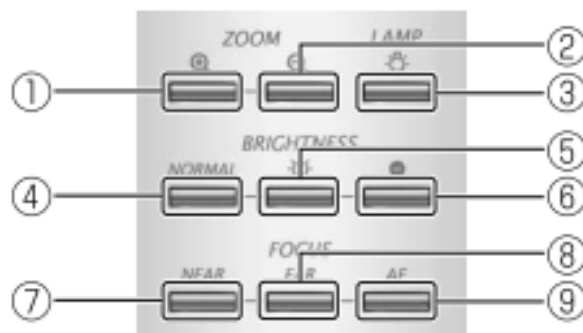

	Name	Function (One-click operation)
①	ZOOM	TELE To zoom in.
②		WIDE To zoom out.

③	LAMP		Toggle between base illumination and → material illumination → both illuminations go out in this order.
④	BRIGHTNESS	NORMAL	Return the automatic brightness adjustment level to the standard level.
⑤		OPEN	Brighten the camera image.
⑥		CLOSE	Darken the camera image.
⑦	FOCUS	NEAR	Move the focus near.
⑧		FAR	Move the focus far.
⑨		AF	Focus the camera automatically.

CONFIGURATIONS

CONFIGURATIONS

Network Configuration

IP address	192.168.0.100
Subnet mask	255.255.255.0
Default gateway	0.0.0.0
Port Number	50000
Root Password	*****

①

②

[TOP](#) — ③

	Name	Function
①	Network Configuration	Display the network configuration page. User name and password need to be entered. (Factory default setting: User name <root> , Password <root>)
②	-	Configuration of the current network.
③	TOP	Display the top Home page.

Network Configuration

Network Configuration

①	IP address	192	.	168	.	0	.	100
②	Subnet mask	255	.	255	.	255	.	0
③	Default gateway	0	.	0	.	0	.	0
④	Port Number	50000						
⑤	Root Password	<input type="text"/> <input type="checkbox"/> Change						

[Configurations](#)

	Name	Function (< >: Factory settings)
①	IP address	IP address information set in this camera system. <192.168.0.100>
②	Subnet mask	<255.255.255.0>
③	Default gateway	Router IP address. <0.0.0.0>
④	Port number	Port number for displaying the Live image. This port number is entered from TCP:49152 to TCP:65535. <TCP:50000>
⑤	Root password	Password for the Network configuration. Up to 15 alphanumeric characters can be entered. <root>
⑥	<input type="checkbox"/> Change	To set or change the password, this check box should be checked. If this check box is checked but nothing is entered in the password edit box, the relevant password information will be cleared.
⑦	Setup	Set to the contents displayed.
⑧	Clear	Reset/clear all edited contents.
⑨	Configurations	Display the configurations page.



Note

- To enable the access to this camera system on the web browser, the PC environment should be as follows:
 - Windows XP (SP2 or later) / Vista / 7 / 8 has been installed.
 - JRE (Java Runtime Environment) 1.6.0_29 or later has been installed, and Java (Sun) is valid.
 - Internet Explorer6 or later has been installed.
- This camera system does not guarantee normal access operation on all web browsers.
- Depending on the version of the OS, the window size may not be set properly and the scroll bar may be displayed.
- Depending on the settings of the Windows or virus check software, loss of connection to the camera and distorted video image, could occur. In this situation, adjust the settings properly following the Windows instruction manual or the virus check software.
- This product uses port HTTP:80 and TCP:50000 (Default setting) for LIVE (Video image display).When this product is connected to a router, firewall, etc., set the port accordingly.
- Live and Capture can not be displayed during SD mode.
Live and Capture can not be displayed during recording.
Live and Capture can not be displayed during play back movie.
Live and Capture can not be displayed while the Compare Picture function is in operation.
- This product can be remote-controlled or the status of this product can be obtained by using the remote control(CGI). For further information such as the commands, contact the dealer from whom you have purchased this product or our branch/office near your location.
- Default setting of the browser address is “http://192.168.0.100”. Set the IP address to be used with the [SET UP] in the Network configuration.
- When the resolution settings are changed, restart the browser.
- Changes made to the network settings of IP address, subnet mask, default gateway, port number or password, become effective after the product is restarted.

3-6 Using [MIC IN] and [AUDIO IN]

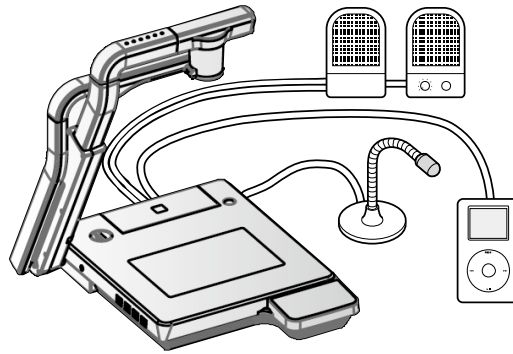

The microphone input and the audio input are mixed and output from [AUDIO OUT]. The microphone input level alone can be adjusted on the touch panel.



Note

Only the microphone for PCs (electret condenser microphone) can be connected to [MIC IN]. If a microphone other than that for PCs is connected to [MIC IN], this camera system could malfunction.

Before connection, carefully check the specifications of the microphone.

3-7 Using the ELMO Wireless Slate/Tablet (CRA-1) with the equipment

By using the separately sold wireless pen tablet with this equipment, you can add comments or draw on camera images directly.

You can also directly perform such operations as zooming in/out.

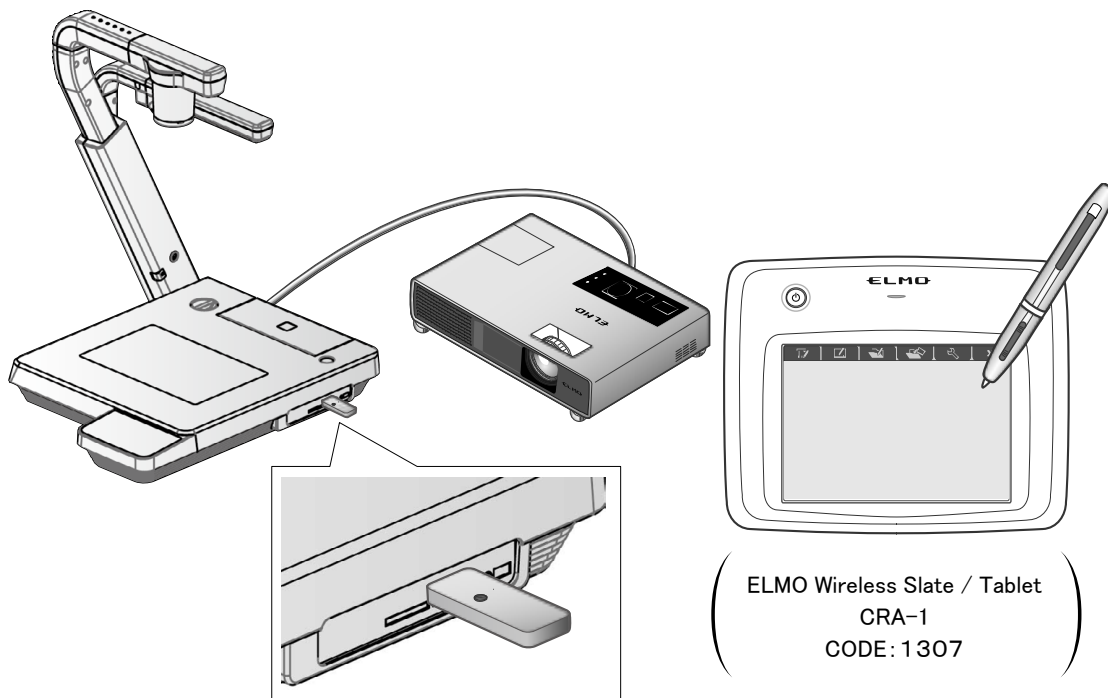

■ Connecting the ELMO Wireless Slate/Tablet (CRA-1)

- ① Set up the equipment as shown in the figure above and connect to the projector. Then turn on the equipment.
- ② Connect the dedicated wireless adapter supplied with the pen tablet to the equipment.
- ③ Turn on the pen tablet.

Note

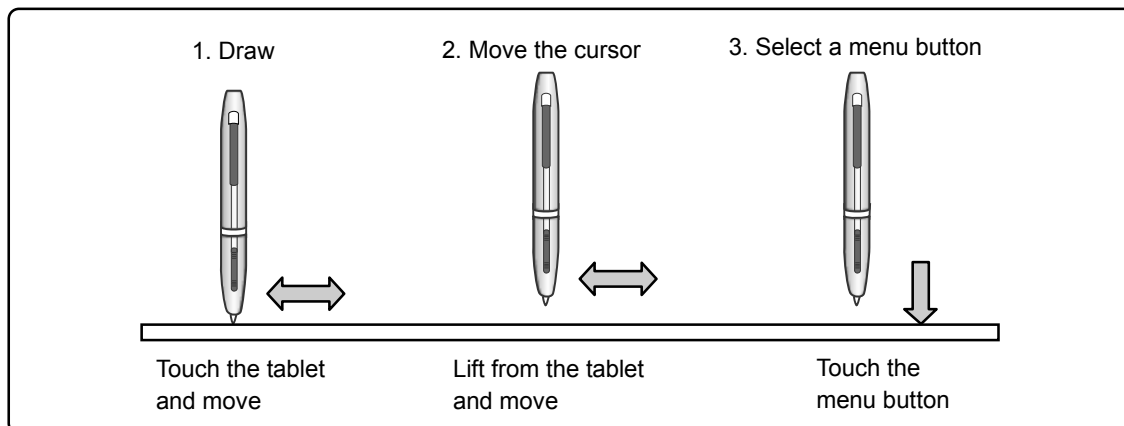

The OSD menu may not be displayed when you connect a tablet while the input is changed. In this case, connect a tablet again after establishing input and select again.

Basic operations



- **Drawing lines**

Touch the tip of the pen to the surface of the tablet and move the pen.

If [ 1] or [ 2] has been selected, the pen will draw a line. Use this function to draw/erase lines.

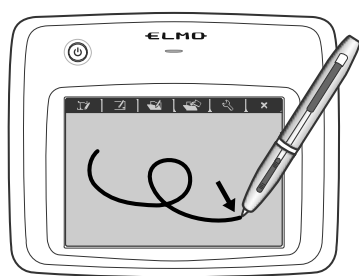

Keep pressed down

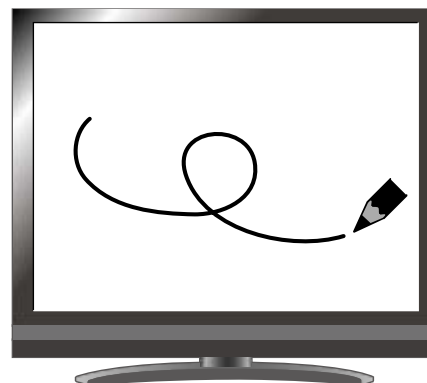

- **Moving the cursor**

Move the pen slightly above the surface of the tablet.

The cursor on the screen moves as the pen moves. Use this function to move the cursor.

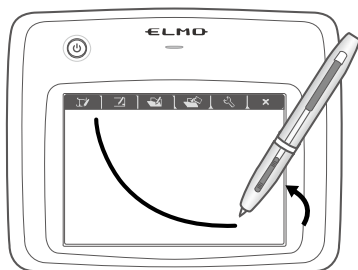

Lift the pen a little



- **Selecting a menu button**

Move the pen slightly above the surface of the tablet to move the cursor and then touch the pen within the working area on the tablet.

Use this function to select a menu button.

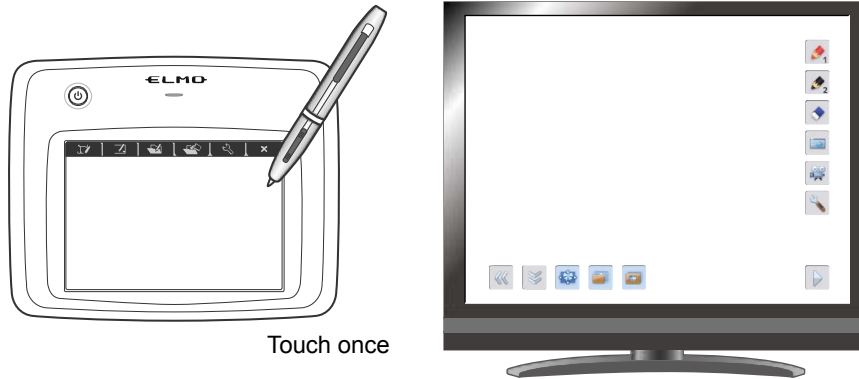

CAUTION

Press the tablet lightly with the pen; do not press hard.



Note

- Hold the pen as upright as possible; holding the pen at an angle may result in a failure of the tablet to recognize the pen.
- If the pen is not used for a while, the power saving mode is activated. Touch the tip to reactivate the pen before you use it again.



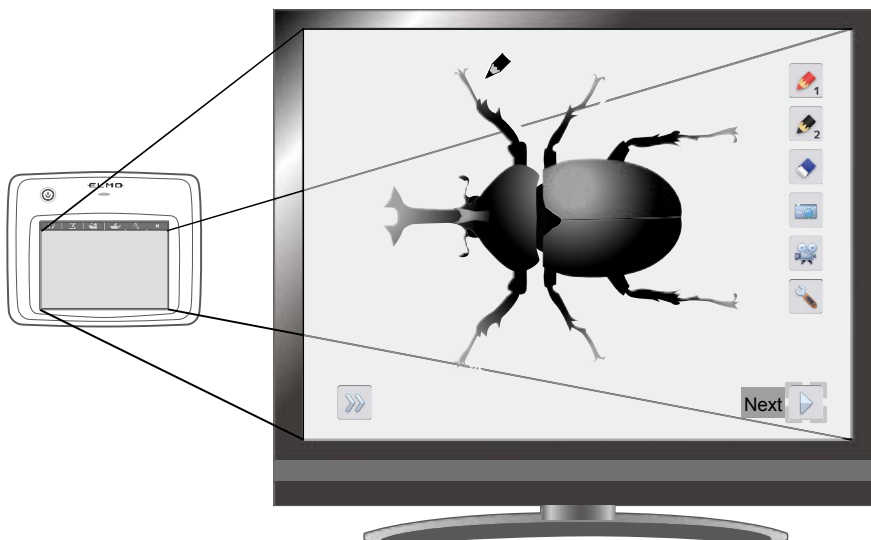



The working area on the tablet corresponds to the whole screen.

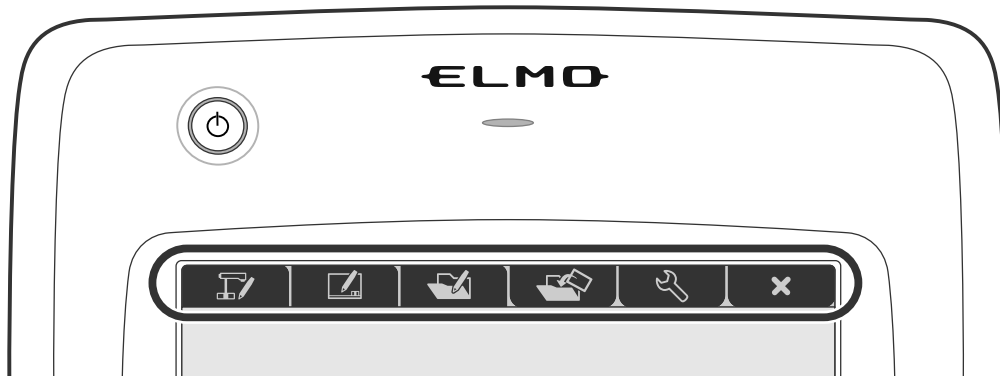

■ Selecting how to use the pen tablet from the tablet menu

To use the pen tablet, touch a function key at the top of the tablet and select a mode according to the situation described in the table below:



Icon	Name	Function
	Write to/work with camera images (Camera Mode)	Display an image on the document camera as a background, and draw on it with the pen tablet.
	Write on a white screen (Whiteboard Mode)	Display a white image as a background, and draw on it using the pen tablet.
	Work with/write to stored data (Play Mode)	Display images stored on the SD card. You can draw on the displayed image only when it is a still picture. You can not draw on a movie with the pen tablet.
		
	Setting	Specify settings for the pen tablet (the settings are common to all modes).
		Change OSD menu show/hide



Note

You can not operate device by the touch panel while using the tablet.

■ Writing to camera images

You can draw on camera images.

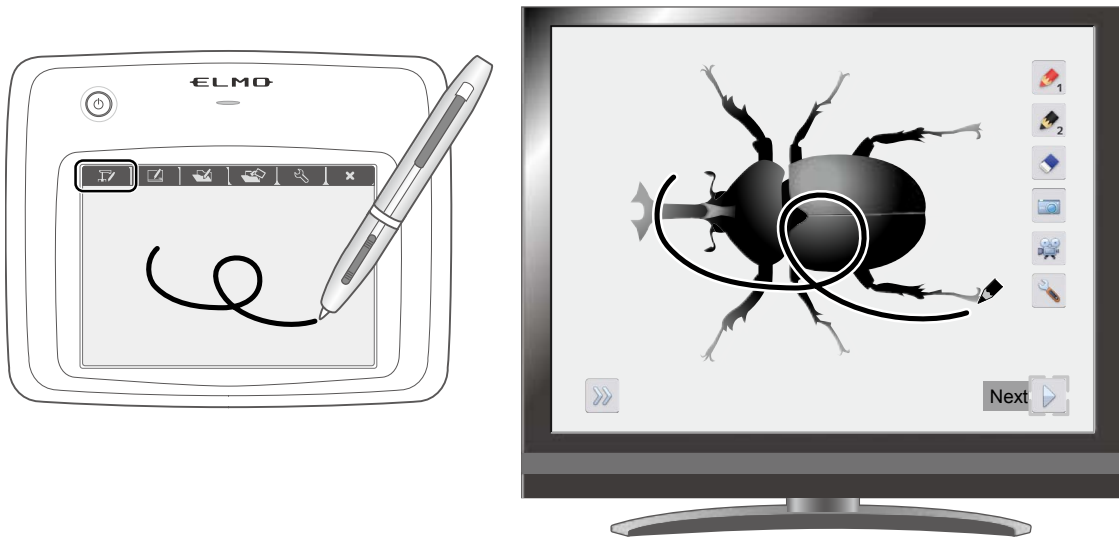





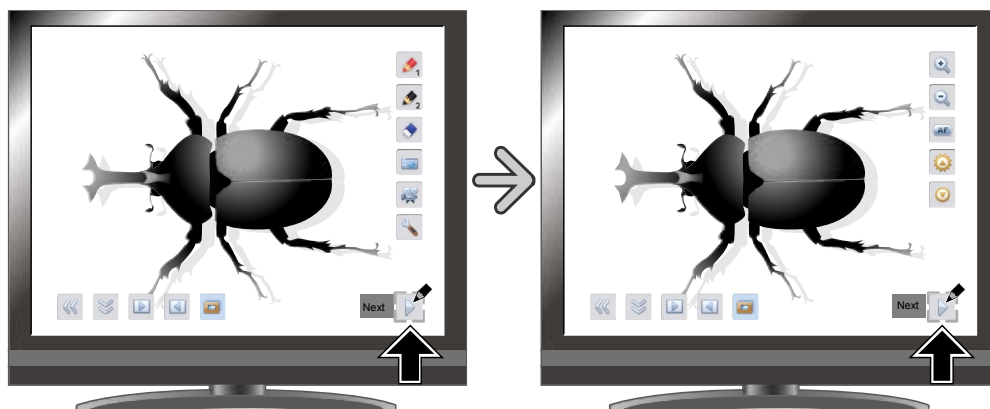
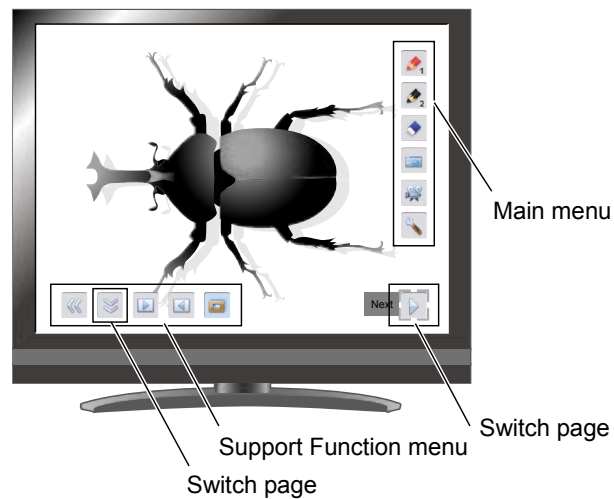

Menu descriptions







Pressing [] or [] switches the menu pages.



Main Menu 1

Icon	Name	Function
	Pen1	Select Pen1. The initial color setting is Red. You can change the settings for the pen in the Setting menu.
	Pen2	Select Pen2. The initial color setting is Black. You can change the settings for the pen in the Setting menu.
	Clear Screen	Erase everything drawn on the screen. If you need to erase a part of a drawing, move the cursor to the section to be erased, and touch the section with the pen while pressing the pen Erase button.
	Capture	Capture the image currently displayed on the screen as a picture and save it on the SD card. This feature captures only the displayed camera image and your comments/drawings; the cursor and menu icons are not captured.
	Rec	Record the image currently displayed on the screen as a movie and save it on the SD card. This does not record the lines drawn with the tablet, the menu icons, or the cursor.
	Setting	Access the settings for Pen and Eraser.
	Next	Go to Main Menu 2.













Main Menu 2

Icon	Name	Function
	Zoom In	Enlarge the size of the camera image.
	Zoom Out	Reduce the size of the camera image.
	AF	Enable autofocus operation.
	Brighten	Brighten the camera image.
	Darken	Darken the camera image.
	Next	Go to Main Menu 1.

Setting Menu

Icon	Name	Selection Item	Default	Function
	Pen1 Color	 Red	↳	Set the pen color to red.
		 Blue		Set the pen color to blue.
		 Black		Set the pen color to black.
	Pen1 Thickness	 Thin		Decrease the pen thickness.
		 Medium	↳	Set the pen thickness to medium width.
		 Thick		Increase the pen thickness.
	Pen2 Color	 Red		Set the pen color to red.
		 Blue		Set the pen color to blue.
		 Black	↳	Set the pen color to black.
	Pen2 Thickness	 Thin		Decrease the pen thickness.
		 Medium	↳	Set the pen thickness to medium width.
		 Thick		Increase the pen thickness.
	Erase Area	 Narrow		Select small erase area.
		 Medium	↳	Select medium erase area.
		 Wide		Select wide erase area.
	Exit			Return to the previous level of menu.

Support Function Menu

Icon	Name	Function
	Show	Show/hide the Support Function Menu.
	Hide	
	Menu	Change Support Function Menu.
	Next Picture	Move to the next picture page.
	Prev Picture	Move to the prev picture page.
	Scroll	Enlarge the image to the size you specify, allowing you to move within the enlarged area.
	Mask	Mask part of the image.
	Highlight	Highlight part of the image you want to emphasize.
	Image Rotation	Rotate a Camera image by 180° in Camera mode. Rotate a still image saved in the SD card by 90° in Playback mode.
	Mosaic	Apply the mosaic effect to the image.
	Compare Picture	<p>When this function is selected while the camera image is displayed, the camera image will be displayed at the left side of the screen and the RGB1-In image will be displayed at the right side of the screen.</p> <p>When this function is selected while a still image is displayed, the camera image will be displayed at the left side of the screen and the still image will be displayed at the right side of the screen.</p> <p>When this function is selected while the external input image is displayed, the camera image will be displayed at the left side of the screen and the external input image will be displayed at the right side of the screen.</p>
	Posi/Nega	Output positive camera images.*
		Output negative camera images.*
	Color/B&W	Output color camera images.*
		Output black and white camera images.*

* : Camera mode only.





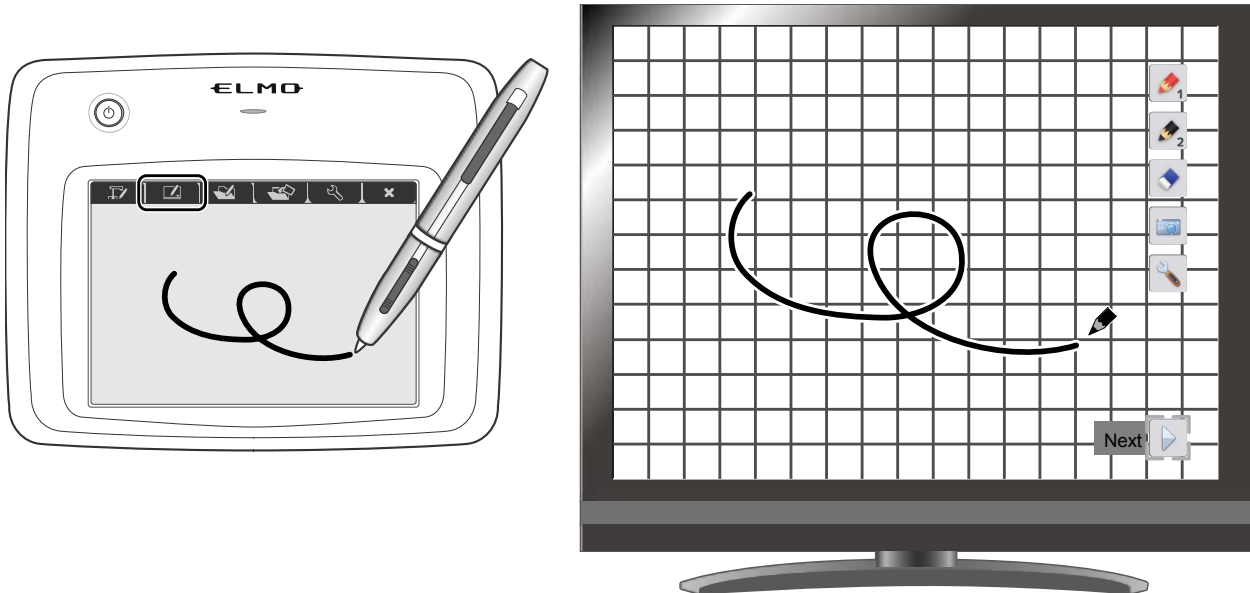

■ Using as a whiteboard

You can draw on any blank white images or areas used as a background.



Menu descriptions

Main Menu

Icon	Name	Function
	Pen 1	Select Pen 1. The initial color setting is Red. You can change the settings for the pen in the Setting menu.
	Pen 2	Select Pen 2. The initial color setting is Black. You can change the settings for the pen in the Setting menu.
	Clear Screen	Erase everything drawn on the screen. If you need to erase a part of a drawing, move the cursor to the section to be erased, and touch the section with the pen while pressing the pen Erase button.
	Capture	Capture the image currently displayed on the screen as a picture and save it to the SD card. This feature captures only the displayed camera image and your comments/drawings; the cursor and menu icons are not captured.
	Setting	Specify the settings for Pen and Eraser.
	Next	

Setting Menu

Icon	Name	Selection Item	Default	Function
	Pen1 Color	 Red	↳	Set the pen color to red.
		 Blue		Set the pen color to blue.
		 Black		Set the pen color to black.
	Pen1 Thickness	 Thin		Decrease the pen thickness.
		 Medium	↳	Set the pen thickness to medium width.
		 Thick		Increase the pen thickness.
	Pen2 Color	 Red		Set the pen color to red.
		 Blue		Set the pen color to blue.
		 Black	↳	Set the pen color to black.
	Pen2 Thickness	 Thin		Decrease the pen thickness.
		 Medium	↳	Set the pen thickness to medium width.
		 Thick		Increase the pen thickness.
	Erase Area	 Narrow		Select small erase area.
		 Medium	↳	Select medium erase area.
		 Wide		Select wide erase area.
	Exit			Return to the previous level of menu.

■ Using the SD card

You can display a picture or movie stored on the SD card and use the tablet to draw or write on it.

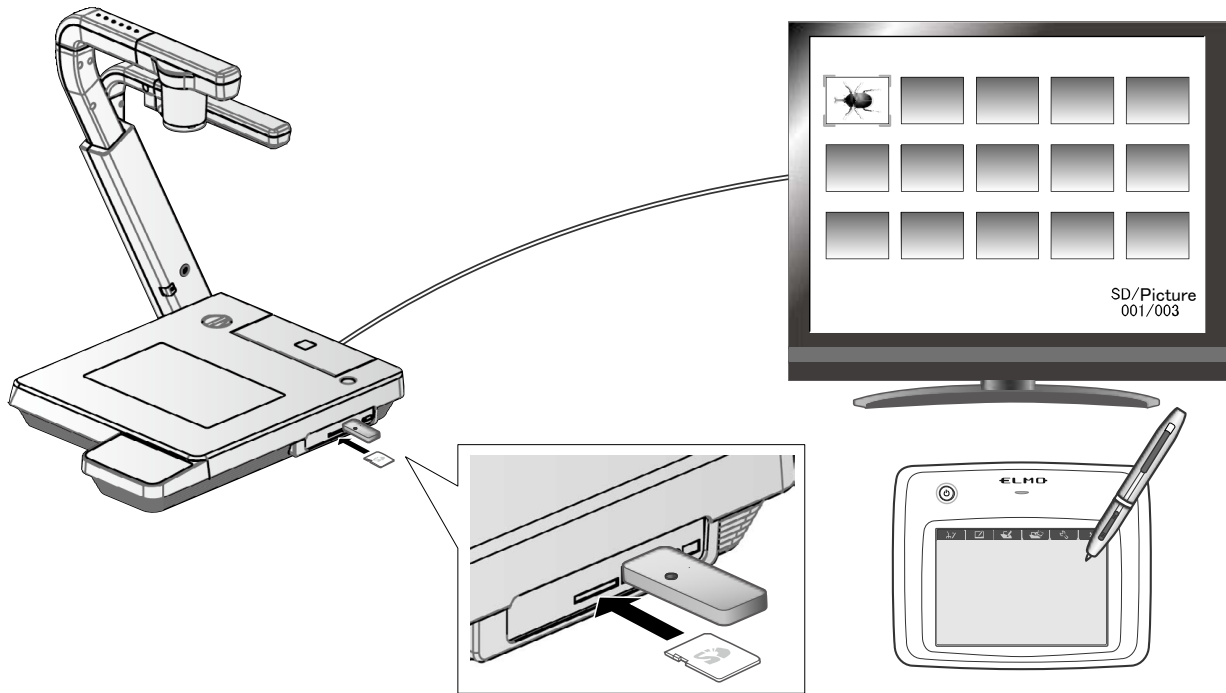

- Thumbnail display

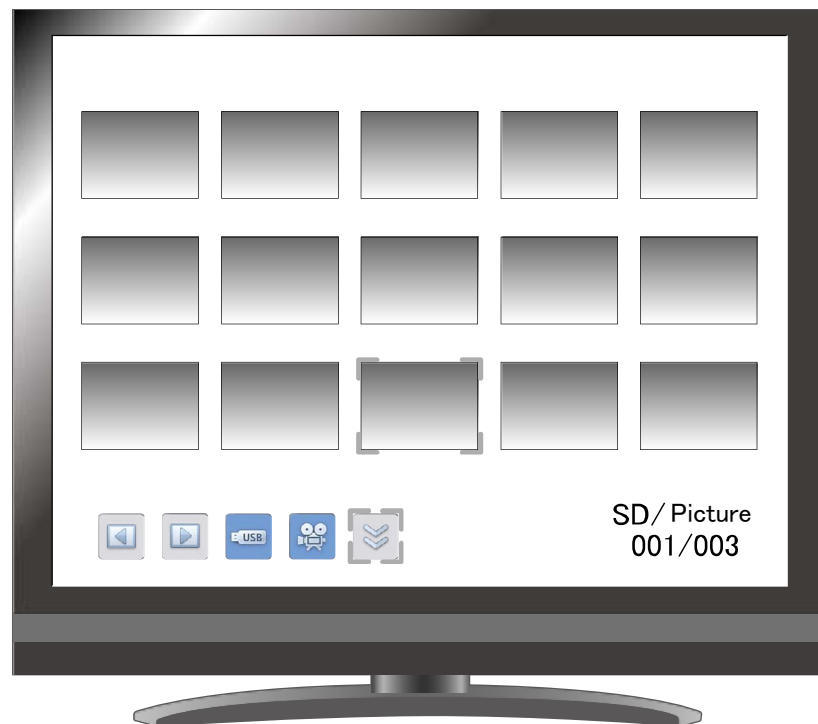



















When you select an image from the thumbnails, the selected image is displayed on the screen.

Menu descriptions







Thumbnail display

Menu







Icon	Name	Selection Item	Function	
	Prev Page		Move to the previous thumbnail page.	
	Next Page		Move to the next thumbnail page.	
	Next Menu		Move to the next menu page.	
	USB Flash Drive			
	Picture		Switch the data displayed as thumbnails between movies and pictures.	
	Movie			
	Memory Lock		Lock/Unlock	Lock (set as protected) or unlock (set as unprotected) the selected image.
			Lock All	Lock (set as protected) all thumbnail images.
			Unlock All	Unlock (set as unprotected) all thumbnail images.
			Exit	Exit the current menu.
	Delete		Yes	Delete the selected image.
			No	Cancel deletion.
			Exit	Exit the current menu.
	Format		Yes	Format the SD card.
			No	Cancel formatting.
			Exit	Exit the current menu.

Single Mode

Picture Display Menu 1

Icon	Name	Function
	Pen 1	Select Pen 1. The initial color setting is Red. You can change the settings for the pen in the Setting menu.
	Pen 2	Select Pen 2. The initial color setting is Black. You can change the settings for the pen in the Setting menu.
	Clear Screen	To erase anything drawn on the screen. If you need to erase a part of a drawing, move the cursor to the section to be erased, and touch the section with the pen while pressing the pen Erase button.
	Capture	Capture the image currently displayed on the screen as a picture and save it to the SD card. This feature captures only the displayed camera image and your comments/drawings; the cursor and menu icons are not captured.
	Setting	Specify the settings for Pen and Eraser.
	Next	Go to Menu 2.













Picture Display Menu 2

Icon	Name	Selection Item	Function
	Delete	 Yes	Delete the image displayed on the screen (You can not delete the image if it is protected).
		 No	Cancel deletion.
		 Exit	Exit the current menu.
	Memory Lock		Lock (set as protected) or unlock (set as unprotected) the selected image.
	Next		Go to Menu 1.

Setting Menu (when Setting Menu is selected)











Icon	Name	Selection Item	Default	Function
	Pen1 Color	 Red	↳	Set the pen color to red.
		 Blue		Set the pen color to blue.
		 Black		Set the pen color to black.
	Pen1 Thickness	 Thin		Decrease the pen thickness.
		 Medium	↳	Set the pen thickness to medium width.
		 Thick		Increase the pen thickness.
	Pen2 Color	 Red		Set the pen color to red.
		 Blue		Set the pen color to blue.
		 Black	↳	Set the pen color to black.
	Pen2 Thickness	 Thin		Decrease the pen thickness.
		 Medium	↳	Set the pen thickness to medium width.
		 Thick		Increase the pen thickness.
	Erase Area	 Narrow		Select small erase area.
		 Medium	↳	Select medium erase area.
		 Wide		Select wide erase area.
	Exit			Return to the previous level of menu.

Support Function Menu

Icon	Name	Function
	Show	Show/hide the Support Function Menu.
	Hide	
	Menu	Change Support Function Menu.
	Next Picture	Move to the next picture page.
	Prev Picture	Move to the prev picture page.
	Scroll	Enlarge the image to the size you specify, allowing you to move within the enlarged area.
	Mask	Mask part of the image.
	Highlight	Highlight part of the image you want to emphasize.
	Image Rotation	Rotate a Camera image by 180° in Camera mode. Rotate a still image saved in the SD card by 90° in Playback mode.
	Mosaic	Apply the mosaic effect to the image.
	Compare Picture	<p>When this function is selected while the camera image is displayed, the camera image will be displayed at the left side of the screen and the RGB1-In image will be displayed at the right side of the screen.</p> <p>When this function is selected while a still image is displayed, the camera image will be displayed at the left side of the screen and the still image will be displayed at the right side of the screen.</p> <p>When this function is selected while the external input image is displayed, the camera image will be displayed at the left side of the screen and the external input image will be displayed at the right side of the screen.</p>
	Posi/Nega	Output positive camera images.*
		Output negative camera images.*
	Color/B&W	Output color camera images.*
		Output black and white camera images.*

* : Camera mode only.

Movie Play Menu

Icon	Name	Function
	Show	Show/hide the Support Function Menu.
	Hide	
	Menu	Change Support Function Menu.
	Play	Play/stop/cue the movie.
	Pause	
	Cueing	
	Up	Set the output audio volume.
	Down	
	Repeat ON	Play the movie on loop.
	Repeat OFF	

3-8 Shooting off the stage

For shooting forward and backward from the camera

- ① Set the camera head in the horizontal direction.

The camera head is adjusted automatically so that the camera image will not be inverted.

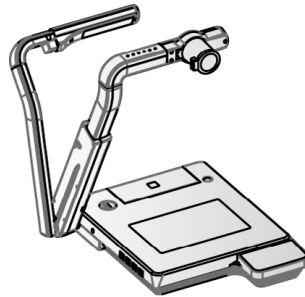



<Forward shooting>



<Backward shooting>



Note

- The camera image can be rotated manually by tapping [ (Presentation)] > [] on the touch panel.

For shooting wall or landscape

- ① Open the close-up lens holder.

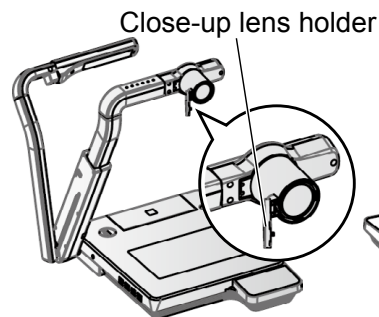

<Forward shooting>

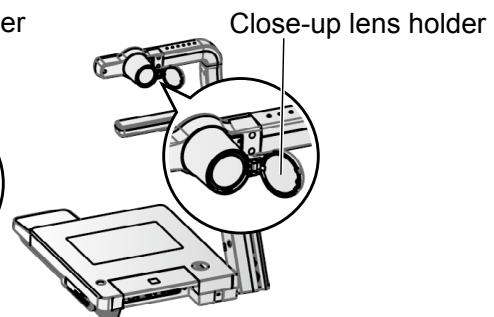

<Backward shooting>

- ② Shoot a wall or landscape.

Shooting range when the close-up lens holder is open

- TELE side (Telescopic) : 500mm - ∞ from the zoom lens
- WIDE side (Wide-angle) : 100mm - ∞ from the zoom lens

CAUTION

Do not fold the camera column without closing the close-up lens holder.
The close-up lens may be damaged.

3-9 About RS-232C

Connection via RS-232C

When the RS-232C port is connected to a PC, the unit can be controlled from a PC.



Note





For the information of RS-232C command, etc., contact the sales outlet from which you have purchased this camera system or the nearest branch office or sales office of ours.

4

TROUBLE SHOOTING

4-1 Symptoms and Confirmation

Check the following items. If any abnormality is found, consult the dealer from whom you purchased this product or our nearest branch/office.

Symptom	Possible cause/ remedy
No image is displayed.	<ul style="list-style-type: none"> • The cable is not correctly connected. • The AC adapter is disconnected from the wall outlet. • The AC adapter is disconnected from the power supply socket of the unit. • The power is not ON. (Blue light) • Zoom is set at the TELE side, displaying only the white/black part of the document. • If you turn the power ON immediately after turning it OFF, the unit may not start. Wait for several seconds after turning the power OFF, and then turn it back ON. • The slide switch is not set to the correct image output (RGB/HDMI). Set the “RGB/HDMI Switch” correctly. • Reconnect the AC adapter.
The output image (resolution) changes automatically.	<ul style="list-style-type: none"> • When the HDMI monitor is connected, the output image (resolution) is automatically changed based on information from the connected monitor.
No image is displayed from the USB.	<ul style="list-style-type: none"> • No image is output from USB when USB mode is set to mass Storage or in Play mode or in Recording mode or when using the Compare Picture Function. Switch the USB mode from Mass Storage to Application by referring to [ (Setting)] > [] on the touch panel. When using Play mode, change the output image to Camera image.
The image is out of focus.	<ul style="list-style-type: none"> • The document (object) is too close to the lens. Move the document (object) slightly away from the lens. • Auto focus may have difficulty in adjusting correctly. Focus on an image manually by referring to “Manual focus”.
The image is too dark.	<ul style="list-style-type: none"> • The intensity of the lighting is insufficient. Tap [ (Main menu)] > [] on the touch panel or press the [] button on the remote control to adjust the brightness.

Symptom	Possible cause/ remedy
The image is striped.	<ul style="list-style-type: none"> • This may be interference fringes between dots of printed matter and TV scanning lines or CMOS pixels. Changing the shooting range may help the problem. • Vertical stripes may appear on an LCD projector image. Manually adjusting the dot clock at the projector side may help the problem.
Images on the SD card/ USB flash drive are not displayed.	<ul style="list-style-type: none"> • Remove the SD card/USB flash drive, wait a few seconds and reinsert.
The image does not move.	<ul style="list-style-type: none"> • Camera image is set to [Pause]. Press the Pause button on the operating panel again to restart.
The remote control does not work.	<ul style="list-style-type: none"> • Battery power is low. Replace the batteries with new ones. • The incorrect remote control is being used. Use the supplied remote control.
After inserting the SD card/USB flash drive, operations cannot be performed.	<ul style="list-style-type: none"> • The SD card/USB flash drive is not being read correctly. Use the SD card/USB flash drive after formatting it twice as described below. First, format the card using a computer. Second, format the card using the main unit.
Drawing speed of the tablet is too slow.	<ul style="list-style-type: none"> • Drawing speed may become slow depending on the resolution setting of the unit. This is not a malfunction.
The touch panel does not operate correctly.	<ul style="list-style-type: none"> • Please be sure not to touch panel in more than one point at a time.
The external mic is not heard.	<ul style="list-style-type: none"> • Adjust the volume by a touch panel. Or adjust the volume in the outside connection apparatus side. • Please confirm that "an outside microphone" has been selected.
The network function does not operate.	<ul style="list-style-type: none"> • Reconfirm this camera system and the network configuration of the PC to be connected to this camera system, and then, cross-check them with the settings described below. • Reconfirm the restrictive conditions (e.g., number of connections) and the setting details of this camera system, as well.
The network operation is unstable.	<ul style="list-style-type: none"> • The WEB connection works only in the following environment: <ol style="list-style-type: none"> 1. The OS installed is Microsoft WindowsXP (SP2 or later /Vista/7/8. 2. 1.6.0_29 or newer has been installed and Java (Sun) is valid. 3. Internet Explorer6 or 7 has been installed.

Symptom	Possible cause/ remedy
The LAN cable cannot be connected.	<ul style="list-style-type: none"> The LAN connector (RJ45) is located on the back side of main unit.
The LAN connector link lamp (green LED) cannot light up.	<ul style="list-style-type: none"> Power is not supplied to this camera system or the unit to be connected to this camera system. Check whether the cable is connected firmly, and then turn ON the power supply. The cable is disconnected. Check the connection between the cable terminals. The cable used is wrong. When the unit to be connected to this camera system is a PC, "cross cable" or "LAN cross cable (attached to this camera system)" is used, and when it is a hub or router, "straight cable" is used. The specifications of the unit should be checked.
Connection from the client is impossible.	<ul style="list-style-type: none"> The IP address of this camera system has not been designated. Designate the IP address set in the camera system. The IP address of the client is not compatible with the network of this camera system. To establish the connection from the client to this camera system, the network address (Subnet mask : 255, 255, 255, 0, IP address : 192.168.0.* when camera system settings are default) should be the same between the client and this camera system. <ul style="list-style-type: none"> * When you forget the IP address of this unit, it goes back to default setting by initial setting (Reset All), and please reboot. The router settings are wrong. Check the network configuration of this camera system and the client, and set the router accordingly.
The network configuration page cannot be accessed.	<ul style="list-style-type: none"> The authority "user" was used for login. Use the authority "root" for login.
Image capture through the network is impossible.	<ul style="list-style-type: none"> Camera mode is not enabled. The camera image cannot be captured in the SD mode. [PAUSE] is working in the camera mode.
The set time is reset	<ul style="list-style-type: none"> The clock setting will be reset automatically after a long period of non-operation. Then you will need to perform the clock setting again. After the clock setting is performed, connect the AC adapter and leave the product for over 6 hours to charge the battery for the clock.

About the lamp (LED lamp)

The brightness of the lamp will diminish with long-term use. If its brightness has significantly diminished, consult the dealer from whom you purchased the product or our nearest branch/office for replacement.

About long-term usage of this product

Due to the lifetime of its parts, if the product is used for longer than the warranty period, its performance and quality may deteriorate. In this case, we will replace the parts for a charge. Consult the dealer from whom you purchased the product or our nearest branch/office.

5

SPECIFICATIONS

5-1 General

Item	Specifications
Power source	12VDC (AC adapter AC100 - 240V)
Power consumption	26.4W
Outside dimensions	W457×D519×H587mm(W18.0 x D20.5 x H23.2 in)(When setup)
	W457×D567×H137mm(W18.0 x D22.4 x H5.4 in)(When folded)
Weight	Approx. 7.9kg(15.7 lbs) (Main body only)
Input selection	Main / External × 4
Output terminal	RGB output Mini Dsub 15P connector, female × 1
	HDMI output terminal Type A × 1
	Line Out terminal Φ3.5mm stereo minijack × 2
Input terminal	RGB input Mini Dsub 15P connector, female × 2
	HDMI input terminal Type A × 2
	Mic In/Line In terminal (shared) Φ3.5mm stereo minijack × 1
	Line In terminal Φ3.5mm stereo minijack × 2
Ext. control terminal	USB device (2.0 compliant) Mini B receptacle × 1
	RS-232C D-SUB 9P connector, male × 1
	Ethernet RJ45 connector × 1
Memory interface	SD card slot × 1
	USB host (2.0 compliant) Type A receptacle × 1

•Line input

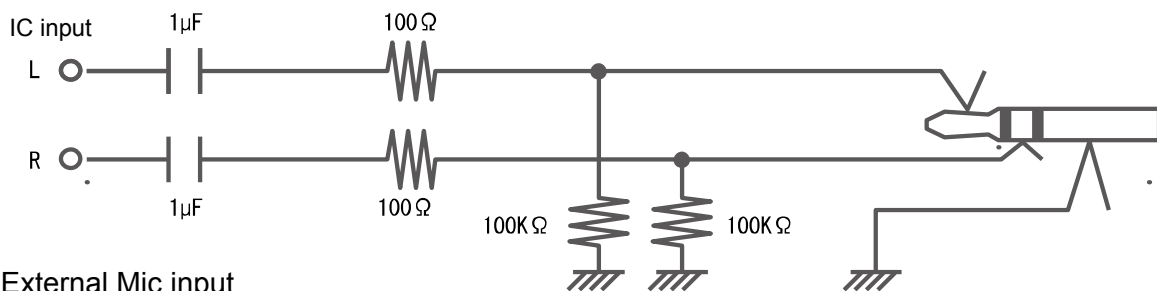

•External Mic input

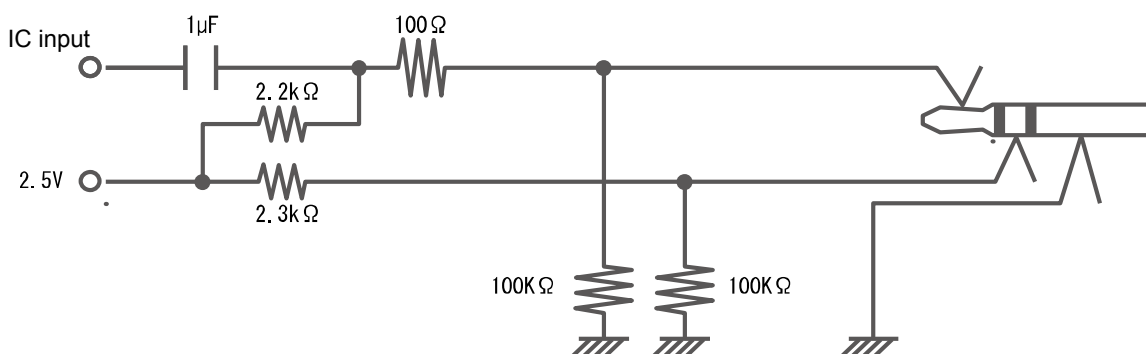

5-2 Main Camera

Item	Specifications					
Lens	f=4.9mm ~ 78.4mm(16x zoom) F2.7					
Frame rate	30fps					
Shooting area			Max.		Min.	
	1080p	400mm	223mm	27mm	15mm	
	720p	400mm	223mm	27mm	15mm	
	SXGA	400mm	320mm	27mm	22mm	
	WXGA	400mm	248mm	27mm	17mm	
	XGA	400mm	299mm	27mm	20mm	
Limit of focus adjustment	With close-up lens TELE side (Telescopic) : 250mm - 440mm from the close-up lens WIDE side (Wide-angle) : 90mm - 440mm from the close-up lens					
	Without close-up lens TELE side (Telescopic) : 500mm - ∞ from the zoom lens surface WIDE side (Wide-angle) : 100mm - ∞ from the zoom lens surface					
Optical zoom	16X					
Digital zoom	8X					
Focus	Auto/Manual/Zoom Sync					
Image pick-up element	1/2.8" CMOS					
Total pixels	Horizontal 2144, Vertical 1588					
Effective pixels	Horizontal 1920, Vertical 1536					
Synchronized signal	Internal					
Resolution	Analog RGB Horizontal 800TV lines or more Vertical 800TV lines or more					
Analog RGB output	Analog RGB output 0.7 V (p-p) 75 Ω unbalanced Synchronized signal		SXGA: 1280x1024@60Hz Horizontal frequency: 63.981kHz Vertical frequency: 60.020Hz WXGA: 1280x800@60Hz Horizontal frequency: 49.702kHz Vertical frequency: 59.810Hz XGA: 1024x768@60Hz Horizontal frequency: 48.363kHz Vertical frequency: 60.004Hz 1080p: 1920x1080@60Hz Horizontal frequency: 67.50kHz Vertical frequency: 60.00Hz			
	SXGA : Positive polarity WXGA : Horizontal negative polarity, Vertical positive polarity XGA : Negative polarity 1080p : Positive polarity 720p : Positive polarity					

		720p: 1280x720@60Hz Horizontal frequency: 45.00kHz Vertical frequency: 60.00Hz
HDMI output	Image output 1080p 720p	
	Audio output PCM 44.1kHz sampling frequency	
White Balance	Auto/One-Push/Manual	
Brightness Control	Auto (W/Level adjustment)/Manual	
Posi/Nega conversion	Provided	
Color/B&W selection	Provided	
Image rotation	Provided (0°/180°)	
Image Mode	Text1/Text2/Text3/ Graphics1/Graphics2	
Gamma setting	Provided (Only for graphic mode)	
Edge Effect	Provided (Only for graphic mode)	
Pause	Provided	
Still Image storage	Provided	
Movie storage	Provided	
Flicker connection	60Hz/50Hz	

5-3 Illumination Device

Item	Specifications
Upper light, Base light	White LED

5-4 Trademarks and License

ELMO and Image Mate are registered trademarks of ELMO Co., Ltd.

SD, SDHC,  (SD logo) and  (SDHC logo) are trademarks of SD-3C, LLC.

HDMI, **HDMI**[™] logo and High-Definition Multimedia interface are trademarks or registered trademarks of HDMI Licensing LLC.

This product is based on the work of the Independent JPEG Group.

All other company/ product names described in this manual are trademarks or registered trademarks of their respective companies.

This product is licensed under the AVC Visual Patent Portfolio License (AVC Video), for the personal and a non-commercial use of a consumer to

- (i) Play AVC Video that was recorded by a consumer engaged in a personal and a non-commercial activity and/or,
- (ii) Play AVC Video that was obtained from a video provider licensed from MPEG-LA and LLC

and it admitted to use only in personal and a non-commercial purpose.

- When you play AVC Video recorded by the personal and non-commercial purpose.
- When you play AVC Video offered by the provider licensed from MPEG-LA, LLC to provide AVC Video.

Additional information including that relating to promotional and commercial uses may be obtained from MPEG-LA, LLC.

WARNING

Unauthorized recording of copyrighted slide films, materials, photographs, etc. may infringe on the rights of copyright owners and be contrary to copyright laws.

ELMO CO., LTD. 6-14, Meizen-cho, Mizuho-ku, Nagoya, 467-8567, Japan

OVERSEAS SUBSIDIARY COMPANIES

ELMO USA CORP.

Headquarters 1478 Old Country Road
Plainview, NY 11803, U.S.A.
Tel. (516) 501-1400 Fax.(516) 501-0429
E-mail: elmo@elmousa.com
Web: <http://www.elmousa.com>

West Coast Branch 5676 Corporate Avenue
Cypress, CA 90630, U.S.A.
Tel. (714) 828-8457 Fax. (714) 823-8429

ELMO Europe SAS

Headquarters Immeuble Elysées La Défense,
7C, Place du Dôme,
92056 Paris La Défense, France
Tel. 33 (0) 1 73 02 67 06 Fax. 33 (0) 1 73 02 67 10
E-mail: info@elmoeurope.fr
Web: <http://www.elmoeurope.com>

German Branch

Hansaallee 201, Haus 1
40549 Düsseldorf Germany
Tel. 49 (0) 211 544756 40 Fax. 49 (0) 211 544756 60

6X1VHND2_R1-Xex