



MS521/MX522/MW523/MS511H/TW523
Digital Projector
User Manual

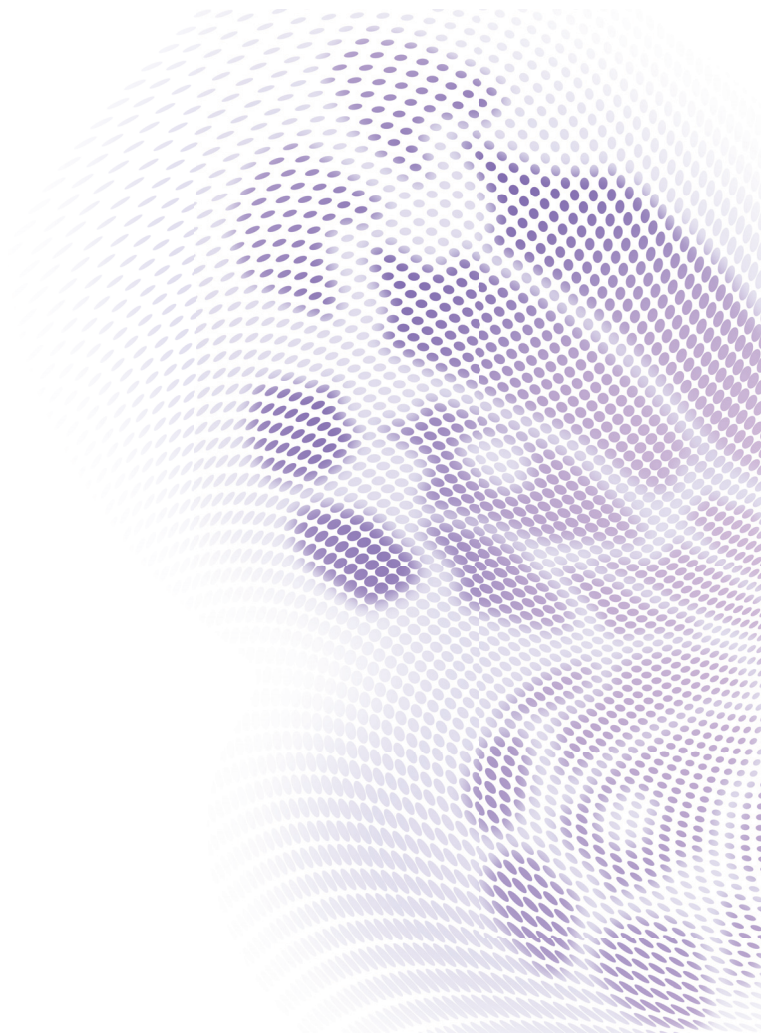

Table of contents

Important safety

instructions 3

Introduction..... 7

Projector features.....7

Shipping contents8

Projector exterior view.....9

Positioning your

projector 15

Choosing a location..... 15

Obtaining a preferred projected image size..... 16

Connection 18

Connecting a computer or monitor... 19

Connecting Video source devices.....20

Operation 24

Starting up the projector24

Adjusting the projected image25

Using the menus.....28

Securing the projector29

Switching input signal32

Magnifying and searching for details ...33

Selecting the aspect ratio33

Optimizing the image35

Setting the presentation timer39

Remote paging operations40

Hiding the image.....41

Freezing the image.....41

Operating in a high altitude environment.....42

Adjusting the sound.....42

Use Teaching Template43

Personalizing the projector menu display44

Select the lamp saver mode 44

Shutting down the projector 45

Menu operation 46

Maintenance 59

Care of the projector 59

Lamp information 60

Troubleshooting..... 68

Specifications..... 69

Dimensions 70

Ceiling mount installation 70

Timing chart..... 71

Warranty and Copyright

information..... 78

Important safety instructions

Your projector is designed and tested to meet the latest standards for safety of information technology equipment. However, to ensure safe use of this product, it is important that you follow the instructions mentioned in this manual and marked on the product.

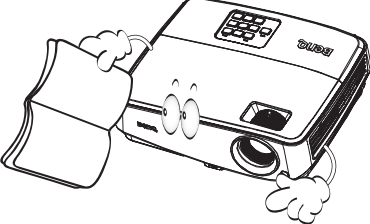
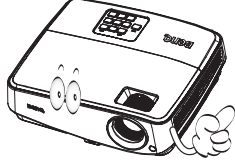
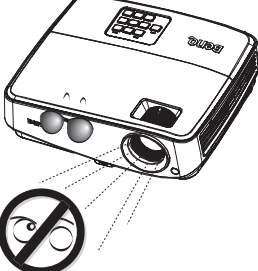
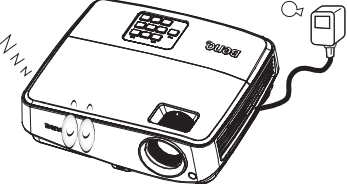
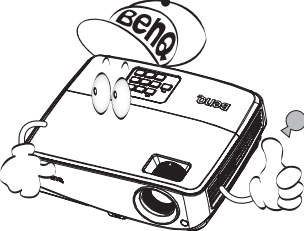
Safety Instructions	
<p>1. Please read this manual before you operate your projector. Save it for future reference.</p>	<p>4. Always open the lens shutter or remove the lens cap when the projector lamp is on.</p>
	
<p>2. Do not look straight at the projector lens during operation. The intense light beam may damage your eyes.</p>	<p>5. In some countries, the line voltage is NOT stable. This projector is designed to operate safely within a mains voltage between 100 to 240 volts AC, but could fail if power cuts or surges of ± 10 volts occur. In areas where the mains voltage may fluctuate or cut out, it is recommended that you connect your projector through a power stabilizer, surge protector or uninterruptible power supply (UPS).</p>
	
<p>3. Refer servicing to qualified service personnel.</p>	<p>6. Do not block the projection lens with any objects when the projector is under operation as this could cause the objects to become heated and deformed or even cause a fire.</p>
	

Safety Instructions (Continued)

7. The lamp becomes extremely hot during operation. Allow the projector to cool for approximately 45 minutes prior to removing the lamp assembly for replacement.

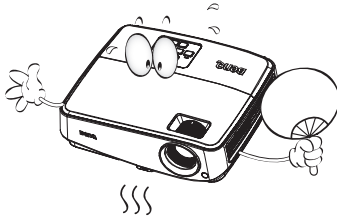

8. Do not operate lamps beyond the rated lamp life. Excessive operation of lamps beyond the rated life could cause them to break on rare occasions.

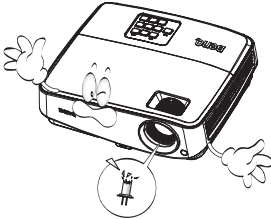

9. Never replace the lamp assembly or any electronic components unless the projector is unplugged.

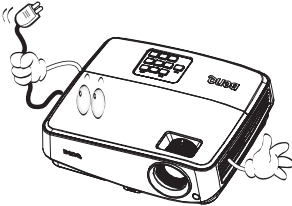

10. Do not place this product on an unstable cart, stand, or table. The product may fall, sustaining serious damage.

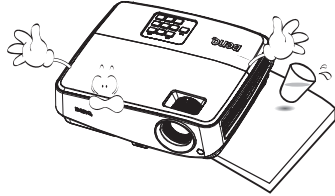

11. Do not attempt to disassemble this projector. There are dangerous high voltages inside which may cause death if you should come into contact with live parts. The only user serviceable part is the lamp which has its own removable cover. Under no circumstances should you ever undo or remove any other covers. Refer servicing only to suitably qualified professional service personnel.

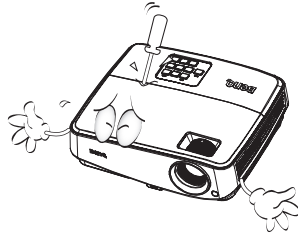

12. When the projector is under operation, you may sense some heated air and odor from its ventilation grill. It is a normal phenomenon and not a product defect.

Safety Instructions (Continued)

13. Do not place this projector in any of the following environments.
- Space that is poorly ventilated or confined. Allow at least 50 cm clearance from walls and free flow of air around the projector.
 - Locations where temperatures may become excessively high, such as the inside of a car with all windows rolled up.
 - Locations where excessive humidity, dust, or cigarette smoke may contaminate optical components, shortening the projector's life span and darkening the image.

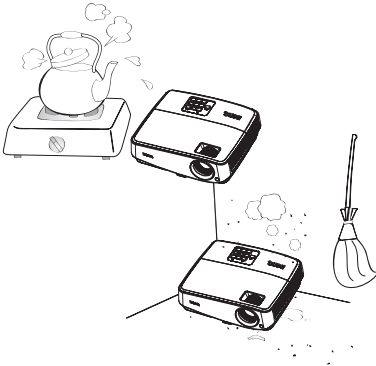

- Locations near fire alarms
- Locations with an ambient temperature above 40°C / 104°F
- Locations where the altitudes are higher than 3000 m (10000 feet).

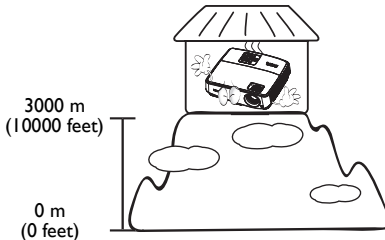

14. Do not block the ventilation holes.
- Do not place this projector on a blanket, bedding or any other soft surface.
 - Do not cover this projector with a cloth or any other item.
 - Do not place inflammables near the projector.

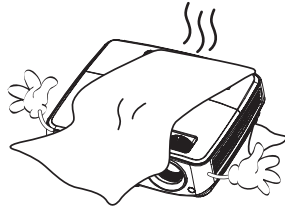

If the ventilation holes are seriously obstructed, overheating inside the projector may result in a fire.

15. Always place the projector on a level, horizontal surface during operation.
- Do not use if tilted at an angle of more than 10 degrees left to right, nor at angle of more than 15 degrees front to back. Using the projector when it is not fully horizontal may cause a malfunction of, or damage to, the lamp.

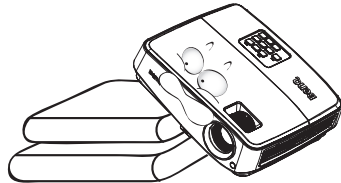

Safety Instructions (Continued)

16. Do not stand the projector on end vertically. Doing so may cause the projector to fall over, causing injury or resulting in damage to the projector.

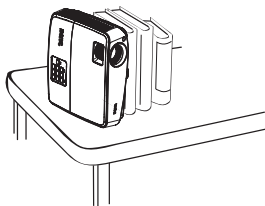

17. Do not step on the projector or place any objects upon it. Besides probable physical damage to the projector, doing so may result in accidents and possible injury.

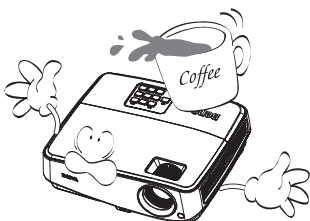

18. Do not place liquids near or on the projector. Liquids spilled into the projector may cause it to fail. If the projector does become wet, disconnect it from the power supply's wall socket and call BenQ to have the projector serviced.

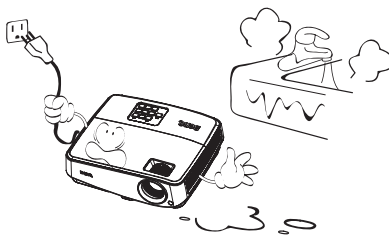

19. This product is capable of displaying inverted images for ceiling mount installation.

 **Use only BenQ's Ceiling Mount Kit for mounting the projector and ensure it is securely installed.**

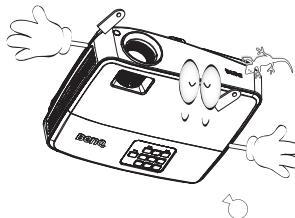

Introduction

Projector features

This model is one of the best projectors available in the world. You can enjoy the best performance video quality with up to 300-inch projection across various devices such as PC, laptop, DVD and VCR even document camera to bring all possibility to life.

The projector offers the following features

- **SmartEco™ starts your dynamic power saving**
SmartEco™ technology saves lamp power consumption up to 80% depending on the content brightness level when SmartEco mode is selected
 - **Longest hours lamp life with SmartEco™ technology**
SmartEco™ technology increases the lamp life hours when selecting SmartEco mode to lower the power consumption
 - **ECO BLANK saves 80% of lamp power**
Pressing the ECO BLANK bottom to immediately hide the image, lowering 80% of the lamp power at the same time your image is hiding
 - **Less than 0.5W in standby condition**
Less than 0.5W power consumption under standby mode
 - **Filter Free**
Filter free design to lower maintenance and operating costs.
 - **One-key auto-adjustment**
Pressing AUTO on the keypad or remote control to show the best picture quality immediately
 - **Quick Cooling, Auto Power Off, Direct Power On**
Quick Cooling function speeds up the cooling process when turning off the projector. Auto Power Off function allows the projector to turn off automatically if no input signal is detected after a set period of time. Direct Power On turns your projector when the power is fed.
 - **Instant Restart**
Selectable Instant Restart function enables you to restart the projector immediately within 90 seconds after turning it off.
 - **3D Function supported**
Various 3D formats make the 3D function more flexible. By presenting the depth of the images, you can wear BenQ 3D goggled to enjoy the 3D movies, videos and sporting events in a more realistic way.
-  • **The apparent brightness of the projected image will vary depending on the ambient lighting conditions, selected input signal contrast/brightness settings, and is proportional to projection distance.**
- **The lamp brightness will decline over time and may vary within the lamp manufacturers specifications. This is normal and expected behavior.**

Shipping contents

Carefully unpack and verify that you have all of the items shown below. If any of these items are missing, please contact your place of purchase.

Standard accessories

 The supplied accessories will be suitable for your region, and may differ from those illustrated.

*The warranty card is only supplied in some specific regions. Please consult your dealer for detailed information.

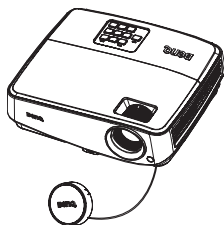

Projector

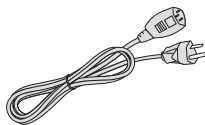

Power cord

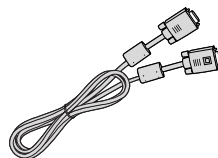

VGA cable



Quick start guide



User manual CD



Warranty card*

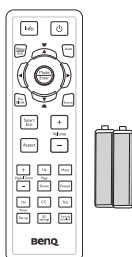

Remote control with battery

Optional accessories

1. Spare lamp kit
2. Ceiling mount kit
3. Carry bag
4. 3D glasses
5. Presentation plus

Projector exterior view

Front/upper side

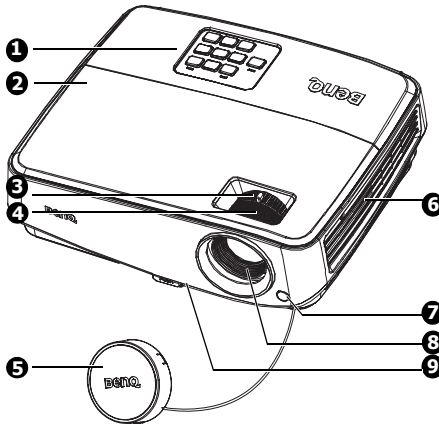

Rear/lower side

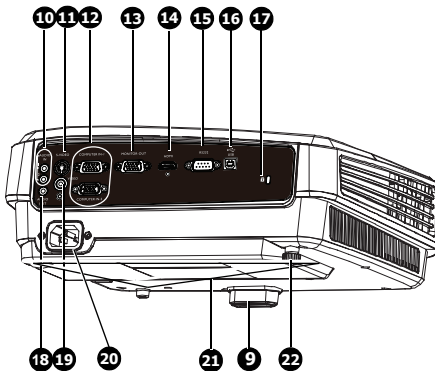

1. External control panel
(See "Projector" on page 10 for details.)
2. Lamp cover
3. Zoom ring
4. Focus ring
5. Lens cover
6. Vent (heated air exhaust)
7. Front IR remote sensor
8. Projection lens
9. Quick-release button
10. Audio input jack
11. S-Video input jack
12. RGB (PC)/Component video (YPbPr/ YCbCr) signal input jack
13. RGB signal output jack
14. HDMI input jack
15. RS-232 control port
16. USB input jack
17. Kensington anti-theft lock slot
18. Audio output jack
19. Video input jack
20. AC power cord inlet
21. Ceiling mount holes
22. Rear adjuster foot

Controls and functions

Projector

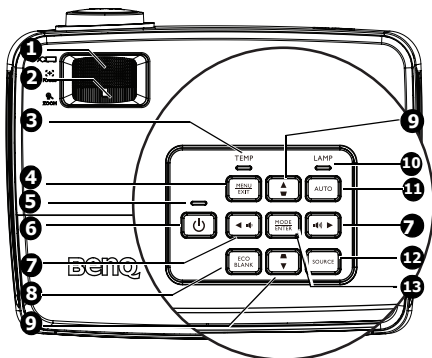

1. **Focus ring**
Adjusts the focus of the projected image. See ["Fine-tuning the image size and clarity" on page 26](#) for details.
2. **Zoom ring**
Adjusts the size of the image. See ["Fine-tuning the image size and clarity" on page 26](#) for details.
3. **TEMP(temperature) warning light**
Lights up red if the projector's temperature becomes too high. See ["Indicators" on page 66](#) for details.
4. **MENU/EXIT**
Turns on the On-Screen Display (OSD) menu. Goes back to previous OSD menu, exits and saves menu settings.
5. **POWER indicator light**
Lights up or flashes when the projector is under operation. See ["Indicators" on page 66](#) for detail.
6. **POWER**
Toggles the projector between standby mode and on. See ["Starting up the projector" on page 24](#) and ["Shutting down the projector" on page 45](#) for details.
7. **Volume /Arrow keys (Left, Right)**
Adjusts the sound level.
When the On-Screen Display (OSD) menu is activated, the #7 and #9 keys are used as directional arrows to select the desired menu items and to make adjustments. See ["Using the menus" on page 28](#) for details.
8. **ECO BLANK**
Used to hide the screen picture. See ["Hiding the image" on page 41](#) for details.
9. **Keystone/Arrow keys (Up, Down)**
Manually corrects distorted images resulting from an angled projection. See ["Correcting keystone" on page 27](#) for details.
10. **LAMP indicator light**
Indicates the status of the lamp. Lights up or flashes when the lamp has developed a problem. See ["Indicators" on page 66](#) for details.
11. **AUTO**
Automatically determines the best picture timings for the displayed image. See ["Auto-adjusting the image" on page 25](#) for details.
12. **SOURCE**
Displays the source selection bar. See ["Switching input signal" on page 32](#) for details.
13. **MODE/ENTER**
Selects an available picture setup mode. See ["Selecting a picture mode" on page 35](#) for details.
Activates the selected On-Screen Display (OSD) menu item. See ["Using the menus" on page 28](#) for details.

Ceiling mounting the projector

We want you to have a pleasant experience using your BenQ projector, so we need to bring this safety matter to your attention to prevent possible damage to person and property.

If you intend to mount your projector on the ceiling, we strongly recommend that you use a proper fitting BenQ projector ceiling mount kit and that you ensure it is securely and safely installed.

If you use a non-BenQ brand projector ceiling mount kit, there is a safety risk that the projector may fall from the ceiling due to an improper attachment through the use of the wrong gauge or length screws.

You can purchase a BenQ projector ceiling mount kit from the place you purchased your BenQ projector. BenQ recommends that you also purchase a separate Kensington lock compatible security cable and attach it securely to both the Kensington lock slot on the projector and the base of the ceiling mount bracket. This will perform the secondary role of restraining the projector should its attachment to the mounting bracket become loose.

Remote control

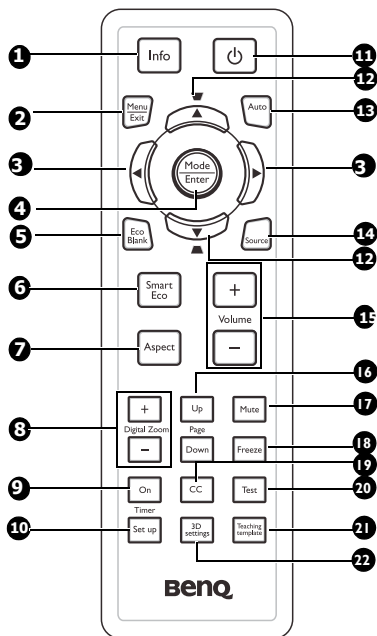

1. **Info**
Showing the status information of the projector.
2. **Menu/Exit**
Turns on the On-Screen Display (OSD) menu. Goes back to previous OSD menu, exits and saves menu settings.
See ["Using the menus" on page 28](#) for details.
3. **◀ Left/▶ Right**
When the On-Screen Display (OSD) menu is activated, the #3 and #12 keys are used as directional arrows to select the desired menu items and to make adjustments. See ["Using the menus" on page 28](#) for details.
4. **Mode/Enter**
Selects an available picture setup mode.
See ["Selecting a picture mode" on page 35](#) for details.
Activates the selected On-Screen Display (OSD) menu item. See ["Using the menus" on page 28](#) for details.

5. **Eco Blank**
Press the Eco Blank button to turn off the image for a period of time with 70% lamp power saving. Press again to restore the image. See ["Hiding the image" on page 41](#) for details.
6. **SmartEco**
Displays the lamp mode selection bar (Normal/Economic/SmartEco/LampSave).
7. **Aspect**
Selects the display aspect ratio. See ["About the aspect ratio" on page 34](#) for details.
8. **Digital Zoom keys (+, -)**
Magnifies or reduces the projected picture size. See ["Magnifying and searching for details" on page 33](#) for details.
9. **Timer On**
Activates or displays an on-screen timer based on your own timer setting. See ["Setting the presentation timer" on page 39](#) for details.
10. **Timer Setup**
Enters presentation timer setting directly. See ["Setting the presentation timer" on page 39](#) for details.
11. **Power**
Toggles the projector between standby mode and on. See ["Starting up the projector" on page 24](#) and ["Shutting down the projector" on page 45](#) for details.
12. **Keystone/Arrow keys (◀ /▲ Up, ▼ Down)**
Manually corrects distorted images resulting from an angled projection. See ["Correcting keystone" on page 27](#) for details.
13. **Auto**
Automatically determines the best picture timings for the displayed image. See ["Auto-adjusting the image" on page 25](#) for details.

- 14. Source**
Displays the source selection bar. See ["Switching input signal" on page 32](#) for details.
- 15. Volume +/-**
Adjusts the sound level. See ["Adjusting the sound" on page 42](#) for details.
- 16. Page Up/Down**
Page up/down arrows when connected through USB to a PC. See ["Remote paging operations" on page 40](#) for details.
- 17. Mute**
Toggles projector audio between on and off.
- 18. ||/▶ Freeze**
Freezes the projected image. See ["Freezing the image" on page 41](#) for details.
- 19. CC**
Display the video term description on screen which is provided for hard-of-hearing viewers.
- 20. Test**
Displays the test pattern. See ["Use build-in test pattern" on page 26](#) for details.
- 21. Teaching Template**
Displays the selectable bar for teachers choosing the template as his/her suitable teaching background. See ["Use Teaching Template" on page 43](#) for details.
- 22. 3D setting**
Activates the 3D On-Screen Display (OSD) menu item.

Infra-Red (IR) remote control sensor is located on the front of the projector. The remote control must be held at an angle within 15 degrees perpendicular to the projector's IR remote control sensor to function correctly. The distance between the remote control and the sensor should not exceed 8 meters (~ 26 feet).

Make sure that there are no obstacles between the remote control and the IR sensor on the projector that might obstruct the infra-red beam.

- **Operating the projector from the front**

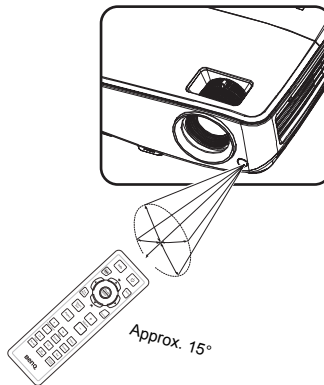

Replacing the remote control battery

1. To open the battery cover, turn the remote control over to view its back, push on the finger grip on the cover and slide it up in the direction of the arrow as illustrated. The cover will slide off.
2. Remove any existing batteries (if necessary) and install two AAA batteries observing the battery polarities as indicated in the base of the battery compartment. Positive (+) goes to positive and negative (-) goes to negative.
3. Refit the cover by aligning it with the base and sliding it back down into position. Stop when it clicks into place.

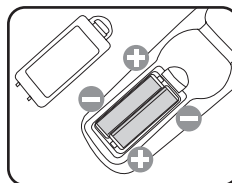
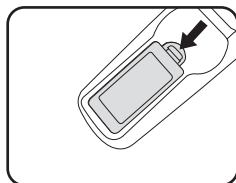

- **Avoid excessive heat and humidity.**
- **There may be battery damage if the battery is incorrectly replaced.**
- **Replace only with the same or equivalent type recommended by the battery manufacturer.**
- **Dispose of the used battery according to the battery manufacturer's instructions.**
- **Never throw a battery into a fire. There may be danger of an explosion.**
- **If the battery is dead or if you will not be using the remote control for a long time, remove the battery to prevent damage to the remote control from possible battery leakage.**

Positioning your projector

Choosing a location

Your room layout or personal preference will dictate which installation location you select. Take into consideration the size and position of your screen, the location of a suitable power outlet, as well as the location and distance between the projector and the rest of your equipment.

Your projector is designed to be installed in one of four possible installation locations:

1. Front Table

Select this location with the projector placed near the floor in front of the screen. This is the most common way to position the projector for quick setup and portability.

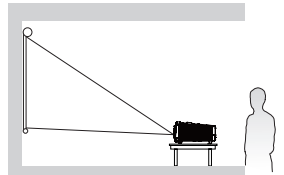

2. Front Ceiling

Select this location with the projector suspended upside-down from the ceiling in front of the screen.

Purchase the BenQ Projector Ceiling Mounting Kit from your dealer to mount your projector on the ceiling.

Set **Front Ceiling** in the **SYSTEM SETUP: Basic > Projector Installation** menu after you turn the projector on.

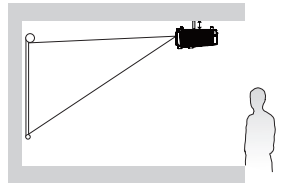

3. Rear Table

Select this location with the projector placed near the floor behind the screen.

Note that a special rear projection screen is required.

Set **Rear Table** in the **SYSTEM SETUP: Basic > Projector Installation** menu after you turn the projector on.

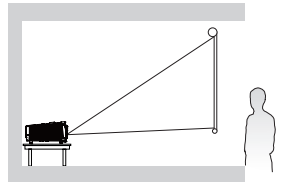

4. Rear Ceiling

Select this location with the projector suspended upside-down from the ceiling behind the screen.

Note that a special rear projection screen and the BenQ Projector Ceiling Mounting Kit are required for this installation location.

Set **Rear Ceiling** in the **SYSTEM SETUP: Basic > Projector Installation** menu after you turn the projector on.

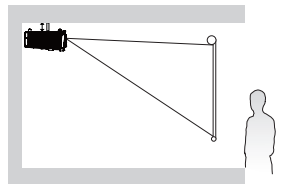

Obtaining a preferred projected image size

The distance from the projector lens to the screen, the zoom setting (if available), and the video format each factors in the projected image size.

Projection dimensions

Refer to "Dimensions" on page 70 for the center of lens dimensions of this projector before calculating the appropriate position.

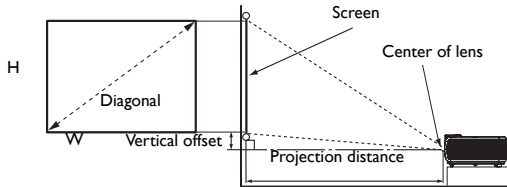

MS521/MX522/MS511H

The screen aspect ratio is 4:3 and the projected picture is 4:3

Screen size		Projection distance (mm)		Vertical offset (mm)			
Diagonal		W (mm)	H (mm)		Min distance (max. zoom)	Average	Max distance (min. zoom)
Inch	mm						
30	762	610	457	1200	1260	1320	69
40	1016	813	610	1600	1680	1760	91
50	1270	1016	762	2000	2100	2200	114
60	1524	1219	914	2400	2520	2640	137
80	2032	1626	1219	3200	3360	3520	183
100	2540	2032	1524	4000	4200	4400	229
120	3048	2438	1829	4800	5040	5280	274
150	3810	3048	2286	6000	6300	6600	343
200	5080	4064	3048	8000	8400	8800	457
220	5588	4470	3353	8800	9240	9680	503
250	6350	5080	3810	10000	10500	11000	572
300	7620	6096	4572	12000	12600	13200	686

For example, if you are using a 120-inch screen, the average projection distance is 5040 mm and with a vertical offset of 274 mm.

If your measured projection distance is 5.0 m (5000 mm), the closest match in the "Projection distance (mm)" column is 5040 mm. Looking across this row shows that a 120" (about 3.0 m) screen is required.

MW523/TW523

The screen aspect ratio is 16:10 and the projected picture is 16:10

Screen size				Projection distance (mm)			Vertical offset (mm)
Diagonal		W (mm)	H (mm)	Min distance (max. zoom)	Average	Max distance (min. zoom)	
Inch	mm						
30	762	646	404	963	1060	1157	50
40	1016	862	538	1284	1413	1542	67
60	1524	1292	808	1926	2119	2313	101
80	2032	1723	1077	2567	2826	3084	135
100	2540	2154	1346	3209	3532	3856	168
120	3048	2585	1615	3851	4239	4627	202
150	3810	3231	2019	4814	5299	5783	252
200	5080	4308	2692	6419	7065	7711	337
250	6350	5385	3365	8023	8831	9639	421
300	7620	6462	4039	9628	10597	11567	505

For example, if you are using a 120-inch screen, the average projection distance is 4239 mm and with a vertical offset of 202 mm.

If your measured projection distance is 5.0 m (5000 mm), the closest match in the "Projection distance (mm)" column is 5299 mm. Looking across this row shows that a 150" (about 4.0 m) screen is required.



All measurements are approximate and may vary from the actual sizes.

BenQ recommends that if you intend to permanently install the projector, you should physically test the projection size and distance using the actual projector in situ before you permanently install it, so as to make allowance for this projector's optical characteristics. This will help you determine the exact mounting position so that it best suits your installation location.

Connection

When connecting a signal source to the projector, be sure to:

1. Turn all equipment off before making any connections.
2. Use the correct signal cables for each source.
3. Ensure the cables are firmly inserted.



In the connections shown below, some cables may not be included with the projector (see "Shipping contents" on page 8). They are commercially available from electronics stores.

- For detailed connection methods, see pages 19-23.
- For the combination of an active audio in source, see the marks in the illustration.

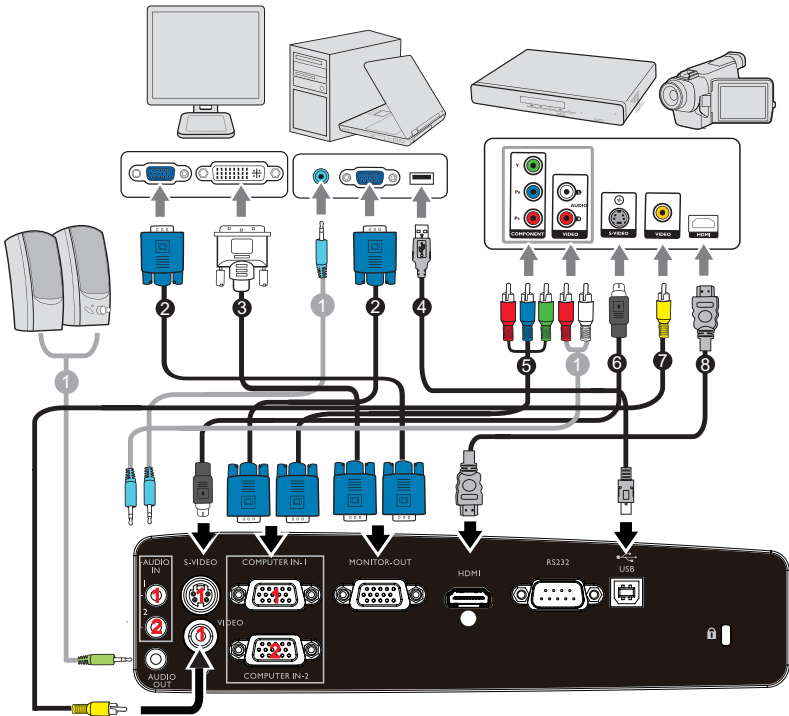

1. Audio Cable	5. Component Video to VGA (DSub) adapter cable
2. VGA cable	6. S-Video cable
3. VGA to DVI-A cable	7. Video cable
4. USB Cable	8. HDMI cable

Connecting a computer or monitor

Connecting a computer

The projector can connect to both IBM® compatibles and Macintosh® computers. A Mac adapter is needed if you are connecting legacy version Macintosh computers.

To connect the projector to a notebook or desktop computer:

1. Take the supplied VGA cable and connect one end to the D-Sub output socket of the computer.
2. Connect the other end of the VGA cable to the **COMPUTER IN-1** or **COMPUTER IN-2** signal input jack on the projector.
3. If you wish to make use of the projector speaker(s) in your presentations, take a suitable audio cable and connect one end of the cable to the audio output jack of the computer, and the other end to the **AUDIO** jack of the projector. When you connect audio output signal from a computer, please balance out the volume control bar to obtain an optimal sound effects.

 Many notebooks do not turn on their external video ports when connected to a projector. Usually a key combo like FN + F3 or CRT/LCD key turns the external display on/off. Locate a function key labeled CRT/LCD or a function key with a monitor symbol on the notebook. Press FN and the labeled function key simultaneously. Refer to your notebook's documentation to find your notebook's key combination.

Connecting a monitor

If you want to view your presentation close-up on a monitor as well as on the screen, you can connect the **MONITOR-OUT** signal output jack on the projector to an external monitor following the instructions below:

To connect the projector to a monitor:





1. Connect the projector to a computer as described in "[Connecting a computer](#)" on [page 19](#).
2. Take a suitable VGA cable (only one supplied) and connect one end of the cable to the D-Sub input jack of the video monitor.
Or if your monitor is equipped with a DVI input jack, take a VGA to DVI-A cable and connect the DVI end of the cable to the DVI input jack of the video monitor.
3. Connect the other end of the cable to the **MONITOR-OUT** jack on the projector.

 • The output signal for **MONITOR-OUT** jack only works when the input signal comes from **COMPUTER IN-1** or **COMPUTER IN-2** jack. When the projector is powered on, the output signal from **MONITOR-OUT** jack varies depending on the input signal from **COMPUTER IN-1** or **COMPUTER IN-2** jack.

• If you wish to use this connection method when the projector is in standby mode, make sure the **Standby Monitor Out** function is turned on in the **SYSTEM SETUP: Advanced** menu. See "[Standby Settings](#)" on [page 57](#) for details.

Connecting Video source devices

You need only connect the projector to a Video source device using just one of the above connecting methods, however each provides a different level of video quality. The method you choose will most likely depend upon the availability of matching terminals on both the projector and the Video source device as described below:

Terminal name	Terminal appearance	Reference	Picture quality
HDMI	HDMI 	"Connecting a HDMI source device" on page 21	Best
Component Video	COMPUTER 	"Connecting a Component Video source device" on page 22	Better
S-Video	S-VIDEO 	"Connecting an S-Video/composite source device" on page 23	Good
Video	VIDEO 		Normal

Connecting a HDMI source device

The projector provides a HDMI input jack that allows you to connect it to a HDMI source device like a DVD player, a DTV tuner or a display.

HDMI (High-Definition Multimedia Interface) supports uncompressed video data transmission between compatible devices like DTV tuners, DVD players and displays over a single cable. It provides pure digital viewing and listening experience.

Examine your Video source device to determine if it has a set of unused HDMI output jacks available:

- If so, you can continue with this procedure.
- If not, you will need to reassess which method you can use to connect to the device.

To connect the projector to a HDMI source device:

1. Take a HDMI cable and connect one end to the HDMI output jack of the HDMI source device. Connect the other end of the cable to the HDMI signal input jack on the projector. Once connected, the audio can be controlled by the projector On-Screen Display (OSD) menus. See "[Audio Settings](#)" on page 56 for details..
2. Connect the other end of the HDMI cable to the **HDMI** jack on the projector.



- **If the selected video image is not displayed after the projector is turned on and the correct video source has been selected, check that the Video source device is turned on and operating correctly. Also check that the signal cables have been connected correctly.**
- **In the unlikely event that you connect the projector to a DVD player via the projector's HDMI input and the projected picture displays wrong colors, please change the color space to YUV. See "[Changing Color Space](#)" on page 32 for details.**

Connecting a Component Video source device

Examine your Video source device to determine if it has a set of unused Component Video output jacks available:

- If so, you can continue with this procedure.
- If not, you will need to reassess which method you can use to connect to the device.

To connect the projector to a Component Video source device:

1. Take a Component Video to VGA (D-Sub) adaptor cable and connect the end with 3 RCA type connectors to the Component Video output jacks of the Video source device. Match the color of the plugs to the color of the jacks; green to green, blue to blue, and red to red.
2. Connect the other end of the Component Video to VGA (D-Sub) adaptor cable (with a D-Sub type connector) to the **COMPUTER IN-1** or **COMPUTER IN-2** jack on the projector.
3. If you wish to make use of the projector speaker(s) in your presentations, take a suitable audio cable and connect one end of the cable to the audio output jack of the device, and the other end to the **AUDIO** jack of the projector.



- **If the selected video image is not displayed after the projector is turned on and the correct video source has been selected, check that the Video source device is turned on and operating correctly. Also check that the signal cables have been connected correctly.**

Connecting an S-Video/composite source device

Examine your Video source device to determine if it has an unused S-Video/composite output jack available:

- If it has both jacks, use the S-Video output jack for connection as the S-Video terminal provides better picture quality than the Video terminal.
- If it has either of the output jack, you can also continue with this procedure.
- If not, you will need to reassess which method you can use to connect to the device.

To connect the projector to an S-Video/Video source device:

1. Take an S-Video/Video cable and connect one end to the S-Video/Video output jack of the Video source device.
2. Connect the other end of the S-Video/Video cable to the **S-Video/ Video** jack on the projector.
3. If you wish to make use of the projector speaker(s) in your presentations, take a suitable audio cable and connect one end of the cable to the audio output jack of the device, and the other end to the **AUDIO** jack of the projector.



- **If the selected video image is not displayed after the projector is turned on and the correct video source has been selected, check that the Video source device is turned on and operating correctly. Also check that the signal cables have been connected correctly.**

Operation

Starting up the projector

1. Plug the power cord into the projector and into a power outlet. Turn on the power outlet switch (where fitted). Check that the **POWER indicator light** on the projector lights orange after power has been applied.



- Please use the original accessories (e.g. power cable) only with the device to avoid possible dangers such as electric shock and fire.

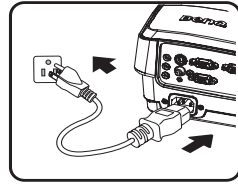

- If Direct power on function is activated in the **SYSTEM SETUP: Basic > Operation Settings** menu, the projector will turn on automatically after the power cord has been connected and power has been applied. See "**Direct Power On**" on page 55 for details.
2. Remove the lens cap. If it is closed, it could become deformed due to the heat produced by the projection lamp.

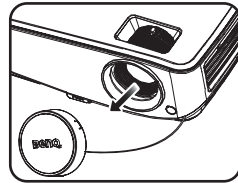

3. Press **POWER** on the projector or remote control to start the projector. The **POWER indicator light** flashes and stays green when the projector is on. The start up procedure takes about 30 seconds. In the later stage of start up, a startup logo is projected. (If necessary) Rotate the focus ring to adjust the image clearness.

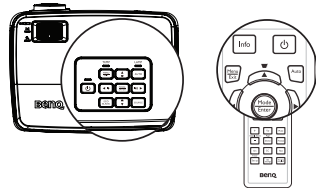

- If the projector is still hot from previous activity, it will run the cooling fan for approximately 90 seconds before energizing the lamp.

4. If the projector is activated for the first time, select your OSD language following the on-screen instructions.
5. If you are prompted for a password, press the arrow keys to enter a six digit password. See "**Utilizing the password function**" on page 29 for details.
6. Switch all of the connected equipment on.
7. The projector will start to search for input signals. The current input signal being scanned displays in the screen. If the projector doesn't detect a valid signal, the message '**No Signal**' will continue displaying until an input signal is found.

Language		
English	한국어	Hrvatski
Français	Svenska	Română
Deutsch	Nederlands	Norsk
Italiano	Türkçe	Dansk
Español	Čeština	Български
Русский	Português	suomi
中文 (繁)	ไทย	Indonesia
中文 (簡)	Polski	Ελληνικά
日本語	Magyar	हिन्दी
العربية		

Enter Confirm MENU Exit

You can also press **Source** on the projector or remote control to select your desired input signal. See ["Switching input signal" on page 32](#) for details.

- ☞ • If no signal is detected for 3 minutes, the projector automatically enters **ECO BLANK** mode.

Adjusting the projected image

Adjusting the projection angle

The projector is equipped with 1 quick-release adjuster foot and 1 rear adjuster foot. These adjusters change the image height and projection angle. To adjust the projector:

1. Press the quick-release button and lift the front of the projector. Once the image is positioned where you want it, release the quick-release button to lock the foot in position.
2. Screw the rear adjuster foot to fine tune the horizontal angle.

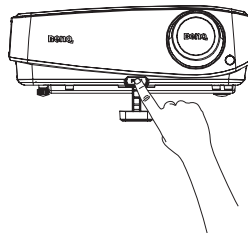

To retract the foot, hold up the projector while pressing the quick-release button, then slowly lower the projector. Screw the rear adjuster foot in a reverse direction.

If the projector is not placed on a flat surface or the screen and the projector are not perpendicular to each other, the projected image becomes trapezoidal. To correct this situation, see ["Magnifying and searching for details" on page 33](#) for details.

- ⚠ • Do not look into the lens while the lamp is on. The strong light from the lamp may cause damage to your eyes.
- Be careful when you press the adjuster button as it is close to the exhaust vent where hot air comes from.

Auto-adjusting the image

In some cases, you may need to optimize the picture quality. To do this, press **AUTO** on the projector or remote control. Within 3 seconds, the built-in Intelligent Auto Adjustment function will re-adjust the values of Frequency and Clock to provide the best picture quality.

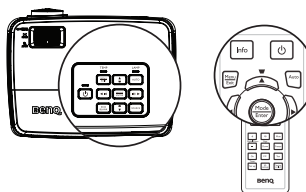

- ☞ • The screen will be blank while Auto is functioning.
- This function is only available when PC signal (analog RGB) is selected.

Use build-in test pattern

You can adjust the image shape and focus status by observing the input signal content, or using the test pattern build-in OSD manual from OSD or remote control for better observe the shape changed.

Open the OSD menu and go to the **SYSTEM SETUP: Advanced** > **Test Pattern** > **On**. Press **MODE/ENTER**. The **Test Pattern** displays.

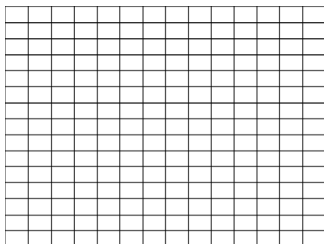
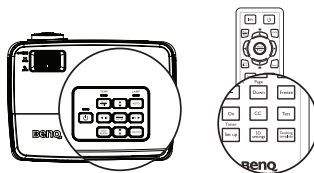

Fine-tuning the image size and clarity

1. Adjust the projected image to the size that you need using the zoom ring.
2. Then sharpen the image by rotating the focus ring.

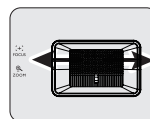
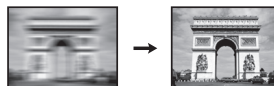
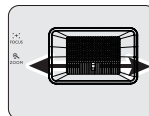

Correcting keystone

Keystoning refers to the situation where the projected image is noticeably wider at either the top or bottom. It occurs when the projector is not perpendicular to the screen.

To correct this, besides adjusting the height of the projector, you will need to manually correct it following one of these steps.

- Using the remote control

Press **▼** / **▲** on the projector or remote control to display the Keystone correction page. Press **▲** to correct keystoning at the top of the image. Press **▼** to correct keystoning at the bottom of the image.

- Using the OSD menu

1. Press **MENU/EXIT** and then press **◀** / **▶** until the **DISPLAY** menu is highlighted.
2. Press **▼** to highlight **Keystone** and press **MODE/ENTER**. The **Keystone** correction page displays.
3. Press **▲** to correct keystoning at the top of the image or press **▼** to correct keystoning at the bottom of the image.

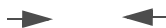
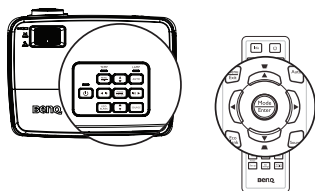

Press **▲** / **▼**.

Press **▼** / **▲**.

Using the menus

The projector is equipped with On-Screen Display (OSD) menus for making various adjustments and settings.

Below is the overview of the OSD menu.



The following example describes how to set the OSD language.

1. Press **MENU/EXIT** on the projector or remote control to turn the OSD menu on.
3. Press **▼** to highlight **Language** and press **Enter** to select a preferred language.

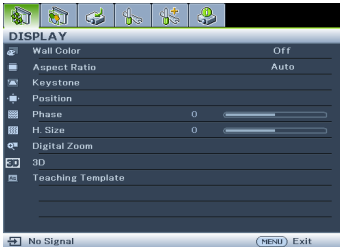

2. Use **◀/▶** to highlight the **SYSTEM SETUP: Basic** menu.
4. Press **MENU/EXIT** twice* on the projector or remote control to leave and save the settings.



*The first press leads you back to the main menu and the second press closes the OSD menu.

Securing the projector

Using a security cable lock

The projector has to be installed in a safe place to prevent theft. Otherwise, purchase a lock, such as the Kensington lock, to secure the projector. You can locate a Kensington lock slot on the rear side of the projector. See item 17 on page 9 for details.

A Kensington security cable lock is usually a combination of key(s) and the lock. Refer to the lock's documentation for finding out how to use it.

Utilizing the password function

For security purposes and to help prevent unauthorized use, the projector includes an option for setting up password security. The password can be set through the On-Screen Display (OSD) menu.

 **WARNING:** You will be inconvenienced if you activate the power-on lock functionality and subsequently forget the password. Print out this manual (if necessary) and write the password you used in this manual, and keep the manual in a safe place for later recall.

Setting a password

 Once a password has been set, the projector cannot be used unless the correct password is entered every time the projector is started.

1. Open the OSD menu and go to the **SYSTEM SETUP: Advanced > Security Settings** menu. Press **MODE/ENTER**. The **Security Settings** page displays.
2. Highlight **Power on lock** and select **On** by pressing **◀/▶**.
3. As pictured to the right, the four arrow keys (**▲**, **▶**, **▼**, **◀**) respectively represent 4 digits (1, 2, 3, 4). According to the password you desire to set, press the arrow keys to enter six digits for the password.
4. Confirm the new password by re-entering the new password.



Once the password is set, the OSD menu returns to the **Security Settings** page.

 **IMPORTANT:** The digits being input will display as asterisks on-screen. Write your selected password down here in this manual in advance or right after the password is entered so that it is available to you should you ever forget it.

Password: _____

Keep this manual in a safe place.

5. To leave the OSD menu, press **MENU/EXIT**.

If you forget the password

If the password function is activated, you will be asked to enter the six-digit password every time you turn on the projector. If you enter the wrong password, the password error message as pictured to the right displays lasting for three seconds, and the message **'INPUT PASSWORD'** follows. You can retry by entering another six-digit password, or if you did not record the password in this manual, and you absolutely do not remember it, you can use the password recall procedure. See ["Entering the password recall procedure" on page 30](#) for details.

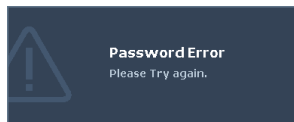

If you enter an incorrect password 5 times in succession, the projector will automatically shut down in a short time.

Entering the password recall procedure

1. Press and hold **Auto** on the projector or remote control for 3 seconds. The projector will display a coded number on the screen.
2. Write down the number and turn off your projector.
3. Seek help from the local BenQ service center to decode the number. You may be required to provide proof of purchase documentation to verify that you are an authorized user of the projector.

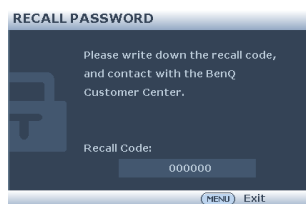

Changing the password

1. Open the OSD menu and go to the **SYSTEM SETUP: Advanced > Security Settings > Change Password** menu.
2. Press **MODE/ENTER**. The message **'INPUT CURRENT PASSWORD'** displays.
3. Enter the old password.
 - If the password is correct, another message **'INPUT NEW PASSWORD'** displays.
 - If the password is incorrect, the password error message displays lasting for three seconds, and the message **'INPUT CURRENT PASSWORD'** displays for your retry. You can press **MENU/EXIT** to cancel the change or try another password.
4. Enter a new password.



IMPORTANT: The digits being input will display as asterisks on-screen. Write your selected password down here in this manual in advance or right after the password is entered so that it is available to you should you ever forget it.

Password: _ _ _ _ _

Keep this manual in a safe place.

5. Confirm the new password by re-entering the new password.

6. You have successfully assigned a new password to the projector. Remember to enter the new password next time the projector is started.
7. To leave the OSD menu, press **MENU/EXIT**.

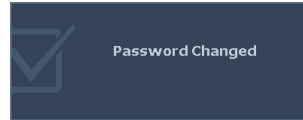

Disabling the password function

To disable password protection, go back to the **SYSTEM SETUP: Advanced > Security Settings > Power on lock** menu after opening the OSD menu system. Select **Off** by pressing ◀/▶. The message 'INPUT PASSWORD' displays. Enter the current password.

- If the password is correct, the OSD menu returns to the **Security Settings** page with '**Off**' shown in the row of **Power on lock**. You will not have to enter the password next time you turn on the projector.
- If the password is incorrect, the password error message displays lasting for three seconds, and the message '**INPUT PASSWORD**' displays for your retry. You can press **MENU/EXIT** to cancel the change or try another password.

 **Though the password function is disabled, you need to keep the old password in hand should you ever need to re-activate the password function by entering the old password.**

Switching input signal

The projector can be connected to multiple devices at the same time. However, it can only display one full screen at a time. When starting up, the projector automatically searches for the available signals.

Be sure the **Quick Auto Search** function in the **SOURCE** menu is **On** (which is the default of this projector) if you want the projector to automatically search for the signals.

You can also manually cycle through the available input signals.

1. Press **SOURCE** on the projector or remote control. A source selection bar displays.
2. Press **▲/▼** until your desired signal is selected and press **MODE/ENTER**.
Once detected, the selected source information will display on the screen for seconds. If there is multiple equipment connected to the projector, repeat steps 1-2 to search for another signal.

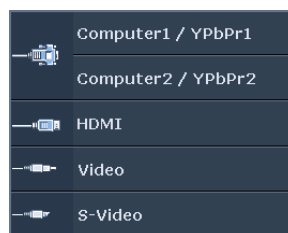
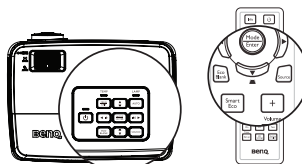

- ☞ **The brightness level of the projected image will change accordingly when you switch between different input signals. Data (graphic) "PC" presentations using mostly static images are generally brighter than "Video" using mostly moving images (movies).**
- **The input signal type effects the options available for the Picture Mode. See ["Selecting a picture mode" on page 35](#) for details.**

For best display picture results, you should select and use an input signal which outputs at this resolution. Any other resolutions will be scaled by the projector depending upon the 'aspect ratio' setting, which may cause some image distortion or loss of picture clarity. See ["Selecting the aspect ratio" on page 33](#) for details.

Changing Color Space

In the unlikely event that you connect the projector to a DVD player via the projector's HDMI input and the projected picture displays wrong colors, please change the color space to YUV.

1. Press **MENU/EXIT** and then press **◀/▶** until the **SOURCE** menu is highlighted.
2. Press **▼** to highlight **Color Space Conversion** and press **◀/▶** to select a suitable color space.

☞ **This function is only available when the HDMI input port is in use.**

Magnifying and searching for details

If you need to find the details on the projected picture, magnify the picture. Use the direction arrow keys for navigating the picture.

- Using the remote control
 1. Press **Digital Zoom +/-** to display the Zoom bar.
 2. Press **Digital Zoom +** to magnify the center of the picture. Press the key repeatedly until the picture size is suitable for your need.
 3. Use the directional arrows (**▲**, **▼**, **◀**, **▶**) on the projector or remote control to navigate the picture.
 4. To restore the picture to its original size, press **AUTO**. You can also press **Digital Zoom -**. When the key is pressed again, the picture is further reduced until it is restored to the original size.

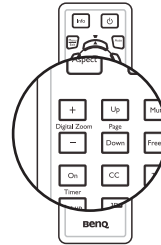

- Using the OSD menu
 1. Press **MENU/EXIT** and then press **◀/▶** until the **DISPLAY** menu is highlighted.
 2. Press **▼** to highlight **Digital Zoom** and press **MODE/ENTER**. The Zoom bar displays.
 3. Repeat steps 2-4 in the section of "Using the remote control" above. Or if you are using the projector control panel, continue to the following steps.
 4. Press **▲** on the projector repeatedly to magnify the picture to a desired size.
 5. To navigate the picture, press **MODE/ENTER** to switch to the panning mode and press the directional arrows (**▲**, **▼**, **◀**, **▶**) to navigate the picture.
 6. Use the directional arrows (**▲**, **▼**, **◀**, **▶**) on the projector or remote control to navigate the picture.
 7. To reduce size of the picture, press **MODE/ENTER** to switch back to the zoom in/out functionality, and press **AUTO** to restore the picture to its original size. You can also press **▼** repeatedly until it is restored to the original size.

 The picture can only be navigated after the picture is magnified. You can further magnify the picture while searching for details.

Selecting the aspect ratio

The 'aspect ratio' is the ratio of the image width to the image height. Most analog TV and computers are in 4:3 ratio, and digital TV and DVDs are usually in 16:9 or 16:10 ratio.

With the advent of digital signal processing, digital display devices like this projector can dynamically stretch and scale the image output to a different aspect than that of the image input signal.

To change the projected image ratio (no matter what aspect the source is):

- Using the remote control
 1. Press **ASPECT** to show the current setting.
 2. Press **ASPECT** repeatedly to select an aspect ratio to suit the format of the video signal and your display requirements.
- Using the OSD menu

1. Press **MENU/EXIT** and then press ◀/▶ until the **DISPLAY** menu is highlighted.
2. Press ▼ to highlight **Aspect Ratio**.
3. Press ◀/▶ to select an aspect ratio to suit the format of the video signal and your display requirements.

About the aspect ratio

1. **Auto:** Scales an image proportionally to fit the projector's native resolution in its horizontal or vertical width. This is suitable for the incoming image which is neither in 4:3 nor 16:9 and you want to make most use of the screen without altering the image's aspect ratio.
2. **Real:** The image is projected as its original resolution, and resized to fit within the display area. For input signals with lower resolutions, the projected image will display smaller than if resized to full screen. You could adjust the zoom setting or move the projector towards the screen to increase the image size if necessary. You may also need to refocus the projector after making these adjustments.
3. **4:3:** Scales an image so that it is displayed in the center of the screen with a 4:3 aspect ratio. This is most suitable for 4:3 images like computer monitors, standard definition TV and 4:3 aspect DVD movies, as it displays them without aspect alteration.
4. **16:9:** Scales an image so that it is displayed in the center of the screen with a 16:9 aspect ratio. This is most suitable for images which are already in a 16:9 aspect, like high definition TV, as it displays them without aspect alteration.
5. **16:10:** Scales an image so that it is displayed in the center of the screen with a 16:10 aspect ratio. This is most suitable for images which are already in a 16:10 aspect, like high definition TV, as it displays them with out aspect alteration.

Optimizing the image

Selecting a picture mode

The projector is preset with several predefined picture modes so that you can choose one to suit your operating environment and input signal picture type.

To select an operation mode that suits your need, you can follow one of the following steps.

- Press **MODE/ENTER** on the remote control or projector repeatedly until your desired mode is selected.
- Go to the **PICTURE > Picture Mode** menu and press **◀/▶** to select a desired mode.

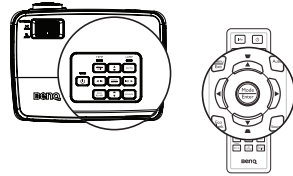

The picture modes are listed below.

1. **Dynamic mode:** Maximizes the brightness of the projected image. This mode is suitable for environments where extra-high brightness is required, such as using the projector in well lit rooms.
2. **Presentation mode (Default):** Is designed for presentations. The brightness is emphasized in this mode.
3. **sRGB mode:** Maximizes the purity of RGB colors to provide true-to-life images regardless of brightness setting. It is most suitable for viewing photos taken with an sRGB compatible and properly calibrated camera, and for viewing PC graphic and drawing applications such as AutoCAD.
4. **Cinema mode:** Is appropriate for playing colorful movies, video clips from digital cameras or DVs through the PC input for best viewing in a blackened (little light) environment.
5. **User 1/User 2 mode:** Recalls the settings customized based on the current available picture modes. See "[Setting the User 1/User 2 mode](#)" on page 35 for details.

Setting the User 1/User 2 mode

There are two user-definable modes if the current available picture modes are not suitable for your need. You can use one of the picture modes (except the **User 1/User 2**) as a starting point and customize the settings.

1. Press **MENU/EXIT** to open the On-Screen Display (OSD) menu.
2. Go to the **PICTURE > Picture Mode** menu.
3. Press **◀/▶** to select **User 1** to **User 2**.
4. Press **▼** to highlight **Reference Mode**.

 This function is only available when **User 1** or **User 2** mode is selected up in the **Picture Mode** sub-menu item.

5. Press **◀/▶** to select a picture mode that is closest to your need.
6. Press **▼** to select a sub-menu item to be changed and adjust the value with **◀/▶**. See "[Fine-tuning the image quality in user modes](#)" below for details.
7. When all settings have been done, highlight **Save Settings** and press **MODE/ENTER** to store the settings.
8. The confirmation message '**Setting Saved**' displays.

Using Wall Color

In the situation where you are projecting onto a colored surface such as a painted wall which may not be white, the **Wall Color** feature can help correct the projected picture's color to prevent possible color difference between the source and projected pictures.

To use this function, go to the **DISPLAY > Wall Color** menu and press ◀/▶ to select a color which is the closest to the color of the projection surface. There are several precalibrated colors to choose from: **Light Yellow**, **Pink**, **Light Green**, **Blue**, and **Blackboard**.

Fine-tuning the image quality in user modes

According to the detected signal type and selected picture mode, some of the below functions may not be available. Based on your needs, you can make adjustments to these functions by highlighting them and pressing ◀/▶ on the projector or remote control.

Adjusting Brightness

The higher the value, the brighter the image. And the lower the setting, the darker the image. Adjust this control so the black areas of the image appear just as black and that detail in the dark areas is visible.



Adjusting Contrast

The higher the value, the greater the contrast. Use this to set the peak white level after you have previously adjusted the **Brightness** setting to suit your selected input and viewing environment.



Adjusting Color

Lower setting produces less saturated colors. If the setting is too high, colors on the image will be overpowering, which makes the image unrealistic.

Adjusting Tint

The higher the value, the more reddish the picture becomes. The lower the value, the more greenish the picture becomes.

Adjusting Sharpness

The higher the value, the sharper the picture becomes. The lower the value, the softer the picture becomes.

Adjusting Brilliant Color

This feature utilizes a new color-processing algorithm and system level enhancements to enable higher brightness while providing truer, more vibrant colors in picture. It enables a greater than 50% brightness increase in mid-tone images, which are common in video and natural scenes, so the projector reproduces images in realistic and true colors. If you prefer images with that quality, select **On**. If you don't need it, select **Off**.

When **Off** is selected, the **Color Temperature** function is not available.

Selecting a Color Temperature

The options available for color temperature* settings vary according to the signal type selected.

1. **Cool:** Makes images appear bluish white.
2. **Normal:** Maintains normal colorings for white.
3. **Warm:** Makes images appear reddish white.

*About color temperatures:

There are many different shades that are considered to be "white" for various purposes. One of the common methods of representing white color is known as the "color temperature". A white color with a low color temperature appears to be reddish white. A white color with a high color temperature appears to have more blue in it.

Setting a preferred color temperature

To set a preferred color temperature:

1. Highlight **Color Temperature** and select **Warm, Normal** or **Cool** by pressing ◀/ ▶ on the projector or remote control.
2. Press ▼ to highlight **Color Temperature Fine Tuning** and press **MODE/ENTER**. The Color Temperature Fine Tuning page displays.
3. Press ▲/▼ to highlight the item you want to change and adjust the values by pressing ◀/ ▶ .
 - **R Gain/G Gain/B Gain**: Adjusts the contrast levels of Red, Green, and Blue.
 - **R Offset/G Offset/B Offset**: Adjusts the brightness levels of Red, Green, and Blue.
4. Press **MENU/EXIT** to exit and save the settings

3D Color Management

In most installation situations, color management will not be necessary, such as in classroom, meeting room, or lounge room situations where lights remain on, or where building external windows allow daylight into the room.

Only in permanent installations with controlled lighting levels such as boardrooms, lecture theaters, or home theaters, should color management be considered. Color management provides fine color control adjustment to allow for more accurate color reproduction, should you require it.

Proper color management can only be achieved under controlled and reproducible viewing conditions. You will need to use a colorimeter (color light meter), and provide a set of suitable source images to measure color reproduction. These tools are not provided with the projector; however, your projector supplier should be able to provide you with suitable guidance, or even an experienced professional installer.

The Color Management provides six sets (RGBCMY) of colors to be adjusted. When you select each color, you can independently adjust its range and saturation according to your preference.

If you have purchased a test disc which contains various color test patterns and can be used to test the color presentation on monitors, TVs, projectors, etc. You can project any image from the disc on the screen and enter the **3D Color Management** menu to make adjustments.

To adjust the settings:

1. Go to the **PICTURE** menu and highlight **3D Color Management**.
2. Press **MODE/ENTER** and the **3D Color Management** page displays.
3. Highlight **Primary Color** and press ◀/▶ to select a color from among Red, Yellow, Green, Cyan, Blue, or Magenta.
4. Press ▼ to highlight **Hue** and press ◀/▶ to select its range. Increase in the range will include colors consisted of more proportions of its two adjacent colors.

Please refer to the illustration to the right for how the colors relate to each other. For example, if you select Red and set its range at 0, only pure red in the projected picture will be selected. Increasing its range will include red close to yellow and red close to magenta.

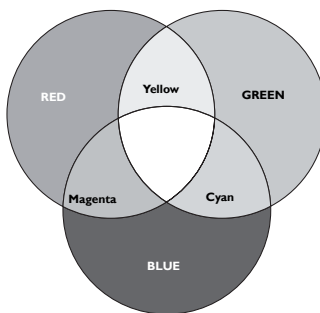

5. Press ▼ to highlight **Saturation** and adjust its values to your preference by pressing ◀ / ▶. Every adjustment made will reflect to the image immediately.

For example, if you select Red and set its value at 0, only the saturation of pure red will be affected.



Saturation is the amount of that color in a video picture. Lower settings produce less saturated colors; a setting of “0” removes that color from the image entirely. If the saturation is too high, that color will be overpowering and unrealistic.

6. Press ▼ to highlight **Gain** and adjust its values to your preference by pressing ◀ / ▶. The contrast level of the primary color you select will be affected. Every adjustment made will reflect to the image immediately.
7. Repeat steps 3 to 6 for other color adjustments.
8. Make sure you have made all of the desired adjustments.
9. Press **MENU/EXIT** to exit and save the settings.

Resetting current or all picture modes

1. Go to the **PICTURE** menu and highlight **Reset Picture Settings**.
2. Press **MODE/ENTER** and press ▲/▼ to select **Current** or **All**.
 - **Current:** returns current picture mode to the factory preset settings.
 - **All:** returns all settings, except **User 1/User 2** in the **PICTURE** menu to the factory preset settings.

Setting the presentation timer

The presentation timer can indicate the presentation time on the screen to help you achieve better time management when giving presentations. Follow these steps to utilize this function:

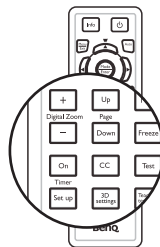

1. Press **Timer Set up** on the remote control or go to the **SYSTEM SETUP: Basic > Presentation Timer** menu and press **MODE/ENTER** to display the **Presentation Timer** page.
2. Highlight **Timer Period** and decide the timer period by pressing **◀/▶**. The length of time can be set from 1 to 5 minutes in 1-minute increments and 5 to 240 minutes in 5-minute increments.
3. Press **▼** to highlight **Timer Display** and choose if you want the timer to show up on the screen by pressing **◀/▶**.

Selection	Description
Always	Displays the timer on screen throughout the presentation time.
3 min/2 min/1 min	Displays the timer on screen in the last 3/2/1 minute(s).
Never	Hides the timer throughout the presentation time.

4. Press **▼** to highlight **Timer Position** and set the timer position by pressing **◀/▶**.
Top-Left → Bottom-Left → Top-Right → Bottom-Right
5. Press **▼** to highlight **Timer Counting Direction** and select your desired counting direction by pressing **◀/▶**.

Selection	Description
Count Up	Increases from 0 to the preset time.
Count Down	Decrease from the preset time to 0.

6. To activate the presentation timer, press **▼** and press **◀/▶** to select **On** and press **MODE/ENTER**.
7. A confirmation message displays. Highlight **Yes** and press **MODE/ENTER** to confirm. You will see the message **"Timer is On"** displaying on the screen. The timer starts counting at the time the timer is on.

To cancel the timer, perform the following steps.

- Using the remote control.

Press **Timer On** and press ◀/▶ to highlight **Off** and press **MODE/ENTER**.

- Using the OSD menu.

1. Go to the **SYSTEM SETUP: Basic > Presentation Timer** menu and highlight **Off**.

Press **MODE/ENTER**. A confirmation message displays.

2. Highlight **Yes** and press **MODE/ENTER** to confirm. You will see the message “Timer is Off!” displaying on the screen.

How to use the Timer On key?

Timer On is a multi-functional key.

- If the presentation timer is off, pressing this key displays a confirmation message. You can decide whether to activate the timer or not by following the on-screen instruction.
- If the timer is already on, pressing this key displays a confirmation message. You can decide whether to restart, continue or turn off the timer by following the on-screen instruction.

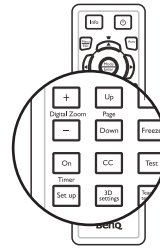

Remote paging operations

Connect the projector to your PC or notebook with a USB cable prior to using the paging function.

You can operate your display software program (on a connected PC) which responds to page up/down commands (like Microsoft PowerPoint) by pressing **Page Up/Down** on the remote control.

If remote paging function doesn't work, check if the USB connection is correctly made and the mouse driver on your computer is updated to the latest version.

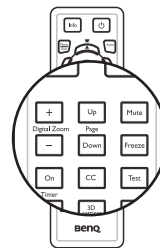

Hiding the image

Press the **Eco Blank** button from projector or remote control to turn off the image for a period of time with up to 70% lamp power saving. Press any key on the projector or remote control to restore the image.

The word "**Eco Blank**" appears at the screen while the image is hidden. When this function is activated with an audio input connected, the audio can still be heard.

- Eco Blank: Save up 70% of your lamp power. Time to do your part in saving the planet.

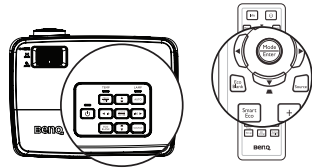

The automatic switch to **Eco Blank Mode** after the projector is turned on for over three minutes without a display source, eliminating unnecessary energy waste and prolonging the life of the projector lamp

You can set the blank time in the **SYSTEM SETUP: Basic > Operation Settings > Blank Timer** menu to let the projector return the image automatically after a period of time when there is no action taken on the blank screen. The length of time can be set from 5 to 30 minutes in 5-minute increments.

 **Do not block the projection lens from projecting as this could cause the blocking object to become heated.**

No matter Eco Blank Timer is activated or not, you can press any key (except the **Page Up/Down** key) on the projector or remote control to restore the picture.

Freezing the image

Press  on the remote control to freeze the image. The word '**FREEZE**' will display in the screen. To release the function, press any key (except the **Page Up/Down** key) on the projector or remote control.

Even if an image is frozen on the screen, the pictures are running on the video or other device. If the connected devices have active audio output, you will still hear the audio even though the image is frozen on screen.

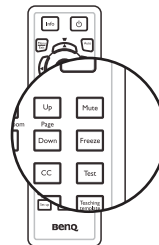

Operating in a high altitude environment

We recommend you use the **High Altitude Mode** when your environment is 1500 m – 3000 m above sea level, and ambient temperature is between 0°C–35°C.



Do not use the High Altitude Mode if your altitude is between 0 m and 1500 m and ambient temperature is between 0°C and 35°C. The projector will be over cooled, if you turn the mode on under such a condition.

To activate the **High Altitude Mode**:

1. Press **MENU/EXIT** and then press ◀/▶ until the **SYSTEM SETUP: Advanced** menu is highlighted.
2. Press ▼ to highlight **High Altitude Mode** and press ◀/▶ to select **On**. A confirmation message displays.
3. Highlight **Yes** and press **MODE/ENTER**.

Operation under "**High Altitude Mode**" may cause a higher decibel operating noise level because of increased fan speed necessary to improve overall system cooling and performance.

If you use this projector under other extreme conditions excluding the above, it may display auto shut-down symptoms, which is designed to protect your projector from overheating. In cases like this, you should switch to High Altitude mode to solve these symptoms. However, this is not to state that this projector can operate under any and all harsh or extreme conditions.

Adjusting the sound

The sound adjustments made as below will have an effect on the projector speaker(s). Be sure you have made a correct connection to the projector audio input. See "[Connection](#)" on page 18 for how the audio input is connected.

Muting the sound

To temporarily turn off the sound:

1. Press **MENU/EXIT** and then press ◀/▶ until the **SYSTEM SETUP: Advanced** menu is highlighted.
2. Press ▼ to highlight **Audio Settings** and press **MODE/ENTER**. The Audio Settings page displays.
3. Highlight **Mute** and press ◀/▶ to select **On**.

Adjusting the sound level

To adjust the sound level, press **Volume +/-** on the remote control, or:

1. Repeat steps 1-2 above.
2. Press ▼ to highlight **Volume** and press ◀/▶ to select a desired sound level.

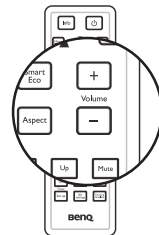

Use Teaching Template

Making writing on the board easier for teachers, you can use build-in template by OSD or remote control.

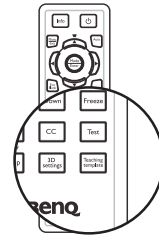
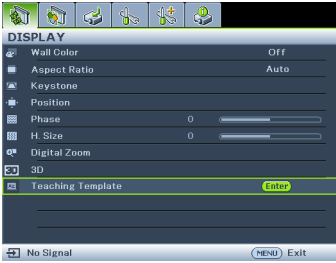

Open the OSD menu and go to the **DISPLAY > Teaching Template** . Choice **Blackboard/ Whiteboard. > Off/ Letter Formation/ Worksheet/ Coordinate Chart**. The Teaching Template displays.

Teaching Template	Whiteboard	Blackboard
Letter Formation		
Worksheet		
Coordinate Chart		

Personalizing the projector menu display

The On-Screen Display (OSD) menus can be set according to your preferences. The following settings do not affect the projection settings, operation, or performance.

- **Menu display Time** in the **SYSTEM SETUP: Basic > Menu Settings** menu sets the length of time the OSD will remain active after your last key press. The time length ranges from 5 to 30 seconds in 5-second increments. Use ◀/▶ to select a suitable time frame.
- **Menu Position** in the **SYSTEM SETUP: Basic > Menu Settings** menu sets the OSD position in five locations. Use ◀/▶ to select a preferred position.
- **Language** in the **SYSTEM SETUP: Basic** menu sets your familiar language for the OSD menus. Use **Enter** to select your language.
- **Reminder Message** in the **SYSTEM SETUP: Basic > Menu Settings** menu sets whether to display reminder messages on screen. Use ◀/▶ to select your desired setting.
- **Splash Screen** in the **SYSTEM SETUP: Basic** menu sets a preferred logo screen to be displayed during projector start-up. Use ◀/▶ to select a screen.

Select the lamp saver mode

- Using the remote control.

Press **SmartEco** and Highlight **Lamp Mode** and press ◀/▶ to select **Normal/Economic/SmartEco/LampSave**.

- Using the OSD menu.

1. Press **Menu/Exit** and then press ◀/▶ until the **SYSTEM SETUP: Advanced** menu is highlighted.
2. Press ▼ to highlight **Lamp Mode** and press **Mode/Enter**. The Lamp Settings page displays.
3. Highlight **Lamp Mode** and press ◀/▶ to select **Normal/Economic/SmartEco/LampSave**. The lamp brightness vary from the different lamp mode, see the description list in table below.

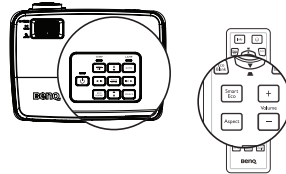

Lamp Mode	Description
Normal	100% lamp brightness.
Economic	Saves 20% lamp power consumption.
SmartEco	Saves up to 80% lamp power consumption depending on the content brightness level and keeps the image as bright as it is in normal mode.
LampSave	Saves up to 80% lamp power consumption to offer the longest lamp life.

 If the **Economic** mode or **SmartEco** mode is selected, the light output will be reduced and result in darker projected pictures.

Shutting down the projector

1. Press **POWER** and a confirmation message displays prompting you. If you don't respond in a few seconds, the message will disappear.
2. Press **POWER** a second time. The **POWER indicator light** flashes orange, the projection lamp shuts down, and the fans will continue to run for approximately 90 seconds to cool down the projector.

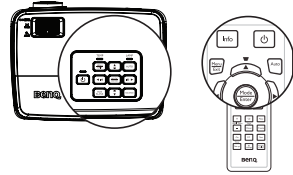

- **To protect the lamp, the projector will not respond to any commands during the cooling process.**
- **To shorten the cooling time, you can also activate the Quick Cooling function. See "Quick Cooling" on page 55 for details.**

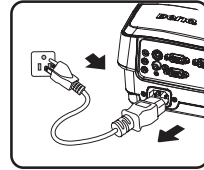

3. Once the cooling process finishes, the **POWER indicator light** is a steady orange and fans stop.
4. Disconnect the power cord from the power outlet if the projector will not be used in an extended period of time.
5. When **Instant Restart** is **On**, users can restart projector immediately within 90 secs after turning off projector. (Projector will maintain 30% of power during the 90 secs)
When **Instant Restart** is **Off**, users need to wait lamp to cool down to restart the projector. When instant restart is on, quick cooling item will be grey out



- **If the projector is not properly shut down, to protect the lamp, when you attempt to re-start the projector, the fans will run for a few minutes to cool down. Press Power again to start the projector after the fans stop and the POWER indicator light turns orange.**
- **Actual lamp life may vary due to different environmental conditions and usage.**

Menu operation

Menu system

Please note that the on-screen display (OSD) menus vary according to the signal type selected.

Main menu	Sub-menu	Options	
I. DISPLAY	Wall Color	Off/Light Yellow/Pink/Light Green/Blue/Blackboard	
	Aspect Ratio	Auto/Real/4:3/16:9/16:10	
	Keystone		
	Position		
	Phase		
	H. Size		
	Digital Zoom		
	3D	3D mode	Auto/Top Bottom/Frame sequential/Frame packing/Side by side/Off
		3D Sync Invert	Disable/Invert
		Apply 3D Settings	3D Settings 1/3D Settings 2/3D Settings 3/Off
		Save 3D Settings	3D Settings 1/3D Settings 2/3D Settings 3
	Teaching Template	Blackboard	Off/Letter Formation/Worksheet/Coordinate Chart
		Whiteboard	Off/Letter Formation/Worksheet/Coordinate Chart

2. PICTURE	Picture Mode	Dynamic/Presentation/sRGB/Cinema/(3D)/User 1/User 2	
	Reference Mode	Dynamic/Presentation/sRGB/Cinema/(3D)	
	Brightness		
	Contrast		
	Color		
	Tint		
	Sharpness		
	Brilliant Color	On/Off	
	Color Temperature	Cool/Normal/Warm	
	Color Temperature Fine Tuning	R Gain/G Gain/B Gain/R Offset/G Offset/B Offset	
	3D Color Management	Primary Color	R/G/B/C/M/Y
		Hue	
		Saturation	
Gain			
Reset picture settings	Current/All/Cancel		
3. SOURCE	Quick Auto Search	On/Off	
	Color Space Conversion	Auto/RGB/YUV	

4. SYSTEM SETUP: Basic





Presentation Timer	Timer Period	1~240 minutes
	Timer Display	Always/3 min/2 min/1 min/Never
	Timer Position	Top-Left/Bottom-Left/Top-Right/ Bottom-Right
	Timer Counting Direction	Count Down/Count Up
	On/Off	Yes/No
Language		English / Français / Deutsch Italiano / Español / Русский 繁體中文 / 简体中文 / 日本語 / 한국어 / Svenska / Nederlands / Türkçe / Čeština / Português / ไทย / Polski Magyar / Български / Hrvatski / Română / Suomi / Norsk / Dansk / Indonesian / বাংলা / العربية / हिन्दी
Projector Installation		Front Table/Rear Table/Rear Ceiling/Front Ceiling
Menu Settings	Menu display Time	5 secs/10 secs/20 secs/30 secs/ Always
	Menu Position	Center/Top-Left/Top-Right/ Bottom-Right/Bottom-Left
	Reminder message	On/Off
Operation Settings	Direct Power On	On/Off
	Auto Power Off	Disable/3 mins/10 mins/15 mins/20 mins/25 mins/30 mins
	Quick Cooling	On/Off
	Instant Restart	On/Off
	Blank Timer	Disable/5 mins/10 mins/15 mins/20 mins/25 mins/30 mins
	Sleep Timer	Disable/30 mins/1 hr/2 hrs/3 hrs/4 hrs/8 hrs/12 hrs
	Fan Speed	Normal/High
Panel Key Lock	On/Off	Yes/No
Background Color		BenQ/Black/Blue/Purple
Splash Screen		BenQ/Black/Blue

5. SYSTEM SETUP: Advanced	High Altitude Mode	On/Off	Yes/No
	Audio Settings	Mute	On/Off
		Volume	0~10
	Lamp Settings	Lamp Mode	Normal/Economic/SmartEco/LampSave
		Reset Lamp Timer	Reset/Cancel
		Equivalent Lamp	
	Security Settings	Change Password	
		Change Security	Power on lock
	Baud Rate		2400/4800/9600/14400/19200/38400/57600/115200
	Test Pattern		On/Off
	Closed Caption	Closed Caption Enable	On/Off
		Caption Version	CC1/CC2/CC3/CC4
	Standby Settings	Monitor Out	On/Off
		Audio Pass Through	Off/Computer 1/Computer 2/Video, Svideo/HDMI
Reset All Settings	Reset/Cancel		
6. INFORMATION	Current System Status		<ul style="list-style-type: none"> • Source • Picture Mode • Resolution • Lamp Mode • 3D Format • Color System • Equivalent Lamp • Firmware Version



Note that the menu items are available when the projector detects at least one valid signal. If there is no equipment connected to the projector or no signal detected, limited menu items are accessible.

Description of each menu

 • The default values listed in this manual, especially on pages 50-58, are for reference only. They may vary between the projectors due to the continuous improvement to the products.

FUNCTION	DESCRIPTION
I. DISPLAY menu	Wall Color Corrects the projected picture's color when the projection surface is not white. See "Using Wall Color" on page 36 for details.
	Aspect Ratio There are four options to set the image's aspect ratio depending on your input signal source. See "Selecting the aspect ratio" on page 33 for details.
	Keystone Corrects any keystone of the image. See "Correcting keystone" on page 27 for details.
	Position Displays the position adjustment page. To move the projected image, use the directional arrow keys. The values shown on the lower position of the page change with every key press you made until they reach their maximum or minimum.  This function is only available when a PC signal (analog RGB) is selected.
	Phase Adjusts the clock phase to reduce image distortion.  This function is only available when a PC signal (analog RGB) is selected. 
	H. Size  This function is only available when a PC signal (analog RGB) is selected.
	Digital Zoom Magnifies or reduces the projected image. See "Magnifying and searching for details" on page 33 for details.

FUNCTION	DESCRIPTION
<p style="writing-mode: vertical-rl; transform: rotate(180deg);">I . DISPLAY menu</p> <p>3D</p>	<p>This projector features a 3D function which enables you to enjoy the 3D movies, videos, and sporting events in a more realistic way by presenting the depth of the images. You need to wear a pair of 3D glasses to view the 3D images.</p> <p>3D Mode The default setting is Auto and the projector automatically chooses an appropriate 3D format when detecting 3D contents. If the projector cannot recognize the 3D format, press ◀ / ▶ to choose a 3D mode.</p> <p>3D Sync Invert When you discover the inversion of the image depth, enable this function to correct the problem.</p> <p>Apply 3D Settings The projector will apply saved 3D settings and keep these settings when you reboot the projector next time.</p> <p>Save 3D Settings The projector will memorize the current 3D settings.</p>
<p>Teaching Template</p>	<p>Provides some templates as teaching aids. Teachers can use them for teaching. See "Use Teaching Template" on page 43 for details.</p>





FUNCTION	DESCRIPTION
2. PICTURE menu	<p>Picture Mode</p> <p>Pre-defined picture modes are provided so you can optimize your projector image set-up to suit your program type. See "Selecting a picture mode" on page 35 for details.</p>
	<p>Reference Mode</p> <p>Selects a picture mode that best suits your need for the image quality and further fine-tune the image based on the selections listed on the same page below. See "Setting the User 1/User 2 mode" on page 35 for details.</p>
	<p>Brightness</p> <p>Adjusts the brightness of the image. See "Adjusting Brightness" on page 36 for details.</p>
	<p>Contrast</p> <p>Adjusts the degree of difference between dark and light in the image. See "Adjusting Contrast" on page 36 for details.</p>
	<p>Color</p> <p>Adjusts the color saturation level -- the amount of each color in a video image. See "Adjusting Color" on page 36 for details.</p> <p> This function is only available when a Video or S-Video signal is selected.</p>
	<p>Tint</p> <p>Adjusts the red and green color tones of the image. See "Adjusting Tint" on page 36 for details.</p> <p> This function is only available when a Video or S-Video signal is selected and the system format is NTSC.</p>
<p>Sharpness</p> <p>Adjusts the image to make it look sharper or softer. See "Adjusting Sharpness" on page 36 for details.</p> <p> This function is only available when a Video or S-Video signal is selected.</p>	

	FUNCTION	DESCRIPTION
2. PICTURE menu	Brilliant Color	See "Adjusting Brilliant Color" on page 36 for details.
	Color Temperature	See "Selecting a Color Temperature" on page 36 for details.
	Color Temperature Fine Tuning	See "Setting a preferred color temperature" on page 37 for details.
	3D Color Management	See "3D Color Management" on page 37 for details.
	Reset Picture Setting	See "Resetting current or all picture modes" on page 38 for details. When Picture Mode is under Dynamic, choosing "Current" will only reset the Dynamic to default value, however, choosing "All" will reset all the Picture Mode settings to default values.
3. SOURCE menu	Quick Auto Search	See "Switching input signal" on page 32 for details.
	Color Space Conversion	See "Changing Color Space" on page 32 for details.

		FUNCTION	DESCRIPTION
4. SYSTEM SETUP: Basic menu		Presentation Timer	Reminds the presenter to finish the presentation within a certain time frame. See " Setting the presentation timer " on page 39 for details.
		Language	Sets the language for the On-Screen Display (OSD) menus. See " Using the menus " on page 28 for details.
		Projector Installation	The projector can be installed on a ceiling or behind a screen, or with one or more mirrors. See " Choosing a location " on page 15 for details.
		Menu Settings	<p>Menu display Time Sets the length of time the OSD will remain active after your last key press. The range is from 5 to 30 seconds in 5-second increments.</p> <p>Menu Position Sets the On-Screen Display (OSD) menu position.</p> <p>Reminder message Sets whether to display the reminder message.</p>

FUNCTION	DESCRIPTION
<p style="writing-mode: vertical-rl; transform: rotate(180deg);">4. SYSTEM SETUP: Basic menu</p> <p>Operation Settings</p>	<p>Direct Power On Selecting On enables the function. See "Starting up the projector" on page 24 for details.</p> <p>Auto Power Off Allows the projector to turn off automatically if no input signal is detected after a set period of time. See "Setting Auto Power Off" on page 60 for details.</p> <p>Quick Cooling Selecting On enables the function and the projector cooling time will be shortened to a few seconds.</p> <p> If you attempt to restart the projector right after the quick cooling process, it may not be turned on successfully and will rerun its cooling fans.</p> <p>Instant Restart When instant restart is on, users can restart projector immediately within 90 secs after turning off projector.</p> <p>Blank Timer Sets the image blank time when the Blank feature is activated, once elapsed the image will return to the screen. See "Hiding the image" on page 41 for details.</p> <p>Sleep Timer Sets the auto-shutdown timer. The timer can be set to a value between 30 minutes and 12 hours.</p> <p>Fan Speed This function is only available when a dust filter is installed. Selecting High enables the function.</p>
<p>Panel Key Lock</p>	<p>Disables or enables all panel key functions except Power on the projector and keys on the remote control.</p>
<p>Background Color</p>	<p>Allows you to select which background color will display when no signal is input into the projector. Four options are available: BenQ logo, Black, Blue, or Purple.</p>
<p>Splash Screen</p>	<p>Allows you to select which logo screen will display during projector start-up. Three options are available: BenQ logo, Black screen, or Blue screen.</p>

FUNCTION	DESCRIPTION
5. SYSTEM SETUP: Advanced menu	High Altitude Mode A mode for operation in high altitude areas. See "Operating in a high altitude environment" on page 42 for details.
	Audio Settings Allows you to enter the audio setting menu. Mute Sets the mute function. Volume Adjusts the audio volume level.
	Lamp Settings Lamp Mode See "Setting Lamp mode eco function as Economic or SmartEco mode" on page 60 for details. Reset Lamp Timer See "Resetting the lamp timer" on page 65 for details. Equivalent Lamp See "Getting to know the lamp hour" on page 60 for details on how the total lamp hour is calculated.
	Security Settings Change Password You will be asked to enter the current password before changing to a new one. Change Security Power on lock See "Utilizing the password function" on page 29 for details.
	Baud Rate Selects a baud rate that is identical with your computer's so that you can connect the projector using a suitable RS-232 cable and update or download the projector's firmware. This function is intended for qualified service personnel.
	Test Pattern Selecting On enables the function and the projector displays the grid test pattern. It helps you adjust the image size and focus and check that the projected image is free from distortion. See "Use build-in test pattern" on page 26 for details.

FUNCTION	DESCRIPTION
5. SYSTEM SETUP: Advanced menu Closed Caption	<p>Closed Caption Enable Activates the function by selecting On when the selected input signal carries closed captions.</p> <ul style="list-style-type: none"> • Captions: An on-screen display of the dialogue, narration, and sound effects of TV programs and videos that are closed captioned (usually marked as "CC" in TV listings). <p>Caption Version Selects a preferred closed captioning mode. To view captions, select CC1, CC2, CC3, or CC4 (CC1 displays captions in the primary language in your area).</p>
	<p>Monitor Out Selecting On enables the function. The projector can output a VGA signal when it is in standby mode and the COMPUTER 1 and MONITOR-OUT jacks are correctly connected to devices. See "Connecting a monitor" on page 19 for how to make the connection.</p> <p> Enabling this function slightly increases the standby power consumption.</p> <p> The Standby Monitor Out only works when an appropriate D-Sub input is made to the COMPUTER 1 jack.</p> <p>Audio Pass Through The projector can play sound when it is in standby mode and the corresponding jacks are correctly connected to devices. Press ◀ / ▶ to choose the source that you wish to use. See "Connection" on page 18 for how to make the connection.</p> <p> Enabling this function slightly increases the standby power consumption.</p>
Reset All Settings	<p>Returns all settings to the factory preset values.</p> <p> The following settings will still remain: User 1, User 2, Projector Position, Color Space Conversion, High Altitude Mode, Security Settings and Baud Rate.</p>

FUNCTION	DESCRIPTION
<p style="writing-mode: vertical-rl; transform: rotate(180deg);">6. INFORMATION menu</p> <p>Current System Status</p>	<p>Source Shows the current signal source.</p> <p>Picture Mode Shows the selected mode in the PICTURE menu.</p> <p>Resolution Shows the native resolution of the input signal.</p> <p>Lamp Mode Shows the current lamp mode.</p> <p>3D Format Shows the current 3D mode.</p> <p>Color System Shows input system format, NTSC, PAL, SECAM, or RGB.</p> <p>Equivalent Lamp Displays the number of hours the lamp has been used.</p> <p>Firmware Version Shows firmware version.</p>

Maintenance

Care of the projector

Your projector needs little maintenance. The only thing you need to do on a regular basis is to keep the lens and case clean.

Never remove any parts of the projector except the lamp. Contact your dealer if other parts need replacing.

Cleaning the lens

Clean the lens whenever you notice dirt or dust on the surface.

- Use a canister of compressed air to remove dust.
- If there is dirt or smears, use lens-cleaning paper or moisten a soft cloth with lens cleaner and gently wipe the lens surface.
- Never use any type of abrasive pad, alkaline/acid cleaner, scouring powder, or volatile solvent, such as alcohol, benzene, thinner or insecticide. Using such materials or maintaining prolonged contact with rubber or vinyl materials may result in damage to the projector surface and cabinet material.

 **Never rub the lens with abrasive materials.**

Cleaning the projector case

Before you clean the case, turn the projector off using the proper shutdown procedure as described in ["Shutting down the projector" on page 45](#) and unplug the power cord.

- To remove dirt or dust, wipe the case with a soft, lint-free cloth.
- To remove stubborn dirt or stains, moisten a soft cloth with water and a neutral pH detergent. Then wipe the case.

 **Never use wax, alcohol, benzene, thinner or other chemical detergents. These can damage the case.**

Storing the projector

If you need to store the projector for an extended time, please follow the instructions below:

- Make sure the temperature and humidity of the storage area are within the recommended range for the projector. Please refer to ["Specifications" on page 69](#) or consult your dealer about the range.
- Retract the adjuster feet.
- Remove the battery from the remote control.
- Pack the projector in its original packing or equivalent.

Transporting the projector

It is recommended that you ship the projector with its original packing or equivalent.

Lamp information

Getting to know the lamp hour

When the projector is in operation, the duration (in hours) of lamp usage is automatically calculated by the built-in timer. The method of calculating the equivalent lamp hour is as follows:

Total (equivalent) lamp hour= $20/9 * (\text{hours used in Normal mode}) + 5/3 * (\text{hours used in Eco mode}) + 20/13 * (\text{hours used in SmartEco}) + 1 * (\text{hours used in LampSave})$

 See "**Setting Lamp mode eco function as Economic or SmartEco mode**" below for more information on Economic mode.

The lamp hour in Economic, SmartEco and LampSave is calculated shorter of that in Normal mode. That is, using the projector in Economic, SmartEco or LampSave mode helps to extend the lamp hour.

To obtain the lamp hour information:

1. Press **Menu/Exit** and then press **◀/▶** until the **SYSTEM SETUP: Advanced** menu is highlighted.
2. Press **▼** to highlight **Lamp Settings** and press **Mode/Enter**. The **Lamp Settings** page displays.
3. You will see the **Equivalent lamp** information displaying on the menu.
4. To leave the menu, press **Menu/Exit**.

You can also get the lamp hour information on the **INFORMATION** menu.

Extending lamp life

The projection lamp is a consumable item. To keep the lamp life as long as possible, you can do the following settings via the OSD menu or remote control.

Setting Lamp mode eco function as Economic or SmartEco mode

Using **Economic /SmartEco** mode will reduce system noise and power consumption. If the **Economic/SmartEco** mode is selected, the light output will be reduced and result in darker projected pictures, the projector protected for longer working life.

Setting the projector in **Economic/SmartEco** mode also extends the lamp operation life.

To set **Economic/SmartEco** mode, go into the **SYSTEM SETUP: Advanced > Lamp Settings > Lamp mode** menu and press **◀/▶** . .

The lamp modes are defined as the chart below.

Lamp mode	Description
Normal	100% lamp brightness.
Economic	Saves 20% lamp power consumption.
SmartEco	Saves up to 80% lamp power consumption depending on the content brightness level and keeps the image as bright as it is in normal mode.
LampSave	Saves up to 80% lamp power consumption to offer the longest lamp life.

Setting Auto Power Off

This function allows the projector to turn off automatically if no input source is detected after a set period of time to prevent unnecessary waste of lamp life.

To set **Auto Power Off**, go into the **SYSTEM SETUP: Basic > Auto Power Off** menu and press ◀/▶. The time period can be set from 5 to 30 minutes in 5-minute increments. If the preset time lengths are not suitable for your presentation, select **Disable**. The projector will not automatically shut down in a certain time period.

Timing of replacing the lamp

When the **Lamp indicator** lights up red or a message appears suggesting it is time to replace the lamp, please install a new lamp or consult your dealer. An old lamp may cause a malfunction in the projector and in some instances the lamp may explode.

 **Do not attempt to replace the lamp yourself. Contact the qualified service personnel for replacement.**

 **The Lamp indicator light and Temperature warning light will light up if the lamp becomes too hot. See "Indicators" on page 66 for details.**

The following lamp warning displays will remind you to change the lamp.

 **The warning messages below are for reference only. Please follow the actual on-screen instructions to prepare and replace the lamp.**

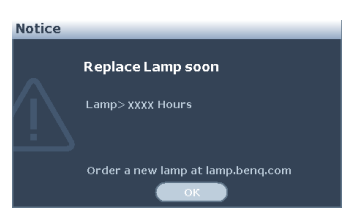
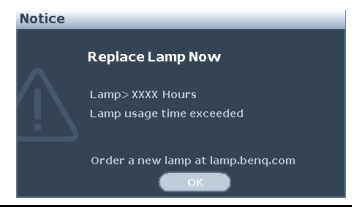
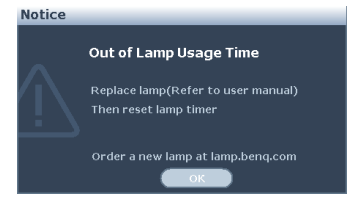
Status	Message
<p>Install a new lamp for optimal performance. If the projector is normally run with Economic selected ("Setting Lamp mode eco function as Economic or SmartEco mode" on page 60), you may continue to operate the projector until the next lamp warning appears.</p>	 <p>The screenshot shows a dark blue notification box with a white header 'Notice'. The main text reads 'Order Replacement Lamp', followed by 'Lamp> XXXX Hours' and 'Order a new lamp at lamp.benq.com'. An 'OK' button is at the bottom.</p>
<p>A new lamp should be fitted to avoid the inconvenience when the projector runs out of lamp time.</p>	 <p>The screenshot shows a dark blue notification box with a white header 'Notice'. The main text reads 'Replace Lamp soon', followed by 'Lamp> XXXX Hours' and 'Order a new lamp at lamp.benq.com'. An 'OK' button is at the bottom.</p>
<p>It is strongly recommended that you replace the lamp at this stage. The lamp is a consumable item. The lamp brightness diminishes with use. This is normal lamp behavior. You can replace the lamp whenever you notice that the brightness level has significantly diminished.</p>	 <p>The screenshot shows a dark blue notification box with a white header 'Notice'. The main text reads 'Replace Lamp Now', followed by 'Lamp> XXXX Hours' and 'Lamp usage time exceeded'. Below that is 'Order a new lamp at lamp.benq.com' and an 'OK' button.</p>
<p>The lamp MUST be replaced before the projector will operate normally.</p>	 <p>The screenshot shows a dark blue notification box with a white header 'Notice'. The main text reads 'Out of Lamp Usage Time', followed by 'Replace lamp(Refer to user manual) Then reset lamp timer'. Below that is 'Order a new lamp at lamp.benq.com' and an 'OK' button.</p>

 **"XXXX" shown in the above messages are numbers that vary depending on different models.**

Replacing the lamp



• **Hg - Lamp contains mercury. Manage in accordance with local disposal laws. See www.lamprecycle.org.**

- If lamp replacement is performed while the projector is suspended upside-down from the ceiling, make sure that no one is underneath the lamp socket to avoid any possible injury or damage to the human eyes caused by fractured lamp.
 - To reduce the risk of electrical shock, always turn the projector off and disconnect the power cord before changing the lamp.
 - To reduce the risk of severe burns, allow the projector to cool for at least 45 minutes before replacing the lamp.
 - To reduce the risk of injuries to fingers and damage to internal components, use caution when removing lamp glass that has shattered into sharp pieces.
 - To reduce the risk of injuries to fingers and/or compromising image quality by touching the lens, do not touch the empty lamp compartment when the lamp is removed.
 - This lamp contains mercury. Consult your local hazardous waste regulations to dispose of this lamp in a proper manner.
 - To assure optimal performance from the projector, it is recommended that you purchase a BenQ projector lamp for lamp replacement.
 - Ensure good ventilation when handling broken lamps. We recommend that you use respirators, safety glasses, goggles or face shield and wear protective clothing such as gloves.
1. Turn the power off and disconnect the projector from the power outlet. If the lamp is hot, avoid burns by waiting for approximately 45 minutes until the lamp has cooled.
 2. Loosen the screw on the lamp cover.

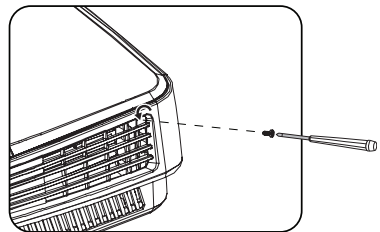

- Remove the lamp cover by (a) sliding the cover toward the side of the projector and (b) lifting it off.



- Do not turn the power on with the lamp cover removed.
- Do not insert your fingers between the lamp and the projector. The sharp edges inside the projector may cause injuries.

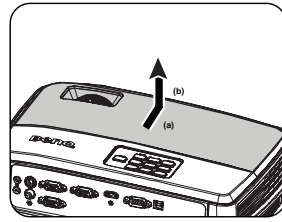

- Loosen the screws that secure the lamp.

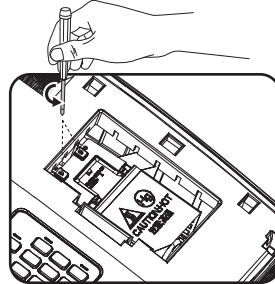

- Lift the handle so that it stands up. Use the handle to slowly pull the lamp out of the projector.



- Pulling it too quickly may cause the lamp to break and scatter broken glass in the projector.
- Do not place the lamp in locations where water might splash on it, children can reach it, or near flammable materials.
- Do not insert your hands into the projector after the lamp is removed. If you touch the optical components inside, it could cause color unevenness and distortion of the projected images.

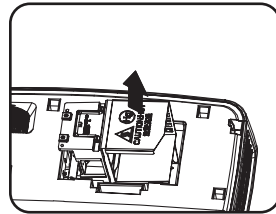

- Insert the new lamp into the lamp compartment and make sure it fits in the projector.

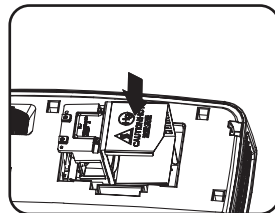

7. Tighten the screws that secure the lamp.



- **Loose screw may cause a bad connection, which could result in malfunction.**

- **Do not over tighten the screws.**

8. Ensure the handle is fully laid flat and locked in place.

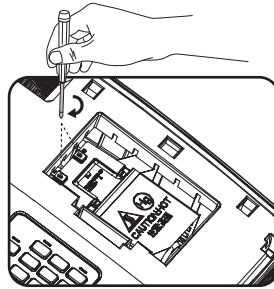

9. Replace the lamp cover by sliding it into place.

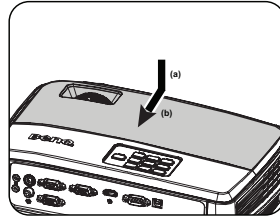

10. Tighten the screw that secures the lamp cover.



- **Loose screw may cause a bad connection, which could result in malfunction.**

- **Do not over tighten the screw.**

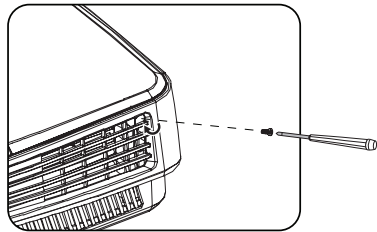

11. Restart the projector.



- **Do not turn the power on with the lamp cover removed.**

Resetting the lamp timer

12. After the startup logo, open the On-Screen Display (OSD) menu. Go to the **SYSTEM SETUP: Advanced > Lamp Settings** menu. Press **Mode/Enter**. The **Lamp Settings** page displays. Press **▼** to highlight **Reset lamp timer** and press **Mode/Enter**.

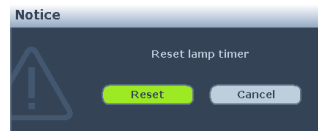

A warning message displays asking if you want to reset the lamp timer. Highlight **Reset** and press **Mode/Enter**. The lamp time will be reset to '0'.



- **Do not reset if the lamp is not new or replaced as this could cause damage.**

Indicators

Light			Status & Description
POWER	TEMP	LAMP	
Power events			
Orange	Off	Off	Stand-by mode
Green Flashing	Off	Off	Powering up
Green	Off	Off	Normal operation
Orange Flashing	Off	Off	Normal power-down cooling
Red	Off	Off	Download
Green	Off	Red	CW start fail
Red Flashing	Off	Off	Scaler shutdown fail (data abort)
Red	Off	Red	Scaler reset fail (video projector only)
Green	Off	Off	Burn-in ON
Green	Green	Green	Burn-in OFF
Lamp events			
Off	Off	Red	Lamp I error in normal operation
Off	Off	Orange Flashing	Lamp is not lit up
Thermal events			
Red	Red	Off	Fan 1 error (the actual fan speed is $\pm 25\%$ outside the desired speed)
Red	Red Flashing	Off	Fan 2 error (the actual fan speed is $\pm 25\%$ outside the desired speed)
Red	Green	Off	Fan 3 error (the actual fan speed is $\pm 25\%$ outside the desired speed)
Red Flashing	Red Flashing	Off	Temperature 1 error (over limited temperature)
Green	Red Flashing	Off	Thermal Sensor 1 open error
Green	Green	Off	Thermal Sensor 1 short error
Green	Green Flashing	Off	Thermal IC #1 I2C Connection error
Green Flashing	Red	Off	Temperature 2 error (over limited temperature)
Green Flashing	Red Flashing	Off	Thermal Sensor 2 open error
Green Flashing	Green	Off	Thermal Sensor 2 short error

Green Flashing	Green Flashing	Off	Thermal IC #2 I2C Connection error
-----------------------	-----------------------	------------	------------------------------------

Troubleshooting

? The projector does not turn on.

Cause	Remedy
There is no power from the power cable.	Plug the power cord into the AC inlet on the projector, and plug the power cord into the power outlet. If the power outlet has a switch, make sure that it is switched on.
Attempting to turn the projector on again during the cooling process.	Wait until the cooling down process has completed.

? No picture

Cause	Remedy
The video source is not turned on or connected correctly.	Turn the video source on and check that the signal cable is connected correctly.
The projector is not correctly connected to the input signal device.	Check the connection.
The input signal has not been correctly selected.	Select the correct input signal with the SOURCE key on the projector or remote control.
The lens cover is still closed.	Open the lens cover.

? Blurred image

Cause	Remedy
The projection lens is not correctly focused.	Adjust the focus of the lens using the focus ring.
The projector and the screen are not aligned properly.	Adjust the projection angle and direction as well as the height of the unit if necessary.
The lens cover is still closed.	Open the lens cover.

? Remote control does not work

Cause	Remedy
The battery is out of power.	Replace the battery with new one.
There is an obstacle between the remote control and the projector.	Remove the obstacle.
You are too far away from the projector.	Stand within 8 meters (26 feet) of the projector.

? The password is incorrect

Cause	Remedy
You do not remember the password.	Please see "Entering the password recall procedure" on page 30 for details.

Specifications

 All specifications are subject to change without notice.

Optical

Resolution

(MS521/MS511H)
800 x 600 SVGA
(MX522)
1024 x 768 XGA
(MW523/TW523)
1280 x 800 WXGA

Display system

I-CHIP DMD

Lens F/Number

(MS521/MX522/MS511H)
F = 2.51 to 2.69
f = 22.08 to 24.28 mm
(MW523/TW523)
F = 2.55 to 3.06
f = 21 to 25.6 mm

Offset

(MS521/MX522/MS511H): 130% ;
(MW523/TW523): 125%

Zoom ratio

(MS521/MX522/MS511H): 1.1X;
(MW523/TW523): 1.2X

Lamp

(MS521/MX522/MW523/MS511H/
TW523): 190 W lamp

Electrical

Power supply

AC100–240V, 2.6 A,
50-60 Hz (Automatic)

Power consumption

(MS521/MX522/MW523/MS511H/
TW523): 265 W (Max); < 0.5 W
(Standby)

Mechanical

Weight

2.3 Kg (5.1 lbs)

Output terminals

RGB output

D-Sub 15-pin (female) x 1

Speaker

(Stereo) 2 watt x 1

Control

RS-232 serial control

9 pin x 1

IR receiver x 1

USB Type B x 1

Input terminals

Computer input

RGB input

D-Sub 15-pin (female) x 2

Video signal input

S-VIDEO

Mini DIN 4-pin port x 1

VIDEO

RCA jack x 1

SD/HDTV signal input

Analog - Component RCA jack x 3
(through RGB input)

Digital-HDMI x 1

Audio signal input

Audio in

PC audio jack x 2

Audio out

PC audio jack x 1

Environmental Requirements

Operating temperature

0°C-40°C at sea level

Operating relative humidity

10%-90% (without condensation)

Operating altitude

0-1499 m at 0°C-35°C

1500-3000* m at 0°C-30°C (with High
Altitude Mode on)

* China region only applies to an altitude
of 2000m.

 Lamp life results will vary depending on environmental conditions and usage.

Dimensions

301.6 mm (W) x 111.3 mm (H) x 219.2 mm (D)

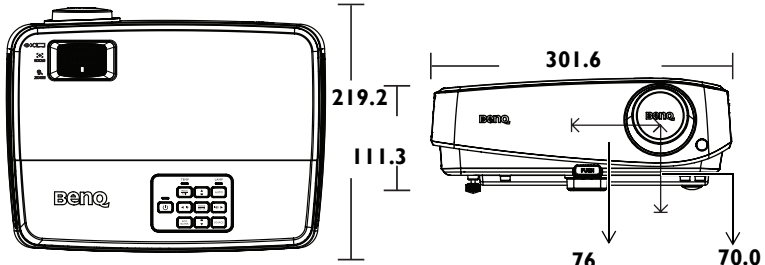

Ceiling mount installation

Ceiling mount screws:
M4 x 8 (Max. L = 8 mm)

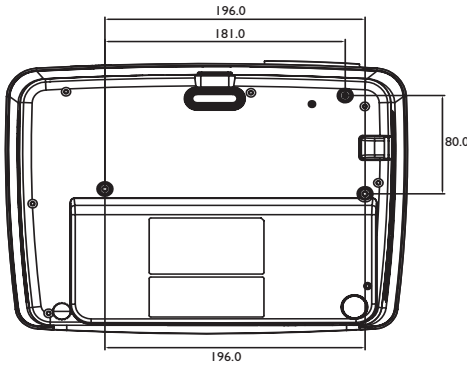

Unit: mm

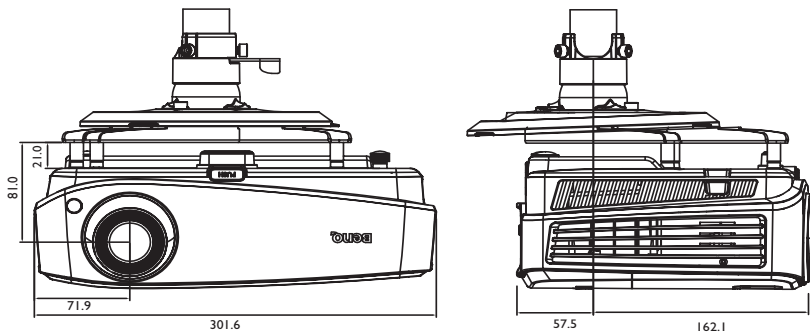

Timing chart

Supported timing for PC input

Resolution	Mode	Vertical Frequency (Hz)	Horizontal Frequency (kHz)	Pixel Frequency (MHz)
640 x 480	VGA_60*	59.940	31.469	25.175
	VGA_72	72.809	37.861	31.500
	VGA_75	75.000	37.500	31.500
	VGA_85	85.008	43.269	36.000
720 x 400	720 x 400_70	70.087	31.469	28.3221
800 x 600	SVGA_60*	60.317	37.879	40.000
	SVGA_72	72.188	48.077	50.000
	SVGA_75	75.000	46.875	49.500
	SVGA_85	85.061	53.674	56.250
	SVGA_120** (Reduce Blanking)	119.854	77.425	83.000
	1024 x 768	XGA_60*	60.004	48.363
XGA_70		70.069	56.476	75.000
XGA_75		75.029	60.023	78.750
XGA_85		84.997	68.667	94.500
XGA_120** (Reduce Blanking)		119.989	97.551	115.5
1152 x 864	1152 x 864_75	75	67.5	108
1024 x 576	BenQ Notebook_ timing	60.0	35.820	46.966
1024 x 600	BenQ Notebook_ timing	64.995	41.467	51.419
1280 x 720	1280 x 720_60*	60	45.000	74.250
1280 x 768	1280 x 768_60*	59.87	47.776	79.5
1280 x 800	WXGA_60*	59.810	49.702	83.500
	WXGA_75	74.934	62.795	106.500
	WXGA_85	84.880	71.554	122.500
	WXGA_120** (Reduce Blanking)	119.909	101.563	146.25
1280 x 1024	SXGA_60***	60.020	63.981	108.000
	SXGA_75	75.025	79.976	135.000
	SXGA_85	85.024	91.146	157.500
1280 x 960	1280 x 960_60***	60.000	60.000	108.000
	1280 x 960_85	85.002	85.938	148.500
1360 x 768	1360 x 768_60***	60.015	47.712	85.5
1440 x 900	WXGA+_60***	59.887	55.935	106.500
1400 x 1050	SXGA+_60***	59.978	65.317	121.750
1600 x 1200	UXGA***	60.000	75.000	162.000
1680 x 1050	1680 x 1050_60***	59.954	65.29	146.25
640 x 480@67Hz	MAC13	66.667	35.000	30.240
832 x 624@75Hz	MAC16	74.546	49.722	57.280
1024 x 768@75Hz	MAC19	74.93	60.241	80.000
1152 x 870@75Hz	MAC21	75.060	68.680	100.000

 *Supported timing for 3D signal with Frame Sequential, Top Bottom and Side by Side format.

**Supported timing for 3D signal with Frame Sequential format.

***Supported timing for 3D signal with Top Bottom and Side by Side format.

- The timings showing above may not be supported due to EDID file and VGA graphic card limitations. It is possible that some timings cannot be chosen.

Supported timing for HDMI (HDCP) input

Resolution	Mode	Vertical Frequency (Hz)	Horizontal Frequency (kHz)	Pixel Frequency (MHz)
640 x 480	VGA_60*	59.940	31.469	25.175
	VGA_72	72.809	37.861	31.500
	VGA_75	75.000	37.500	31.500
	VGA_85	85.008	43.269	36.000
720 x 400	720 x 400_70	70.087	31.469	28.3221
800 x 600	SVGA_60*	60.317	37.879	40.000
	SVGA_72	72.188	48.077	50.000
	SVGA_75	75.000	46.875	49.500
	SVGA_85	85.061	53.674	56.250
	SVGA_120** (Reduce Blanking)	119.854	77.425	83.000
1024 x 768	XGA_60*	60.004	48.363	65.000
	XGA_70	70.069	56.476	75.000
	XGA_75	75.029	60.023	78.750
	XGA_85	84.997	68.667	94.500
	XGA_120** (Reduce Blanking)	119.989	97.551	115.5
1152 x 864	1152 x 864_75	75	67.5	108
1280 x 768	1280 x 768_60*	59.87	47.776	79.5
1024 x 576@60Hz	BenQ Notebook_ timing	60.00	35.820	46.996
1024 x 600@65Hz	BenQ Notebook_ timing	64.995	41.467	51.419
1280 x 720	1280 x 720_60*	60	45.000	74.250
1280 x 768	1280 x 768_60	59.870	47.776	79.5
1280 x 800	WXGA_60*	59.810	49.702	83.500
	WXGA_75	74.934	62.795	106.500
	WXGA_85	84.880	71.554	122.500
	WXGA_120** (Reduce Blanking)	119.909	101.563	146.25
1280 x 1024	SXGA_60***	60.020	63.981	108.000
	SXGA_75	75.025	79.976	135.000
	SXGA_85	85.024	91.146	157.500
1280 x 960	1280 x 960_60***	60.000	60.000	108.000
	1280 x 960_85	85.002	85.938	148.500
1360 x 768	1360 x 768_60***	60.015	47.712	85.5
1440 x 900	WXGA+ 60***	59.887	55.935	106.500
1400 x 1050	SXGA+ 60***	59.978	65.317	121.750
1600 x 1200	UXGA***	60.000	75.000	162.000
1680 x 1050	1680 x 1050_60***	59.954	65.29	146.25
640 x 480@67Hz	MAC13	66.667	35.000	30.240
832 x 624@75Hz	MAC16	74.546	49.722	57.280
1024 x 768@75Hz	MAC19	74.93	60.241	80.000
1152 x 870@75Hz	MAC21	75.060	68.680	100.000

 *Supported timing for 3D signal with Frame Sequential, Top Bottom and Side by Side format.

**Supported timing for 3D signal with Frame Sequential format.

***Supported timing for 3D signal with Top Bottom and Side by Side format.

- The timings showing above may not be supported due to EDID file and VGA graphic card limitations. It is possible that some timings cannot be chosen.

Timing	Resolution	Vertical Frequency (Hz)	Horizontal Frequency (kHz)	Pixel Frequency (MHz)	Remark
480i*	720 x 480	59.94	15.73	27	HDMI only
480p*	720 x 480	59.94	31.47	27	HDMI only
576i	720 x 576	50	15.63	27	HDMI/DVI
576p	720 x 576	50	31.25	27	HDMI/DVI
720/50p**	1280 x 720	50	37.5	74.25	HDMI/DVI
720/60p***	1280 x 720	60	45.00	74.25	HDMI/DVI
1080/50i****	1920 x 1080	50	28.13	74.25	HDMI/DVI
1080/60i****	1920 x 1080	60	33.75	74.25	HDMI/DVI
1080/24P**	1920 x 1080	24	27	74.25	HDMI/DVI
1080/25P	1920 x 1080	25	28.13	74.25	HDMI/DVI
1080/30P	1920 x 1080	30	33.75	74.25	HDMI/DVI
1080/50P	1920 x 1080	50	56.25	148.5	HDMI/DVI
1080/60P	1920 x 1080	60	67.5	148.5	HDMI/DVI

 *Supported timing for 3D signal with Frame Sequential format.

**Supported timing for 3D signal with Top Bottom and Frame Packing format.

***Supported timing for 3D signal with Side by Side format.

****Supported timing for 3D signal with Frame Sequential, Top Bottom and Frame Packing format.

Supported timing for Component-YPbPr input

Timing	Resolution	Vertical Frequency (Hz)	Horizontal Frequency (kHz)	Pixel Frequency (MHz)
480i*	720 x 480	59.94	15.73	13.5
480p*	720 x 480	59.94	31.47	27
576i	720 x 576	50	15.63	13.5
576p	720 x 576	50	31.25	27
720/50p	1280 x 720	50	37.5	74.25
720/60p*	1280 x 720	60	45.00	74.25
1080/50i	1920 x 1080	50	28.13	74.25
1080/60i	1920 x 1080	60	33.75	74.25
1080/24P	1920 x 1080	24	27	74.25
1080/25P	1920 x 1080	25	28.13	74.25
1080/30P	1920 x 1080	30	33.75	74.25
1080/50P	1920 x 1080	50	56.25	148.5
1080/60P	1920 x 1080	60	67.5	148.5

- ☞ *Supported timing for 3D signal with Frame Sequential format.
- ☞ Displaying a 1080i(1125i)@60Hz or 1080i(1125i)@50Hz signal may result in slight image vibration.

Supported timing for Video and S-Video input

Video mode	Horizontal Frequency (kHz)	Vertical Frequency (Hz)	Color sub-carrier Frequency (MHz)
NTSC*	15.73	60	3.58
PAL	15.63	50	4.43
SECAM	15.63	50	4.25 or 4.41
PAL-M	15.73	60	3.58
PAL-N	15.63	50	3.58
PAL-60	15.73	60	4.43
NTSC4.43	15.73	60	4.43

- ☞ *Supported timing for 3D signal with Frame Sequential format.

Supported 3D signal for HDMI (HDCP) input

Video timing

Resolution	Timing	Horizontal frequency (KHz)	Vertical frequency (Hz)	3D Field Sequential	3D frame packing	3D top bottom	3D side by side
720 (1440) x 480	480i	15.73	59.94	⊙			
720 x 480	480p	31.47	59.94	⊙			
720 (1440) x 576	576i	15.63	50				
720 x 576	576p	31.25	50				
1280 x 720	720/50p	37.5	50		⊙	⊙	
1280 x 720	720/60p	45	60	⊙	⊙	⊙	
1920 x 1080	1080/24P	27	24		⊙	⊙	
1920 x 1080	1080/25P	28.13	25				
1920 x 1080	1080/30P	33.75	30				
1920 x 1080	1080/50i	28.13	50				⊙
1920 x 1080	1080/60i	33.75	60				⊙
1920 x 1080	1080/50P	56.25	50				
1920 x 1080	1080/60P	67.5	60				

PC timing

Resolution	Timing	Horizontal frequency (KHz)	Vertical frequency (Hz)	3D Field Sequential	3D top bottom	3D side by side
640 x 480	VGA_60	59.94	31.469	⊙	⊙	⊙
	VGA_72	72.809	37.861			
	VGA_75	75	37.5			
	VGA_85	85.008	43.269			
720 x 400	720x400_70	70.087	31.469			
800 x 600	SVGA_60	60.317	37.879	⊙	⊙	⊙
	SVGA_72	72.188	48.077			
	SGVA_75	75	46.875			
	SVGA_85	85.061	53.674			
	SVGA_120 (Reduce Blanking)	119.854	77.425	⊙		
1024 x 768	XGA_60	60.004	48.363	⊙	⊙	⊙
	XGA_70	70.069	56.476			
	XGA_75	75.029	60.023			
	XGA_85	84.997	68.667			
	XGA_120 (Reduce Blanking)	119.989	97.551	⊙		
1152 x 864	1152 x 864_75	75	67.5			
1024 x 576	BenQ Notebook Timing	60	35.82			
1024 x 600	BenQ Notebook Timing	64.995	41.467			
1280 x 720	1280 x 720_60	60	45	⊙	⊙	⊙
	1280 x 720_120	120	90	⊙		
1280 x 768	1280 x 768_60 (Reduce Blanking)	60	47.396	⊙	⊙	⊙
	1280 x 768_60	59.87	47.776	⊙	⊙	⊙

1280 x 800	WXGA_60	59.81	49.702	⊙	⊙	⊙
	WXGA_75	74.934	62.795			
	WXGA_85	84.88	71.554			
	WXGA_120 (Reduce Blanking)	119.909	101.563	⊙		
1280 x 1024	SXGA_60	60.02	63.981		⊙	⊙
	SXGA_75	75.025	79.976			
	SXGA_85	85.024	91.146			
1280 x 960	1280 x 960_60	60	60		⊙	⊙
	1280 x 960_85	85.002	85.938			
1360 x 768	1360 x 768_60	60.015	47.712		⊙	⊙
1440 x 900	WXGA+_60 (Reduce Blanking)	60	55.469		⊙	⊙
	WXGA+_60	59.887	55.935		⊙	⊙
1400 x 1050	SXGA+_60	59.978	65.317		⊙	⊙
1600 x 1200	UXGA	60	75		⊙	⊙
1680 x 1050	1680 x 1050_60 (Reduce Blanking)	59.883	64.674		⊙	⊙
	1680 x 1080_60	59.954	65.29		⊙	⊙
1920 x 1200	1920 x 1200_60 (Reduce Blanking)	59.95	74.038		⊙	⊙
640 x 480 @67Hz	MAC13	66.667	35			
832 x 624 @75Hz	MAC16	74.546	49.722			
1024 x 768 @75Hz	MAC19	75.02	60.241			
1152 x 870 @75Hz	MAC21	75.06	68.68			
1920 x 1080 (VESA)	1920 x 1080_60 (for Auditorium model)	59.963	67.158			

Supported 3D signal for D-SUB input

PC timing

Resolution	Timing	Horizontal frequency (KHz)	Vertical frequency (Hz)	3D Field Sequential	3D top bottom	3D side by side
640 x 480	VGA_60	59.94	31.469	⊙	⊙	⊙
	VGA_72	72.809	37.861			
	VGA_75	75	37.5			
	VGA_85	85.008	43.269			
720 x 400	720 x 400_70	70.087	31.469			
800 x 600	SVGA_60	60.317	37.879	⊙	⊙	⊙
	SVGA_72	72.188	48.077			
	SVGA_75	75	46.875			
	SVGA_85	85.061	53.674			
	SVGA_120 (Reduce Blanking)	119.854	77.425	⊙		
1024 x 768	XGA_60	60.004	48.363	⊙	⊙	⊙
	XGA_70	70.069	56.476			
	XGA_75	75.029	60.023			
	XGA_85	84.997	68.667			
	XGA_120 (Reduce Blanking)	119.989	97.551	⊙		
1152 x 864	1152 x 864_75	75	67.5			
1024 x 576	BenQ Notebook Timing	60	35.82			
1024 x 600	BenQ Notebook Timing	64.995	41.467			

1280 x 720	1280 x 720_60	60	45	⊙	⊙	⊙
	1280 x 720_120	120	90	⊙		
1280 x 768	1280 x 768_60 (Reduce Blanking)	60	47.396	⊙	⊙	⊙
	1280 x 768_60	59.87	47.776	⊙	⊙	⊙
1280 x 800	WXGA_60	59.81	49.702	⊙	⊙	⊙
	WXGA_75	74.934	62.795			
	WXGA_85	84.88	71.554			
	WXGA_120 (Reduce Blanking)	119.909	101.563	⊙		
1280 x 1024	SXGA_60	60.02	63.981		⊙	⊙
	SXGA_75	75.025	79.976			
	SXGA_85	85.024	91.146			
1280 x 960	1280 x 960_60	60	60		⊙	⊙
	1280 x 960_85	85.002	85.938			
1360 x 768	1360 x 768_60	60.015	47.712		⊙	⊙
1440 x 900	WXGA+ 60 (Reduce Blanking)	60	55.469		⊙	⊙
	WXGA+_60	59.887	55.935		⊙	⊙
1400 x 1050	SXGA+_60	59.978	65.317		⊙	⊙
1600 x 1200	UXGA	60	75		⊙	⊙
1680 x 1050	1680 x 1050_60 (Reduce Blanking)	59.883	64.674		⊙	⊙
	1680 x 1050_60	59.954	65.29		⊙	⊙
1920 x 1200	1920 x 1200_60 (Reduce Blanking)	59.95	74.038		⊙	⊙
640 x 480 @67Hz	MAC13	66.667	35			
832 x 624 @75Hz	MAC16	74.546	49.722			
1024 x 768 @75Hz	MAC19	75.02	60.241			
1152 x 870 @75Hz	MAC21	75.06	68.68			
1920 x 1080 (VESA)	1920 x 1080_60 (Auditorium model)	59.963	67.158			

Supported 3D signal for Video and S-Video input

Video mode	Horizontal Frequency (kHz)	Vertical Frequency (Hz)	3D Field Sequential
NTSC	15.73	60	⊙
PAL	15.63	50	
SECAM	15.63	50	
PAL-M	15.73	60	
PAL-N	15.63	50	
PAL-60	15.73	60	
NTSC4.43	15.73	60	

Warranty and Copyright information

Patents

This BenQ projector is covered by the following patents:

U.S. patents 6,837,608; 7,275,834; 7,181,318; TW patents 202690; 205470; I228635; I259932; China Patents (中国发明专利) ZL01143168.7; ZL03119907.0; ZL200510051609.2

Limited warranty

BenQ warrants this product against any defects in material and workmanship, under normal usage and storage.

Proof of purchase date will be required with any warranty claim. In the event this product is found to be defective within the warranty period, BenQ's only obligation and your exclusive remedy shall be replacement of any defective parts (labor included). To obtain warranty service, immediately notify the dealer from which you purchased the product of any defects.

Important: The above warranty shall be void if the customer fails to operate the product in accordance with BenQ's written instructions, especially the ambient humidity must be in-between 10% and 90%, temperature in-between 0°C and 35°C, altitude lower than 4920 feet, and avoiding to operate the projector in a dusty environment. This warranty gives you specific legal rights, and you may have other rights which vary from country to country.

For other information, please visit www.BenQ.com.

Copyright

Copyright 2013 by BenQ Corporation. All rights reserved. No part of this publication may be reproduced, transmitted, transcribed, stored in a retrieval system or translated into any language or computer language, in any form or by any means, electronic, mechanical, magnetic, optical, chemical, manual or otherwise, without the prior written permission of BenQ Corporation.

Disclaimer

BenQ Corporation makes no representations or warranties, either expressed or implied, with respect to the contents hereof and specifically disclaims any warranties, merchantability or fitness for any particular purpose. Further, BenQ Corporation reserves the right to revise this publication and to make changes from time to time in the contents hereof without obligation to notify any person of such revision or changes.

*DLP, Digital Micromirror Device and DMD are trademarks of Texas Instruments. Others are copyrights of their respective companies or organizations.

FCC statement (for the United States only)

CLASS B: This equipment generates, uses and can radiate radio frequency energy and, if not installed and used in accordance with the instructions, may cause harmful interference to radio communications. However, there is no guarantee that interference will not occur in a particular installation. If this equipment does cause harmful interference to radio or television reception, which can be determined by turning the equipment off and on, the user is encouraged to try to correct the interference by one or more of the following measures:

- Reorient or relocate the receiving antenna.
- Increase the distance between the equipment and receiver.
- Connect the equipment into an outlet on a circuit different from that to which the receiver is connected.
- Consult the dealer or an experienced radio/TV technician for help.

Operation is subject to the following two conditions:

- 1) this device may not cause interference and
- 2) this device must accept any interference, including interference that may cause undesired operation of the device.

FCC Caution: Any changes or modifications not expressly approved by the party responsible for compliance could void the user's authority to operate this equipment.

Accessibility Requirements for Rehabilitation Act of 1973, Section 508

BenQ's commitment to accessible products allows us to support government in making accessible technology choices. BenQ's LCD monitors and projectors are compliant with Section 508 guidelines by including the assistive features as below:

- BenQ's monitors have colored "Power" indicators. While the indicator shows green, it means that the monitor is using the full power. While the indicator shows yellow or amber, it means that the monitor is in suspend or sleep mode and is using less than 2watts of electricity.
- BenQ's monitors have a variety of settings of pre-programmed flicker-free timing to make the screen shown on the monitor readily accessible. The default timing setting is automatically turned on every time the monitor is powered up, and thus reduces the hassle of user intervention.
- BenQ's monitors and projectors have options for brightness and contrast adjustments that text and images could be displayed differently to meet the demands of the visually impaired. Other similar adjustments are also available by using the On-Screen Display (OSD) controls on the products.
- BenQ's multimedia monitors and projectors usually have one or two speakers for audio performance which allow users (including hearing impaired) to interact with the computer systems connected. Speaker controls are typically located on the front-panel.
- Firmware of BenQ's monitors and projectors contain unique product information that helps computer systems to identify BenQ products and activate their Plug-and-Play function when connected.
- All BenQ's monitors and projectors are compatible with the PC99 standard. For example, connectors are color-coded to help users easily connecting products to computer systems correctly.
- Some models of BenQ's monitors and projectors contain additional USB and DVI ports for connection to more devices such as a special headphone to assist the hearing impaired.
- All BenQ monitors and projectors come with user manuals on compact discs which could be easily read by commercial software such as Adobe Reader via a connected computer system. These documents are also available on the BenQ's web site (www.BenQ.com). Other types of documents may be available upon requests.
- BenQ's customer service provides answers and assistance to all our customers through phone calls, facsimiles, e-mails, or web sites.

IC statement (for Canadian users)

This Class B digital apparatus complies with Canadian ICES-003.

Cet appareil numérique de la classe B est conforme à la norme NMB-003 du Canada.

The device complies with RSS-210 of the Industry Canada Rules. Operation is subject to the following two conditions (If the product within RF function):

- 1) this device may not cause interference and
- 2) this device must accept any interference, including interference that may cause undesired operation of the device.

Ce dispositif est conforme à la norme CNR-210 d'Industrie Canada applicable aux appareils radio exempts de licence. Son fonctionnement est sujet aux deux conditions suivantes: (1) le dispositif ne doit pas produire de brouillage préjudiciable, et (2) ce dispositif doit accepter tout brouillage reçu, y compris un brouillage susceptible de provoquer un fonctionnement indésirable.

For UK only

- The mains lead (power cable) on the equipment comes with a moulded plug incorporating a fuse.
- The rating of the fuse is indicated on the pin face of the plug and, if it requires replacing, a fuse approved by ASTA or BSI to BS 1362 of the same rating must be used.
- If the plug has a detachable fuse cover, remember to place the fuse cover back if you need to change the fuse.
- Do NOT use a plug without the fuse cover. If the fuse cover is missing, contact your nearest BenQ Customer Service Center for assistance.

CE DOC

English

DECLARATION OF CONFORMITY

The device complies with the requirements set out in the Council Directives on the Approximation of the Laws of the Member States relating Electromagnetic Compatibility (2004/108/EC) and Low Voltage Directive (2006/95/EC) and Radio and Telecommunications Terminal Equipment Directive (1999/5/EC), the Restriction of The Use of Certain Hazardous Substances in Electrical And Electronic Equipment Directive (2011/65/EU), Turkish EEE Directive; Turkish ErP (Decision 2010/643);the Commission Regulation (EC) No 1275/2008 implementing Directive 2005/32/EC of the European Parliament and of the Council with regard to eco-design requirements for standby and off mode electric power consumption of electrical and electronic household and office equipment, and the Directive 2009/125/EC of the European parliament and of the council establishing a framework for the setting of eco-design requirements for energy-related products.

Français

DÉCLARATION DE CONFORMITÉ

Cet appareil est conforme aux exigences énoncées dans les directives du Conseil sur le rapprochement des législations des États membres concernant la compatibilité électromagnétique (2004/108/CE) et la Directive basse tension (2006/95/CE), la directive équipements radio et équipements terminaux de télécommunication (1999/5/EC), la directive relative à la limitation de l'utilisation de certaines substances dangereuses dans les équipements électriques et électroniques(2011/65/UE), la directive EEE turc, le règlement (CE) n° 1275/2008 mettant en œuvre la directive 2005/32/CE du Parlement européen et du Conseil en ce qui concerne les exigences d'écoconception pour le mode veille et arrêt de la consommation d'énergie électrique d'appareils électriques et électroniques et matériel de bureau, et de la Directive 2009/125/EC du Parlement européen et du Conseil établissant un cadre pour la fixation d'exigences en matière d'écoconception applicables aux produits liés à l'énergie.

Español

DECLARACIÓN DE CONFORMIDAD

Este dispositivo cumple con los requisitos establecidos en las Directivas del Consejo sobre la Aproximación de las Leyes de los Estados Miembros en relación con la Directiva de Compatibilidad Electromagnética (2004/108/EC) y Directiva de Bajo Voltaje (2006/95/EC) y la Directiva sobre equipos radioeléctricos y terminales de comunicación (1999/5/EC), la Directiva sobre la restricción del uso de ciertas sustancias peligrosas en equipos eléctricos y electrónicos (2011/65/UE), la directiva EEE turca, Reglamento (CE) n° 1275/2008 de la Comisión, por el que se desarrolla la Directiva 2005/32/CE del Parlamento Europeo y del Consejo en lo concerniente a los requisitos de diseño ecológico aplicables al consumo de energía eléctrica en los modos preparado y desactivado de los equipos eléctricos y electrónicos domésticos y de oficina y la Directiva 2009/125/EC del Parlamento Europeo y del Consejo por la que se instaura un marco para el establecimiento de requisitos de diseño ecológico aplicables a los productos relacionados con la energía.

Deutsch

KONFORMITÄTSERKLÄRUNG

Dieses Gerät erfüllt die Voraussetzungen, welche in den Richtlinien zur Angleichung der Rechtsvorschriften der Mitgliedstaaten in Bezug auf elektromagnetische Kompatibilität (2004/108/EC), Niederspannungsrichtlinie (2006/95/EC), Richtlinie für Funkanlagen und Telekommunikations-Endeinrichtungen (1999/95/EC), Beschränkung der Verwendung bestimmter gefährlicher Stoffe in Elektro- und Elektronikgeräten (2011/65/EU), Türkische EEE-Direktive, Kommissionreglementierung (EC) Nr. 1275/2008 zur Ausführung der Direktive 2005/32/EC des Europaparlamentes und des Rats für Öko-Design-Voraussetzungen für Stromverbrauch im Standby- und Aus-Modus von Elektro- und Elektronikgeräten für den Heim- und Bürogebrauch und die Direktive 2009/125/EC des Europaparlamentes und es Rats zu Etablierung eines Rahmens zum Aufstellen von Voraussetzungen für Öko-Designs für Energie verbrauchende Produkte aufgestellt wurden.

Italiano

DICHIARAZIONE DI CONFORMITÀ

Il dispositivo è conforme con i requisiti esposti nel Consiglio Direttivo in materia di Approssimazione delle Leggi degli Stati Membri in relazione alla Compatibilità Elettromagnetica (2004/108/EC) e alla Direttiva basso voltaggio (2006/95/EC) e alla Direttiva sugli Apparati Radio e Terminali di Telecomunicazione (1999/5/EC), Direttiva sulla restrizione dell'uso di sostanze pericolose nelle apparecchiature elettriche ed elettroniche (RoHS) (2011/65/UE), Direttiva EEE turca, Regolamento della Commissione (EC) No 1275/ 2008 che implementa la Direttiva 2005/32/EC del Parlamento europeo e del Consiglio in merito ai requisiti di ecodesign per il consumo di alimentazione elettrica in modalità standby e spento per le apparecchiature elettriche domestiche e di lavoro, e la Direttiva 2009/ 125/EC del Parlamento europeo e del Consiglio che stabilisce la struttura dell'impostazione dei requisiti di ecodesign per prodotti basati su energia.

Русский

ЗАЯВЛЕНИЕ О СООТВЕТСТВИИ

Это устройство соответствует требованиям Комиссии на основе законов государств-участников относительно электромагнитной совместимости (2004/108/EC), директиве для низковольтного оборудования (2006/95/EC) и директиве о радио- и телекоммуникационном терминальном оборудовании (1999/5/EC), Директивы по ограничению использования некоторых опасных веществ в электрическом и электронном оборудовании (2011/65/EU), Турецкой директивы EEE, Правил комиссии (EC) No 1275/2008 обеспечивающей выполнение Директивы 2005/32/EC Европейского Парламента и Совета относительно требований экодизайна для потребления энергии в режиме ожидания и в режиме отключения бытовым электрическим и электронным оборудованием и офисной техникой, и Директивой 2009/125/EC Европейского парламента и совета, установившего рамки для создания требований экодизайна для электроприборов.

Svenska

KONFORMITETSDEKLARATION

Denna enhet uppfyller kraven i rådets direktiv om tillnärmning av medlemsstaternas lagstiftning om elektromagnetisk kompatibilitet (2004/108/EG) och lågspänningsdirektiv (2006/95/EG) och direktivet om radioutrustning och teleterminalutrustning (1999/5/EC), begränsning av användningen av vissa farliga ämnen i elektriska och elektroniska produkter (2011/65/EU), turkiskt EEE-direktiv, kommissionsbestämmelse (EG) nr. 1275/2008 med implementering av direktiv 2005/32/EG i Europaparlamentet och rådet för att fastställa krav på ekodesign för standby- och av-läge för strömförbrukning i elektriska och elektroniska hushålls- och kontorsapparater, och Europaparlamentets och rådets direktiv 2009/125/EG om upprättande av en ram för att fastställa krav på ekodesign för energirelaterade produkter.

Nederlands

VERKLARING VAN OVEREENSTEMMING

Dit apparaat voldoet aan de vereisten van de Richtlijn van de Raad betreffende de onderlinge aanpassing van de wetgeving van de lidstaten inzake elektromagnetische compatibiliteit (2004/108/EG) en de Richtlijn betreffende Lage spanningen (2006/95/EG) en de Richtlijn betreffende Radio- en telecommunicatieapparatuur (1999/5/EG), betreffende de beperkingen van het gebruik van bepaalde gevaarlijke stoffen in elektrische en elektronische apparatuur (2011/65/EU), Turkse EEE Richtlijn, Verordening (EG) nr. 1275/2008 tot vaststelling van uitvoeringsbepalingen van Richtlijn 2005/32/EC van het Europees Parlement en de Raad, wat betreft voorschriften inzake ecologisch ontwerp voor het elektriciteitsverbruik van elektrische en elektronische huishoud- en kantoorapparatuur in de stand-by-stand en de uit-stand, en Richtlijn 2009/125/EC van het Europees Parlement en de Raad betreffende de totstandbrenging van een kader voor het vaststellen van eisen inzake ecologisch ontwerp voor energiegerelateerde producten.

Polski

Oświadczenie zgodności

To urządzenie jest zgodne z wymaganiami ustalonymi Dyrektywą Rady o zbliżeniu przepisów prawnych państw członkowskich dotyczących kompatybilności elektromagnetycznej (2004/108/EC), dyrektywą niskiego napięcia (2006/95/EC), dyrektywą w sprawie urządzeń radiowych i końcowych urządzeń telekomunikacyjnych (1999/5/EC), dyrektywą ograniczenia stosowania niektórych niebezpiecznych substancji w wyposażeniu elektrycznym i elektronicznym (2011/65/UE), turecką dyrektywą EEE, rozporządzeniem komisji (WE) nr 1275/2008 w sprawie wykonania dyrektywy 2005/32/WE Parlamentu Europejskiego i Rady w odniesieniu do wymogów dotyczących ekoprojektu dla zużycia energii przez elektryczne i elektroniczne urządzenia gospodarstwa domowego i urządzenia biurowe w trybie czuwania i wyłączenia oraz dyrektywą 2009/125/EC, ustanawiającą ogólne zasady ustalania wymogów dotyczących ekoprojektu dla produktów związanych z energią.

PROHLÁŠENÍ O SHODĚ

Toto zařízení odpovídá požadavkům stanoveným ve směrnici Rady o sblížení právních předpisů členských států týkajících se elektromagnetické kompatibility (2004/108/ES), ve směrnici týkající se nízkonapěťových zařízení (2006/95/ES), ve směrnici o rádiových zařízeních a telekomunikačních koncových zařízeních (1999/5/ES), ve směrnici o omezení používání některých nebezpečných látek v elektrických a elektronických zařízeních (2011/65/EU), v turecké směrnici EEE, v nařízení Komise (ES) č. 1275/2008, kterým se provádí směrnice 2005/32/ES Evropského parlamentu a Rady týkající se požadavků na ekodesign z hlediska spotřeby elektrické energie u elektrických a elektronických zařízení v pohotovostním režimu a ve vypnutém stavu určených pro domácnosti a kanceláře avesměrnici Evropského parlamentu a Rady 2009/125/ES o stanovení rámce pro určení požadavků na ekodesign výrobků spojených se spotřebou energie.

UYUM BEYANI

Bu aygıt Üye Ülkelerin Yasalarının Yakınlaştırılması bağlamında Konsey Direktifleri dahilinde getirilen gereklilikler, Elektromanyetik Uyumluluk (2004/108/EC) ve Düşük Voltaj Direktifi (2006/95/EC) ve Radyo ve Telekomünikasyon Terminal Ekipmanı Direktifi (1999/5/EC), Elektrikli ve Elektronik Aletlerde Tehlikeli Maddelerin Kullanımıyla İlgili Sınırlamalar Direktifi (2011/65/EU) i Türkiye EEC Direktifi, Türk ErP (Karar 2010/643); Avrupa Parlamentosu ve Konseyinin elektrikli ve elektronik ev aletleri ve büro ekipmanlarının bekleme ve kapalı moddayken elektrik tüketimleriyle ilgili eko-tasarım gereklilikleri bağlamında yayınlamış olduğu 2005/32/EC numaralı Direktifin uygulanmasıyla ilgili Komisyon Tüzüğü (EC) No 1275/2008 ve Avrupa Parlamentosu veKonseyinin enerji sarfiyatıyla ürünlerin eko-tasarım gerekliliklerinin düzenlenmesi bağlamında bir çerçeve çizen 2009/125/EC numaralı Direktifiyle uyumludur.

DECLARAÇÃO DE CONFORMIDADE

O dispositivo está conforme aos requisitos definidos pelas Directivas do Conselho sobre a Aproximação das Leis dos Estados-Membros relativamente à Compatibilidade Electromagnética (2004/108/CE) e Directiva de Baixa Tensão (2006/95/CE) e a Directiva relativa aos equipamentos de rádio e equipamentos terminais de telecomunicações (1999/5/CE), a restrição do uso de determinadas substâncias perigosas em equipamentos eléctricos e electrónicos (2011/65/EU), Directiva Turca EEE, Regulamento da Comissão (EC) nº. 1275/2008 que implementa a Directiva 2005/32/EC do Parlamento Europeu e do Conselho relativamente aos requisitos de eco-design para consumo de energia eléctrica no modo de suspensão e desligado de equipamentos eléctricos e electrónicos domésticos e de escritório, e a Directiva 2009/125/EC do Parlamento Europeu e do Conselho, que estabelece uma base para a definição dos requisitos de eco-design para produtos relacionados com energia.

Magyar

MEGFELELŐSÉGI NYILATKOZÁS

Az eszköz megfelel a Bizottság tagállamainak harmonizált jogszabályainak az elektromágneses kompatibilitás (2004/108/EK) és a kisfeszültségű direktíva (2006/95/EK), a rádiófrekvenciás és telekommunikációs végberendezések direktíva (1999/5/EK), továbbá az elektromos eszközök egyes veszélyesanyag-felhasználását korlátozó direktíva (2011/65/EU), a török EEE direktíva, a 1275/2008 sz. Bizottsági szabályozás (EK) (amely az Európai Parlament és a Bizottság 2005/32/EK sz. direktíváját vezeti be az elektromos és elektronikus háztartási és irodai eszközök környezetbarát kialakításával, környezetbarát készlenléti és kikapcsolt állapotbeli fogyasztásával kapcsolatban) és az Európai Parlament és a Bizottság 2009/125/EK sz. direktíva (amely az energiahasználó termékek környezetbarát kialakítási követelményeinek keretrendszerét határozza meg) tekintetében.

Български

ДЕКЛАРАЦИЯ ЗА СЪОТВЕТСТВИЕ

Това устройство отговаря на изискванията, установени от директивите на Европейския съюз за хармонизиране на законодателствата на държавите-членки в областта на електромагнитната съвместимост (2004/108/EC), Директивата за ниско напрежение (2006/95/EC), Директивата за радио и телекомуникационно терминално оборудване (1999/5/EC), Директивата за ограничаване на употребата на някои опасни вещества в електрическото и електронното оборудване (2011/65/EC), турската EEE Директива, Регламент № 1275/2008 на Комисията (EC) по изпълнение на Директива 2005/32/EC на Европейския парламент и на Съвета относно изискванията по отношение на екологичния дизайн за потребление на електроенергия в режим на готовност и изключено положение от електронни и електрически домакински уреди и офис оборудване и Директива 2009/125/EC на Европейския парламент и на Съвета, които установяват работна рамка за създаване на изисквания за екологичен дизайн насвързани с енергетиката продукти.

Hrvatski

DEKLARACIJA O USKLAĐENOSTI

Uređaj je u skladu sa zahtjevima navedenim u Direktivama komisije za usklađivanje zakona država članica u svezi elektromagnetske kompatibilnosti (2004/108/EC) i Direktivom za niske napone (2006/95/EC) i Direktivom za radio i telekomunikacijske terminalne uređaje (1999/5/EC), Direktivi o ograničenju upotrebe određenih opasnih tvari u električnoj i elektroničkoj opremi (2011/65/EU), EEE direktivi Turske, Propisu komisije (EC) br. 1275/2008 o implementiranju Direktive 2005/32/EC Europskog parlamenta i Vijeća po pitanju ekodizajnerskih zahtjeva za električnu potrošnju u mirovanju i isključenom stanju električne i elektroničke opreme u kućanstvu i uredima, te Direktive 2009/125/EC Europskog parlamenta i Vijeća koja uspostavlja radni okvir za određivanje ekodizajnerskih zahtjeva za energetske proizvode.

Română

DECLARAȚIE DE CONFORMITATE

Acest dispozitiv este în conformitate cu prevederile stabilite prin Directivele Consiliului privind apropierea legislațiilor statelor membre cu privire la compatibilitatea electromagnetică (2004/108/CE) și Directiva privind joasa tensiune (2006/95/CE) și Directiva privind echipamentele hertziene și echipamentele terminale de telecomunicații (1999/5/CE), Directiva de Restricție a Utilizării Anumitor Substanțe Periculoase în Echipamentele Electrice și Electronice (2011/65/UE), Directive EEE pentru Turcia, Regulamentul Comisiei (EC) Nr. 1275/2008 de implementare a Directivei 2005/32/EC a Parlamentului European și a Consiliului cu privire la elementele de design ecologic pentru consumul energetic al echipamentelor electrice și electronice de uz casnic și de birou în modurile de așteptare și oprire și Directiva 2009/125/EC a Parlamentului European și a Consiliului pentru stabilirea unui cadru de lucru în îndeplinirea cerințelor de design ecologic al produselor cu consum energetic.

Ελληνικά

ΔΗΛΩΣΗ ΣΥΜΜΟΡΦΩΣΗΣ

Η παρούσα συσκευή συμμορφώνεται με τις απαιτήσεις που ορίζονται στις Οδηγίες του Ευρωπαϊκού Συμβουλίου για την προσέγγιση των νομοθεσιών των χωρών-μελών σχετικά με την Ηλεκτρομαγνητική Συμβατότητα (2004/108/ΕΚ) και την Οδηγία περί Χαμηλών Τάσεων (2006/95/ΕΚ) και την Οδηγία περί Τερματικού εξοπλισμού Ραδιοφωνίας και Τηλεπικοινωνιών (1999/5/ΕΚ), στην απαγόρευση της χρήσης ορισμένων επικίνδυνων υλικών στην Οδηγία Ηλεκτρικού και ηλεκτρονικού εξοπλισμού (2011/65/ΕΕ), στην Τουρκική οδηγία EEE, στον Κανονισμό της Επιτροπής (ΕΚ) Αρ. 1275/2008 που εφαρμόζει την Οδηγία 2005/32/ΕΚ του Ευρωπαϊκού Κοινοβουλίου και του Συμβουλίου όσον αφορά τις απαιτήσεις οικολογικού σχεδιασμού για κατανάλωση ρεύματος στην αναμονή και στην απενεργοποίηση του ηλεκτρικού και ηλεκτρονικού εξοπλισμού, οικιακού εξοπλισμού και εξοπλισμού γραφείου και την Οδηγία 2009/125/ΕΚ του Ευρωπαϊκού Κοινοβουλίου και του Συμβουλίου που εγκαθιστά ένα πλαίσιο για τη ρύθμιση των απαιτήσεων οικολογικού σχεδιασμού για προϊόντα που έχουν σχέση με την κατανάλωση ενέργειας.

Danich

OVERENSSTEMMELSESERKLÆRING

Apparatet er i overensstemmelse med kravene i Rådets direktiver om indbyrdes tilnærmelse af medlemsstaternes lovgivning om elektromagnetisk kompatibilitet (2004/108/EF) og lavspændingsdirektiv (2006/95/EF) og radio- og teleterminaludstyr (1999/5/EF), begrænsning af anvendelsen af visse farlige stoffer i elektrisk og elektronisk udstyr (2011/65/EU), Tyrkisk EEE direktiv, Kommissionens forordning (EF) nr. 1275/2008 om gennemførelse af direktiv 2005/32/EF af Europa-Parlamentets og Rådets direktiv med hensyn til krav til miljøvenligt design for elforbrug i standbytilstand og slukket tilstand af elektrisk og elektronisk husholdnings- og kontorudstyr, og direktiv 2009/125/EF af Europa-Parlamentet og Rådet om rammerne for fastlæggelse af krav til miljøvenligt design af energiforbrugende produkter.

Finnish

VAATIMUSTENMUKAISUUSVAKUUTUS

Laite täyttää sähkömagneettista yhteensopivuutta koskevan EMC-direktiivin (2004/108/EY), pienjännitedirektiivin (2006/95/EY), radio- ja telepäätelaitedirektiivin (1999/5/EY) ja vaarallisten aineiden käytön rajoittamista sähkö- ja elektroniikkalaitteissa koskevan direktiivin (2011/65/EU), turkkilaisen EEE-direktiivin; komission asetuksen (EY) N:o 1275/2008 direktiivin 2005/32/EY täytäntöönpanosta kotitalouksissa ja toimistoissa käytettävien sähkö- ja elektroniikkalaitteiden lepovirtakulutuksen ekologista suunnittelua koskevien vaatimusten osalta sekä Euroopan parlamentin ja neuvoston direktiivin 2009/125/EY energiaan liittyvien tuotteiden ekologiselle suunnittelulle asetettävien vaatimusten puitteista.

Norwegian

SAMSVARERKLÆRING

Enheten er i samsvar med de angitte kravene i EU-direktivene om tilnærming av lovene i medlemslandene angående elektromagnetisk kompatibilitet (2004/108/EC), lavspenning (2006/95/EC) og radio og telekommunikasjonsutstyr (1999/5/EC), begrensningen i bruk av visse farlige substanser i EU-direktivet for elektrisk og elektronisk utstyr (2011/65/EU), det tyrkiske EEE-direktivet, EU-kommisjonsforskrift nr. 1275/2008 som iverksetter EU-parlamentets og EU-rådets direktiv 2005/32/EC angående øko-designkrav til strømforbruk i beredt og avslått elektrisk og elektronisk utstyr til hjem og kontor og EU-parlamentets direktiv 2009/125/EC som etablerer et rammeverk for etableringen av øko-designkrav for energirelaterte produkter.

WEEE directive

English

Disposal of Waste Electrical and Electronic Equipment and/or Battery by users in private households in the European Union.



WEEE



Battery

This symbol on the product or on the packaging indicates that this can not be disposed of as household waste. You must dispose of your waste equipment and/or battery by handling it over to the applicable take-back scheme for the recycling of electrical and electronic equipment and/or battery. For more information about recycling of this equipment and/or battery, please contact your city office, the shop where you purchased the equipment or your household waste disposal service. The recycling of materials will help to conserve natural resources and ensure that it is recycled in a manner that protects human health and environment.

Recycling information: See <http://www.benq.com/support/recycle> for details.

Français

Directive DEEE

Mise au rebut des déchets d'équipements électriques et électroniques et/ou des piles par les particuliers dans l'Union Européenne.



WEEE



Pile

Ce symbole figurant sur le produit ou l'emballage signifie que celui-ci ne peut pas être jeté avec les ordures ménagères. Vous devez mettre vos déchets d'équipements et/ou piles au rebut en le déposant dans un point de collecte prévu à cet effet afin que les équipements électroniques et électriques et/ou piles soient recyclés. Pour de plus amples informations sur le recyclage de ce produit et/ou cette pile, veuillez prendre contact avec l'organisme local compétent, le service d'élimination des déchets ménagers ou le point de vente du produit. Le recyclage des matériaux aidera à conserver les ressources naturelles et à s'assurer qu'ils seront recyclés d'une façon que cela protège la santé humaine et l'environnement.

Recycling information: See <http://www.benq.com/support/recycle> for details.

Directiva WEEE



WEEE

Residuos de aparatos eléctricos y electrónicos y/o batería por parte de los usuarios domésticos privados en la Unión Europea.

El símbolo que muestra el producto o el embalaje indica que no puede ser desechado como residuo doméstico. Para desechar el equipo siga las directrices aplicables para el reciclaje de equipo eléctrico y electrónico y/o batería.

Para obtener más información sobre el reciclaje de este equipo y/o batería, póngase en contacto con el ayuntamiento, la tienda donde adquirió el equipo o el servicio de recogida de basuras. Al reciclar materiales ayudamos a conservar el medio natural y a garantizar el reciclaje de manera que proteja la salud y el medioambiente.



Batería

Recycling information: See <http://www.benq.com/support/recycle> for details.

WEEE-Richtlinie

Entsorgung von Elektro- und Elektronikgeräten bzw. Batterien in Privathaushalten der Europäischen Union.

Das Symbol auf der Produktverpackung zeigt an, dass dieses Gerät nicht mit dem normalen Hausmüll entsorgt werden darf. Sie sind verpflichtet, Ihre Altgeräte bzw. Batterien entsprechend der geltenden Bestimmungen für die Wiederverwertung von Elektro- und Elektronik-Altgeräten bzw. Batterien zu entsorgen. Weitere Informationen über das Recycling dieses Geräts bzw. Batterie erhalten Sie von Ihren örtlichen Behörden, Ihrem Fachhändler oder der lokalen Rücknahmestelle. Fachgerechtes Wertstoffrecycling spart nicht nur wertvolle Ressourcen, sondern schützt auch Umwelt und Gesundheit.



WEEE



Batterie

Recycling information: See <http://www.benq.com/support/recycle> for details.

Direttiva WEEE

Smaltimento di apparecchi elettrici ed elettronici e/o batterie nell'Unione Europea da parte di utenti privati.

Questo simbolo sul prodotto o sulla confezione indica che l'articolo non può essere smaltito come i normali rifiuti domestici. È necessario smaltire le apparecchiature e/o batterie secondo quanto previsto dagli schemi di recupero per il riciclaggio di apparecchiature elettriche e elettroniche e/o batterie. Per ulteriori informazioni sul riciclaggio di questo apparecchio e/o batteria, contattare l'ente della propria città, il negozio dove è stato acquistato l'apparecchio o il proprio servizio di smaltimento rifiuti domestici. Il riciclaggio dei materiali contribuisce a ridurre il consumo di risorse naturali e assicura che i materiali siano riciclati tutelando la salute umana e l'ambiente.



WEEE



Batteria

Recycling information: See <http://www.benq.com/support/recycle> for details.

Директива WEEE



WEEE



Аккумулятор

Утилизация электрического и электронного оборудования и/или аккумуляторов населением в Европейском союзе.

Данный символ на изделии или на упаковке означает, что данное изделие запрещается утилизировать наравне с бытовыми отходами. Вы должны сдавать все пришедшие в негодность устройства и/или аккумуляторы для утилизации на специальный пункт сбора электрических или электронных устройств и/или аккумуляторов. Для получения подробных сведений о переработке этого оборудования и/или аккумуляторов обратитесь в местные органы управления, магазин, в котором был приобретен продукт, или службу по сбору бытовых отходов. Переработка материалов поможет сохранить природные ресурсы и обеспечит безопасность для здоровья людей и окружающей среды.

Recycling information: See <http://www.benq.com/support/recycle> for details.

WEEE-direktiv



WEEE



Batteri

Riktlinjer för kassering av avfall som utgörs av eller innehåller elektriska eller elektroniska produkter och/eller batteri, gällande hushåll i EU.

Den här symbolen kan finnas på produkten eller på förpackningen och betyder att produkten inte kan kasseras som vanligt hushållsavfall. När du vill kassera produkten och/eller batteri måste du lämna in den på det ställe som avses för återvinning av elektriska eller elektroniska produkter och/eller batteri. Om du vill ha mer information om återvinning av den här typen av utrustning och/eller batteri kan du vända dig till din kommun, ditt inköpsställe eller till den lokala sophämtningen. Genom att återvinna materialet i produkten kan vi spara på naturtillgångarna och försäkra oss om att produkten återvinns på ett sätt som skyddar människors hälsa och miljön.

Recycling information: See <http://www.benq.com/support/recycle> for details.

WEEE-richtlijn



WEEE



Accu

Wegwerpen van elektrische en elektronische apparatuur en/of accu's door huishoudens in de Europese Unie.

Dit symbool geeft aan dat het product niet met het huishoudelijke afval kan worden aangeboden. U moet afgedankte apparatuur en/of accu's wegwerpen door ze in te leveren op de inzamelpunten voor elektrische en elektronische apparatuur en/of accu's. Voor meer informatie over het hergebruik van deze apparatuur en/of de accu neemt u contact op met uw gemeente, de winkel waar u de apparatuur hebt gekocht of de milieudienst van de gemeente. Door het recyclen van de materialen worden natuurlijke hulpbronnen behouden en helpt u de natuur en de volksgezondheid te beschermen.

Recycling information: See <http://www.benq.com/support/recycle> for details.

Polski

Dyrektywa WEEE



WEEE



Bateria

Utylizacja odpadów z urządzeń elektrycznych i elektronicznych lub baterii przez użytkowników prywatnych w Unii Europejskiej.

Ten symbol na urządzeniu lub opakowaniu oznacza, że nie może być ono utylizowane razem z odpadami domowymi. Zużyty sprzęt lub baterie należy przekazać do odpowiedniego punktu zwrotu sprzętu elektrycznego i elektronicznego w celu wtórnego przetworzenia. Szczegółowe informacje dotyczące wtórnego przetwarzania tych urządzeń lub baterii można uzyskać, kontaktując się z lokalną administracją, sprzedawcą lub lokalnym przedsiębiorstwem oczyszczania. Przetwarzanie wtórne materiałów pomaga w zachowaniu surowców naturalnych i utylizacji w sposób przyjazny dla ludzkiego zdrowia i środowiska.

Recycling information: See <http://www.benq.com/support/recycle> for details.

Čeština

Směrnice WEEE



WEEE



Baterie

Likvidace vyřazených elektrických a elektronických zařízení anebo baterií v domácnostech uživatelů v Evropské unii.

Tento symbol na výrobku nebo na jeho obalu znamená, že dané zařízení nelze vyhodit do běžného domovního odpadu. Vyřazené elektrické nebo elektronické zařízení anebo baterii je nutno zlikvidovat odevzdáním k recyklaci v souladu s platným plánem recyklace elektrických a elektronických zařízení anebo baterií. Další informace o recyklaci tohoto zařízení anebo baterií získáte u místních úřadů, v obchodě, kde jste výrobek zakoupili nebo u společnosti, která se zabývá likvidací domovního odpadu. Recyklace materiálů pomáhá chránit přírodní zdroje a zaručuje likvidaci výrobku způsobem, který je šetrný k lidskému zdraví a životnímu prostředí.

Recycling information: See <http://www.benq.com/support/recycle> for details.

Türkçe

WEEE direktifi



WEEE



Pil

Avrupa Birliği ülkelerinde özel ev eşyası kullanıcıları tarafından Elektrikli ve Elektronik Cihazların ve/veya Pillerin Atılması.

Ürün yada ambalaj üzerindeki bu sembol, bunun evsel atık olarak işlem görmemesi gerektiğini ifade etmektedir. Atık cihazınızı ve/veya pilleri, elektrikli ve elektronik cihazların ve/veya pillerin geri dönüşümü için uygulanabilir geri alma şemasına göre ele alarak atmalısınız. Bu cihazın ve/veya pillerin geri dönüşümü hakkında daha fazla bilgi edinmek için lütfen cihazı satın aldığınız yerel bayiye veya dükkana yada ev eşyası uzlaştırma servisine başvurun. Materyallerin geri dönüşümü, doğal kaynakların korunmasını ve insan sağlığına ve çevreye zarar verilmeksizin geri dönüştürülmesini güvence etmektedir.

Recycling information: See <http://www.benq.com/support/recycle> for details.

Português

Directiva REE



WEEE



Bateria

Eliminação de Resíduos de Equipamentos Eléctricos e Electrónicos e/ou Baterias por particulares na União Europeia.

Este símbolo no produto ou na embalagem indica que não pode ser eliminado como lixo doméstico. Deverá eliminar os resíduos dos seus equipamentos e/ou baterias entregando-os nos pontos de recolha aplicáveis para reciclagem de equipamentos de equipamentos eléctricos e electrónicos e/ou baterias. Para mais informações sobre a reciclagem destes equipamentos e/ou baterias, contacte a sua câmara municipal, a loja onde adquiriu o equipamento ou serviço de recolha de lixo doméstico. A reciclagem de materiais contribuirá para a conservação dos recursos naturais e assegura que são reciclados de forma a proteger a saúde humana e o ambiente.

Recycling information: See <http://www.benq.com/support/recycle> for details.

Magyar

WEEE irányelv



WEEE



Akkumulátor

Az Európai Unióban a háztartások elektromos és elektronikus hulladékainak és/vagy az akkumulátorok kezeléséről szóló irányelv.

A terméken vagy a csomagoláson ez a szimbólum azt jelzi, azt aháztartási hulladékoktól külön kell kezelni. A készüléket és/vagy az akkumulátorokat az elektronikus és elektromos hulladékokra és/vagy az akkumulátorokra érvényes újrahasznosítási rendszer keretein belül kell leadni újrahasznosításra. A készülék és/vagy akkumulátorok újrahasznosítás céljára való begyűjtéséről bővebb információt kaphat a helyi önkormányzatnál, a vásárlás helyén vagy a háztartási hulladékot szállító szolgáltatójánál. Az anyagok újrahasznosításra való begyűjtése hozzájárul a természeti erőforrások megőrzéséhez és biztosítja, hogy a hulladékok szelektálása az emberi egészséget és a környezetet védő módon történjék.

Recycling information: See <http://www.benq.com/support/recycle> for details.

Директива WEEE



WEEE



Батерия

Изхвърляне на отпадъчно електрическо и електронно оборудване и/или батерии от потребители в частни домакинства в Европейския съюз.

Този символ върху продукт или неговата опаковка указва, че не може да бъде изхвърлян заедно с останалите домакински отпадъци. Трябва да изхвърлите отпадъчното оборудване и/или батерии, като го предадете в подходящ пункт за събиране и рециклиране на електрическо и електронно оборудване и/или батерии. За повече информация относно рециклирането на този уред и/или батерии, моля, свържете се със съответния офис във Вашия град, с магазина, от който сте закупили продукта или с местната служба за събиране на битови отпадъци. Рециклирането на материалите ще спомогне за запазване на природните ресурси и ще осигури рециклиране по запазващ човешкото здраве и околната среда начин.

Recycling information: See <http://www.benq.com/support/recycle> for details.

Хрватски

WEEE direktiva



WEEE



Батерия

Odlaganje u otpad električnih i elektroničkih uređaja i/ili baterija iz kućanstava u Europskoj uniji.

Ovaj simbol na proizvodu ili pakiranju naznačuje da se ovaj proizvod ne može odbaciti s kućnim otpadom. Uređaje za otpad i/ili baterije trebate odložiti u otpad u skladu s pravilima povrata, zbrinjavanja i reciklaže električnih i elektroničkih uređaja i/ili baterija. Više informacija o recikliranju ovog uređaja i/ili baeterije, potražite u vašem mjesnom uredu, u trgovini gdje ste kupili proizvod ili u službi koja prikuplja vaš kućni otpad. Recikliranje materijala pomoći će očuvanju prirodnih resursa i osigurati recikliranje na način koji štiti ljudsko zdravlje i prirodni okoliš.

Recycling information: See <http://www.benq.com/support/recycle> for details.

Directiva WEEE



WEEE



Baterie

Evacuarea deșeurilor echipamentelor electrice și electronice și/sau bateriilor de către utilizatorii casnici din Uniunea Europeană.

Acest simbol de pe produs sau de pe ambalaj indică că acest produs nupoate fi evacuat ca deșeu casnic. Trebuie să evacuați deșeurile de echipamente și/sau bateria prin predarea conform schemei de preluare pentru reciclare a componentelor electrice și electronice și/sau a bateriilor. Pentru informații suplimentare privind reciclarea acestui echipament și/sau a bateriei, contactați primăria orașului dvs., magazinul de unde ați achiziționat echipamentul sau serviciul de salubritate pentru deșeuri menajere. Reciclarea acestor materiale va ajuta la păstrarea resurselor naturale și asigură că sunt reciclate într-o modalitate care protejează viața și mediul oamenilor.

Recycling information: See <http://www.benq.com/support/recycle> for details.

Οδηγία WEEE



WEEE



Μπαταρία

Απόρριψη άχρηστου ηλεκτρολογικού και ηλεκτρονικού εξοπλισμού ή/και μπαταριών από χρήστες σε νοικοκυριά εντός της Ευρωπαϊκής Ένωσης.

Το παρόν σύμβολο στο προϊόν ή τη συσκευασία υποδηλώνει ότι αυτό δεν μπορεί να απορριφθεί με τα οικιακά απορρίμματα. Πρέπει να φροντίσετε για την απόρριψη του άχρηστου εξοπλισμού σας ή/και μπαταριών, παραδίδοντάς τα σε αρμόδιο φορέα παραλαβής με σκοπό την ανακύκλωση ηλεκτρολογικού και ηλεκτρονικού εξοπλισμού ή/και μπαταριών. Για περισσότερες πληροφορίες σχετικά με την ανακύκλωση του παρόντος εξοπλισμού ή/και μπαταριών, παρακαλούμε απευθυνθείτε στο αρμόδιο γραφείο του δήμου, στο κατάστημα όπου αγοράσατε τον εξοπλισμό ή στην υπηρεσία αποκομιδής οικιακών απορριμμάτων. Η ανακύκλωση των υλικών θα βοηθήσει την εξοικονόμηση φυσικών πόρων και θα διασφαλίσει ότι αυτά ανακυκλώνονται με τρόπο που προστατεύει την ανθρώπινη υγεία και το περιβάλλον.

Recycling information: See <http://www.benq.com/support/recycle> for details.

For Mexico only (for RF module only)

El manual de usuario contendrá las siguientes leyendas o su equivalente en una posición notoria:

“La operación de este equipo está sujeta a las siguientes dos condiciones:

- (1) es posible que este equipo o dispositivo no cause interferencia perjudicial y
- (2) este equipo o dispositivo debe aceptar cualquier interferencia, incluyendo la que pueda causar su operación no deseada.

For Korea:

B Class

B 급기기 (가정용 방송통신기기)

이 기기는 가정용(B 급)으로 전자파적합등록을 한 기기로서 주로 가정에서 사용하는 것을 목적으로 하며, 모든 지역에서 사용할 수 있습니다.

한국에 해당 (RF 모듈이 포함된 제품의 경우)

해당 무선설비는 전파혼신 가능성이 있으므로 인명

안전과 관련된 서비스는 할 수 없음

(Translation: the service related to human safety is not allowed because this device may have the possibility of the radio interference.)

日本専用です

同梱した電源コードセットは本機以外の電気機器で使用できません

VCCI (CLASS B)

この装置は、クラスB情報技術装置です。この装置は、家庭環境で使用することを目的としていますが、この装置がラジオやテレビジョン受信機に近接して使用されると、受信障害を引き起こすことがあります。

取扱説明書に従って正しい取り扱いをしてください。

(RF モジュール付きの製品の場合)

電波法により5GHz帯は屋内使用に限ります。

僅適用於台灣地區 (若產品有WLAN/BT module)

本產品內含無線模組。若該無線模組支援5GHz 頻帶, 5.15GHz~5.25GHz限於室內使用。

依**低功率電波輻射性電機管理辦法**要求

第 12 條經型式認證合格之低功率射頻電機，非經許可，公司、商號或使用者均不得擅自變更頻率、加大功率或變更原設計之特性及功能。

第 14 條低功率射頻電機之使用不得影響飛航安全及干擾合法通信；經發現有干擾現象時，應立即停用，並改善至無干擾時方得繼續使用。

前項合法通信，指依電信法規定作業之無線電通信。

低功率射頻電機須忍受合法通信或工業、科學及醫療用電波輻射性電機設備之干擾。

使用電池的注意事項 (當產品附有遙控器時)

電池的使用方式或型號如果錯誤，可能會導致化學物質的洩漏或爆炸。請注意下列事項：

- 安裝電池時，請確認電池的正負極已依照電池室中所標示的方向正確安裝。
- 不同品牌與類型的電池(例如碳鋅電池與鹼性電池)具有不同的特性。請勿混合使用不同品牌與類型的電池。
- 當電池電量用盡時，請儘速更換新電池。換新電池時，請將全部電池一次換新。
- 長時間不使用遙控器時，請將電池從遙控器中取出。
- 請勿將新的和舊的電池混合使用。將新電池與舊電池混合使用會減短電池的使用壽命，或導致化學液從不良的電池中洩漏出來。
- 電池中洩漏出來的化學液可能會刺激皮膚並腐蝕金屬接點。假使有任何化學物質從電池中滲漏出來，請立即以乾布擦拭乾淨並更換電池。
- 耗盡的電池請依照相關之適用規章回收或丟棄。詳細資訊，請聯繫當地廢料管理機關。

台灣廢電池回收標誌



廢電池請回收

电池安全注意事项 (当产品附有遥控器时)

使用错误类型的电池可能导致化学物质泄漏或爆炸。请遵循下列事项：

- 务必按照电池仓内的正极和负极标记以正确方向装入电池。
- 不同类型的电池具有不同的特性。请勿混用不同类型的电池。
- 请勿混用新旧电池。混用新旧电池会缩短电池使用时间或导致旧电池化学物质泄漏。
- 电池不能正常工作时，应立即更换它们。
- 电池泄漏的化学物质可能刺痛皮肤。如果电池泄漏出任何化学物质，应立即用干布擦拭干净，并尽快更换电池。
- 由于存放条件不同，电视随附的电池的使用时间可能缩短。在3个月内或在初次使用后尽快更换它们。
- 耗尽的电池请依照相关之适用规章回收或丢弃。详细信息，请联系当地废料管理机构

中国RoHS



依据中国政府针对《电子信息产品污染控制管理办法》为控制和减少电子信息产品废弃后对环境造成的污染，促进生产和销售低污染电子信息产品，保护环境和人体健康，仅提供有关本产品可能含有有毒及有害物质如后：

零部件名称	有毒有害物质或元素					
	铅 (Pb)	汞 (Hg)	镉 (Cd)	六价铬 (Cr6+)	多溴联苯 (PBBs)	多溴二苯醚 (PBDEs)
塑料外框	○	○	○	○	○	○
金属机构	X	○	○	○	○	○
灯源	○	X	○	○	○	○
电源基板	X	○	○	○	○	○
主基板	X	○	○	○	○	○
按键基板	X	○	○	○	○	○
镜头	X	○	○	○	○	○
风扇	X	○	○	○	○	○
电源线	X	○	○	○	○	○
其他线材	X	○	○	○	○	○
电池	○	○	○	○	○	○
无线适配卡	○	○	○	○	○	○

○：表示该有害物质在该部件所有均质材料中的含量均在《电子信息产品中有毒有害物质的限量要求标准》规定的限量要求以下。

X：表示该有害物质至少在该部件的某一均质材料中的含量超出《电子信息产品中有毒有害物质的限量要求标准》规定的限量要求；但是上表中打“x”的部件，其含量超出是因为目前业界还没有成熟的可替代的技术。

有关中国《电子信息产品污染控制管理办法》之相关规定请参考信息产业部所公布之信息。

WEEE 指令 (针对中国地区)

<废弃电器电子产品回收处理管理条例>或<China WEEE>

产品废弃时请交给当地有资质的回收单位处理。

<废电池>

本产品含有电池，废弃时请交给当地有资质的回收单位处理。

UAE

TRA
REGISTERED NO:ER0095782/12
DEALER NO:DA0045787/10

SINGAPORE

Complies with
IDA Standards
DB101054