

ANY SPOT[®] **TRAVELER[®]** Wireless Portable Sound Systems

AS-TV10, AS-TV8, TV5i & TV5X
Plus TXRM Stationary Transmitter
USER'S GUIDE



**ALL INCLUSIVE BATTERY
OPERATED PORTABLE PA SYSTEM
COMPACT, LIGHTWEIGHT, HIGH OUTPUT POWER &
CLEAR SOUND.**



MAKERS OF THE ORIGINAL
HOT SPOT PERSONAL MONITOR



Contents

Introduction	1
Before using theTV10, TV8, TV5i & TV5X.....	1
TV10 Front & Rear panel configuration.....	2
TV10 Master Control Panel.....	3
AS-TV8 Series Rear Panel Configuration.....	4
AS-TV8 & TV10 Series Description of Functions	5-11
Power Supply/Charger.....	5, 6
Power Switch.....	5, 6
AS-TV8 Master Control.....	5, 6
Digital Echo System.....	7
Audio Link Transmitter.....	7, 8
Wireless Mic/Audio Link Receiver	8
Bluetooth Receiver Module.....	9
RM-CD CD/MP3/SD/USB Player.....	10
RM-CDV CD/DVD/MP3/SD/USB Player.....	11
RM-DIGIMP Digital Player.....	11
RM-CASSP Cassette Player.....	11
TV5i & TV5X	
TV5i Front & Rear Panel.....	12, 13
TV5i Battery Replacement.....	12
TV5i Bluetooth Connection.....	13
TV5MP3 Optional Media Player.....	14, 15
Wireless Microphone Receiver Option TV5-REC for TV5i & TV5X.....	15
TV5X Panel Configuration.....	16
WIRELESS HAND HELD & BODY PACK TRANSMITTERS	
TVHH Microphone Description & Functions.....	18-21
TVH2 Microphone Description & Functions.....	21-23
AS-TVBP Body Pack Transmitter Description & Functions.....	23, 24
AS-TVBR Body Pack Receiver Description & Functions.....	25, 26
AS-TVMBP Body Pack Transmitter Description & Functions.....	26-28
Maintenance.....	29
AS-TXRM Stationary Transmitter.....	30, 31
Setup and Operation of TXRM.....	31
Specifications	32-40
AS-TV10 Specifications.....	32
AS-TV8 Specifications.....	33
TV5i Specifications.....	34
TV5X Specifications.....	35
AS-TVREC Wireless Receiver Module.....	36, 37
AS-TVTX & TXRM Audio Link Transmitter Module.....	37
AS-TVEC Digital Echo Module.....	37
AS-TVHH Handheld Microphones.....	37-38
AS-TVH2 Handheld Microphones.....	38
AS-TVMBP Body Pack Transmitter.....	39
AS-TVBP Body Pack Transmitter.....	39, 40
TV5MP3 Digital Media Player.....	39
TRAVELER APPLICATION TABLE	41

Operating Manual for AS-TV10/TV8/TV5i/TV5X Series

Please visit www.galaxyaudio.com for the latest updates

Introduction

Thank you for purchasing the TV10/TV8/TV5i/TV5X series wireless portable sound systems. These units feature an “all in one” design that allows them to be configured with a variety of different function modules to suit your specific needs. With rich, full sound and plenty of power, the TV10/TV8 series is ideally suited to cover large areas. The TV5's, with their compact size, is ideal for classrooms, conference rooms, and guided tours. This manual covers the complete functions and operations of the TV10/TV8, TV5i and TV5X including all optional function modules. It also covers the TXRM Stationary Transmitter, the TVHH/TVHHC & TVH2 Handheld Wireless Mics, the TVMBP Bodypack and AS-TVBP Pendant Transmitters. To use these systems to their fullest potential please read this manual carefully.

Before Using the TV10, TV8 or TV5i & TV5X

1. The TV10, TV8 and TV5 use a universal AC switching power supply/charger that will operate on voltages of 100~240V,50/60Hz. The TV10, TV8 power supplies are internal, while the TV5's is external. Verify that the voltage to which you are connecting is in this range and then connect the AC power cord from the Traveler to the wall outlet.
2. **Charge the battery for at least 8 hours with the Power Switch OFF prior to first time use** to maintain the quality of the battery and provide maximum operation time. When charging, the charging indicator lights RED. When charging is almost complete, the indicator will flash alternately RED and GREEN. After the battery is fully charged, the indicator will light GREEN. After the initial charge the Traveler may be operated on either AC or Battery power. When operating on AC power the Traveler will simultaneously recharge its internal batteries.
3. These units have auto protection circuitry that will protect the battery from being overcharged or overused. When running on battery power and the power switch LED blinks RED, the battery power is down to 30%. When the battery is nearly exhausted, the system will turn off automatically to protect the battery.



AS-TV8 & AS-TV10

CHARGING FUNCTIONS:

1. Charge indicator will illuminate red when charging and green when fully charged
2. Unit can be permanently left on charge.
3. For maximum battery life, recharge after every use and at least once every 3 months.
4. When in use and battery capacity is < 20% the power switch flashes red.



TV5i & TV5X

CHARGING FUNCTIONS:

- Charging- LEDs light in sequence.
- Fully charged-Only top Green LED will light.

USEFUL TIPS:

- Unit can be permanently left on charge.
- For maximum battery life, recharge after every use and at least once every 3 months.

AS-TV10 Front & Rear Panel Configuration



Front Side

1. Retractable Handle
2. Handle
3. Horn Tweeter
4. Speaker Grille
5. Woofer
6. Port
7. Wheels



Rear Side

1. Retractable Handle
2. Optional Wireless Receivers
3. Optional CD/MP3 Player
4. Main Power Switch and Charging Indicator (Optional Transmitter module)
5. Master Control Panel
6. AC Power Input
7. Battery Cover
8. Wheels

TV10 Master Control Panel

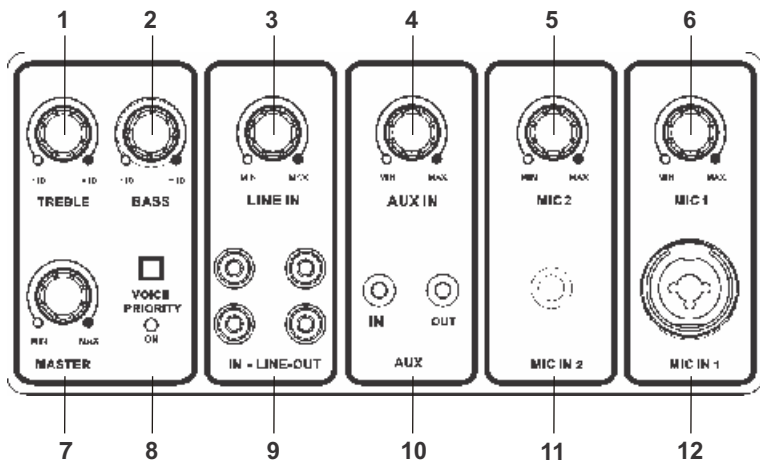

1. TREBLE control with center detent
2. BASS control with center detent
3. LINE IN volume control
4. AUX IN volume control
5. MIC2 volume control
6. MIC1 volume control
7. MASTER control for overall system volume
8. VOICE PRIORITY button to activate or end the microphone priority function
9. LINE-IN (RCA phone jack) to connect with external music sources including CD/MP3/DVD/iPod players etc.
LINE OUT (RCA phone jack) to connect with external mixed-signal recorder or active speaker system
10. AUX IN (1/8" jack) to connect with external music sources including CD/MP3 DVD/iPod players etc.
AUX OUT (1/8" jack) to connect with external mixed-signal recorder or active speaker system
11. MIC IN 2 (1/4" jack) microphone connector
12. MIC IN 1 (XLR / 1/4" jack) combo microphone connector

AS-TV8 Series Rear Panel Configuration

AS-TV8CT2 (Part# for unit shown with options)

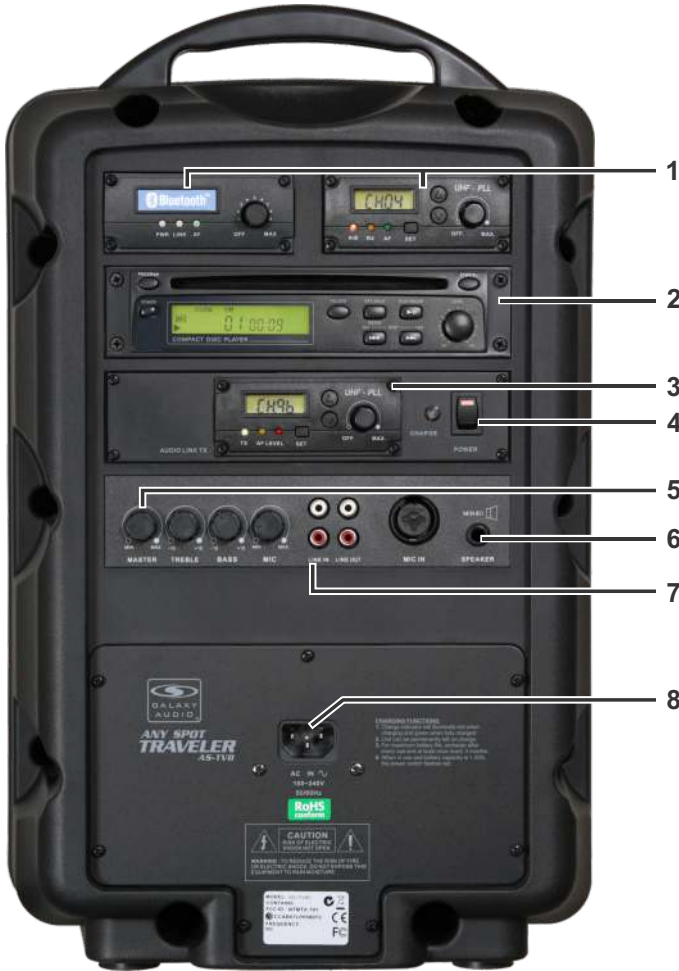

1. Optional Receiver Modules
2. Optional MEDIA Player
3. Audio Link Transmitter
4. Power Switch
5. Mixer
6. Speaker Out
7. In/Out Jacks
8. Power Supply/Charging Input

Description of Functions for AS-TV8 & TV10

A. Power Supply/Charging Input

1. AC Power Cable connector
2. Batteries (behind cover)
3. Battery cover

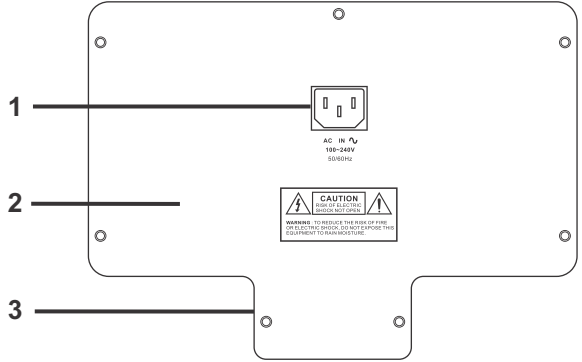

B. Power Switch and Charge Indicator for AS-TV8 & TV10

1. Power LED
2. Charging indicator
3. Power On/Off switch

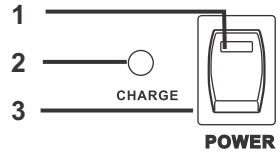

C. TV8 Master Control Panel

1. Master volume control
2. Treble control
3. Bass control
4. Mic volume control
(For wired Mic connected
to Mic In jack 7)
5. Line in RCA jacks
6. Line out RCA jacks
7. Mic in XLR/1/4" jack
8. Speaker level output jack.
Minimum 8 ohm external speaker

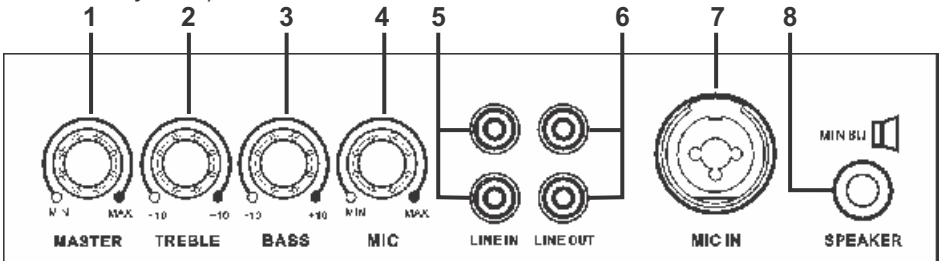

Operation of TV8 & TV10 Portable Sound System

A. Power Supply/Charger (see page 5)

1. There is a universal AC switching power supply/charger built into the system that will operate on voltages of 100~240V,50/60Hz. Verify that the voltage to which you are connecting is in that range and then connect the AC power cord from the AC IN (**A1**) to the wall outlet.

B. Power Switch and Charge Indicator (see page 5)

1. Power LED lights constant red under normal operation when power switch is on. Blinking Power LED indicates 30% of battery power remaining.
2. When charging is almost complete, the indicator will flash RED and GREEN. After the battery is fully charged, the indicator lights GREEN. The Universal Power Supply/Battery Charger allows the Traveler to be used anywhere in the world. The Traveler will operate for an unlimited time on AC power and for about 6 hours on just battery power. A full recharge of the batteries takes about 4 hours. The Traveler may be operated while recharging the batteries without affecting the charge time. If a power failure occurs when operating on AC, the Traveler will seamlessly switch over to battery power.

C. TV8 Master Control Panel (see the page 5)

1. Master Volume Control.
2. Turn the Treble control (**C2**) counterclockwise to decrease the treble, and turn clockwise to increase the treble. The center position (straight up) produces a flat response.
3. Turn the Bass control (**C3**) counterclockwise to decrease the bass, and turn clockwise to increase the bass. The center position (straight up) produces a flat response.
4. Mic Volume (**C3**) for wired Mic In jack (**C7**).
5. The system contains Line In, Line Out, and Mic in jacks for connecting external audio devices.
6. Line In (**C5**): RCA jacks to connect external audio sources, such as CD/MP3 players or iPods. The volume of the Line In is controlled solely by the Master (**C5**) on the TV8 individual on the TV10.
7. Line Out (**C6**): RCA jacks for sending the entire mix signal to other audio devices, such as recorders, mixers, or power amps.
8. Mic In (**C7**): XLR or 1/4" (6.3mm) phone jack for wired microphones. Volume of this input is controlled by Mic In (**C4**) and the Master (**C1**).
9. **Speaker Out: (C8)** Used to connect to an external unpowered speaker (8Ω Min.) **AS-TV8 Only**

D. Digital Echo System (AS-TVEC) (for AS-TV8)

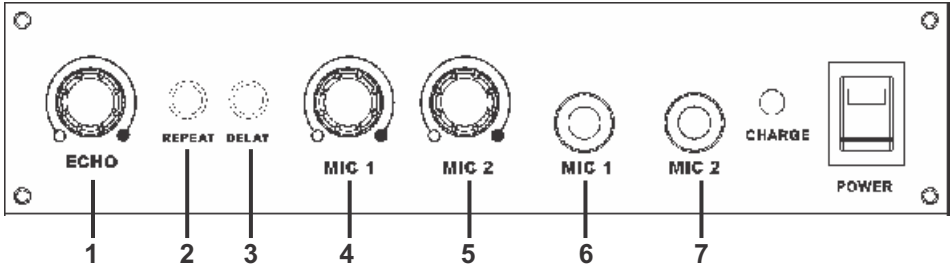

1. Master echo volume control
2. Delay repeat control
3. Delay time control
4. Wired mic 1 volume control
5. Wired mic 2 volume control
6. Wired mic 1-1/4" input jack
7. Wired mic 2-1/4" input jack

1. Turn the Echo Control (**D-1**) clockwise to turn on the echo system. Then use this control to adjust the level of echo in the mix. Echo will be applied to all 3 mic inputs.
2. Adjust the repeat button (**D-2**) to select the number of repeats desired. Adjust the delay button to select the delay time.
3. Mic input jacks (**D-6** and **D-7**) are provided for connecting wired Mics. Mic volume is controlled by **D-4** and **D-5** plus the Master (**C-1**, Pg.5).

E. Audio Link Transmitter (AS-TVTX) (for AS-TV8/TV10)

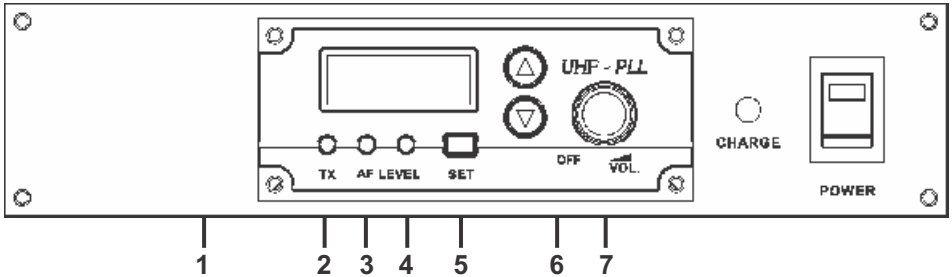

1. LCD display
2. TX indicator
3. Low audio level indicator
4. High audio level indicator
5. Enter Setting
6. Channel selector
7. Power switch and volume control

► **This module transmits the entire audio mix from one Traveler to another Traveler that is equipped with a wireless Mic/Audio Link Receiver.**

1. Turn the power switch (**E-7**) clockwise to turn on the transmitter.
2. The LCD display (**E-1**) will show "On" and the channel in use when the unit was last turned off.
3. To select a different channel, press the set button (**E-5**) and the channel will flash in the LCD display. Press the up or down button (**E-6**) to select the transmit channel, and then press the set button again to enter the setting. The LCD will then automatically display the selected channel. To display the frequency of the selected channel press and hold either the up or down button.
4. Turn the volume control (**E-7**) to adjust the audio transmit level. Use this control in conjunction with the volume controls on the receiving Traveler.

- When transmitting signal, the TX indicator (**E-2**) will light Green to show the transmitting condition. The AF Level indicator lights Yellow (**E-3**) to show a low audio level and lights Red (**E-4**) to show high audio level.
- Set up the receiving Traveler according to the procedure outlined in: section (**F**) page 12. Wireless Mic/Audio Link Receiver Select the same channel chosen on the transmitting Traveler.

Optional Modules for TRAVELERS

F. Wireless Microphone/Audio Link Receiver (AS-TVREC for TV8/TV10) & (TV5REC for TV5i/TVX)

- LCD display
- A/B diversity indicator
- RF indicator
- AF level indicator
- Channel Set
- Channel selector
- Power switch & mic. volume

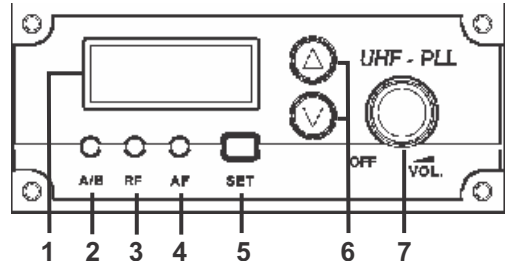

F. Wireless Mic/Audio Link Receiver (AS-TVREC)

This system may include one or two receivers with selectable PLL 96 channel operation. These modules receive signals from wireless Mics or from another Traveler equipped with an Audio Link Transmitter.

- Turn the power switch clockwise to turn on the receiver.
- The LCD display will show "On" and the channel that was last in use when the unit was turned off.
- To select a different channel, press the set button. The channel number will flash in the LCD display. Press the up or down button to select a channel to use, and then press the set button. After a channel has been set, press either the up or down button to display the frequency of the selected channel.
- Adjust the volume control to the desired level.
- When receiving signal, the A/B diversity indicator will light RED or Green to show the normal condition. The RF indicator will light to show RF received and the AF indicator will show audio received.

TV5-REC Wireless Mic/Audio Receiver on Page 15.

G. Bluetooth Receiver

Module

(TV-RECBT for TV8/TV10)

(TV5-RECBT for TV5i & TV5X)

1. PWR - Power indicator
2. LINK - Bluetooth connectivity indicator
3. AF - Audio Frequency indicator
4. On/Off/Volume control knob

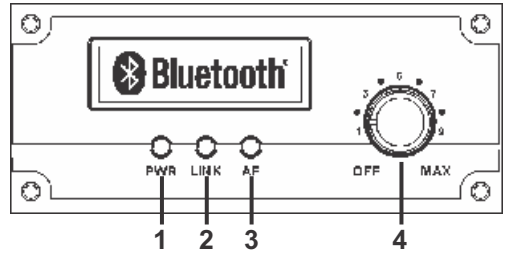

1. Turn the knob clockwise to switch on the Bluetooth module. Set a mid-range volume level to begin.
2. You will hear a tone and the PWR indicator (LED) will light blue. The LINK indicator will also flash blue to indicate that the module is ready to pair with another Bluetooth device.
3. When in pairing mode, activate a Bluetooth connection scan on your device that will serve as a source of audio. When the search is complete, select a device named "Galaxy Traveler" from the pairing list. Your device will attempt to connect with the Bluetooth module.
4. When the devices have successfully paired, the module will sound a prompt tone again. The LINK indicator will light steady blue.
5. You are now ready to stream audio via the Bluetooth connection from your device. You can adjust the audio volume on your device or using the volume knob on the Bluetooth receiver module.
6. The AF indicator will light when an audio signal is streamed from your playback device and received by the Bluetooth module.
7. If a phone call is incoming during playback, the audio stream will be interrupted for the user to take the call. When the call is finished, the Bluetooth module will be automatically re-link and audio files will continue playback from where they were interrupted.
8. When a user moves out of range for the Bluetooth connection, the audio stream will be severed until the user returns to a location within range of the module. The range is approximately 30 feet. However, it depends on the operating system that's installed on the device. Occasionally it's necessary to manually reconnect to the Bluetooth following the steps above.

Optional Modules for TV10/TV8

H. RM-CD CD/MP3/SD/USB Player w/Remote **OPTION C**

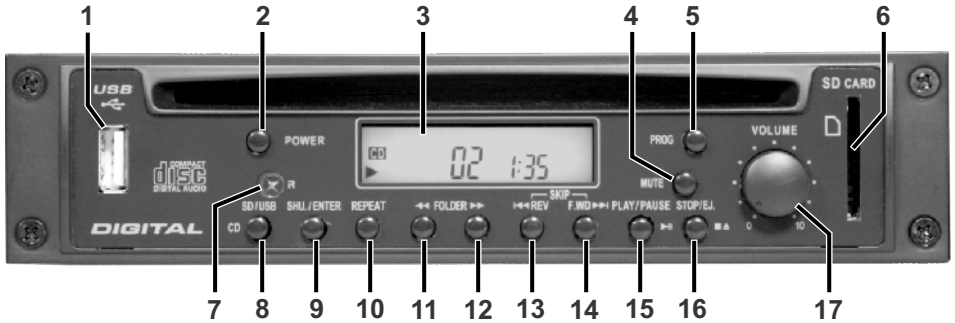

1. USB Connector
2. Power Switch
3. LCD display
4. Mute
5. Program Button
6. SD Card Slot: Accepts SD and SDHC Cards containing MP3 files
7. IR Window
8. CD / USB / SD: Press this key to select USB, SD, or CD mode.
9. Shuffle and execute button
10. Repeat: Repeat play mode
11. Previous Folder
12. Next Folder
13. Reverse
14. Fast Forward
15. Play/Pause
16. Stop/Eject
17. Volume Control

1. Push the power switch (2) to turn on the player. Put a CD in the CD slot (G10) or push the Stop/Eject button (5) to take a CD out of the slot.

2. Press the Play/Pause button (8) to start or pause CD/MP3 play. Turn the volume control (9) to adjust to the proper volume. Push the Stop/Eject button to stop or change the CD or MP3 disc.

3. Press the Forward (7) or Reverse (6) button to skip forward to the next track or reverse to the previous track. Holding down the Forward or Reverse button will continuously forward or reverse the tracks.

Tip: MP3 files on a USB or Flash card should be loaded on the media in the order of desired playback. Do not have files in individual folders.

4. Repeat/Shuffle (4) has three modes:

1. Repeat one song
2. Repeat all songs
3. Shuffle for random play.

5. Create Program Playlist:

Step 1: Press Prog button (1) to begin setting up the program playlist

Step 2: Select a song (see step 3 and 6)

Step 3: Press Repeat (4) to enter the song. Repeat steps 2 and 3 to enter additional songs.

Step 4: Press Play (4) to play the programmed songs in memory

Note: that the program will reset once the Program button is pressed again.

6. To select a folder from an MP3, press Folder button (11). Use Forward or Reverse buttons to select a song.

RM-CDV CD/DVD/MP3/SD/USB Player w/Remote and Video Out
OPTION J



RM-DIGIMP Digital Player w/ Remote **OPTION B**



RM-CASSP Cassette Player **OPTION A**



TV5i Front and Rear Panel Configuration

TV5iM1K9 (Part# for unit shown with options)



- 1. Tweeter (1")
- 2. Neodymium Driver (5")
- 3. Optional UHF Receiver
- 4. Optional Digital Media Player

- 5. Controls, Battery Meter, Mic in
- 6. Power Switch
- 7. DC Input
- 8. Battery Door

Battery replacement



Remove battery door screws



Pull battery out

Lead-Acid battery



Remove connectors and replace new battery in reverse order
RED = Positive;
BLACK = Negative

I. Rear Panel of TV5i

1. DC Power Input
2. Power Switch
3. Power LED
4. Master
5. Treble
6. Bass
7. Battery meter
8. Voice priority: when activated, Priority LED (6) will light.
9. Voice priority indicator
10. Bluetooth Button (if equipped)
11. Aux in control
12. Aux in, 1/8" Jack
13. Aux out, 1/8" Jack
14. Mic (wired) in control
15. Mic in, 1/4"/ XLR Combo jack
16. Battery Cover Plate

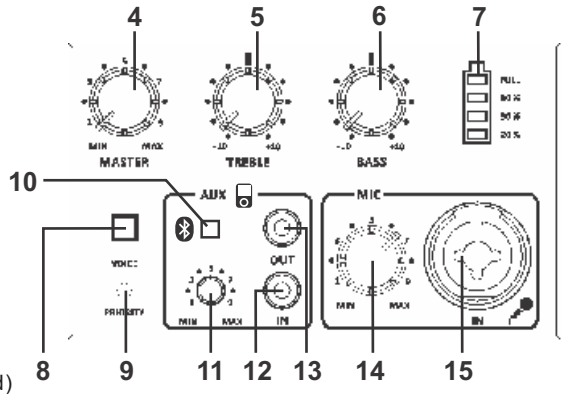

Guide for TV5i Bluetooth connection

Turn On and Off:

Press and hold Bluetooth button for approximately 2 seconds to activate the Bluetooth function. Press and hold Bluetooth button for approximately 2 seconds again, to turn the Bluetooth function off.

Bluetooth pairing:

1. When Bluetooth function is activated successfully, it will emit with a prompt tone.
2. The button will flash Blue as a sign that the device is in pairing mode.
3. Activate the Bluetooth connection on your smartphone or any Bluetooth device you are using.
4. Find the device name "Galaxy Traveler" on the pairing list to connect your device.
5. When the pairing is successful, it emit out with a prompt tone again and the blue indicator light will be illuminated.
6. You are ready to stream audio from your device.

Caution:

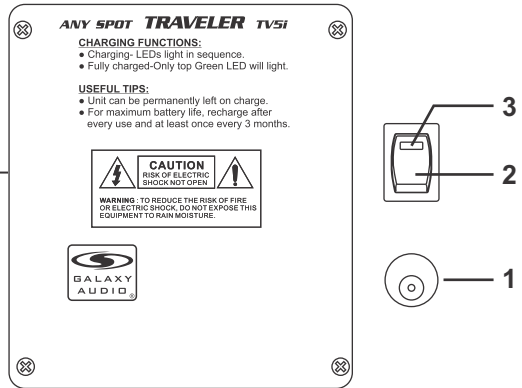

1. During Bluetooth connection, audio playback will stop when a call is made to your smartphone or tablet. When the call is finished, Bluetooth will be relinked automatically and audio files will be played.
2. The Bluetooth connection can be lost when the device gets out of range of the TV5i. When this happens it may automatically re-link when back in range, or it may have to be manually reset. This is dependant on the device and it's operating system.

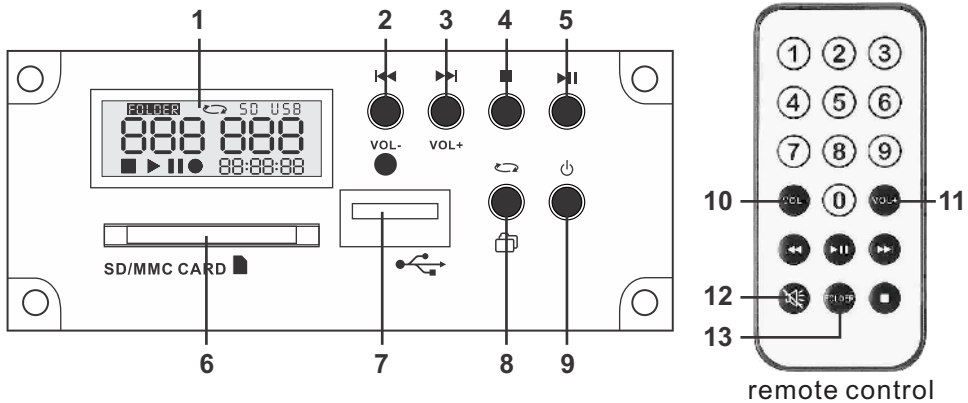

J. TV5MP3 Optional Media Player for TV5i & TV5X



- | | |
|---|---|
| <ol style="list-style-type: none"> 1. LCD display 2. Previous track / volume down (works during playback) 3. Next track / volume up (works during playback) 4. Stop 5. Play / Pause 6. SD/MMC port 7. USB port | <ol style="list-style-type: none"> 8. Repeat / Folder select 9. Power 10. Volume down (MUTE when in minimum level) 11. Volume up 12. Mute 13. Folder select |
|---|---|

1. Press and hold (9) for 1 second to turn TV5MP3 player on. Press and hold (9) for 1 second to turn off.
2. Press (2) to play previous audio track; press (3) to play next audio track. Press (4) to stop any playback.
3. Press (5) to Play or to Pause any audio track.
4. When both SD card and USB are installed, USB has higher priority to be readout.
5. Do not pull SD card out directly or it may be damaged. Push in and SD card will eject.
6. Repeat / Folder Select:
 - a. There are 3 modes for repeat during audio playback.
 -  :To repeat a track.
 -  :To repeat all tracks in all album.
 -  :To repeat all tracks in a single album.
 - b. When not in playback, press (8) to select a desired folder/album with NEXT, PREV buttons. Finally press PLAY to end the setting.
7. During playback, press VOL+ to increase volume; press VOL- to decrease volume.

K. Wireless Microphone Receiver Option (TV5-REC) For TV5i and TV5X

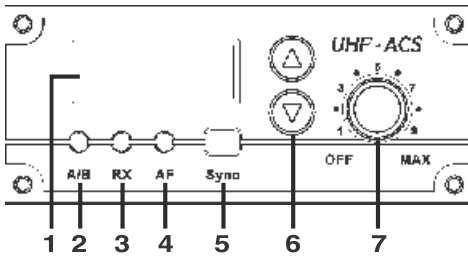

1. LCD window
2. Antenna A and B indicator
3. RF signal indicator
4. AF signal indicator
5. Synchronization button
6. Channel up/down adjustment
7. Receiver power on/off control and volume adjustment

Operation:

Turn receiver power on/off control (**K7**) clockwise until a click occurs. A text of “**SYNC**” will appear on LCD window for about 2 seconds followed by a channel number. To turn it off, turn the control counterclockwise until a click occurs. A text of “**OFF**” will appear on LCD window and will disappear after 2 to 3 seconds.

How SYNC works:

“**SYNC**” function can find a clean channel and assign it to transmitter in the range, about 3 m. Turn on your microphone or transmitter first and press SYNC button, in a few seconds the receiver will have found a clear channel and Synced the transmitter to it. During synchronization, the RF indicator will blink.

Change channel manually:

Press and hold UP or DOWN button for 1 second until channel number is blinking. Select a desired number using the UP or DOWN button. The selected channel number will be confirmed in 1 second if no other adjustment is made.

- * When you have more than 1 receiver complete the channel setup in one receiver first and then set up the second receiver.
- * Be sure to use a different channel number for each receiver.

TV5X Panel Configuration

TV5XM1FK9 (Part# for unit shown with options)

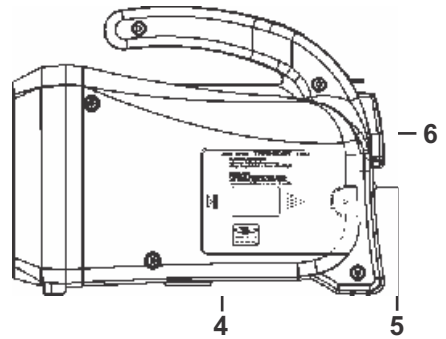
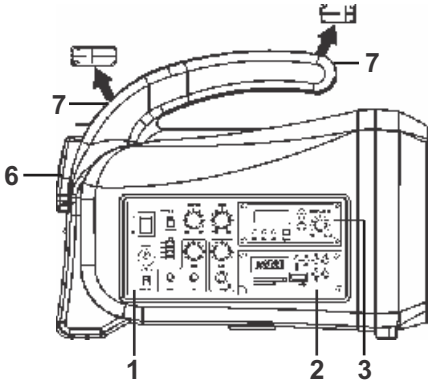

1. Controls, Battery Life, Mic in
2. Digital Media Player
3. Wireless Receiver
4. Battery Door

5. LED indicator
6. Drop in Hand Held Charger
7. Strap Attachment Point

K. Control Panel for TV5X

1. Power
2. Voice priority indicator
3. Voice priority:
when activated,
Priority LED (2) will light.
4. Master
5. Tone
6. Battery meter
7. DC IN
8. 5V charger
9. Aux out, 1/8" Jack
10. Aux in, 1/8" Jack
11. Aux in control
12. Mic (wired) in control
13. Wired mic input

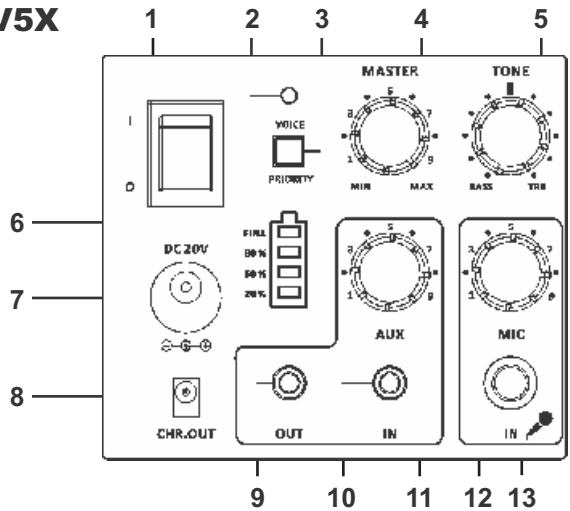

J. TV5MP3 Optional Media Player for TV5i & TV5X (see pages 14-15)

K. For a Description and Operation of the Optional Wireless Microphone Receiver (TV5-REC) (see pages 15).

Battery replacement TV5X



Remove battery door screws



Pull battery out



Remove connectors and replace new battery in reverse order
RED = Positive;
BLACK = Negative

WIRELESS HAND HELD & BODY PACK TRANSMITTERS



Description of Functions for Hand held Microphone AS-TVHH/TVHHC

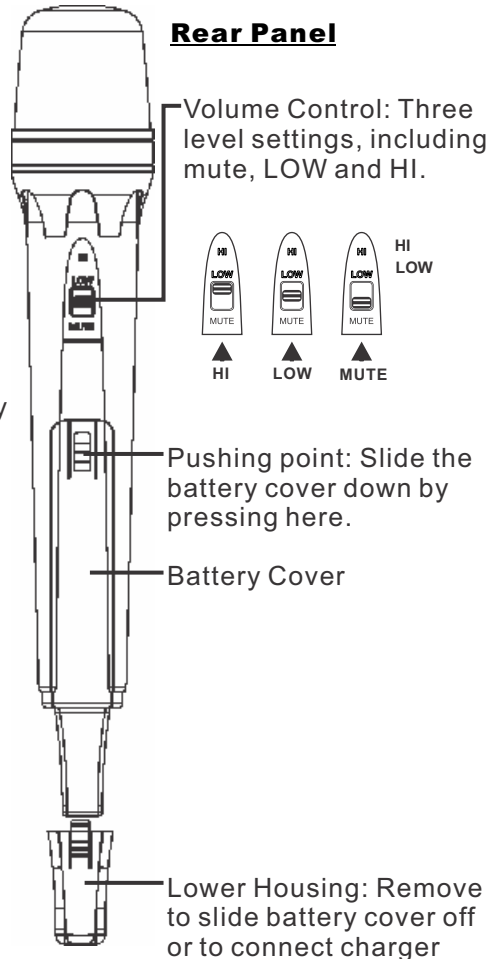
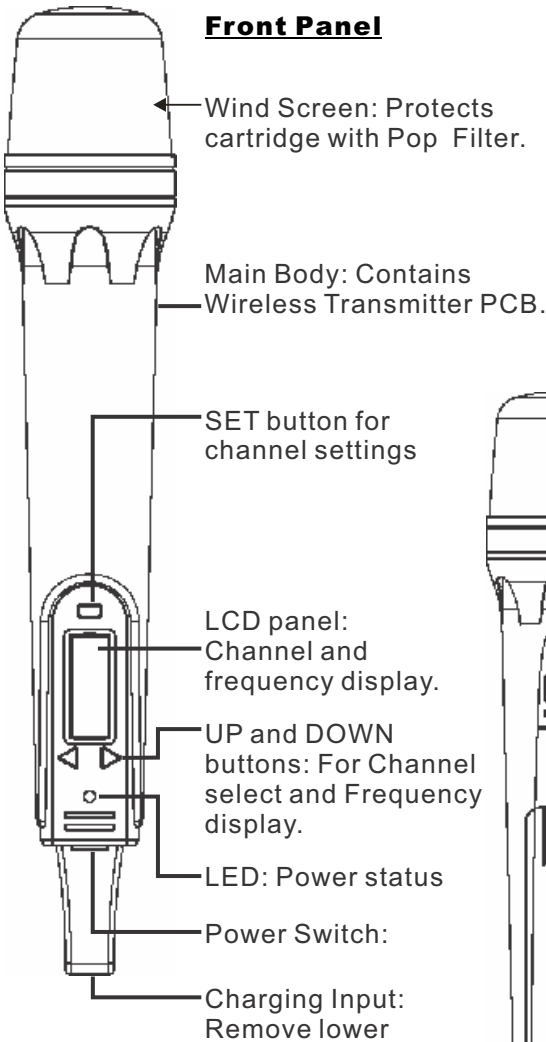



Operation of Hand Held Microphone AS-TVHH/TVHHC

A. Battery Installation Steps:

1. Turn off the microphone before inserting batteries.
2. Press in the latch to release the lower housing and slide it off.
3. Press in the latch to release the battery cover and slide it down.
4. Insert 2 disposable batteries of 1.5V type or 2 rechargeable batteries of 1.2V type.
5. Observe proper polarity while inserting batteries.
6. Slide the battery cover back to its original position.
7. Install the lower housing back to the lower part of the microphone.

B. Switch-On Steps:

1. Press the power switch and hold for about two seconds until the LED turns to RED and "on" is displayed in the LCD. 
2. The LCD will then automatically display the selected channel.

 :Channel indicator.

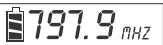
 :Press and hold the Up or Down button to display the corresponding frequency.

C. Switch Off steps:

1. Press and hold power switch for about two seconds until the LCD displays OFF. 

D. Channel/Frequency Settings (with power on):

1. Press the SET button and hold for about 2 seconds.
2. The Channel number display will start flashing.
3. Press the Up button to display a higher numbered channel.
4. Press the Down button to display a lower numbered channel.
5. Press the SET button to activate the selected channel.



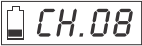
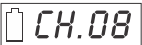

E. LCD Indications:

1.  :Three bars means batteries are fully charged.
2.  :One bar indicates low batteries. Replace or recharge the batteries.
3.  :No bars showing indicates batteries are exhausted and after flashing three times the power will automatically shut off.

F. Battery Charging Steps:

1. Rechargeable batteries need to be NiMH AA 1.2V with an amperage of 2100mAH or less as the charging function is limited to batteries of this rating.
2. Recharging is best accomplished by using the AS-DCTVHH charger

3. Charging status:

- a.  Battery indicator flashing: Non-Rechargeable batteries installed or no batteries installed. Check the batteries.
- b.  Battery indicator is flashing and LCD backlight is on: Failing, corroded, or over-temperature batteries.
- c.  One or two bars showing: Batteries are charging successfully.
- d.  Three bars showing: Batteries have been fully charged.

* Please note the microphone will be turned off automatically while it is being charged.

G. Troubleshooting:

1. **LED doesn't light when power switch is pressed to turn on mic.**
 - a. Make sure that the batteries are not discharged.
 - b. Make sure that the batteries are installed correctly.
2. **LCD shows  when power switch is pressed to turn mic off.**
 - a. Press the SET, UP and DOWN buttons at the same time in order to turn the microphone off automatically. The LCD display will flash about ten times and then the microphone will turn off automatically. The microphone should now turn on and off normally.
 - b. If the problem persists, call for service.
3. **LCD panel shows unusual indications.**
 - a. Remove the batteries from the microphone and re-install them.
4. **No audio from microphone.**
 - a. Check that the frequency of the transmitter is the same as that of the receiver.
 - b. Make sure that the Mic switch is not set to Mute.

- c. Check if the distance between the transmitter and the receiver is too great.
- d. Check if the transmitter or the receiver is too close to any large metal objects.

5. Interference and signal Disturbance.

- a. Make sure there are no other wireless systems operating on the same frequency in the same area. This includes Microphones, televisions, radio stations, etc. Try setting the transmitter and receiver to a new channel.

H. Q&A

- 1. **Q:** How long can the microphone be operated with fully charged batteries?
A: Re-chargeable batteries will last approximately 8 to 10 hours. Disposable batteries will last approximately 13 hours.
- Q:** How much time is required to recharge batteries from a fully exhausted state?
A: Approximately 4 to 5 hours.

Description of Functions for Hand held Microphone AS-TVH2

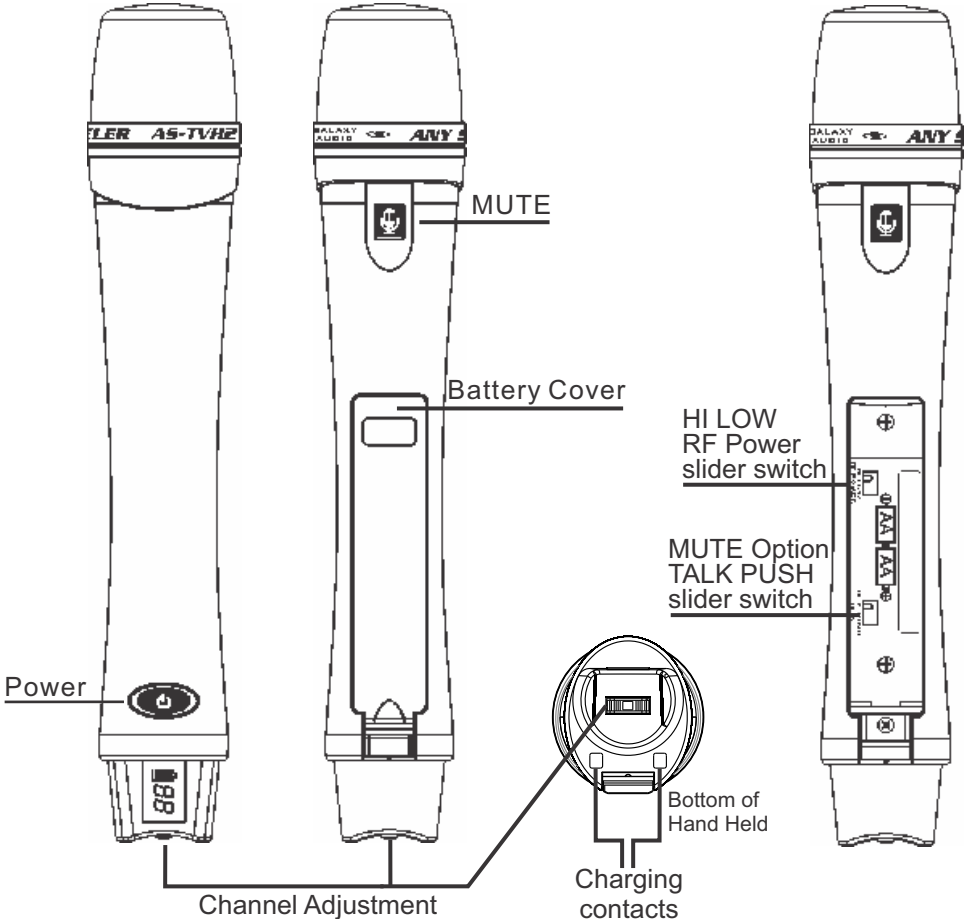

Operation of Hand held Microphone AS-TVH2

A. Battery Installation Steps:

1. Turn off the microphone before inserting batteries.
2. Press in the latch to release the battery cover and slide it down.
3. Insert 2 disposable batteries of 1.5V type or 2 rechargeable batteries of 1.2V type.
4. Observe proper polarity while inserting batteries.
5. Slide the battery cover back to its original position.
6. Install the lower housing back to the lower part of the microphone.

B. Switch-On Steps:

1. Press the power switch and hold for about two seconds until the LED turns to Blue and  is displayed in the LCD.
2. The LCD will then automatically display the selected channel.

 :Channel indicator.

C. Switch Off steps:

1. Press and hold power switch for about two seconds until the LCD displays 

D. Channel/Frequency Settings (with power on):

1. Press the Channel adjustment button in and hold for about 3 seconds.
2. The Channel number display will start flashing.
3. Press the Channel adjustment button to the right to display a higher numbered channel.
4. Press the Channel adjustment button to the left to display a lower numbered channel.
5. Press the Channel adjustment button in to activate the selected channel.

E. Power Settings:

1. Remove battery cover and batteries, the switch is under the batteries.
2. Slide the RF Power switch to the desired position HI for 10mW low for 1mW

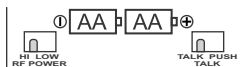



F. Mute options

1. Remove battery cover and batteries, the switch is under the batteries.
2. With the switch in the talk position the microphone is on until you press the mute button.

3. With the switch in the Push position the microphone is muted until you press and hold the mute button.
4. In either position, when the mute switch is green the microphone is on, when the mute button is red the microphone is muted.

F. LCD Indications:

1.  : Three bars means batteries are fully charged.
2.  : One bar indicates low batteries. Replace or recharge the batteries.
3.  : No bars showing indicates batteries are exhausted and after flashing three times the power will automatically shut off.

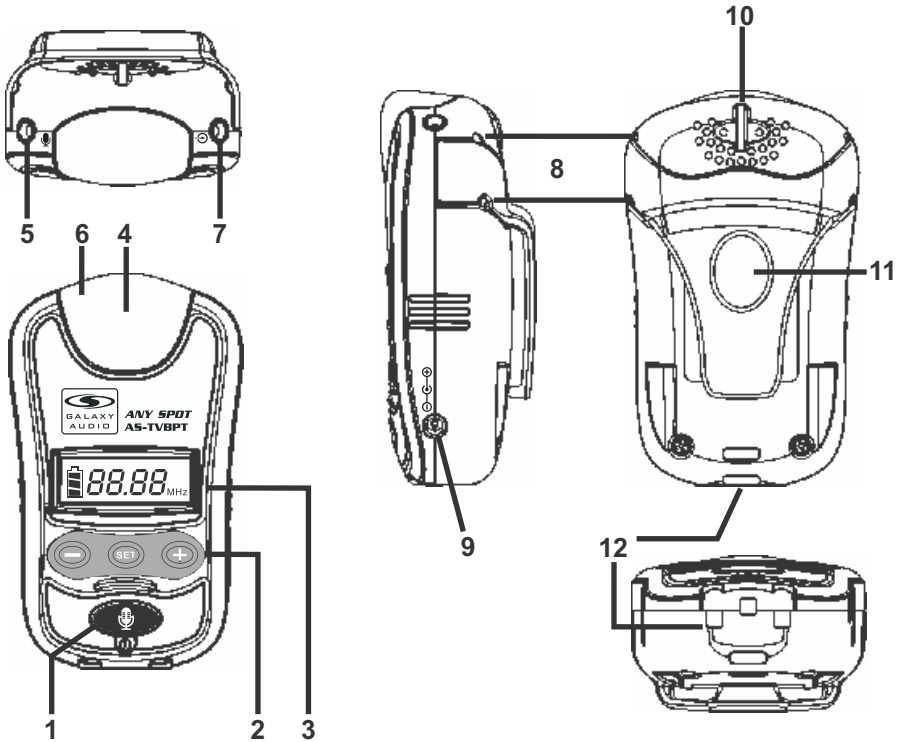

Description of Functions for Body Pack Transmitter AS-TVBP



- | | |
|-----------------------------------|----------------------------|
| 1. POWER / MUTE switch | 7. Aux input |
| 2. Channel / Volume switch | 8. Strap attachment point |
| 3. LCD | 9. DC charging input |
| 4. Mesh Screen Cover (microphone) | 10. Strap attachment point |
| 5. External mic. Input | 11. Belt clip |
| 6. Charging indicator (built-in) | 12. Charging terminal |

Operation of AS-TVBPT Transmitter

A. Switch-On Steps:

1. Press the power switch and hold for about two seconds until the LED turns to Blue and  is displayed in the LCD.
2.  The LCD will then automatically display the selected channel.

B: Volume adjust

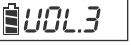
1.  Press the + button to increase press the – button to decrease. The range is 3 steps

D. Channel/Frequency Settings (with power on):

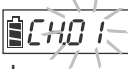
1. Press the Set button in and hold for about 3 seconds. 
2. The Channel number display will start flashing.
3. Press the + button to display a higher numbered channel.
4. Press the - button to display a lower numbered channel.
5. Press the set button to activate the selected channel.

E. Switch Off steps:

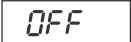
1. Press and hold power switch for about two seconds until the LCD displays 

Description of Functions for Body Pack Receiver AS-TVBP

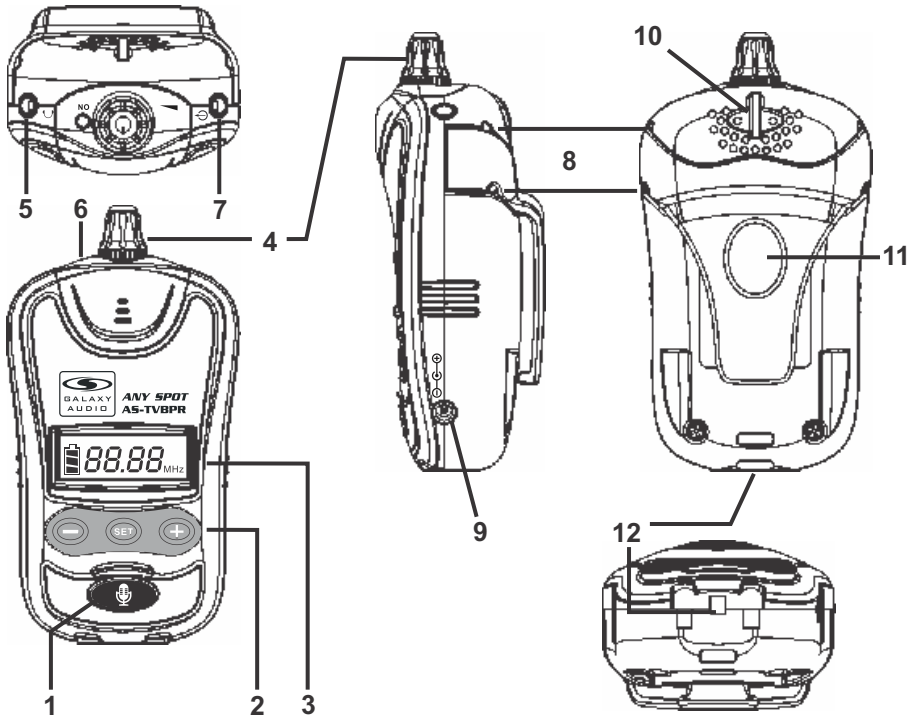

- | | |
|----------------------------------|----------------------------|
| 1. MUTE switch | 7. Line out |
| 2. Channel | 8. Strap attachment point |
| 3. LCD | 9. DC charging input |
| 4. Power / Volume switch | 10. Strap attachment point |
| 5. Audio out | 11. Belt clip |
| 6. Charging indicator (built-in) | 12. Charging terminal |

Operation of AS-TVBP Body pack Receiver

A. Switch-On Steps:

1. Turn the power/volume switch clockwise is displayed in the LCD.
2. The LCD will then automatically display the selected channel.

B: Volume adjust

1. Turn the power/volume switch clockwise to increase, turn counter clockwise to decrease.

C: Mute

1. Press the mute button, it will turn red to indicate mute.

D. Channel/Frequency Settings (with power on):

1. Press the + button to display a higher numbered channel.
2. Press the - button to display a lower numbered channel.
3. Press the set button to display the frequency.

E. Switch Off steps:

1. Turn the power/volume control completely counter clockwise until it clicks off.

F. Charging the AS-TVBPT and AS-TVBPR

1. These units have permanent rechargeable lithium batteries.
2. Plug the provided charger into the body pack and an AC power source when the battery display shows empty.
3. An optional cradle charger that will charge two body packs at a time is available.

Description of Functions for Body Pack Transmitter AS-TVMBP

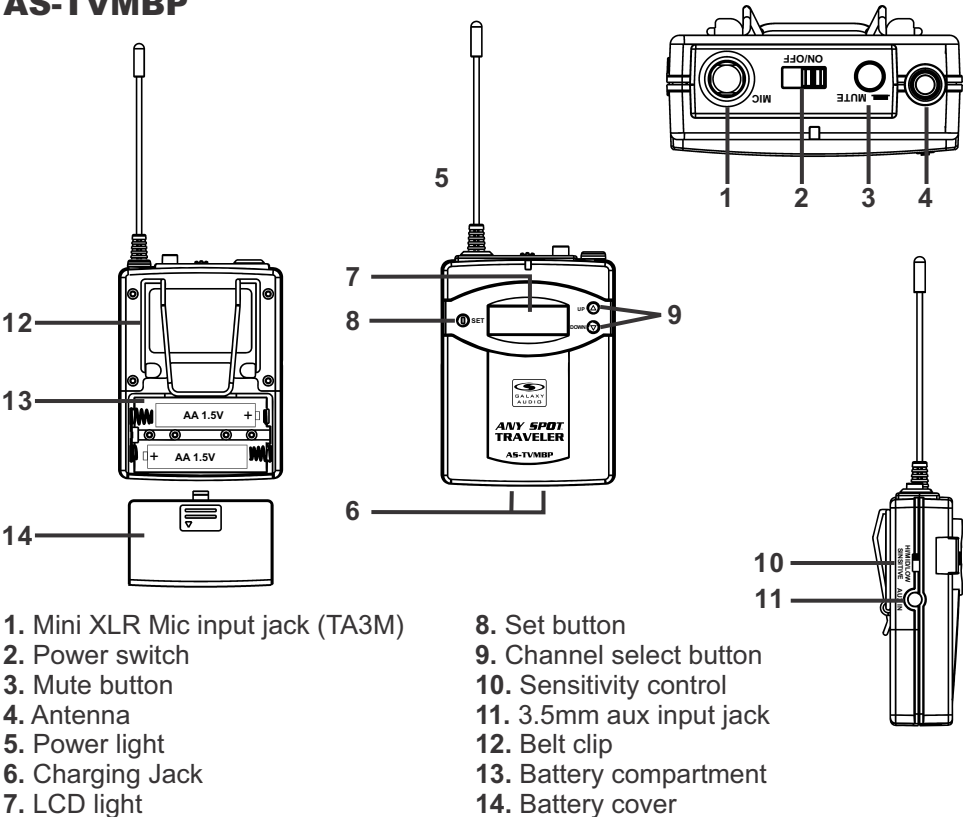

Operation of AS-TVMBP Body Pack Transmitter

A. Battery Installation:

1. Switch the transmitter off before inserting batteries.
2. Slide the battery cover off.
3. Insert 2 disposable batteries (1.5V AA) or 2 rechargeable batteries (1.2V AA).
4. Observe correct polarity when inserting batteries.
5. Slide the battery cover back to its original position.

B. Turning unit on:

1. Switch the power to ON position
2. The RED LED will light and the LCD will display "On".



Battery status and channel will then appear.



If no other operation is performed, LCD light will go off automatically in 5 seconds.

C. Channel/Frequency Settings:

1. Press and hold the SET button for approximately 2 seconds until the channel number flashes.
2. Release the SET button and the current channel will keep flashing
3. Press the UP or DOWN buttons to select a different channel.
4. When the desired channel is displayed press the SET button again. The display will stop flashing and stay on the channel selected.
5. Press and hold the UP or DOWN buttons to display the frequency associated with the channel number selected.

D. LCD Indications:

1. Batteries fully charged and channel 08 selected. The image shows a battery icon with four full bars and the text "CH.08".
2. One bar displayed indicates low-battery. The batteries need to be changed or rechargeable batteries need to be recharged. The image shows a battery icon with one bar and the text "CH.08".
3. No bars displayed indicates the batteries are exhausted and after flashing three times, the power will automatically shut off. The image shows a battery icon with no bars and the text "CH.08".

E. Battery Charging Steps:

1. Insure that the batteries are the rechargeable type.
2. Switch Power to OFF position.
3. Insert AS-TVMBP into its own intelligent charger stand (AS-DCTVMBP).
4. Batteries will recharge automatically.
5. For more details of charger stand please refer to AS-DCTVMBP user guide.

F. Turning the unit OFF:

1. Slide the power switch to the OFF position.

2. LCD display will show "OFF"



If there is no further operation, the Power LED and LCD will switch off automatically.

G. Troubleshooting

1. No LCD display when the unit is switched on.
 - a. Make sure the batteries are not discharged.
 - b. Make sure the batteries are installed correctly.
2. LCD shows Err when switched on.
 - a. Switch power OFF, repeat steps for turning unit on.
 - b. If the problem persists, call for service
3. No Audio from Transmitter.
 - a. Check that the Transmitter and Receiver are on the same channel.
 - b. Check if "MUTE" is activated.
 - c. Check if the volume control of the receiver is set to a proper position.
 - d. Check if the Transmitter and Receiver are within the operating distance range.
4. Interference and signal disturbances.
 - a. When two Transmitters are being used, select different frequencies. If voice disturbance still occurs try selecting another channel until interference is gone.
 - b. Make sure there are no other wireless systems operating on the same frequency in the area. This includes other wireless microphones, television or radio stations, etc. Try setting the Transmitter and Receiver to a new channel.

Maintenance

Avoid Excessive Heat

Don't leave transmitter or receiver in hot sun, on a radiator, or near other sources of high temperature.

Avoid Rough Handling

The transmitter and receiver may be damaged if dropped.

Storage

Before storage, fully charge the batteries in both transmitters and receivers. If possible, recharge once a month during storage and again before first use.

Storage (Long term)

Remove the internal batteries when storing the units for a long period of time.

Replacing Batteries

Observe the correct polarity when installing batteries. Replace batteries only with the same or equivalent type.

Battery Terminals

Keep the contacts clean and inspect them often to insure they are not corroded. If they become corroded, polish them with a pencil eraser.

AS-TXRM Stationary Transmitter

The AS-TXRM is a stand alone version of our AS-TVTX Audio Link Transmitter module. The module is housed in a standard half-rack sized enclosure, and includes a variety of inputs and outputs as well as mixing controls. The AS-TXRM is great for transmitting the entire mix from a mixing console to one or more Traveler speakers equipped with wireless receivers.

AS-TXRM Stationary Transmitter

Front Panel

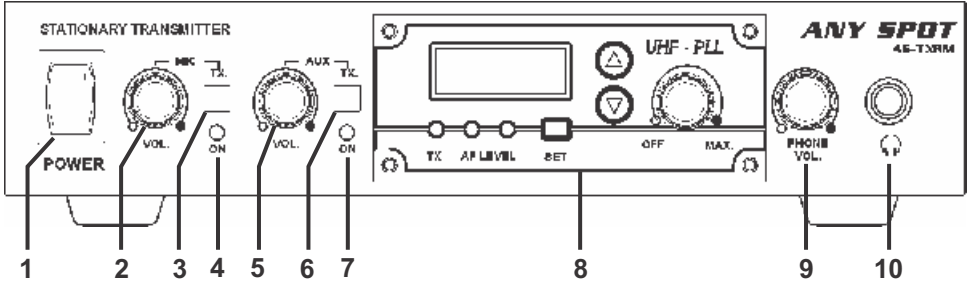

Rear Panel

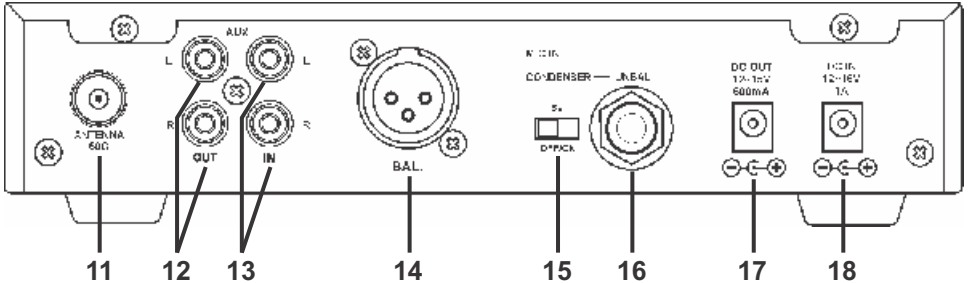

1. Power Switch w/ LED
2. Mic Volume
3. Mic On/Off Switch
4. Mic On LED
5. Aux Volume
6. Aux On/Off Switch
7. Aux On LED
8. Transmitter Module
9. Headphone Volume

10. Headphone Output
11. Antenna Connector
12. L/R Aux Outputs
13. L/R Aux Inputs
14. Balanced Mic Input
15. 5v DC Mic Switch
16. Unbalanced Mic Input
17. 12-15v DC Output
18. 12-15v DC Input

Setup and Operation of AS-TXRM

1. Starting with both the main power switch off **(1)** and the transmitter **(8)** power switch off, plug the included power supply into the DC In jack **(18)**, and then plug the other end into an AC outlet. Connect the supplied antenna to the Antenna Jack **(11)**.
2. Set all volume controls **(2)**, **(5)**, & **(9)** to the minimum. Set the input TX switches **(3)** and **(6)** to off, and then switch on the power **(1)**.
3. Connect the desired source devices (such as a microphone or line output of a mixer) to the appropriate AS-TXRM inputs. The XLR input **(14)** will accept balanced mic level signals. The ¼" input **(16)** will accept unbalanced mic level signals, and provide 5v DC to condenser mics when desired, by activating the switch **(15)**. These two inputs are controlled by the Mic Volume **(2)** and TX switch **(3)**. The L/R Aux Inputs will accept a stereo line level signal, and are controlled by the Aux Volume **(5)** and TX switch **(6)**. When the TX switches **(3)** and **(6)** are engaged, the respective LEDs **(4)** and **(7)** will light, indicating that the input signal is being sent to the Transmitter Module **(8)** and the L/R Aux Output jacks.
4. Switch on the Transmitter Module **(8)** and set it according to the Audio Link System instructions provided on page 13.
5. Set the receiver(s) according to the Wireless Mic Receiver instructions provided on page 12.
6. Start sending a signal from the source device and set various volume controls (in the signal chain from the source to the receiving device) to the desired levels. It is important to set the gain structure properly to achieve the best signal to noise ratio. Normally you will want to set the output of the source as high as possible without causing distortion to the input of the following device, and so on down the line.
7. Signals sent to the L/R Aux Input will appear at the Headphone Jack **(10)** and be controlled by the Phone Volume **(9)**. Note: Signals from the Mic Inputs **(14)** and **(16)** do not appear at the Headphone Jack.
8. The DC Output Jack **(17)** supplies 12v DC for charging or powering other devices. Make sure any device connected to this jack complies with the voltage and current rating listed for this jack.

CAUTION

Danger of explosion if the battery is incorrectly installed.
Replace only with the same or the equivalent type.



TV10

Specifications Portable Amplifier Speaker

Sensitivity	92 dB, 1Watt @ 1 M
Maximum SPL	112 dB
Frequency response	20 Hz ~ 20 kHz (audio)
Speakers	10" LF Woofer, 1" HF Horn
Receiver module (optional)	AS-TVREC x 2 @ diversity
Antenna	Built-in antenna
Output power	100 Watt (RMS), 140W (MAX) @ 4 Ω
Signal to noise ratio	Up 70 dB
CD/Media players (optional)	RM-CD/CDM/CDV/DIGIMP/CASSP/CASS
Audio link TX (optional)	AS-TVTX transmitter
Audio input	XLR - Mic in, 6.5 mm - Mic in, RCA - Line in, 3.5 mm - Aux in
Audio output	RCA - Line out, 3.5mm - Aux out
Controls	Wireless, MIC, Bass, Treble, Master, AUX & LINE
Power requirement	100-240V AC 50/60Hz
Battery	12V, 4.5Ah * 2 (Lead-Acid) rechargeable batteries
Operating life	4 ~ 6 Hours (tested at 10+ hours)
Charging time	5 Hours
Operating distance	164' - 197' (50 - 60 meters)
Dimensions (D x W x H)	(D) 12.2" x (W) 14.17" x (H) 22.83" (310mm x 360mm x 580 mm)
Weight	44 lbs (20 kg) (batteries included)

CAUTION

Danger of explosion if the battery is incorrectly installed.
Replace only with the same or the equivalent type.

TV8

Specifications Portable Amplifier Speaker

Sensitivity	92 dB, 1Watt @ 1 M
Maximum SPL	109 dB
Frequency response	70 Hz ~ 20 kHz (audio)
Speakers	8" LF Woofer, 1" HF Horn
Receiver module (optional)	AS-TVREC x 2 @ diversity
Antenna	Built-in antenna
Output power	50 Watt (RMS), 80W (MAX)
Signal to noise ratio	Up 70 dB
CD/Media players (optional)	RM-CD/CDM/CDV/DIGIMP/CASSP/CASS
Audio link TX (optional)	AS-TVTX transmitter
Audio input	XLR - Mic in, RCA - Line in
Audio output	RCA - Line out, SPK out (unswitched)
Controls	Mic., Line, Bass, Treble, Master
Power requirement	100-240V AC 50/60Hz
Battery	12V, 2.9Ah * 2 (Lead-Acid) rechargeable batteries
Operating life	4 ~ 6 Hours (tested at 10+ hours)
Charging time	4 ~ 6 Hours
Operating distance	164' - 197' (50 - 60 meters)
Dimensions (D x W x H)	(D) 12" x (W) 9" x (H) 18.5" (300 x 230 x 470 mm)
Weight	26.5 lbs (12 kg) (batteries included)

Sensitivity	88 dB, 1Watt @ 1 M
Maximum SPL	104 dB
Frequency response	70 Hz ~ 16 kHz (audio)
Speakers	5" Woofer, 1" Tweeter
Receiver module	AS-TVREC x 2 diversity (optional)
Output power	40 W (RMS) @ 4ohm
Signal to noise ratio	Up 70 dB
Optional Media Player	AS-DIGIMP5 (optional)
Audio input	¼"/XLR Combo-Mic. In, 1/8"-Aux In
Audio output	1/8"-Aux Out,
Controls	Master, Tone, Aux In, Mic
Range	150' (50 meters)
Power Supply	20VDC 3.25A
Battery	12V, 2.9Ah (Lead-Acid) rechargeable battery
Running time	4 ~ 5 Hours
Charging time	3 ~ 4 Hours
Dimensions (D x W x H)	7.9" x 6.7" x 10.9" (200 x 170 x 276 mm)
Weight	8.15lbs (3.7 kg)

Sensitivity	88 dB, 1Watt @ 1 M
Maximum SPL	104 dB
Frequency response	70 Hz ~ 16 kHz (audio)
Speakers	5" Neolite Speaker
Receiver module	AS-TVREC x 2 diversity (optional)
Output power	40 W (RMS) @ 4ohm
Signal to noise ratio	Up 70 dB
Optional Media Player	AS-DIGIMP5 (optional)
Audio input	¼"-Mic. In, 1/8"-Aux In
Audio output	1/8"-Aux Out,
Controls	Master, Tone, Aux In, Mic
Range	150' (50 meters) to 220' (70 meters)
Power Supply	20VDC 3.25A
Battery	12V, 2.9Ah (Lead-Acid) rechargeable battery
Running time	4 ~ 5 Hours
Charging time	3 ~ 4 Hours
Dimensions (D x W x H)	13.11" x 6" x 9.7" (333 x 153 x 246 mm)
Weight	7 lbs (3.1 kg)

Wireless Mic/Audio link Receiver Module (AS-TVREC)

Oscillation type	PLL synthesized control OSC
Adjustable frequency	Pre-programmed max. 96 switchable channels
Switching bandwidth	Max. 12 MHz
Ambient temperature	-10 °C ~ 50 °C
Maximum deviation	50 kHz, with level limiting
Dynamic range	110 dB
T. H. D.	Less than 0.5%
Pre/De- emphasis	50 μ s
Squelch	Tone key and noise lock dual-squelch
Frequency response	70 Hz ~ 16 kHz (wireless)
Operating range	160 - 230 feet (50 ~ 70 M) (open field) with built-in antenna
Antenna mode	Diversity
Sensitivity	4 μ V @ 30 dB SINAD
Double intermediate	110.6 Mhz / 10.7 MHz
Display status	LCD indicator displays channel or frequency
Channel select	SET, UP, DOWN keys
RF spurious rejection	70 dB
Adjacent channel performance	68 dB @ 250kHz
IMD rejection	58 dB
Carrier frequency range	640 ~ 664 MHz

Continued on page 37

Wireless Mic/Audio link Receiver (AS-TVREC) (continued)

Antenna	Built-in or external
Dimensions (L x W x H)	5.25" x 3.46" x 1.45" (133 x 88 x 37 mm)
Weight	3.88 oz. (110 g)

Audio Link Transmitter Module (AS-TVTX also used in TXRM)

RF output	10mW
Spurious emission	Less than 250 nW
Display status	LCD indicator displays channel or frequency
Channel select	SET, UP, DOWN keys
Antenna	Built-in or external
Dimensions (L x W x H)	4.25" x 7.5" x 1.75" (108 x 190 x 44 mm)
Weight	5.99 oz. (170 g)

Digital Echo Module (AS-TVEC)

Input sensitivity	10 mV
Delay time	110 ms ~ 340 ms
Audio input	6.3 ϕ -Mic in * 2 TRS, Low 2
Controls	Echo, Repeat, Delay, MIC1, MIC2

Handheld Microphone (AS-TVHH)

Microphone type	Cardioid dynamic capsule
RF output	10mW
Spurious emission	Less than 250 nW
Display status	LCD indicator displays channel or frequency, battery condition

Continued on page 38

Handheld Microphone (AS-TVHH) (continued)

Channel select	SET, UP, DOWN keys
AF controls	Hi/Low/Mute switch
Battery	1.2 V (Ni-MH 1300 mAh) * 2 AA type rechargeable battery 1.5V * 2 AA Alkaline disposable
Battery life Ni-MH rechargeable	11 hours typical
Battery life Alkaline disposable	14 hours typical
Antenna	Built-in
Dimensions (Dia x L)	1.8" x 10.4" (46 x 264 mm)
Weight with battery	9.87 oz. (280 g)

Handheld Microphone (AS-TVH2)

Microphone type	Uni-Directional Condenser 16.5mm Element
RF output	10mW/1mW
Frequency Response	70Hz-16kHz
Channels	16 or 96
Indicators	Power, Mute/Talk
Display	Back Lit LCD (Channel, 3 bar battery indicator)
Battery	2- AA type (Ni-MH 1600 mAh) Rechargeable battery 1.5V 2- AA Alkaline disposable
Battery life Alkaline disposable	12 to 16 hours typical
Antenna	Built-in
Dimensions (Dia x L)	1.16" x 7.9" (37 x 200 mm)
Weight with battery	0.20 oz. (90.7 g)

Bodypack Transmitter (AS-TVMBP)

Microphone Type	Headset or Lavalier
RF output	10mW
Spurious emission	Less than 250 nW
Display status	LCD indicator displays channel or frequency, battery life
Channel select	SET, UP, DOWN keys
AF controls	Mute switch, Hi/Mid/Low switch
Audio input	Mic in, Aux in
Battery	1.2 V (Ni-MH 1300 mAh) * 2 AA type rechargeable battery 1.5V * 2 AA Alkaline disposable
Battery life Ni-MH rechargeable	11 hours typical
Battery life Alkaline disposable	14 hours typical
Housing	Aluminium
Dimensions (D x W x H)	1.04" x 2.52" x 3.48" (27 x 64 x 88 mm)
Weight with battery	4.48 oz. (127 g)

Bodypack Transmitter (AS-TVBP)

Microphone	Built in Microphone
RF output	10mW/1mW
Frequency Response	Aux: 70Hz-15kHz Headphone: 100Hz-15kHz
Display	LCD indicator displays channel, frequency, 3 bar battery life & volume
Channels	16 or 96
Indicators	RF/Mute Led, Charging "ON" Led
Inputs	1 -3.5 mm Mic Input and 1 - 3.5 mm Line Input

Bodypack Transmitter (AS-TVBP) (continued)

Battery	Rechargeable Lithium Battery
Battery life	12 - 16 hours typical
Dimensions (D x W x H)	3.46" x 2.04" x 1.33" (88 x 52 x 34mm)
Weight with battery	2.64oz. (75 kgs)

Digital Media Player (TV5MP3)

Frequency Response	20Hz ~ 20kHz
Power Requirement	DC 12 V
Display	Backlit LCD
Output Level	600mV
Supported Format	MP3 Layer 3
S/N Ratio	> 60 dB
T.H.D.	<1%
Remote Range	10' (3 meters)
Controls	Play, Stop, Repeat, Next, Previous
Supported Audio External	USB, SD card

Notice: Changes or modifications not expressly approved by the party responsible for compliance could void the user's authority to operate the equipment.

IMPORTANT NOTE: To comply with the FCC RF exposure compliance requirements, no change to the antenna or the device is permitted. Any change to the antenna or the device could result in the device exceeding the RF exposure requirements and void the user's authority to operate the device.

This device complies with Part 15 of the FCC Rules. Operation is subject to the following two conditions: (1) this device may not cause harmful interference, and (2) this device must accept any interference received, including interference that may cause undesired operation.



ANY SPOT[®] TRAVELER

APPLICATION TABLE

MODULES		TRANSMITTERS & ASSOCIATED RECEIVERS						MODULES			
TV5X 	TV-RECBT **For use with Bluetooth enabled devices only.	TV5-RECBT **For use with Bluetooth enabled devices only.	TV5IMP3 Media Player	AS-TVTX Wireless Audio Link Transmitter	RM-CD CD/MP3/SD USB Player	AS-TVHH Wireless Hand Held Microphone	AS-TVMBP Wireless Body Pack Transmitter	AS-TVH2 Wireless Hand Held Microphone	AS-TVMBPT Wireless Body Pack Transmitter	AS-TVREC Wireless Receiver	TV5REC Wireless Receiver
TV5I 											
AS-TV8 											
AS-TV10 											
AS-TVREC Wireless Receiver											
TV5REC Wireless Receiver											

* = Applicable

**For Bluetooth Media Players Only
Does not work with Bluetooth Headsets



MAKERS OF THE ORIGINAL
HOT SPOT PERSONAL MONITOR



www.galaxyaudio.com

TRAVELER OWNERS MANUAL

	<p>Look for this symbol on our website and Build Your Own Traveler</p>
---	--

LIMITED THREE YEAR WARRANTY

Please visit [galaxyaudio.com](http://www.galaxyaudio.com) for the latest updates
<http://www.galaxyaudio.com/warranty.php>



www.galaxyaudio.com/warranty.php

1-800-369-7768 www.galaxyaudio.com

Please visit [galaxyaudio.com](http://www.galaxyaudio.com) for the latest updates

Specifications in this manual are subject to change without notice.

© 2014 Copyright Galaxy Audio Inc.