

Audio Mixer

AD-200



Quick Start Guide

Warranty

Standard Warranty

- Datavideo equipment is guaranteed against any manufacturing defects for one year from the date of purchase.
- The original purchase invoice or other documentary evidence should be supplied at the time of any request for repair under warranty.
- Damage caused by accident, misuse, unauthorized repairs, sand, grit or water is not covered by this warranty.
- All mail or transportation costs including insurance are at the expense of the owner.
- All other claims of any nature are not covered.
- Cables & batteries are not covered under warranty.
- Warranty only valid within the country or region of purchase.
- Your statutory rights are not affected.

Two Year Warranty

- All Datavideo products purchased after 01-Oct.-2008 qualify for a free one year extension to the standard Warranty, providing the product is registered with Datavideo within 30 days of purchase. For information on how to register please visit www.datavideo-tek.com or contact your local Datavideo office or authorized Distributors
- Certain parts with limited lifetime expectancy such as OLED Panels, DVD Drives, Hard Drives are only covered for the first 10,000 hours, or 1 year (whichever comes first).

Any second year warranty claims must be made to your local Datavideo office or one of its authorized Distributors before the extended warranty expires.

Disposal

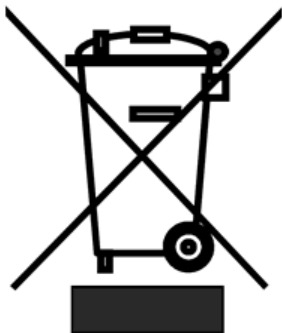

For EU Customers only - WEEE Marking

This symbol on the product indicates that it will not be treated as household waste. It must be handed over to the applicable take back scheme for the recycling of electrical and electronic equipment. For more detailed information about the recycling of this product, please contact your local Datavideo office.

Packing List

1	x	AD-200 Main Unit
1	x	AD-200 Control Unit
1	x	Accessory List
1	x	AD-200 Quick Start Guide

Connections & Controls

Main Unit (Front Panel)



Connection

Use the D-SUB Cable to connection AD-200 main unit and AD-200 control unit.



Audio Output

Use the connect cable to connection AD-200 main unit and AD-200 control unit.

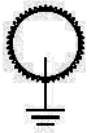

Grounding Terminal

When connecting this unit to any other component, make sure that it is properly grounded by connecting this terminal to an appropriate point. When connecting, use the socket and be sure to use wire with a cross-sectional area of at least 1.0 mm².

Main Unit (Rear Panel)

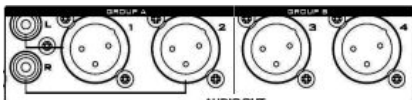
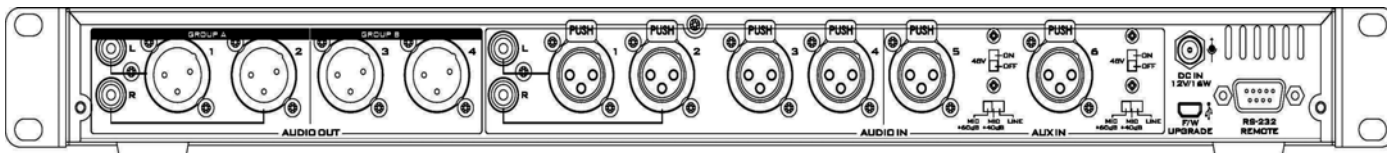

Audio Output

RCA audio output & 4 channels XLR balanced audio output (You can use ch1, 2 audio out is XLR or RCA).

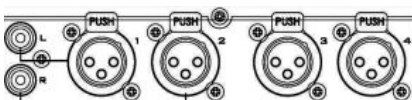

Audio input

RCA audio input & 4 channels XLR balanced audio input (You can use ch1, 2 audio input is XLR or RCA)

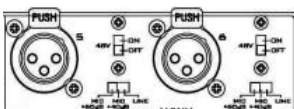

AUX Audio Input

2 channels XLR balanced audio input.

For more information please see **page 7** for more details.

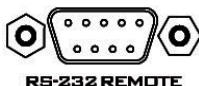

RS-232 REMOTE

To be updated.



USB

Firmware Upgrades



DC IN Socket

Connect the supplied 12V PSU to this socket. The power connection can be secured by screwing the outer fastening ring of the DC In plug to the socket.

Control Unit (Front Panel)

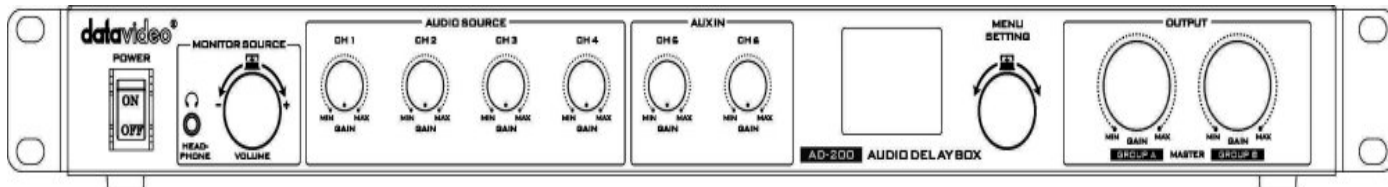

Power Switch

Switches the power On / Off.

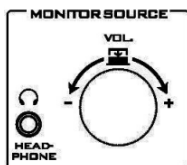

Headphone

Accepts a stereo mini jack plug for stereo headphones. The headphone volume is adjusted by the rotating Head phone volume control.

Headphone Volume Control

Controls Headphone volume level.

Use the Headphone section to accurately monitor any of the sources output.

Push this button can switch audio source 1~6 and audio output 1, 2.



Audio Input Source Level Controls

The AD-200 controls audio input channel (CH1~CH6).

This row of audio channel selection buttons has OLED built in to show which input channel is active. Level control for each audio input source is via the rotary pots above each of the audio channel selection buttons.

(Level range from -80dB to +20dB)

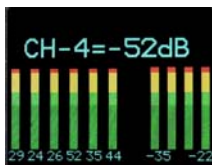

OLED Panel

Audio Meters & Function Display.

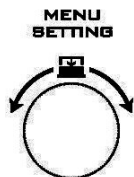

MENU Navigation Button

Rotate to change options and press in to select.

For more information please see the **Menu Function**.

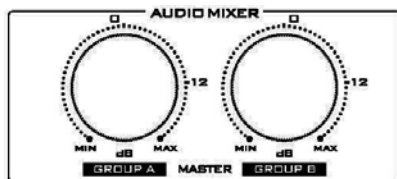

Audio Output Source Level Controls

GROUP A = Control the CH1,2 output volume.

GROUP B = Control the CH3,4 output volume.

Control Unit (Rear Panel)



Connection

Use the D-SUB Cable to connection AD-200 main unit and AD-200 control unit.



Audio Input

Use the connect cable to connection AD-200 main unit and AD-200 control unit.



DC IN Socket

Connect the supplied 12V PSU to this socket. The power connection can be secured by screwing the outer fastening ring of the DC In plug to the socket.

*Note: AD-200 main unit and AD-200 control unit both have **DC IN Socket**, they are the same function, you just need select one socket to supply the power input.*



Grounding Terminal

When connecting this unit to any other component, make sure that it is properly grounded by connecting this terminal to an appropriate point. When connecting, use the socket and be sure to use wire with a cross-sectional area of at least 1.0 mm².

Connection AD-200 main unit and AD-200 control unit

AD-200 Main Unit

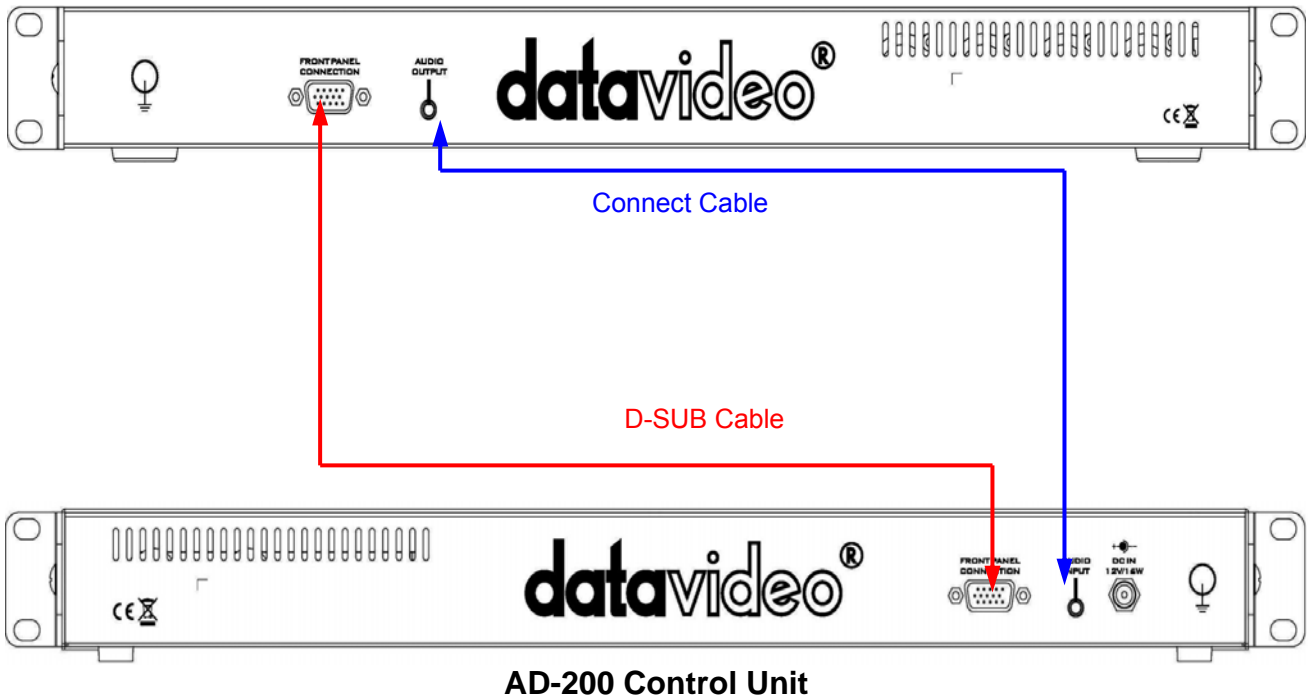

Audio Inputs and Levels

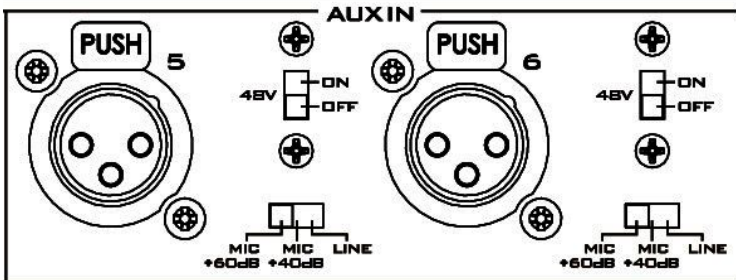

There are two kinds of switches under **AUDIO IN**:

The **LINE/ MIC+40dB/ MIC+60dB** switch is used to set the audio as LINE in or MIC+40dB or MIC+60dB in. When LINE in is selected please also set the **48V ON/OFF** switch to **OFF** in order to prevent burn-out damage to the circuit.

The **48V ON/OFF** switch is for phantom power. If you want to use MIC in, please set the **LINE/ MIC+40dB/ MIC+60dB** switch first, and then if using a Condenser microphone turn ON the **48V ON/OFF** switch. If you wish to use a Dynamic microphone please turn OFF the **48V ON/OFF** switch.

***NOTE:** Always double check the manual for the microphone being used to see what advice it gives regarding power as some Mics have internal batteries too.

Menu Function

1: SET MIXER

___ /	1	2	3	4	5	6	T
OUT1=	+	-	-	-	-	-	-
OUT2=	+	+	+	+	+	+	-
OUT3=	-	+	-	-	-	-	-
OUT4=	-	-	-	-	-	-	+
ESCAPE							

- + : Enable
- : Disable
- 1~6 : Audio Input (CH1~6)
- T : Tone
- OUT1~4 : Audio Output (CH1~4)

This table are setting to be:

- Out1 is input1 audio mixed
- Out2 is input1~6 audio mixed
- Out3 is input2 audio mixed
- Out4 is tone mixed

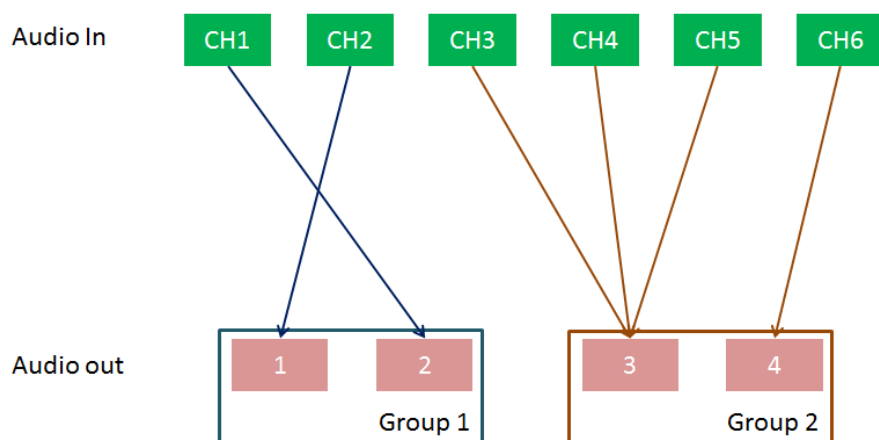

2: DELAY TIME

This function can be setting audio input delay time from 0000~3000 m SEC.

3: TONE MODE

1. **FQ.** : This function is setting TONE frequency 1KHz, 6KHz or 12 KHz
2. **LEL** : This function is setting TONE level from 00~24 dBu.

4: DISPLAY

1. **BRI.** : This function is setting OLED panel brightness.
2. **TEST** : You can select different color (Red, Green, Blue, Black, White) to test OLED panel
3. **MODE** : This function is setting OLED panel display CH1/2, CH3/4, CH5/6, OUT1/2, OUT3/4 or all channels volume indicator .

System Diagram

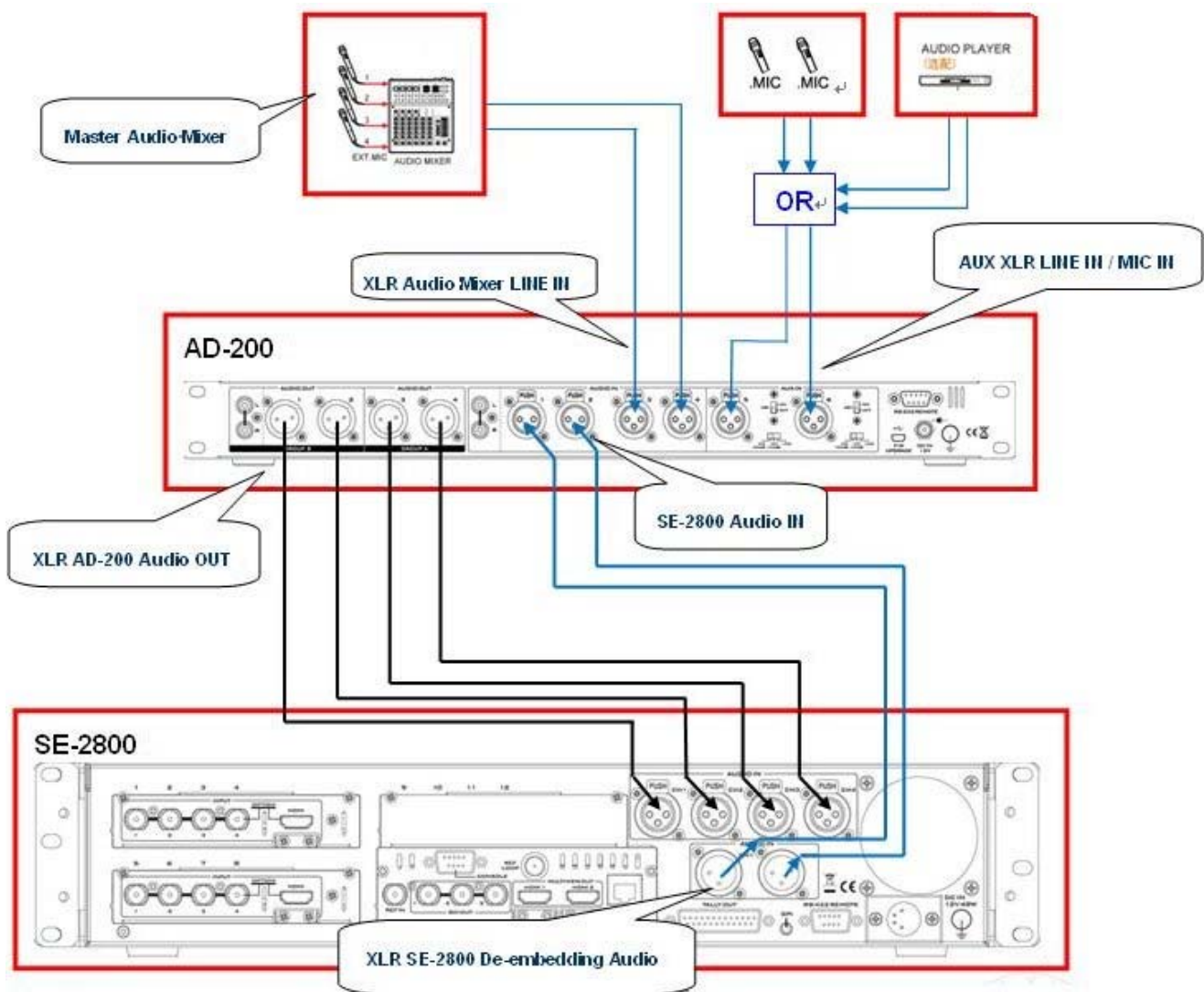

Specifications

Parameter	Specification	Limit	Units	Conditions/Comments
AUX IN				
MIC/Line Connectors (CH5~CH6)	3Pin XLR Female			Pin2=(+),Pin3=(-),Pin1=GND
Mic/Line Input Impedance(CH5/CH6)	6.8K/300K		Ω	
Mic Gain Range	off to +20	±3	dB	Audio source GAIN(knob)
Line Gain Range	off to +20	±3	dB	Audio source GAIN(knob)
THD+N	0.01	max	%	@1KHz,0dB(Lin IN)
Line in Max Level	+23dBu	±3%	dBu	
Signal to noise ratio	75	min	dB	@1KHz,0dB(Lin IN)
Frequency Response	20Hz~20KHz	±3	dB	
Audio IN				
Input (CH1~CH4)				
Connectors	3Pin XLR Female			Pin2=(+),Pin3=(-),Pin1=GND
Input Impedance	300K		Ω	
Gain Range	off to +20	±3	dB	Audio source GAIN(knob)
Signal to noise ratio	75	min	dB	@1KHz,0dB
THD+N	0.01	max	%	@1KHz,0dB
Frequency Response	20Hz~20KHz	±3	dB	
unbalanced mono audio (L, R)	RCA			
Signal to noise ratio	80	min	dB	@1KHz,0dB(RCA IN)
THD+N	0.01	max	%	@1KHz,0dB(RCA IN)
Impedance	20K	1%	Ω	
Audio Output				
Connector (1,2,3,4)(Group A,B)	3Pin XLR Male			Pin2=(+),Pin3=(-),Pin1=GND
Impedance	60	1%	Ω	
Gain Range	off to +20	±3	dB	OUTPUT (Group A,B)(knob)
Output Max Level	+23dBu	±1.5%	dB	
unbalanced mono audio (L, R)	RCA			
Gain Range	off to +20	±3	dB	OUTPUT (Group A,B)(knob)
Impedance	300	1%	Ω	
Headphone				
Connector	3.5mm phone jack			Tip(+),Ring=(-),Sleeve=GND
Signal to noise ratio	70	min	dB	@1KHz,0dB(Lin IN)
THD+N	0.01	max	%	@1KHz,0dB(Lin IN)
Frequency Response	20Hz~20KHz	±3	dB	
Others				
Phantom Power	+48V	±3%	VDC	
Power Consumption	12V/19W	±3%	watts	
Power Input connector	2pin DC Jack			Pin4=(+),Pin1=GND
Dimensions (Main Unit)	147 x 440 x 45.4	±1%	mm	L X W X H
Dimensions (Control Unit)	90.5 x 440 x 47.5	±1%	mm	L X W X H
Weight	Main Unit 1.8kg / Control Unit 1.1kg		kg	
OLED	1,77" TFT			160XRGBX128
Audio Delay for audio input	0~3 sec			

Notes

Service & Support

It is our goal to make owning and using Datavideo products a satisfying experience. Our support staff is available to assist you to set up and operate your system. Contact your local office for specific support requests. Plus, please visit www.datavideo.com to access our FAQ section.

USA: Datavideo Corporation

Tel: +1 562 696 2324	Fax: +1 562-698-6930	E-Mail: techsupport@datavideo.us
----------------------	----------------------	----------------------------------

The Netherland: Datavideo Technologies Europe BV

Tel: +31-30-261-96-56	Fax: +31-30 261-96-57	E-Mail: service@datavideo.nl
-----------------------	-----------------------	------------------------------

United Kingdom: Datavideo UK Limited

Tel: +44 1457 851 000	Fax: +44 1457 850 964	E-Mail: sales@datavideo.co.uk
-----------------------	-----------------------	-------------------------------

Taiwan: Datavideo Technologies Co., Ltd

Tel: +886 2 8227 2888	Fax: +886-2-8227-2777	E-mail: service@datavideo.com.tw
-----------------------	-----------------------	----------------------------------

China: Datavideo Technologies China Co., Ltd

Tel: +86 21-5603 6599	Fax: +86 21-5603 6770	E-mail: service@datavideo.cn
-----------------------	-----------------------	------------------------------

Singapore: Datavideo Technologies (S) PTE LTD

Tel: +65-6749 6866	Fax: +65-6749 3266	E-mail: sales@datavideo.sg
--------------------	--------------------	----------------------------

Hong Kong: Datavideo HK Limited.

Tel: +852 2833 1981	Fax: +852-2833-9916	E-mail: info@datavideo.com.hk
---------------------	---------------------	-------------------------------

France: Datavideo France

Tel: +33 1 60 37 02 46	Fax: +33 1 60 37 67 32	E-Mail: info@datavideo.fr
------------------------	------------------------	---------------------------

India: Datavideo India

Tel: +91-0120-2427337	Fax: +91-0120-2427338	E-Mail: sales@datavideo.in
-----------------------	-----------------------	----------------------------

All the trademarks are the properties of their respective owners.
Datavideo Technologies Co., Ltd. All rights reserved 2018

Feb-20.2014 P/N: G082060559B1