

**Canon**

# EOS M



**E**

**Basic Instruction Manual**

# Introduction

The EOS M is a high-performance, interchangeable-lens digital camera featuring a fine-detail CMOS sensor with approx. 18.0 effective megapixels, DIGIC 5, high-precision and high-speed 31-point AF, approx. 4.3 fps continuous shooting, and Full High-Definition (Full HD) movie shooting. The camera is highly responsive to any shooting situation, and provides many features for demanding shots.

## Refer to This Manual while Using the Camera to Further Familiarize Yourself with the Camera

With a digital camera, you can immediately view the image you have captured. While reading this manual, take a few test shots and see how they come out. You can then better understand the camera.

To avoid botched pictures and accidents, first read the “Safety Warnings” (p.96, 97) and “Handling Precautions” (p.8, 9).

## Testing the Camera Before Use and Liability

After shooting, play images back and check whether they have been properly recorded. If the camera or memory card is faulty and the images cannot be recorded or downloaded to a computer, Canon cannot be held liable for any loss or inconvenience caused.

## Copyrights

Copyright laws in your country may prohibit the use of your recorded images or copyrighted music and images with music in the memory card for anything other than private enjoyment. Also be aware that certain public performances, exhibitions, etc., may prohibit photography even for private enjoyment.



This camera is compatible with SD memory cards, SDHC memory cards, and SDXC memory cards. In this manual, “card” refers to all these cards.

**\* The camera does not come with a card for recording images/movies.** Please purchase it separately.

## Cards that can record movies

When shooting movies, use a large-capacity SD card rated SD Speed Class 6 “CLASS 6” or higher (p.75).

# Instruction Manuals

This Basic Instruction Manual only explains the camera's basic operations and functions for basic shooting with the EOS M attached with an EF-M lens. For more detailed instructions such as shooting with EF and EF-S lenses with Mount Adapter EF-EOS M, advanced shooting and playback procedures, printing photos, and Custom Functions, see the Camera Instruction Manual in the CD-ROM.

The EOS M's instruction manuals consist of the following:

- **Camera Instruction Manual**

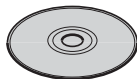

**Instruction Manual  
(CD-ROM)**

#### CD-ROM Contents

**Camera Instruction Manual** (PDF file)

Explains all the camera's functions and operation procedures. Includes also all the contents in this Basic Instruction Manual.

**Accessory Instruction Manual** (PDF file)

PDF files for the Lens Instruction Manual (EF-M18-55mm f/3.5-5.6 IS STM and EF-M22mm f/2 STM), Mount Adapter EF-EOS M Instruction Manual, and Speedlite 90EX Instruction Manual are provided.

See page 87 on how to view the Instruction Manual (PDF) in the CD-ROM.

- **Software**

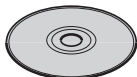

**EOS DIGITAL  
Solution Disk  
(Software CD-ROM)**

See pages 87 to 88 for an overview of the software programs, installation procedure for a personal computer, and how to view the Software Instruction Manual CD-ROM.

# Item Check List

Before starting, check that all the following items have been included with your camera. If anything is missing, contact your dealer.



**Camera**  
(with body cap)



**Battery Pack  
LP-E12**  
(with protective cover)



**Battery Charger  
LC-E12/LC-E12E\***

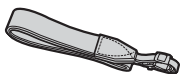

**Neck Strap EM-100DB**

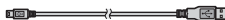

**Interface Cable**



**EOS DIGITAL  
Solution Disk**  
(Software CD-ROM)



**Instruction Manual**  
(CD-ROM)



**Software  
Instruction Manual**  
(CD-ROM)



**Camera Basic Instruction Manual**

\* Battery Charger LC-E12 or LC-E12E is provided. (The LC-E12E comes with a power cord.)

- If you purchased a Camera Kit, check that all the components are included. Depending on the Camera Kit, these may include a lens, Speedlite flash or Mount Adapter EF-EOS M.





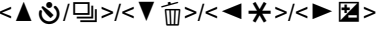

# Conventions Used in this Manual

## Icons in this Manual

 : Indicates the Main Dial to be turned.

 : Indicates the Main Dial buttons on the top, bottom, left, or right to be pressed.

/SET> : Indicates the Main Dial to be pressed at the center.

4, 6, 10, 16 : Indicates that the corresponding function remains active for 4 sec., 6 sec., 10 sec., or 16 sec. respectively after you let go of the button.

\* In this manual, the icons and markings indicating the camera's buttons, dials, and settings correspond to the icons and markings on the camera and on the LCD monitor.

 : Press the <MENU> button to set a function.

 PDF : See the Camera Instruction Manual PDF file for details.

(p.\*\*): Reference page number for more information.

 : Warning to prevent shooting problems.

 : Supplemental information.

 : Tips or advice for better shooting.



 : Problem-solving advice.

## Basic Assumptions

- The instructions in this manual assume that the power is on (p.25) and the menu functions and Custom Functions are set to the default settings.
- The illustrations in this manual show the camera attached with the EF-M18-55mm f/3.5-5.6 IS STM lens as an example.











### Certification Logo

Under the [4] tab, if you select [Certification Logo Display] and press </SET>, some of the logos of the camera's certifications will appear. Other certification logos can be found in this Instruction Manual, on the camera body, and on the camera's package.

# Contents



<b>Introduction</b>	<b>2</b>
Instruction Manuals .....	3
Item Check List.....	4
Conventions Used in this Manual.....	5
Handling Precautions .....	8
Quick Start Guide .....	10
Nomenclature .....	12
<b>1 Getting Started</b>	<b>19</b>
Charging the Battery .....	20
Installing and Removing the Battery and Card .....	22
Turning on the Power .....	25
Setting the Time Zone, Date and Time .....	27
Selecting the Interface Language.....	29
Attaching and Detaching a Lens .....	30
About the Lens Image Stabilizer .....	32
Basic Operation.....	34
Quick Control.....	36
<b>MENU</b> Menu Operations.....	39
Formatting the Card .....	42
Switching the LCD Monitor Display .....	44
👉 Using the Touch Screen and Main Dial.....	45
<b>2 Scene Intelligent Auto + Basic Zone Modes</b>	<b>47</b>
📷 <sup>+</sup> Fully Automatic Shooting (Scene Intelligent Auto) .....	48
📷 <sup>+</sup> Full Auto Techniques (Scene Intelligent Auto) .....	51
Select a Shooting Mode .....	53
📷 <b>A</b> Creative Auto Shooting .....	54
👤 Shooting Portraits (Portrait).....	56
🏞️ Shooting Landscapes (Landscape).....	57

 Shooting Close-ups (Close-up) .....	58
 Shooting Moving Subjects (Sports) .....	59
 Shooting Night Portraits (Night Portrait) (With a Tripod) .....	60
 Shooting Night Scenes Handheld (Handheld Night Scene) .....	61
 Shooting Backlit Scenes (HDR Backlight Control) .....	62
 Image Playback .....	64
Changing the Focusing Method .....	65
 Shooting with the Touch Shutter .....	73
 Using the Self-timer .....	74

### **3 Shooting Movies 75**

 Shooting Movies .....	76
---	----

### **4 Image Playback 81**

 Playing Back with the Touch Screen .....	82
 Playing Movies .....	84

### **5 Instruction Manuals in the CD-ROM and Software Start Guide 86**

Viewing the Instruction Manual CD-ROM .....	87
About the Software .....	89
Installing the Software .....	90
Software Instruction Manual .....	91
Software System Requirements .....	92
Safety Warnings .....	96

## **Trademarks**

- Adobe is a trademark of Adobe Systems Incorporated.
- Windows is a trademark or registered trademark of Microsoft Corporation in the United States and other countries.
- Macintosh and Mac OS are trademarks or registered trademarks of Apple Inc. in the United States and other countries.
- SDXC logo is a trademark of SD-3C, LLC.
- HDMI, HDMI logo, and High-Definition Multimedia Interface are trademarks or registered trademarks of HDMI Licensing LLC.
- All other corporate and product names and trademarks mentioned in this manual are the property of their respective owners.

# Handling Precautions

## Camera Care

- This camera is a precision instrument. Do not drop it or subject it to physical shock.
- Do not point the camera-attached lens toward the sun. The sun's heat can damage the camera's internal components.
- The camera is not waterproof and cannot be used underwater. If you accidentally drop the camera into water, promptly consult the nearest Canon Service Center. Wipe off any water droplets with a dry cloth. If the camera has been exposed to salty air, wipe it with a well-wrung wet cloth.
- Never leave the camera near anything having a strong magnetic field such as a magnet or electric motor. Also avoid using or leaving the camera near anything emitting strong radio waves such as a large antenna. Strong magnetic fields can cause camera incorrect operation or destroy image data.
- Do not leave the camera in excessive heat such as in a car in direct sunlight. High temperatures can cause the camera to malfunction.
- The camera contains precision electronic circuitry. Never attempt to disassemble the camera yourself.
- Do not block the shutter operation with your finger, etc. Doing so may cause a malfunction.
- Use a blower to blow away any dust on the lens. Do not use cleaners that contain organic solvents to clean the camera body or lens. For stubborn dirt, take the camera to the nearest Canon Service Center.
- Do not touch the camera's electrical contacts with your fingers. This is to prevent the contacts from corroding. Corroded contacts can cause camera misoperation.
- If the camera is suddenly brought in from the cold into a warm room, condensation may form on the camera and internal parts. To prevent condensation, first put the camera in a sealed plastic bag and let it adjust to the warmer temperature before taking it out of the bag.
- If condensation forms on the camera, do not use the camera. This is to avoid damaging the camera. If there is condensation, remove the lens, card and battery from the camera, and wait until condensation has evaporated before using the camera.
- If the camera will not be used for an extended period, remove the battery and store the camera in a cool, dry, well-ventilated location. Even while the camera is in storage, press the shutter button a few times once in a while to check that the camera is still working.
- Avoid storing the camera where there are corrosive chemicals such as a darkroom or chemical lab.
- If the camera has not been used for an extended period, test all its functions before using it. If you have not used the camera for some time or if there is an important shoot coming up, have the camera checked by your Canon dealer or check the camera yourself and make sure it is working properly.
- When you detach the lens, the image sensor will be exposed. To prevent scratching the image sensor, do not touch the image sensor.

## LCD Monitor

- Although the LCD monitor is manufactured with very high precision technology with over 99.99% effective pixels, there may be a few dead pixels among the remaining 0.01% or less pixels. Dead pixels displaying only black or red, etc., are not a malfunction. They do not affect the images recorded.
- If the LCD monitor is left on for a prolonged period with the same screen displayed, screen burn-in may occur where you see remnants of what was displayed. However, this is only temporary and will disappear when the camera is left unused for a few days.
- The LCD monitor display may seem slow in low temperatures, or look black in high temperatures. It will return to normal at room temperature.
- After changing the LCD monitor's brightness settings, the display may look a little coarse, depending on the subject. This is not a malfunction and will not affect the recorded image.

## Cards

To protect the card and its recorded data, note the following:

- Do not drop, bend, or wet the card. Do not subject it to excessive force, physical shock, or vibration.
- Do not touch the card's electronic contacts with your fingers or anything metallic.
- Do not affix any stickers, etc., on the card.
- Do not store or use the card near anything having a strong magnetic field such as a TV set, speakers, or magnet. Also avoid places prone to having static electricity.
- Do not leave the card in direct sunlight or near a heat source.
- Store the card in a case.
- Do not store the card in hot, dusty, or humid locations.

## Lens

After detaching the lens from the camera, put down the lens with the rear end up and attach the lens caps to avoid scratching the lens surface and electrical contacts.

## Cautions regarding Prolonged Use

If you use continuous shooting, Live View shooting, or movie shooting for a prolonged period, the camera may become hot. Although this is not a malfunction, holding the hot camera for a long period can cause slight skin burns.

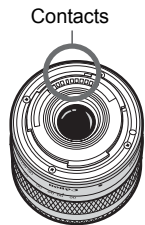

## About smudges adhering to the front of the sensor

Besides dust entering the camera from outside, in rare cases lubricant from the camera's internal parts may adhere to the front of the sensor. If visible spots still remain after the automatic sensor cleaning, having the sensor cleaned by a Canon Service Center is recommended.

## About the lens mount

Periodically cleaning the camera's body and lens mount with a soft lens cleaning cloth is recommended.

# Quick Start Guide

1

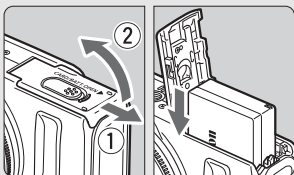

**Insert the battery** (p.22).

- Charging the battery: p.20

2

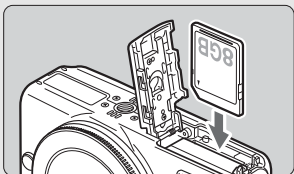

**Insert a card** (p.22).

- With the card's label facing toward the front of the camera, insert it into the card slot.

3



**Attach the lens** (p.30).

- Align the lens' index with the camera's index.

4

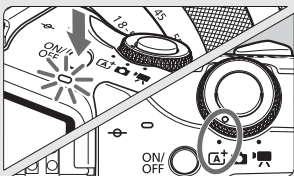

**Press the power button to turn on the camera, and set  $\langle A^+ \rangle$  (Scene Intelligent Auto)** (p.48).

- All the necessary camera settings will be set automatically.
- When the LCD monitor displays the time zone or date/time setting screen, see page 27.

5

**Focus the subject (p.35).**

- Aim the LCD monitor's center over the subject.
- Press the shutter button halfway, and the camera will focus the subject.

6

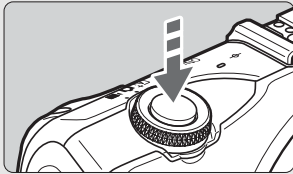
**Take the picture (p.35).**

- Press the shutter button completely to take the picture.

7

**Review the picture (→  PDF).**

- The captured image will be displayed for approx. 2 sec. on the LCD monitor.
  - To display the image again, press the <▶> button (p.64).
- To view the images captured so far, see “Image Playback” (p.64).
  - After you finish shooting, replace the lens cap to protect the lens.

# Nomenclature

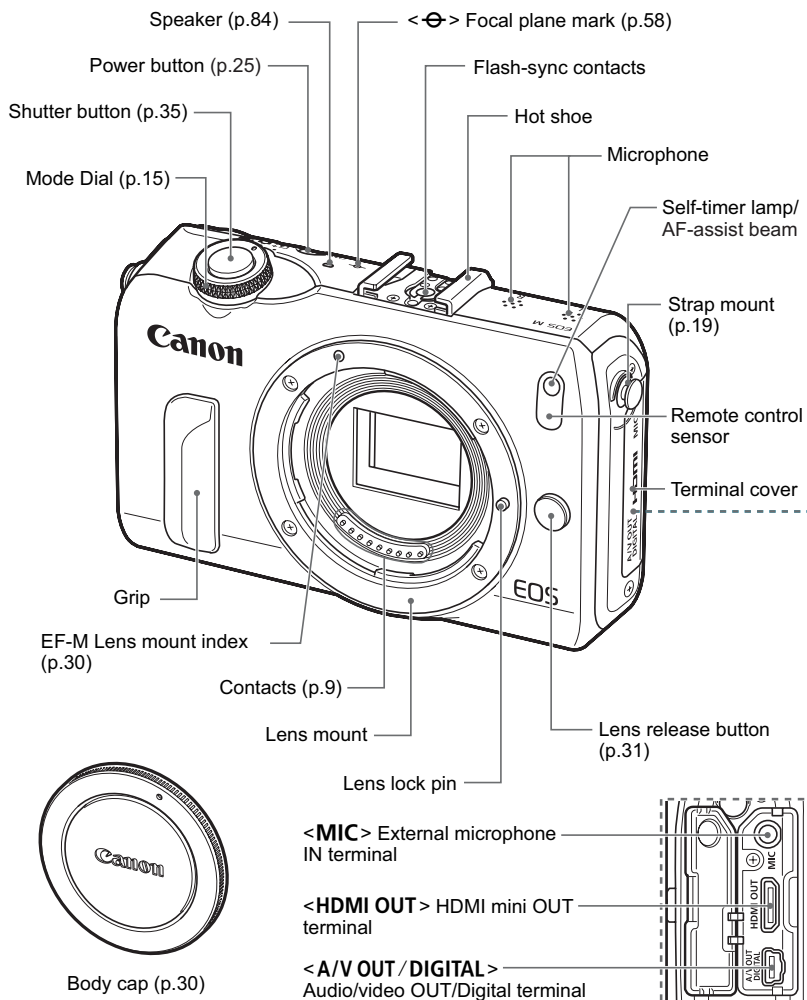

 Parts whose reference page is not indicated are explained in the Camera Instruction Manual PDF file.



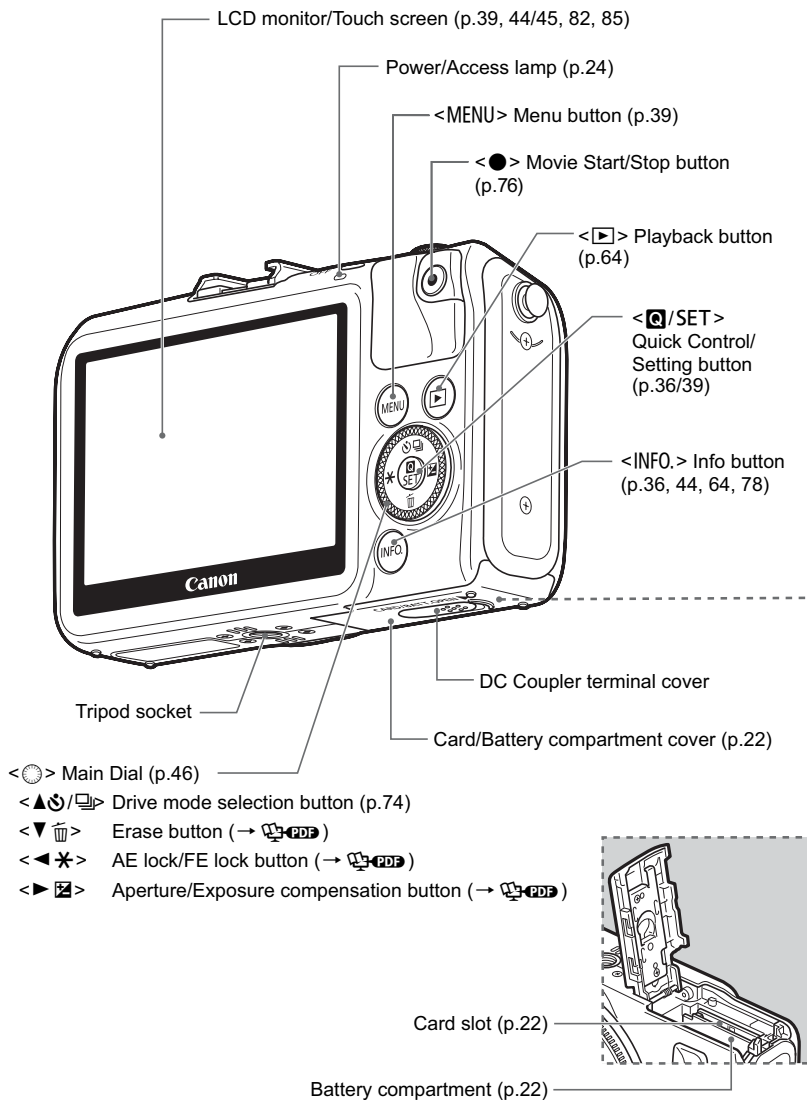

## Screen Display

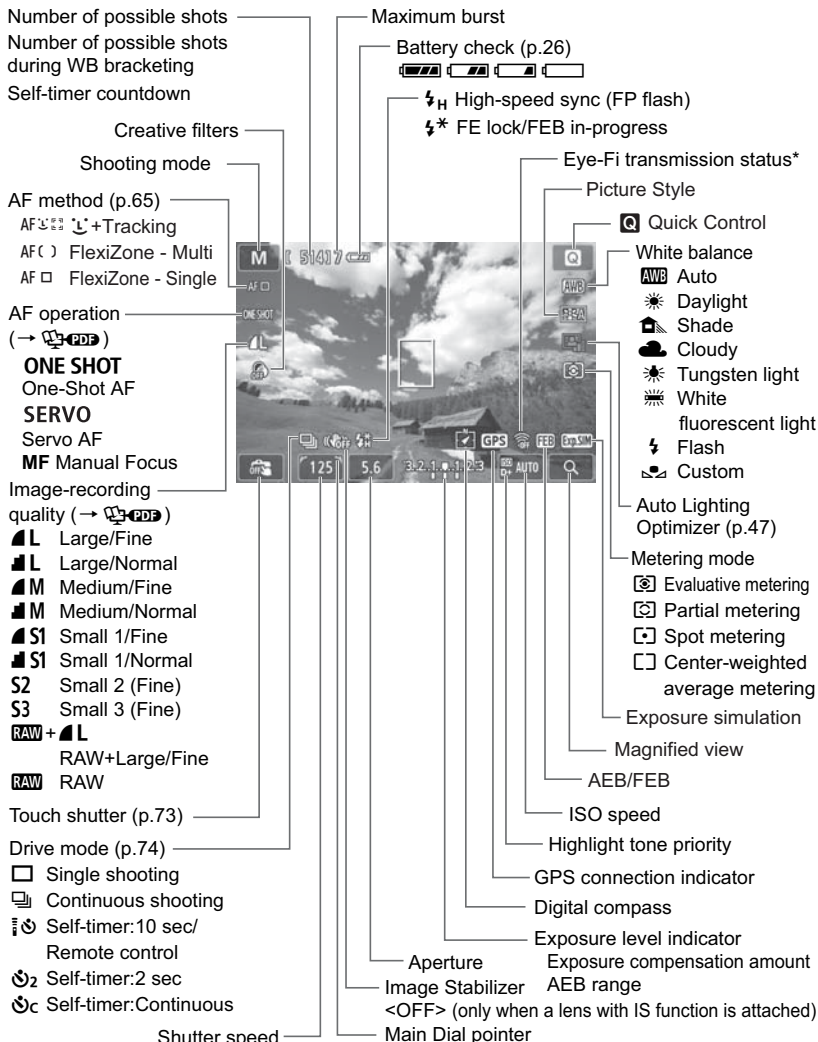

\*: Displayed when an Eye-Fi card is used.

The display will show only the settings currently applied.

## Mode Dial

Switches to <A+> Scene Intelligent Auto, <📷> Still Photos, or <🎥> Movies.



Shoot still photos with <A+> or <📷>, or shoot movies with <🎥>.

<A+> Scene Intelligent Auto enables you to just press the shutter button to take a picture with the camera taking care of everything to suit the subject or scene.

With <📷> Still photos, you can select Creative Zone modes or the Basic Zone modes.

## Creative Zone

These modes give you more control for shooting various subjects.



**M** : Manual exposure

**Av** : Aperture-priority AE

**Tv** : Shutter-priority AE

**P** : Program AE

## Basic Zone

All you do is press the shutter button. The camera sets everything to suit the subject or scene.

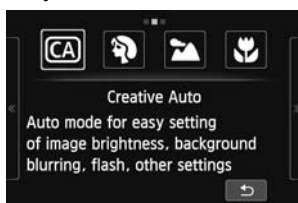

 : **Creative Auto** (p.54)

 : **Portrait** (p.56)

 : **Landscape** (p.57)

 : **Close-up** (p.58)

 : **Sports** (p.59)

 : **Night Portrait** (p.60)

 : **Handheld Night Scene** (p.61)

 : **HDR Backlight Control** (p.62)

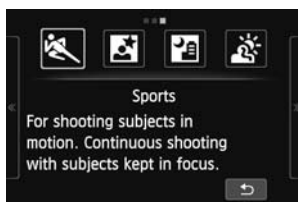

## Movies

With <> Movie, you can select Autoexposure or Manual exposure.



 : **Movie auto exposure**

 : **Movie manual exposure**

## Lens

### EF-M Lens

(Lens with no focus mode switch and no Image Stabilizer switch.)

\* Instructions for EF lens, EF-S lens and Mount Adapter EF-EOS M are in the Camera Instruction Manual PDF file.

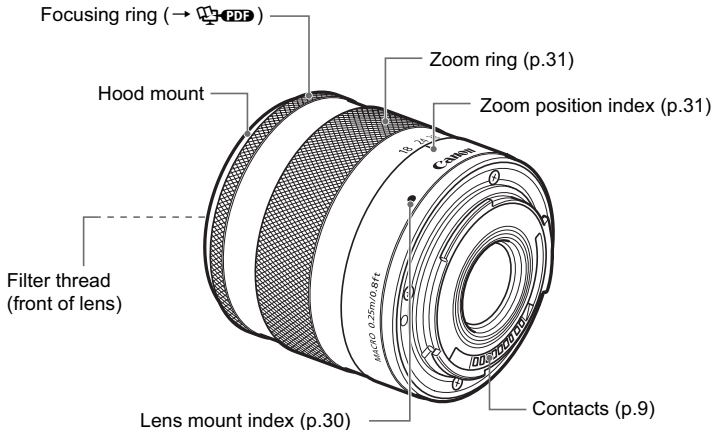

### Use of genuine Canon accessories is recommended

This product is designed to achieve excellent performance when used with genuine Canon accessories. Canon shall not be liable for any damage to this product and/or accidents such as fire, etc., caused by the malfunction of non-genuine Canon accessories (e.g., a leakage and/or explosion of a battery pack). Please note that this warranty does not apply to repairs arising out of the malfunction of non-genuine Canon accessories, although you may request such repairs on a chargeable basis.

## Battery Charger LC-E12

Charger for Battery Pack LP-E12 (p.20).

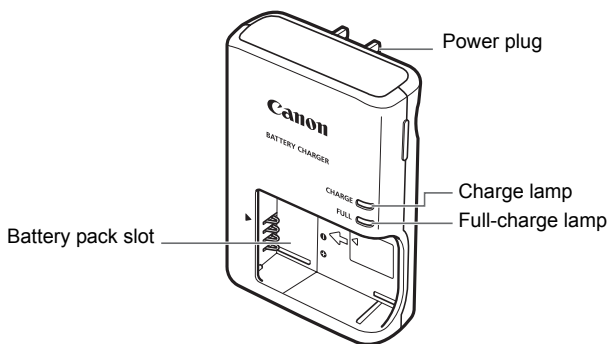

**IMPORTANT SAFETY INSTRUCTIONS-SAVE THESE INSTRUCTIONS.  
DANGER-TO REDUCE THE RISK OF FIRE OR ELECTRIC SHOCK,  
CAREFULLY FOLLOW THESE INSTRUCTIONS.**

For connection to a supply not in the U.S.A., use an attachment plug adapter of the proper configuration for the power outlet, if needed.

## Battery Charger LC-E12E

Charger for Battery Pack LP-E12 (p.20).

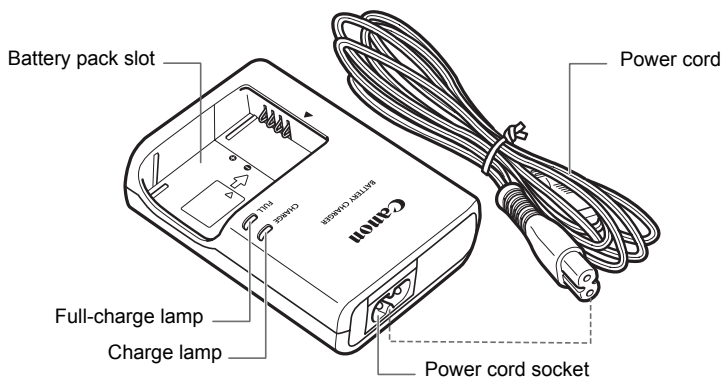



This camera was designed so you can truly enjoy taking photos and capturing the feeling, the essence of a moment in your photos.

Photographs are fun and wonderful!



## Getting Started

This chapter explains preparatory steps before you start shooting and basic camera operations.

### Attaching the Strap

Fit the strap's metallic ring over the camera's strap mount. Use a coin or similar tool to turn the stopper clockwise until it stops (the index marks are aligned). Make sure the strap's metallic ring is not loose.

Adjust the strap length.

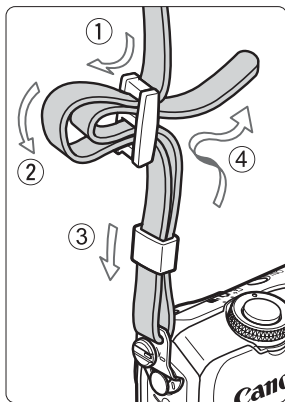
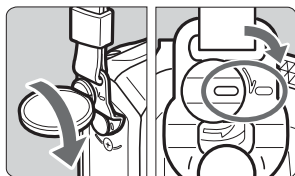
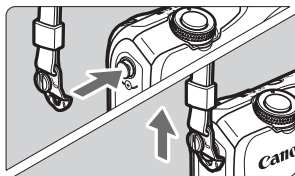

# Charging the Battery

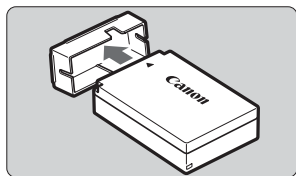

**1** Remove the protective cover.

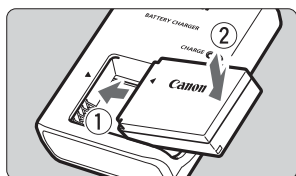

**2** Attach the battery.

- Align the battery's ◀ mark with the battery charger's ▶ mark.
- To detach the battery, follow the above procedure in reverse.

## LC-E12

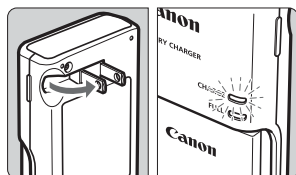

**3** Recharge the battery.

### For LC-E12

- As shown by the arrow, flip out the battery charger's prongs and insert the prongs into a power outlet.

### For LC-E12E

- Connect the power cord to the charger and insert the plug into a power outlet.
- ▶ Recharging starts automatically and the charge lamp lights up in orange.
- ▶ When the battery is fully recharged, the full-charge lamp will light up in green.

## LC-E12E

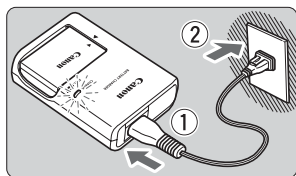

- It takes approx. 2 hours to fully recharge a completely exhausted battery at 23°C / 73°F. The time required to recharge the battery will vary greatly depending on the ambient temperature and the battery's remaining capacity.
- For safety reasons, recharging in low temperatures (5°C - 10°C / 41°F - 50°F) will take longer (up to approx. 4 hours).



## Tips for Using the Battery and Charger

- **Upon purchase, the battery is not fully charged.**  
Recharge the battery before using.
- **Recharge the battery on the day before or on the day it is to be used.**  
Even during storage, a charged battery will gradually drain and lose its capacity.
- **After recharging the battery, detach it and disconnect the charger from the power outlet.**
- **When not using the camera, remove the battery.**  
If the battery is left in the camera for a prolonged period, a small amount of power current is released, resulting in excess discharge and shorter battery life. Store the battery with the protective cover (provided) attached. Storing the battery when it is fully charged may lower the battery's performance.
- **The battery charger can also be used in foreign countries.**  
The battery charger is compatible with a 100 V AC to 240 V AC 50/60 Hz power source. If necessary, attach a commercially-available plug adapter for the respective country or region. Do not attach any portable voltage transformer to the battery charger. Doing so can damage the battery charger.
- **If the battery becomes exhausted quickly even after being fully charged, the battery has reached the end of its service life.**  
Purchase a new battery.



- After disconnecting the charger's power plug, do not touch the prongs for at least 3 sec.
- Do not charge any battery other than a Battery Pack LP-E12.
- Battery Pack LP-E12 is dedicated to Canon products only. Using it with an incompatible battery charger or product may result in malfunction or accidents for which Canon cannot be held liable.

# Installing and Removing the Battery and Card

Load a fully charged Battery Pack LP-E12 into the camera. The card (sold separately) can be an SD, SDHC, or SDXC memory card. SDHC and SDXC cards with UHS-I can also be used. The captured images are recorded onto the card.

- **Make sure the card's write-protect switch is set upward to enable writing/erasing.**

## Installing the Battery and Card

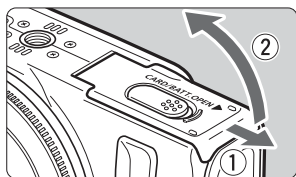

### 1 Open the cover.

- Slide the lever as shown by the arrows and open the cover.

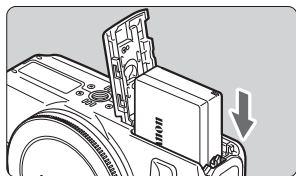

### 2 Insert the battery.

- The battery's "Canon" logo must be toward the camera's front side as you insert the battery with the battery contacts in first.
- Insert the battery until it clicks and locks in place.

Write-protect switch

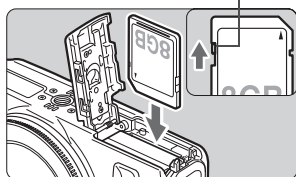

### 3 Insert the card.

- The card's label side must be toward the front of the camera.
- Insert it straight down until it stops.

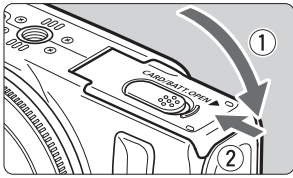

#### 4 Close the cover.

- Press the cover until it snaps shut.
- When you set the power to <ON>, the number of possible shots (p.26) will be displayed on the LCD monitor.



Possible shots

### Removing the Battery and Card

#### 1 Set the power to <OFF>.

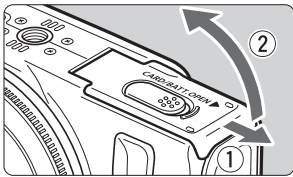

#### 2 Open the cover.

- Make sure the LCD monitor and Power/access lamp are off, then open the cover.
- If [Recording...] is displayed, close the cover.

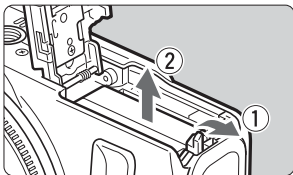

#### 3 Remove the battery.

- 1. Press the battery release lever as shown by the arrow. 2. Remove the battery.
- To prevent short circuiting of the battery contacts, be sure to attach the protective cover (provided, p.20) to the battery.

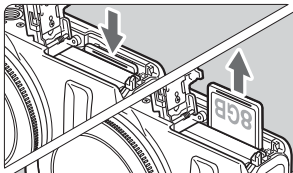



#### 4 Remove the card.

- Gently push in the card, then let go to eject it.
- Pull the card straight out.

#### 5 Close the cover.

- Press the cover until it snaps shut.

 After opening the card/battery compartment cover, be careful not to swing it back further. Otherwise, the hinge may break.

-  ● **When the Power/access lamp is blinking in orange, it indicates that images are being written to or read by the card, being erased, or data is being transferred. Do not open the card/battery compartment cover during this time. Also, never do any of the following while the Power/access lamp is blinking in orange. Otherwise, it can damage the image data, card, or camera.**
- **Removing the card.**
  - **Removing the battery.**
  - **Shaking or banging the camera around.**
- If the card already contains recorded images, the image number may not start from 0001.
- If a card-related error message is displayed on the LCD monitor, remove and reinsert the card. If the error persists, use a different card. If you can transfer all the images on the card to a computer, transfer all the images and then format the card with the camera (p.42). The card may then return to normal.
- Do not touch the card's contacts with your fingers or metal objects.

# Turning on the Power

If you set the power to <ON> and the time zone/date/time setting screen appears, see page 27 to set the time zone and date/time.



Pressing the power button toggles between <ON> and <OFF>.

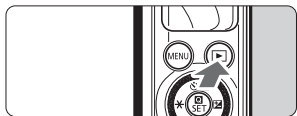

With the power <OFF>, holding down the <▶> button for 2 sec. or longer will start the playback mode.

- When an EF-M lens is attached to the camera and the power is off, the aperture stops down to shut out the light and protect the inside of the camera. When you set the power to <ON> or <OFF>, the aperture makes a small noise as it opens.

## MENU Power-saving Features

- To save power, the LCD monitor turns off automatically if you do not operate the camera. If you continue to not operate the camera, the power will turn off automatically. While the LCD monitor is off, pressing any camera button or tapping the LCD monitor will turn it on again. If the power turned off, either press the power button or press the <▶> for at least approx. 2 sec. to turn on the power again.
- You can change the LCD monitor auto off time and Camera auto off time with [**LCD auto off**] and [**Camera auto off**] under [**2: Power saving**] (→ PDF).







If you set the power to <OFF> while an image is being recorded to the card, [**Recording...**] will be displayed and the power will turn off after the card finishes recording the image.

## Checking the Battery Level

When the power is turned on, the battery level will be indicated in one of four levels.



-  : Battery level is sufficient.
-  : Battery level is low, but the camera can still be used.
-  : Battery will be exhausted soon. (Blinks)
-  : Recharge the battery.

### Battery Life

[Approx. number of shots]

Temperature	At 23°C / 73°F	At 0°C / 32°F
Possible shots	230	200

- The figures above are based on a fully-charged Battery Pack LP-E12 and CIPA (Camera & Imaging Products Association) testing standards.



- The number of possible shots will decrease with any of the following operations:
  - Pressing the shutter button halfway for a prolonged period. (Activating the AF frequently without taking a picture.)
  - Using the lens Image Stabilizer.
- The number of possible shots may decrease depending on the actual shooting conditions.
- The lens operation is powered by the camera's battery. Depending on the lens used, the number of possible shots may be lower.

## MENU Setting the Time Zone, Date and Time

When you turn on the camera for the first time, the Time zone and Date/Time setting screen will appear. First set the time zone, then set the date and time. **Note that the shooting date/time appended to the captured images will be based on this date/time setting. Be sure to set the correct date/time.**

### Set the Time Zone

[London] is set by default.



- 1 Display the menu screen.**
  - Press the <MENU> button.
- 2 Under the [⚡] tab, select [Time Zone].**
  - On the Main Dial, press the <◀ \* >/<▶ ☒ > button to select the [⚡] tab.
  - On the Main Dial, press the <▲ ⚡/☒ >/<▼ ☒ > button to select [Time Zone], then press <Q/SET>.
- 3 Set the date and time.**
  - On the Main Dial, press the <◀ \* >/<▶ ☒ > button to enable the selection of the time zone.
  - Press <Q/SET> so <⚡> is displayed.
  - On the Main Dial, press the <▲ ⚡/☒ >/<▼ ☒ > button to set the time zone, then press <Q/SET>.
  - On the Main Dial, press the <◀ \* >/<▶ ☒ > button to select [OK], then press <Q/SET>.

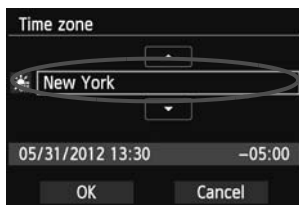

- The menu setting procedure is explained on pages 39-41.
- The time displayed on the lower right is the time difference compared with Coordinated Universal Time (UTC). If you do not see your time zone, set the time zone while referring to the difference with UTC.
- After changing the time zone, check that the correct date/time has been set.
- You can also set the daylight saving time with [⚡: Time zone].
- The [⚡: Time zone] and [⚡: Date/Time] daylight saving time settings are linked.

### Set the Date and Time



- 1 Display the menu screen.**
  - Press the <MENU> button.

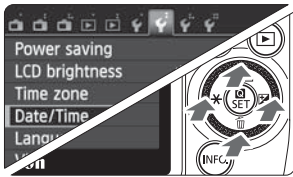

**2 Under the [F2] tab, select [Date/Time].**

- On the Main Dial, press the <◀ \* >/ <▶ ☒ > button to select the [F2] tab.
- On the Main Dial, press the <▲ ☺/☐ >/ <▼ ☒ > button to select [Date/Time], then press <Q/SET >.

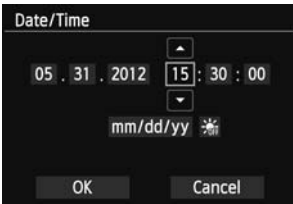

**3 Set the date and time.**

- On the Main Dial, press the <◀ \* >/ <▶ ☒ > button to select the number to be adjusted.
- Press <Q/SET > so <☐ > is displayed.
- On the Main Dial, press the <▲ ☺/☐ >/ <▼ ☒ > button to set the number, then press <Q/SET > (returns to <☐ >).



**4 Set the daylight saving time.**

- Set it if necessary.
- On the Main Dial, press the <◀ \* >/ <▶ ☒ > button to select [☺].
- Press <Q/SET > so <☐ > is displayed.
- On the Main Dial, press the <▲ ☺/☐ >/ <▼ ☒ > button to select [☺], then press <Q/SET >.
- When the daylight saving time is set to [☺], the time set in step 3 will advance by 1 hour. If [☺] is set, the daylight saving time will be canceled and the time will go back by 1 hour.

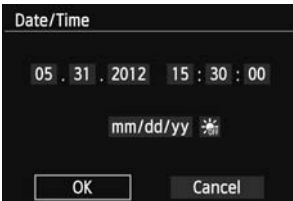

**5 Exit the setting.**

- On the Main Dial, press the <◀ \* >/ <▶ ☒ > button to select [OK], then press <Q/SET >.
- ▶ The date/time and daylight saving time will be set and the menu will reappear.

**!** If you remove the battery or the battery is exhausted, the time zone and date/time might be reset. If this happens, set the Time zone and Date/Time again.

**📅** To synchronize the seconds, in step 5, press <Q/SET > at 0 sec.



# MENU Selecting the Interface Language

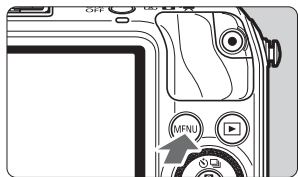

## 1 Display the menu screen.

- Press the <MENU> button.

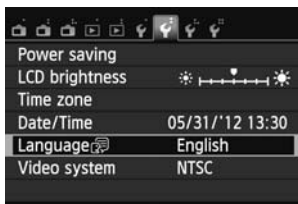

## 2 Under the [F2] tab, select [Language].

- On the Main Dial, press the <◀ \* >/ >▶ □ > button to select the [F2] tab.
- On the Main Dial, press the <▲ ☺ / □ >/ >▼ ▢ > button to select [Language] (the fifth from the top), then press <□ / SET >.

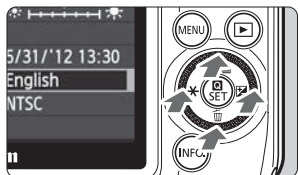

## 3 Set the desired language.

- On the Main Dial, press the <▲ ☺ / □ >/ >▼ ▢ >/ <◀ \* >/ >▶ □ > button to select the language, then press <□ / SET >.
- ▶ The interface language will change.



# Attaching and Detaching a Lens

The camera can use EF-M, EF, and EF-S lenses. To attach an EF or EF-S lens to the camera, Mount Adapter EF-EOS M is required.

## Attaching a Lens

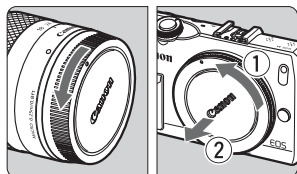

### 1 Remove the caps.

- Remove the rear lens cap and the body cap by turning them as shown by the arrows.

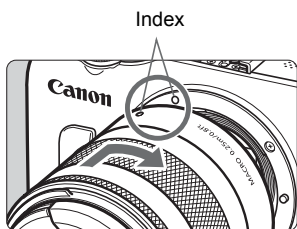

### 2 Attach the lens.

- Align the lens' index with the camera's index. Turn the lens as shown by the arrow until it clicks in place.

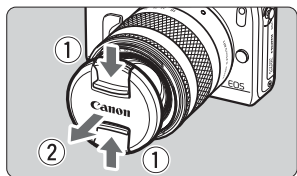

### 3 Remove the front lens cap.

#### Minimizing Dust

- When changing lenses, do it quickly in a place with minimal dust.
- When storing the camera without a lens attached, be sure to attach the body cap to the camera.
- Remove dust on the body cap before attaching it.

## Detaching the Lens

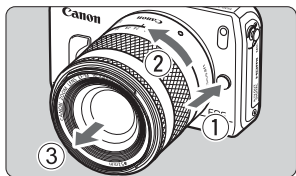

**While pressing the lens release button, turn the lens as shown by the arrow.**

- Turn the lens until it stops, then detach it.
- Attach the rear lens cap to the detached lens.

## About Zooming

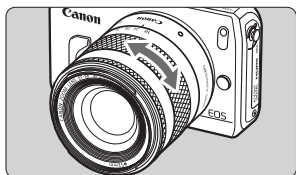

To zoom, turn the zoom ring on the lens with your fingers.

**If you want to zoom, do it before focusing. Turning the zoom ring after achieving focus may throw off the focus slightly.**



- Do not look at the sun directly through any lens. Doing so may cause loss of vision.
- If the front part (focusing ring) of the lens rotates during autofocus, do not touch the rotating part.
- The focus preset function of some lenses cannot be used with this camera. Also, Power Zoom cannot be used even if you attach a lens featuring the Power Zoom function, like the EF35-80mm f/4-5.6.



### Lens Focal Length (Image Conversion Factor)

Since the image sensor size is smaller than the 35mm film format, it will look like the lens focal length is increased by approx. 1.6x.

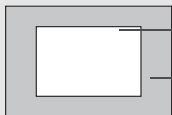

Image sensor size (Approx.)  
(22.3 x 14.9 mm / 0.88 x 0.59 in.)  
35mm image size  
(36 x 24 mm / 1.42 x 0.94 in.)

Example: An 18-55mm focal length would be equivalent to an approx. 29-88mm focal length on a 35mm camera.

# About the Lens Image Stabilizer

When you use the IS lens' built-in Image Stabilizer, camera shake is corrected to obtain a sharper shot.

\* IS stands for Image Stabilizer.

\* Instructions for EF and EF-S lenses are in the Camera Instruction Manual PDF file.

## With an EF-M Lens (Operated with a Menu)

Set it with the menu\*. By default, it is set to **[Enable]**.

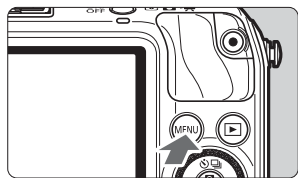

### 1 Display the menu screen.

- Press the <MENU> button.

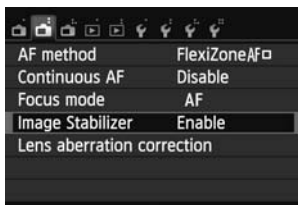

### 2 Under the [CAMERA] tab, select [Image Stabilizer].

- Press the <◀ \* ▶▶> button to select the [CAMERA] tab.
- Press the <▲ \* /▶▶> / <▼ \* >> button to select [Image Stabilizer], then press <Q/SET>.

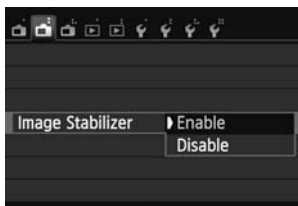

### 3 Select [Enable].

- Press the <▲ \* /▶▶> / <▼ \* >> button to select [Enable], then press <Q/SET>.
- Press the <MENU> button.

\* This menu is displayed when an EF-M lens with IS function has been attached.

## Using the Image Stabilizer when Shooting

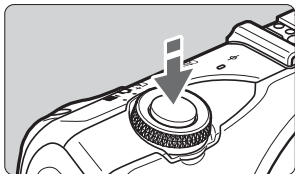

- 1 **Press the shutter button halfway.**
  - ▶ The Image Stabilizer will operate.

- 2 **Take the picture.**
  - When the picture looks steady on the LCD monitor, press the shutter button completely to take the picture.



- The Image Stabilizer cannot correct “subject blur”, when the subject moves at the time of exposure.
- For bulb exposures, set the IS to <OFF>. If <ON> is set, Image Stabilizer incorrect operation may occur.
- The Image Stabilizer may not be effective for excessive shaking such as on a rocking boat.



- The Image Stabilizer works in all focus modes.
- When the IS is set to <OFF>,  will appear on the screen.
- When using a tripod, you can still shoot with the IS set to <ON> with no problem. However, to save battery power, setting the IS to <OFF> is recommended.
- The Image Stabilizer is effective even when the camera is mounted on a monopod.

# Basic Operation

## Holding the Camera

To obtain sharp images, hold the camera still to minimize camera shake.

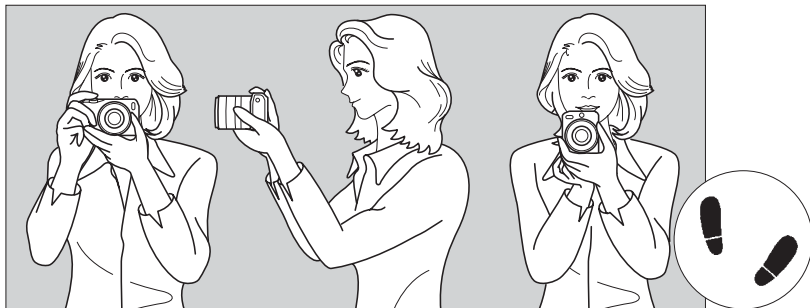

Horizontal shooting

Vertical shooting

1. Wrap your right hand around the camera grip firmly.
2. Hold the lens bottom with your left hand.
3. Rest your hand's right index finger lightly on the shutter button.
4. Press your arms and elbows lightly against the front of your body.
5. To maintain a stable stance, place one foot slightly ahead of the other.

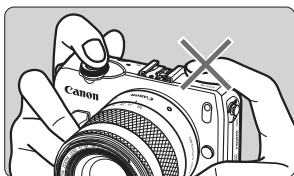

When shooting movies, be careful not to cover the microphone.

## Shutter Button

The shutter button has two steps. You can press the shutter button halfway. Then you can further press the shutter button completely.

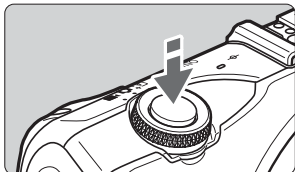

### Pressing halfway

The camera will focus and adjust the exposure automatically (shutter speed and aperture set automatically).

The exposure setting (shutter speed and aperture) is displayed (1/16).

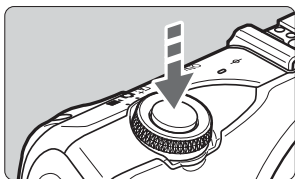

### Pressing completely

This releases the shutter and takes the picture.

## Preventing Camera Shake

Hand-held camera movement during the moment of exposure is called camera shake. It can cause blurred pictures. To prevent camera shake, note the following:

- Hold and steady the camera as shown on the preceding page.
- Press the shutter button halfway to autofocus, then slowly press the shutter button completely.



- If you press the shutter button completely without pressing it halfway first or if you press the shutter button halfway and then press it completely immediately, the camera will take a moment before it takes the picture.
- Even during menu display, image playback, or image recording, you can instantly go back to shooting-ready by pressing the shutter button halfway.

# Quick Control

You can directly select and set the shooting functions displayed on the LCD monitor. This is called the Quick Control screen.

There are two types of Quick Control screens: **Q** Quick Control and INFO. Quick Control.

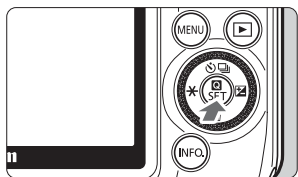

## 1 **Q** Quick Control

- Tap [**Q**] on the screen or press <**Q**/SET>.

## INFO. Quick Control

- Press and hold the <INFO.> button until the INFO. Quick Control screen shown on the next page appears.
  - ▶ The Quick Control screen will appear.

## 2 Set the desired function.

- Tap the function to be set.
  - ▶ The selected function and Feature guide will appear.
- On the screen that appears, tap on the function and set it.
  - ▶ There are also functions with more settings when you press the <INFO.> button.
- To select and set the function, you can press the Main Dial's <◀\*>, <▶☒>, <▲☺/☑>, or <▼☒> button or turn the Main Dial.



## Scene Intelligent Auto



### Quick Control



### INFO. Quick Control

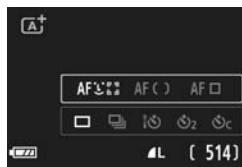

## Basic Zone modes

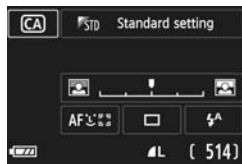

## Creative Zone modes



## 3 Take the picture.

- Press the shutter button completely to take the picture.



# MENU Menu Operations

You can set various settings with the menus such as the image-recording quality, date/time, etc. Operate the menus with the <MENU> button, Main Dial, and <Q/SET> button.

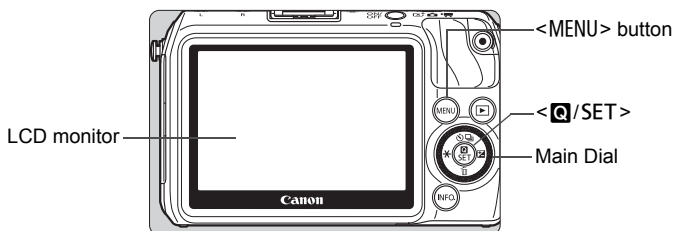

## Menu Screen

The menu applicable to the current shootings mode is provided.

### Scene Intelligent Auto

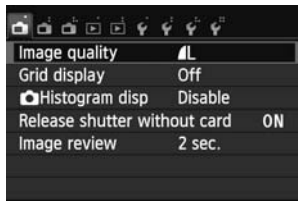
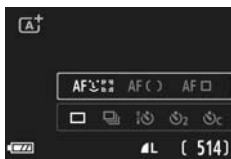

### Basic Zone modes

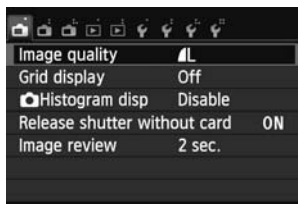

### Creative Zone modes

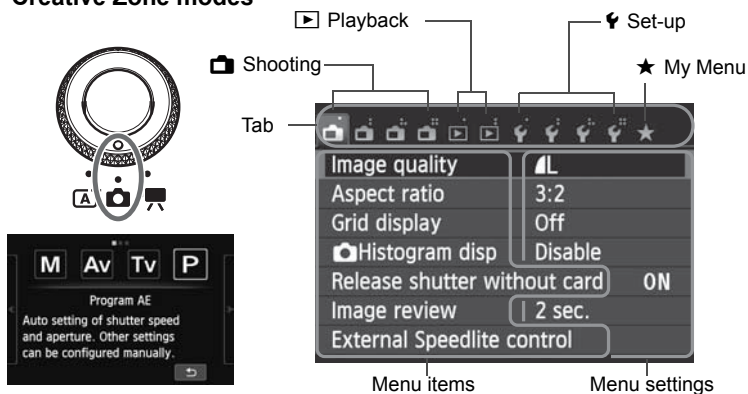

### Movie shooting



## Menu Setting Procedure

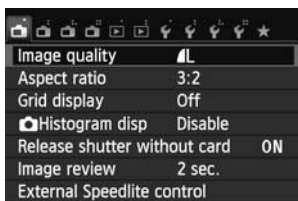

### 1 Display the menu screen.

- Press the <MENU> button.

### 2 Select a tab.

- Press the <◀\*>/<▶☒> button to select a tab.
- For example, the [☒3] tab refers to the screen displayed when the ☒ (Shooting) tab's third icon [☒<sup>3</sup>] from the left is selected.



### 3 Select the desired item.

- Press the <▲☒/☒>/<▼☒> button to select the item, then press <Q/SET>.

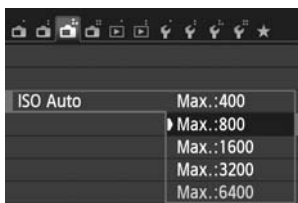

### 4 Select the setting.

- Press the <▲☒/☒>/<▼☒> button or <◀\*>/<▶☒> button to select the setting. (There are settings you select with the <▲☒/☒>/<▼☒> button and settings you select with the <◀\*>/<▶☒> button.)
- The current setting is indicated in blue.



### 5 Set the desired setting.

- Press <Q/SET> to set it.

### 6 Exit the setting.

- Press the <MENU> button to return to the shooting settings screen.



- In step 2, you can also turn the <☒> dial to select a menu tab.
- In steps 2 to 5, you can also use the LCD monitor's touch screen (p.45).
- To cancel, press the <MENU> button.

## MENU Formatting the Card

If the card is new or was previously formatted by another camera or computer, format the card with the camera.

- 1 When the card is formatted, all images and data in the card will be erased. Even protected images will be erased, so make sure there is nothing you need to keep. If necessary, transfer the images to a computer, etc., before formatting the card.

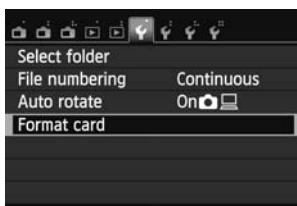

### 1 Select [Format card].

- Under the [1] tab, select [Format card], then press <Q/SET>.

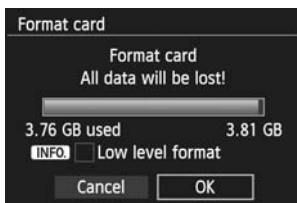

### 2 Format the card.

- Select [OK], then press <Q/SET>.
- ▶ When the formatting is completed, the menu will reappear.

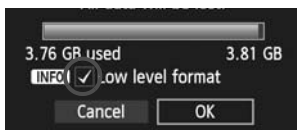

- For low-level formatting, press the <INFO.> button to append [Low level format] with a checkmark <✓>, then select [OK].

**Execute [Format card] in the following cases:**

- The card is new.
- The card was formatted by a different camera or a computer.
- The card is full with images or data.
- A card error is displayed (→ PDF).

**What is low-level formatting?**

- Perform low-level formatting if the card's recording or reading speed seems slow or if you want to totally erase all data in the card.
- Since low-level formatting will format all recordable sectors in the card, the formatting will take slightly longer than normal formatting.
- You can stop the low-level formatting by selecting **[Cancel]**. Even in this case, normal formatting will be completed and you can use the card as usual.



- When the card is formatted or data is erased, only the file management information is changed. The actual data is not completely erased. Be aware of this when selling or discarding the card. When discarding the card, execute low-level formatting or destroy the card physically to prevent the personal data from being leaked.
- **Before using a new Eye-Fi card, the software in the card must be installed in your computer. Then format the card with the camera.**



- The card capacity displayed on the card format screen may be smaller than the capacity indicated on the card.
- This device incorporates exFAT technology licensed from Microsoft.

# Switching the LCD Monitor Display

## INFO. Quick Control

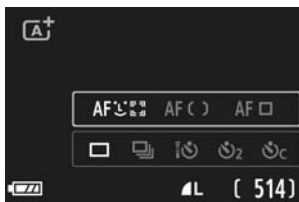

- Each time you press the <INFO.> button, the LCD monitor switches between the Live View screen and INFO. Quick Control (p.36).

## Menu

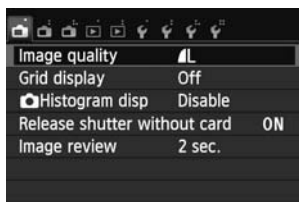

- Appears when you press the <MENU> button. Press the button again to return to the Live View screen.

## Captured Image



- Appears when you press the <▶> button. Press the button again to return to the Live View screen.

 Even when the menu screen or captured image is displayed, pressing the shutter button will enable you to shoot immediately.



# Using the Touch Screen and Main Dial ■

The LCD monitor is a touch-sensitive panel that you can operate with your fingers.

Also, on the camera back, you can turn the Main Dial to make a selection and press the dial's top, bottom, left, right, or center.

You can operate this camera by touching the LCD monitor or using the Main Dial (turning it or pressing the top, bottom, left, or right) to select an item, then pressing the Main Dial's center button to set it.

## Touch Screen

### Tap



#### Quick Control (Sample display)



- Use your finger to tap (touch and let go) the LCD monitor.
- By tapping, you can select menus, icons, etc., displayed on the LCD monitor.
- Icons that you can tap are displayed in a frame (except for the menu screen).
- By tapping [>], you can return to the previous screen.



#### Operations possible by tapping the screen

- Setting menu functions after pressing the <MENU> button
- Quick Control
- Setting a function after you press the <▲ /☐>, <▼ >, <◀ \* >, or <▶  > button
- Touch shutter
- Playback operations

## Drag

### Menu screen (Sample display)

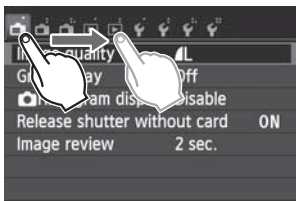

- Slide your finger while touching the LCD monitor.

### Scale display (Sample display)

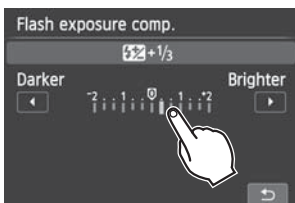

### Operations possible by dragging your finger on the screen

- Selecting a menu tab or item after pressing the <MENU> button
- Setting a scale control
- Quick Control
- Playback operations (swipe)

## Main Dial

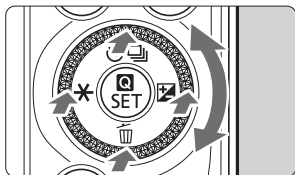

To select a function, you can turn the dial or press the top, bottom, left, and right edges. By pressing <Q/SET> at the center, you can set the selected function.





Through the lens of a camera, you may discover things you've never noticed before. Try wearing casual clothing so you can rest on one knee or crouch if necessary. Walk around with a camera in hand and observe your surroundings so you can discover new subjects you may find interesting.



## Scene Intelligent Auto + Basic Zone Modes

This chapter explains how to shoot with the Scene Intelligent Auto and Basic Zone modes.

Basic Zone modes enable you to just point and shoot by pressing the shutter button. However, you can also blur the background (p.55), apply image effects (→  PDF), and suit the lighting or scene (→  PDF).



### About the Auto Lighting Optimizer

In Basic Zone modes, the Auto Lighting Optimizer (→  PDF) will adjust the image automatically to obtain the optimum brightness and contrast. It is also enabled by default in Creative Zone modes.

# Fully Automatic Shooting (Scene Intelligent Auto)

< > is a fully automatic mode. The camera analyzes the scene and sets the optimum settings automatically.

With Scene Intelligent Auto, the camera always focuses automatically. You can select one of three AF methods with the menu or Quick Control screen. When you select [ (face)+Tracking], the person's face will be detected and focused (p.66). [**FlexiZone - Multi**] makes it easier to focus a moving subject (p.68). [**FlexiZone - Single**] uses only one AF point to focus the desired target subject (p.69).



Using [ (face)+Tracking] is explained below.

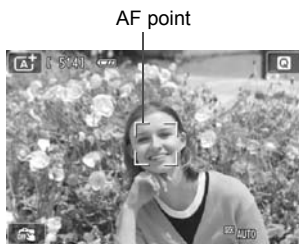

## 1 Set the Mode Dial to < >.



## 2 Check the AF point.

- When a face is detected, the < > AF point will appear over the face to be focused.
- You can also tap the screen to select the face or subject. If the subject is not a face, < > will be displayed.
- If no faces are detected or if you tap the screen but do not select any face or subject, the camera will switch to [**FlexiZone - Multi**] for automatic selection (p.68).

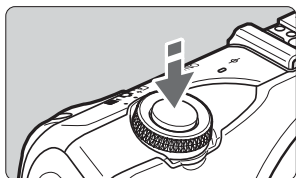

### 3 Focus the subject.

- Press the shutter button halfway to focus.
- ▶ When focus is achieved, the AF point will turn green and the beeper will sound.



### 4 Take the picture.

- Press the shutter button completely.
- ▶ The captured image will be displayed for approx. 2 sec. on the LCD monitor.



- The **<A+>** mode makes the colors look more impressive in nature, outdoor, and sunset scenes. If the desired color tone is not obtained, use a Creative Zone mode and select a Picture Style other than **<P>** and shoot (→ **PDF**).
- The image's field of view is approx. 99% (when the image-recording quality is set to JPEG **L**).
- During continuous shooting, the exposure set for the first shot will also be applied to subsequent shots.
- If you do not operate the camera and the time set with **[LCD auto off]** under **[Y2: Power saving]** elapses, the LCD monitor will turn off automatically. After the LCD monitor turns off and the time set with **[Camera auto off]** elapses, the power will turn off automatically.
- With a stereo AV cable or HDMI cable (both sold separately), you can display the image being shot on a TV set (→ **PDF**).

## FAQ

- **The AF point does not turn green and focus is not achieved.**  
Try again, aiming the AF point at an area with a good bright/dark contrast, then press the shutter button halfway. Also, focus might not be achieved if you are too close to the subject. Move away from the subject and shoot.
- **Multiple AF points appear in green.**  
Focus has been achieved at all the green AF points. When the AF point covering the desired subject turns green, take the picture.
- **Pressing the shutter button halfway does not focus the subject.**  
When an EF or EF-S lens is used, if the focus mode switch on the lens is set to <MF> (manual focus), manual focusing will be in effect. Set the focus mode switch to <AF> (autofocus).

## With Speedlite 90EX Attached (→ PDF)

(When you use flash, there is a slight time lag after you press the shutter button completely before the picture is taken.)

- **The flash fired even though it was daylight.**  
For a backlit subject, the flash may fire to help lighten the subject's dark areas. If you do not want the flash to fire, switch the Speedlite's power to <OFF>.
- **The flash fired and the picture came out extremely bright.**  
Move farther from the subject and shoot. When shooting flash photography, if the subject is too close to the camera, the picture may come out extremely bright (overexposure).
- **The flash fired, but the photo came out dark.**  
You were too far away from the subject. See "Effective Flash Range" (→  PDF) and shoot.
- **When flash was used, the bottom part of the picture came out unnaturally dark.**  
The subject was too close to the camera, and a shadow was created by the lens barrel. The subject should be at least 1 meter/3.3 feet away from the camera. If a hood is attached to the lens, remove it before taking the flash picture.

## Full Auto Techniques (Scene Intelligent Auto) ■

With a digital camera, you should use a card with ample capacity. If you cannot decide on the composition or which mode to use, you should shoot freely in various compositions and modes. Even if the picture is slightly blurred, it can still convey something. You can always erase failed or unwanted images, so be sure to try many different shots.

---

### Recomposing the Shot

































Depending on the scene, instead of having the subject at the center, you should put the subject toward the right or left and include some background. This gives the picture more balance and depth.

While you press the shutter button halfway to focus a still subject, the focus will be locked at the subject's distance. Then aim the camera to the right or left and press the shutter button completely. This is called "focus lock". Focus lock is also possible in other Basic Zone modes (except <img alt="Sports mode icon" data-bbox="225 590 245 610"/> Sports).

## Scene Icons

When you shoot in the  mode, an icon representing the scene detected by the camera will be displayed.

Subject Background	Portrait <sup>*1</sup>		Non-Portrait			Background Color
		Movement	Nature and Outdoor Scene	Movement	Close <sup>*2</sup>	
Bright						Gray
Backlit						
Blue sky included						Light blue
Backlit						
Sunset	*3			*3		Orange
Spotlight						Dark blue
Dark						
With tripod	 <sup>*4*5</sup>	*3	 <sup>*4*5</sup>	*3		

\*1 : Displayed only when the AF method is set to [+Tracking]. If another AF method is set, the “Non-Portrait” icon will be displayed even if a person is detected.

\*2 : Displayed when the attached lens has distance information. With an Extension Tube or Closeup Lens, the icon displayed may not match the actual scene.

\*3 : The icon suiting the scene detected will be displayed.

\*4 : Displayed when you use a tripod for a low-light or night scene.

\*5 : Displayed with any of the lenses below:

- EF24mm f/2.8 IS USM
- EF300mm f/2.8L IS II USM
- EF500mm f/4L IS II USM
- EF-S18-55mm f/3.5-5.6 IS II
- EF-S55-250mm f/4-5.6 IS II
- EF28mm f/2.8 IS USM
- EF400mm f/2.8L IS II USM
- EF600mm f/4L IS II USM
- EF-S18-135mm f/3.5-5.6 IS STM
- IS lenses marketed in 2012 or later.

\* For certain scenes, the icon displayed may not match the actual scene.



# Select a Shooting Mode



## 1 Tap the shooting mode icon on the screen's upper left corner.

- The shooting mode selection screen will appear.

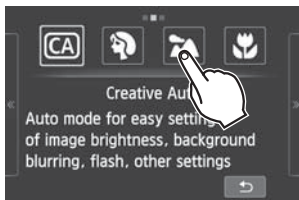

## 2 Tap the screen to select a shooting mode.

- You can also select the shooting mode on the INFO. Quick Control screen.









### With

Tap the arrow on either side of the screen to go to another page. The shooting mode screen has three pages, the Creative Zone screen has one page, and the Basic Zone screen has two pages.

### Creative Zone modes

You can select the following: **M**: Manual, **Av**: Aperture-priority AE, **Tv**: Shutter-priority AE, and **P**: Program AE.

### Basic Zone modes

: Creative Auto, : Portrait, : Landscape, : Close-up, : Sports, : Night Portrait, : Handheld Night Scene, : HDR Backlight Control

### With

: Autoexposure, : Manual exposure

# CA Creative Auto Shooting

In the <CA> mode, you can easily blur the background, change the drive mode or control the firing of an attached Speedlite flash. You can also choose the ambience you want to convey in your images. The default settings are the same as the <A+> mode.

\* CA stands for Creative Auto.



1 Turn the Mode Dial to <CA>, then select <CA> on the screen.



2 Display the Quick Control screen.

- With the **Q** Quick Control screen, you can check the effect while setting the function (except for [Backgnd:Blurred <-> Sharp]).



3 Set the desired function.

- Select the function, then tap [↵].
- ▶ The selected function and Feature guide (→ **PDF**) will appear.
- For setting procedure and details on each function, see the next page.

4 Take the picture.

- Press the shutter button.

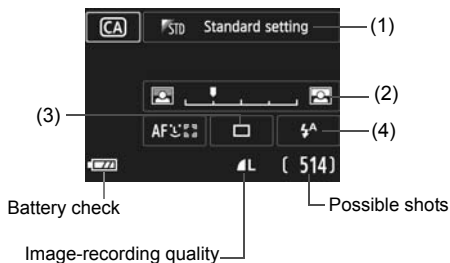

**(1) Ambience-based shots** (  Quick Control / INFO. Quick Control)

You can choose the ambience you want to convey in your images.

**(2) Blurring/Sharpening the background** (  Quick Control / INFO. Quick Control)

If you move the index mark toward the left, the background will look more blurred. If you move it toward the right, the background will look more in focus. If you want to blur the background, see “Shooting Portraits” on page 56.

Depending on the lens and shooting conditions, the background may not look so blurred. If flash is used, this setting will not be applied.

**(3) Drive mode** (INFO. Quick Control)

<  > **Single shooting:**

Shoot one image at a time.

<  > **Continuous shooting:**

While you hold down the shutter button completely, shots will be taken continuously. You can shoot up to approx. 4.3 shots per sec.



<  > **Self-timer: 10sec./remote:**

The picture is taken 10 seconds after you press the shutter button. A remote controller can also be used.

<  > **Self-timer: 2sec.:**

The picture is taken 2 seconds after you press the shutter button.

<  > **Self-timer: Continuous:**

Tap []/[] to set the number of multiple shots (2 to 10) to be taken with the self-timer. 10 seconds after you press the shutter button, the set number of multiple shots will be taken.

**(4) Attached Speedlite 90EX flash firing** (  Quick Control / INFO. Quick Control)

<  > **Auto flash** : The flash fires automatically when necessary.

<  > **Flash on** : The flash fires at all times.

<  > **Flash off** : The flash is disabled.

\* When a flash other than the Speedlite 90EX is attached, the flash mode will be set to Flash on.



If you change the shooting mode or set the power to <OFF>, the functions you have set on this screen will revert to their default setting. However, the AF method, image-recording quality, self-timer and remote control settings will be retained. With Creative Zone modes that allow the use of creative filters, the creative filter settings will be retained as well.

## Shooting Portraits (Portrait)

This mode blurs the background to make the person stand out better. It also makes skin tones and the hair look softer.

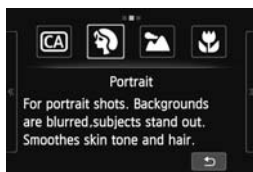

### Shooting Tips

- **The further the distance between the subject and background, the better.**  
The further the distance between the subject and background, the more blurred the background will look. The subject will also stand out better in front of a plain, dark background.
- **Use a telephoto lens.**  
If you have a zoom lens, use the telephoto end to fill the frame with the subject from the waist up. Move in closer if necessary.
- **Focus the face.**  
Check that the AF point covering the face turns green.

- The default setting is  (continuous shooting). If you hold down the shutter button, you can shoot continuously to obtain different poses and facial expressions (max. approx. 4.3 shots/sec.).
- Using the Speedlite 90EX or similar flash in Portrait mode is recommended.

## Shooting Landscapes (Landscape)

Suited for wide scenes when you want everything to be in focus from near to far. For vivid blues and greens, and very sharp and crisp images.

---

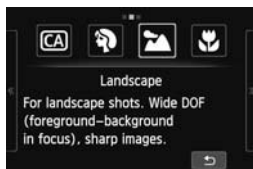

### Shooting Tips

- **With a zoom lens, use the wide-angle end.**  
When using the wide-angle end of a zoom lens, objects near and far will be in focus better than at the telephoto end. It also adds breadth to landscapes.
- **Shooting night scenes.**  
Since the flash will be disabled, this mode  is also good for night scenes. Use a tripod to prevent camera shake.

## Shooting Close-ups (Close-up)

For shooting flowers and small objects up close. To make small things appear much larger, use a macro lens (sold separately).

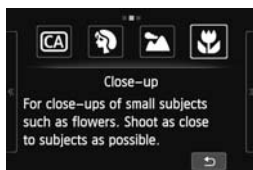

### Shooting Tips

- **Use a simple background.**  
When the background has no other flowers, leaves, etc., the close-up subject will stand out more.
- **Move as close as possible to the subject.**  
Check the lens for its minimum focusing distance. Some lenses have indications such as <img alt="Flower icon" data-bbox="328 633 348 653"/> **0.25m/0.8ft**>. (This example indicates a minimum focusing distance of 25 cm/0.8 ft.) The lens minimum focusing distance is measured from the <img alt="Focal plane mark" data-bbox="308 678 328 698"/> (focal plane) mark (on the left of the hot shoe) to the subject. If you get too close to the subject, focus cannot be achieved.
- **With a zoom lens, use the telephoto end.**  
If you have a zoom lens, using the telephoto end will make the subject look larger.

## Shooting Moving Subjects (Sports) ■

Use this mode to photograph a moving subject.



### Shooting Tips

- **Shoot continuously.**

When you press the shutter button halfway, the camera will focus and the AF point will be fixed.

While the camera focuses, the beeper will sound. If focus cannot be achieved, the AF point will turn orange.

When the right moment comes, press the shutter button completely to take the picture. If you hold down the shutter button completely, the camera will keep focusing and shooting continuously so you can capture the changing movement.

The continuous shooting speed (maximum number of frames per second) depends on the lens used.

- EF-M18-55mm f/3.5-5.6 IS STM: approx. 1.7 fps
- EF-M22mm f/2 STM: approx. 1.2 fps
- EF and EF-S lenses: approx. 4.3 fps

 Under low light, when camera shake is prone to occur, the LCD monitor's shutter speed display on the bottom left will blink. Hold the camera steady and shoot.

## Shooting Night Portraits (Night Portrait) (With a Tripod)

Attach Speedlite 90EX and shoot portraits with a beautiful and bright night scene in the background.

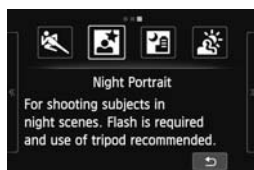

### Shooting Tips

- **Use a wide-angle lens and a tripod.**

When using a zoom lens, use the wide-angle end to obtain a wide night view. Also, use a tripod to prevent camera shake.

- **Take portraits without flash.**

When the Speedlite's power is <ON>, the Speedlite will fire a flash automatically under low-light conditions to obtain a nice portrait.

You should then play back the image to check the image brightness. If the subject looks dark, move nearer and shoot again.

The effective range of the flash is explained in “Effective Flash Range” (→  PDF).

When shooting a night scene without a human subject, turn off the Speedlite.

- **Also shoot in another shooting mode.**

Since camera shake is prone to occur with night shots, shooting also with <A+> and <P> is recommended.

- Tell the subject to keep still even after the flash fires.
- If you use a flash with the self-timer, the self-timer/AF-assist beam lamp will light up briefly after the picture is taken.
- When shooting night scenes or other scenes where multiple point-like light sources appear on the screen, the camera may not be able to focus automatically. In such cases, setting the [AF method] to [FlexiZone - Single] is recommended. If the camera still cannot focus automatically, set the focus mode to [MF] and focus manually.



## Shooting Night Scenes Handheld (Handheld Night Scene) ■

For shooting night scenes while handholding the camera. When you take a picture, four shots are taken continuously to produce a single, bright photo that reduces camera shake.

---



## Shooting Tips

- **Hold the camera firmly.**

While shooting, hold the camera firmly and steadily. If the continuous shots are very misaligned due to camera shake, etc., they may not align properly in the final image.

### **With Speedlite 90EX Attached**

- **If you will only shoot a night scene, turn off the Speedlite.**

If you are shooting only the night scene, turn off the flash.

- **If you are also photographing a person, turn on the Speedlite.**

To take a nice portrait, the first shot will use flash. Tell the person not to move until all four continuous shots are taken. The effective range of the flash for human subjects is explained in “Effective Flash Range”

(→  PDF).

## Shooting Backlit Scenes (HDR Backlight Control) ■

When shooting a scene having both bright and dark areas. When you take a picture, three continuous shots will be taken at different exposures. The loss of detail in highlights and shadows will be reduced in the final image.

---

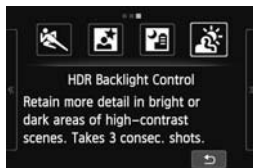

## Shooting Tips

- **Hold the camera firmly.**

While shooting, hold the camera firmly and steadily. If the continuous shots are very misaligned due to camera shake, etc., they may not align properly in the final image.



### < > (Handheld Night Scene)

- When shooting night scenes and other scenes with multiple point-like light sources, the camera may not be able to focus automatically. In such cases, set the focus mode to **[MF]** and focus manually.
- When shooting flash photography, if the flash fires and the subject's background is close enough to be illuminated by the flash or the night scene has only few lights, the shots may not align correctly. This can result in a blurry photo.
- When shooting flash photography, if the subject is too close to the camera, the picture may come out extremely bright (overexposure).
- When using a Speedlite with automatic flash coverage setting, the zoom position will be fixed to the wide end, regardless of the lens' zoom position. When using a Speedlite with manual flash coverage switch, shoot with the flash head retracted to the wide (normal) position.

### < > (HDR Backlight Control)

- The AF-assist beam will be emitted.
- Flash cannot be used.
- Note that the image may not be rendered with a smooth gradation and may look irregular or have significant noise.
- HDR Backlight Control may not be effective for excessively backlit scenes or extremely high-contrast scenes.
- When shooting subjects that are sufficiently bright, for example for normally lit scenes, the image may look unnatural because of the applied HDR effect.

### < > (Handheld Night Scene), < > (HDR Backlight Control)

- Compared with other shooting modes, the shooting area will be smaller.
- **[RAW] +**  or **[RAW]** cannot be selected. With other shooting modes, if **[RAW] +**  or **[RAW]** is set, the picture will be recorded in .
- If you shoot a moving subject, ghost-like images of the subject may result.
- The image alignment may not function properly with repetitive patterns (lattice, stripes, etc.), flat or single-tone images, or greatly misaligned shots caused by camera shake.
- Compared to normal shooting, recording the image to the card will take longer. During the processing of the images, **[BUSY]** will be displayed and you cannot take another picture until the processing is completed.
- You cannot use Creative filters when shooting.
- Final image simulation is not available.
- If the mode dial is set to < > or < >, direct printing is not possible. Select other mode and perform direct printing.

# ▶ Image Playback

The easiest way to play back images is explained below. For more details on the playback procedure, see page 81.

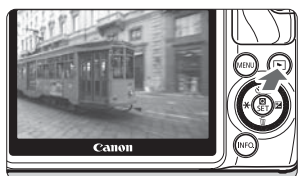

## 1 Play back the image.

- Press the <▶> button.
- ▶ The last captured image or last image viewed will appear.
- When the power is <OFF> and you hold down the <▶> button for 2 seconds or longer, the power will turn <ON> and the playback screen will appear.

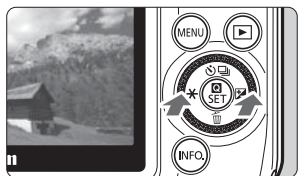

## 2 Select an image.

- When you press the <◀ \* > button, the last image captured will be displayed first.
- When you press the <▶ ☒ > button, the first image captured will be displayed first.
- Each time you press the <INFO.> button, the information display will change.



No information



With basic information

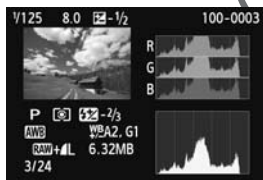

Histogram display

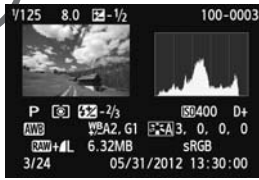

Shooting information

## 3 Exit the image playback.

- Press the <▶> button to exit the image playback and return to the Live View screen.

# Changing the Focusing Method

		Scene Intelligent Auto	Basic Zone modes, Creative Zone modes
Focus mode*	Menu	(AF only)	AF, MF, AF+MF
AF method	Menu, Quick Control	L+Tracking, FlexiZone - Multi, FlexiZone - Single	
Continuous AF	Menu	Enable / Disable	

\* "Focus mode" will be displayed when an EF-M lens has been attached.

\* Instructions for EF and EF-S lenses are in the Camera Instruction Manual PDF file.

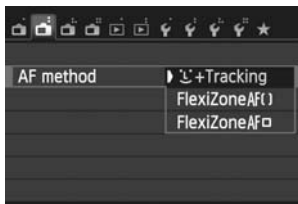
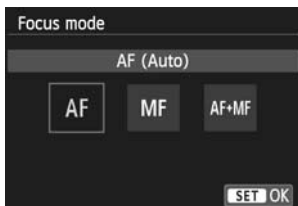

With an EF-M lens  
(operated with a menu):



## 1 Select the AF method.

- Under the [CAMERA] tab, select [Focus mode], [AF method], or [Continuous AF].
- Select the item to be set, then press <Q>/SET >.
- You can also select the [AF method] on the Quick Control screen.

## 2 Set the lens focus mode to [AF].

- Under the [CAMERA] tab, select [Focus mode].
- Select [AF].
- ▶ For [Focus mode], if you select [AF+MF], you can hold the shutter button pressed halfway after the AF operation and focus manually (MF) with the focusing ring.

## ☺(face)+Tracking: AF

Human faces are detected and focused. If a face moves, the AF point <[ ]> also moves to track the face.



### 1 Check the AF point.

- When a face is detected, the <[ ]> AF point will appear over the face to be focused.
- You can also tap the screen to select the face or subject. If the subject is not a face, <[ ]> will be displayed.
- If no faces are detected or if you tap the screen but do not select any face or subject, the camera will switch to **[FlexiZone - Multi]** for automatic selection (p.68).

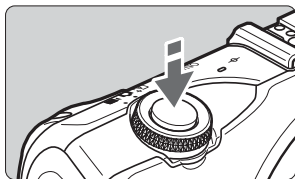

### 2 Focus the subject.

- Press the shutter button halfway to focus.
- ▶ When focus is achieved, the AF point will turn green and the beeper will sound. (If **[AF operation]** has been set to **[Servo AF]**, the AF point remains white and the beeper will not sound.)
- ▶ If focus is not achieved, the AF point will turn orange.



### 3 Take the picture.

- Press the shutter button completely (p.49).



- If the focus is far off, face detection will not be possible. If you set **[Continuous AF]** to **[Enable]**, you can prevent the image from becoming greatly out of focus.
- An object other than a human face may be detected as a face.
- Face detection will not work if the face is very small or large in the picture, too bright or too dark, or partially hidden.
- The <[ ]> may cover only part of the face.



- When you press the <[ ]> button, the <[ ]> AF point will appear at the center of the screen. Drag it to move the AF point. Press the <[ ]> button again, and the AF point will move to the detected subject.
- Since AF is not possible with a face detected near the edge of the picture, the <[ ]> will be grayed out. If you press the shutter button halfway, the subject will be focused in FlexiZone - Multi method with automatic selection.



**When [Continuous AF] (p.72) or [Movie servo AF] (→ [PDP]) is set to [Enable]**

- When [**+**Tracking] or [**FlexiZone - Multi**] with automatic selection is set, the AF point will be momentarily displayed in the image center if the subject is not detected. If you press the shutter button halfway, the camera will focus in FlexiZone - Multi method with automatic selection.

## FlexiZone - Multi: AF ( )

Up to 31 AF points (automatically selected) covering a wide area can be used to focus. This wide area can also be divided into 9 zones for focusing (zone selection).



### 1 Select the AF zone. ☆

- Pressing the <▼ [AF Zone Icon]> button will toggle between automatic selection and zone selection. In Basic Zone modes, automatic selection will be set.
- To select a zone, tap it on the screen. To return to the center zone, press the <▼ [AF Zone Icon]> button.
- During zone selection, tap the [ [AF Zone Icon] ] icon on the screen to switch to automatic selection.

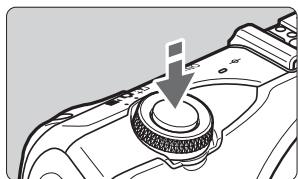

### 2 Focus the subject.

- Aim the AF point over the subject and press the shutter button halfway.
  - ▶ When focus is achieved, the AF point turns green and the beeper sounds. (If [AF operation] has been set to [Servo AF], the AF point remains white and the beeper will not sound.)
  - ▶ If focus is not achieved, the AF point will turn orange.



### 3 Take the picture.

- Press the shutter button completely (p.49).





- When the camera does not focus the desired target subject with automatic AF point selection, switch the AF method to zone selection or **[FlexiZone - Single]**, and refocus.
- Depending on the aspect ratio setting, the number of AF points will differ. At **[3:2]**, there will be 31 AF points. At **[1:1]** and **[4:3]**, there will be 25 AF points. And at **[16:9]**, 21 AF points. Also, at **[16:9]**, there will be only three zones.
- For movie shooting, there will be 21 AF points (or 25 AF points if **[640x480]** is set) and three zones (or 9 zones if **[640x480]** is set).

## FlexiZone - Single: AF □

Since only one AF point is used to focus, you can focus the target subject.



AF point

### 1 Move the AF point.

- Tap the screen where you want to focus to move the AF point. (It cannot go to the edges of the picture.) To return the AF point to the center, press the **<▼ [trash] >** button.

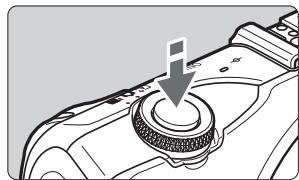

### 2 Focus the subject.

- Aim the AF point over the subject and press the shutter button halfway.
- ▶ When focus is achieved, the AF point turns green and the beeper sounds. (If **[AF operation]** has been set to **[Servo AF]**, the AF point remains white and the beeper will not sound.)
- ▶ If focus is not achieved, the AF point will change to orange.



### 3 Take the picture.

- Press the shutter button completely (p.49).

## Notes About [**⏏**+Tracking], [FlexiZone - Multi], and [FlexiZone - Single]

### AF Operation

- Even when focus has been achieved, pressing the shutter button halfway will focus again.
- The image brightness may change during and after the AF operation.
- If the light source changes during autofocusing, the screen may flicker and focusing may be difficult. If this happens, autofocus under the light to be used for shooting.
- When [FlexiZone - Multi] is set and you tap on [**Q**] on the screen, the center of the zone (or screen center if automatic selection is set) will be magnified. If you press the shutter button halfway, the display will return to normal and the camera will focus.
- When [FlexiZone - Single] is set and you tap on [**Q**] on the screen, the image at the AF point will be magnified. When you press the shutter button halfway, the camera will focus while the magnified image is displayed (however, if [AF operation] is set to [Servo AF], the display will return to normal and then the camera will focus). This is effective when the camera is attached to a tripod and you need to attain very precise focus. If focusing is difficult in the magnified view, return to the normal display and use AF. Note that the AF speed may differ between the normal and magnified views.
- If you magnify the view after focusing with [FlexiZone - Multi] or [FlexiZone - Single] in the normal view, it may not look focused.
- If [**⏏**+Tracking] is set, magnified view is not possible.

### About continuous shooting when [AF operation] is set to [Servo AF]:

- When [**⏏**+Tracking] or [FlexiZone - Multi] is set, when you press the shutter button halfway, the camera will focus and the AF point will be fixed.
- When an EF-M lens is used, Servo AF will be used to focus; if an EF or EF-S lens is used, focus lock will be used instead.

- 
- If you shoot a peripheral subject and it is slightly out of focus, aim the center AF point or zone over the subject to focus, focus again and then take the picture.
  - When [FlexiZone - Multi] is set and AF is used to focus, depending on the shooting conditions, it may take longer to focus the subject.
  - In magnified view, focusing using AF may be difficult due to the magnified effect of camera shake. Using a tripod is recommended.

## Shooting conditions that make focusing difficult

- Low-contrast subjects such as the blue sky, solid-color flat surfaces or when highlights or shadow details are lost.
- Extremely bright or dark subjects.
- Stripes and other patterns where there is contrast only in the horizontal direction.
- Subjects with repetitive patterns (skyscraper windows, computer keyboards, etc.).
- Fine lines and subject outlines.
- Under a light source whose brightness, color, or pattern keeps changing.
- Night scenes or points of light.
- When the image flickers under fluorescent or LED light sources.
- Extremely small subjects.
- Subjects at the edge of the picture.
- Subjects strongly reflecting light.
- The AF point covers both a near and faraway subject (such as an animal in a cage).
- Subjects that keep moving within the AF point and cannot keep still due to camera shake or subject blur.
- Autofocusing while the subject is very far out of focus.
- Soft focus effect is applied with a soft focus lens.
- A special effect filter is used.



- In the above cases, if the camera cannot focus automatically, focus manually.
- With some EF lenses (Mount Adapter EF-EOS M required), it may take longer to achieve focus or correct focus may not be achieved. For the latest information, visit your local Canon Web site.

## Using Continuous AF

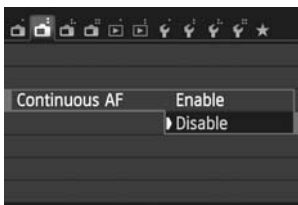

The default setting is **[Enable]**. Since the focus is constantly close to the subject, when you press the shutter button, the camera quickly focuses the subject. If **[Enable]** is set, the lens will operate frequently and consume more battery power. This will reduce the number of possible shots (battery life). When an EF or EF-S lens is used, during Continuous AF, turn off the power before setting the lens's focus mode switch to **<MF>**.

## Using AF+MF Mode (Full-time manual focusing)

Set the Focus mode to **[AF+MF]**.

After focus is achieved using AF, you can adjust the focus manually as desired using the focusing ring while holding the shutter button pressed halfway.





However, in **<A>** mode (p.59) or if **[AF operation]** is set to **[Servo AF]** (→ **[PDF]**), priority is given to Servo AF. In such cases, even if you set the focus mode to **[AF+MF]**, you will not be able to focus manually.

# Shooting with the Touch Shutter

You can focus and take the picture automatically just by tapping the LCD monitor screen. This works in all shooting modes.



## 1 Enable the touch shutter.

- Tap  on the screen's bottom left. Each time you tap the icon, it will toggle between  and .
- When  is set, you can tap to focus and shoot. When  is set, you can tap to select the point to focus. Then, press the shutter button completely to shoot.

## 2 Tap the screen to shoot.

- Tap the face or subject on the screen.
- ▶ At the point you tap, the camera will focus in the AF method that was set (p.66-69). When **[FlexiZone - Multi]** is set, it will switch to **[FlexiZone - Single]**.
- ▶ When focus is achieved, the picture is taken automatically.
- The picture is not taken if focus is not achieved. Tap the face or subject on the screen again.



- Even if the drive mode is set to  (> (continuous shooting)), single shooting will take effect.
- The touch shutter does not function when the view is magnified.
- When **[1: AE lock/AF]** or **[3: AE/AF, no AE lock]** is set to **[5: Shutter/AE lock button]** under **[4: Custom Functions (C.Fn)]**, autofocusing does not take effect.

- You can also enable the touch shutter by setting **[Touch Shutter: Enable]** under the  **[3]** tab.
- To take a bulb exposure, tap the screen twice. The first tap on the screen will start the bulb exposure. Tapping it again will stop the exposure. Be careful not to shake the camera when tapping the screen.
- Even if **[AF operation]** is set to **[Servo AF]**, One-Shot AF will take effect when touch shutter is used.

# Using the Self-timer

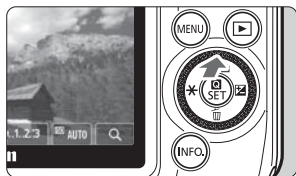

## 1 Press the $\blacktriangle$ $\square$ button.

- You can also select the shooting mode on the INFO. Quick Control screen.



## 2 Tap the self-timer.

- By tapping  $\square$ , you can return to the previous screen.

### : 10-sec. self-timer

The remote controller can also be used ( $\rightarrow$  P. 107).

### $\square$ : 2-sec. self-timer

### $\square$ : 10-sec. self-timer plus continuous shots

Tap  $\blacktriangle$ / $\blacktriangledown$  to set the number of multiple shots (2 to 10) to be taken with the self-timer.

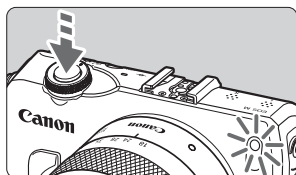

## 3 Take the picture.

- Focus the subject, then press the shutter button completely.
- ▶ You can check the self-timer operation with the self-timer/AF-assist beam, beeper, and countdown display (in seconds) on the LCD monitor.
- ▶ Two seconds before the picture is taken, the self-timer/AF-assist beam will light up and the beeper will sound faster.

### To cancel the self-timer shooting:

Press the  $\blacktriangle$   $\square$  button or set the power to <OFF>.

(To cancel the self-timer setting, press the  $\blacktriangle$   $\square$  button and tap  $\square$  or  $\square$ .)



Movies shot with interchangeable-lens digital cameras have a unique look, different from video shot with camcorders. You can manipulate how light enters the camera, shoot wide angle, and enjoy many other video features.

# 3

## Shooting Movies



Set the Mode Dial to <[Movie Camera Icon]> to shoot movies. The movie recording format will be MOV.

For more movie-shooting details, functions, and cautions, see the Camera Instruction Manual PDF file.



### Cards that can record movies

**When shooting movies, use a large-capacity SD card rated SD Speed Class 6 “CLASS 6” or higher.**

If the card's writing speed is slow, the movie may not be recorded properly. Also, if the card's reading speed is slow, movies recorded on the card may not play properly.

To check the card's read/write speed, refer to the card manufacturer's Web site.





### About Full HD 1080

Full HD 1080 indicates compatibility with High-Definition featuring 1080 vertical pixels (scanning lines).



# Shooting Movies

Connecting the camera to a TV set is recommended to play back the movies shot (→  PDF).

\* For details on manual-exposure movie shooting () , see the Camera Instruction Manual PDF file.

## Autoexposure Shooting

When you select the Movie shooting mode [] , autoexposure is set to adjust the brightness automatically.



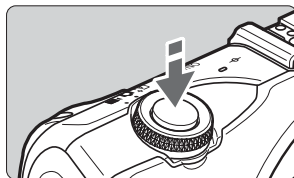

1 Set the Mode Dial to < >.

2 Select [] (Movie auto exposure) for the shooting mode.





3 Focus the subject.

- Before shooting a movie, focus with AF or manual focus (p.65-69).
- By default, [Movie Servo AF: Enable] (→  PDF) is set for continuous focusing.
- When [Movie Servo AF] is set to [Enable], you can tap [] on the screen's lower left to stop/start the focusing. If you stop the focusing, the AF point will turn gray.



Recording movie

4 Shoot the movie.

- Press the < > (Movie start/stop) button to start shooting a movie. To stop shooting the movie, press the < > (Movie start/stop) button again.
- ▶ While the movie is being shot, the “●” mark will be displayed on the upper right of the screen.
- While shooting a movie, be careful not to cover the microphone with your finger.

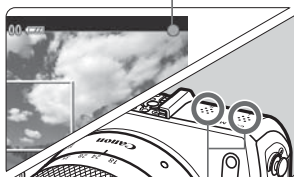

Microphone





With certain lenses, focus cannot be achieved with AF. Focus manually instead (→ PDF).



- If [**Movie Servo AF: Disable**] is set, you can focus by pressing the shutter button halfway.
- The ISO speed (100-6400), shutter speed, and aperture are set automatically.
- Press the <◀ \* > button to lock the current exposure setting (AE lock) (→ PDF). To release the AE lock, press the <◀ \* > button again. In movie shooting mode, you can tap [\*] to lock the exposure/release the AE lock.
- You can then set the exposure compensation by pressing the <▶ ☒ > button to display the range that can be set [ 3.2.1.4, 1.2.3 ] and then turning the <◉ > dial.
- Pressing the shutter button halfway displays the shutter speed, aperture, and ISO speed on the screen's bottom. This is the exposure setting for taking a still photo (p.78). The exposure setting for movie shooting is not displayed. Note that the exposure setting for movie shooting may differ from that for still photo shooting.

## Movie Shooting Screen

- Each time you press the <INFO.> button, the information display will change.

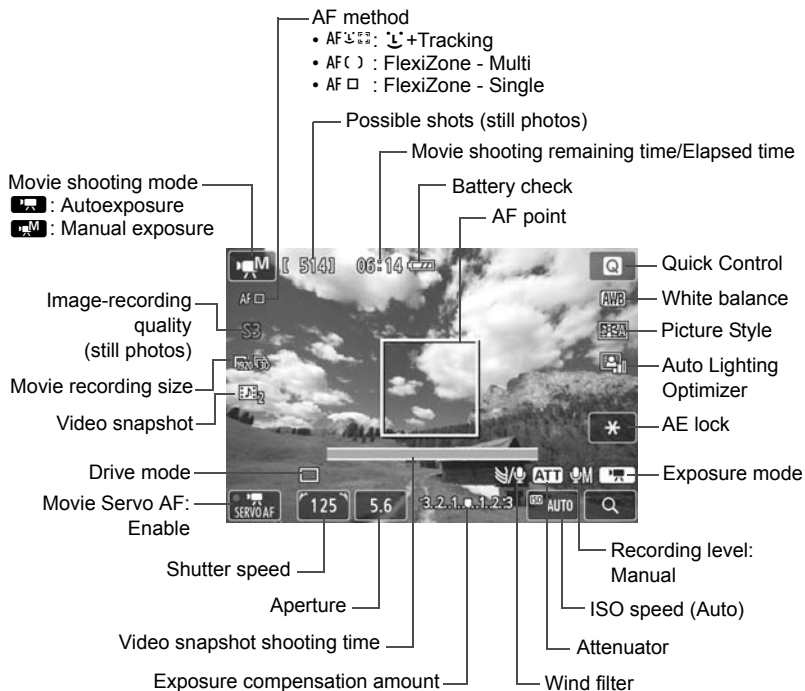

\* When an Eye-Fi card is inserted in the camera, the Eye-Fi transmission status (→ PDE) will be displayed.

When movie shooting starts, the movie shooting remaining time will change to the elapsed time.

## During movie shooting, note the following:



- If <AWB> is set and the ISO speed or aperture changes during movie shooting, the white balance may also change.
- If you shoot a movie under fluorescent or LED lighting, the movie may flicker.
- Zooming the lens during movie shooting is not recommended. Zooming the lens can cause changes in the exposure regardless of whether the lens' maximum aperture changes or not. Exposure changes may be recorded as a result.



- Movie-related settings are under the [ 1 ] tab (→ PDF).
- A movie file is recorded each time you shoot a movie. If the file size exceeds 4 GB, a new file will be automatically created.
- The movie image's field of view is approx. 100% (with movie recording size set to [ 1920 ]).
- The sound will be recorded in stereo by the camera's built-in microphone (p.76).
- Most commercially-available external stereo microphones with a 3.5 mm diameter miniplug can be connected to the camera. If an external microphone has been connected to the camera's external microphone IN terminal (p.12), it will be given priority the built-in microphone.
- You can use the Remote Controller RC-6 (sold separately, → PDF) to start and stop the movie shooting if the drive mode is < >. Set the shooting timing switch to <2> (2-sec. delay), then press the transmit button. If the switch is set to <●> (immediate shooting), still photo shooting will take effect.
- With a fully-charged Battery Pack LP-E12, the total movie shooting time will be as follows: approx. 1 hr. 30 min. at room temperature (23°C/73°F), and approx. 1 hr. 20 min. at low temperature (0°C/32°F).
- If the Speedlite 90EX is attached, set the Speedlite's power to <OFF>.





---

Viewing images on a large TV screen is a very different experience from seeing them on a computer screen.

Seeing photos on a large screen is another way to enjoy them.

---

# 4

## Image Playback

---

This chapter explains basic operations to playback images and movies.

### **About images shot and saved with another device**

The camera may not be able to properly display images captured with a different camera, edited with a computer or whose file name was changed.

# Playing Back with the Touch Screen ■

The LCD monitor is a touch-sensitive panel that you can touch with your fingers for playback operations. **Press the <▶> button to play back images.** (The last shot will appear first.)

If the power is off, you can hold down the <▶> button for 2 sec. or longer to turn on the camera and display the playback screen.

## Browse Images



### Swipe with one finger.

- With the single-image display, use **one finger** to swipe the image to the left or right to see another image. Swipe to the left to see the next (newer) image or swipe to the right to see the previous (older) image.
- With the index display of four or nine images, use **one finger** to scroll up or down the screen to display another screen of index images. Swipe your finger up to see newer images or swipe your finger down to see the older images. When you select an image and tap it, it will be displayed as a single image.

## Jump through Images (Jump Display)

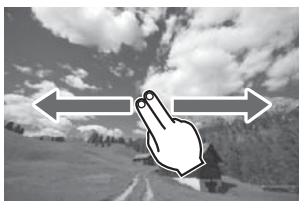

### Swipe with two fingers.

When you use **two fingers** to swipe left or right on the screen, you can jump through images with the method set in [Image jump with ] under the [▶2] tab.

## Reduce Images (Index Display)



### Pinch two fingers.

Touch the screen with two fingers spread apart, and pinch your fingers together on the screen.

- Each time you pinch your fingers, the screen changes from a single-image display to a 4-image index display and 9-image index display.
- The selected image on the index display is indicated in an orange frame.
- Movie images on the index display will have a vertical perforation.

## Magnify Images



### Spread two fingers apart.

Touch the screen with two fingers together, then spread your fingers apart on the screen.

- As you spread your fingers, the image will be magnified.
- The image can be magnified up to 10x.
- Tapping the [↶] icon on the screen's upper right will return to the single-image display.

# ▶ Playing Movies

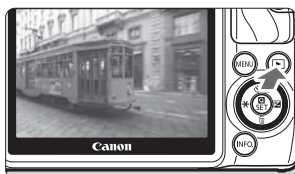

## 1 Play back the image.

- Press the <▶> button to display images.

## 2 Select a movie.

- Press the <◀ \* ▶>/<▶ [ ]> button to select a movie.
- On the single-image display, the <▶ [ ]> icon displayed on the upper left indicates a movie. If the movie is a video snapshot, <▶ [ ]> will be displayed.
- You can press the <INFO.> button to switch to the shooting information display (→ [PDF]).
- In the index display, perforations at the left edge of a thumbnail indicate a movie.  
**As movies cannot be played on the index display, press <Q/SET> to switch to the single-image display.**



## 3 In the single-image display, press

<▶ [ ]>.

- ▶ The movie playback panel will appear at the bottom of the screen.



## 4 Play back the movie.

- Select [▶] (Play), then press <Q/SET>.
- ▶ The movie will start playing.
- You can pause the movie playback by pressing <Q/SET>.
- During movie playback, you can turn the <◻> dial to adjust the built-in speaker's sound volume.
- For more details on the playback procedure, see the next page.



Speaker

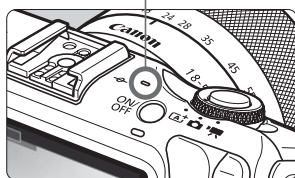



## Movie Playback Panel

Operation	Playback Description
▶ Play	Pressing <Q/SET> toggles between play and stop.
▶ Slow motion	Adjust the slow motion speed by pressing the <◀✳>/<▶☒> button. The slow-motion speed is indicated at the upper right of the screen.
◀◀ First frame	Displays the movie's first frame.
◀◀ Previous frame	Each time you press <Q/SET>, the previous frame is displayed. If you hold down <Q/SET>, it will rewind the movie.
▶▶ Next frame	Each time you press <Q/SET>, the movie will play frame-by-frame. If you hold down <Q/SET>, it will fast forward the movie.
▶▶ Last frame	Displays the movie's last frame.
✂ Edit	Displays the editing screen (→ ).
🎵 Background music*	Play back a movie with the selected background music (→ ).
	Play back position
mm' ss"	Playback time (minutes:seconds)
🔊 Volume	You can adjust the built-in speaker's (p.84) volume by turning the <🌀> dial.
MENU ↶	Returns to the single-image display.

\* When background music is set, the movie's sound will not be played.

## Playback with the Touch Screen



### Tap [▶] at the center of the screen.

- ▶ The movie will start playing.
- To display the movie playback panel, tap <▶🎞> on the upper left of the screen.
- To pause the movie while it is playing, tap the screen. The movie playback panel will also appear.



- With a fully-charged Battery Pack LP-E12, the continuous playback time at 23°C/73°F will be as follows: approx. 2 hr. 20 min.
- If you took a still photo while you shot the movie, the still photo will be displayed for approx. 1 sec. during the movie playback.

# 5

## Instruction Manuals in the CD-ROM and Software Start Guide

This chapter explains how to view the instruction manual PDF files in the provided CD-ROMs. It also introduces the software contained in the EOS DIGITAL Solution Disk (CD-ROM) and explains how to install them to your personal computer.

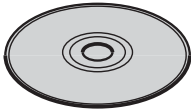

**EOS DIGITAL  
Solution Disk  
(Software)**

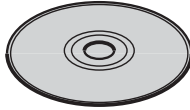

**Instruction Manual**

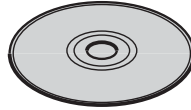

**Software  
Instruction Manual**

# Viewing the Instruction Manual CD-ROM ■

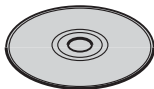

## Camera Instruction Manual

The Instruction Manual CD-ROM has the following PDF files: Camera Instruction Manual, Lens Instruction Manual (EF-M18-55mm f/3.5-5.6 IS STM and EF-M22mm f/2 STM), Mount Adapter EF-EOS M Instruction Manual, and Speedlite 90EX Instruction Manual.

### Camera Instruction Manual (PDF file)

Explains all the camera's functions and operation procedures and includes also all the contents in this Basic Instruction Manual. Contains instructions for all functions, including those covered in this Basic Instruction Manual. It provides detailed instructions not found in this Basic Instruction Manual such as shooting with EF and EF-S lenses with Mount Adapter EF-EOS M, advanced shooting and playback procedures, printing photos, and Custom Functions.

### Accessory Instruction Manual (PDF file)

PDF files for the Lens Instruction Manual (EF-M18-55mm f/3.5-5.6 IS STM and EF-M22mm f/2 STM), Mount Adapter EF-EOS M Instruction Manual, and Speedlite 90EX Instruction Manual are provided.

---

## Viewing the Instruction Manual CD-ROM

To view the instruction manual PDF files in the Instruction Manual CD-ROM, your personal computer must have Adobe Reader (version 6.0 or higher) installed. You can download Adobe Reader from the Internet for free. After installing Adobe Reader, follow the procedure below.

**1 Insert the Instruction Manual CD-ROM into your computer.**

**2 Double-click the CD-ROM icon.**

- For Windows, the icon will be displayed in **[[My Computer]**.
- For Macintosh, the icon will be displayed on the desktop.
- The icon that appears will differ depending on your computer.



Canon (D:)



START.pdf

### 3 Double-click the “START” file.

- The screen shown in step 4 will appear.
- The icon that appears will differ depending on your computer.

### 4 Click on the name of the instruction manual you want to view.

- Click on the name of the instruction manual under the desired language.
- ▶ The Instruction Manual in the desired language will be displayed.

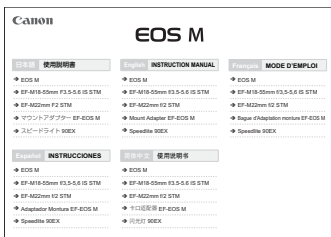

Camera Instruction Manual



- You can copy and save the PDF files to your personal computer.
- The Camera Instruction Manual PDF incorporates page links so you can quickly go to the desired page. On the Contents or Index page, just click on the page number to jump to that page.
- For more information about how to use Adobe Reader, see the Adobe Reader's Help menu.

# About the Software

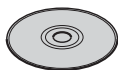

## EOS DIGITAL Solution Disk

This disk contains various software applications for EOS DIGITAL cameras.

### EOS Utility

With the camera connected to a personal computer, EOS Utility enables you to transfer still photos and movies shot with the camera to the computer. You can also use EOS Utility to set various camera settings. Also, you can copy background music tracks, such as EOS Sample Music\*, to the card.

\* Five original background music tracks are provided by Canon. Use EOS Utility to copy the background music tracks to the card, and you can play the background music during playback of video snapshot albums, movies, and slide shows with the camera.

### Digital Photo Professional

This software is recommended for users who mainly shoot RAW images. You can view, edit, process, and print RAW images at high speed. You can also edit JPEG images while retaining the original images.

### ImageBrowser EX

This software is recommended for users who mainly shoot JPEG images. You can easily view and play photos, movies, and video snapshot albums and also print JPEG images. Add-on features such as EOS Video Snapshot Task (→  PDF) can also be downloaded from the Internet.



Note that the software ZoomBrowser EX/ImageBrowser provided with previous cameras does not support still photos and movie files shot with this camera (it is not compatible). Use ImageBrowser EX provided with this camera.

### Picture Style Editor

You can edit Picture Styles and create and save original Picture Style files. This software is aimed at advanced users who are experienced in processing images.

# Installing the Software

- Do not connect the camera to your computer before you install the software. Otherwise, the software will not be installed properly.
- Even if your personal computer already has ImageBrowser EX installed, install ImageBrowser EX included on the CD-ROM that came with your new camera. It is the latest version with features optimized for your camera. You can also use the auto update feature to add the latest functions.
- Even if a previous version of the software is installed or if you have different software, install the software by following the steps below. (The newer version will overwrite the previous version.)

## 1 Insert EOS DIGITAL Solution Disk (CD-ROM).

- For Macintosh, double-click to open the CD-ROM icon displayed on the desktop, then double-click on **[Canon EOS Digital Installer]**.

## 2 Click **[Easy Installation]** and follow the on-screen instructions to install.

- For Macintosh, click **[Install]**.
- If install screen for “Microsoft Silverlight” is displayed during installation, install “Microsoft Silverlight”.



## 3 Click **[Restart]** and remove the CD-ROM after the computer restarts.

- When the computer has restarted, the installation is complete.

# Software Instruction Manual

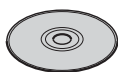

Contains the Software Instruction Manuals.

## Copying and Viewing the Instruction Manual PDFs

- 1 Insert the [Software INSTRUCTION MANUAL] CD-ROM into your computer.
- 2 Double-click the CD-ROM icon.
  - For Windows, the icon is displayed in [(My) Computer].
  - For Macintosh, the icon is displayed on the desktop.
- 3 Copy the [English] folder to your computer.
  - Instruction Manual PDFs with the names below are copied.

	Windows	Macintosh
EOS Utility	EUx.xW_E_xx	EUx.xM_E_xx
Digital Photo Professional	DPPx.xW_E_xx	DPPx.xM_E_xx
ImageBrowser EX	IBXx.x_E_xx	
Picture Style Editor	PSEx.xW_E_xx	PSEx.xM_E_xx

- 4 Double-click the copied PDF file.
  - Adobe Reader (most recent version recommended) must be installed on your computer.
  - Adobe Reader can be downloaded free from the Internet.

# Software System Requirements

For the latest compatibility information (including new OS versions), refer to your local Canon Web site.

## EOS Utility

### Windows

<b>OS</b>	Windows 7* <sup>1</sup> Windows Vista* <sup>2</sup> Windows XP Professional/Home Edition* <sup>3</sup>
<b>Computer</b>	PC with one of the above OS preinstalled and a USB port as a standard feature (Upgraded machines not supported) * .NET Framework 3.0 or later is required.* <sup>4</sup>
<b>CPU</b>	1.3GHz Pentium or higher
<b>RAM</b>	Minimum 1GB* <sup>5</sup>
<b>Interface</b>	Hi-Speed USB
<b>Display</b>	Screen resolution: 1024 x 768 pixels or more Color quality: Medium (16 bit) or more

\*1 Compatible with 32-bit/64-bit systems for all versions except Starter Edition

\*2 Compatible with 32-bit/64-bit systems for Service Pack 1 and Service Pack 2 except Starter Edition

\*3 Compatible with Service Pack 3

\*4 .NET Framework is Microsoft software. It is installed together with EU.

\*5 For Windows 7 64-bit systems, minimum 2GB

### Macintosh

<b>OS</b>	Mac OS X 10.6.8, 10.7
<b>Computer</b>	Macintosh with one of the above OS installed and a USB port as a standard feature
<b>CPU</b>	Intel processor
<b>RAM</b>	Minimum 1GB
<b>Interface</b>	Hi-Speed USB
<b>Display</b>	Resolution: 1024 x 768 or more Colors: Thousands or more



## Digital Photo Professional

### Windows

<b>OS</b>	Windows 7* <sup>1</sup> Windows Vista* <sup>2</sup> Windows XP Professional/Home Edition* <sup>3</sup>
<b>Computer</b>	PC with one of the above OS preinstalled * Upgraded machines not supported
<b>CPU</b>	1.3GHz Pentium or higher* <sup>4</sup>
<b>RAM</b>	Minimum 1GB* <sup>5</sup>
<b>Display</b>	Screen resolution: 1024 x 768 pixels or more Color quality: Medium (16 bit) or more

\*1 Compatible with 32-bit/64-bit systems for all versions except Starter Edition

\*2 Compatible with 32-bit/64-bit systems for Service Pack 1 and Service Pack 2 except Starter Edition

\*3 Compatible with Service Pack 3

\*4 Core2 Duo or higher is recommended

\*5 For Windows 7 64-bit systems, minimum 2GB

### Macintosh

<b>OS</b>	Mac OS X 10.6, 10.7
<b>Computer</b>	Macintosh with one of the above OS installed
<b>CPU</b>	Intel processor*
<b>RAM</b>	Minimum 1GB
<b>Display</b>	Resolution: 1024 x 768 or more Colors: Thousands or more

\* Core2 Duo or higher is recommended.

- This software program is not compatible with UFS (UNIX File System) formatted disks.

## ImageBrowser EX/CameraWindow

### Windows

<b>Operating System</b>	Windows 7 SP1 Windows Vista SP2 Windows XP SP3
<b>Computer</b>	Computer running one of the above operating systems (preinstalled), with an included USB port An Internet connection is required to use the auto update function.
<b>CPU (Still Images)</b>	1.6 GHz or higher
<b>CPU (Movies)</b>	HD (720p), SD: Core 2 Duo 1.66 GHz or higher Full HD (1080p): Core 2 Duo 2.6 GHz or higher ALL-I, IPB: Core 2 Duo 3.0 GHz or higher
<b>RAM (Still Images)</b>	Windows 7 (64-bit): 2 GB or more Windows 7 (32-bit): 1 GB or more Windows Vista (64-bit, 32-bit): 1 GB or more Windows XP: 512 MB or more
<b>RAM (Movies)</b>	HD (720p), SD: 1 GB or more Full HD (1080p): 2 GB or more
<b>Interface</b>	USB
<b>Free Hard Disk Space</b>	440 MB or more*
<b>Display</b>	1,024 x 768 resolution or higher

\* Silverlight 5.1 (100MB maximum) or higher must be installed. Additionally, in Windows XP, Microsoft .NET Framework 3.0 or later (max. 500 MB) must be installed. Installation may take some time, depending on computer performance.

### Macintosh

<b>Operating System</b>	Mac OS X 10.6, 10.7
<b>Computer</b>	Computer running one of the above operating systems (preinstalled), with an included USB port An Internet connection is required to use the auto update function.
<b>CPU (Still Images)</b>	Core 2 Duo or higher (for v10.7) Core Duo 1.83 GHz or higher (for v10.6)
<b>CPU (Movies)</b>	HD (720p), SD: Core Duo 1.83 GHz or higher Full HD (1080p): Core 2 Duo 2.6 GHz or higher ALL-I, IPB: Core 2 Duo 3.0 GHz or higher
<b>RAM (Still Images)</b>	2 GB or more (v10.7), 1 GB or more (v10.6)
<b>RAM (Movies)</b>	HD (720p), SD: 2 GB or more (v10.7), 1 GB or more (v10.6) Full HD (1080p): 2 GB or more
<b>Interface</b>	USB
<b>Free Hard Disk Space</b>	550 MB or more*
<b>Display</b>	1,024 x 768 resolution or higher

\* Silverlight 5.1 (100MB maximum) or higher must be installed. For this reason, depending on the system used, the installation may take some time.

## Picture Style Editor

### Windows

<b>OS</b>	Windows 7* <sup>1</sup> Windows Vista* <sup>2</sup> Windows XP Professional/Home Edition* <sup>3</sup>
<b>Computer</b>	PC with one of the above OS preinstalled (Upgraded machines not supported) * .NET Framework 3.0 or later is required.* <sup>4</sup>
<b>CPU</b>	1.3GHz Pentium or higher* <sup>5</sup>
<b>RAM</b>	Minimum 1GB* <sup>6</sup>
<b>Display</b>	Screen resolution: 1024 x 768 pixels or more Color quality: Medium (16 bit) or more

\*1 Compatible with 32-bit/64-bit systems for all versions except Starter Edition

\*2 Compatible with 32-bit/64-bit systems for Service Pack 1 or Service Pack 2 for all versions except Starter Edition

\*3 Compatible with Service Pack 3

\*4 .NET Framework is Microsoft software. It is installed together with PSE.

\*5 Core2 Duo or higher is recommended

\*6 For Windows 7 64-bit systems, minimum 2GB

### Macintosh

<b>OS</b>	Mac OS X 10.6 to 10.7
<b>Computer</b>	Macintosh with one of the above OS installed
<b>CPU</b>	Intel processor*
<b>RAM</b>	Minimum 1GB
<b>Display</b>	Resolution: 1024 x 768 or more Colors: Thousands or more

\* Core 2 Duo or higher recommended.

- This software program is not compatible with UFS (UNIX File System) formatted disks.

## Safety Warnings

Follow these safeguards and use the equipment properly to prevent injury, death, and material damage.

### Preventing Serious Injury or Death

- To prevent fire, excessive heat, chemical leakage, and explosions, follow the safeguards below:
  - Do not use any batteries, power sources, and accessories not specified in this booklet. Do not use any home-made or modified batteries.
  - Do not short-circuit, disassemble, or modify the battery pack or back-up battery. Do not apply heat or apply solder to the battery pack or back-up battery. Do not expose the battery pack or back-up battery to fire or water. And do not subject the battery pack or back-up battery to strong physical shock.
  - Do not install the battery pack or back-up battery in reversed polarity (+ -). Do not mix new and old or different types of batteries.
  - Do not recharge the battery pack outside the allowable ambient temperature range of 0°C - 40°C (32°F - 104°F). Also, do not exceed the recharging time.
  - Do not insert any foreign metallic objects into the electrical contacts of the camera, accessories, connecting cables, etc.
- Keep the back-up battery away from children. If a child swallows the battery, consult a physician immediately. (Battery chemicals may harm the stomach and intestines.)
- When disposing of a battery pack or back-up battery, insulate the electrical contacts with tape to prevent contact with other metallic objects or batteries. This is to prevent fire or an explosion.
- If excessive heat, smoke, or fumes are emitted during battery pack recharging, immediately unplug the battery charger from the power outlet to stop the recharging and prevent a fire.
- If the battery pack or back-up battery leaks, changes color, deforms, or emits smoke or fumes, remove it immediately. Be careful not to get burned in the process.
- Prevent any battery leakage from contacting your eyes, skin, and clothing. It can cause blindness or skin problems. If the battery leakage contacts your eyes, skin, or clothing, flush the affected area with lots of clean water without rubbing it. See a physician immediately.
- During the recharging, keep the equipment away from the reach of children. The cord can accidentally choke the child or give an electrical shock.
- Do not leave any cords near a heat source. It can deform the cord or melt the insulation and cause a fire or electrical shock.
- Do not fire the flash at someone driving a car. It may cause an accident.
- Do not fire the flash near a person's eyes. It may impair the person's vision. When using flash to photograph an infant, keep at least 1 meter away.
- Before storing the camera or accessory when not in use, remove the battery pack and disconnect the power plug. This is to prevent electrical shock, heat generation, and fire.
- Do not use the equipment where there is flammable gas. This is to prevent an explosion or fire.
- If you drop the equipment and the casing breaks open to expose the internal parts, do not touch the internal parts due to the possibility of electrical shock.

- Do not disassemble or modify the equipment. High-voltage internal parts can cause electrical shock.
- Do not look at the sun or an extremely bright light source through the camera or lens. Doing so may damage your vision.
- Keep the camera from the reach of small children. The neck strap can accidentally choke the child.
- Do not store the equipment in dusty or humid places. This is to prevent fire and electrical shock.
- Before using the camera inside an airplane or hospital, check if it is allowed. Electromagnetic waves emitted by the camera may interfere with the plane's instruments or the hospital's medical equipment.
- To prevent fire and electrical shock, follow the safeguards below:
  - Always insert the power plug all the way in.
  - Do not handle a power plug with wet hands.
  - When unplugging a power plug, grasp and pull the plug instead of the cord.
  - Do not scratch, cut, or excessively bend the cord or put a heavy object on the cord. Also do not twist or tie the cords.
  - Do not connect too many power plugs to the same power outlet.
  - Do not use a cord whose insulation has been damaged.
- Occasionally unplug the power plug and use a dry cloth to clean off the dust around the power outlet. If the surrounding is dusty, humid, or oily, the dust on the power outlet may become moist and short-circuit the outlet to cause a fire.

## Preventing Injury or Equipment Damage

- Do not leave equipment inside a car under the hot sun or near a heat source. The equipment may become hot and cause skin burns.
- Do not carry the camera around while it is attached to a tripod. Doing so may cause injury. Also make sure the tripod is sturdy enough to support the camera and lens.
- Do not leave a lens or lens-attached camera under the sun without the lens cap attached. Otherwise, the lens may concentrate the sun's rays and cause a fire.
- Do not cover or wrap the battery-recharging apparatus with a cloth. Doing so may trap heat within and cause the casing to deform or catch fire.
- If you drop the camera in water or if water or metal fragments enter inside the camera, promptly remove the battery pack and back-up battery. This is to prevent fire and electrical shock.
- Do not use or leave the battery pack or back-up battery in a hot environment. Doing so may cause battery leakage or a shorter battery life. The battery pack or back-up battery can also become hot and cause skin burns.
- Do not use paint thinner, benzene, or other organic solvents to clean the equipment. Doing so may cause fire or a health hazard.

**If the product does not work properly or requires repair, contact your dealer or your nearest Canon Service Center.**

## Digital Camera Model DS126391 Systems

This device complies with Part 15 of the FCC Rules. Operation is subject to the following two conditions: (1) This device may not cause harmful interference, and (2) this device must accept any interference received, including interference that may cause undesired operation.

Note: This equipment has been tested and found to comply with the limits for class B digital devices, pursuant to Part 15 of the FCC Rules. These limits are designed to provide reasonable protection against harmful interference in a residential installation. This equipment generates, uses and can radiate radio frequency energy and, if not installed and used in accordance with the instructions, may cause harmful interference to radio communications. However, there is no guarantee that interference will not occur in a particular installation. If this equipment does cause harmful interference to radio or television reception, which can be determined by turning the equipment off and on, the user is encouraged to try to correct the interference by one or more of the following measures:

- Reorient or relocate the receiving antenna.
- Increase the separation between the equipment and receiver.
- Connect the equipment into an outlet on a circuit different from that to which the receiver is connected.
- Consult the dealer or an experienced radio/TV technician for help.

The cable with the ferrite core provided with the digital camera must be used with this equipment in order to comply with Class B limits in Subpart B of Part 15 of the FCC rules.

Do not make any changes or modifications to the equipment unless otherwise specified in the manual. If such changes or modifications should be made, you could be required to stop operation of the equipment.

Canon U.S.A. Inc.  
One Canon Plaza, Lake Success, NY 11042, U.S.A.  
Tel No. (516)328-5600

This Class B digital apparatus complies with Canadian ICES-003.



When connecting to and using a household power outlet, use only AC Adapter Kit ACK-E12 (rated input: 100-240 V AC 50/60 Hz, rated output: 7.4 V DC). Using anything else can cause fire, overheating, or electrical shock.

## IMPORTANT SAFETY INSTRUCTIONS

1. **SAVE THESE INSTRUCTIONS** — This manual contains important safety and operating instructions for Battery Charger LC-E12 & LC-E12E.
2. Before using the charger, read all instructions and cautionary remarks on (1) the charger, (2) the battery pack, and (3) the product using the battery pack.
3. **CAUTION** — To reduce risk of injury, charge only the Battery Pack LP-E12. Other types of batteries may burst, causing personal injury and other damage.
4. Do not expose the charger to rain or snow.
5. Use of an attachment not recommended or sold by Canon may result in fire, electric shock, or personal injury.
6. To reduce risk of damage to electric plug and cord, pull by plug rather than by cord when disconnecting charger.
7. Make sure cord is located so that it will not be stepped on, tripped over, or otherwise subjected to damage or stress.
8. Do not operate the charger with damaged cord or plug - replace them immediately.
9. Do not operate the charger if it has received a sharp blow, been dropped, or otherwise damaged in any way; take it to a qualified serviceman.
10. Do not disassemble the charger; take it to a qualified serviceman when service or repair is required. Incorrect reassembly may result in a risk of electric shock or fire.
11. To reduce risk of electric shock, unplug charger from outlet before attempting any maintenance or cleaning.

## MAINTENANCE INSTRUCTION

Unless otherwise stated in this manual, there are no user serviceable parts inside. Refer servicing to qualified serviceman.



USA and Canada only:

The Lithium ion/polymer battery that powers the product is recyclable. Please call 1-800-8-BATTERY for information on how to recycle this battery.

For CA, USA only

Included lithium battery contains Perchlorate Material – special handling may apply. See [www.dtsc.ca.gov/hazardouswaste/perchlorate/](http://www.dtsc.ca.gov/hazardouswaste/perchlorate/) for details.

## CAUTION

RISK OF EXPLOSION IF BATTERY IS REPLACED BY AN INCORRECT TYPE.  
DISPOSE OF USED BATTERIES ACCORDING TO LOCAL REGULATION.

# Canon

**CANON INC.** 30-2, Shimomaruko 3-chome, Ohta-ku, Tokyo 146-8501, Japan

**U.S.A.** ————— **CANON U.S.A. INC.**

One Canon Plaza, Lake Success, NY 11042-1198, U.S.A.  
For all inquires concerning this product, call toll free in the U.S.  
1-800-OK-CANON

**CANADA** ————— **CANON CANADA INC. HEADQUARTERS**

6390 Dixie Road, Mississauga, Ontario L5T 1P7, Canada

**CANON CANADA INC. MONTREAL BRANCH**

5990, Côte-de-Liesse, Montréal Québec H4T 1V7, Canada

**CANON CANADA INC. CALGARY OFFICE**

2828, 16th Street, N.E. Calgary, Alberta T2E 7K7, Canada

For all inquiries concerning this product, call toll free in Canada  
1-800-OK-CANON

**EUROPE,** ————— **CANON EUROPA N.V.**

**AFRICA &** Bovenkerkerweg 59-61, 1185 XB Amstelveen, The Netherlands

**MIDDLE EAST** **CANON FRANCE S.A.S.**

17, Quai du Président Paul Doumer, 92414 Courbevoie Cedex, France

**CANON UK LTD.**

Woodhatch Reigate, Surrey RH2 8BF, United Kingdom

**CANON DEUTSCHLAND GmbH**

Europark Fichtenhain A10, 47807 Krefeld, Germany

**CANON ITALIA S.p.A.**

Via Milano 8, 20097 San Donato Milanese, (MI), Italy

**CANON Schweiz A.G.**

Industriestrasse 12, 8305 Dietlikon, Switzerland

**Canon GmbH**

Zetschegasse 11, A-1230 Vienna, Austria

**CANON España, S.A.**

Av. De Europa, 6 Alcobendas 28108 Madrid, Spain

**CANON Portugal S.A.**

Rua Alfredo da Silva, 14 Alfragide 2610-016 Amadora, Portugal

**CENTRAL &** ————— **CANON LATIN AMERICA, INC.**

**SOUTH AMERICA** 703 Waterford Way, Suite 400 Miami, FL 33126, U.S.A.

**ASIA** ————— **CANON (China) Co., LTD.**

15F Jinbao Building No.89 Jinbao Street, Dongcheng District, Beijing 100005, China

**CANON HONGKONG CO., LTD.**

19/F, The Metropolis Tower, 10 Metropolis Drive, Hung Hom, Kowloon, Hong Kong

**CANON SINGAPORE PTE. LTD.**

1 HarbourFront Avenue, #04-01 Keppel Bay Tower, Singapore 098632

**CANON KOREA CONSUMER IMAGING INC.**

Canon BS Tower 5F, #168-12 Samseong-dong, Gangnam-gu, Seoul, Korea

**OCEANIA** ————— **CANON AUSTRALIA PTY. LTD.**

1 Thomas Holt Drive, North Ryde, Sydney N.S.W. 2113, Australia

**CANON NEW ZEALAND LTD.**

Akoranga Business Park, Akoranga Drive, Northcote, Auckland, New Zealand

**JAPAN** ————— **CANON MARKETING JAPAN INC.**

16-6, Kohnan 2-chome, Minato-ku, Tokyo 108-8011, Japan

The lenses and accessories mentioned in this Instruction Manual are current as of July 2012. For information on the camera's compatibility with any lenses and accessories introduced after this date, contact any Canon Service Center.