



KRAMER ELECTRONICS LTD.

USER MANUAL

MODEL:

VM-10xl

Video Audio Distribution
Amplifier

P/N: 2900-001042 Rev 4



VM-10xl Quick Start Guide

This guide helps you install and use your product for the first time. For more detailed information, go to http://www.kramerelectronics.com/support/product_downloads.asp to download the latest manual or scan the QR code on the left.

Step 1: Check what's in the box

- VM-10xl Video Audio Distribution Amplifier
- 4 Rubber feet
- 1 Power cord
- 1 Quick Start sheet

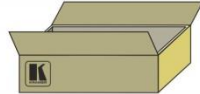

Save the original box and packaging materials in case you need to return your VM-10xl for service.

Step 2: Install the VM-10xl

Mount the VM-10xl in a rack or attach the rubber feet and place on a table.

Step 3: Connect the inputs and outputs

Always switch off the power on each device before connecting it to your VM-10xl.

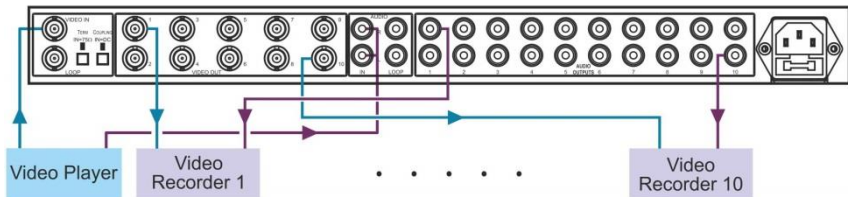

Always use Kramer high-performance cables for connecting AV equipment to the VM-10xl.

Step 4: Connect the power

Connect the power cord to the VM-10xl and plug it into the mains electricity.



Step 5: Operate the VM-10xl

TERM IN=75Ω COUPLING IN=DC

Set the termination button
If required, set the AC or DC coupling

Adjust the left and right audio gain

Adjust the Video gain level and equalization

Select balanced mono or unbalanced stereo audio signals

Set to ENABLE to adjust the audio gain

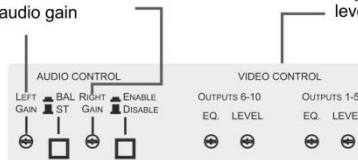

Contents

1	Introduction	1
2	Getting Started	2
2.1	Achieving the Best Performance	2
2.2	Safety Instructions	3
2.3	Recycling Kramer Products	3
3	Overview	4
3.1	Defining the VM-10xl Video Audio Distribution Amplifier	4
4	Installing in a Rack	7
5	Connecting the VM-10xl	8
5.1	Increasing the Outputs	9
6	Technical Specifications	12

Figures

Figure 1:	VM-10xl Video Audio Distribution Amplifier Front Panel	5
Figure 2:	VM-10xl Video Audio Distribution Amplifier Rear Panel	6
Figure 3:	Connecting the VM-10xl Video Audio Distribution Amplifier	9
Figure 4:	Increasing the Outputs: Arranging a 1:30 Video Audio DA	11

1 Introduction

Welcome to Kramer Electronics! Since 1981, Kramer Electronics has been providing a world of unique, creative, and affordable solutions to the vast range of problems that confront video, audio, presentation, and broadcasting professionals on a daily basis. In recent years, we have redesigned and upgraded most of our line, making the best even better!

Our 1,000-plus different models now appear in 11 groups that are clearly defined by function: GROUP 1: Distribution Amplifiers; GROUP 2: Switchers and Routers; GROUP 3: Control Systems; GROUP 4: Format/Standards Converters; GROUP 5: Range Extenders and Repeaters; GROUP 6: Specialty AV Products; GROUP 7: Scan Converters and Scalers; GROUP 8: Cables and Connectors; GROUP 9: Room Connectivity; GROUP 10: Accessories and Rack Adapters and GROUP 11: Sierra Products.

Congratulations on purchasing your Kramer **VM-10xl** *Video Audio Distribution Amplifier*, which is ideal for the following typical applications:

- Audio video duplication studios
- Rental/staging, CCTV, and home theater use

2 Getting Started

We recommend that you:

- Unpack the equipment carefully and save the original box and packaging materials for possible future shipment
- Review the contents of this user manual



Go to http://www.kramerelectronics.com/support/product_downloads.asp to check for up-to-date user manuals, application programs, and to check if firmware upgrades are available (where appropriate).

2.1 Achieving the Best Performance

To achieve the best performance:

- Use only good quality connection cables (we recommend Kramer high-performance, high-resolution cables) to avoid interference, deterioration in signal quality due to poor matching, and elevated noise levels (often associated with low quality cables)
- Do not secure the cables in tight bundles or roll the slack into tight coils
- Avoid interference from neighboring electrical appliances that may adversely influence signal quality
- Position your Kramer **VM-10xl** away from moisture, excessive sunlight and dust



This equipment is to be used only inside a building. It may only be connected to other equipment that is installed inside a building.

2.2 Safety Instructions



Caution: There are no operator serviceable parts inside the unit

Warning: Use only the power cord that is supplied with the unit

Warning: Do not open the unit. High voltages can cause electrical shock! Servicing by qualified personnel only

Warning: Disconnect the power and unplug the unit from the wall before installing

2.3 Recycling Kramer Products

The Waste Electrical and Electronic Equipment (WEEE) Directive 2002/96/EC aims to reduce the amount of WEEE sent for disposal to landfill or incineration by requiring it to be collected and recycled. To comply with the WEEE Directive, Kramer Electronics has made arrangements with the European Advanced Recycling Network (EARN) and will cover any costs of treatment, recycling and recovery of waste Kramer Electronics branded equipment on arrival at the EARN facility. For details of Kramer's recycling arrangements in your particular country go to our recycling pages at <http://www.kramerelectronics.com/support/recycling/>.

3 Overview

The **VM-10xl** is a high-quality 1:10 video audio distribution amplifier using BNC connectors for composite video, and RCA connectors for unbalanced stereo audio signals. The **VM-10xl** accepts a composite video input and distributes the signal to 10 identical outputs.

In particular, the **VM-10xl**:

- Includes looping connectors for connecting to a local monitor, other acceptor, or for forming larger systems

For example, you can connect 3 VM 10xl units to make a 1:30 video audio distribution amplifier. See [Section 5.1](#) for details.

- Has a video bandwidth of 360MHz, ensuring transparent performance with typical video and audio sources
- Can function as unbalanced stereo audio or balanced mono audio (selected via an audio control button)

Recommended for low signal transmission over long distances or in audio broadcasting studios for high quality signal recreation.

- Can output video signals that are DC or AC coupled for maximum flexibility (selected via a coupling button)
- Has front panel video trimmer controls for output level and cable equalization (EQ.), as well as audio trimmer controls for left and right gain, with an enable / disable control button

The video outputs are arranged in two blocks of 5 outputs (outputs 1 to 5, and outputs 6 to 10). Each block can be separately trimmed for output level and cable equalization (EQ.) thus achieving different compensations for different cable lengths.

3.1 Defining the VM-10xl Video Audio Distribution Amplifier

This section defines the **VM-10xl**.

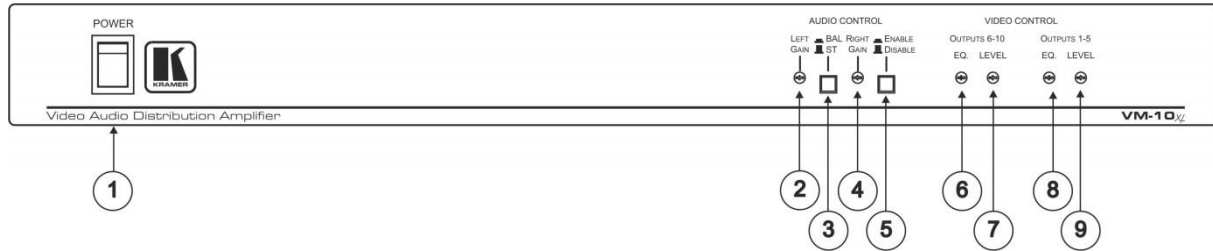

Figure 1: VM-10xl Video Audio Distribution Amplifier Front Panel

#	Feature	Function
1	POWER Switch	Illuminated switch supplying power to the unit
2	AUDIO CONTROL	LEFT GAIN Trimmer Adjusts the audio signal level for the left channel <i>Insert a screwdriver into the hole and carefully rotate it, to trim the level</i>
3		BAL/ST Button Pushing in selects balanced mono audio operation, releasing selects unbalanced stereo audio operation
4		RIGHT GAIN Trimmer Adjusts the audio signal level for the right channel
5		Enable/Disable Button Pushing in enables audio gain trimmer control, releasing bypasses it disabling audio gain trimmer control
6	VIDEO CONTROL	EQ. Trimmer Adjusts the video EQ. (equalization) compensation of outputs 6 to 10
7		LEVEL Trimmer Adjusts the video signal level of outputs 6 to 10
8		EQ. Trimmer Adjusts the video EQ. (equalization) compensation of outputs 1 to 5
9		LEVEL Trimmer Adjusts the video signal level of outputs 1 to 5

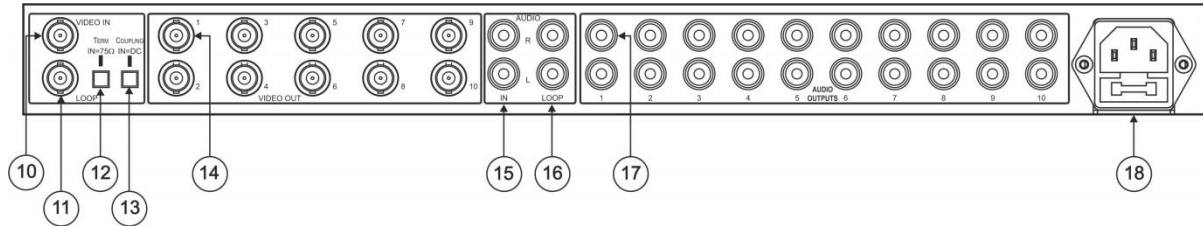

Figure 2: VM-10xl Video Audio Distribution Amplifier Rear Panel

#	Feature	Function
10	VIDEO IN BNC Connector	Connects to the video source
11	LOOP BNC Connector	For looping to increase output availability
12	TERM Button	Pushing in selects 75Ω, releasing selects Hi-Z For looping select Hi-Z
13	COUPLING Button	Pushing in selects DC coupling, releasing selects AC coupling (removing the DC offset of the input signal) Achieving the best linearity and signal fidelity
14	VIDEO OUT BNC Connectors	Connect to the video acceptors (from 1 to 10)
15	AUDIO IN RCA Connectors	Connects to the stereo audio source (R and L)
16	AUDIO LOOP RCA Connectors	For looping to increase audio output availability (R and L)
17	AUDIO OUTPUTS RCA Connectors	Connect to the stereo audio acceptors R and L, from 1 to 10)
18	Power Connector with Fuse	AC connector enabling power supply to the unit

4 Installing in a Rack

This section provides instructions for rack mounting the unit.

Before installing in a rack, be sure that the environment is within the recommended range:

OPERATING TEMPERATURE:	0° to +40°C (32° to 104°F)
STORAGE TEMPERATURE:	-40° to +70°C (-40° to 158°F)
HUMIDITY:	10% to 90%, RHL non-condensing



CAUTION!

When installing on a 19" rack, avoid hazards by taking care that:

1. It is located within the recommended environmental conditions, as the operating ambient temperature of a closed or multi unit rack assembly may exceed the room ambient temperature.
2. Once rack mounted, enough air will still flow around the machine.
3. The machine is placed straight in the correct horizontal position.
4. You do not overload the circuit(s). When connecting the machine to the supply circuit, overloading the circuits might have a detrimental effect on overcurrent protection and supply wiring. Refer to the appropriate nameplate ratings for information. For example, for fuse replacement, see the value printed on the product label.
5. The machine is earthed (grounded) in a reliable way and is connected only to an electricity socket with grounding. Pay particular attention to situations where electricity is supplied indirectly (when the power cord is not plugged directly into the socket in the wall), for example, when using an extension cable or a power strip, and that you use only the power cord that is supplied with the machine.

To rack-mount a machine:

1. Attach both ear brackets to the machine. To do so, remove the screws from each side of the machine (3 on each side), and replace those screws through the ear brackets.

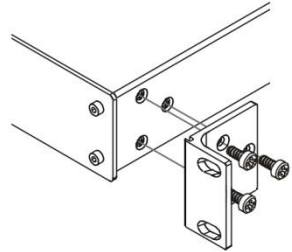

2. Place the ears of the machine against the rack rails, and insert the proper screws (not provided) through each of the four holes in the rack ears.

Note:

- In some models, the front panel may feature built-in rack ears
- Detachable rack ears can be removed for desktop use
- Always mount the machine in the rack before you attach any cables or connect the machine to the power
- If you are using a Kramer rack adapter kit (for a machine that is not 19"), see the Rack Adapters user manual for installation instructions available from our Web site

5 Connecting the VM-10xl



Always switch off the power to each device before connecting it to your **VM-10xl**. After connecting your **VM-10xl**, connect its power and then switch on the power to each device.

To connect the **VM-10xl** as illustrated in the example in [Figure 3](#):

1. Connect a video audio source (for example, a composite video player) to the VIDEO IN BNC connector and to the left and right AUDIO IN RCA connectors.
2. Connect the 10 VIDEO OUT BNC connectors and the 10 left and right AUDIO OUTPUT RCA connectors to the video audio acceptors 1 to 10 (for example, video recorders).
Not all outputs need to be connected.
3. Connect the power cord to the mains electricity.
4. Push in the Term button to terminate the line to 75Ω.
5. Release the BAL/ST button to select unbalanced stereo audio operation.
6. If required, adjust the video trimmer controls for output signal level and/or cable compensation equalization level.
Insert a screwdriver into the hole and carefully rotate it, to trim the level.
The video outputs are arranged in two blocks of 5 outputs (outputs 1 to 5, and outputs 6 to 10). Each block can be separately trimmed for output level and cable equalization (EQ.) thus achieving different compensations for different cable lengths.
7. If audio control adjustment is required for left and/or right gain, push in Enable/Disable button, and then adjust the trimmer controls.

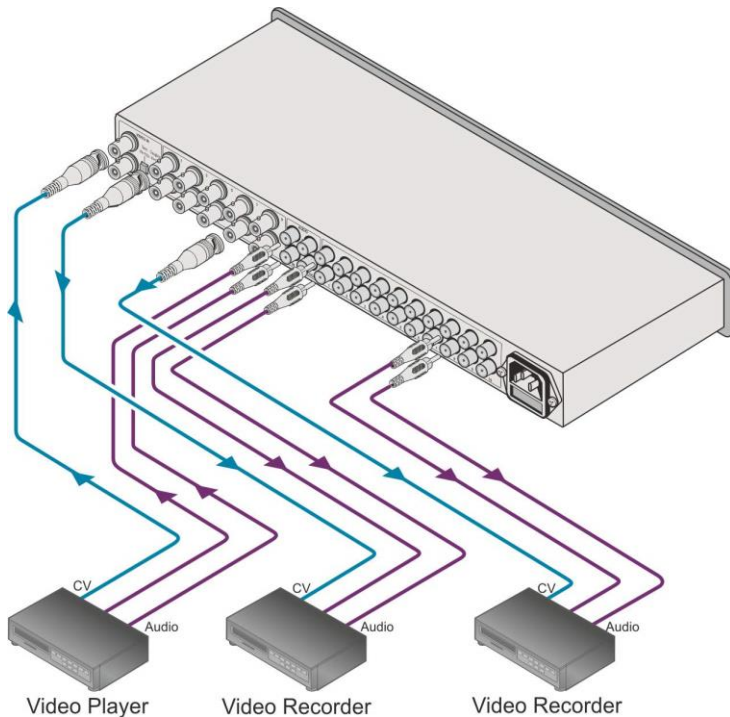

Figure 3: Connecting the VM-10xl Video Audio Distribution Amplifier

5.1 Increasing the Outputs

You can increase the number of outputs by interconnecting **VM-10xl** units. The example in [Figure 4](#) illustrates how to connect 3 units to increase the number of outputs from 10 to 30.

To form a 1:30 video and unbalanced stereo audio DA, do the following:

1. Connect a video audio source (for example, a composite VCR) to the VIDEO IN BNC connector and to the left and right AUDIO IN RCA connectors of the first **VM-10xl** unit.

2. Connect the video LOOP BNC connector of the:
 - First **VM-10xl** unit to the VIDEO IN BNC connector of the second **VM-10xl** unit
 - Second **VM-10xl** unit to the VIDEO IN BNC connector of the third **VM-10xl** unit
3. Connect the left and right AUDIO LOOP RCA connectors of the:
 - First **VM-10xl** unit to the left and right AUDIO IN RCA connectors of the second **VM-10xl** unit
 - Second **VM-10xl** unit to the left and right AUDIO IN RCA connectors of the third **VM-10xl** unit
4. Connect the 10 VIDEO OUT BNC connectors and the 10 left and right AUDIO OUTPUT RCA connectors of the:
 - First **VM-10xl** unit to the video audio acceptors 1 to 10 (for example, VCR units)
 - Second **VM-10xl** unit to the video audio acceptors 11 to 20
 - Third **VM-10xl** unit to the video audio acceptors 21 to 30
5. On the first and second **VM-10xl** units, release the Term button. On the third **VM-10xl** unit, push in the Term button to terminate the line to 75Ω.
6. On each **VM-10xl** unit:
 - Connect the power cord to the mains electricity
 - Release the BAL/ST buttons to select unbalanced stereo audio operation
 - Adjust the video trimmer controls for output signal level and/or cable compensation equalization level, if required
 - If audio control adjustment is required for left and/or right gain, push in the Enable/Disable buttons, and then adjust the trimmer controls

The video outputs are arranged in two blocks of 5 outputs (outputs 1 to 5, and outputs 6 to 10). Each block can be separately trimmed for output level and cable equalization (EQ.) thus achieving different compensations for different cable lengths

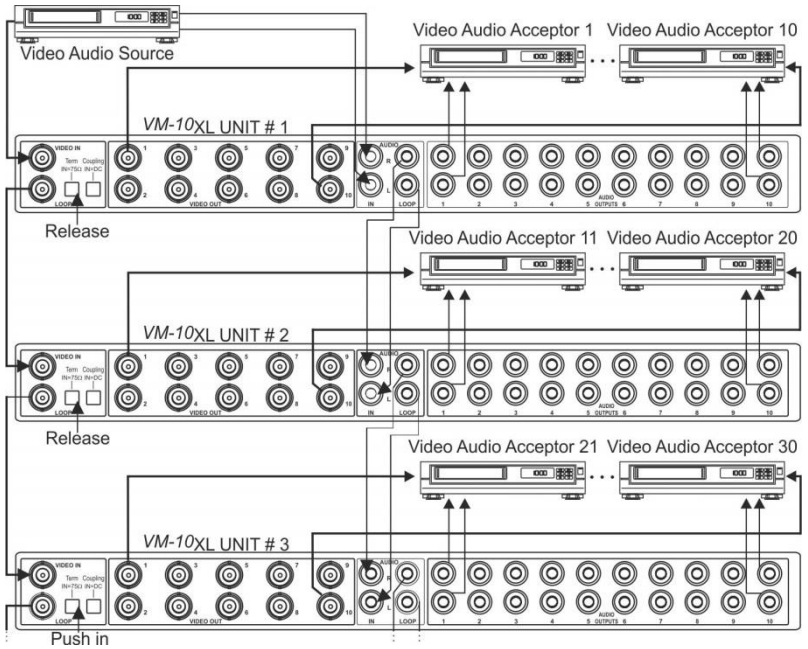

Figure 4: Increasing the Outputs: Arranging a 1:30 Video Audio DA

6 Technical Specifications

INPUTS:	1 composite video with loop, 1Vpp/75Ω with termination switch on BNC connectors 2 balanced stereo audio or mono with loops, on RCA connectors
OUTPUTS:	10 composite video, 1Vpp/75Ω on BNC connectors 10 balanced stereo audio or mono, on RCA connectors
MAX. OUTPUT LEVEL:	Video: 1.6Vpp, Audio: 26.5Vpp
BANDWIDTH (-3dB):	Video: 360MHz, Audio: >100kHz
DIFF. GAIN:	0.07%
DIFF. PHASE:	0.05 Deg.
K-FACTOR:	<0.05%
S/N RATIO:	Video: 77dB, Audio: 87dB
CONTROLS:	Front panel accessible trimmers for video level (-1.2dB to +6dB) and EQ. (0dB to +8.1dB), audio left and right control trimmers (0dB to +6dB), balanced/stereo selector switch and audio controls enable switch
COUPLING:	Video: DC/AC, Audio: AC
AUDIO THD + NOISE:	0.023%
AUDIO 2nd HARMONIC:	0.001%
POWER CONSUMPTION:	230V AC 50 / 60Hz (115V U.S.A.), 4.7VA
OPERATING TEMPERATURE:	0° to +40°C (32° to 104°F)
STORAGE TEMPERATURE:	-40° to +70°C (-40° to 158°F)
HUMIDITY:	10% to 90%, RHL non-condensing
DIMENSIONS:	19" x 7" x 1U (W, D, H)
WEIGHT:	2.1kg (4.7lbs) approx.
ACCESSORIES:	Power cord
Specifications are subject to change without notice at http://www.kramerelectronics.com	

LIMITED WARRANTY

The warranty obligations of Kramer Electronics for this product are limited to the terms set forth below.

What is Covered

This limited warranty covers defects in materials and workmanship in this product.

What is Not Covered

This limited warranty does not cover any damage, deterioration or malfunction resulting from any alteration, modification, improper or unreasonable use or maintenance, misuse, abuse, accident, neglect, exposure to excess moisture, fire, improper packing and shipping (such claims must be presented to the carrier), lightning, power surges, or other acts of nature. This limited warranty does not cover any damage, deterioration or malfunction resulting from the installation or removal of this product from any installation, any unauthorized tampering with this product, any repairs attempted by anyone unauthorized by Kramer Electronics to make such repairs, or any other cause which does not relate directly to a defect in materials and/or workmanship of this product. This limited warranty does not cover cartons, equipment enclosures, cables or accessories used in conjunction with this product.

Without limiting any other exclusion herein, Kramer Electronics does not warrant that the product covered hereby, including, without limitation, the technology and/or integrated circuit(s) included in the product, will not become obsolete or that such items are or will remain compatible with any other product or technology with which the product may be used.

How Long Does this Coverage Last

Seven years as of this printing; please check our Web site for the most current and accurate warranty information.

Who is Covered

Only the original purchaser of this product is covered under this limited warranty. This limited warranty is not transferable to subsequent purchasers or owners of this product.

What Kramer Electronics will do

Kramer Electronics will, at its sole option, provide one of the following three remedies to whatever extent it shall deem necessary to satisfy a proper claim under this limited warranty:

1. Elect to repair or facilitate the repair of any defective parts within a reasonable period of time, free of any charge for the necessary parts and labor to complete the repair and restore this product to its proper operating condition. Kramer Electronics will also pay the shipping costs necessary to return this product once the repair is complete.
2. Replace this product with a direct replacement or with a similar product deemed by Kramer Electronics to perform substantially the same function as the original product.
3. Issue a refund of the original purchase price less depreciation to be determined based on the age of the product at the time remedy is sought under this limited warranty.

What Kramer Electronics will not do Under This Limited Warranty

If this product is returned to Kramer Electronics or the authorized dealer from which it was purchased or any other party authorized to repair Kramer Electronics products, this product must be insured during shipment, with the insurance and shipping charges prepaid by you. If this product is returned uninsured, you assume all risks of loss or damage during shipment. Kramer Electronics will not be responsible for any costs related to the removal or re-installation of this product from or into any installation. Kramer Electronics will not be responsible for any costs related to any setting up this product, any adjustment of user controls or any programming required for a specific installation of this product.

How to Obtain a Remedy under this Limited Warranty

To obtain a remedy under this limited warranty, you must contact either the authorized Kramer Electronics reseller from whom you purchased this product or the Kramer Electronics office nearest you. For a list of authorized Kramer Electronics resellers and/or Kramer Electronics authorized service providers, please visit our web site at www.kramerelectronics.com or contact the Kramer Electronics office nearest you.

In order to pursue any remedy under this limited warranty, you must possess an original, dated receipt as proof of purchase from an authorized Kramer Electronics reseller. If this product is returned under this limited warranty, a return authorization number, obtained from Kramer Electronics, will be required. You may also be directed to an authorized reseller or a person authorized by Kramer Electronics to repair the product.

If it is decided that this product should be returned directly to Kramer Electronics, this product should be properly packed, preferably in the original carton, for shipping. Cartons not bearing a return authorization number will be refused.

Limitation on Liability

THE MAXIMUM LIABILITY OF KRAMER ELECTRONICS UNDER THIS LIMITED WARRANTY SHALL NOT EXCEED THE ACTUAL PURCHASE PRICE PAID FOR THE PRODUCT. TO THE MAXIMUM EXTENT PERMITTED BY LAW, KRAMER ELECTRONICS IS NOT RESPONSIBLE FOR DIRECT, SPECIAL, INCIDENTAL OR CONSEQUENTIAL DAMAGES RESULTING FROM ANY BREACH OF WARRANTY OR CONDITION, OR UNDER ANY OTHER LEGAL THEORY. Some countries, districts or states do not allow the exclusion or limitation of relief, special, incidental, consequential or indirect damages, or the limitation of liability to specified amounts, so the above limitations or exclusions may not apply to you.

Exclusive Remedy

TO THE MAXIMUM EXTENT PERMITTED BY LAW, THIS LIMITED WARRANTY AND THE REMEDIES SET FORTH ABOVE ARE EXCLUSIVE AND IN LIEU OF ALL OTHER WARRANTIES, REMEDIES AND CONDITIONS, WHETHER ORAL OR WRITTEN, EXPRESS OR IMPLIED. TO THE MAXIMUM EXTENT PERMITTED BY LAW, KRAMER ELECTRONICS SPECIFICALLY DISCLAIMS ANY AND ALL IMPLIED WARRANTIES, INCLUDING, WITHOUT LIMITATION, WARRANTIES OF MERCHANTABILITY AND FITNESS FOR A PARTICULAR PURPOSE. IF KRAMER ELECTRONICS CANNOT LAWFULLY DISCLAIM OR EXCLUDE IMPLIED WARRANTIES UNDER APPLICABLE LAW, THEN ALL IMPLIED WARRANTIES COVERING THIS PRODUCT, INCLUDING WARRANTIES OF MERCHANTABILITY AND FITNESS FOR A PARTICULAR PURPOSE, SHALL APPLY TO THIS PRODUCT AS PROVIDED UNDER APPLICABLE LAW.

IF ANY PRODUCT TO WHICH THIS LIMITED WARRANTY APPLIES IS A "CONSUMER PRODUCT" UNDER THE MAGNUSON-MOSS WARRANTY ACT (15 U.S.C.A. §2301, ET SEQ.) OR OTHER APPLICABLE LAW, THE FOREGOING DISCLAIMER OF IMPLIED WARRANTIES SHALL NOT APPLY TO YOU, AND ALL IMPLIED WARRANTIES ON THIS PRODUCT, INCLUDING WARRANTIES OF MERCHANTABILITY AND FITNESS FOR THE PARTICULAR PURPOSE, SHALL APPLY AS PROVIDED UNDER APPLICABLE LAW.

Other Conditions

This limited warranty gives you specific legal rights, and you may have other rights which vary from country to country or state to state.

This limited warranty is void if (i) the label bearing the serial number of this product has been removed or defaced, (ii) the product is not distributed by Kramer Electronics or (iii) this product is not purchased from an authorized Kramer Electronics reseller. If you are unsure whether a reseller is an authorized Kramer Electronics reseller, please visit our Web site at www.kramerelectronics.com or contact a Kramer Electronics office from the list at the end of this document.

Your rights under this limited warranty are not diminished if you do not complete and return the product registration form or complete and submit the online product registration form. Kramer Electronics thanks you for purchasing a Kramer Electronics product. We hope it will give you years of satisfaction.



For the latest information on our products and a list of Kramer distributors, visit our Web site where updates to this user manual may be found.

We welcome your questions, comments, and feedback.

Web site: www.kramerelectronics.com

E-mail: info@kramerel.com



SAFETY WARNING

Disconnect the unit from the power supply before opening and servicing



P/N: 2900-001042



Rev: 4