

SHARP[®]

PN-U553

PN-U473

PN-U423

LCD MONITOR

OPERATION MANUAL

HDMI

IMPORTANT:

To aid reporting in case of loss or theft, please record the product's model and serial numbers in the space provided. The numbers are located in the rear of the product.



Model No.:

Serial No.:

U.S.A. ONLY

IMPORTANT INFORMATION

WARNING: TO REDUCE THE RISK OF FIRE OR ELECTRIC SHOCK, DO NOT EXPOSE THIS PRODUCT TO RAIN OR MOISTURE.

	CAUTION RISK OF ELECTRIC SHOCK DO NOT OPEN	
CAUTION: TO REDUCE THE RISK OF ELECTRIC SHOCK, DO NOT REMOVE COVER. NO USER-SERVICEABLE PARTS INSIDE. REFER SERVICING TO QUALIFIED SERVICE PERSONNEL.		



The lightning flash with arrowhead symbol, within a triangle, is intended to alert the user to the presence of uninsulated “dangerous voltage” within the product’s enclosure that may be of sufficient magnitude to constitute a risk of electric shock to persons.



The exclamation point within a triangle is intended to alert the user to the presence of important operating and maintenance (servicing) instructions in the literature accompanying the product.

WARNING:

FCC Regulations state that any unauthorized changes or modifications to this equipment not expressly approved by the manufacturer could void the user’s authority to operate this equipment.

NOTE:

This equipment has been tested and found to comply with the limits for Class A digital device, pursuant to Part 15 of the FCC Rules. These limits are designed to provide reasonable protection against harmful interference when the equipment is operated in a commercial environment. This equipment generates, uses, and can radiate radio frequency energy and, if not installed and used in accordance with the instruction manual, may cause harmful interference to radio communications. Operation of this equipment in a residential area is likely to cause harmful interference in which case the user will be required to correct the interference at his own expense.

U.S.A. ONLY

DEAR SHARP CUSTOMER

Thank you for your purchase of a SHARP LCD product. To ensure safety and many years of trouble-free operation of your product, please read the Safety Precautions carefully before using this product.

SAFETY PRECAUTIONS

Electricity is used to perform many useful functions, but it can also cause personal injuries and property damage if improperly handled. This product has been engineered and manufactured with the highest priority on safety. However, improper use can result in electric shock and/or fire. In order to prevent potential danger, please observe the following instructions when installing, operating and cleaning the product. To ensure your safety and prolong the service life of your LCD product, please read the following precautions carefully before using the product.

1. Read instructions — All operating instructions must be read and understood before the product is operated.
2. Keep this manual in a safe place — These safety and operating instructions must be kept in a safe place for future reference.
3. Observe warnings — All warnings on the product and in the instructions must be observed closely.
4. Follow instructions — All operating instructions must be followed.
5. Cleaning — Unplug the power cord from the AC outlet before cleaning the product. Use a dry cloth to clean the product. Do not use liquid cleaners or aerosol cleaners.
6. Attachments — Do not use attachments not recommended by the manufacturer. Use of inadequate attachments can result in accidents.
7. Water and moisture — Do not use the product near water. Do not install the product in a place where water may splash onto it. Be careful of equipment which drains water such as an air-conditioner.
8. Ventilation — The vents and other openings in the cabinet are designed for ventilation. Do not cover or block these vents and openings since insufficient ventilation can cause overheating and/or shorten the life of the product. Do not place the product on a sofa, rug or other similar surface, since they can block ventilation openings. Do not place the product in an enclosed place such as a bookcase or rack, unless proper ventilation is provided or the manufacturer's instructions are followed.
9. Power cord protection — The power cords must be routed properly to prevent people from stepping on them or objects from resting on them.
10. The LCD panel used in this product is made of glass. Therefore, it can break when the product is dropped or applied with impact. Be careful not to be injured by broken glass pieces in case the LCD panel breaks.
11. Overloading — Do not overload AC outlets or extension cords. Overloading can cause fire or electric shock.
12. Entering of objects and liquids — Never insert an object into the product through vents or openings. High voltage flows in the product, and inserting an object can cause electric shock and/or short internal parts. For the same reason, do not spill water or liquid on the product.
13. Servicing — Do not attempt to service the product yourself. Removing covers can expose you to high voltage and other dangerous conditions. Request a qualified service person to perform servicing.
14. Repair — If any of the following conditions occurs, unplug the power cord from the AC outlet, and request a qualified service person to perform repairs.
 - a. When the power cord or plug is damaged.
 - b. When a liquid was spilled on the product or when objects have fallen into the product.
 - c. When the product has been exposed to rain or water.
 - d. When the product does not operate properly as described in the operating instructions.

Do not touch the controls other than those described in the operating instructions. Improper adjustment of controls not described in the instructions can cause damage, which often requires extensive adjustment work by a qualified technician.
 - e. When the product has been dropped or damaged.
 - f. When the product displays an abnormal condition. Any noticeable abnormality in the product indicates that the product needs servicing.
15. Replacement parts — In case the product needs replacement parts, make sure that the service person uses replacement parts specified by the manufacturer, or those with the same characteristics and performance as the original parts. Use of unauthorized parts can result in fire, electric shock and/or other danger.
16. Safety checks — Upon completion of service or repair work, request the service technician to perform safety checks to ensure that the product is in proper operating condition.
17. Wall mounting — When mounting the product on a wall, be sure to install the product according to the method recommended by the manufacturer.
18. Heat sources — Keep the product away from heat sources such as radiators, heaters, stoves and other heat-generating products (including amplifiers).

SAFETY PRECAUTIONS (Continued)

19. Batteries — Incorrect use of batteries may cause the batteries to burst or ignite. A leaky battery may corrode the equipment, dirty your hands or spoil your clothing. In order to avoid these problems, make sure to observe the precautions below:
 - Use the specified batteries only.
 - Install the batteries with due attention to the plus (+) and minus (-) sides of the batteries according to the instructions in the compartment.
 - Do not mix old and new batteries.
 - Do not mix batteries of different types. Voltage specifications of batteries of the same shape may vary.
 - Replace an exhausted battery with a new one promptly.
 - If you will not use the remote control for a long time, remove the batteries.
 - If leaked battery fluid gets on your skin or clothing, rinse immediately and thoroughly. If it gets into your eye, bathe your eye well rather than rubbing and seek medical treatment immediately. Leaked battery fluid that gets into your eye or your clothing may cause a skin irritation or damage your eye.
20. Usage of the monitor must not be accompanied by fatal risks or dangers that, could lead directly to death, personal injury, severe physical damage or other loss, including nuclear reaction control in nuclear facility, medical life support system, and missile launch control in a weapon system.
21. Do not stay in contact with the parts of the product that become hot for long periods of time. Doing so may result in low-temperature burns.

WARNING:

This is a Class A product. In a domestic environment this product may cause radio interference in which case the user may be required to take adequate measures.

To maintain compliance with EMC regulations, use shielded cables to connect to the following terminals: DVI-D input/output terminals, HDMI input terminal, D-sub input terminal, RS-232C input/output terminals, and DisplayPort input terminal.

If a monitor is not positioned in a sufficiently stable location, it can be potentially hazardous due to falling. Many injuries, particularly to children, can be avoided by taking simple precautions such as:

- Using fixing devices like wall mount brackets recommended by the manufacturer.
- Only using furniture that can safely support the monitor.
- Ensuring the monitor is not overhanging the edge of the supporting furniture.
- Not placing the monitor on tall furniture (for example, cupboards or bookcases) without anchoring both the furniture and the monitor to a suitable support.
- Not standing the monitors on cloth or other materials placed between the monitor and supporting furniture.
- Educating children about the dangers of climbing on furniture to reach the monitor or its controls.

Especially for child safety

- Don't allow children to climb on or play with the monitor.
- Don't place the monitor on furniture that can easily be used as steps, such as a chest of drawers.
- Remember that children can become excited while watching a program, especially on a "larger than life" monitor. Care should be taken to place or install the monitor where it cannot be pushed, pulled over, or knocked down.
- Care should be taken to route all cords and cables connected to the monitor so that they cannot be pulled or grabbed by curious children.

TIPS AND SAFETY INSTRUCTIONS

- The TFT color LCD panel used in this monitor is made with the application of high precision technology. However, there may be minute points on the screen where pixels never light or are permanently lit. Also, if the screen is viewed from an acute angle there may be uneven colors or brightness. Please note that these are not malfunctions but common phenomena of LCDs and will not affect the performance of the monitor.
- Do not display a still picture for a long period, as this could cause a residual image.
- Never rub or tap the monitor with hard objects.
- Please understand that SHARP CORPORATION bears no responsibility for errors made during use by the customer or a third party, nor for any other malfunctions or damage to this product arising during use, except where indemnity liability is recognized under law.
- This monitor and its accessories may be upgraded without advance notice.
- Do not use the monitor where there is a lot of dust, where humidity is high, or where the monitor may come into contact with oil or steam. Do not use in an environment where there are corrosive gases (sulfur dioxide, hydrogen sulfide, nitrogen dioxide, chlorine, ammonia, ozone, etc.). As this could lead to fire.
- Ensure that the monitor does not come into contact with water or other fluids. Ensure that no objects such as paper clips or pins enter the monitor as this could lead to fire or electric shock.
- Do not place the monitor on top of unstable objects or in unsafe places. Do not allow the monitor to receive strong shocks or to strongly vibrate. Causing the monitor to fall or topple over may damage it.
- Do not use the monitor near heating equipment or in places where there is likelihood of high temperature, as this may lead to generation of excessive heat and outbreak of fire.
- Do not use the monitor in places where it may be exposed to direct sunlight.
- Please be sure to constantly remove dust and garbage that has attached to the ventilation opening. If dust collects in the ventilation opening or the inside of the monitor, it may lead to excessive heat, outbreak of fire, or malfunction. Please request a cleaning of the inside of the monitor from an authorized SHARP servicing dealer or service center.
- Images cannot be rotated on this monitor. When using in portrait orientation, you will need to prepare appropriately orientated content in advance.
- The AC outlet shall be installed near the equipment and shall be easily accessible.

The Power Cord

- Use only the power cord supplied with the monitor.
- Do not damage the power cord nor place heavy objects on it, stretch it or over bend it. Also, do not add extension cords. Damage to the cord may result in fire or electric shock.
- Do not use the power cord with a power tap. Adding an extension cord may lead to fire as a result of overheating.
- Do not remove or insert the power plug with wet hands. Doing so could result in electric shock.
- Unplug the power cord if it is not used for a long time.
- Do not attempt to repair the power cord if it is broken or malfunctioning. Refer the servicing to the service representative.

Manual Scope

- Microsoft, Windows and Internet Explorer are registered trademarks of Microsoft Corporation.
- The terms HDMI and HDMI High-Definition Multimedia Interface, and the HDMI Logo are trademarks or registered trademarks of HDMI Licensing LLC in the United States and other countries.
- DisplayPort is a registered trademark of Video Electronics Standards Association.
- Adobe, Acrobat, and Reader are either registered trademarks or trademarks of Adobe Systems Incorporated in the United States and/or other countries.
- This product comes with RICOH Bitmap Fonts produced and sold by RICOH COMPANY, LTD.
- All other brand and product names are trademarks or registered trademarks of their respective holders.
- Language of OSD menu used in this manual is English by way of example.
- Illustrations in this manual may not exactly represent the actual product or display.
- This manual assumes use in landscape orientation, except where specifically noted.

LED Backlight

- The LED backlight in this product has a limited lifetime.
 - * If the screen gets dark or does not turn on, it may be necessary to replace the LED backlight.
 - * This LED backlight is exclusive to this product and must be replaced by an authorized SHARP servicing dealer or service center. Please contact an authorized SHARP servicing dealer or service center for assistance.

MOUNTING PRECAUTIONS

- This product is for use indoors.
- A mounting bracket compliant with VESA specifications is required.
- Since the monitor is heavy, consult your dealer before installing, removing or moving the monitor.
- Do not hold the monitor by the speakers.
- Mounting the monitor on the wall requires special expertise and the work must be performed by an authorized SHARP dealer. You should never attempt to perform any of this work yourself. Our company will bear no responsibility for accidents or injuries caused by improper mounting or mishandling.
- Use the monitor with the surface perpendicular to a level surface. If necessary, the monitor may be tilted up to 20 degrees upward or downward.
- This monitor should be used at an ambient temperature between 41°F (5°C) and 104°F (40°C). (32°F (0°C) and 104°F (40°C) for the PN-U473/PN-U423) Provide enough space around the monitor to prevent heat from accumulating inside.

For the monitor in landscape orientation

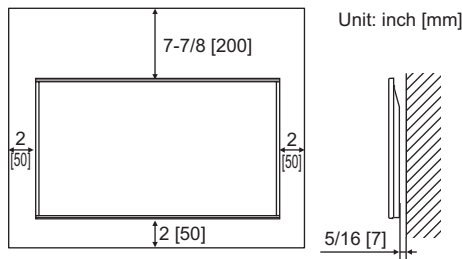

For the monitor in portrait orientation

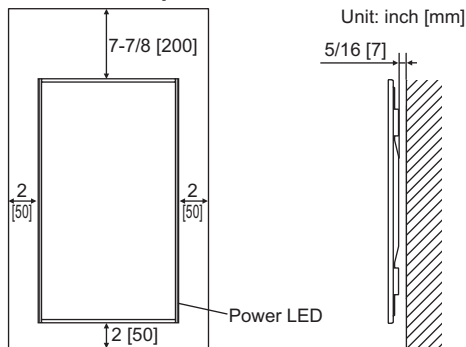

- Adhere to the following when installing the monitor in its portrait orientation. Failing to adhere to the following may cause malfunctions.
 - Install the monitor such that the power LED is located on the bottom side.
 - Set the MONITOR on the MONITOR menu to PORTRAIT. (See page 24.)
 - Be sure to clamp the power cord (supplied) onto the cable clamp attachment using the supplied cable clamp. When clamping the power cord, take care not to stress the terminal of the power cord. Do not bend the power cord excessively.

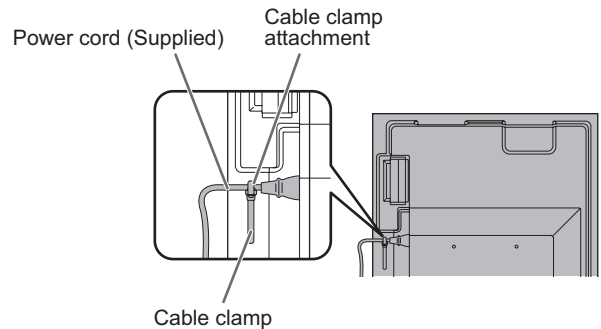

- Use the supplied vertical sticker when you install the monitor in portrait orientation.

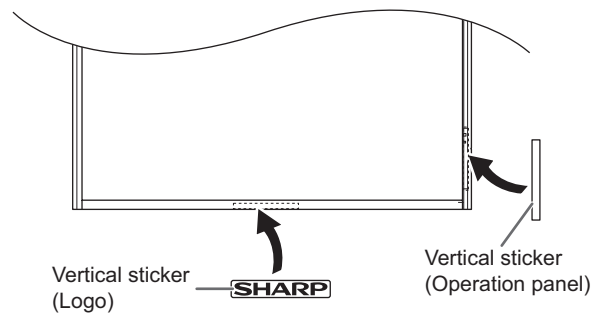

Do not remove the factory-affixed sticker but affix the sticker over it. Be careful not to cover the remote control sensor or buttons.

- If it is difficult to provide sufficient space for any reason such as the installation of the monitor inside a housing, or if the ambient temperature may be outside of the range of 41°F (5°C) to 104°F (40°C), install a fan or take other measures to keep the ambient temperature within the required range. (32°F (0°C) and 104°F (40°C) for the PN-U473/PN-U423)
- Temperature condition may change when using the monitor together with the optional equipments recommended by SHARP. In such cases, please check the temperature condition specified by the optional equipments.
- Do not block any ventilation openings. If the temperature inside the monitor rises, this could lead to a malfunction.
- Do not place the monitor on a device which generates heat.

Contents

IMPORTANT INFORMATION	3	Initialization (Reset)/Functional Restriction	
DEAR SHARP CUSTOMER	4	Setting (FUNCTION)	29
SAFETY PRECAUTIONS	4	Controlling the Monitor with a PC (RS-232C)	30
TIPS AND SAFETY INSTRUCTIONS	6	PC connection	30
MOUNTING PRECAUTIONS	7	Communication conditions	30
Supplied Components	8	Communication procedure	30
Part Names	9	RS-232C command table.....	34
Connecting Peripheral Equipment	11	Controlling the Monitor with a PC (LAN)	39
Connecting the Power Cord	13	Settings to connect to a LAN.....	39
Binding Cables	14	Controlling with a PC.....	41
Preparing the Remote Control Unit	15	“Advanced operation” Command-based control	44
Installing the batteries	15	Troubleshooting	45
Remote control operation range.....	15	Specifications	47
Turning Power On/Off	16	Mounting Precautions	
Turning on the main power.....	16	(For SHARP dealers and service engineers)	53
Turning power on/off	16		
Basic Operation	18		
Menu Items	20		
Displaying the menu screen.....	20		
Menu item details	21		
Adjustments for PC screen display	28		

Supplied Components

If any component should be missing, please contact your dealer.

- Liquid Crystal Display Monitor: 1
- Remote control unit: 1
- Cable clamp: 2
- Power cord: 1
- R-6 battery (“AA” size): 2
- CD-ROM (Utility Disk for Windows): 1
- Setup Manual: 1
- Vertical sticker (Logo): 1
- Vertical sticker (Operation panel): 1
- Model Name / Serial No. label: 1
 - Indicates the model name and serial number.
- Cover SHARP logo: 1
 - Place this sticker onto the SHARP logo to cover the logo.

* SHARP Corporation holds authorship rights to the Utility Disk program. Do not reproduce it without permission.

* For environmental protection!

Do not dispose of batteries in household waste. Follow the disposal instructions for your area.

Part Names

■ Front view

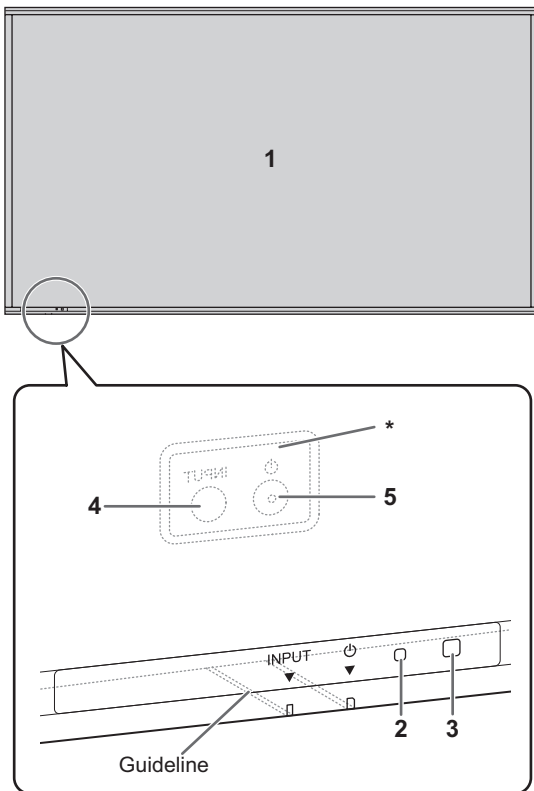

1. LCD panel
2. Power LED (See page 16.)
3. Remote control sensor (See page 15.)
4. Input switch (See page 18.)
5. Power switch (See page 16.)

* The Input switch and Power switch are located on the back of the monitor. Use the position of the slot on the front as a guideline for operation of the switches.
(The switch with the protrusion is the Power switch.)

■ Rear view

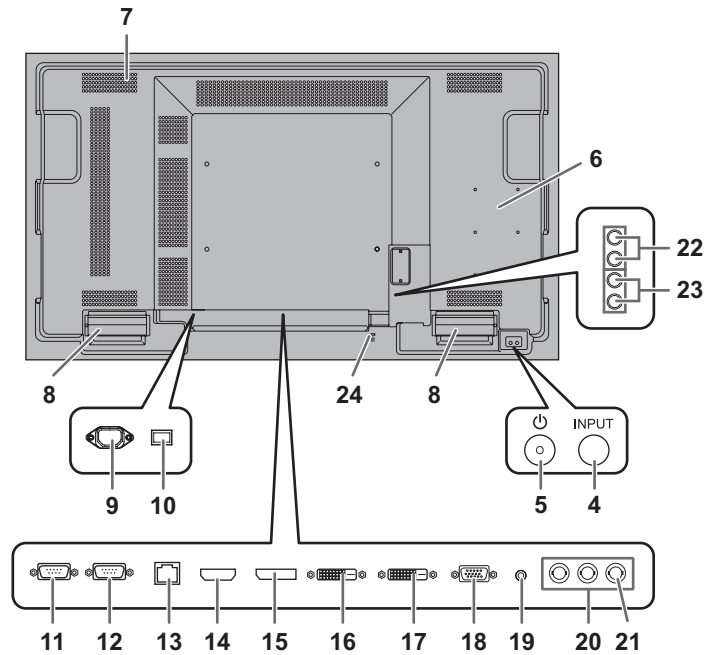

6. **Optional attachment section**
This section is used to connect optional hardware for function expansion. Offering this attachment location is not a guarantee that future compatible hardware attachments will be released.
7. **Vents**
8. **Speakers**
9. **AC input terminal** (See page 13.)
10. **Main power switch** (See page 16.)
11. **RS-232C output terminal** (See page 12.)
12. **RS-232C input terminal** (See page 12.)
13. **LAN terminal** (See page 12.)
14. **HDMI input terminal** (See page 11.)
15. **DisplayPort input terminal** (See page 11.)
16. **DVI-D input terminal** (See page 11.)
17. **DVI-D output terminal** (See page 12.)
18. **D-sub input terminal** (See page 11.)
19. **Audio1 input terminal** (See page 12.)
20. **Component input terminals** (See page 11.)
21. **Video input terminal** (See page 11.)
22. **Audio output terminals** (See page 12.)
23. **Audio2 input terminals** (See page 12.)
24. **Anti-theft hole** (R)
A commercially available anti-theft lock can be connected. The anti-theft hole is compatible with the Kensington MicroSaver Security System.

! Caution

- Consult your SHARP dealer for attachment/detachment of optional parts.
- When lifting or moving the monitor, do not hold by the speakers.

■ Remote control unit

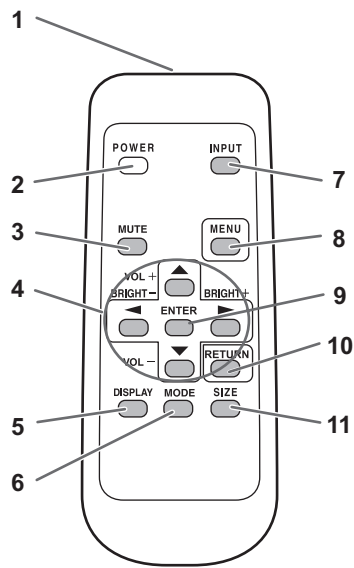

1. Signal transmitter
2. POWER button (See page 16.)
3. MUTE button (See page 18.)
4. VOL +/- buttons (See page 18.)
BRIGHT +/- buttons (See page 18.)
Cursor control (▲ / ▼ / ◀ / ▶) buttons
5. DISPLAY button (See page 18.)
6. MODE button (See page 18.)
7. INPUT button (See page 18.)
8. MENU button (See page 18.)
9. ENTER button (See page 18.)
10. RETURN button (See page 18.)
11. SIZE button (See page 18.)

Connecting Peripheral Equipment

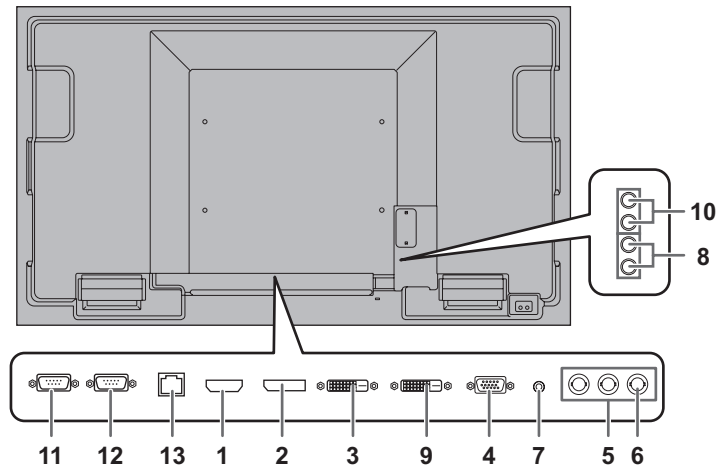

! Caution

- Be sure to turn off the main power switch and disconnect the plug from the power outlet before connecting/disconnecting cables. Also, read the manual of the equipment to be connected.
- Be careful not to confuse the input terminal with the output terminal when connecting cables. Accidentally reversing cables connected to the input and output terminals may cause malfunctions and the other problems.
- Do not use any cable that has a damaged or deformed terminal. Using such cables may cause malfunctions.

TIPS

- Images may not be displayed properly depending on the computer (video card) to be connected.
- Use the automatic screen adjustment when a PC screen is displayed for the first time using D-SUB, or when the setting of the PC is changed. The screen is adjusted automatically when SELF ADJUST in the SCREEN menu is set to ON.
- If the audio output from the playback device is connected directly to speakers or other devices, the video on the monitor may appear delayed from the audio portion. Audio should be played through this monitor by connecting the playback device to the monitor's audio input, and connecting the monitor's audio output to the speakers or other devices.
- The audio input terminals used in each input mode are factory-set as follows.

Input mode	Audio input terminal (Factory setting)
DVI-D, D-SUB	Audio1 input terminal
DisplayPort	DisplayPort input terminal
HDMI	HDMI input terminal
COMPONENT, VIDEO	Audio2 input terminals

1. HDMI input terminal

- Use a commercially available HDMI cable (conforming to the HDMI standard).
- Select the audio input terminal to be used in AUDIO SELECT of the SETUP menu. When HDMI is selected, connection to the audio input terminal is unnecessary.

2. DisplayPort input terminal

- Use a commercially available DisplayPort cable.
- Select the audio input terminal to be used in AUDIO SELECT of the SETUP menu. When DisplayPort is selected, connection to the audio input terminal is unnecessary.

3. DVI-D input terminal

- Use a commercially available signal cable (DVI-D 24 pin).
- Select the audio input terminal to be used in AUDIO SELECT of the SETUP menu.

4. D-sub input terminal

- Select the audio input terminal to be used in AUDIO SELECT of the SETUP menu.

5. Component input terminals

- Select the audio input terminal to be used in AUDIO SELECT of the SETUP menu.

6. Video input terminal

- Select the audio input terminal to be used in AUDIO SELECT of the SETUP menu.

Connecting Peripheral Equipment

7. Audio1 input terminal

- Use an audio cable without resistance.
- Set the audio input terminal to be used in each input mode in AUDIO SELECT on the SETUP menu.

8. Audio2 input terminals

- Set the audio input terminal to be used in each input mode in AUDIO SELECT on the SETUP menu.

9. DVI-D output terminal

- When the input mode is set to DVI-D, the video of the DVI-D input can be output to an external device.
- Outputting HDCP-encrypted video requires an external device which supports HDCP.
- This terminal allows the daisy chain connection of up to 5 monitors by connecting the monitors to each other through the DVI-D input terminal of each monitor.

TIPS

- The length of the signal cables or surrounding environment may affect the image quality.
- When the input mode is set to a mode other than DVI-D, video cannot be output.

10. Audio output terminals

- The output sound varies depending on the input mode.
- It is not possible to control the sound output from the audio output terminals with the AUDIO menu.

11. RS-232C output terminal

12. RS-232C input terminal

- You can control the monitor from a PC by connecting a commercially available RS-232 straight cable between these terminals and the PC.
- PN-U553/PN-U473/PN-U423 monitors can be connected together in a daisy chain connection.

13. LAN terminal

- You can control the monitor from a PC on a network by connecting a commercially available LAN cable between this terminal and a network.

Connecting the Power Cord

! Caution

- Use only the power cord supplied with the monitor.
1. Turn off the main power switch.
 2. Plug the power cord (supplied) into the AC input terminal.
 3. Plug the power cord (supplied) into the AC power outlet.

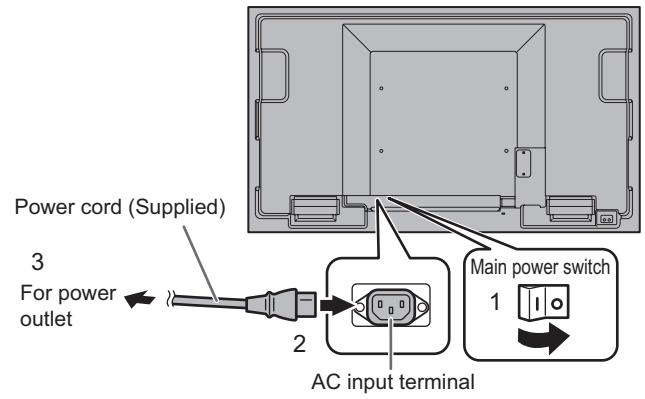

Binding Cables

[PN-U553]

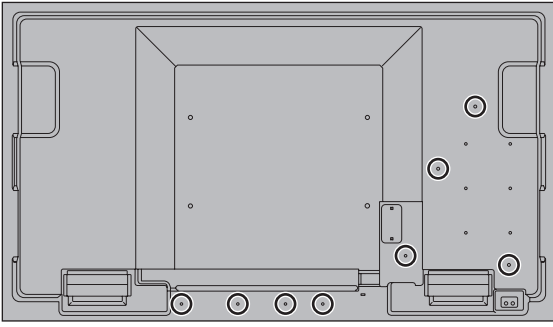

The cables connected to the terminals on the rear of the monitor can be fastened with the cable clamp.

Attach the cable clamp into the cable clamp attachment on the rear of the monitor and fasten the cables.

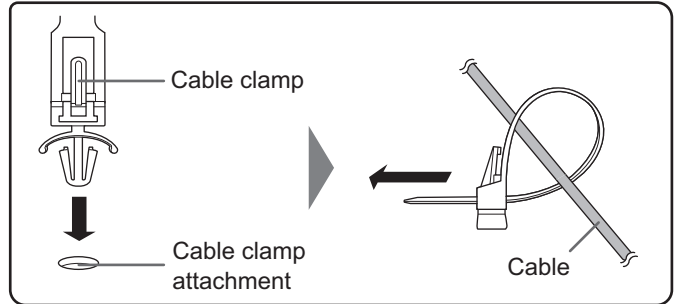

[PN-U473]

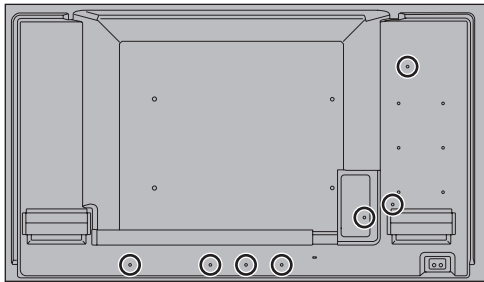

[PN-U423]

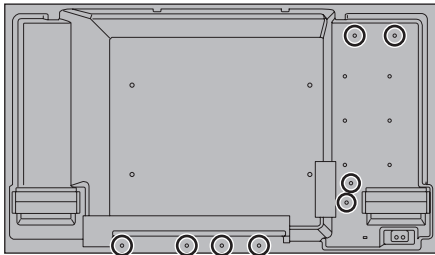

Preparing the Remote Control Unit

Installing the batteries

1. Press the cover gently and slide it in the direction of the arrow.

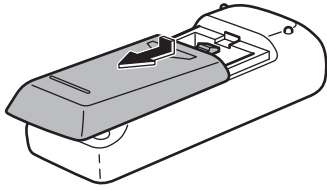

2. See the instructions in the compartment and put in the supplied batteries (R-6 ("AA" size) x 2) with their plus (+) and minus (-) sides oriented correctly.
3. Close the cover.

TIPS

- When the batteries become exhausted, replace them with new (commercially available) batteries.
- The supplied batteries (R-6 ("AA" size) x 2) may become exhausted quickly depending on how they are stored.
- If you will not be using the remote control for a long time, remove the batteries.
- Use manganese or alkaline batteries only.

Remote control operation range

The operation range of the remote control unit is approx. 16.4 feet (5 m) at an angle of approx 10° from the center to the top/bottom/right/left of the remote control sensor.

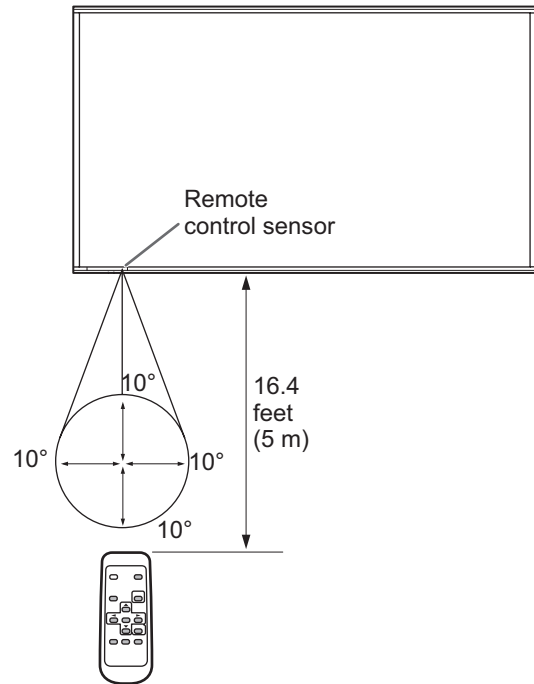

TIPS

- Do not expose the remote control unit to shock by dropping or stepping on it. This could lead to a malfunction.
- Do not expose the remote control unit to liquids, and do not place it in an area with high humidity.
- The remote control unit may not work properly if the remote control sensor is under direct sunlight or strong lighting.
- Objects between the remote control unit and the remote control sensor may prevent proper operation.
- Replace the batteries when they run low as this may shorten the remote control's operation range.
- If a fluorescent light is illuminated near the remote control unit, it may interfere with proper operation.
- Do not use it with the remote control of other equipment such as air conditioner, stereo components, etc.

Turning Power On/Off

! Caution

- Turn on the monitor first before turning on the PC or playback device.

Turning on the main power

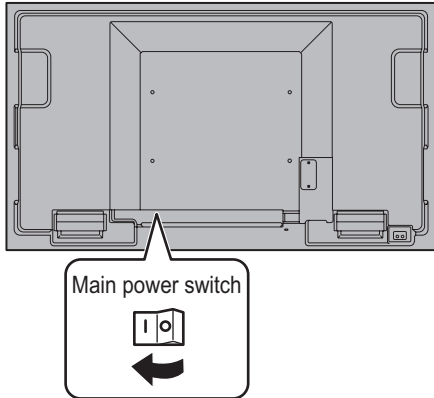

! Caution

- The main power must be turned on/off with the main power switch. Do not connect/disconnect the power cord or turn the breaker on/off while the main power switch is on.
- When switching the main power switch or the POWER button off and back on, always wait for at least 5 seconds.
- For a complete electrical disconnection, pull out the main plug.

Turning power on/off

Press the POWER button or POWER switch to turn the power ON/OFF.

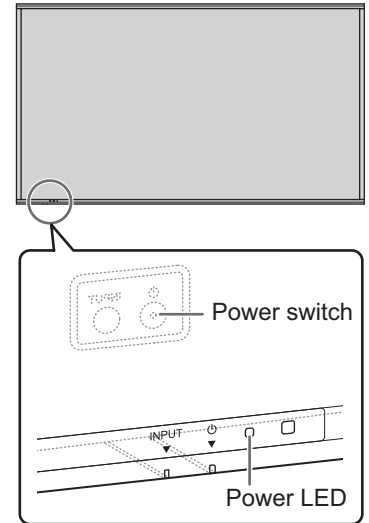
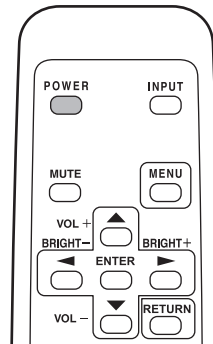

Status	Status of the monitor
Green lit	Power on
Orange lit	Power off (Standby mode)
Green flashing	Input signal waiting mode

! Caution

- When switching the main power switch or the POWER button off and back on, always wait for at least 5 seconds. A short interval may result in a malfunction.

TIPS

- When the main power switch is off, the monitor cannot be turned on.
- If the monitor is in the input signal standby mode and you press the POWER button on the remote control unit, the monitor enters standby mode.
- Setting the SCHEDULE flashes the power LED alternately in red and orange in standby mode.
- To disable the logo screen from displaying when turning the power ON, set LOGO SCREEN to OFF on the OTHERS menu. (See page 25.)

■ Date/time setting

- If the time has not been set, such as when the monitor is first turned on, set the date and time in DATE/TIME SETTING of the SETUP menu.
Be sure to set the date and time.

TIPS

- Set the date in "Year/Month/Day" order.
- Set the time on a 24-hour basis.
- The clock stops if the main power remains off for about 1 week.*
(*Approximate time. The actual time varies depending on the state of the monitor.)

Basic Operation

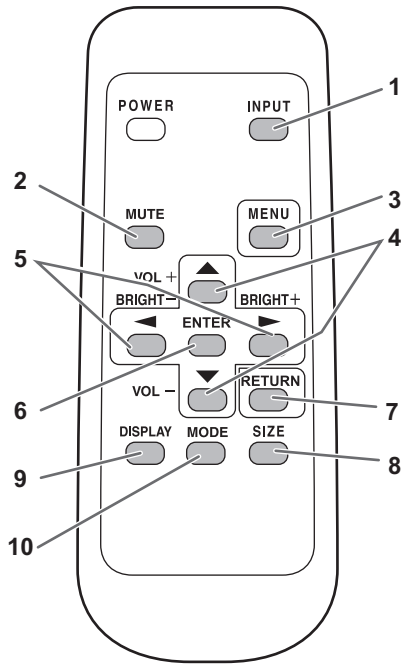

1. INPUT (Input mode selection)

The menu is displayed. Press or to select the input mode, and press to enter.

* You can select the input terminal by pressing the input switch of the monitor.

Input mode	Video	Audio
DVI-D	DVI-D input terminal	*
DisplayPort	DisplayPort input terminal	
HDMI	HDMI input terminal	
D-SUB	D-sub input terminal	
COMPONENT	Component input terminals	
VIDEO	Video input terminal	

* Select the terminal for AUDIO SELECT which is used for audio input. (See page 23.)

2. MUTE

Turns off the volume temporarily.

Press the MUTE button again to turn the sound back to the previous level.

3. MENU

Displays and turns off the menu screen. (see page 20.)

4. VOL +/- (Volume adjustment)

Pressing or displays the VOLUME menu when the menu screen is not displayed.



Press or to adjust the volume of the sound.

* If you do not press any buttons for about 5 seconds, the VOLUME menu automatically disappears.

5. BRIGHT +/- (Brightness adjustment)

Pressing or displays the BRIGHT menu when the menu screen is not displayed.



Press or to adjust the brightness.

* If you do not press any buttons for about 5 seconds, the BRIGHT menu automatically disappears.

6. ENTER

Confirms the setting.

7. RETURN

Returns to the previous screen.

8. SIZE (Screen size selection)

Each time you press this button, the screen size changes in the following order: (See page 19.)

WIDE → NORMAL → CUSTOM → Dot by Dot → WIDE...

9. DISPLAY

Displays monitor information (Input mode, Audio).

The display disappears automatically after about 5 seconds.

10. MODE (Color mode selection)

Each time you press this button, the color mode changes in the following order:

STD (Standard) → sRGB → HIGH ILLUMINANCE → STD...

- HIGH ILLUMINANCE is a display with colors suited to bright locations.
- sRGB is for DVI-D, DisplayPort, and D-SUB input only. sRGB is international standard of color representation specified by IEC (International Electrotechnical Commission). Color conversion is made in taking account of liquid crystal's characteristics and represents color tone close to its original image.

■ Switching the screen size

Even when the screen size is changed, the display may remain the same depending on the input signal.

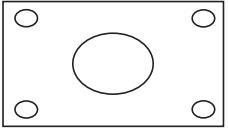
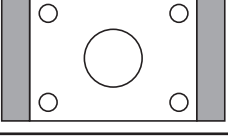
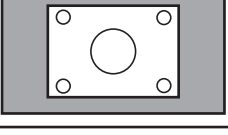
WIDE		Displays image so it fills the entire screen.
NORMAL		Displays image so it fills the screen without changing the aspect ratio of the input signals.
Dot by Dot		Displays the dots of the input signals as the corresponding dots on the screen.
CUSTOM	Displays the image at the size set with CUSTOM ZOOM in the SCREEN menu.	

TIPS

- Using this monitor's screen-size switching or dual-screen display functions to compress or expand the screen for commercial or public viewing in establishments like cafes or hotels may infringe on the rights of the creators, as protected by Copyright Law, so please be careful.
- When "Enlarge" is set, the screen size is fixed to WIDE mode.
- When dual-screen display is selected, the screen size cannot be set to Dot by Dot or CUSTOM.
- The appearance of the original video may change if you select a screen size with a different aspect ratio than the original image (e.g. TV broadcast or video input from external equipment).
- When an ordinary non-wide image (4:3) is viewed with the whole screen using the screen-size switching function of this monitor, the edge of the image may be lost or appear distorted. If you wish to respect the creator's intentions, set the screen size to NORMAL.
- When playing commercial software, parts of the image (like subtitles) may be cropped. In this case select the optimal screen size using the screen-size switching function of this monitor. With some software, there may be noise or distortion at the edges of the screen. This is due to the characteristics of the software, and is not a malfunction.
- Depending on the original image size, black bands may remain at the edges of the screen.

Menu Items

Displaying the menu screen

Video and audio adjustment and settings of various functions are enabled. This section describes how to use the menu items. See pages 21 to 27 for details of each menu items.

Caution

- Do not turn the main power switch off while the menu items are being displayed. Doing so may initialize the settings.

Example of operation

(Adjusting CONTRAST in the PICTURE menu)

- Press to display the menu screen.

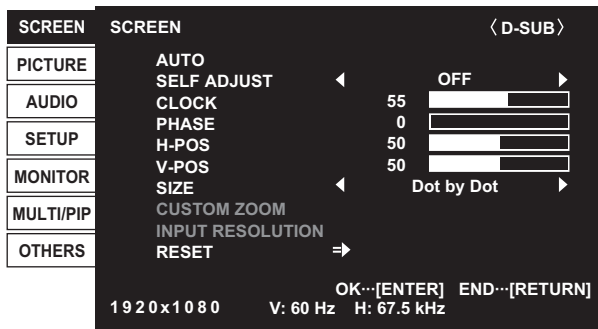

- Press or to select PICTURE, and press .

- Press or to select CONTRAST.

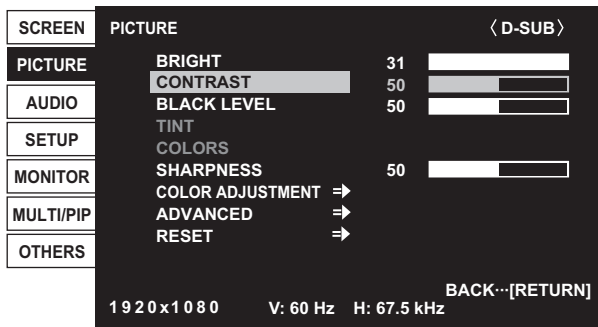

- Press or to adjust the setting.

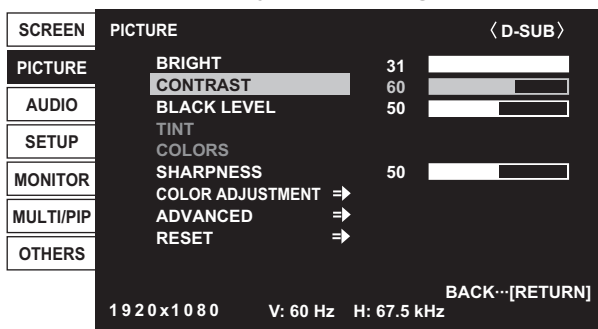

For items that have , press , make settings and then press .

- Press to close the menu screen.

TIPS

- The menu will differ depending on the input mode.
- The menu screen will close automatically if no operation is performed for about 45 seconds.

Menu screen display

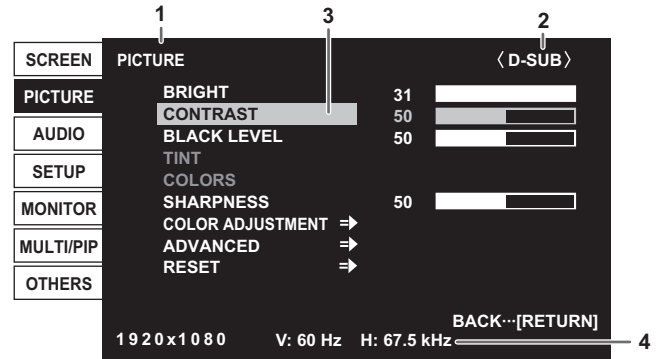

- Name of the menu
- Input mode
- An item being selected (highlighted)
- Screen resolution of input signal, and other data.

TIPS

- Items that cannot be selected appear in gray. (e.g. Function not supported by the current input signal)

Menu item details

The menu will differ depending on the input mode.

■SCREEN

AUTO (D-SUB)

The CLOCK, PHASE, H-POS, and V-POS are automatically adjusted.

Pressing performs adjustment. Use this automatic adjustment when you use the D-SUB to display a PC screen for the first time or when you change the setting of the PC. (See page 28.)

SELF ADJUST (D-SUB)

On a D-SUB screen, specify whether to perform screen adjustment automatically or not.

When ON is selected, the screen is automatically adjusted when the timing of input signals changes.

For images with black edges, etc., depending on the signal, adjustment may not be possible. In this case select OFF. (Perform manual adjustment of the screen.)

CLOCK (D-SUB)

Adjusts frequency for sampling clock for applicable video.

Adjust when there is flickering in the form of vertical stripes.

When using the adjustment pattern (see page 28), make adjustments so that no vertical stripe noise appears in it.

PHASE (D-SUB)

Adjusts sampling clock phase for applicable video. Useful when small characters appear with low contrast and/or there are flickers at corners. When using the adjustment pattern (see page 28), make adjustments so that no horizontal stripe noise appears in it.

* Adjustments to PHASE should be made only after CLOCK has been correctly set.

H-POS (D-SUB)

Adjust the horizontal position of the image.

V-POS (D-SUB)

Adjust the vertical position of the image.

SIZE

Changes the screen size. The screen size can also be changed using a remote control unit. (See page 19.)

CUSTOM ZOOM

Sets the image size and display area when SIZE is set to CUSTOM.

ZOOM

Enlarge and display part of the image.

H-ZOOM

Adjust the horizontal size of the image.

V-ZOOM

Adjust the vertical size of the image.

H-POS / V-POS (D-SUB)

Adjust the display position of the enlarged image.

INPUT RESOLUTION (D-SUB)

If a computer connected to the D-SUB output any of the following resolution, make a selection from the following options.

768.....AUTO, 1024x768, 1280x768, or 1360x768

1050.....AUTO, 1400x1050 or 1680x1050

1200.....AUTO, 1600x1200 or 1920x1200

RESET

Resets the values of the SCREEN menu items to the factory preset values.

Select "ON" and then press .

Menu Items

■ PICTURE

BRIGHT

Adjusts the backlight brightness.

CONTRAST

Adjusts the difference between the bright and dark portions of the image.

BLACK LEVEL

Adjusts the entire brightness of the video signals.

TINT (HDMI/COMPONENT/VIDEO)

Adjusts the hue. Selecting - changes the color towards green, and selecting + changes it towards magenta.

COLORS (HDMI/COMPONENT/VIDEO)

Adjusts the color intensity.

SHARPNESS

Adjusts the sharpness of the image.

COLOR ADJUSTMENT

COLOR MODE

Changes the color mode on the screen. The color mode on the screen can also be changed using a remote control unit. (See page 18.)

* sRGB is DVI-D, DisplayPort, D-SUB input only. See page 18 for details.

WHITE BALANCE

THRU Displays the input signal level as is.

PRESET Selects the color temperature using PRESET.

USER Used for adjusting R-/G-/B-GAIN and R-/G-/B-OFFSET respectively.

PRESET

Selects the color temperature when the WHITE BALANCE is set to PRESET.

The setting values are shown for reference. The color temperature of the screen varies over time. This function is not intended to keep the color temperature constant.

USER

Adjusts each item when the WHITE BALANCE is set to USER.

R-GAIN Adjusts bright-toned red component.

G-GAIN Adjusts bright-toned green component.

B-GAIN Adjusts bright-toned blue component.

R-OFFSET Adjusts dark-toned red component.

G-OFFSET Adjusts dark-toned green component.

B-OFFSET Adjusts dark-toned blue component.

GAMMA

Selects the gamma.

ADVANCED

NOISE REDUCTION (HDMI/COMPONENT/VIDEO)

Reduce the noise of playback images on video.

Setting a higher level reduces more noise. However, it may cause blurring on an image.

HDMI RGB INPUT RANGE (HDMI)

Sets the RGB input signal range. Set according to the image.

When the setting is different, images will be displayed with washed out blacks and compressed gradients.

RESET

Resets the values of the PICTURE menu items to the factory preset values.

Select "ON" and then press .

■AUDIO**TREBLE**

Adjusts the volume of treble-level sound.

BASS

Adjusts the volume of bass-level sound.





BALANCE

Adjusts the balance of the audio sound between right and left.

RESET

Resets the values of the AUDIO menu items to the factory preset values.
Select "ON" and then press .

■SETUP**DATE/TIME SETTING**

Set the date and time. Press  or  to select the date and time, and press  or  to change the numerical values.
Set the date in "Year/Month/Day" order.
Set the time on a 24-hour basis.

SCHEDULE (See page 27.)

You can turn the power on/off at a specified time.

LANGUAGE

Sets the display language for the menu screen.

INPUT SELECT**HOT PLUG CONTROL**

Sets whether to use hot plug control for the DVI-D and HDMI input terminals.

AUDIO SELECT

Selects the terminal used to input audio signals in each input mode.

COMMUNICATION SETTING**RS-232C/LAN SELECT**

Selects the method with which to control the monitor from the computer.

LAN SETUP

Configures the settings to control the monitor from the computer via LAN. (See page 39.)

ID No. SET

Assigns ID numbers to monitors connected in a daisy chain (see page 31), using the RS-232 cables.
The numbers 1 to 26 are available for ID numbers.
If "0" is set, the system regards this as the state where no ID number is set.

INFORMATION

Displays monitor information (model, serial number, MAC address).

Menu Items

■ MONITOR

MONITOR

Select the installation direction of the monitor.

LANDSCAPELandscape orientation

PORTRAITPortrait orientation

OSD H-POSITION

Adjusts the horizontal display position of menu screen.

OSD V-POSITION

Adjusts the vertical display position of menu screen.

STANDBY MODE

When STANDARD is selected, startup time from standby mode is reduced. Note, however that, more power will be consumed in standby mode.

When LOW POWER is selected, current consumption is reduced while the monitor is in standby mode. Note, however, that the startup time from standby mode becomes longer.

If set to LOW POWER, RS-232C commands cannot be used in standby mode and control via LAN is disabled.

OFF IF NO OPERATION

Determines whether or not to set the monitor to go into standby mode when there is no operation from the remote control unit, RS-232C commands, or LAN for over 4 hours.

POWER ON DELAY

You can delay the screen display after the monitor is turned on. The period can be set up to 60 seconds in units of 1 second.

When this function is activated, the power LED flashes (at approx. 1 second interval) in orange.

■ MULTI/PIP

MULTI

ENLARGE (See page 26.)

Sets whether or not to use the enlarge function.

ADVANCED (ENLARGE)

ENLARGE H / ENLARGE V

.....Sets the number of screen splits (number of monitors) in the horizontal/vertical direction used for the enlargement.

ENLARGE-POS

.....Specify the split screen to be displayed when the enlargement function is used.

BEZEL ADJUST

When ENLARGE is set to ON, sets whether or not to use the frame correction function.

PIP/PbyP

PIP MODES (See page 26.)

Sets the display method.

OFFDisplays one screen.

PIPDisplays a sub screen inside a main screen.

PbyP.....Displays a main screen and a sub screen in a line.

PbyP2.....Displays a main screen which measures 1440 pixels in the longest direction and a sub screen in a line.

PIP SIZE

Sets the size of the sub screen in PIP mode.

PIP H-POS

Adjusts the horizontal position of the sub screen in PIP mode.

PIP V-POS

Adjusts the vertical position of the sub screen in PIP mode.

PIP SOURCE

Selects the input signal of the sub screen in PIP, PbyP, or PbyP2 mode.

SOUND CHANGE

Sets the sound which is output in PIP, PbyP, or PbyP2 mode.

■ OTHERS

SCREEN MOTION

Residual images can be reduced by moving the entire screen vertically and horizontally.
Set the time (operating interval) until the screen moves.

POWER MANAGEMENT

POWER MANAGEMENT determines whether or not to switch modes from no signal to the input signal standby mode.
When the input mode is DisplayPort, HDMI, DVI-D, or D-SUB, or when the input mode is COMPONENT or VIDEO, the settings of each can be configured.

LOGO SCREEN

Sets whether or not to display the logo screen.

SCAN MODE (HDMI)

Sets the scan mode.

OVERSCAN Over-scan display

UNDERSCAN..... Under-scan display

BACKLIGHT OFF

When set to ON, the backlight turns off. While the backlight is off, residual images are reduced by internal display of a residual image reduction pattern. BACKLIGHT OFF is canceled when any operation is performed, such as using the remote control unit.

COLOR SYSTEM (VIDEO)

Select the color system of the AV equipment which is connected to video input terminal. (AUTO / PAL / PAL-60 / SECAM / NTSC3.58 / NTSC4.43)

When AUTO is selected, the color system is automatically set according to the input signal.

TIPS

- If COLOR MODE is set to sRGB, the following items cannot be set.
WHITE BALANCE, PRESET, USER, GAMMA, BLACK LEVEL and CONTRAST
- When the COLOR MODE is set to HIGH ILLUMINANCE, GAMMA can not be adjusted.
- When the SCREEN MOTION function is set to used, the SIZE is WIDE.
- When dual-screen display is selected or Enlarge is used, the SCREEN MOTION function is disabled.
- With some parameters, the same adjustment value may continue.
This is because adjustment in 100 or more steps is possible internally, and is not a failure.

Menu Items

■Dual screen display

You can display two screens simultaneously. Set this function with PIP MODES of PIP/PbyP in the MULTI/PIP menu.

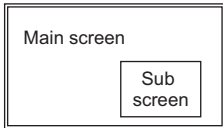
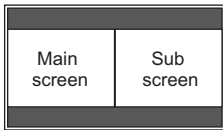
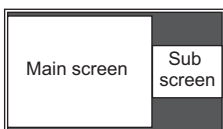
PIP		A sub screen is displayed inside a main screen.
PbyP		A main screen and a sub screen are displayed in a line.
PbyP2		Displays a main screen which measures 1440 pixels in the longest direction and a sub screen in a line.

- * The currently selected input signal is displayed on the main screen.
- * The following combinations [A] and [B] are available for display:
[A]: DVI-D/DisplayPort/HDMI
[B]: D-SUB/COMPONENT/VIDEO

TIPS

- You might infringe on a copyright of the author which is protected by copyright law when you display the images of the computer screen and television/VCR simultaneously for profit-making or to show the image to the public.
- When the screen size is Dot by Dot or CUSTOM, dual-screen display is not possible.
- When dual-screen display is selected, the screen size cannot be set to Dot by Dot or CUSTOM.
- When PIP is selected, the sub screen is displayed at an aspect ratio of 4:3, regardless of the screen size setting.
- When PbyP is selected, the main screen and sub screen are displayed at the aspect ratio of the input signal, regardless of the screen size setting.
- When PbyP2 is selected, the main screen and sub screen are displayed at an aspect ratio of 4:3, regardless of the screen size setting.
- When dual-screen display is selected, the SCREEN MOTION function is disabled.
- When dual-screen display is selected, the screen cannot be enlarged.
- When an interlaced signal (1080i, 480i, video) is input to the sub screen, horizontal lines may flicker. If this happens, display the image on the main screen.
- When the main screen is DVI-D, HDMI, or DisplayPort, the input mode that can be selected is DVI-D, HDMI, or DisplayPort.
- When the main screen is D-SUB, COMPONENT, or VIDEO, the input mode that can be selected is D-SUB, COMPONENT, or VIDEO.
- In the following cases, dual-screen display is turned off:
 - The power is turned off
 - Input signal waiting mode is entered

■Enlarge

- You can align several monitors and integrate them into a single large screen to display.
- Up to 5 monitors can be aligned in both the horizontal and vertical directions.
- Each monitor displays enlarged views of separated images.

(Example)

Horizontal direction: 2 monitors

Vertical direction: 2 monitors

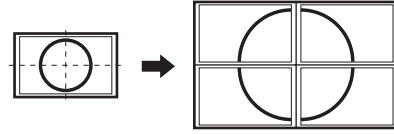





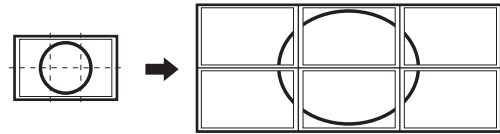

Horizontal direction: 3 monitors

Vertical direction: 2 monitors



Setting procedure

Set using MULTI in the MULTI/PIP menu.

1. Set **ENLARGE** to **ON**.
2. Select **ADVANCED (ENLARGE)**.
3. Set the number of monitors aligned in the horizontal direction in **ENLARGE H**.
4. Set the number of monitors aligned in the vertical direction in **ENLARGE V**.
5. Set the section of the separated image to be displayed on each monitor in **ENLARGE-POS**.
 - 1) Press .
 - 2) Press , ,  or  to select position, then press .

TIPS

- When Enlarge is used, the SCREEN MOTION function is disabled.
- When Enlarge is used, dual-screen display cannot be used.
- When Enlarge is used, the SELF ADJUST function is disabled.

■ SCHEDULE

You can set the time to switch the monitor on and off.
Set this function with SCHEDULE in the SETUP menu. (See page 23.)

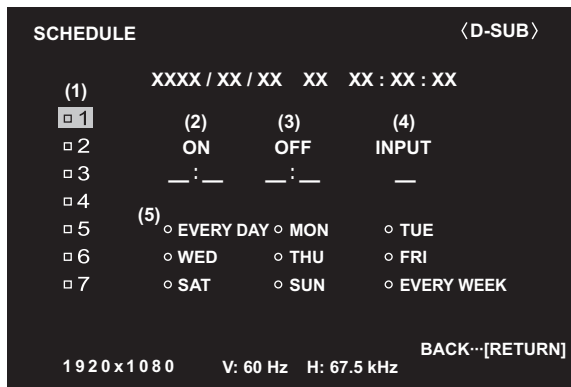

- Press or to select the SCHEDULE number, and press .
- Set the SCHEDULE. ((2) to (5) below)
Press or to select items.
- Press .
- Press or to select the SCHEDULE number, and press . ((1) below)
SCHEDULE becomes effective.

(1) SCHEDULE number

Enable/disable the SCHEDULE with .

- : SCHEDULE effective
- : SCHEDULE not effective

(2) ON

Specify the time the power turns on with or .

Set the time on a 24-hour basis.

(3) OFF

Specify the time the power turns off with or .

Specify a time later than the time the power is turned on.
Set the time on a 24-hour basis.

(4) INPUT

Specify the input mode at power on with or .

If you don't specify this the input active at the last power-off will appear.

(5) Day of the week

Specifies the day of the week to execute the SCHEDULE with .

- EVERY DAY
Executes the SCHEDULE every day regardless of the day of the week.
- MON - SUN
Executes the SCHEDULE once on the specified day.
- EVERY WEEK
Executes the SCHEDULE on the specified day every week.
Select EVERY WEEK and specify the day of the week (MON - SUN).

! Caution

- Do not switch off the main power after setting the SCHEDULE.
- Specify the correct date and time. (See page 23.)
SCHEDULE does not function unless the date and time are specified.
- Check regularly that the set date and time are correct.





TIPS

- Up to 7 SCHEDULE items can be registered.
- Setting the SCHEDULE flashes the power LED alternately in red and orange in standby mode.
- A SCHEDULE that has a large number has precedence over that of a small number when schedules overlap.
- In the following cases, set separate power-on SCHEDULE and power-off SCHEDULE:
 - The power is turned off and then on, in that order, in the SCHEDULE
 - The power is turned on and then off, in that order, in the SCHEDULE, but the power-off time is the next day or later

Adjustments for PC screen display

■ Automatic adjustment

When you use the D-SUB to display a PC screen for the first time, or when you change the setting of the PC, use the automatic screen adjustment.

1. **Switch the input to D-SUB and display the adjustment pattern.** (See the description below.)
2. Press  and use  or  to display the SCREEN menu.
3. Press  and select "AUTO".
4. Press .

The automatic adjustment is complete in several seconds.

TIPS

- If the screen cannot be adjusted properly with one automatic adjustment, repeat the automatic adjustment two or three times. Try manual adjustment if necessary.

■ Screen display for adjustment

Before making adjustments in the SCREEN menu or PICTURE menu, display an image to brighten the entire screen. If you are using a Windows PC, use the adjustment pattern on the supplied CD-ROM.

Opening the adjustment pattern

The following example is performed in Windows 7.

1. **Load the supplied CD-ROM into the computer's CD-ROM drive.**
2. **Open [CD Drive] in [Computer].**
In Windows XP, open [CD Drive] in [My Computer].
3. **Double-click [Adj_uty.exe].**
The adjustment pattern will appear.
Adjust the screen automatically or manually.

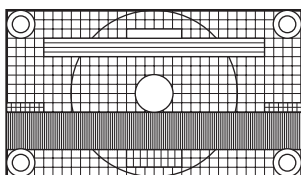

4. **When adjustment is finished, press the [Esc] on the computer's keyboard to quit the adjustment program.**
5. **Eject the CD-ROM from the CD-ROM drive.**

TIPS

- If the display mode on the computer you are using is 65,000 colors, the color levels in the color pattern may appear differently or grayscale may appear to be colored. (This is due to the specifications of the input signal and is not a malfunction.)

Initialization (Reset)/Functional Restriction Setting (FUNCTION)

You can return the settings to their factory-preset values and restrict operations.

1. Hold **SIZE** down until "F" appears in the upper left corner of the screen.
2. While "F" appears, press **UP**, **RIGHT**, **DOWN**, **LEFT** in that order.

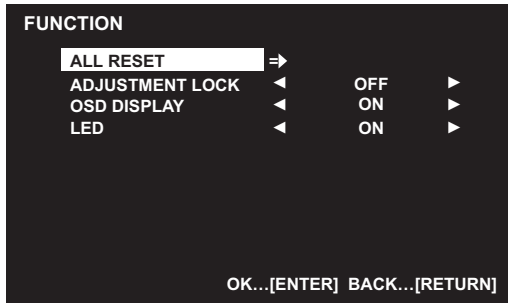

3. Select and set the items.

ALL RESET

Resets the settings to the factory default settings. (The settings in COMMUNICATION SETTING are retained.)

Press **ENTER**, select ALL RESET, and then press **ENTER**. After initialization, turn the main power switch off and then back on.

ADJUSTMENT LOCK

You can disable operations on the monitor and the remote control unit that use buttons.

OFF ... Enables operation.

ON Disables all operations other than turning power on/off and FUNCTION.

OSD DISPLAY

Shows/hides the menu, modes and messages. The FUNCTION screen cannot be hidden.

ON Shows menus, modes, and messages.

OFF Hides menus, modes and messages.

LED

Specifies whether to light the power LED.

4. Press **RETURN** to return to the normal screen.

TIPS

- Even if LED is set to OFF, the power LED lights when a temperature alert occurs.

Controlling the Monitor with a PC (RS-232C)

You can control this monitor from a PC via RS-232C (COM port) on the PC.

You can also connect multiple monitors via a daisy chain by using a PC. By assigning ID numbers to each monitor (see page 31), you can make input mode selection/adjustment or can check the status of a specific monitor.

TIPS

- To control the monitor via RS-232C, set RS-232C/LAN SELECT to RS-232C, and STANDBY MODE to STANDARD.
- You cannot use RS-232C and LAN control simultaneously.

PC connection

■One-to-one connection with a PC

Connect with RS-232 straight cable between the PC's COM port (RS-232C connector) and the RS-232C input terminal on the monitor.

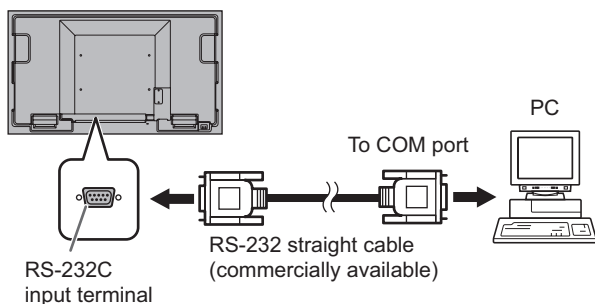

■Daisy chain connection... **Advanced operation**

PN-U553/PN-U473/PN-U423 monitors can be connected together in a daisy chain connection.

Connect with RS-232 straight cable between the PC's COM port (RS-232C connector) and the RS-232C input terminal on the first monitor.

Next, connect RS-232 straight cable to the first monitor's RS-232C output terminal and to the second monitor's RS-232C input terminal. Connect in the same way to the third and subsequent monitors.

Up to 25 monitors can be connected. (Depending on the length of the cable used and the surrounding environment.)

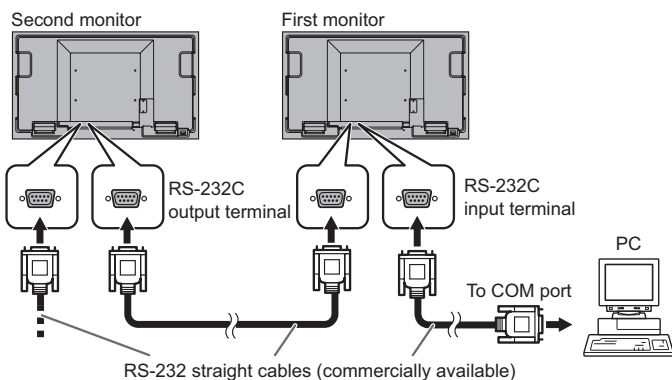

Communication conditions

Set the RS-232C communication settings on the PC to match the monitor's communication settings as follows:

Baud rate	9600bps	Stop bit	1 bit
Data length	8 bits	Flow control	None
Parity bit	None		

Communication procedure

■Command format

When a command is sent from the PC to the monitor, the monitor operates according to the received command and sends a response message to the PC.

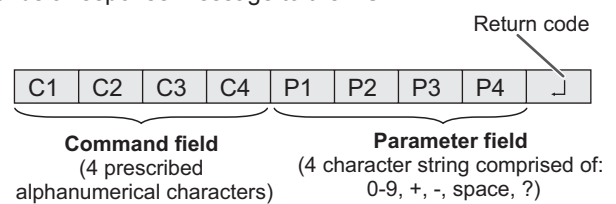

Example: VOLM0030
VOLM _ _ 30

- * Be sure to input 4 characters for the parameter. Pad with spaces (" ") if necessary. (" " is a return code (0DH, 0AH or 0DH))
Wrong : VOLM30
Right : VOLM _ _ 30

Do not use spaces for MPOS, DATE, and SH01 through SH07. Specify parameters using a specified number of characters.

Example: MPOS010097

If a command has "R" listed for "DIRECTION" in the "RS-232C command table" on page 34, the current value can be returned by using "?" as the parameter.

Example:

VOLM ? ? ? ? ← From PC to monitor (How much is current volume setting?).

30 ← From monitor to PC (Current volume setting: 30).

- * If an ID number (see page 31) has been assigned (For example, ID number = 1).

VOLM _ _ _ ? ← From PC to monitor.

30 _ 001 ← From monitor to PC.

Response code format

When a command has been executed correctly

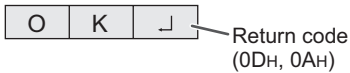

A response is returned after a command is executed.

- * If an ID number has been assigned

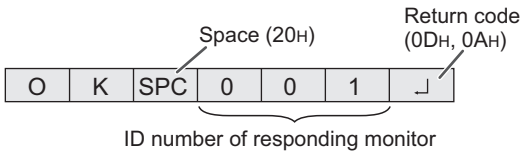

When a command has not been executed

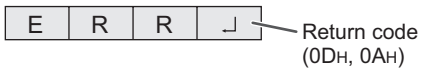

- * If an ID number has been assigned

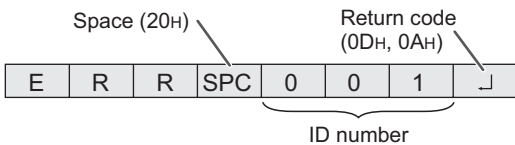

TIPS

- “ERR” is returned when there is no relevant command or when the command cannot be used in the current state of the monitor.
- If communication has not been established for reasons such as a bad connection between the PC and monitor, nothing is returned (not even ERR).
- “ERR” may be returned when a command cannot be received correctly due to interference from the surrounding environment.
Please ensure that the system or software retries the command if this occurs.
- If no monitor has been assigned the designated ID number (e.g. if the command IDSL0002 is used, but no monitor with ID number: 2 is found), no response is returned.

If execution of the command is taking some time

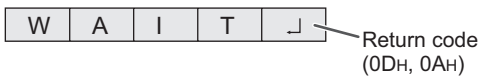

When the following commands are used, “WAIT” is returned. In this case, a value will be returned if you wait a while. Do not send any command during this period.

No ID number is attached to WAIT response.

- Commands which return WAIT:
 1. When repeater control is used
 2. When an IDSL or IDLK command is used
 3. When one of the following commands is used: RSET, INPS, ASNC, WIDE, PXSL, POWR, MWIN, MWIP, EMHV, EPHV, ESHV, ENLG, BOMD

Communication interval

- After OK or ERR is returned, you must send the following commands.

To set a timeout for the command response, specify 10 seconds or longer.

When connecting multiple monitors in a daisy chain, set the timeout to at least the product of the monitor’s position from the computer multiplied by 10 seconds.

Example) 3rd monitor from computer: 30 seconds or longer.

- Provide an interval of 100 ms or more between the command response and the transmission of the next command.

VOLM0020

OK

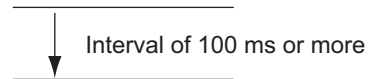

INPS0001

WAIT

OK

TIPS

- When executing ALL RESET, set the timeout period to 30 seconds or longer.
- When turning the power on while the POWER ON DELAY function is in use, set the timeout period to the POWER ON DELAY period + 10 seconds or longer.

Advanced operation

This section explains commands for daisy chain connection. The basic communication procedure is the same as in the “One-to-one connection with a PC” section.

ID numbers

You can assign a unique ID number to each monitor (see page 23). This allows you to control a particular monitor in a daisy chain of monitors.

You can assign ID numbers either from the menu screen or from the PC using RS-232 cable.

[Example]

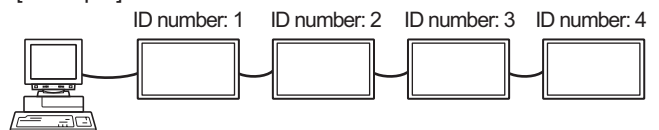

If monitors are connected as shown above, you can execute commands like “Set the volume of the monitor with ID 4 to 20”.

When designating ID numbers for a set of monitors linked in a daisy chain, you should basically avoid any duplication of ID numbers.

ID numbers do not have to be assigned in ascending order starting from the PC. They can also be connected as shown below.

[Example]

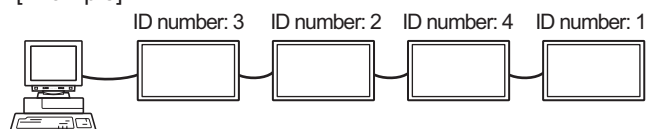

Controlling the Monitor with a PC (RS-232C)

■ Commands for ID control

The command examples shown on this page assume the following connection and ID number set up.

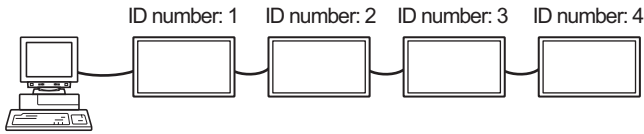

IDSTA monitor receiving this command sets its own ID number in the parameter field.

Example:

IDST0001

OK _ 001 ← The ID number of this monitor is set to 1.

TIPS

You can automatically assign ID numbers by using the IDST command with the Repeater control (see “Repeater control” on page 33).

For example, using the command “IDST001+” automatically sets the ID numbers, as shown below.

[Example]

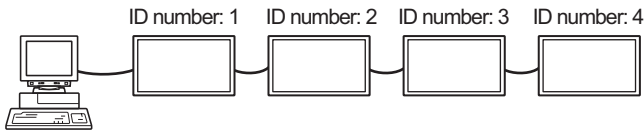

IDST001 + ← ID setting command with repeater control

WAIT

OK _ 001 ← “OK” response from ID number: 1

OK _ 002 ← “OK” response from ID number: 2

OK _ 003 ← “OK” response from ID number: 3

OK _ 004 ← “OK” response from ID number: 4 (End)

IDSLThe parameter of this command sets the ID number of the monitor. The monitor is subject to the next command.

Example:

IDSL0002 ← The next command is for the monitor with ID number: 2.

WAIT ← Searching for monitor with ID number: 2

OK _ 002 ← Found monitor with ID number: 2

VOLM0030 ← Sets volume of monitor with ID number: 2 to 30.

WAIT ← Processing

OK _ 002 ← OK response from monitor with ID number: 2

VOLM0020 ← Sets volume to 20.

OK _ 001 ← The volume of the monitor with ID number: 1 (the one directly connected to the PC) is set to 20.*

* The IDSL command is effective only once, for the immediately succeeding command.

IDLKThe parameter of this command sets the ID number of the monitor. The monitor is subject to all subsequent commands.

Example:

IDLK0002 ← Following commands are for the monitor with ID number: 2.

WAIT ← Searching for monitor with ID number: 2

OK _ 002 ← Found monitor with ID number: 2

VOLM0030 ← Sets volume of monitor with ID number: 2 to 30.*

WAIT ← Processing

OK _ 002

VOLM0020 ← Sets volume of monitor with ID number: 2 to 20.*

WAIT

OK _ 002

IDLK0000 ← Canceling fixed ID number setting

WAIT ← Canceling IDLK

OK _ 002 ← Cancellation complete

VOLM0010

OK _ 001 ← The volume of the monitor with ID number: 1 (the one directly connected to the PC) is set to 10. (IDLK is canceled.)

* The IDLK command remains effective until it is canceled, or power is shut off.

■ Repeater control

This system has a function to allow setting of multiple monitors connected in a daisy chain using a single command. This function is called repeater control. You can use Repeater control function without assigning ID numbers.

[Example]

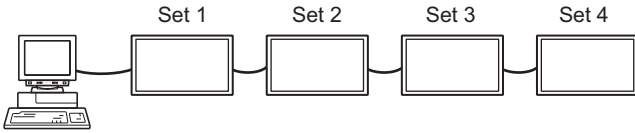

* If monitors are connected as shown above, you can execute a command like "Set all monitors' input settings to D-SUB".

■ Repeater control command

Repeater control is achieved by setting the FOURTH CHARACTER of the parameter to "+".

Example:

VOLM030 + ← Sets volume of all monitors to 30.

In repeater control, responses are returned by all the connected monitors.

If you want to determine that a value has been returned by a specific set, assign ID numbers to each monitor in advance. When some monitors do not return their responses, the probable cause is that the monitors could not receive the command or command processing is not complete. Do not send a new command.

Example: (When 4 monitors are connected, and assigned ID numbers: 1 through 4)

```
VOLM030 +
WAIT
OK _ 001
OK _ 002
OK _ 003
OK _ 004 ← If 4 monitors are connected in
             a chain, reliable operation can
             be ensured by sending a new
             command only after a reply
             has been returned by 4th (last)
             monitor.
```

Repeater control can also be used for reading settings.

Example:

```
VOLM ??? +
WAIT
10 _ 001
20 _ 002
30 _ 003
30 _ 004
```

Volume settings for all monitors are returned.

TIPS

- If repeater control is used during ID designation (IDSL, IDLK), the ID designation is canceled.

Controlling the Monitor with a PC (RS-232C)

RS-232C command table

How to read the command table

- Command: Command field (See page 30.)
 Direction: W When the "Parameter" is set in the parameter field (see page 30), the command functions as described under "Control/Response Contents".
 R The returned value indicated under "Reply" can be obtained by setting "????", "____?" or "???" (repeater control) in the parameter field (see page 30).
 Parameter: Parameter field (See page 30.)
 Reply: Response (Returned value)
 * : "o" indicates a command which can be used in power standby mode.
 "—" indicates a command which cannot be used in power standby mode.
 (When STANDBY MODE is STANDARD. When set to LOW POWER, RS-232C commands cannot be used.)

Power control/Input mode selection

Function	Command	Direction	Parameter	Reply	Control/Response contents	*
POWER CONTROL	POWR	W	0		Switches to standby mode.	
			1		Returns from standby mode.	
		R	0		Standby mode	
			1		Normal mode	
			2		Input signal waiting mode	
INPUT MODE SELECTION	INPS	W	0		Toggle change for input mode.	
			1		DVI-D	
			2		D-SUB	
			3		COMPONENT	
			4		VIDEO	
			9		HDMI	
			14		DisplayPort	
		R	1		DVI-D	
			2		D-SUB	
			3		COMPONENT	
			4		VIDEO	
			9		HDMI	
			14		DisplayPort	

SCREEN menu

Function	Command	Direction	Parameter	Reply	Control/Response contents	*	
AUTO	ASNC	W	1		When the input mode is D-SUB.	-	
SELF ADJUST	AADJ	WR	0-1	0-1	0: OFF, 1: ON	o	
CLOCK	CLCK	WR	0-100	0-100	When the input mode is D-SUB.		
PHASE	PHSE	WR	0-100	0-100	When the input mode is D-SUB.		
POSITIONING	POSITION OF THE LONGEST DIRECTION	HPOS	WR	0-100	0-100	When the input mode is D-SUB.	
	POSITION OF THE SHORTEST DIRECTION	VPOS	WR	0-100	0-100	When the input mode is D-SUB.	
SIZE (DVI-D, DisplayPort, D-SUB)	WIDE	WR	1-3,6	1-3,6	1: WIDE, 2: NORMAL, 3: Dot by Dot, 6: CUSTOM		
SIZE (HDMI, COMPONENT, VIDEO)	WIDE	WR	1,4-6	1,4-6	1: WIDE, 4: NORMAL, 5: Dot by Dot, 6: CUSTOM		
CUSTOM ZOOM	ZOOM	CZSZ	WR	0-100	0-100		
	SIZE OF THE LONGEST DIRECTION	CZHS	WR	0-100	0-100		
	SIZE OF THE SHORTEST DIRECTION	CZVS	WR	0-100	0-100		
	POSITION OF THE LONGEST DIRECTION	CZHP	WR	0-100	0-100	When the input mode is D-SUB.	
	POSITION OF THE SHORTEST DIRECTION	CZVP	WR	0-100	0-100	When the input mode is D-SUB.	
INPUT RESOLUTION (DVI-D, DisplayPort, D-SUB)	RESOLUTION CHECK	PXCK	R		-	Returns current resolution in the form of hhh, vvv.	
	PIXEL SETTING (D-SUB)	PXSL	WR	1	1	768) 1360 x 768	
				2	2	768) 1280 x 768	
				3	3	768) 1024 x 768	
				7	7	1050) 1680 x 1050	
				8	8	1050) 1400 x 1050	
				9	9	768) AUTO	
				11	11	1200) 1920 x 1200	
				12	12	1200) 1600 x 1200	
				13	13	1050) AUTO	
14	14	1200) AUTO					
INPUT RESOLUTION (HDMI, COMPONENT, VIDEO)	RESOLUTION CHECK	RESO	R		-	480i, 480p, 1080i, 720p, 1080p, etc.	
RESET	ARST	W	1				

PICTURE menu

Function		Command	Direction	Parameter	Reply	Control/Response contents	*	
BRIGHT		VLMP	WR	0-31	0-31			
CONTRAST		CONT	WR	0-100	0-100			
BLACK LEVEL		BLVL	WR	0-100	0-100			
TINT (HDMI, COMPONENT, VIDEO)		TINT	WR	0-100	0-100			
COLORS (HDMI, COMPONENT, VIDEO)		COLR	WR	0-100	0-100			
SHARPNESS		SHRP	WR	0-100	0-100			
COLOR ADJUSTMENT	COLOR MODE	BMOD	WR	0	0	STD		
				3	3	sRGB (When the input mode is DVI-D, DisplayPort, D-SUB)		
				4	4	HIGH ILLUMINANCE		
	WHITE BALANCE	THRU PRESET	CTMP	WR	0	0		
					1-18	1-18	From 1: approximately 3,000K to 15: approximately 10,000K (500K steps) 16: approximately 5,600K, 17: approximately 9,300K, 18: approximately 3,200K	
		USER			99	99		
		R-GAIN	CRTR	WR	0-256	0-256	"ERR" when CTMP is not set to 99.	
		G-GAIN	CRTG	WR	0-256	0-256		
		B-GAIN	CRTB	WR	0-256	0-256		
		R-OFFSET	OFSR	WR	0-255	0-255		
		G-OFFSET	OFSG	WR	0-255	0-255		
B-OFFSET	OFSB	WR	0-255	0-255				
GAMMA	GAMM	WR	0-2, 5	0-2, 5	0: 1.8, 1: 2.2, 2: 2.4, 5: 2.0			
ADVANCED	NOISE REDUCTION (HDMI, COMPONENT, VIDEO)	TDNR	WR	0-2	0-2	0: OFF, 1: LOW, 2: HIGH		
	HDMI RGB INPUT RANGE (HDMI)	AHDR	WR	1-2	1-2	1: FULL, 2: LIMITED		
RESET		ARST	W	2				

AUDIO menu

Function		Command	Direction	Parameter	Reply	Control/Response contents	*
TREBLE		AUTR	WR	0-100	0-100		
BASS		AUBS	WR	0-100	0-100		
BALANCE		AUBL	WR	0-100	0-100		
RESET		ARST	W	3			

Controlling the Monitor with a PC (RS-232C)

SETUP menu

Function	Command	Direction	Parameter	Reply	Control/Response contents	*	
DATE/TIME SETTING	DATE	WR	AABBCCDDEE	AABBCCDDEE	AA: Year, BB: Month, CC: Day, DD: Hour, EE: Minute		
SCHEDULE	SH01-SH07	WR	ABBCCDDEEF GHIJKLMNO	ABBCCDDEEF GHIJKLMNO	Schedule of a specified number A : Schedule 0= Not effective, 1 = Effective B : Power-on hour 00-23, 99 = Not effective C : Power-on minute 00-59, 99 = Not effective D : Power-off hour 00-23, 99 = Not effective E : Power-off minute 00-59, 99 = Not effective F : Input 0 = Not specified, 1 = DVI-D, 2 = DisplayPort, 3 = HDMI, 4 = D-SUB, 5 = COMPONENT, 6 = VIDEO G : EVERY DAY 0 = OFF, 1 = ON H : EVERY WEEK 0 = OFF, 1 = ON I-O : MON-SUN 0 = OFF, 1 = ON		
LANGUAGE	LANG	WR	14	14	ENGLISH		
			1	1	DEUTSCH		
			2	2	FRANÇAIS		
			3	3	ITALIANO		
			4	4	ESPAÑOL		
			5	5	РУССКИЙ		
INPUT SELECT	HOT PLUG CONTROL (DVI-D)	HPCT	WR	0-1	0-1	0: OFF, 1: ON	
	HOT PLUG CONTROL (HDMI)	HPCH	WR	0-1	0-1	0: OFF, 1: ON	○
AUDIO SELECT	DVI-D	ASDP	WR	1-2	1-2	1: AUDIO1, 2: AUDIO2	
	D-SUB	ASAP	WR	1-2	1-2	1: AUDIO1, 2: AUDIO2	
	HDMI	ASHA	WR	0-2	0-2	0: HDMI, 1: AUDIO1, 2: AUDIO2	
	COMPONENT	ASCA	WR	1-2	1-2	1: AUDIO1, 2: AUDIO2	
	VIDEO	ASVA	WR	1-2	1-2	1: AUDIO1, 2: AUDIO2	
	DisplayPort	ASDI	WR	1-3	1-3	1: AUDIO1, 2: AUDIO2, 3: DisplayPort	
ID SETTING	ID NO.SETTING	IDST	W	0-26		Sets the monitor's ID number. ("0" means "no ID number".)	
					0-26	Returns the monitor's ID number.	
	ID NO. SETTING (ONCE)	IDSL	W	1-26		Sets a monitor ID number. This ID number is only effective for the command immediately after this command.	
				0		Clears the ID number if one has been designated.	
	ID NO. SETTING (SUBSEQUENT)	IDLK	W	1-26		Sets a monitor ID number. This ID number is effective for the next and all subsequent commands after this command.	
0					Clears the ID number if one has been designated.		
INFORMATION	MODEL	INF1	R		Value		
	SERIAL NO	SRNO	R		Value		

MONITOR menu

Function	Command	Direction	Parameter	Reply	Control/Response contents	*
MONITOR	STDR	WR	0-1	0-1	0: LANDSCAPE, 1: PORTRAIT	
OSD H-POSITION	OSDH	WR	0-100	0-100		
OSD V-POSITION	OSDV	WR	0-100	0-100		
STANDBY MODE	STBM	WR	0-1	0-1	0: STANDARD, 1: LOW POWER	
OFF IF NO OPERATION	ATOF	WR	0-1	0-1	0: OFF, 1: ON	○
POWER ON DELAY	PWOD	WR	0-60	0-60	0: OFF, 1-60 seconds	

Controlling the Monitor with a PC (RS-232C)

MULTI/PIP menu

Function	Command	Direction	Parameter	Reply	Control/Response contents	*
ENLARGE	ENLG	WR	0-1	0-1	0: OFF, 1: ON	
ENLARGE MODE	EMHV	WR	11-55	11-55	1 x 1 (OFF) to 5 x 5 ("m x n" is expressed as "mn", where m and n are the numbers of monitors specified for the longest direction and the shortest direction respectively.)	
IMAGE POSITION (M x N)	EPHV	WR	11-55	11-55	Specifies values in the order of IMAGE POSITION IN LONGEST/ SHORTEST DIRECTION.	
BEZEL ADJUST	BZCO	WR	0-1	0-1	0: OFF, 1: ON	
ENLARGE/IMAGE POSITION SETTING	ESHV	WR	XXYY	XXYY	XX: ENLARGE MODE (Same as EMHV), YY: IMAGE POSITION (Same as EPHV)	
PIP MODES	MWIN	WR	0-3	0-3	0: OFF, 1: PIP, 2: PbyP, 3: PbyP2	
PIP SIZE	MWSZ	WR	0-2	0-2	0: SMALL, 1: MIDDLE, 2: LARGE	
PIP POS	THE LONGEST DIRECTION	MHPS	W	0-100		
			R		0-100	
	THE SHORTEST DIRECTION	MVPS	W	0-100		
			R		0-100	
PIP POS LD+SD BATCH	MPOS	W	0-100,0-100		Specify the position in MPOSxxxxyy format. (xxx: Longer side, yyy: Shorter side position)	
		R		0-100,0-100	Returns a response in (xxx,yyy) format. (xxx: Longer side, yyy: Shorter side position)	
PIP SOURCE	MWIP	WR	1	1	DVI-D	
			2	2	D-SUB	
			3	3	COMPONENT	
			4	4	VIDEO	
			9	9	HDMI	
			14	14	DisplayPort	
SOUND CHANGE	MWAD	WR	1-2	1-2	1: MAIN, 2: SUB	

OTHERS menu

Function	Command	Direction	Parameter	Reply	Control/Response contents	*
SCREEN MOTION	MTIM	WR	0-900	0-900	0: OFF, 10-900: Operating interval (Per 10 senconds)	
POWER MANAGEMENT (DisplayPort, HDMI, DVI-D, D-SUB)	PMNG	WR	0-1	0-1	0: OFF, 1: ON	
POWER MANAGEMENT (COMPONENT, VIDEO)	PMAV	WR	0-1	0-1	0: OFF, 1: ON	
LOGO SCREEN	BTSC	WR	0-1	0-1	0: OFF, 1: ON	
SCAN MODE	SCAN	WR	0-1	0-1	0: OVERSCAN, 1: UNDERSCAN (When the input mode is HDMI)	
BACKLIGHT OFF	BOMD	W	0-1		0: Enters BACKLIGHT OFF mode, 1: Exits BACKLIGHT OFF mode	
		R		0-1	0: BACKLIGHT OFF mode, 1: Normal operation state	
COLOR SYSTEM (VIDEO)	CSYS	WR	0-5	0-5	0: AUTO, 1: PAL, 2: PAL-60, 3: SECAM, 4: NTSC3.58, 5: NTSC4.43	

Initialization/Functional Restriction Setting (FUNCTION) menu

Function	Command	Direction	Parameter	Reply	Control/Response contents	*
ALL RESET	RSET	W	1		1: ALL RESET	
ADJUSTMENT LOCK	ALCK	WR	0-1	0-1	0: OFF, 1: ON	
OSD DISPLAY	LOSD	WR	0-1	0-1	0: ON, 1: OFF	
LED	OFLD	WR	0-1	0-1	0: ON, 1: OFF	

Controlling the Monitor with a PC (RS-232C)

Others

Function	Command	Direction	Parameter	Reply	Control/Response contents	*
VOLUME	VOLM	WR	0-31	0-31		○
MUTE	MUTE	WR	0-1	0-1	0: OFF, 1: ON	-
TEMPERATURE SENSOR	DSTA	R		0	Internal temperature normal	
				1	Internal temperature abnormal has occurred and the monitor is in standby mode	
				2	Internal temperature abnormal occurred (To delete the information of temperature abnormal, turn off the main power.)	
				3	Internal temperature abnormal has occurred and backlight brightness is dimmed	
				4	Temperature sensor abnormal	
TEMPERATURE ACQUISITION	ERRT	R		Value	Returns the temperature at the temperature sensors in the following format. [Sensor 1] [Sensor 2] Indicates a temperature sensor abnormality when "126" is returned.	
CAUSE OF LAST STANDBY MODE	STCA	W	0		Initialization	○
		R	0	No detectable error has occurred		
			1	Standby mode by POWER button		
			2	Main power off by the main power switch		
			3	Standby mode by RS-232C or LAN		
			4	Input signal waiting mode by No Signal		
			6	Standby mode by abnormal temperature		
			8	Standby mode by SCHEDULE setting		
			20	Standby mode by OFF IF NO OPERATION setting		

TIPS

- With some commands, the settings of an item are not continuous. In that case, the entered parameter will be set to the closest setting.
(Example) When the settings are "...45, 50, 55..." :
The entered parameter is "50", "51", or "52", "50" is set.
The entered parameter is "53", "54", or "55", "55" is set.
- With some commands, the number set in the menu screen may differ from the number of the parameter.

Controlling the Monitor with a PC (LAN)

Your monitor can be connected to a LAN allowing you to control it from a PC on the LAN.

The connection requires a commercially available LAN cable (UTP cable, Category 5, straight through).

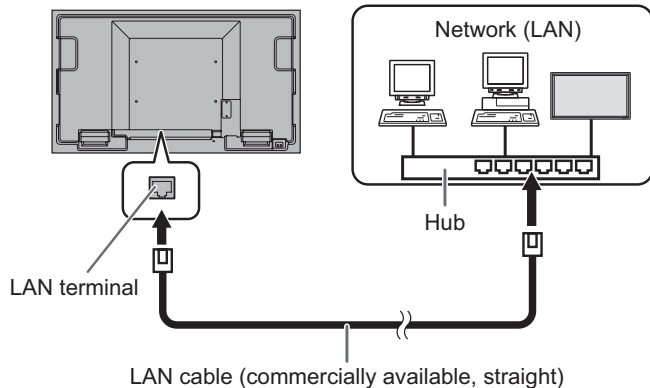

TIPS

- You must assign an IP address to the monitor by following the procedures in "Settings to connect to a LAN". (See the description on the right.)
- Your PC must be installed with Internet Explorer (version 7.0 or later).
 - Version 7, 8, or 9 of Internet Explorer is recommended.
 - Use Internet Explorer Version 10 in compatibility mode.
- To control the monitor via LAN, set RS-232C/LAN SELECT to LAN, and STANDBY MODE to STANDARD.
- You cannot use RS-232C and LAN control simultaneously.

Settings to connect to a LAN

Set the monitor's IP address and subnet mask to match the settings of your LAN.

These settings can be made on either the monitor or a PC connected to the monitor.

The settings depend on the configuration of your LAN. Ask your LAN administrator for details.

■ To set on the monitor

Set RS-232C/LAN SELECT of COMMUNICATION SETTING on the SETUP menu to LAN, and then set the LAN SETUP options. (See page 23.)

After setting each item, press .

DHCP CLIENT

If your LAN has a DHCP server and you wish to obtain an address automatically, change this setting to ON.

To set the address manually, set this to OFF.

IP ADDRESS

If the DHCP CLIENT is set to OFF, specify an IP address.

Press or to select items, and press or to change the values.

SUBNET MASK

If the DHCP CLIENT is set to OFF, specify the subnet mask.

Press or to select items, and press or to change the values.

DEFAULT GATEWAY

If the DHCP CLIENT is set to OFF, specify the default gateway.

If you are not using a gateway, specify "000.000.000.000".

Press or to select items, and press or to change the values.

Controlling the Monitor with a PC (LAN)

■ To set from a PC

When the monitor is connected to a PC, LAN settings can be configured via PC.

Set up process

- (1) Connect your monitor to a PC
- (2) Specify the PC's IP address
- (3) Configure the monitor's LAN settings

(1) Connecting your monitor to a PC

Connect a commercially available crossover LAN cable (UPT cable, Category 5) to the LAN port on the PC and this monitor.

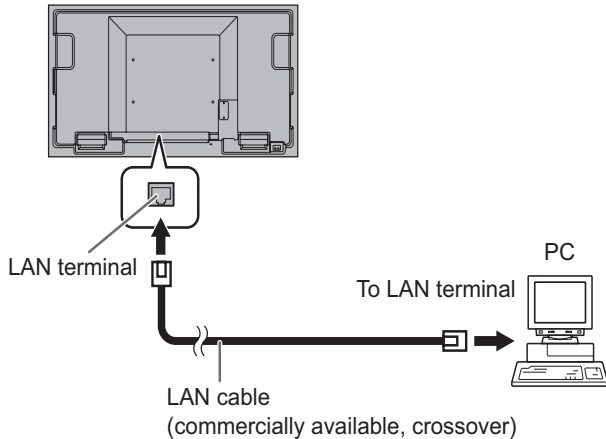

(2) Specifying the PC's IP address

To configure the monitor's LAN settings, you must temporarily change the settings on the PC.

This explanation is based on Windows 7.

1. Log on to the PC with an administrator account.
2. Click [Start], and then click "Control Panel".
3. Click "View network status and tasks" in "Network and Internet".
- In "Classic View", click "Network and Sharing Center".
4. Click "Local Area Connection" and then "Properties".
5. Click "Internet Protocol Version 4 (TCP/IPv4)" and then "Properties".
6. Make a note of the current IP address, subnet mask, and default gateway settings.

Make sure you write this information now as you will be changing the IP address, subnet mask, and default gateway settings back to these settings afterwards.

7. Temporarily change the IP address and subnet mask. To access the monitor as it is shipped from the factory, set as follows.

- IP Address: 192.168.150.1
- Subnet Mask: 255.255.255.0
- Default Gateway: (leave blank)

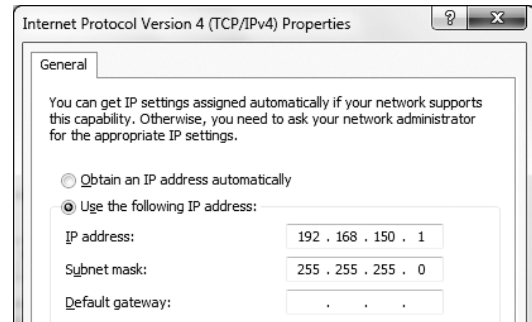

8. Click [OK] and then reboot the PC.

TIPS

- This monitor is factory preset as shown below. (When DHCP CLIENT is set to OFF)
IP Address : 192.168.150.2
Subnet Mask : 255.255.255.0
Default Gateway : 0.0.0.0

(3) Configuring the monitor's LAN settings

Access the monitor using Internet Explorer.

Controlling the monitor

1. Turn the power ON to the monitor.
2. Set RS-232C/LAN SELECT of COMMUNICATION SETTING on the SETUP menu to LAN.
3. Set DHCP CLIENT of LAN SETUP of COMMUNICATION SETTING on the SETUP menu to OFF.

PC operation

4. Launch Internet Explorer, in the "Address" box type "http://192.168.150.2/" and press the Enter key.



5. Leave the "Username" and "Password" boxes blank and click [Login].

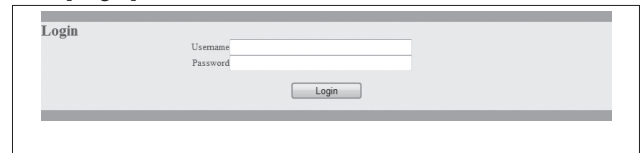

6. Click SETUP.

. SCREEN . PICTURE . AUDIO [SETUP] . MONITOR . MULTI/PIP . OTHERS . SNMP . FUNCTION	<p style="text-align: center;">SCREEN</p> <p>AUTO ▶</p> <p>SELF ADJUST ON ▾</p> <p>CLOCK 47</p> <p>PHASE 0</p> <p>H-POS 50</p> <p>V-POS 50</p> <p>SIZE WIDE ▾</p> <p>CUSTOM ZOOM ▶</p> <p>INPUT RESOLUTION AUTO ▾</p> <p>RESET ▶</p>
--	---

7. Click [▶] next to LAN SETUP.

. SCREEN . PICTURE . AUDIO . SETUP . MONITOR . MULTI/PIP . OTHERS . SNMP . FUNCTION	<p style="text-align: center;">SETUP</p> <p>DATE/TIME SETTING ▶</p> <p>SCHEDULE ▶</p> <p>LANGUAGE English ▾</p> <p>HOT PLUG CONTROL ▶</p> <p>AUDIO SELECT AUDIO1 ▾</p> <p>LAN SETUP ▶</p> <p>ID No. SET 0 (0-29)</p> <p>INFORMATION ▶</p>
---	---

8. Specify the DHCP CLIENT, IP ADDRESS, etc.

. SCREEN . PICTURE . AUDIO . SETUP . MONITOR . MULTI/PIP . OTHERS . SNMP . FUNCTION	<p style="text-align: center;">LAN SETUP</p> <table border="1"> <tr> <td>DHCP CLIENT</td> <td>Off ▾</td> </tr> <tr> <td>IP ADDRESS</td> <td>192.168.150.2</td> </tr> <tr> <td>SUBNET MASK</td> <td>255.255.255.0</td> </tr> <tr> <td>DEFAULT GATEWAY</td> <td>0.0.0.0</td> </tr> </table> <p style="text-align: right;"><input type="button" value="Apply"/></p>	DHCP CLIENT	Off ▾	IP ADDRESS	192.168.150.2	SUBNET MASK	255.255.255.0	DEFAULT GATEWAY	0.0.0.0
DHCP CLIENT	Off ▾								
IP ADDRESS	192.168.150.2								
SUBNET MASK	255.255.255.0								
DEFAULT GATEWAY	0.0.0.0								

DHCP CLIENT

If your LAN has a DHCP server and you wish to obtain an address automatically, change this setting to ON. To set the address manually, set this to OFF.

IP ADDRESS

If the DHCP CLIENT is set to OFF, specify an IP address.

SUBNET MASK

If the DHCP CLIENT is set to OFF, specify the subnet mask.

DEFAULT GATEWAY

If the DHCP CLIENT is set to OFF, specify the default gateway. If you are not using a default gateway, specify "0.0.0.0".

9. When the setting is changed, click [Apply].

10. Exit Internet Explorer.

11. Restore the PC's IP address jotted in Step 6, "(2) Specifying the PC's IP address".

12. Connect the monitor and the PC to the LAN.

Controlling with a PC

Basic operation

You use Internet Explorer on a PC on the LAN to control the monitor.

1. Launch Internet Explorer on the PC.
2. In the "Address" box, type "http://" followed by your monitor's IP address followed by "/", then press the Enter key.



3. Enter in "Username" and in "Password", and click [Login].

<p style="text-align: center;">Login</p> <p>Username <input type="text"/></p> <p>Password <input type="password"/></p> <p style="text-align: center;"><input type="button" value="Login"/></p>

Enter the user name and password set in SECURITY. If you did not make any SECURITY settings, leave the spaces blank and click on [Login].

4. You can configure settings in each setting screen.

. SCREEN . PICTURE . AUDIO . SETUP . MONITOR . MULTI/PIP . OTHERS . SNMP . FUNCTION	<p style="text-align: center;">SCREEN</p> <p>AUTO ▶</p> <p>SELF ADJUST ON ▾</p> <p>CLOCK 47</p> <p>PHASE 0</p> <p>H-POS 50</p> <p>V-POS 50</p> <p>SIZE WIDE ▾</p> <p>CUSTOM ZOOM ▶</p> <p>INPUT RESOLUTION AUTO ▾</p> <p>RESET ▶</p>
---	---

TIPS

- You cannot operate the monitor while it is warming up.

Controlling the Monitor with a PC (LAN)

■ PC operation

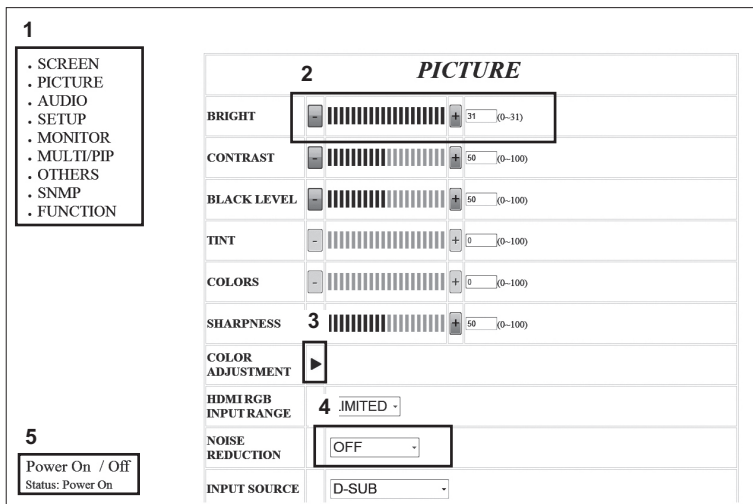

1. Display a setting screen.
2. Click [+][-] to adjust. If there is a text box, you can also directly enter a number.
3. Click [▶] and adjust in the screen that appears.
4. Click and select an item from the menu that appears.
5. Click to turn the power on/off.

* Make sure that the setting is applied before performing the next step. If clicked repeatedly, the setting may not be properly applied.

For details on each item, see below.

SCREEN	Page 21
PICTURE	Page 22
INPUT SOURCE	Page 18
AUDIO	Page 23
VOLUME	Page 18
SETUP	Page 23
SCHEDULE	Page 27
LAN SETUP	Page 43
MONITOR	Page 24
MULTI/PIP	Page 24
OTHERS	Page 25
SNMP	Page 43
FUNCTION	Page 29

LAN SETUP / SECURITY / GENERAL

This screen allows you to set the settings necessary when the monitor is connected to a LAN.

<ul style="list-style-type: none"> . SCREEN . PICTURE . AUDIO . SETUP . MONITOR . MULTI/PIP . OTHERS . SNMP . FUNCTION 	<h3>LAN SETUP</h3>
DHCP CLIENT: <input type="text" value="OFF"/>	
IP ADDRESS: <input type="text" value="192.168.150.2"/>	
SUBNET MASK: <input type="text" value="255.255.255.0"/>	
DEFAULT GATEWAY: <input type="text" value="0.0.0.0"/>	
[Apply]	
<h3>SECURITY</h3>	
USERNAME: <input type="text" value=""/> (MAX 16 characters(A-Z,a-z,0-9,_)	
PASSWORD: <input type="text" value=""/> (MAX 16 characters(A-Z,a-z,0-9,_)	
Confirm PASSWORD: <input type="text" value=""/>	
[Apply]	
<h3>GENERAL</h3>	
AUTO LOGOUT TIME: <input type="text" value="5"/> (from 1 to 65535) Set 0 to disable this function.	
DATA PORT: <input type="text" value="10008"/> (from 1025 to 65535)	
SEARCH PORT: <input type="text" value="5006"/> (from 1025 to 65535)	
[Apply]	
Power On / Off Status: Power On	

DHCP CLIENT

If your LAN has a DHCP server and you wish to obtain an address automatically, change this setting to ON. To set the address manually, set this to OFF.

IP ADDRESS

If the DHCP CLIENT is set to OFF, specify an IP address.

SUBNET MASK

If the DHCP CLIENT is set to OFF, specify the subnet mask.

DEFAULT GATEWAY

If the DHCP CLIENT is set to OFF, specify the default gateway. If you are not using a default gateway, specify "0.0.0.0".

USER NAME / PASSWORD / Confirm PASSWORD

Sets up a user name and password to restrict access to this monitor.

For confirmation, reenter the password you entered in PASSWORD in Confirm PASSWORD.

AUTO LOGOUT TIME

Specify the time (in minutes) to elapse before automatically disconnecting this monitor from the network. Specify in minutes from 1 to 65535. A value of '0' will disable this function.

DATA PORT

Specify the TCP port number to use for exchanging data with the monitor. Specify a value from 1025 to 65535.

SEARCH PORT

Specify the port number to use when searching for this monitor. Specify a value from 1025 to 65535.

TIPS

- After you have changed the settings, click [Apply].
- After you have changed the settings in DATA PORT and SEARCH PORT, click [Reboot].

SNMP

You can configure settings related to SNMP.

<ul style="list-style-type: none"> . SCREEN . PICTURE . AUDIO . SETUP . MONITOR . MULTI/PIP . OTHERS . SNMP . FUNCTION 	<h3>SNMP - GENERAL</h3>
SNMP SETTING: <input type="text" value="OFF"/>	
COMMUNITY NAME 1: <input type="text" value=""/> (MAX 16 characters) <input type="text" value="Read"/>	
COMMUNITY NAME 2: <input type="text" value=""/> (MAX 16 characters) <input type="text" value="Read"/>	
COMMUNITY NAME 3: <input type="text" value=""/> (MAX 16 characters) <input type="text" value="Read"/>	
[Apply]	
<h3>SNMP - TRAP</h3>	
TRAP SETTING: <input type="text" value="OFF"/>	
TRAP SETTING OF AUTHENTICATION ERROR: <input type="text" value="OFF"/>	
TRAP ADDRESS & PORT	TRAP 1 ADDRESS: <input type="text" value="0.0.0.0"/> PORT: <input type="text" value="0"/>
	TRAP 2 ADDRESS: <input type="text" value="0.0.0.0"/> PORT: <input type="text" value="0"/>
	TRAP 3 ADDRESS: <input type="text" value="0.0.0.0"/> PORT: <input type="text" value="0"/>
	TRAP 4 ADDRESS: <input type="text" value="0.0.0.0"/> PORT: <input type="text" value="0"/>
TEST	
[Apply]	
Power On / Off Status: Power On	

SNMP SETTING

Set whether to enable or disable SNMP.

COMMUNITY NAME 1 to 3

Set the name of the community required for the access.

TRAP SETTING

Set whether to enable or disable the trap function. When this function is enabled, a trap will be sent when the monitor is turned on.

TRAP SETTING OF AUTHENTICATION ERROR

Set whether the trap function sends a notification when authentication fails.

TRAP ADDRESS & PORT

Set the destination address and port number of the notification sent by the trap function.

TIPS

- After you have changed the settings, click [Apply].

“Advanced operation”

Command-based control

You can control the monitor using RS-232C commands (see page 34) via terminal software and other appropriate applications.

In order to use this function, enable a connection to the monitor through Internet Explorer.

Read the manual for the terminal software for detailed instructions.

(1) Connect the PC to the monitor.

1. Specify the IP address and data port number and connect the PC to the monitor.
When connection has been established successfully, [Login:] is returned as response.
2. Send the user name set in the SECURITY settings (see page 43).
 - Send [User name] + [].
 - If the user name is not set, send [].
 - When the transmission is successful, [Password:] is returned as response.
3. Send the password set in the SECURITY settings (see page 43).
 - Send [Password] + [].
 - If the password is not set, send [].
 - When the transmission is successful, [OK] is returned as response.

(2) Send commands to control the monitor.

- The commands used are the same as those for RS-232C. Refer to the communication procedure (see page 30) for operation.
- Usable commands are provided in the RS-232C command table (see page 34).

(3) Disconnect the connection with the monitor and quit the function.

1. Send [BYE].
When the transmission is successful, [goodbye] is returned and the connection is disconnected.

TIPS

- Connection is automatically disconnected when the time specified in AUTO LOGOUT TIME elapses over a no-communication period.

Troubleshooting

If you are experiencing any problem with your display, before calling for service, please review the following troubleshooting tips.

There is no picture or sound.

- Is the power cord disconnected? (See page 13.)
- Is the main power switch off? (See page 16.)
- Is the monitor in standby mode (the power LED illuminating in orange)? (See page 16.)
- Make sure correct input mode is selected. (See page 18.)
- If any external equipment is connected, make sure the equipment is operating (playing back).

Remote control does not work.

- Are the batteries inserted with polarity (+,-) aligned? (See page 15.)
- Are the batteries exhausted?
- Point the remote control unit toward the monitor's remote control sensor. (See page 15.)
- Is the menu display hidden or is operation disabled? (See page 29.)

Sound from left and right speakers is reversed.

Sound is heard from only one side.

- Are audio cables connected properly?
- Check the setting of BALANCE for AUDIO menu. (See page 23.)

There is a picture but no sound.

- Is the sound muted?
- Make sure the volume is not set to minimum.
- Are audio cables connected properly?
- Is the setting of AUDIO SELECT on the SETUP menu correct? (See page 23.)

Unstable video.

- The signal may be incompatible.
- Try the automatic screen adjustment when the D-SUB is used.

The video from the HDMI input terminal does not appear properly.

- Is the HDMI cable HDMI standard compliant? The monitor will not work with cables that are not standard compliant.
- Is the input signal compatible with this monitor? (See page 51.)

The video from the DVI-D input terminal does not appear properly.

- Is the input signal compatible with this monitor? (See page 51.)
- Turn off the power to the connected equipment and then turn the power on again.
- If the monitors are connected in a daisy chain, turn off the power to all the monitors connected in a daisy chain and then turn the power on again.

The video from D-Sub input terminal does not appear properly.

- Is the input signal compatible with this monitor? (See page 51.)

The video from the DisplayPort does not appear properly.

- Is the input signal compatible with this monitor? (See page 51.)

The video from component input terminals does not appear properly.

- Is the video cable (Y/Cb/Cr) connected correctly?
- Is the input mode set to COMPONENT?
The video will not appear correctly if the input mode is set to VIDEO.

The video from video input terminal does not appear properly.

- Is the input mode set to VIDEO?
The video will not appear correctly if the input mode is set to COMPONENT.

Control buttons do not work.

There is no picture.

- Load noises from outside may be interfering with normal operation. Turn off the power and turn it on after waiting at least 5 seconds, and then check the operation.

The monitor makes a cracking sound.

- You may occasionally hear a cracking sound from the monitor. This happens when the cabinet slightly expands and contracts according to change in temperature. This does not affect the monitor's performance.

Troubleshooting

The Power LED is flashing in red and green alternately.

- When the internal temperature of the monitor rises excessively, the brightness of the backlight decreases automatically in order to prevent high-temperature-related problems. When this occurs, the Power LED flashes red and green alternately.
- If the internal temperature rises further, the monitor automatically enters standby mode. (The Power LED continues flashing red and green alternately.)
- Remove the cause of the excessive temperature rise.
 - If the monitor enters standby mode due to a rise in temperature, to return to normal display, turn the power switch off and then back on again. The monitor, however, will enter standby mode again if the cause of the temperature rise is not eliminated. (See page 7.)
 - Check whether the monitor is placed at a location where a quick rise in temperature is likely. Internal temperature rises quickly if the vents on the monitor are blocked.
 - Internal temperature rises quickly if dust accumulates inside the monitor or around the vents. Remove dust if possible. Ask SHARP dealer about removing internal dust.

Specifications

■Product Specifications

Model	PN-U553	PN-U473	PN-U423
LCD component	55" Class [54-5/8 inch (138.8cm) diagonal] TFT LCD	47" Class [46-15/16 inch (119.3cm) diagonal] TFT LCD	42" Class [42 inch (106.7cm) diagonal] TFT LCD
Max. resolution (pixels)	1920 x 1080		
Max. colors	Approx. 1.06 billion colors		
Pixel pitch	0.630 mm (H) × 0.630 mm (V)	0.542 mm (H) × 0.542 mm (V)	0.485 mm (H) × 0.485 mm (V)
Viewing angle	178° right/left/up/down (contrast ratio ≥ 10)		
Screen active area inch (mm)	47-5/8 (W) x 26-13/16 (H) (1209.6 x 680.4)	40-15/16 (W) x 23 (H) (1039.7 x 584.8)	36-5/8 (W) x 20-5/8 (H) (930.2 x 523.3)
Computer input signal	Digital (DVI 1.0 standard-compliant), Analog RGB (0.7 Vp-p) [75 Ω], DisplayPort 1.1		
Sync signal	Horizontal/vertical separate (TTL: positive/negative)		
Video color system	NTSC (3.58MHz)/NTSC (4.43MHz)/PAL/PAL-60/SECAM		
Plug and play	VESA DDC2B		
Power management	VESA DPMS, DVI DMPM		
Input terminals	PC/AV	HDMI x 1	
	PC	Mini D-sub 15 pin, 3 rows x 1 DisplayPort x 1 DVI-D 24 pin (HDCP compatible) x 1	
	AV	Component: BNC (Y, Cb/Pb, Cr/Pr) x 1*1 Composite video: BNC x 1*1	
	Audio	3.5 mm mini stereo jack x 1 RCA pin (L/R) x 1	
	Serial (RS-232C)	D-sub 9 pin x 1	
Output terminals	PC	DVI-D 24 pin (HDCP compatible) x 1	
	Audio	RCA pin (L/R) x 1	
	Serial (RS-232C)	D-sub 9 pin x 1	
LAN terminal	10 BASE-T/100 BASE-TX		
Speaker output	10 W + 10 W		
Power requirement	AC 100 - 240 V, 1.5 A, 50/60 Hz	AC 100 - 240 V, 1.5 A, 50/60 Hz	AC 100 - 240 V, 1.3 A, 50/60 Hz
Operating temperature *2	41°F to 104°F (5°C to 40°C) *3	32°F to 104°F (0°C to 40°C)	
Operating humidity	20% to 80% (no condensation)		
Power consumption (Input signal waiting mode / standby mode *4)	130 W (4.5 W / 4.5 W)	130 W (4.5 W / 4.5 W)	115 W (4.5 W / 4.5 W)
Dimensions (excluding protrusions) inch (mm)	Approx. 49-3/16 (W) x 2-1/4 (D) x 28-3/8 (H) (1250 x 57 x 721)	Approx. 42-5/8 (W) x 2-3/16 (D) x 24-11/16 (H) (1083 x 55 x 627)	Approx. 38-5/16 (W) x 2-1/4 (D) x 22-1/4 (H) (973 x 57 x 565)
Weight lbs. (kg)	Approx. 55.2 (25)	Approx. 41.9 (19)	Approx. 35.3 (16)

*1 Cannot be used simultaneously.

*2 Temperature condition may change when using the monitor together with the optional equipments recommended by SHARP. In such cases, please check the temperature condition specified by the optional equipments.

*3 Use of the monitors in temperatures below 50°F (10°C) might result in inconsistent image quality that, depending on the viewing angle, might be noticeable along the edges of the screen. Please note that this is not a malfunction and does not affect monitor operation.

*4 When STANDBY MODE is set to STANDARD. When STANDBY MODE is set to LOW POWER: 0.5 W

As a part of our policy of continuous improvement, SHARP reserves the right to make design and specification changes for product improvement without prior notice. The performance specification figures indicated are nominal values of production units. There may be some deviations from these values in individual units.

Specifications

■ Dimensional Drawings

Note that the values shown are approximate values.

[PN-U553]

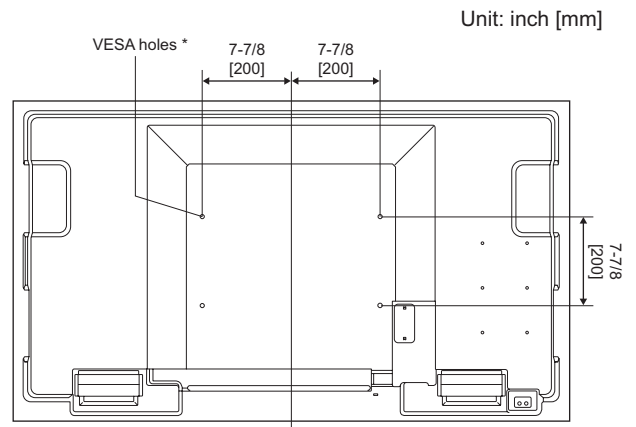
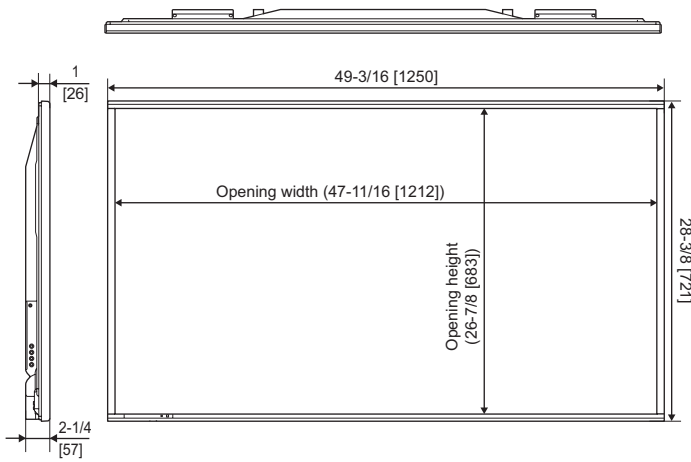

[PN-U473]

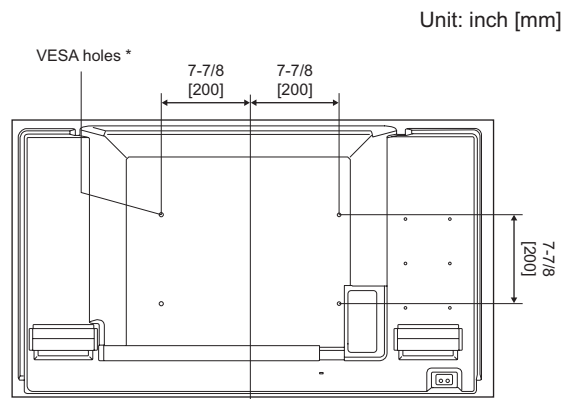
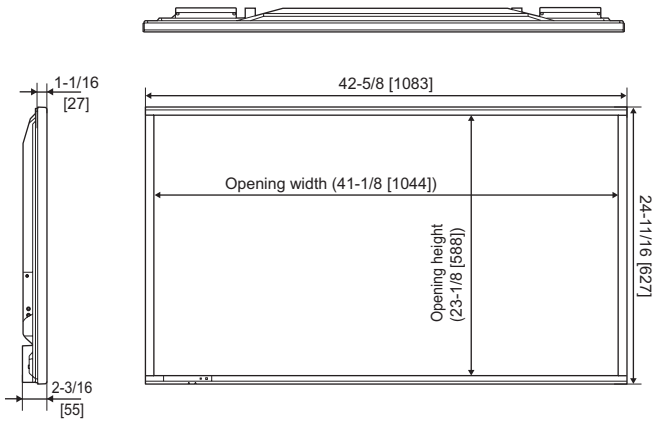

[PN-U423]

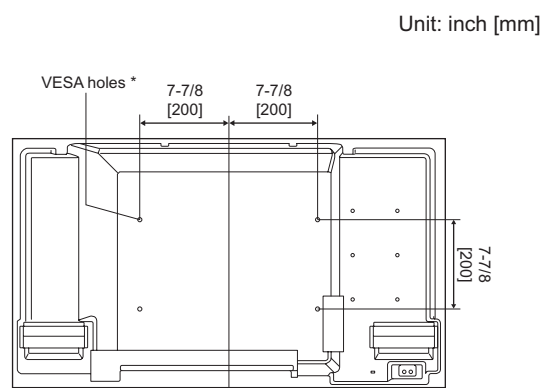
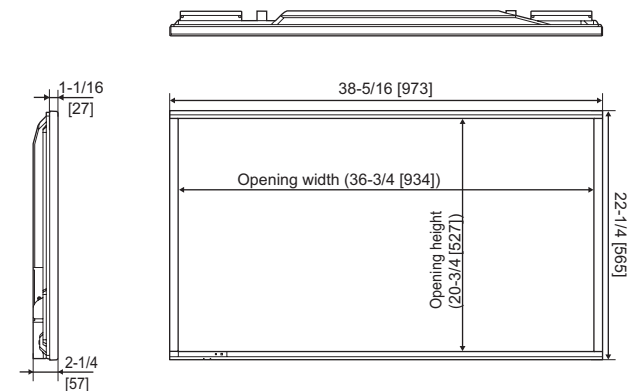

When mounting the monitor, be sure to use a wall-mount bracket that complies with the VESA-compatible mounting method. SHARP recommends using M6 screws and tighten the screws. Note that screw hole depth of the monitor is 3/8 inch (10 mm). Loose mounting may cause the product to fall, resulting in serious personal injuries as well as damage to the product. The screw and hole should come together with over 5/16 inch (8 mm) length of thread. Use a bracket which has been approved for UL1678 standard, and which can endure at least 4 times or more the weight of the monitor.

Power management

This monitor conforms to VESA DPMS and DVI DMPM. Both your video card and computer must support the same standard in order for the monitor's power management function to work.

DPMS: Display Power Management Signaling

DPMS	Screen	Power consumption*	Hsync	Vsync
ON STATE	Display	130 W	Yes	Yes
		130 W		
		115 W		
STANDBY	No display	4.5 W	No	Yes
SUSPEND		4.5 W	Yes	No
OFF STATE		4.5 W	No	No

DMPM: Digital Monitor Power Management

DMPM	Screen	Power consumption*
Monitor ON	Display	130 W
		130 W
		115 W
Active OFF	No display	4.5 W
		4.5 W
		4.5 W

* Values of the PN-U553, PN-U473, and PN-U423 in that order from the top.

DDC (plug and play)

The monitor supports the VESA DDC (Display Data Channel) standard.

DDC is a signal standard for plug and play between monitors and computers. Information about resolution and other parameters is exchanged between the two. This function can be used if the computer supports DDC and it has been configured to detect plug-and-play monitors.

There are several types of DDC, depending on the communication method used. This monitor supports DDC2B.

Specifications

Compatible signal timing (PC)

Screen resolution		Hsync	Vsync	Dot frequency	Digital			Analog (D-SUB)
					DVI-D	HDMI	DisplayPort	
VESA	640 × 480	31.5kHz	60Hz	25.175MHz	Yes	Yes	Yes	Yes
		37.9kHz	72Hz	31.5MHz	Yes	Yes	Yes	Yes
		37.5kHz	75Hz	31.5MHz	Yes	Yes	Yes	Yes
	800 × 600	35.1kHz	56Hz	36.0MHz	-	-	-	Yes
		37.9kHz	60Hz	40.0MHz	Yes	Yes	Yes	Yes
		48.1kHz	72Hz	50.0MHz	Yes	Yes	Yes	Yes
		46.9kHz	75Hz	49.5MHz	Yes	Yes	Yes	Yes
	848 × 480	31.0kHz	60Hz	33.75MHz	Yes	-	-	Yes
	1024 × 768	48.4kHz	60Hz	65.0MHz	Yes	Yes	Yes	Yes
		56.5kHz	70Hz	75.0MHz	Yes	Yes	Yes	Yes
		60.0kHz	75Hz	78.75MHz	Yes	Yes	Yes	Yes
	1152 × 864	67.5kHz	75Hz	108.0MHz	Yes	Yes	Yes	Yes
	1280 × 768	47.8kHz	60Hz	79.5MHz	Yes	-	Yes	Yes
		60.3kHz	75Hz	102.25MHz	Yes	-	Yes	Yes
	1280 × 800	49.7kHz	60Hz	83.5MHz	Yes	Yes	Yes	Yes
	1280 × 960	60.0kHz	60Hz	108.0MHz	Yes	Yes	Yes	Yes
	1280 × 1024	64.0kHz	60Hz	108.0MHz	Yes	Yes	Yes	Yes
		80.0kHz	75Hz	135.0MHz	Yes	Yes	Yes	Yes
	1360 × 768	47.7kHz	60Hz	85.5MHz	Yes	Yes	Yes	Yes
	1400 × 1050	65.3kHz	60Hz	121.75MHz	Yes	Yes	Yes	Yes
1440 × 900	55.9kHz	60Hz	106.5MHz	Yes	Yes	Yes	Yes	
1600 × 1200*	75.0kHz	60Hz	162.0MHz	Yes	Yes	Yes	Yes	
1680 × 1050	65.3kHz	60Hz	146.25MHz	Yes	Yes	Yes	Yes	
1920 × 1200*	74.0kHz	60Hz	154.0MHz	Yes	Yes	Yes	Yes	
Wide	1280 × 720	44.7kHz	60Hz	74.4MHz	Yes	Yes	Yes	Yes
		66.3kHz	60Hz	148.5MHz	Yes	Yes	Yes	Yes
	1920 × 1080	67.5kHz	60Hz	148.5MHz	Yes	Yes	Yes	Yes
US TEXT	720 × 400	31.5kHz	70Hz	28.3MHz	Yes	Yes	Yes	Yes
Sun	1024 × 768	48.3kHz	60Hz	64.13MHz	-	-	-	Yes
		53.6kHz	66Hz	70.4MHz	-	-	-	Yes
		56.6kHz	70Hz	74.25MHz	-	-	-	Yes
	1152 × 900	61.8kHz	66Hz	94.88MHz	-	-	-	Yes
		71.8kHz	76.2Hz	108.23MHz	-	-	-	Yes
	1280 × 1024	71.7kHz	67.2Hz	117.01MHz	-	-	-	Yes
		81.1kHz	76Hz	134.99MHz	-	-	-	Yes
1600 × 1000	68.6kHz	66Hz	135.76MHz	-	-	-	Yes	

* Displays a reduced image, except in Dot by Dot. In Dot by Dot, the image will be cut down to panel size then displayed.

- All are compliant only with non-interlaced.
- Depending on the connected PC, images may not be displayed properly even if the compatible signal described above is input.
- The frequency values for the Sun are reference values.

Compatible signal timing (AV)

Screen resolution	Frequency	HDMI	Component
1920 × 1080p	24Hz	Yes	-
	50Hz	Yes	Yes
	59.94Hz	Yes	Yes
	60Hz	Yes	Yes
1920 × 1080i	50Hz	Yes	Yes
	59.94Hz	Yes	Yes
	60Hz	Yes	Yes
1280 × 720p	50Hz	Yes	Yes
	59.94Hz	Yes	Yes
	60Hz	Yes	Yes
720 × 576p	50Hz	Yes	Yes
720 × 480p	59.94Hz	Yes	Yes
	60Hz	Yes	Yes
640 × 480p(VGA)	59.94Hz	Yes	-
	60Hz	Yes	-
720(1440) × 576i	50Hz	Yes	Yes
720(1440) × 480i	59.94Hz	Yes	Yes
	60Hz	Yes	Yes

■DVI-D input terminal pins

(DVI-D 24 pin)

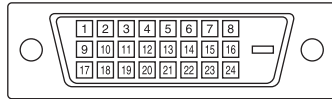

No.	Function	No.	Function
1	TMDS data 2-	13	N.C.
2	TMDS data 2+	14	+5V
3	TMDS data 2/4 shield	15	GND
4	N.C.	16	Hot-plug detection
5	N.C.	17	TMDS data 0-
6	DDC clock	18	TMDS data 0+
7	DDC data	19	TMDS data 0/5 shield
8	N.C.	20	N.C.
9	TMDS data 1-	21	N.C.
10	TMDS data 1+	22	TMDS clock shield
11	TMDS data 1/3 shield	23	TMDS clock+
12	N.C.	24	TMDS clock-

■HDMI input terminal pins

(HDMI™ Connector)

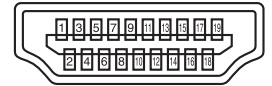

No.	Function	No.	Function
1	TMDS data 2+	11	TMDS clock shield
2	TMDS data 2 shield	12	TMDS clock-
3	TMDS data 2-	13	CEC
4	TMDS data 1+	14	N.C.
5	TMDS data 1 shield	15	SCL
6	TMDS data 1-	16	SDA
7	TMDS data 0+	17	GND
8	TMDS data 0 shield	18	+5V
9	TMDS data 0-	19	Hot-plug detection
10	TMDS clock+		

■D-sub input terminal pins

(Mini D-sub 15 pin)

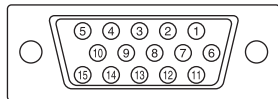

No.	Function	No.	Function
1	Red video signal input	9	+5V
2	Green video signal input	10	GND
3	Blue video signal input	11	N.C.
4	N.C.	12	DDC data
5	N.C.	13	Hsync signal input
6	GND for red video signal	14	Vsync signal input
7	GND for green video signal	15	DDC clock
8	GND for blue video signal		

■RS-232C input terminal pins

(D-sub 9 pin)

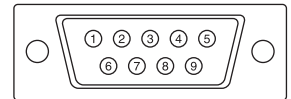

No.	Function	No.	Function
1	N.C.	6	N.C.
2	Transmitted data	7	N.C.
3	Received data	8	N.C.
4	N.C.	9	N.C.
5	GND		

■DisplayPort input terminal pins

(DisplayPort 20 pin)

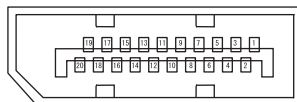

No.	Function	No.	Function
1	MainLane 3-	11	Gnd
2	Gnd	12	MainLane 0+
3	MainLane 3+	13	Gnd
4	MainLane 2-	14	Gnd
5	Gnd	15	Aux +
6	MainLane 2+	16	Gnd
7	MainLane 1-	17	Aux -
8	Gnd	18	Hot-plug detection
9	MainLane 1+	19	Gnd
10	MainLane 0-	20	3.3V

Specifications

■DVI-D output terminal pins

(DVI-D 24 pin)

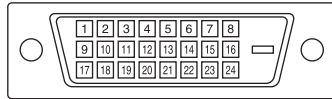

No.	Function	No.	Function
1	TMDS data 2-	13	N.C.
2	TMDS data 2+	14	+5V
3	TMDS data 2/4 shield	15	GND
4	N.C.	16	Hot-plug detection
5	N.C.	17	TMDS data 0-
6	DDC clock	18	TMDS data 0+
7	DDC data	19	TMDS data 0/5 shield
8	N.C.	20	N.C.
9	TMDS data 1-	21	N.C.
10	TMDS data 1+	22	TMDS clock shield
11	TMDS data 1/3 shield	23	TMDS clock+
12	N.C.	24	TMDS clock-

■RS-232C output terminal pins

(D-sub 9 pin)

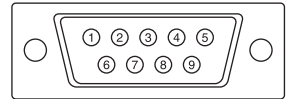

No.	Function	No.	Function
1	N.C.	6	N.C.
2	Received data	7	N.C.
3	Transmitted data	8	N.C.
4	N.C.	9	N.C.
5	GND		

Mounting Precautions (For SHARP dealers and service engineers)

- When installing, removing or moving the monitor, ensure that this is carried out by at least 2 people.
- Be sure to use a wall-mount bracket designed or designated for mounting the monitor.
- This monitor is designed to be installed on a concrete wall or pillar. Reinforced work might be necessary for some materials such as plaster / thin plastic board / wood before starting installation.
- This monitor and bracket must be installed on a wall which can endure at least 4 times or more the weight of the monitor. Install by the most suitable method for the material and the structure.
- To attach a VESA-compliant mounting bracket, use M6 screws that are 5/16 inch (8 mm) to 3/8 inch (10 mm) longer than the thickness of the mounting bracket.
- Do not use an impact driver.
- When moving the monitor, hold the parts marked by  below. Do not hold the LCD panel. This may cause product damage, failure, or injury.

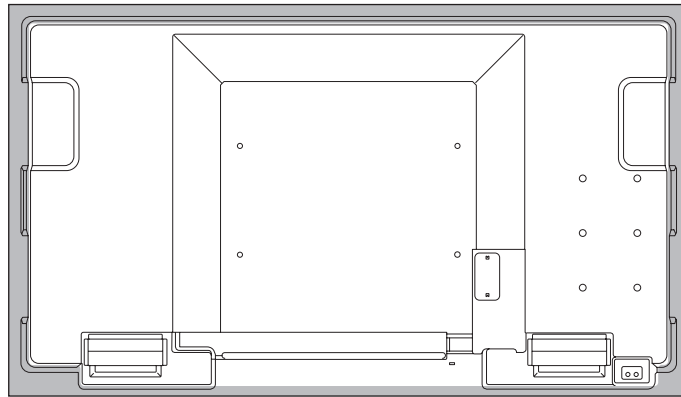

- After mounting, please carefully ensure the monitor is secure, and not able to come loose from the wall or mount.
- Do not use any screw holes other than VESA holes for installation.

SHARP[®]
SHARP CORPORATION