



**F16, F16R, F24 and F32
Professional Audio Mixing
Consoles**

Operator Manual

MUSIC Group Research UK Limited,
Klark Industrial Park,
Walter Nash Road,
Kidderminster.
Worcestershire.
DY11 7HJ.
England.

Tel: +44 1562 741515
Fax: +44 1562 745371

Email: mkt.info@music-group.com
Website: www.midasconsoles.com

VeniceF — Operator Manual
DOC02-VENICEXXX Issue E — November 2013
© MUSIC Group IP Ltd.

In line with the company's policy of continual improvement, specifications and function may be subject to change without notice. This document was correct at the time of writing. E&OE.



Important safety instructions



Terminals marked with this symbol carry electrical current of sufficient magnitude to constitute risk of electric shock. Use only high-quality commercially-available speaker cables with ¼" TS plugs pre-installed. All other installation or modification should be performed only by qualified personnel.



This symbol, wherever it appears, alerts you to the presence of uninsulated dangerous voltage inside the enclosure - voltage that may be sufficient to constitute a risk of shock.



This symbol, wherever it appears, alerts you to important operating and maintenance instructions in the accompanying literature. Please read the manual.



Caution
To reduce the risk of electric shock, do not remove the top cover (or the rear section). No user serviceable parts inside. Refer servicing to qualified personnel.



Caution
To reduce the risk of fire or electric shock, do not expose this appliance to rain and moisture. The apparatus shall not be exposed to dripping or splashing liquids and no objects filled with liquids, such as vases, shall be placed on the apparatus.



Caution
These service instructions are for use by qualified service personnel only. To reduce the risk of electric shock do not perform any servicing other than that contained in the operation instructions. Repairs have to be performed by qualified service personnel.

- 1 Read these instructions.
- 2 Keep these instructions.
- 3 Heed all warnings.
- 4 Follow all instructions.
- 5 Do not use this apparatus near water.
- 6 Clean only with dry cloth.
- 7 Do not block any ventilation openings. Install in accordance with the manufacturer's instructions.
- 8 Do not install near any heat sources such as radiators, heat registers, stoves, or other apparatus (including amplifiers) that produce heat.

9 Do not defeat the safety purpose of the polarized or grounding-type plug. A polarized plug has two blades with one wider than the other. A grounding-type plug has two blades and a third grounding prong. The wide blade or the third prong are provided for your safety. If the provided plug does not fit into your outlet, consult an electrician for replacement of the obsolete outlet.

10 Protect the power cord from being walked on or pinched particularly at plugs, convenience receptacles, and the point where they exit from the apparatus.

11 Use only attachments/accessories specified by the manufacturer.



moving the cart/apparatus combination to avoid injury from tip-over.

12 Use only with the cart, stand, tripod, bracket, or table specified by the manufacturer, or sold with the apparatus. When a cart is used, use caution when

moving the cart/apparatus combination to avoid injury from tip-over.

13 Unplug this apparatus during lightning storms or when unused for long periods of time.

14 Refer all servicing to qualified service personnel. Servicing is required when the apparatus has been damaged in any way, such as power supply cord or plug is damaged, liquid has been spilled or objects have fallen into the apparatus, the apparatus has been exposed to rain or moisture, does not operate normally, or has been dropped.

15 The apparatus shall be connected to a MAINS socket outlet with a protective earthing connection.

16 Where the MAINS plug or an appliance coupler is used as the disconnect device, the disconnect device shall remain readily operable.



Legal disclaimer

Technical specifications and appearance are subject to change without notice. The information contained herein is correct at the time of printing. All trademarks are the property of their respective owners. MUSIC Group accepts no liability for any loss which may be suffered by any person who relies either wholly or in part upon any description, photograph or statement contained herein. Colors and specifications may vary slightly from product. Midas products are sold through authorized dealers only. Distributors and dealers are not

agents of MUSIC Group and have absolutely no authority to bind MUSIC Group by any express or implied undertaking or representation. This manual is copyrighted. No part of this manual may be reproduced or transmitted in any form or by any means, electronic or mechanical, including photocopying and recording of any kind, for any purpose, without the express written permission of MUSIC Group IP Ltd.

ALL RIGHTS RESERVED.

© 2013 MUSIC Group IP Ltd.

Trident Chambers, Wickhams Cay, P.O. Box 146, Road Town, Tortola, British Virgin Islands

Limited warranty

§ 1 Warranty

7. This limited warranty is valid only if you purchased the product from a MUSIC Group authorized dealer in the country of purchase. A list of authorized dealers can be found on MUSIC Group's website www.midasconsoles.com, or you can contact the MUSIC Group office closest to you.

2. MUSIC Group* warrants the mechanical and electronic components of this product to be free of defects in material and workmanship if used under normal operating conditions for a period of three (3) years from the original date of purchase (see the Limited Warranty terms in § 4 below), unless a longer minimum warranty period is mandated by applicable local laws. If the product shows any defects within the specified warranty period and that defect is not excluded under § 4, MUSIC Group shall, at its discretion, either replace or repair the product using suitable new or reconditioned product or parts. In case MUSIC Group decides to replace the entire product, this limited warranty shall apply to the replacement product for the remaining initial warranty period, i.e., three (3) years (or otherwise applicable minimum warranty period) from the date of purchase of the original product.

3. Upon validation of the warranty claim, the repaired or replacement product will be returned to the user freight prepaid by MUSIC Group.

4. Warranty claims other than those indicated above are expressly excluded.

PLEASE RETAIN YOUR SALES RECEIPT. IT IS YOUR PROOF OF PURCHASE COVERING YOUR LIMITED WARRANTY. THIS LIMITED WARRANTY IS VOID WITHOUT SUCH PROOF OF PURCHASE.

§ 2 Online registration

Please do remember to register your new Midas equipment right after your purchase at www.midasconsoles.com and kindly read the terms and conditions of our limited warranty carefully. Registering your purchase and equipment with us helps us process your repair

claims quicker and more efficiently. Thank you for your cooperation!

§ 3 Return materials authorization

1. To obtain warranty service, please contact the retailer from whom the equipment was purchased. Should your MUSIC Group dealer not be located in your vicinity, you may contact the MUSIC Group distributor for your country listed at www.midasconsoles.com. If your country is not listed please contact the "United Kingdom (Midas/ KT main office)" located under "Service ↪ Service/Repairs" on the www.midasconsoles.com website. Alternatively, please submit the online warranty return form found under "Service ↪ Warranty Registration" on www.midasconsoles.com BEFORE returning the product. All enquires must be accompanied by the description of the problem and the serial number of the product. The warranty eligibility will be verified from the original sales receipt.

2. Subsequently, the product must be returned in its original shipping carton, together with the return authorization number to the address indicated by MUSIC Group.

3. Shipments without freight prepaid will not be accepted.

§ 4 Warranty Exclusions

1. This limited warranty does not cover consumable parts including, but not limited to, fuses and batteries. Where applicable, MUSIC Group warrants the valves or meters contained in the product to be free from defects in material and workmanship for a period of ninety (90) days from date of purchase.

2. This limited warranty does not cover the product if it has been electronically or mechanically modified in any way. If the product needs to be modified or adapted in order to comply with applicable technical or safety standards on a national or local level, in any country which is not the country for which the product was originally developed and manufactured, this modification/adaptation shall not be considered a defect in materials or workmanship. This limited warranty does not cover any such modification/adaptation, regardless of whether it was carried out properly or not. Under the terms of this limited warranty, MUSIC Group shall not be held responsible for any cost resulting from such a modification/adaptation.

3. This limited warranty covers only the product hardware. It does not cover technical assistance for hardware or software usage and it does not cover any software products whether or not contained in the product. Any such software is provided "AS IS" unless expressly provided for in any enclosed software limited warranty.

4. This limited warranty is invalid if the factory-applied serial number has been altered or removed from the product.

5. Free inspections and maintenance/repair work are expressly excluded from this limited warranty, in particular, if caused by improper handling of the product by the user. This also applies to defects caused by normal wear and tear, in particular, of faders, crossfaders, potentiometers, keys/buttons, guitar strings, illuminants and similar parts.

6. Damage/defects caused by the following conditions are not covered by this limited warranty:

- improper handling, neglect or failure to operate the unit in compliance with the instructions given in Midas user or service manuals;
- connection or operation of the unit in any way that does not comply with the technical or safety regulations applicable in the country where the product is used;
- damage/defects caused by acts of God/ Nature (accident, fire, flood, etc) or any other condition that is beyond the control of MUSIC Group.

7. Any repair or opening of the unit carried out by unauthorized personnel (user included) will void the limited warranty.

8. If an inspection of the product by MUSIC Group shows that the defect in question is not covered by the limited warranty, the inspection costs are payable by the customer.

9. Products which do not meet the terms of this limited warranty will be repaired exclusively at the buyer's expense. MUSIC Group or its authorized service center will inform the buyer of any such circumstance. If the buyer fails to submit a written repair order within 6 weeks after notification, MUSIC Group will return the unit C.O.D. with a separate invoice for freight and packing. Such costs will also be invoiced separately when the buyer has sent in a written repair order.

10. Authorized MUSIC Group dealers do not sell new products directly in online auctions. Purchases made through an online auction are on a "buyer beware" basis. Online auction confirmations or sales receipts are not accepted for warranty verification and MUSIC Group will not repair or replace any product purchased through an online auction.

§ 5 Warranty transferability

This limited warranty is extended exclusively to the original buyer (customer of authorized retail dealer) and is not transferable to anyone who may subsequently purchase this product. No other person (retail dealer, etc.) shall be entitled to give any warranty promise on behalf of MUSIC Group.

§ 6 Claim for damage

Subject only to the operation of mandatory applicable local laws, MUSIC Group shall have no liability to the buyer under this warranty for any consequential or indirect loss or damage of any kind. In no event shall the liability of MUSIC Group under this limited warranty exceed the invoiced value of the product.

§ 7 Limitation of liability

This limited warranty is the complete and exclusive warranty between you and MUSIC Group. It supersedes all other written or oral communications related to this product. MUSIC Group provides no other warranties for this product.

§ 8 Other warranty rights and national law

1. This limited warranty does not exclude or limit the buyer's statutory rights as a consumer in any way.

2. The limited warranty regulations mentioned herein are applicable unless they constitute an infringement of applicable mandatory local laws.

3. This warranty does not detract from the seller's obligations in regard to any lack of conformity of the product and any hidden defect.

§ 9 Amendment

Warranty service conditions are subject to change without notice. For the latest warranty terms and conditions and additional information regarding MUSIC Group's limited warranty, please see complete details online at www.midasconsoles.com.

* MUSIC Group Macao Commercial Offshore Limited of Rue de Pequim No. 202-A, Macau Finance Centre 9/J, Macau, including all MUSIC Group companies

Other important information

1 Register online. Please register your new Midas equipment right after you purchase it by visiting www.midasconsoles.com. Registering your purchase using our simple online form helps us to process your repair claims more quickly and efficiently. Also, read the terms and conditions of our warranty, if applicable.

2 Malfunction. Should your MUSIC Group dealer not be located in your vicinity, you may contact the MUSIC Group distributor for your country at www.midasconsoles.com. If your country is not listed please contact the "United Kingdom (Midas/KT main office)" located under "Service ↪ Service/Repairs" on the www.midasconsoles.com website. Alternatively, please submit the online warranty return form found under "Service ↪ Warranty Registration" on www.midasconsoles.com BEFORE returning the product. All enquires must be accompanied by the description of the problem and the serial number of the product. The warranty eligibility will be verified from the original sales receipt.

3 Power Connections. Before plugging the unit into a power socket, please make sure you are using the correct mains voltage for your particular model. Faulty fuses must be replaced with fuses of the same type and rating without exception.

FireWire and the FireWire symbol are trademarks of Apple Inc., registered in the U.S. and other countries. The FireWire logo is a trademark of Apple Inc.

Mac and the Mac logo are trademarks of Apple Inc., registered in the U.S. and other countries.

Microsoft and Windows are registered trademarks of Microsoft Corporation in the United States and other countries.

FireWire board hot plugging

IMPORTANT! Do not connect or disconnect the FireWire cable to your Venice F when the console is powered up, as this may result in damage to sensitive components. Always switch off the console before connecting or disconnecting the FireWire cable!

It is strongly recommended that when connecting or disconnecting the Venice F to a PC/MAC/LAPTOP you do so in the following manner:

When Connecting the Venice F

- Ensure that the computer is turned OFF
- Ensure that the Venice F is turned OFF
- Connect your Venice F FireWire port to your computer's FireWire port
- Turn ON your Venice F
- Turn ON your Computer
- Turn ON your Monitor Speakers

When disconnecting the Venice F

- Turn OFF your monitor speakers
- Turn OFF your Venice F
- Disconnect your Venice F

Contents

Important safety instructions	iii
Other important information	v
Chapter 1	Introduction 1
	Overview of the VeniceF 1
	Key features 3
	Control surface 4
	Rear panel 5
	External connections 6
	Signal flow 7
	Mix matrix 9
	About this manual 9
	Service and support 10
Chapter 2	Getting Started. 11
	Installation 11
	Handling the equipment 11
	Electric fields 12
	Connecting up 12
	Audio connections 12
	Connecting to balanced/unbalanced equipment 13
	Other connections 14
	Setting up 15
	Switching the VeniceF on/off 15
Chapter 3	Using The VeniceF With FireWire. 17
	Installing FireWire on a PC 17
	Step A — Installing the device driver on your PC 17
	Step B — Connecting the VeniceF to your PC 20
	Step C — Configuring the FireWire settings for the VeniceF 22
	Installing FireWire on a Mac 25
	Step A — Installing the device driver on your Mac 25
	Step B — Connecting the VeniceF to your Mac 27
	Step C — Configuring the FireWire settings for the VeniceF 27
	Updating the FireWire driver 27
	Troubleshooting FireWire 28
	Audio problems 28
	No devices found 28
	Overcoming ground loop problems 28
Chapter 4	Working With The Console. 29
	Ground loop problems 29

Chapter 5	Mono Input Channel	31
	Overview of the mono input channel32
	Rear panel33
	Gain34
	FireWire35
	Insert35
	EQ36
	Monitors37
	Auxes38
	Pan, routing, mute and solo39
	Fader and meter41
Chapter 6	Dual Stereo Input Channel	43
	Overview of the dual stereo input channel44
	Rear panel45
	Gain (stereo mic inputs)46
	FireWire46
	Stereo line inputs47
	EQ48
	Monitors49
	Auxes49
	Pan, routing, mute and solo50
	Group sends51
	Fader and meter52
Chapter 7	Output Section.	53
	Rear panel54
	Overview of the outputs section55
	Output module notes56
	Group-aux changeover56
	Meter changeover56
	Groups57
	FireWire58
	Matrices61
	Stereo returns63
	Monitors64
	Auxes65
	Master outputs (mono and stereo)66
	Signal generator and talkback68
	Playback and recording69
	Playback69
	Recording70
	Local monitor and phones70
	Lamps71
Appendix A	Functional Block Diagrams	73
	Overview74
	Mono input module75
	Stereo input module76
	Stereo return77
	Group78
	Aux79

	Monitor	80
	Stereo master	81
	Mono master	82
	Matrix	83
	Solo and comms	84
	Digital	85
Appendix B	Technical Specification.	87
	Dimensions	90
Appendix C	Application Notes	93
	Gain	93
	Headroom	93
	The effect of EQ	94
	Dynamic processing	94
	Unity Gain	95
	Signal Processing and Amplifiers	95
	Routing	96
	FOH mode	96
	MON mode	97
	Dual FOH/MON Mode	97
Appendix D	Crib Sheets	99
	Mono input channels	100
	Dual stereo input channels	101
Appendix E	Best Grounding Practice.	103
	Safety first	103
	Ground loops	103
	Noise sources	104
	Noise solutions	106
	Balanced connections	107
	Balanced transformers	108
	Screen termination	108
	Ground referenced connections	109
	Unbalanced connections	110
	Signal ground lift	110
	XLR shells	111
	Signal ground bonding	111
Appendix F	Service Information	113
	Routine maintenance	113
	Cleaning the console	113
	Troubleshooting	113
	Special accessories	113
	Optional equipment	113
	Equipment disposal	114
	FEDERAL COMMUNICATIONS COMMISSION COMPLIANCE INFORMATION	115

Chapter 1: Introduction

Thank you for choosing a Midas Venice*F* mixing console. The Venice*F* range of consoles have been developed to meet the needs of demanding live sound engineers and provide the solution for any audio mixing application in live sound or studio environments. The Venice*F* meets the quality of build and performance that you would expect from a Midas console.



VeniceF32

The Venice*F* was conceived by Midas to offer audio professionals high-performance audio equipment, designed to provide no-compromise sonic quality with a feature set that offers all essential facilities and functions. It represents the very best of British design and engineering combined with contemporary, efficient manufacturing methods, and will give you many years of reliable service.

Midas has total confidence in the quality and reliability of this product. To back this up, this product comes with the standard Midas three year warranty.

Please take the time to register your product by completing and returning the registration card or by registering on our website at www.midasconsoles.com.

So, to obtain the best results with a minimum of effort, please read this Operator Manual and, finally, enjoy your Midas Venice*F*!

Overview of the Venice*F*

The Venice*F* is a premium quality, robust, live sound and studio, small format mixing console. The Venice*F* is available in three sizes — *F16*, *F24* and *F32* — and there is also a rack mount version (*F16R*). The incorporation of FireWire®, bridges the gap between analogue and digital audio consoles by offering the user the ease-of-use, warmth, feel, and zero-latency of analogue, combined with the power, choice and flexibility of outboard digital processing. Physically, it's a one-piece solution provided in a substantial chassis with cosmetic trim suitable for use and storage in a road flight case (not provided). All circuitry — analogue, digital and power — is housed inside this box.

Equally at home as an all-purpose front of house (FOH) or studio console, the Venice*F* can also be used for monitors. The Venice*F* is quickly and easily configurable, with each mono input channel offering microphone (mic) and line inputs, direct out and insert points, and a four-band fully swept equaliser stage. In addition, the Venice*F* has a

flexible bus structure that lets the engineer configure the console for different applications.



The VeniceF consoles (F16 left, F24 top and F32 bottom)

All variants include four stereo input channels for use on stereo sources. These share single control knobs and have slightly different functionality as compared to the mono channels.

The VeniceF lets the user route to any of 13 other buses — six auxiliaries (including two monitors), four groups and three masters (stereo left and right, and mono). There are also two matrix buses, which are a submix of the master buses, and three solo buses (two after-fader listen (AFL) and one pre-fader listen (PFL)).

All major inputs and outputs are on balanced XLR connectors. The following table gives a 'quick stats' comparison of the VeniceF consoles (where: XLRF = XLR female; XLRM = XLR male; TRS = 1/4" TRS Jack; and RCA = phono plug).

<i>Item</i>	<i>F16</i>	<i>F24</i>	<i>F32</i>
Mic inputs	8 mono and 4 stereo XLRF	16 mono and 4 stereo XLRF	24 mono and 4 stereo XLRF
Line inputs	8 mono and 4 stereo TRS	16 mono and 4 stereo TRS	24 mono and 4 stereo TRS
Aux returns	2 stereo TRS	2 stereo TRS	2 stereo TRS
Playback input	1 stereo RCA	1 stereo RCA	1 stereo RCA
Talkback mic input	1 XLRF	1 XLRF	1 XLRF
Aux mix buses (includes 2 monitors)	6 XLRM	6 XLRM	6 XLRM
Audio subgroups	4 XLRM	4 XLRM	4 XLRM
Matrices	2 XLRM	2 XLRM	2 XLRM
Stereo master output	XLRM	XLRM	XLRM

<i>Item</i>	<i>F16</i>	<i>F24</i>	<i>F32</i>
Mono master output	XLRM	XLRM	XLRM
FireWire (IEEE 1394)	16-channel, FW400, 6-pin	24-channel, FW400, 6-pin	32-channel, FW400, 6-pin

The FireWire interface can be used with any personal computer (PC) fitted with an IEEE1394 port, and is effectively a digital multi-channel cable (up to 2 x 32-channels) for connecting the PC to the console. FireWire lets you use any third party audio processing software in conjunction with the console, and applications include multi-track recording, software-generated effects processors and “plug-ins” inserted on input channel FireWire send/returns.

Key features

The Venice*F* consoles include the following key features:

- **Sizes** — available in 16, 24 and 32 input channel frame sizes.
- **Midas mic preamps** — 16/24/32 overload-tolerant Midas mic preamps (the last eight being on four stereo modules), which accept +32dBu.
- **Midas XL3 EQ** — each mono channel has a Midas XL3, 4-band swept EQ with 2 parametric mids (treble, hi mid, lo mid and bass).
- **4-band EQs on stereo channels** — 4-band fixed frequency EQs on stereo channels and a sum-to-mono switch.
- **Ease of use** — easy to store, prep, configure, maintain, repair, transport, set up/down and clean.
- **Hybrid technology** — analogue technology for sound processing and mixing, and digital connectivity provided by FireWire. Analogue or digital (FireWire) input and analogue or digital (FireWire) direct output pre-EQ or post-EQ.
- **FireWire** — up to 32 x 32-channel FireWire interface that provides I/O connectivity, which defaults to input channels, but can be switched to access buses. FireWire socket (6-pin) and sample rate and clock source LEDs.
- **Mono input channels** — mic/line in, insert (with in/out switch and LED) and direct out (with a pre-EQ or post-EQ switch) per channel. Polarity switch on each channel.
- **Dual stereo input channels** — mic/line in left and in right (mic and line can be used simultaneously with mic routed via the channel and the line inputs routed direct to masters), separate gain for the left and right inputs, and same mic amp functions as the mono inputs.
- **Master channels** — mono, left and right master channels, each with an insert.
- **15 Buses** — 6 aux sends (includes 2 monitor (foldback) sends that are also switchable pre-/post-EQ on an individual channel basis), 4 groups, 3 masters (2 stereo and a mono) and 2 matrices, all with hardware outputs.
- **Returns** — 2 additional stereo return line inputs.
- **Local outputs** — 2 local outputs (left and right).
- **Routing** — individual routing to stereo, mono and groups with pan-to-groups enable switch. Individual group routing switches.
- **Metering** — 4-LED meter per mono and stereo input channels, 4 x 8-LED output meters and 3 x 12-LED master meters.
- **Faders** — high-precision 100 mm faders on a horizontal fader panel.
- **48V phantom power** — all analogue audio I/O is tolerant of 48V connection.

- **Mains power supply** — universal power supply unit (PSU) with mains input socket and on/off switch.
- **Lamps** — socket(s) for fitting lamps.
- **Playback/record I/Os** — input/output sockets for playback and recording.
- **Warranty** — standard Midas 3-year warranty.

Control surface

The surface of the VeniceF can be divided into the following main vertical sections.

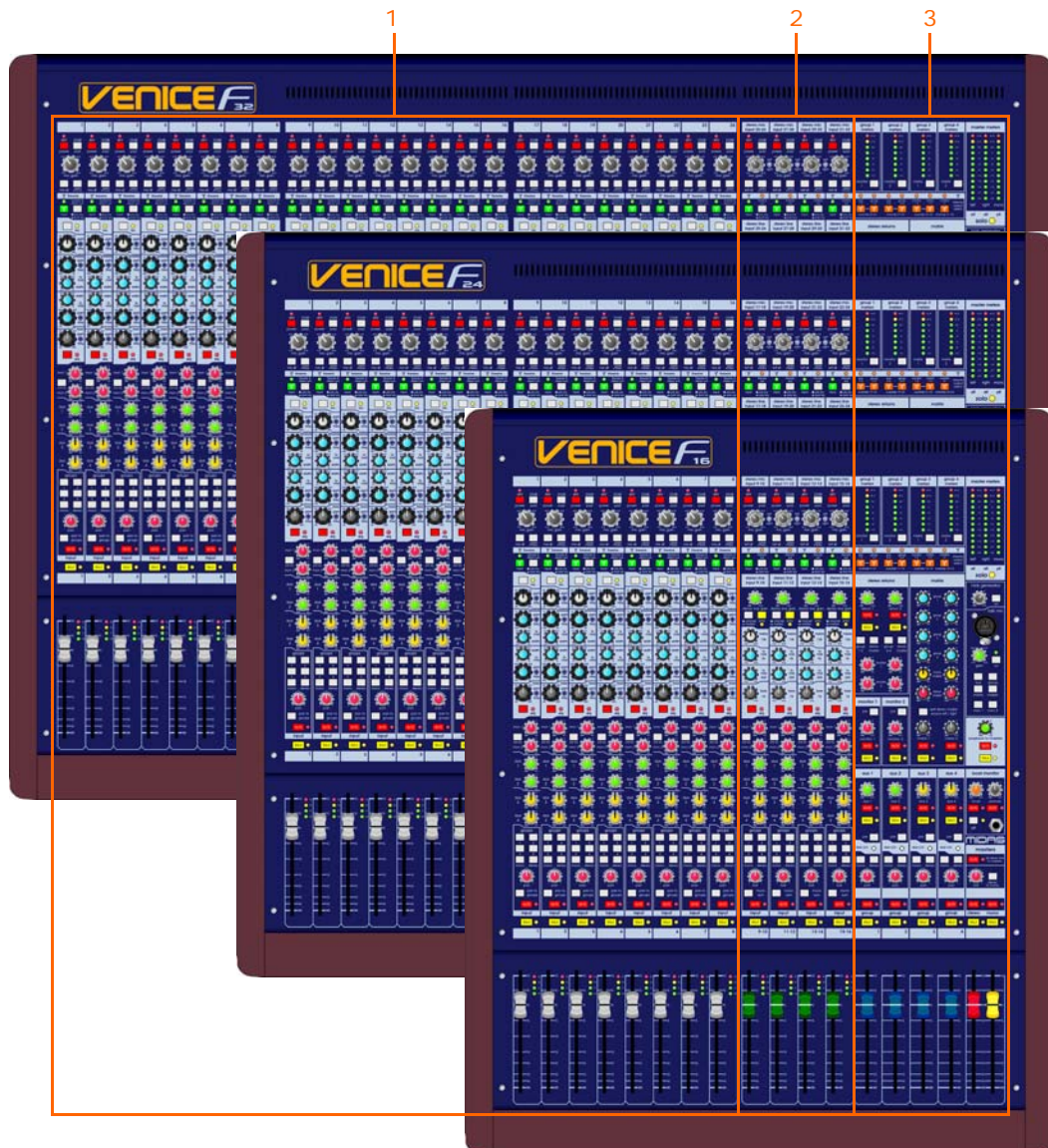

Control surfaces of the VeniceF consoles showing the three main areas

<i>Item</i>	<i>Description</i>
1	See Chapter 5 "Mono Input Channel" on page 31
2	See Chapter 6 "Dual Stereo Input Channel" on page 43
3	See Chapter 7 "Output Section" on page 53

Rear panel

The VeniceF has a rear panel that houses the following.

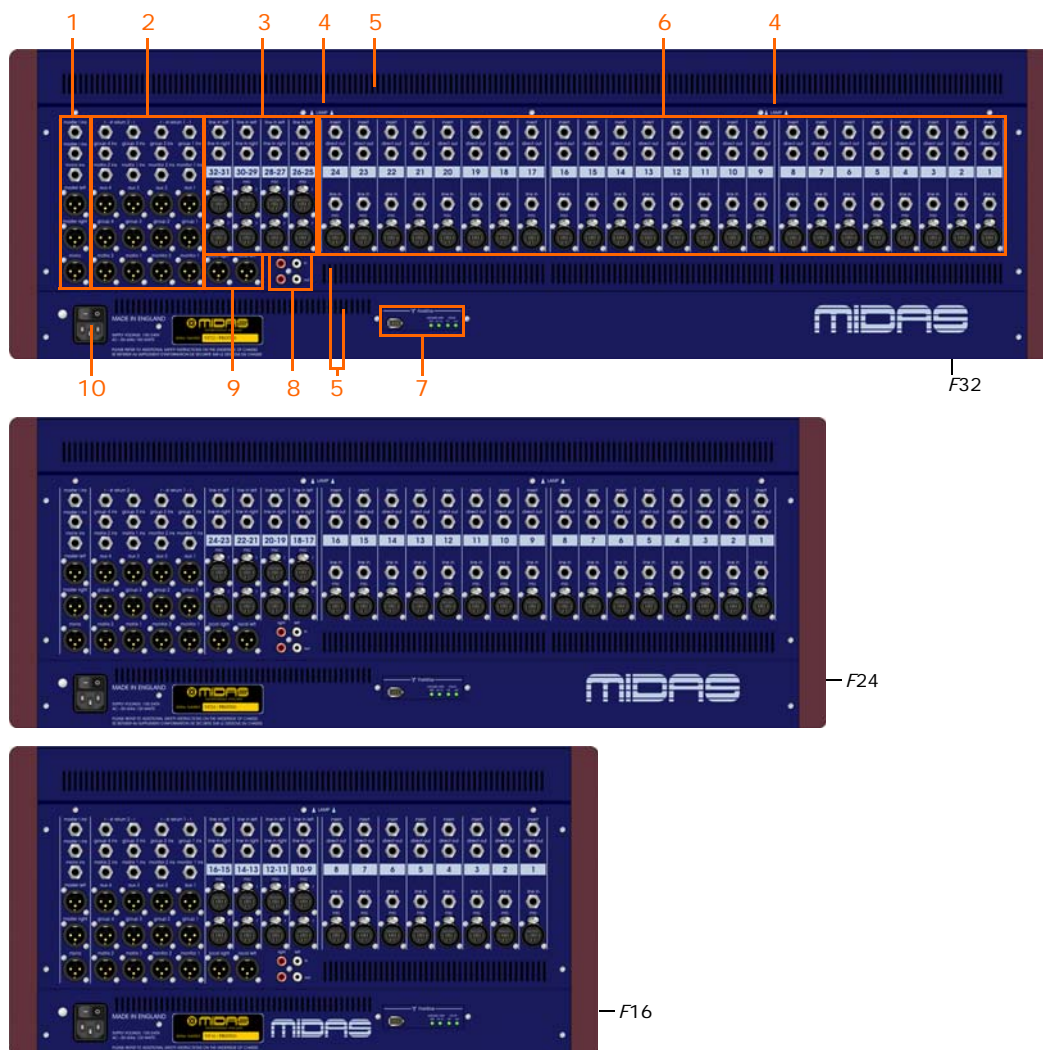

Rear panels of the VeniceF consoles showing the main areas

Item	Description
1	See "Master outputs (mono and stereo)" on page 66.
2	See "Stereo returns" on page 63, "Groups" on page 57, "Matrices" on page 61, "Monitors" on page 64 and "Auxes" on page 65.
3	See Chapter 6 "Dual Stereo Input Channel" on page 43.
4	See "Lamps" on page 71.
5	Ventilation grills. Do not obstruct.
6	See Chapter 5 "Mono Input Channel" on page 31.
7	See "FireWire" on page 35, page 46 and page 58.
8	See "Playback and recording" on page 69.
9	See "Local monitor and phones" on page 70.
10	See "Switching the VeniceF on/off" on page 15.

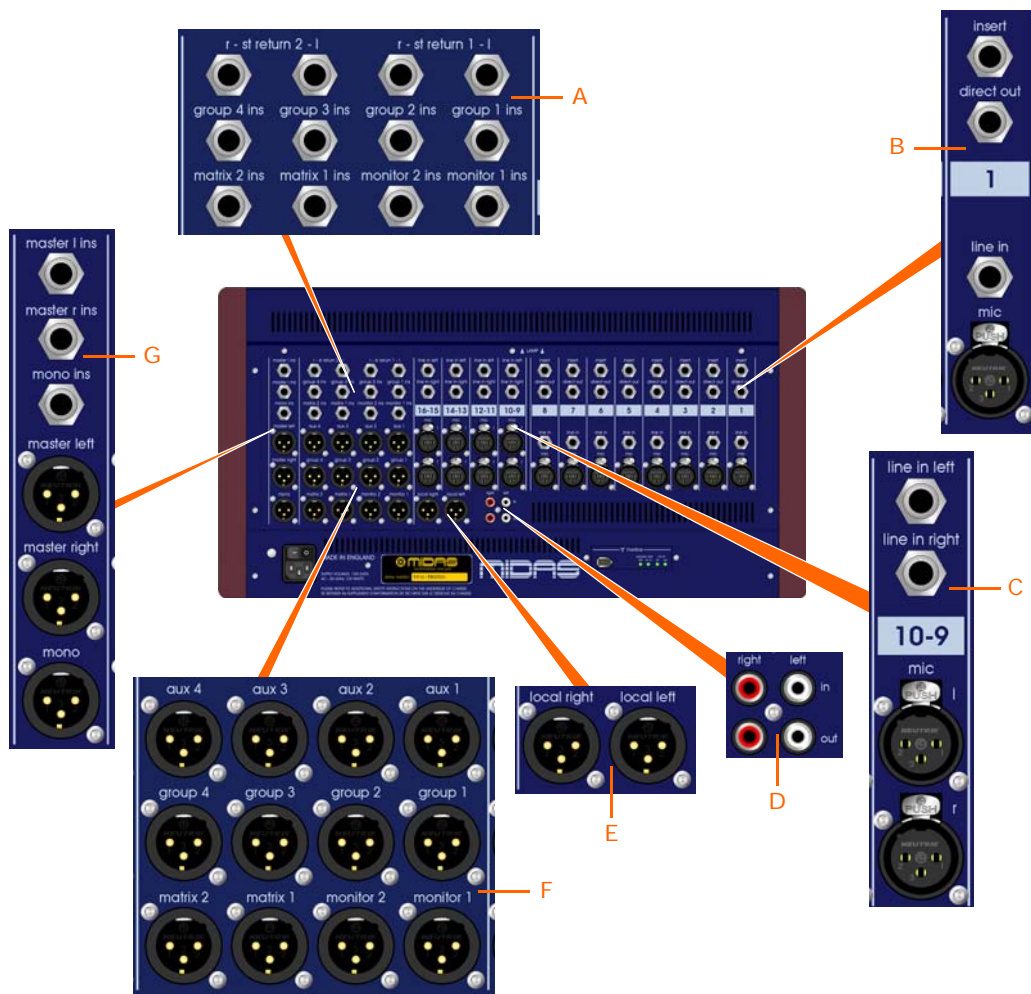

Rear panel of the VeniceF16 showing the main connector sections

A. Inserts and returns. **B.** Mono input channel (insert, direct out, line in and mic in). **C.** Dual stereo channel (line in left and right, and mic inputs left and right). **D.** Playback I/Os (left and right). **E.** Local monitor outputs. **F.** Aux, group, matrix and monitor outputs. **G.** Stereo and mono master inserts and outputs.

External connections

The following table details all of the external connections on the VeniceF.

Connection(s)	Description	Notes
All mic inputs	Balanced XLR connectors, 2K load	Mono and stereo channels
All primary line inputs	Balanced Jacks 10K load	Mono and stereo channels
All inserts	Jack connectors, 50R source, 10K load	Mono and master channels
		Group, matrix and monitor buses
		Stereo returns

<i>Connection(s)</i>	<i>Description</i>	<i>Notes</i>
All primary outputs	Balanced XLR connectors, 50R source	Master channels Aux, group, matrix, monitor and local (monitor) buses Talk mic in talk mic section of outputs (control surface)
All secondary outputs (direct outs)	Balanced Jack connectors, 50R source	Mono channels
Headphone outputs	Jack connectors, 10R source (nominal +10dB)	local monitor section of outputs (control surface)
Playback left and right inputs and outputs	Unbalanced phono connectors, 600R source (nominal -10dB)	Rear panel
FireWire connections	FireWire (FW 4000 6-pin) connector to IEEE1394	Rear panel
Power connections	IEC mains inlet	Rear panel
	4-pin XLR lamp power outlets	Under top edge of rear of console

Signal flow

The following table gives an overview of the basic signal flow.

<i>Channels or inputs</i>	<i>Route to</i>
8, 16 or 24 mono mic/line channels	2 monitor, 4 aux, 4 group and 3 master buses, and FireWire (8, 16 or 24 channels)
4 stereo mic channels	2 monitor, 4 aux, 4 group and 3 master buses, and FireWire (8 channels)
4 stereo line inputs	The same numbered stereo channel and then onwards (as above) or the stereo master bus
2 stereo return channels	2 monitor, group 1-2 (return 1) and group 3-4 (return 2), and the stereo master buses
4 group channels	3 master and 2 matrix buses
3 master channels	2 matrix buses
4 aux channels	N/A
2 monitor channels	N/A
2 matrix channels	N/A

All channel types can also access the PFL, and AFL (left and right) solo buses.

The following table shows the signal flow in detail.

<i>Signal</i>	<i>Sourced from</i>	<i>Routed to</i>
Mono	Balanced XLR mic/line input or balanced Jack line Z input (common gain control with above) or FireWire connection or insert return	Buses, insert Jack, direct output Jack and FireWire connection
Stereo	Balanced XLR mic/line input and balanced Jack line Z input (independent gain control) or FireWire connection	Buses and FireWire connection
Stereo return	Balanced Jack	Buses
Group	Bus	Master and matrix buses, insert Jack, group output balanced XLR and optional FireWire connection (in place of stereo input channel)
Aux	Bus	Insert Jack, monitor output balanced XLR and optional FireWire connection (in place of stereo input channel)
Monitor	Bus	Insert Jack, monitor output balanced XLR and optional FireWire connection (in place of stereo input channel)
Matrix	Insert Jack	Insert Jack, matrix output balanced XLR and optional FireWire connection (in place of stereo input channel)
Stereo master bus	Bus, input channels, group buses, stereo returns or playback	Insert Jack, master output balanced XLR and optional FireWire connection (in place of stereo input channel)
Mono master bus	Bus, input channels, group buses, stereo returns or sum of stereo bus	Insert Jack and master output balanced XLR

Mix matrix

Ultimately, the mix matrix defines the capability of each VeniceF. It follows the console layout, where inputs run vertically and buses run horizontally. A mix matrix is usually defined as the number of buses and the quantity of simultaneously-mixable inputs there are per bus.

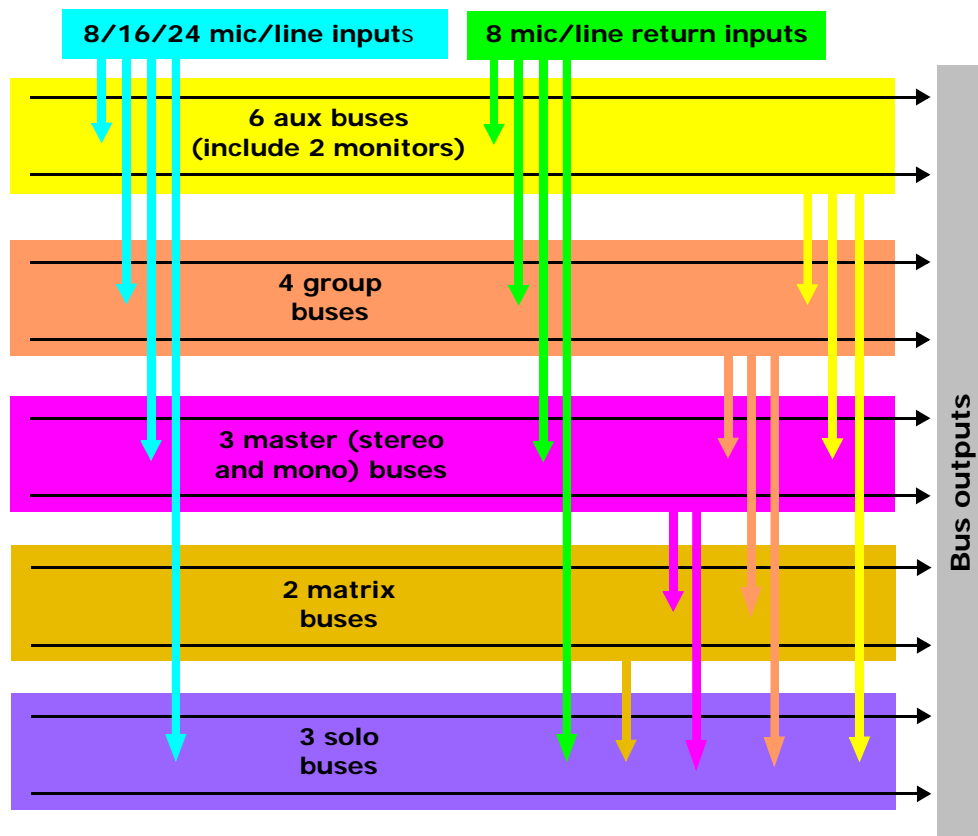



VeniceF mix matrix

About this manual

This is the Operator Manual for the VeniceF. Its purpose is to familiarise the user with the VeniceF and show how to install, set up, configure and operate the VeniceF.

This manual uses the following conventions:

- The exclamation mark (shown right) is intended to alert the user to important operating instructions. 
- The drawing pin (shown right) appears next to useful information, which provides hints and tips. 
- There are diagrams throughout the manual that show you where on the console the local information is referring to. These areas are indicated by blue shading. For example, the mono input channels, as shown right.

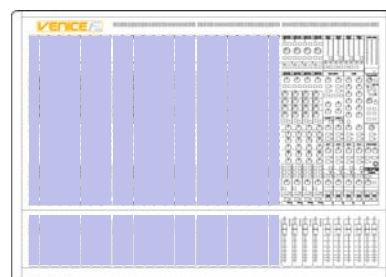

- Unless otherwise stated, an illuminated LED means that its related control/function is on and when extinguished it is off.
- Although this manual is based on the VeniceF32 (pictures shown throughout), the information also applies to the F16 and F24 models unless stated otherwise.

Service and support

We provide superb levels of support and service to give users confidence in Midas products. For more information, please contact your local distributor or Midas at the address shown in the front of this manual.

Chapter 2: Getting Started

This chapter shows you how to prepare the VeniceF for operation, which includes:

- Installation
- Connecting up
- Setting up
- Powering up

Before installing, setting up or operating this equipment make sure you have read and fully understand all of the “IMPORTANT SAFETY INSTRUCTIONS” at the front of this document and observe the following precautions.

Installation

The position of the console will vary from venue to venue. When installing the console, take the following into consideration.

- Before installing and operating this Class 1 equipment, make sure it is correctly connected to the protective earth conductor of the mains voltage supply socket outlet through the mains lead.
- When positioning the console for FOH use it is worth placing the console in a position where the sound system used can be heard properly from the mix position. Try to avoid placing the console behind pillars or large objects, or mixing from a level above the speaker position (for example, from a balcony).
- The console should be located in a convenient space commensurate with the use to which the console is being put.
- Ideally a cool area is preferred, away from power distribution equipment or other potential sources of interference.
- Do not install the equipment in places of poor ventilation.
- Do not install this equipment in a location subjected to excessive heat, dust or mechanical vibration. Allow for adequate ventilation around the equipment, making sure that its fans and vents are not obstructed. Whenever possible, keep the equipment out of direct sunlight.
- Do not place the equipment in an unstable condition where it might accidentally fall over.
- Provision should be made for some flat surface surrounding the console to prevent people using it as a table top.

Handling the equipment

When lifting or moving the equipment, always take its size and weight into consideration. If necessary, use suitable lifting equipment or transporting gear, or sufficient additional personnel.

Completely isolate the equipment electrically and disconnect all cables from the equipment before moving it.

Do not insert your fingers or hands in any gaps or openings on the equipment, for example, vents.

Electric fields

Should this product be used in an electromagnetic field that is amplitude modulated by an audio frequency signal (20Hz to 20kHz), the signal to noise ratio may be degraded. Degradation of up to 60dB at a frequency corresponding to the modulation signal may be experienced under extreme conditions (3V/m, 90% modulation).

Connecting up

To ensure the correct and reliable operation of your equipment, only high quality, balanced, screened, twisted pair audio cable should be used.







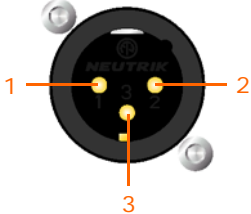

XLR connector shells should be of metal construction so that they provide a screen when connected to the console and, where appropriate, they should have Pin 1 connected to the cable screen.

All Jack connector shells should be connected to the cable screen.

Audio connections

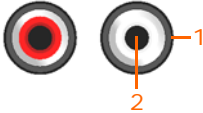
This section gives details of the audio connections of the VeniceF.

Table 1: Connector pinouts

<i>Connector on rear panel</i>	<i>Example of plug</i>	<i>Pinouts</i>	<i>Example of socket</i>
Male XLR chassis connector (output)		1 = ground 2 = hot 3 = cold	
Female XLR chassis connector (mic input)		1 = ground 2 = hot 3 = cold	
Pair of RCA connectors (tape in/out)		1 = ground 2 = signal	
1/4" TRS Jack plug (inserts)		1 (tip) = send 2 (ring) = return 3 (sleeve) = ground	
1/4" TRS Jack plug (input, output)		1 (tip) = hot 2 (ring) = cold 3 (sleeve) = ground	

Connecting to balanced/unbalanced equipment

The inserts of the VeniceF are unbalanced. Ideally, you will be connecting the inserts to balanced equipment to help avoid noise problems due to grounding.

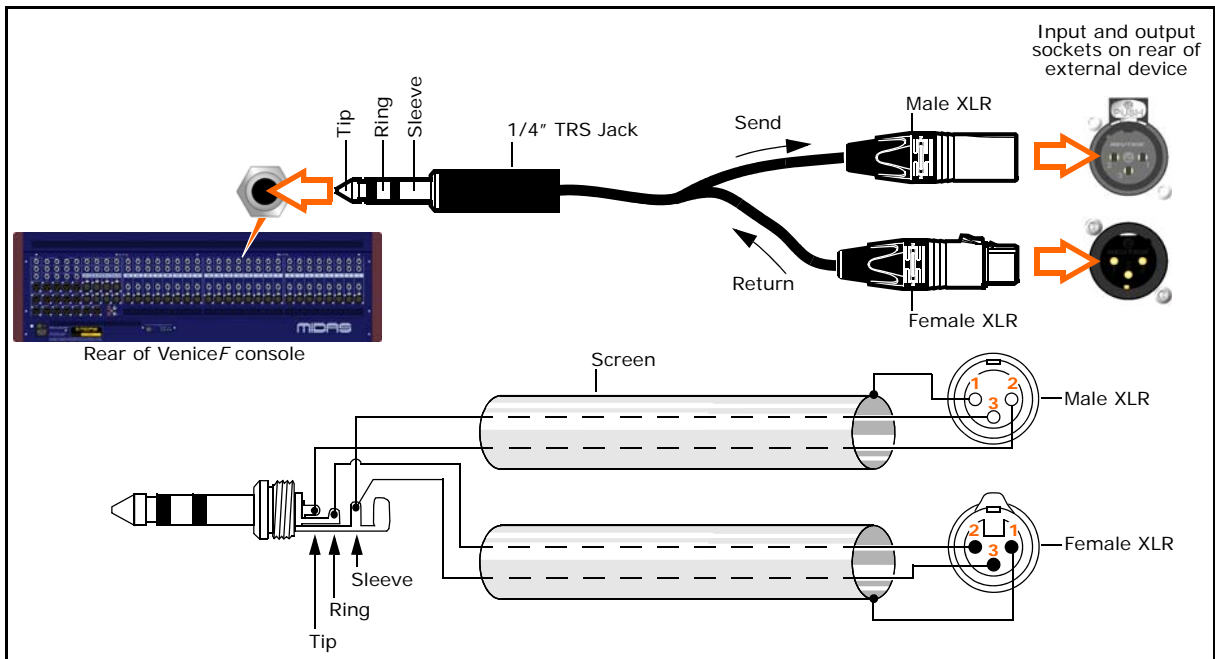

Figure 1: Connecting to balanced equipment

However, if you do have to connect to unbalanced devices, the following wiring is recommended for best results.

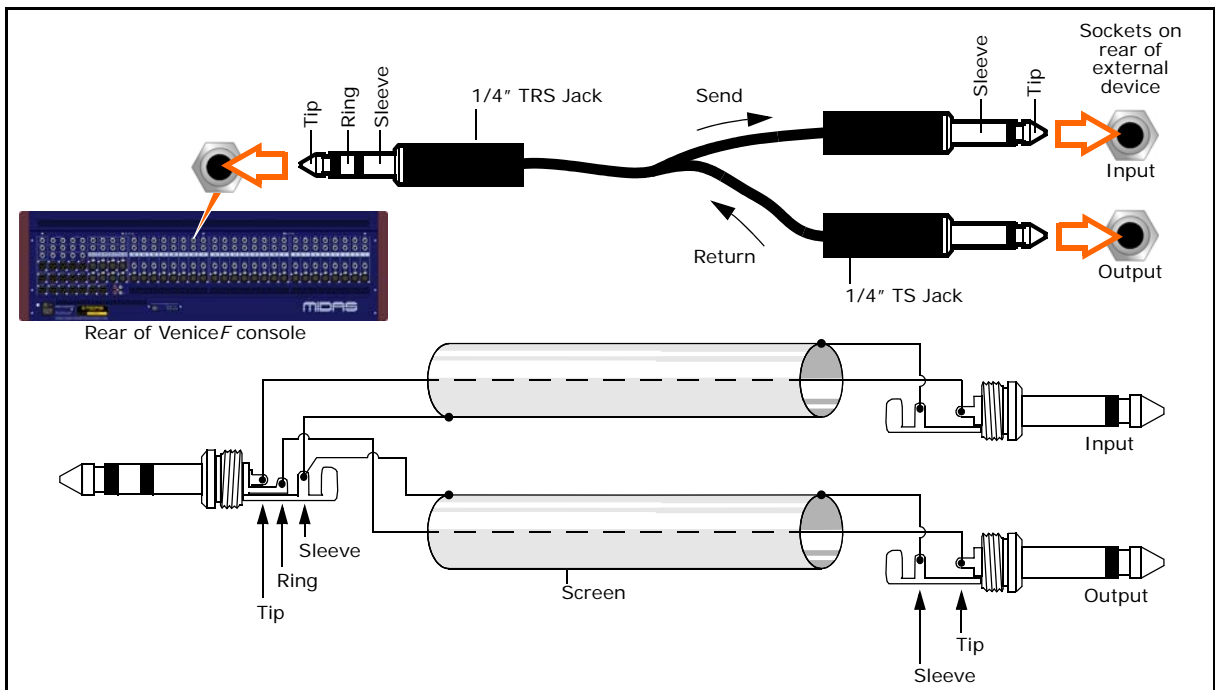
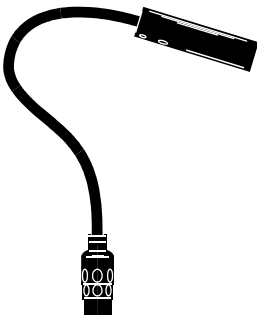







Figure 2: Connecting to unbalanced equipment

Important:
 If you have any audio problems, see Appendix E "Best Grounding Practice" on page 103.

Other connections

The section gives details of the other VeniceF interconnections.

Description	Example	Pinouts	Example of socket
4-pin, male XLR chassis connector(s) on the rear panel for connecting 12V/5W lamp(s)		1 = N/A 2 = N/A 3 = ground 4 = 12V	
1-off socket in the FireWire section of the rear panel for connecting a 6-pin, FireWire 400 connector		N/A	
<p>Important: If you have any audio problems these may be due to ground loops (see Appendix E "Best Grounding Practice" on page 103).</p>		1 (tip) = left 2 (ring) = right 3 (sleeve) = ground	
Headphones socket in the local monitor section of the control surface for connecting a 1/4" TRS Jack plug. There is also one under the armrest on the desktop versions.			

Setting up

There is no initial setting up required for the VeniceF console. However, if you want to use FireWire, you will need to set up your PC first (see Chapter 3 "Using The VeniceF With FireWire" on page 17).

Switching the VeniceF on/off

Switch the VeniceF on/off via the mains switch on the rear panel.

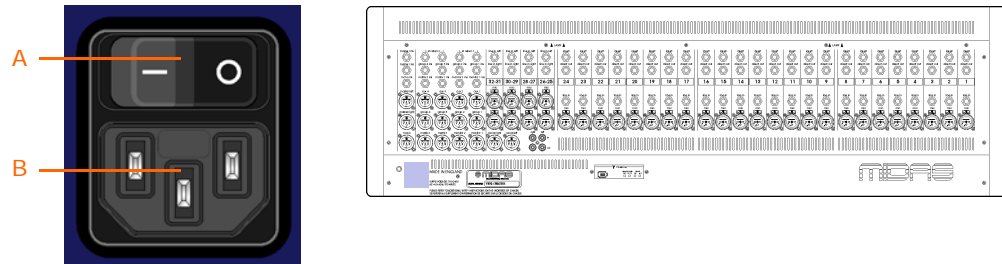

Mains power supply input on the rear panel. **A.** Mains on/off switch. **B.** Mains power supply socket (IEC connector).

Chapter 3: Using The VeniceF With FireWire

FireWire board hot plugging

! IMPORTANT! Do not connect or disconnect the FireWire cable to your VeniceF when the console is powered up, as this may result in damage to sensitive components. Always switch off the console before connecting or disconnecting the FireWire cable!

This chapter shows you how to prepare your PC/Mac for using FireWire, how to update the FireWire driver and how to troubleshoot FireWire. For information on how to use FireWire with the 'bundled' recording software, refer to the Software Application Guide.

Installing FireWire on a PC

It is strongly recommended that when connecting or disconnecting the Venice *F* to a PC/MAC/LAPTOP you do so in the following manner:

When Connecting the Venice *F*

- Ensure that the computer is turned OFF
- Ensure that the Venice *F* is turned OFF
- Connect your Venice *F* FireWire port to your computer's FireWire port
- Turn ON your Venice *F*
- Turn ON your Computer
- Turn ON your Monitor Speakers

When disconnecting the Venice *F*

- Shut down record software
- Turn OFF your monitor speakers
- Turn OFF your Venice *F*
- Disconnect your Venice *F*

This section shows how to install and set up FireWire on a PC running the Windows® operating system. This procedure comprises three main steps:

- "Step A — Installing the device driver on your PC"
- "Step B — Connecting the VeniceF to your PC"
- "Step C — Configuring the FireWire settings for the VeniceF"

Step A — Installing the device driver on your PC

! Do not connect the FireWire cable to the PC *before* installing the device driver.

Important:

Before installing the FireWire device driver, we recommend that you make sure it is the latest version by checking the www.midasconsoles.com website. This is important, as you may not be able to use FireWire properly with an older version of the device driver.

>> To install the FireWire device driver

- 1 The FireWire device driver software can be found on www.midasconsoles.com (Depending on your PC's configuration, a window may open asking you what you want Windows to do. If so, select the **Open folder to view files** option and then click **OK**.)
- 2 Double-click the "MidasFW-Installer.exe" file to start the setup wizard.
- 3 In the **Setup - Midas FW** window (right), click **Next**.

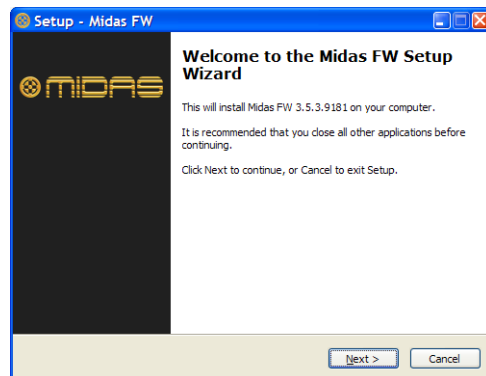

- 4 In the **Select Destination Location** window, click **Next**.
You can change the install location by typing it in or using the browse facility.

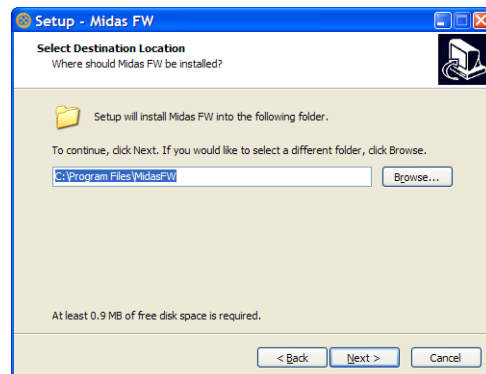

- 5 In the **Select Additional Tasks** window, click **Next**.
You can choose to create a desktop icon by selecting the **Create a desktop icon** option.

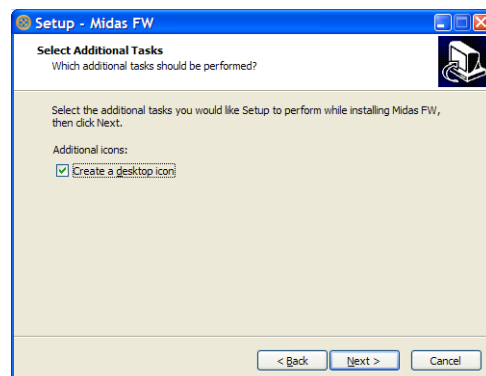

- 6 If the installer's release notes appear, close them. Then, in the **Ready to Install** window, check that the information is correct and click **Install**.

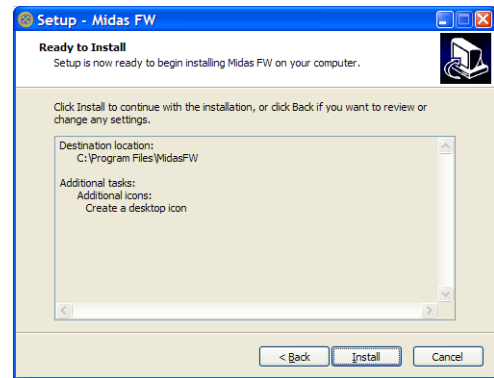

- 7 The **Installing** window will display the progress of the installation.

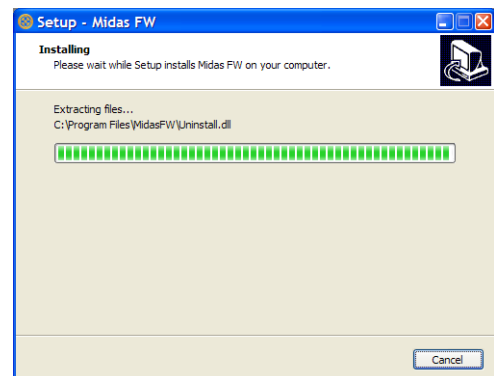

- 8 If the Windows "Logo testing" compatibility window appears, click **Continue Anyway**.

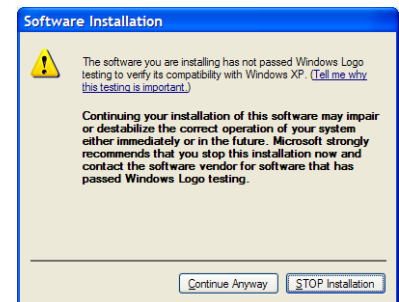

- 9 To complete the installation, select the **Yes, restart the computer now** option and then click **Finish**.

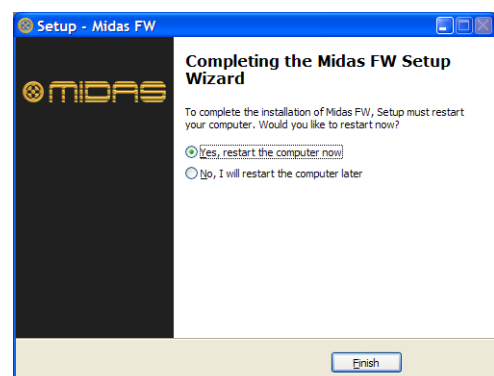

! You must restart your PC *before* using the VeniceF driver you have just installed.

After restarting your PC, proceed to the next step (see "Step B — Connecting the VeniceF to your PC" on page 20).

Step B — Connecting the VeniceF to your PC

Important:

The VeniceF must be switched off *before* the FireWire cable is connected to it.

When you use your PC with the VeniceF for the first time after installing the FireWire device driver, you will need to install the VeniceF device software. This is so that your PC will recognise the VeniceF whenever they are connected together.

>> To connect the PC to the console

! Do not attempt the following procedure until you have completed Step A (see "Step A — Installing the device driver on your PC" on page 17).

- 1 Switch off the VeniceF.
- 2 Connect the VeniceF to the PC using the appropriate FireWire cable, while observing the following precautions. Plug the 6-pin connector into the FireWire socket of the **FireWire** section on the rear of the console. Connect the other end of the cable into the PC.

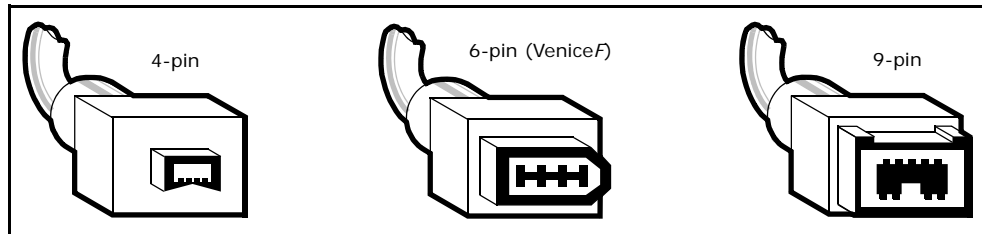

Figure 3: Some typical FireWire connectors

! Make sure you use the correct FireWire cable connector with your PC.

! When plugging the FireWire connector into your PC, make sure the connector is the correct way up and take great care not to exert too much force.

- 3 In the **Found New Hardware Wizard** window, select the **No, not this time** option and then click **Next**.



- 4 For standard installation, select the **Install the software automatically (Recommended)** option and then click **Next**.

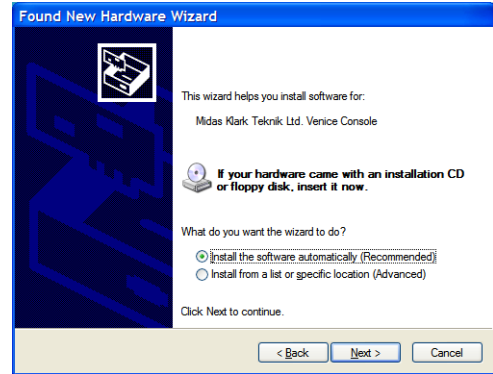

- 5 The wizard will perform a search for the correct driver. When it has finished, click **Next**.

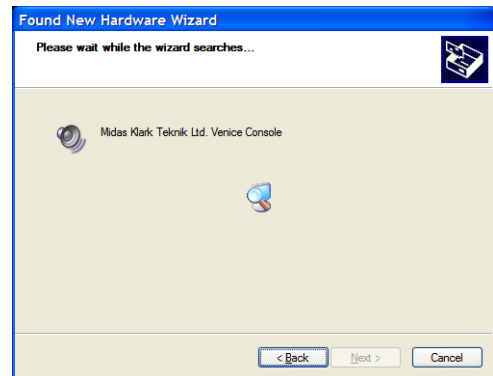

- 6 When the Windows "Logo testing" compatibility window appears, click **Continue Anyway**.

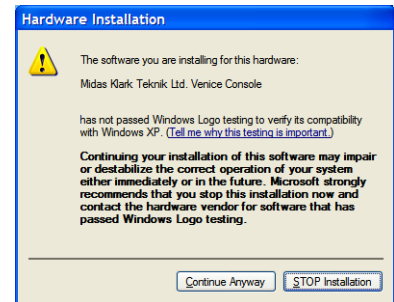

- 7 The driver will now be installed.

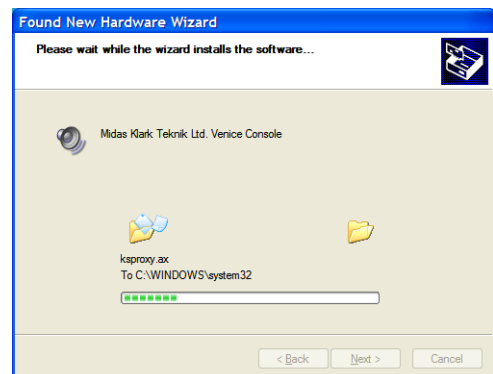

- 8 After the wizard has finished installing the driver, click **Finish**.

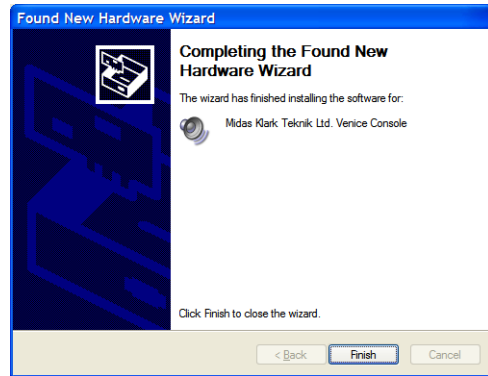

After the device hardware has been successfully installed, you will see a **Found New Hardware** balloon on your desktop.

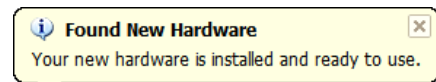

You are now ready to configure the VeniceF FireWire settings (see Step C below).

Step C — Configuring the FireWire settings for the VeniceF

In general, you should be able to use your recording software application on your PC/Mac quite successfully using the default FireWire settings. However, you can change the settings, if desired (for example, if you have audio problems), which is done in the **Midas FW** FireWire settings window.

Configuration of the VeniceF's FireWire settings involves opening the **Midas FW** settings window, selecting your desired options and then closing the window.

>> To open the Midas FW settings window

- 1 On your PC/Mac desktop, double-click the **Midas FW** icon.
- 2 If no devices are found, you will see the message shown right. Make sure the PC/Mac and console are properly connected together with the FireWire cable, and then click **ok**.
- 3 The **Midas FW** settings window will open. In the **Devices** section you should see the Venice icon (shown right).

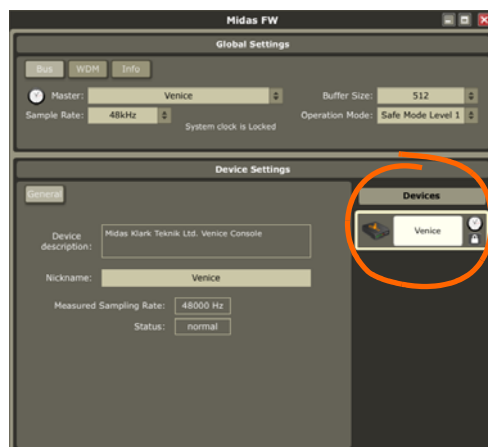

>> To change the FireWire settings

Use the drop-down lists and buttons on the **Midas FW** settings screen to change the FireWire settings, as desired, using the following diagram and the accompanying list of associated elements to guide you.

Note: The settings available for configuration may be dependent on a number of variables, such as the hardware specification of the PC, the type of operating system you are using, the recording software application, etc. The setting you may want to adjust may be available for change in the recording software application itself.

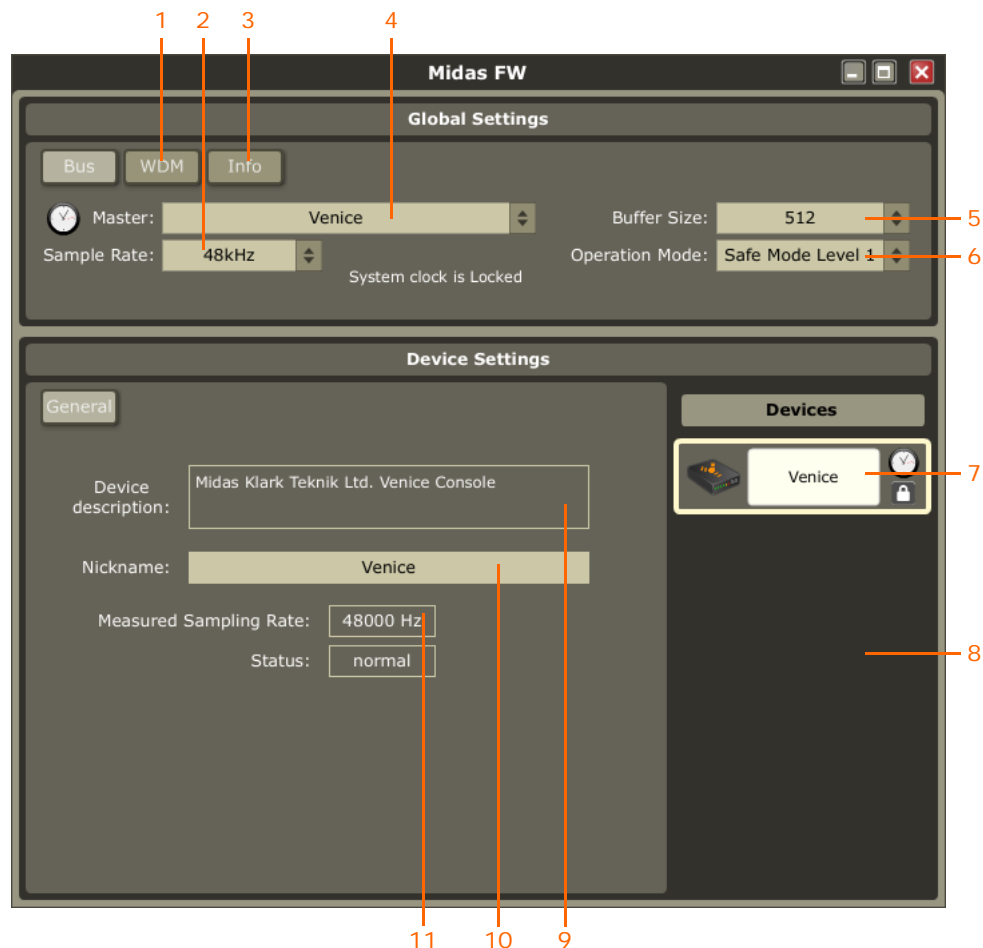

Mains elements of a typical **Midas FW** screen (PC version)

Item	Element	Description
1	WDM button	The WDM ¹ button lets you select a different audio device driver, such as Sonar.
2	Sample Rate drop-down list	This drop-down list lets you select the sample rate (samples per second) for the VeniceF. Options are 44.1kHz and 48kHz.
3	Info button	Use this button to check the software version of the driver.
4	Master drop-down list	This drop-down list shows the clock source. (This will be always be set to Venice .)

<i>Item</i>	<i>Element</i>	<i>Description</i>
5	Buffer Size drop-down list	This drop-down list lets you select the buffer size that the PC/Mac will use for the recording software.  <i>Select buffer size according to your equipment, remembering that if it is too small you will suffer audio clicks and pops, and if it is too large there will be audible delays (latency).</i>
6	Operation Mode drop-down list	This drop-down list lets you select another operating mode if you are having problems with the audio. (Default = normal.)
7	Venice icon	This icon shows you that the PC/Mac recognises the connected device as a VeniceF and that the connection is good.
8	Devices panel	This panel shows you what FireWire device(s) are connected to your PC/Mac. If the message “no devices found” appears in this panel, see “No devices found” on page 29.
9	Device description field	This field gives details of the selected device.
10	Nickname field	This field gives a shortened description of the selected device.
11	Measured Sampling Rate field	This field shows the sampling rate of the currently connected device.

1. Windows Driver Models (WDMs) are audio device drivers for the Microsoft® Windows® family of operating systems.

>> To select an option from a drop-down list

Click the up/down arrow box of the drop-down list to open it, and then click the desired option.

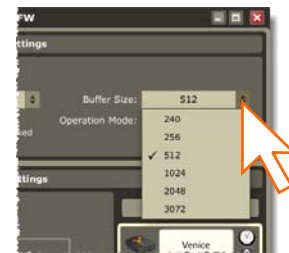

>> To close the Midas FW window

Click “X” at the upper-right corner of the **Midas FW** window.

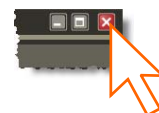

Installing FireWire on a Mac

It is strongly recommended that when connecting or disconnecting the Venice *F* to a PC/MAC/LAPTOP you do so in the following manner:

When Connecting the Venice *F*

- Ensure that the computer is turned OFF
- Ensure that the Venice *F* is turned OFF
- Connect your Venice *F* FireWire port to your computer's FireWire port
- Turn ON your Venice *F*
- Turn ON your Computer
- Turn ON your Monitor Speakers

When disconnecting the Venice *F*

- Shut down record software
- Turn OFF your monitor speakers
- Turn OFF your Venice *F*
- Disconnect your Venice *F*

This section shows how to install and set up FireWire on a Mac. This procedure comprises the following main steps:

- "Step A — Installing the device driver on your Mac"
- "Step B — Connecting the VeniceF to your Mac"
- "Step C — Configuring the FireWire settings for the VeniceF"

Step A — Installing the device driver on your Mac

! Do not connect the FireWire cable to the Mac *before* installing the device driver.

Important:

Before installing the FireWire device driver, we recommend that you make sure it is the latest version by checking the www.midasconsoles.com website. This is important, as you may not be able to use FireWire properly with an older version of the device driver.

>> To install the FireWire device driver

- 1 The FireWire device driver software can be found on the MIDAS website.

- 2 On your Mac, navigate to the drivers sections of the website.
- 3 In the "MidasFW-x.x.x-xxxx-osx" folder, double-click the "MidasFW.dmg" file.
- 4 In the disk image file window, double-click the "MidasFW-x.x.x-xxxx.pkg" package file to start the Midas FW driver installer.
- 5 At the **Introduction** stage of the installation procedure, observe the driver release notes and then click **Continue**.
- 6 If your Mac has another hard drive connected, the **Destination Select** stage will let you select another install location. Otherwise, go to the next step.
- 7 At the **Installation Type** stage, click **Install**. (If a password window appears, enter your password and continue.)

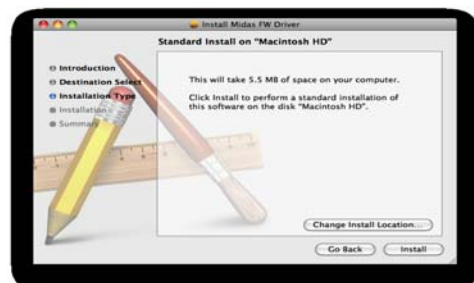
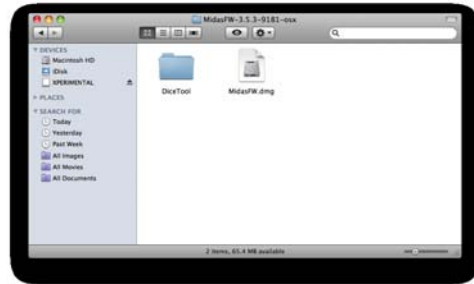

- 8 At the **Installation** stage, click **Continue**. Your Mac will start installing the driver.



- 9 After the driver has been installed successfully, your Mac will display the window shown right at the **Summary** stage. Click **Restart**.

Your Mac will reboot automatically. After it has restarted it is ready to use.



! You must make sure that you Mac has restarted *before* using the VeniceF driver you have just installed.

Step B — Connecting the VeniceF to your Mac

Important:

The VeniceF must be switched off *before* the FireWire cable is connected to it.

>> To connect the Mac to the console

! Do not attempt the following procedure until you have completed Step A (see “Step A — Installing the device driver on your Mac” on page 25).

- 1 Switch off the VeniceF.
- 2 Connect the VeniceF to the Mac using the appropriate FireWire cable (see Figure 3 “Some typical FireWire connectors” on page 20), while observing the following precautions

! Make sure you use the correct FireWire cable connector with your Mac.

! When plugging the FireWire connector into your Mac, make sure the connector is the correct way up and take great care not to exert too much force.

Step C — Configuring the FireWire settings for the VeniceF

In general, you should be able to use your recording software application quite successfully using the default FireWire settings. However, you can change the settings if you want (for example, if you have audio problems) in the **Midas FW** FireWire settings window. For details of how to configure the VeniceF's FireWire settings, see “Step C — Configuring the FireWire settings for the VeniceF” on page 22.

Updating the FireWire driver

The latest version of the FireWire driver for the VeniceF will be available on the Midas website (address is on the front cover of this manual).

>> To update your PC/Mac with the latest driver

- 1 Download the latest VeniceF FireWire driver from the Midas website onto your PC/Mac. There should be two drivers available — one each for a PC and Mac — so make sure you download the correct one.
- 2 Install the latest VeniceF FireWire driver (see “Installing FireWire on a PC” on page 17 or “Installing FireWire on a Mac” on page 25). You don't have to uninstall the existing VeniceF FireWire driver, as this it will be overwritten by the new one.

Troubleshooting FireWire

The following subsections may help you overcome any problems that may arise when using FireWire.

Audio problems

If you encounter any problems with the audio, for example, when recording, try changing the FireWire settings (see "Step C — Configuring the FireWire settings for the VeniceF" on page 22).

No devices found

Important:

The VeniceF must be switched off *before* the FireWire cable is connected to it.

If you see a 'no devices found' message, it means that the PC cannot detect a FireWire device. To clear the message, do one of the following:

- Connect the VeniceF to the PC.
- If the VeniceF is already connected to the PC, check that the connections are good.

Overcoming ground loop problems

See Appendix E "Best Grounding Practice" on page 103. *F*

Chapter 4: Working With The Console

The following chapters give a description of the controls on the console surface and include useful operating information.

- Chapter 5 "Mono Input Channel" on page 31
- Chapter 6 "Dual Stereo Input Channel" on page 43
- Chapter 7 "Output Section" on page 53

Before using FireWire, read Chapter 3 "Using The VeniceF With FireWire".

Ground loop problems

In the event of ground loop problems, disconnect the signal screen at one end of the connecting cables. Note that this can only be done when the equipment is used with balanced cable systems. For more information, see Appendix E "Best Grounding Practice" on page 103.

Chapter 5: Mono Input Channel

This chapter details the mono input channels (8/16/24) of the VeniceF. It describes the sections of each channel on the control surface and the related connectors on the rear panel.

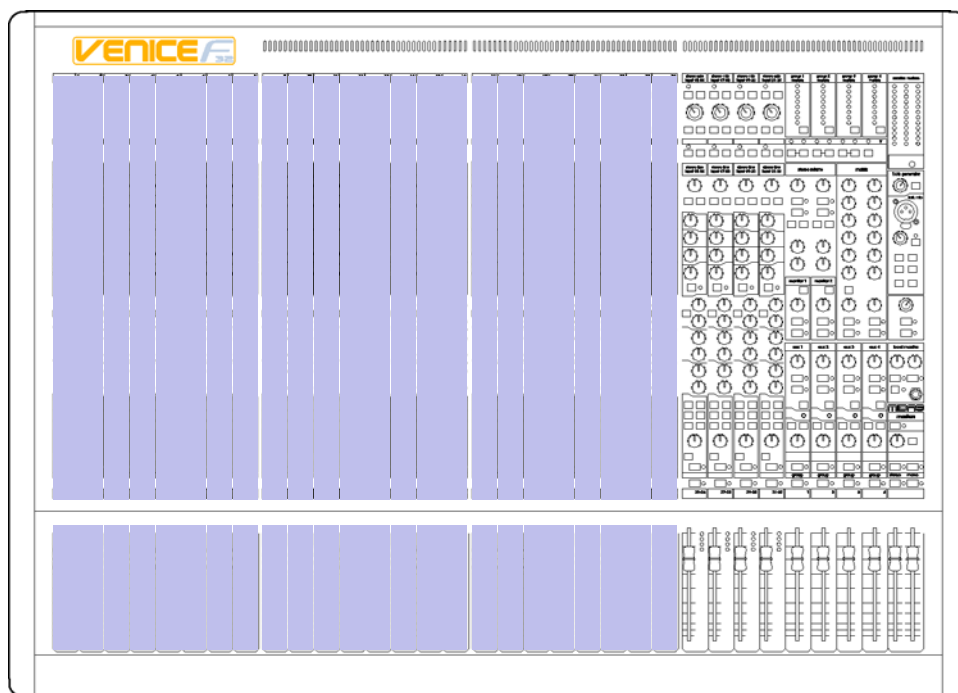

Mono input channels on the control surface (F32 shown)

Although the actual number of mono input channels on your VeniceF will depend upon your choice of frame, their function remains the same.

Overview of the mono input channel

Each mono channel has an XLR input that can be used for mic or line level signals up to +32dBu. An additional 1/4" inch TRS Jack socket, provides an input for line level signals that require protection against accidental 48-volt connection. The line input gives 10dB of permanent attenuation to the input signal, which allows the connection of extremely high line level signals of up to +42dBu with the pad engaged.

Item	Section
1	Gain (see "Gain" on page 34)
2	FireWire and direct output section (see "FireWire" on page 35)
3	Insert and EQ (see "Insert" on page 35 and "EQ" on page 36)
4	Monitor and aux contributions (see "Monitors" on page 37 and "Auxes" on page 38)
5	Pan and routing (see "Pan, routing, mute and solo" on page 39)
6	100 mm fader and meter (see "Fader and meter" on page 41)

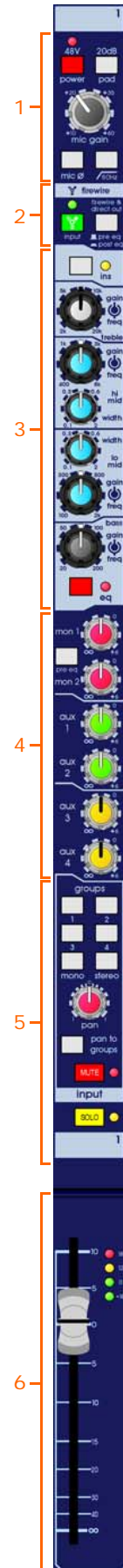

Rear panel

The VeniceF channel inputs are located on the rear panel of the console and each channel comprises the following.

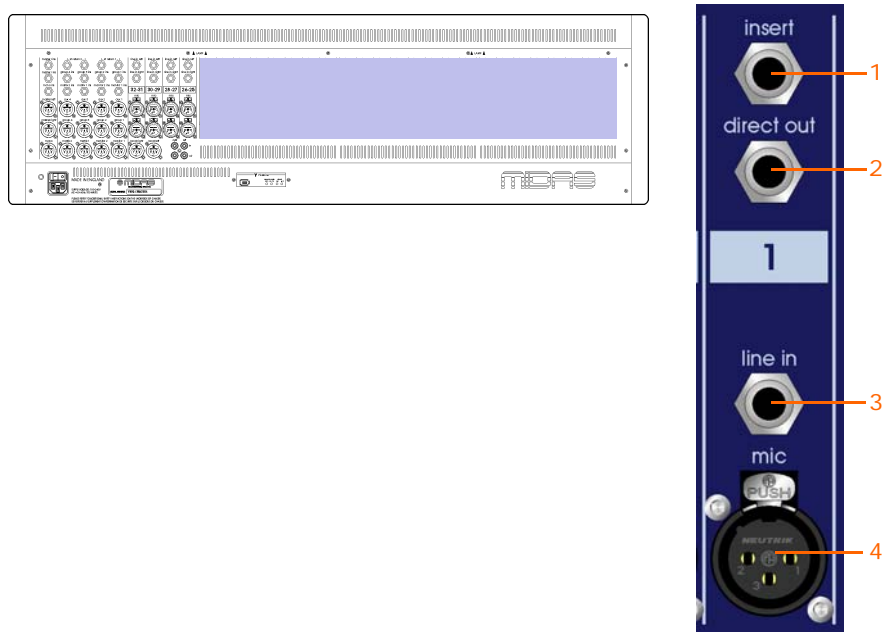

Mono input channel connectors

<i>Item</i>	<i>Description</i>
1	insert connector Insert point on a single 1/4" TRS Jack socket. This is unbalanced and requires a conventionally-wired insert lead.
2	direct out connector Direct output on a single, balanced 1/4" TRS Jack socket.
3	line in connector Line in on a single, balanced 1/4" TRS Jack socket.
4	mic connector Mic input on a single, balanced XLR female chassis connector.

The direct out and insert points operate at a nominal level of 0dBu.

Balanced XLR and Jack inputs are conventionally wired (see Table 1 "Connector pinouts" on page 12).

Gain

This section lets you adjust the level of the mic input signal, switch on 48 volts phantom power for the mic, attenuate the input signal by 20dB, invert the mic polarity and enable the high pass filter on the mic input.

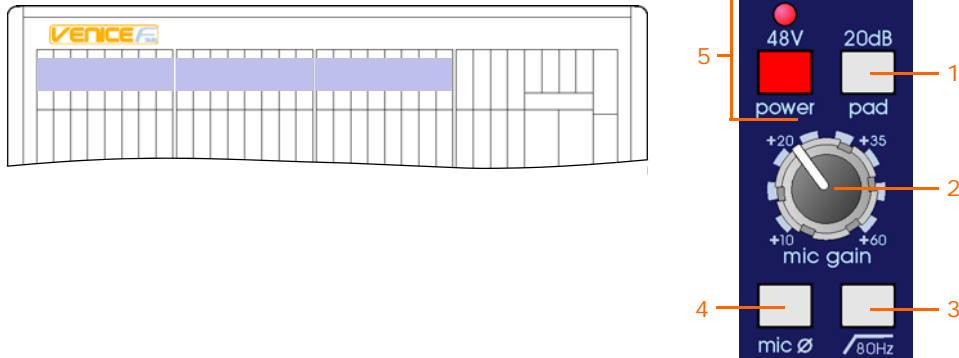

Mic gain section of the mono input channels

<i>Item</i>	<i>Description</i>
1	20dB pad switch This pad switch provides 20dB attenuation to the input signal, allowing for the connection of high output microphones and line level signals without overloading the channel input amplifier. Overloads are indicated on the meter by the red LED at the top (see "Fader and meter" on page 41).
2	mic gain control knob The mic gain is continuously variable from +10dB to +60dB (-10dB to +40dB with the pad enabled). The actual value of the gain required will depend upon the source and should ideally be set such that peaks in level on the input should not cause the input amplifier to overload (occasional peaks of +12dB are OK, but +18dB is too high).
3	80Hz switch The hi pass switch inserts the 80Hz hi pass filter in the input channel signal path before the insert point and EQ. This is commonly used to remove handling noise from a mic, bass rumble through coupling with the stage or any unwanted low frequency audio.
4	mic Ø switch This is a microphone polarity switch that causes a 180-degree phase change (with respect to the input signal) to occur in the input amplifier such that the channel signal will have opposite polarity to the input signal. The mic Ø switch is commonly needed where two microphones are used facing each other (for example, when using a microphone on both the top and bottom of a snare drum). Ordinarily the two microphones would be out of phase causing cancellation when the console sums the two signals into the output. Reversing the phase of one signal causes the microphones to have the same phase and no cancellation.
5	48V LED and power switch The power switch applies 48 volts of phantom power to the microphone input. This is used to power condenser microphones, direct inject boxes and other devices that require phantom power. The 48V LED illuminates to show that phantom power is on.

FireWire

This section lets you select the channel input source as mic/line (analogue) or FireWire (digital) and select the FireWire output signal as pre-EQ or post-EQ. For more information on FireWire, see Chapter 3 "Using The VeniceF With FireWire" on page 17.

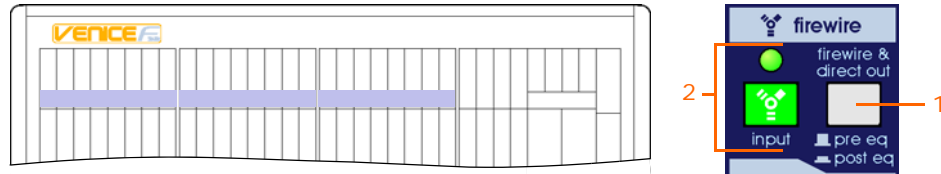

FireWire section of the mono input channels

Item	Description
1	<p>input switch and green LED The green FireWire input switch breaks the mic and line signals, making the channel input FireWire only and, effectively, creating a FireWire insert point (when combined with the FireWire direct output). The green LED illuminates to show when the switch is on.</p> <p>Important: To avoid a feedback loop, take care not to switch FireWire sends to post-EQ when using FireWire inputs as digital insert returns.</p>
2	<p>firewire & direct out switch Switches the signal, which is routed to the FireWire output and direct out, to pre-EQ (button out) or post-EQ (button in).</p>

Insert

This insert switch enables the channel's analogue insert point, by connecting the insert return to the channel signal path. This lets you use traditional compressor, gates or other dynamic and signal processors or effects with the console. The yellow LED illuminates to show when the insert is enabled.

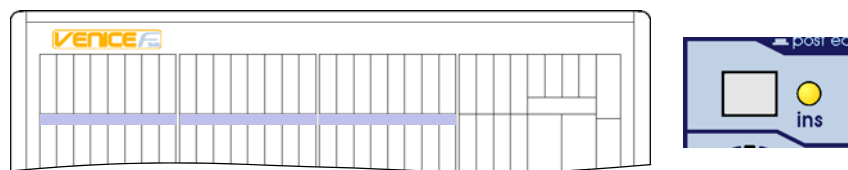

Insert section of the mono input channels

EQ

Each mono input channel of the VeniceF has a four-band, swept EQ, allowing tonal control over the input signal.

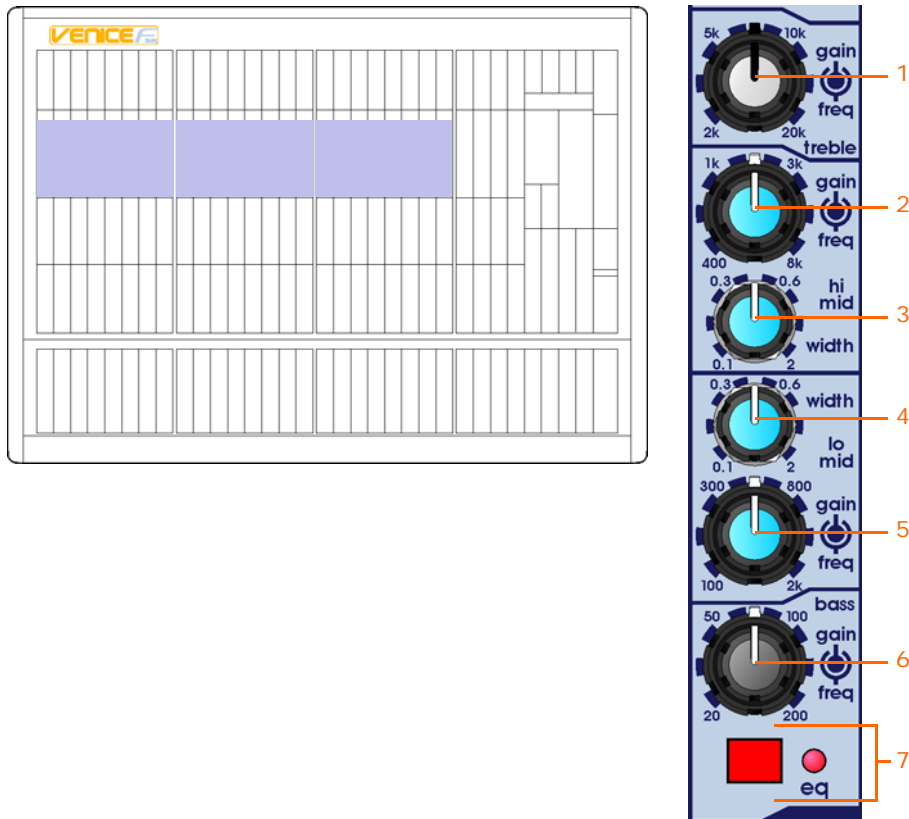

EQ section of the mono input channels

Item	Description
1	<p>Treble gain/freq control knob This dual-concentric control knob adjusts the gain/frequency of the treble EQ:</p> <ul style="list-style-type: none"> • gain The top control knob adjusts the gain of the treble band, which is continuously variable from -15dB to +15dB with a centre detent of 0dB. • freq The bottom control knob adjusts the centre frequency of the treble band, which is continuously variable from 2kHz to 20kHz.
2	<p>Hi mid gain/freq control knob This dual-concentric control knob adjusts the gain/frequency of the hi mid EQ:</p> <ul style="list-style-type: none"> • gain The top control knob adjusts the gain of the hi mid band, which is continuously variable from -15dB to +15dB with a centre detent of 0dB. • freq The bottom control knob adjusts the centre frequency of the hi mid band, which is continuously variable from 400Hz to 8kHz.
3	<p>Hi mid width control knob This hi mid control knob adjusts the filter bandwidth.</p>
4	<p>Lo mid width control knob This lo mid control knob adjusts the filter bandwidth.</p>

<i>Item</i>	<i>Description</i>
5	<p>Lo mid gain/freq control knob This dual-concentric control knob adjusts the gain/frequency of the lo mid EQ:</p> <ul style="list-style-type: none"> • gain The top control knob adjusts the gain of the lo mid band, which is continuously variable from -15dB to +15dB with a centre detent of 0dB. • freq The bottom control knob adjusts the centre frequency of the lo mid band, which is continuously variable from 100Hz to 2kHz.
6	<p>Bass gain/freq control knob This dual-concentric control knob adjusts the gain/frequency of the bass EQ:</p> <ul style="list-style-type: none"> • gain The top control knob adjusts the gain of the bass band, which is continuously variable from -15dB to +15dB with a centre detent of 0dB. • freq The bottom control knob adjusts the centre frequency of the bass band, which is continuously variable from 20Hz to 200Hz.
7	<p>EQ switch and red LED The EQ switch enables the EQ. With EQ disabled, adjustment of the EQ controls has no effect. This can be used to compare the sound with and without EQ. The red LED illuminates to show that EQ is enabled.</p>

Monitors

The two monitor sends per input channel have the same functionality as the auxes (see “Auxes” on page 38). However, they have the following additional features:

- They can be sourced pre-EQ.
- They can be metered individually (see “Monitors” on page 64).
- They can receive a contribution from the stereo returns (see “Stereo returns” on page 63).
- They have individual talk buttons (see “Signal generator and talkback” on page 68).

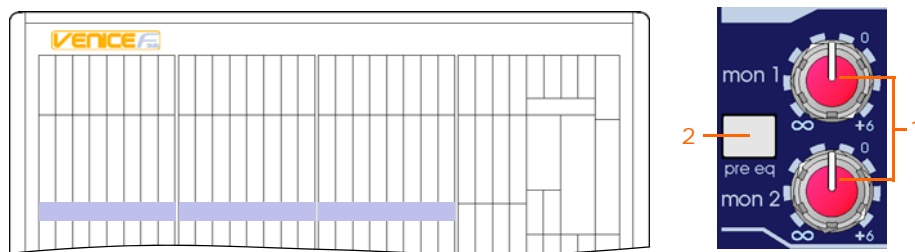

Monitor section of the mono input channels

<i>Item</i>	<i>Description</i>
1	<p>Monitor control knob The monitor control knobs give continuous adjustment of the signal sent from the input channel to the monitor buses (default is post-fader and post-EQ) in the range ∞ (infinity/off) to +6dB.</p>
2	<p>pre eq switch Changes the source of the monitor sends to pre-EQ, provided the bus is set to be pre-fader via the pre switch in the output section (see “Monitors” on page 64).</p>

Either monitor send can be sourced pre-fader globally using the **pre** switch in the output section (see “Monitors” on page 64).

Auxes

The VeniceF has four aux sends per input channel, which can be used for effects sends, monitors or as extra assignable outputs from the console. Each aux has a control knob that gives continuous adjustment of the level sent from the input channel to the aux buses, in the range ∞ (infinity/off) to +6dB.

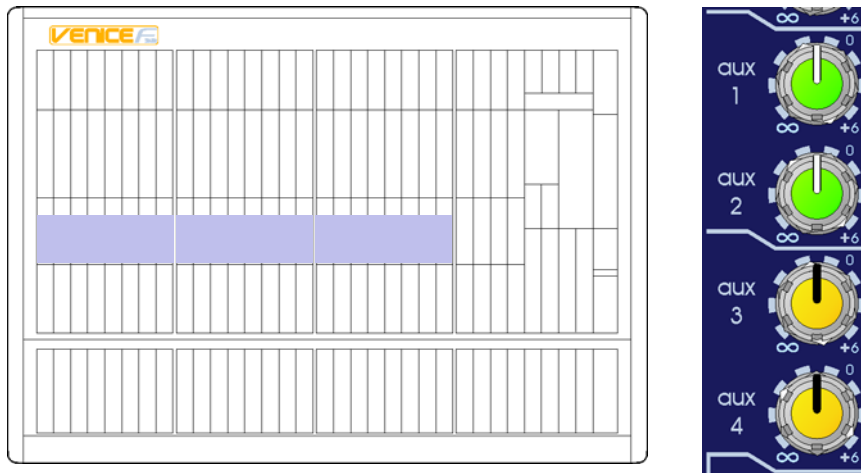

Aux sections of the mono input channels

Auxes are post-EQ and post-fader, but each of the four aux buses can be independently switched globally to pre-fader using the **pre** switch in the outputs section (see “Auxes” on page 65).

- **Post-fade** aux sends are sourced after the channel insert, mute, EQ and channel fader. As a result, the actual level sent to the aux bus is proportional to the aux send control *and* the channel fader.
- **Pre-fade** aux sends are sourced after the channel insert, mute and EQ, but before the channel fader. As a result, the actual level sent to the aux bus is proportional to the aux send control only.

The following table shows some typical uses for auxes.

Application	Pre-/Post-fade	Reason
Stage monitors	Pre-fade (post-EQ)	The level in the monitor stays constant, so that the engineer can change the FOH fader level without affecting the performer.
Effect sends	Post-fade (post-EQ)	The level sent to the effects is proportional to the level on the fader, so the balance between wet (processed) and dry (unprocessed) sound stays the same, even when the channel level is changed.
Mixed recording	Post-fade (post-EQ)	If the aux is set to unity the FOH mix is replicated on the aux output. This includes EQ, but excludes pan.

Pan, routing, mute and solo

The VeniceF is a flexible mixing console with four group buses plus stereo and mono.

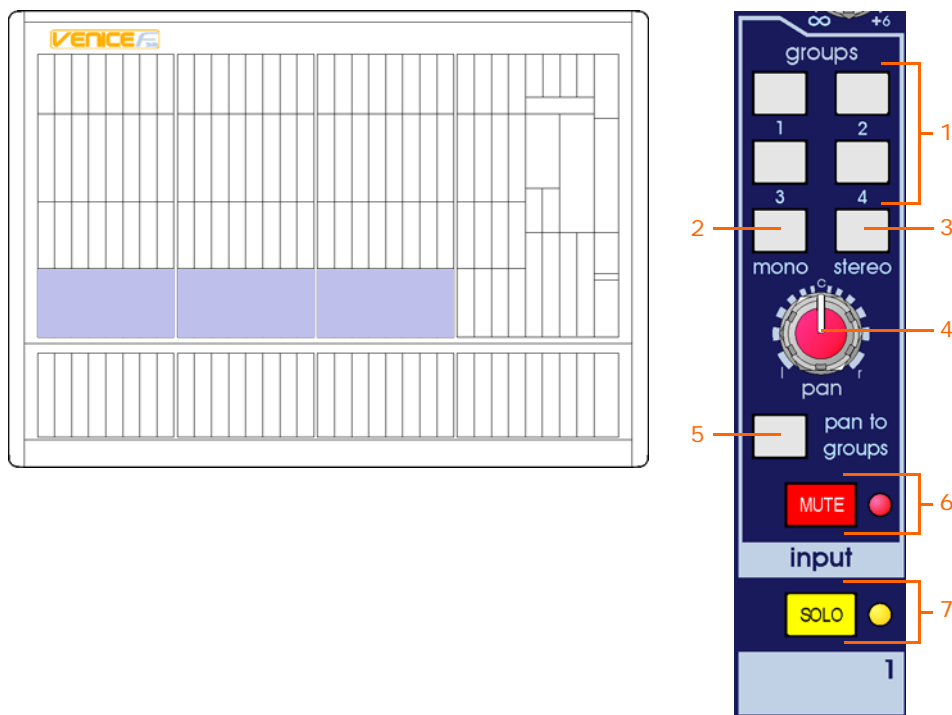

Groups and solo sections of the mono input channels

Item	Description
1	Group switches Each group switch routes the channel signal to its associated group bus (as described later in this section).
2	mono switch This switch routes the channel signal to the mono bus (post-EQ, post-mute and post-fader).
3	stereo switch Routes the channel signal to the stereo master bus (post-EQ, post-pan, post-mute and post-fader).
4	pan control knob The pan control allows the channel signal to be positioned in a stereo field when routed to the stereo bus, or when group sends are configured to be stereo. The pan control allows continuous adjustment of the image from hard left, to hard right with a centre detent, and obeys a constant power law (that is, -3dB at the centre).
5	pan to groups switch The VeniceF's group sends may be configured by pressing this switch for stereo group operation or released for mono group mode (as described later in this section).
6	MUTE switch and red LED The MUTE switch mutes the channel signal. The signal will still be sent to the insert point and to the direct output. The mute LED illuminates to show that the MUTE switch is on.
7	SOLO switch and yellow LED With solo enabled the channel signal is sent to the after-fade listen (AFL) stereo and pre-fade listen (PFL) mono buses. The left and right local monitor outputs can be used, for example, when operating from within a booth to hear selected solos and not the whole mix. The solo LED illuminates to show when a solo is on.

The signal can be routed to any of the four group buses by pressing the corresponding group select switch.

Group routing, which is post-EQ, post-mute and post-fader, can be configured in either of two modes:

- **Pre-pan (mono)** Each group is sent the same mono signal, so that, for example, selecting 1, 2 and 3 will send to each group equally.
- **Post-Pan (stereo)** Each pair of groups behave as if they were stereo groups. The mono signal is positioned in a stereo field by the pan control. The left signal is routed to the odd numbered bus and the right signal to the even numbered bus. Selecting groups 1, 2 and 3 with pan hard left will result in the signal being routed to groups 1 and 3 only. Similarly, with pan hard right, the signal will be sent only to group 2.

This configuration is made by pressing the **pan to groups** button for stereo group operation or released for mono group mode.

This selection, however, is on a channel-by-channel basis and so some may be assigned to the groups as mono or as stereo, depending upon the desired usage. For example:

<i>Application</i>	<i>Configuration</i>	<i>Reason</i>
Submix	Stereo	Submix of drum kit.
Submix	Mono	Vocals with inserted compressor (multiple vocals feed the same compressor).

Fader and meter

The VeniceF has a 100 mm fader and a four-LED signal meter per mono input channel.

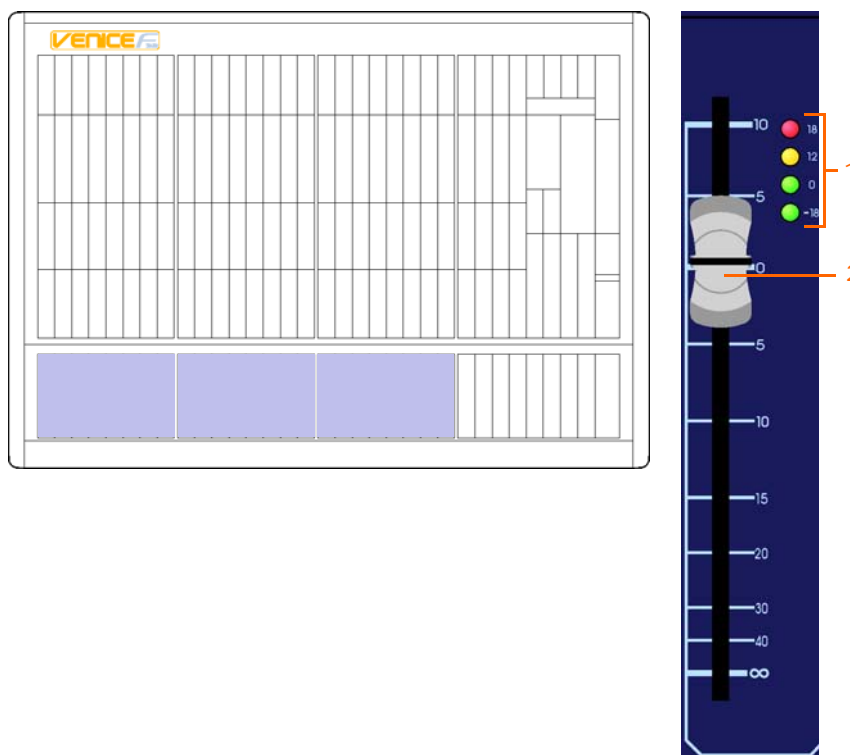

Fader section of the mono input channels

Item	Description
1	LED meter These four LEDs comprise the input channel meter, which lets you monitor the input signal without having to use the PFL. The red +18 LED will also show any overload activity on the FireWire and direct output.
2	Fader This channel fader allows for continuous adjustment of the channel level from ∞ (infinity/off) to +10dB. At 0dB the output of the channel to the stereo, mono and group buses will be at unity, that is, no adjustment in level from the input.

The meter is especially useful when setting the microphone gain of a channel. Also, as the meter is post-EQ, it is possible to see the effect that the channel equalisation has upon the level. It may be necessary to turn the input gain down when excessive EQ is used to prevent the channel from overloading.

The LEDs represent the following:

- **18 (red):** +18dB, overload (peak). This LED also monitors the FireWire/insert send signals to highlight any possible digital clipping that may be masked by attenuation in the EQ stages.
- **12 (yellow):** +12dB, high level.
- **0 (green):** 0dB, normal level.
- **-18 (green):** -18dB, shows that a signal is present.

Note: The meter and direct output, which are fed from the same source, are post-insert and switchable pre-EQ/post-EQ, but pre-fader and pre-mute. They are both unaffected by the channel mute.

Chapter 6: Dual Stereo Input Channel

This chapter details the dual stereo input channels of the VeniceF. It describes the sections of each dual stereo channel on the control surface and the related connectors on the rear panel.

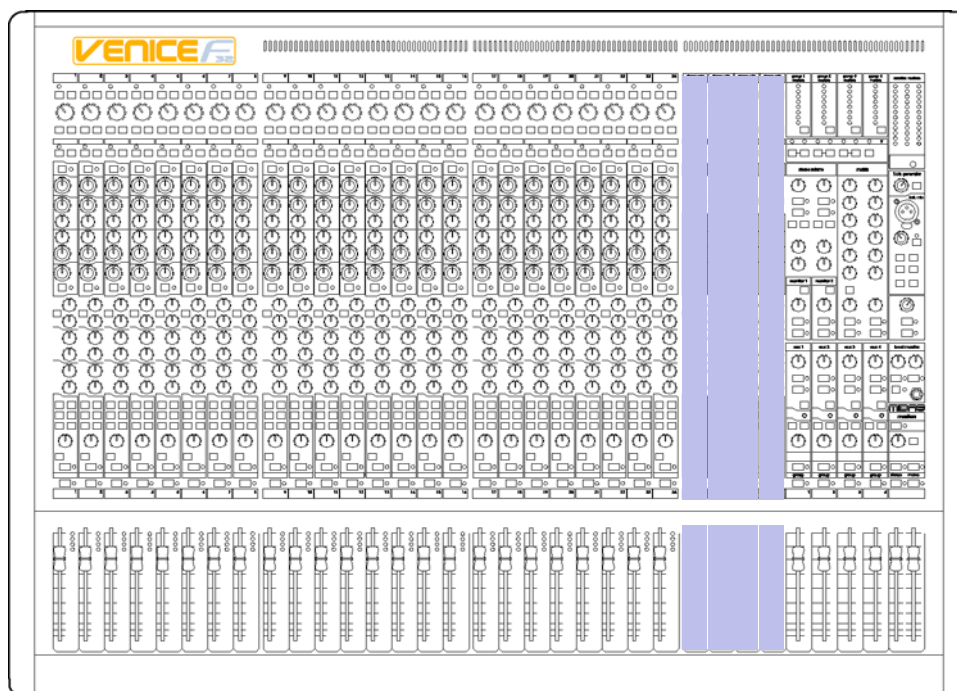

Dual stereo input channels on the control surface

All types of VeniceF have four pairs of dual stereo input channels.

Overview of the dual stereo input channel

The VeniceF dual stereo channel (shown right) is equipped with two XLR inputs, which are used for mic/line level signals up to +32dBu. Two 1/4" TRS Jack sockets provide inputs for line level signals that require protection against accidental 48-volt connection. The line inputs accept signals up to +28dBu and have +20dB of gain available.

Item	Section
1	Stereo mic input gain (see "Gain (stereo mic inputs)" on page 46).
2	FireWire (see "FireWire" on page 46).
3	Stereo line input gain (see "Stereo line inputs" on page 47).
4	EQ (see "EQ" on page 48).
5	Monitors and auxes (see "Monitors" on page 49 and "Auxes" on page 49).
6	Groups, panning and solo (see "Pan, routing, mute and solo" on page 50 and "Fader and meter" on page 52).
7	Fader (see "Fader and meter" on page 52).

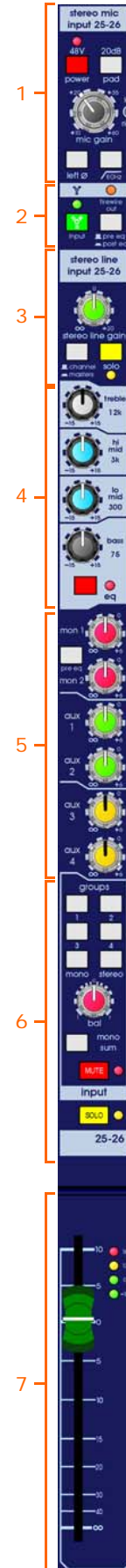

Rear panel

The VeniceF channel inputs are located on the rear panel of the console.

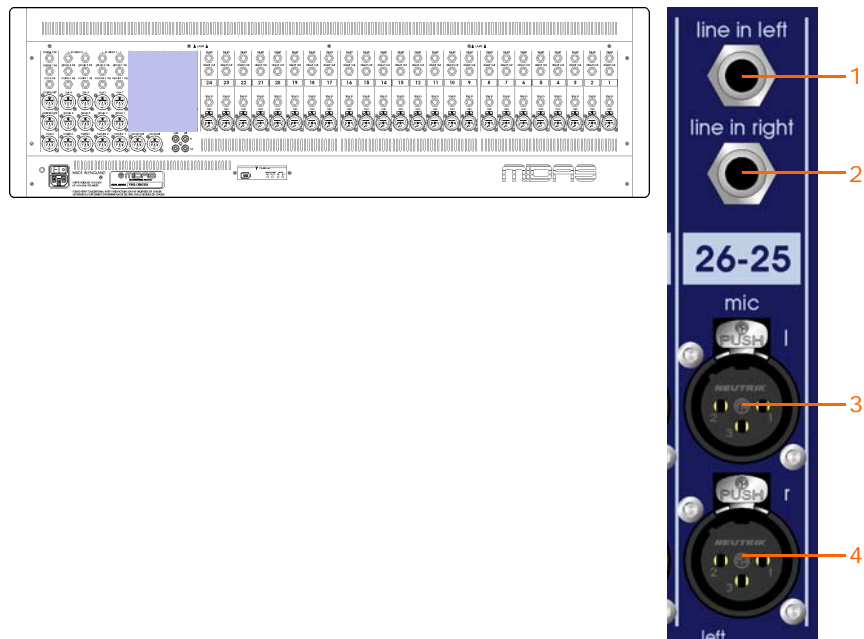

Dual stereo input channel connectors

<i>Item</i>	<i>Description</i>
1	line in left Line in on a single, balanced 1/4" TRS Jack socket.
2	line in right Line in on a single, balanced 1/4" TRS Jack socket.
3	mic I Mic input on a single, balanced XLR female chassis connector.
4	mic r Mic input on a single, balanced XLR female chassis connector.

Gain (stereo mic inputs)

This section has the same functionality as the gain section of the mono input channels except for the following. For full details, see “Gain” on page 34.

- **20dB pad switch** On dual stereo input channels the pad switch has no effect upon the left and right line levels. Overloads are indicated on the meter by the red LED at the top (see “Fader and meter” on page 52).
- **mic gain control knob** This is a dual-concentric **mic gain** knob. The adjacent **left/right** symbol informs you that top control knob adjusts the left channel and the bottom one adjusts the right channel.
- **80Hz switch** On dual stereo channels, this switch has no effect upon the left and right line inputs.
- **left Ø switch** On dual stereo channels, this microphone phase switch causes a 180-degree phase change (with respect to the input signal) in the left input amplifier only, such that the channel signal will have opposite polarity to the input signal. This switch has no effect upon the left and right line inputs.

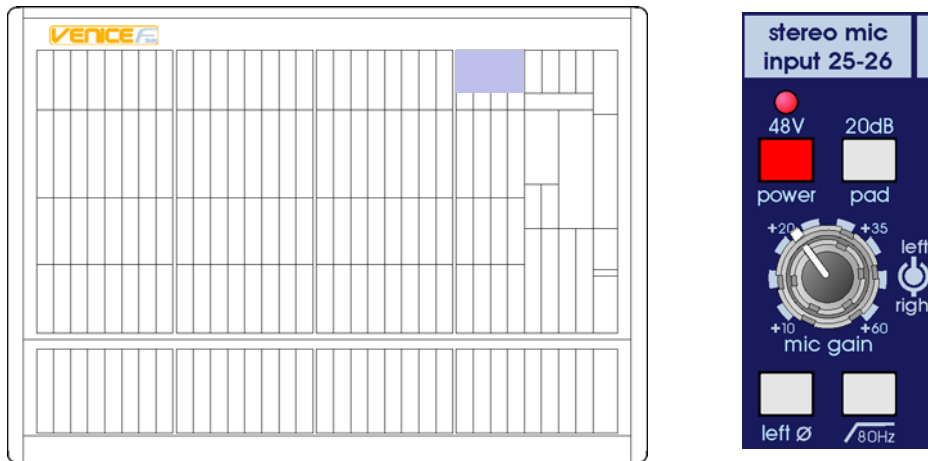

Mic gain section of the dual stereo input channels

FireWire

Similarly to the mono input channel, this section lets you select the channel input source as mic/line (analogue) or FireWire (digital) and select the FireWire output signal as pre-EQ or post-EQ (see “FireWire” on page 35). In addition, this section has an orange **firewire out** LED that shows you whether or not the FireWire signal is sourced from the local dual stereo input channel (see “FireWire” on page 58).

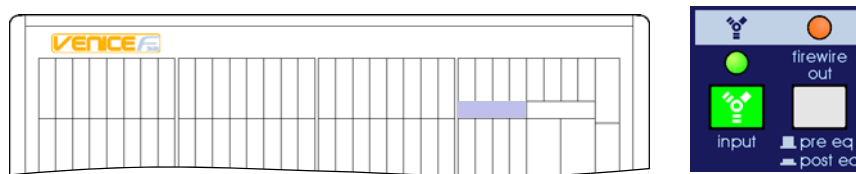

FireWire section of the dual stereo input channels

Stereo line inputs

This section lets you adjust the level of the stereo line input signal, solo the signal and route it to the channel or directly to masters.

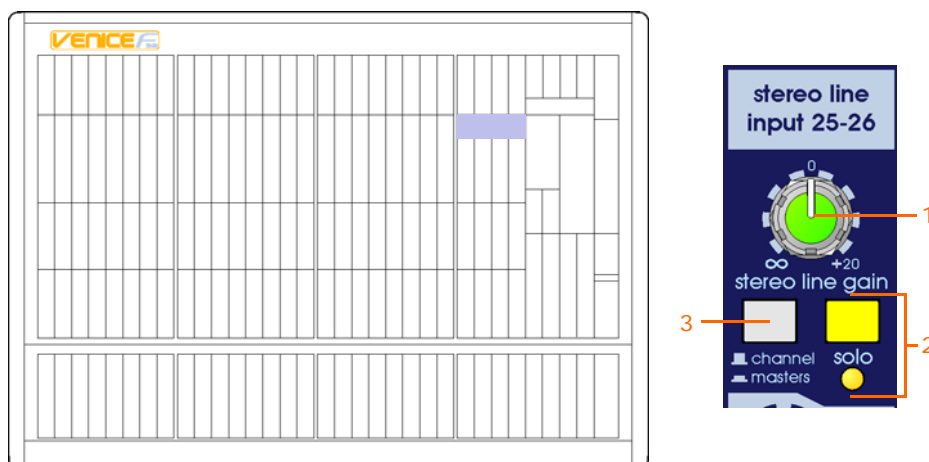

Stereo line input section of the dual stereo input channels

Item	Description
1	stereo line gain control knob Adjusts the stereo line gain, which is continuously variable from ∞ (infinity/off) to +20dB with a centre detent at 0dB, thus allowing low level line signals to be trimmed to obtain the optimal signal level.
2	solo switch and yellow LED Sends the channel signal to the AFL stereo and PFL mono buses. The left and right local monitor outputs can be used, for example, when operating from within a booth to hear selected solos and not the whole FOH mix. The solo LED illuminates to show when the SOLO switch is on.
4	channel/masters switch With this switch in the channel position, the local stereo line input is routed normally through the channel. However, in the masters position, the stereo line input is routed to the stereo master left and right channels (see "Master outputs (mono and stereo)" on page 66). This is particularly useful if you require extra inputs. For example, you can use the stereo line input for a reverb return routed directly to the masters, while still normally using the stereo mic inputs through the channel. Note: The all stereo line to masters MUTE switch (see "Master outputs (mono and stereo)" on page 66) is a global mute for any stereo line inputs routed directly to masters.

EQ

Each dual stereo input channel of the VeniceF has a four-band, fixed EQ (treble and bass shelving EQ and hi and lo mid EQ stages), allowing tonal control over the input signal.

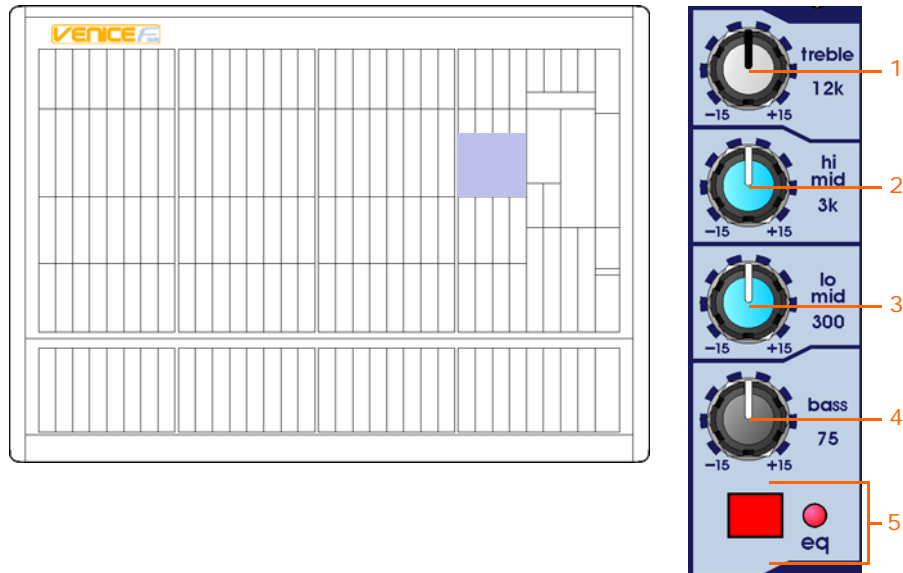

EQ section of the dual stereo input channels

<i>Item</i>	<i>Description</i>
1	Treble control knob The treble shelving EQ gain is continuously variable from -15dB to +15dB, with the shelf frequency set to 12kHz.
2	Hi mid control knob The hi mid gain is continuously variable from -15dB to +15dB around 3kHz.
3	Lo mid control knob The lo mid gain is continuously variable from -15dB to +15dB around 300Hz.
4	Bass control knob The bass shelving EQ gain is continuously variable from -15dB to +15dB, with the shelf frequency set to 75Hz.
5	EQ switch and red LED The EQ switch enables the EQ. With EQ disabled, adjustment of the EQ controls has no effect. This can be used to compare the sound with and without EQ. The eq LED illuminates to show that EQ is enabled.

Monitors

The monitor sends of the dual stereo input channels have similar functionality to those of the mono input channels. For more information, see “Monitors” on page 37.

Note: Stereo left and right channel signals are summed into a mono signal to be routed to the monitor buses by the channel monitor sends.

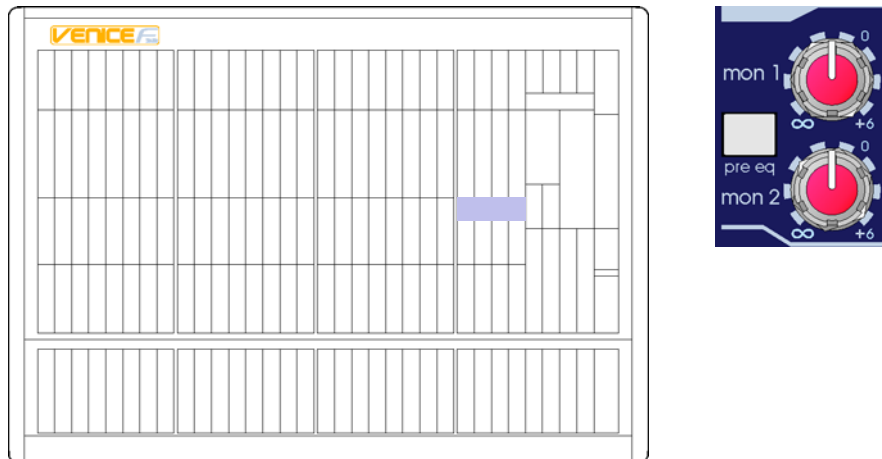

Monitor section of the dual stereo input channels

Auxes

The aux sends of the dual stereo input channels have similar functionality to those of the mono input channels. For more information, see “Auxes” on page 38.

Note: Stereo left and right channel signals are summed into a mono signal to be routed to the aux buses by the channel aux sends.

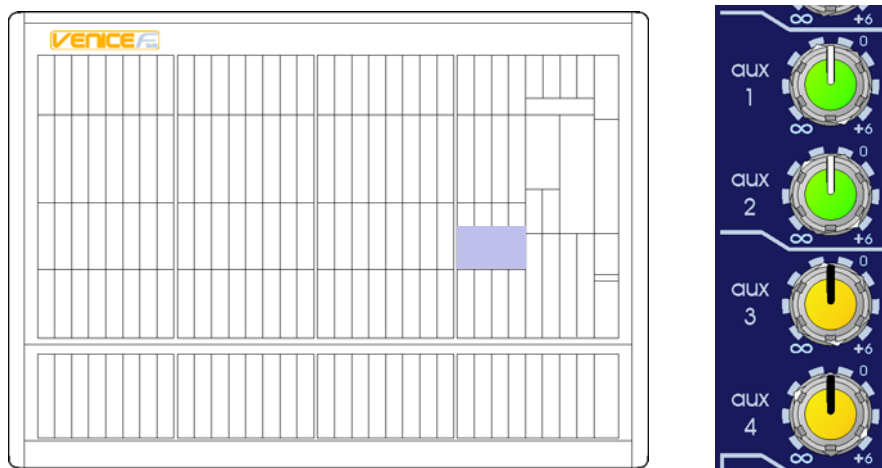

Aux sections of the dual stereo input channels

Pan, routing, mute and solo

The VeniceF is a flexible mixing console with four group buses plus stereo and mono.

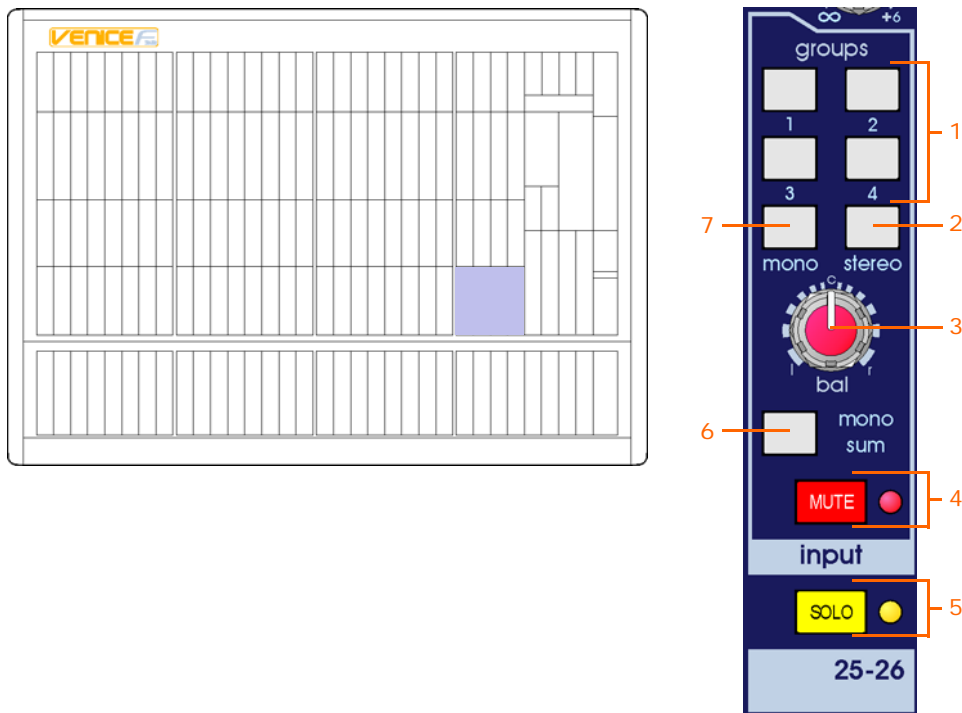

Group and solo sections of the dual stereo input channels

Item	Description
1	Group switches Each of these four group switches routes its channel signal to its associated group bus (see “Group sends” on page 51).
2	stereo switch Routes the channel signals to the stereo master buses (post-EQ, post-pan, post-mute and post-fader).
3	bal control knob This balance control allows continuous reciprocal adjustment of the channel’s stereo image. It allows the user to determine the relative output power to each left and right output. At all points this control retains constant power.
4	MUTE switch and red LED The MUTE switch mutes the channel signal. The signal will still be sent to the FireWire output. The mute LED illuminates to show when the MUTE switch is on.
5	SOLO switch and yellow LED With solo enabled, the channel signal is sent to the after-fade listen (AFL) stereo and pre-fade listen (PFL) mono buses. The left and right local monitor outputs can be used, for example, when operating from within a booth to hear selected solos and not the whole mix. The solo LED illuminates to show when a solo is on.
6	mono sum switch This switch configures the group sends (see “Group sends” on page 51) for stereo group operation (out position) or mono group mode (in position). In mono group mode the bal control knob only acts on the stereo master sends.
7	mono switch This switch routes the channel signal to the mono master bus (post-EQ and post-fader).

Group sends

Group sends are post-EQ, post-mute and post-fader. The group sends can be configured in either of two modes using the **mono sum** switch:

- **mono sum switch out (stereo)** Each pair of groups behave as if they were stereo groups. The relative odd and even numbered send level is controlled by the **bal** control knob.
- **mono sum switch in (mono)** The stereo signals are sent to the group buses as a mono sum of left and right.

This selection is on a channel-by-channel basis and, therefore, some may be assigned to the groups as mono or as stereo depending upon the desired usage. This is especially useful if the stereo input is to be used as a mono input.

Fader and meter

The VeniceF fader section has the following functions.

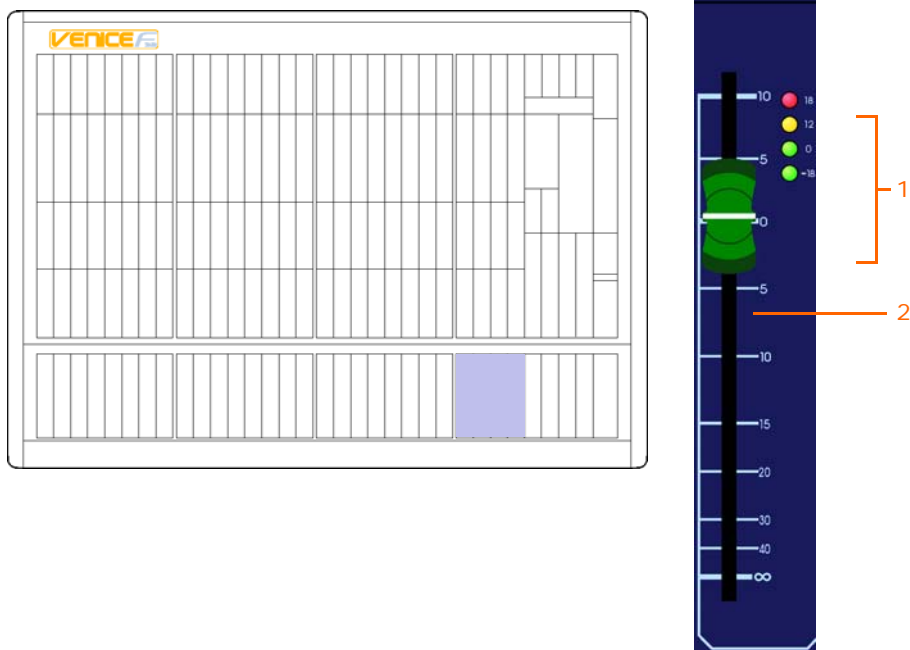

Fader section of the dual stereo input channels

<i>Item</i>	<i>Description</i>
1	<p>LED meter These LEDs comprise the dual stereo input channel meter, which lets you monitor the input signal without having to use the PFL. The meter will display the higher of the two signals (left or right). The red +18 LED will also show any overload activity on the FireWire.</p> <p><i>Note: The LED meter is post-insert and post-EQ, but pre-fader and pre-mute.</i></p>
2	<p>Fader This channel fader allows for continuous adjustment of the channel level from ∞ (infinity/off) to +10dB. At 0dB, the output of the channel to the stereo, mono and group buses will be at unity, that is, no adjustment in level from the input.</p>

The meter is especially useful when setting the microphone gain of a channel. Also, as the meter is post-EQ, it is possible to see the effect that the channel equalisation has upon the level. It may be necessary to turn the input gain down when excessive EQ is used to prevent the channel from overloading.

The LEDs represent the following:

- **18 (red):** +18dB, overload (peak)
- **12 (yellow):** +12dB, high level
- **0 (green):** 0dB, normal level
- **-18 (green):** -18dB, shows signal is present

Chapter 7: Output Section

This chapter deals with the output section of the VeniceF. It describes the control surface and the related connectors on the rear panel.

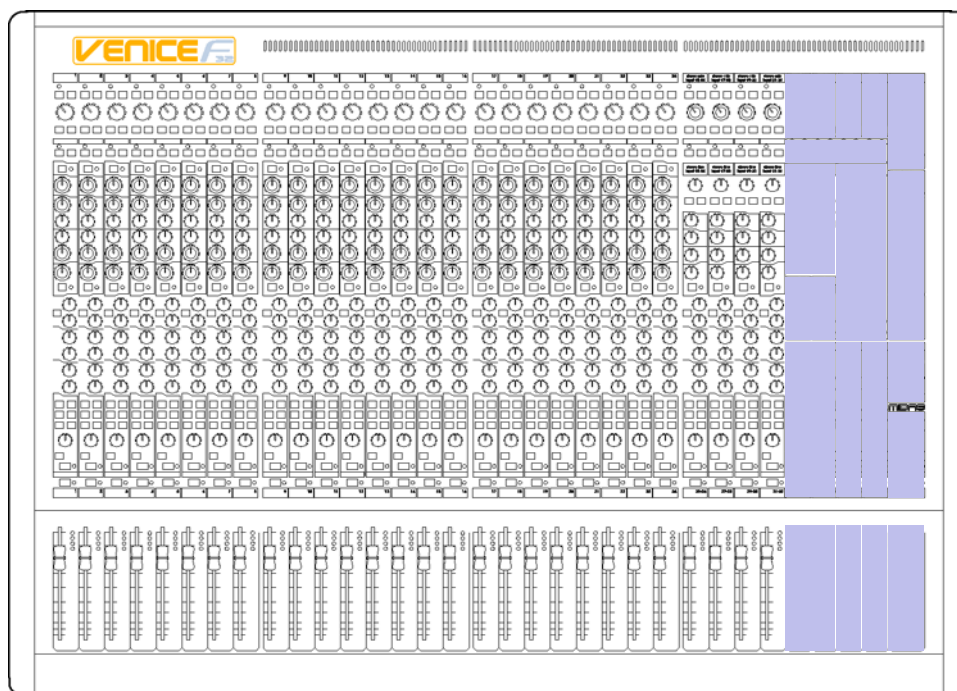

Output section of the control surface

The output section comprises the following main areas:

- Group (see “Groups” on page 57)
- Matrix (see “Matrices” on page 61)
- Stereo return (see “Stereo returns” on page 63)
- Monitor (see “Monitors” on page 64)
- Aux (see “Auxes” on page 65)
- Mono master (see “Master outputs (mono and stereo)” on page 66)
- Stereo master (see “Master outputs (mono and stereo)” on page 66)
- Talkback (see “Signal generator and talkback” on page 68)
- Playback (to masters) (see “Playback and recording” on page 69)
- Local monitor (see “Local monitor and phones” on page 70)

Rear panel

The main outputs of the VeniceF are located on the rear of the console.

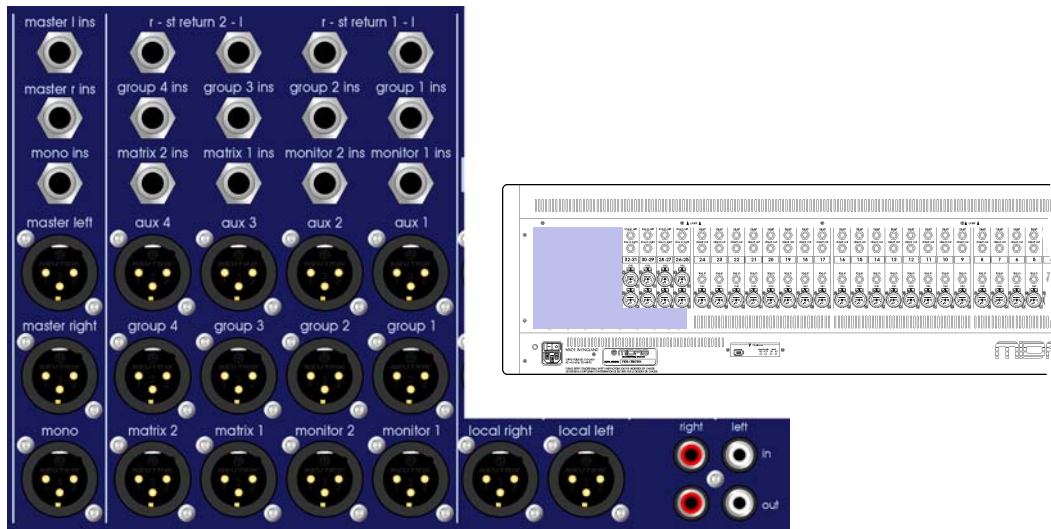

Output connections on rear panel

Overview of the outputs section

The outputs section comprises the following main areas.

Item	Description
1	See "Groups" on page 57.
2	See "FireWire" on page 58.
3	See "Stereo returns" on page 63.
4	See "Matrices" on page 61.
5	See "Monitors" on page 64.
6	See "Auxes" on page 65.
7	See "Groups" on page 57.
8	Faders — the four blue faders adjust their current assignment (for example, groups), and the red and yellow ones are for the masters.
9	See "Master outputs (mono and stereo)" on page 66.
10	See "Signal generator and talkback" on page 68.
11	See "Playback and recording" on page 69.
12	See "Local monitor and phones" on page 70.
13	See "Master outputs (mono and stereo)" on page 66.

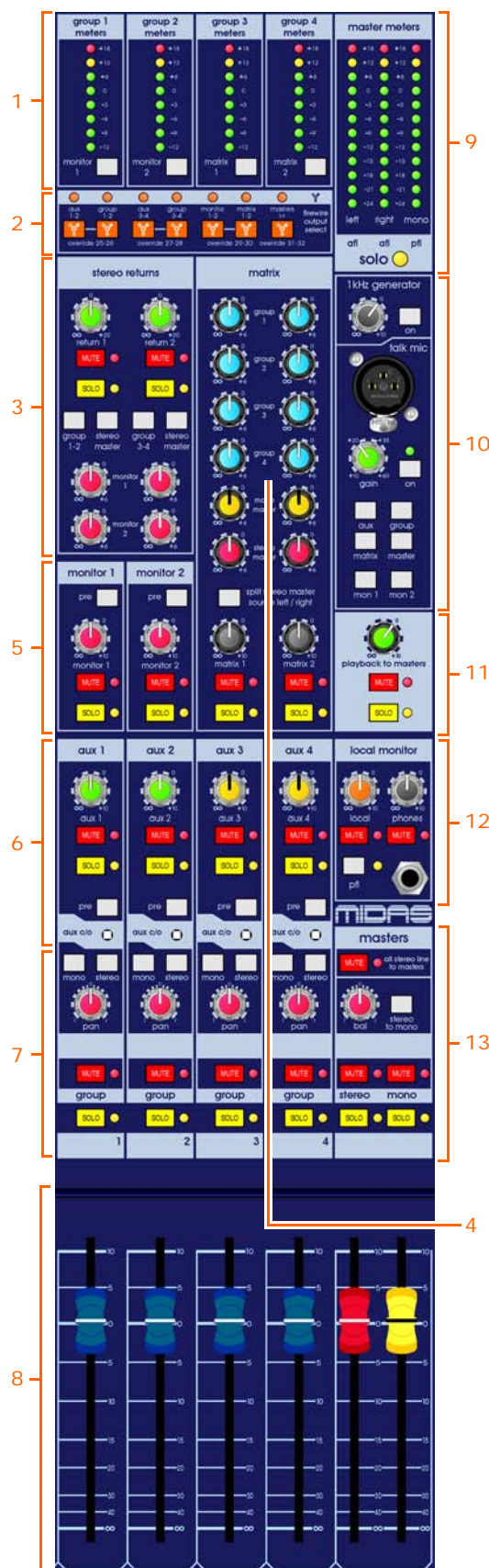

Output module notes

Before looking at the function of the output section of the console, it is essential that you are comfortable with a few of the console's features that affect groups, matrices and auxes. Rather than discuss these features in each section (although they will be repeated there), an understanding of their function in a more general context is desirable.

Group-aux changeover

The VeniceF can be used as a front of house (FOH) console or monitor console. Monitor engineers tend to prefer the output faders on their console to operate the aux outputs (for monitors), whereas FOH engineers would rather use their output faders for groups (either for sub mixes or alternative outputs).

To achieve this flexibility, the VeniceF has an **aux c/o** (aux/group changeover) switch, so that each output can be individually 'changed over' so that the group output path becomes that of the aux output and vice versa.

The VeniceF has been developed with real world sound engineers in mind. The real flexibility of the VeniceF is in the speed in which the changeover can be made and also the ability to create a console that can be used for FOH and monitors in a smaller venue where you still need monitors, but don't have space for a monitor engineer or console.

Pressing the **aux c/o** switch will connect the aux bus to the group insert, group mute, group meter, group solo, group fader, group pan and finally the group output XLR.

The group bus is connected to the aux output pot and to the aux output XLR.

This routing flexibility is available on each of the four group/aux buses.

>> To operate the aux c/o switch

We recommend using a pointed (but not sharp) object, such as a ballpoint pen.

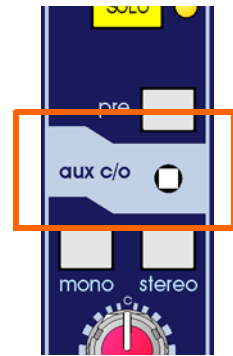

Meter changeover

You can meter the monitor (1 and 2) or matrix (1 and 2) outputs, rather than the group outputs. For example, if using the matrix outputs to drive delay speakers, it may be desirable to monitor those outputs.

Note: If you have used the group **aux c/o** switch, the group meters will show the aux outputs.

The monitor and matrix switches send the relevant signal to the meter array.

Note: Meters are post-fader and post-mute.

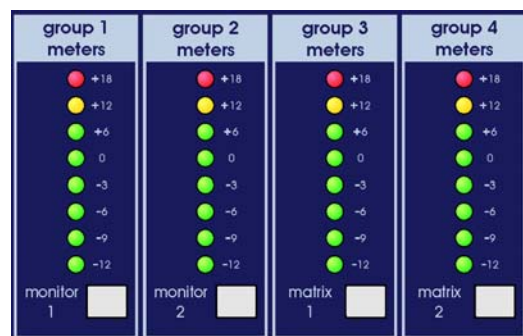

For more information on VeniceF signal routing, see Appendix A "Functional Block Diagrams" on page 73.

Groups

Each of the four group buses has an output and an insert.

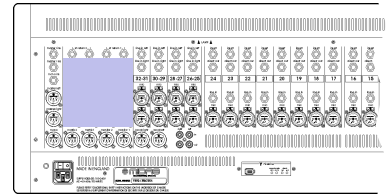
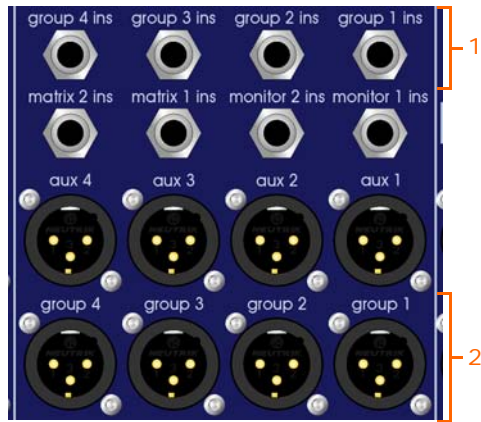

Group connectors on rear panel

Item	Description
1	Group insert sockets Each group has an insert point via a single 1/4" TRS Jack socket.
2	Group output sockets Each group has an output via a male XLR chassis connector.

FireWire output is available for the groups by the overriding dual stereo input channels. For more information, see "FireWire" on page 58.

Each group output has fader level adjustment and metering.

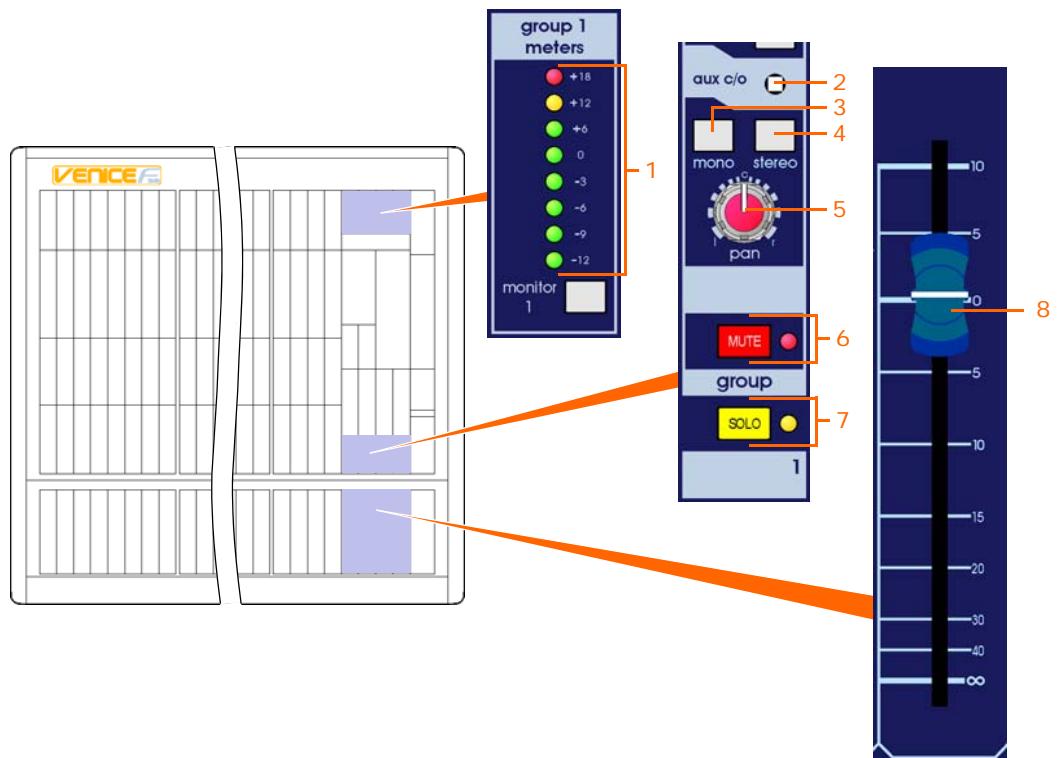

Group output sections on the control surface

<i>Item</i>	<i>Description</i>
1	Meter LEDs These LEDs comprise the group meter, which monitors the signal level of the group bus. Range is from -12dBu to +18dBu (3dBu steps from -12dBu to 0dBu, and 6dBu steps from 0dBu to +18dBu).
2	aux c/o switch See “Group-aux changeover” on page 56.
3	mono switch This switch routes the channel signal to the mono bus (post-EQ, post-mute and post-fader).
4	stereo switch Routes the channel signal to the stereo master bus (post-EQ, post-pan, post-mute and post-fader).
5	pan control knob The pan control allows the group channel signal to be positioned in a stereo field when routed to the stereo master bus. The pan control allows continuous adjustment of the image from hard left, to hard right with a centre detent, and obeys a constant power law (that is, -3dB at the centre).
6	MUTE switch and red LED The MUTE switch mutes the channel signal. Note that the signal will still be sent to the insert point. The mute LED illuminates to show that the mute is on.
7	SOLO switch and yellow LED Group output solo has the same function as on the mono input channels (see “Pan, routing, mute and solo” on page 39).
8	Fader The group fader allows for continuous adjustment of the channel level from ∞ (infinity/off) to +10dB.

FireWire

The **FireWire** section is located on the rear panel of the console.

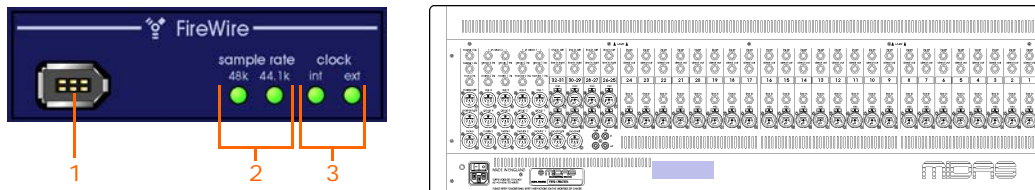

FireWire section on the rear panel

<i>Item</i>	<i>Description</i>
1	FireWire socket For connecting a FireWire 400, 6-pin connector (to IEEE 1394 standard) to a PC.
2	sample rate LEDs There are two possible sample rate frequencies (in Hz), which are configured via a PC using the FireWire driver. Either the 48k LED or 44.1k LED will illuminate to show which sample rate is in operation.
3	clock LEDs There are two clock sources, internal or external, which are configured via a PC using the FireWire driver. Either the int LED or ext LED will illuminate to show the current clock source.

The output section on the control surface has a **firewire output select** section that lets you replace the FireWire outputs of the dual stereo input channels, and route output buses to the FireWire interface instead.

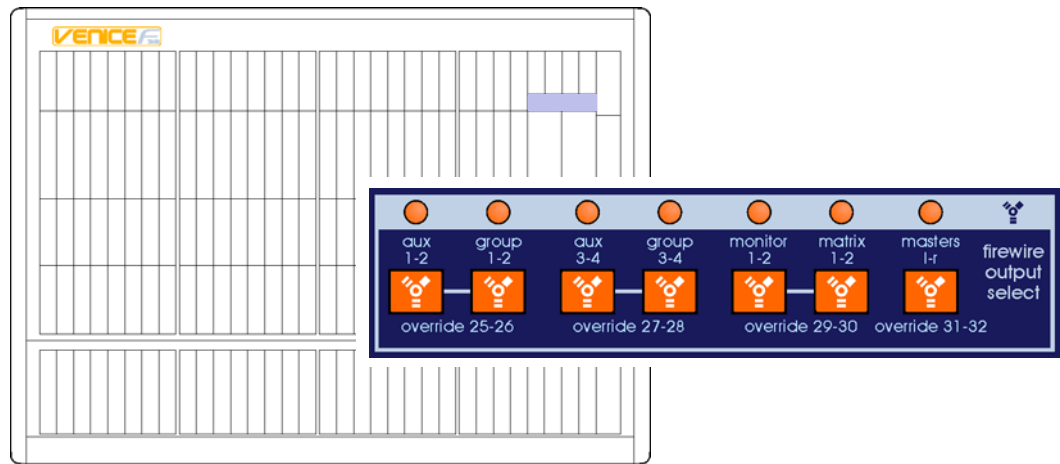

firewire output select section on the control surface

When an orange FireWire button is switched on (depending on button precedence), it replaces the FireWire output of its respective stereo input channel for its associated buses. The orange LEDs above illuminate to indicate which pair of buses are overriding which stereo channel FireWire output.

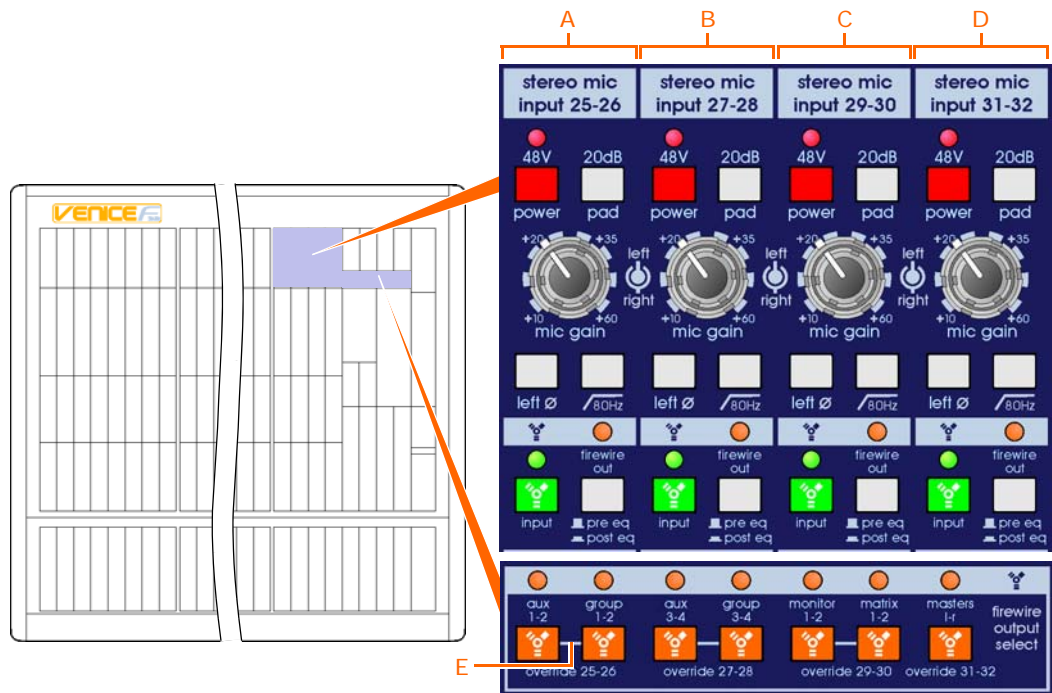

The buttons in the **firewire output select** section override their respective stereo channel FireWire output. (Although the above example uses a VeniceF32, this applies to the equivalent stereo channels on all VeniceF consoles.) **A.** Stereo input channel 25-26 can be overridden by auxes 1 and 2 or groups 1 and 2. **B.** Stereo input channel 27-28 can be overridden by auxes 3 and 4 or groups 3 and 4. **C.** Stereo input channel 29-30 can be overridden by monitors 1 and 2 or matrices 1 and 2. **D.** Stereo input channel 31-32 can be overridden by master left and right only. **E.** A bar, indicating that the two adjacent override buttons are interlinked (in the same channel).

The hierarchy of the three pairs of FireWire override buttons can be summarised by the following:

- The right button of the pair overrides any FireWire output.
- The left button of the pair only overrides the stereo input channel FireWire output (default).

The buttons are latching, so pressing one when its associated FireWire output is being used will cancel it, reverting to the default condition.

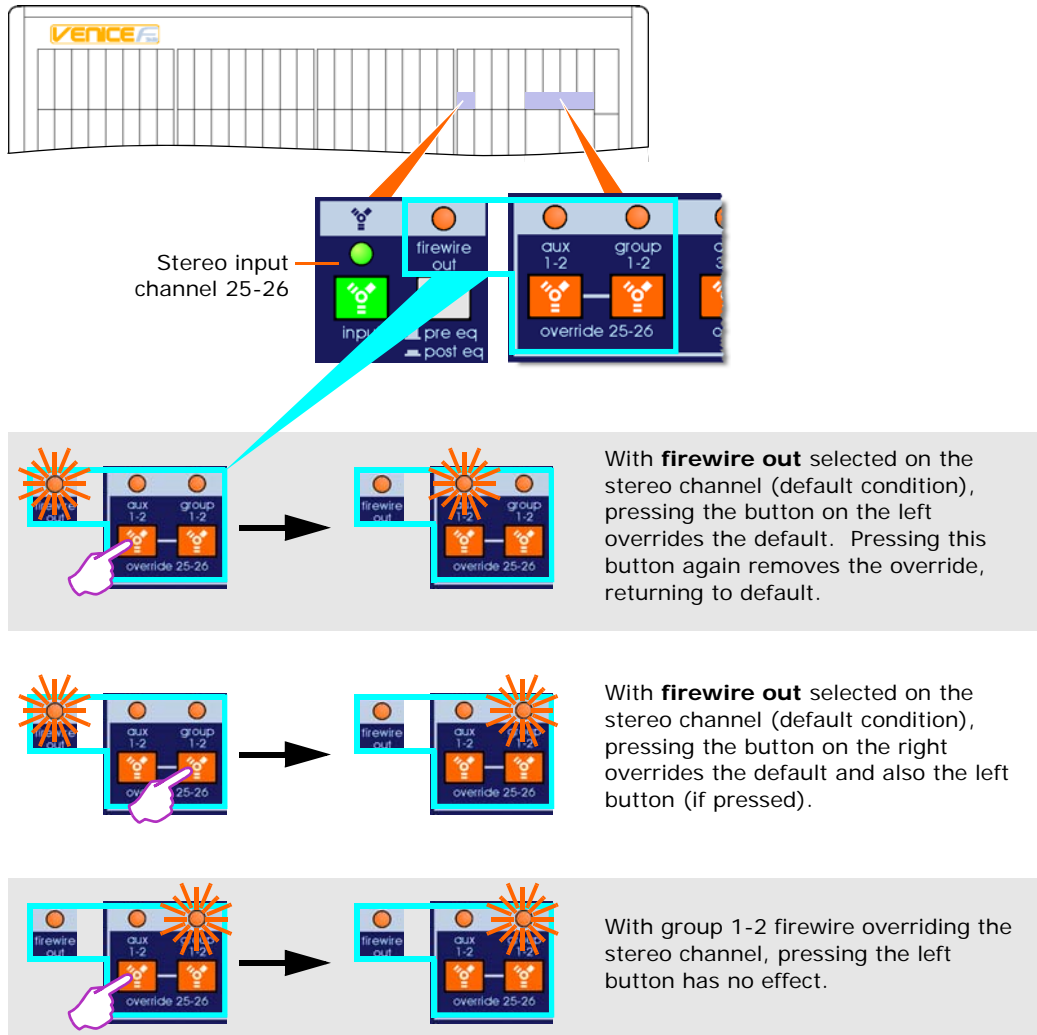

Using the override buttons in the **firewire output select** section. The example uses stereo channel 25-26 of an F32 console.

Matrices

There is an output connector and insert connector on the rear panel for both matrix outputs.

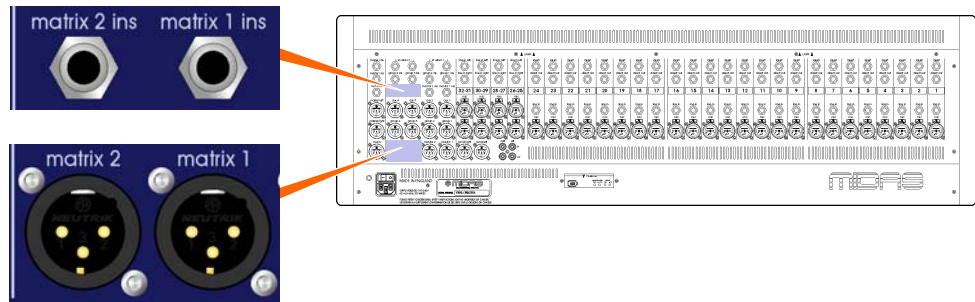

Two matrix inserts and two matrix outputs on the rear panel

FireWire output is available for the matrix outputs by overriding the relevant dual stereo input channel 29-30. For more information, see “FireWire” on page 58.

The VeniceF provides another two outputs from the console, which can be contributions from a combination of the group bus signals and mono, left and right master signals. The matrix signal can be made from a combination of the group bus signals and mono, left and right master signals. They can be used to drive additional speaker zones or as effects sends from the groups (like the auxes from inputs).

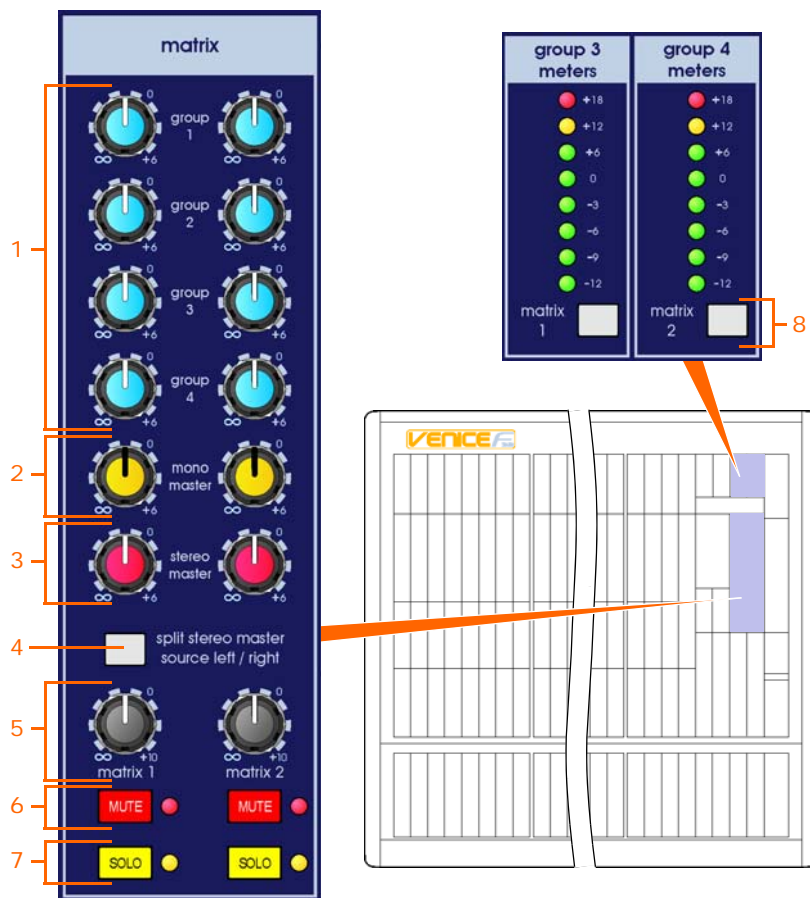

matrix output section on the control surface

<i>Item</i>	<i>Description</i>
1	<p>group 1 to group 4 control knobs Each of the groups (1-4) has its own individual matrix send level, which is continuously variable from ∞ (infinity/off) to +6dB. Unity (0dB) is also marked on the scale, allowing the signal to be routed to the matrix without any attenuation or gain.</p> <p>Alternatively, the auxiliaries can be routed to the matrix by pressing the aux c/o switch (see “Group-aux changeover” on page 56). This is especially useful for generating additional monitor mixes or re-routing existing monitor mixes (for example, if artists are moving around to other parts of the stage).</p>
2	<p>mono master control knobs The master mono signal sent to the matrix is continuously variable from ∞ (infinity/off) to +6dB. Unity (0dB) is also marked on the scale, allowing the signal to be routed to the matrix without any attenuation or gain.</p>
3	<p>stereo master control knobs The single stereo master control knob on each matrix comprises a ‘summed’ signal of the left and right master channels.</p>
4	<p>split stereo master source left/right switch This switch makes matrix 1 stereo master contribution ‘left’ and matrix 2 stereo master contribution ‘right’, rather than the summed default.</p>
5	<p>matrix 1 and matrix 2 control knobs Adjust the matrix output levels from ∞ (infinity/off) to +10dB.</p>
6	<p>MUTE switch and red LED The MUTE switch mutes the matrix output. The mute LED illuminates to show that the mute is on.</p>
7	<p>SOLO switch and yellow LED The SOLO switch routes the matrix signal to the mono PFL bus and stereo AFL buses. The solo LED illuminates to show when solo is on.</p>
8	<p>matrix 1 and matrix 2 switches Meter changeover switches (from group).</p>

Stereo returns

There are two stereo returns that route to masters, certain groups and the two monitor buses.

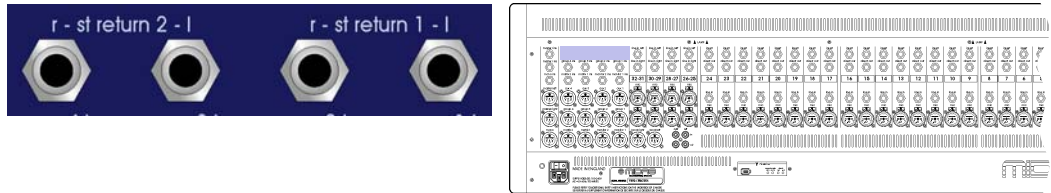

Stereo returns 1 and 2 on the rear panel. Each return has left and right TRS 1/4" TRS Jack sockets.

The **stereo returns** section is immediately below the **firewire output select** section.

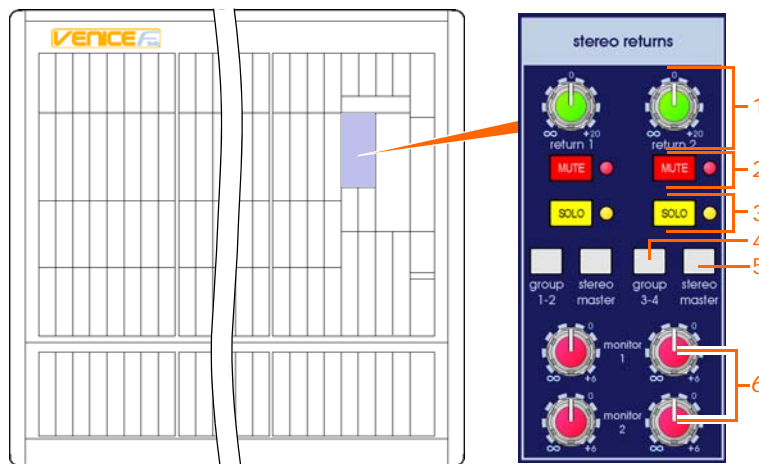

stereo returns section

Item	Description
1	return 1 and return 2 control knob These control knobs adjust the line gain from ∞ (infinity/off) to +20dB.
2	MUTE switch and red LED These switches mute the stereo returns. The LEDs illuminate to show that the mute is on.
3	SOLO switch and yellow LED These switches route the stereo return signal to the mono PFL bus and stereo AFL buses. The LEDs illuminate to show that the solo is on.
4	group 1-2 and group 3-4 switches Routes the stereo return channels to groups 1 and 2 (return 1) or 3 and 4 (return 2).
5	stereo master switch Routes each stereo return to the stereo master channel.
6	monitor 1 and monitor 2 control knob Adjusts the contribution to the monitor 1 and 2 buses (pre-fade or post-fade mono sum) from ∞ (infinity/off) to +6dB.

Monitors

There is an output connector and insert connector on the rear panel for both monitor bus outputs.

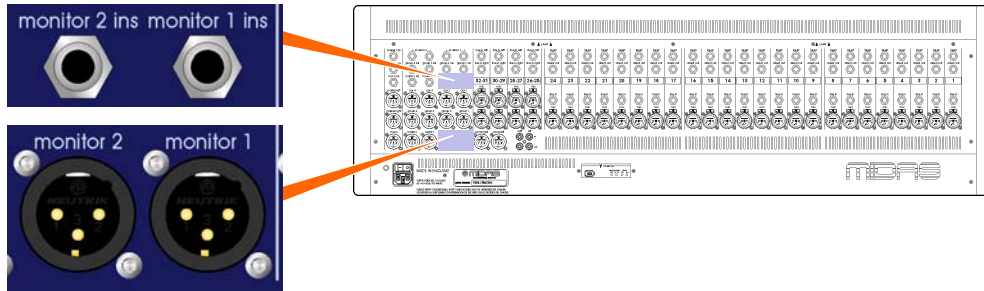

Two monitor inserts and two monitor outputs on rear panel

FireWire output is available for the monitors by the overriding the relevant dual stereo input channel. For more information, see “FireWire” on page 58.

There are two discrete monitor sections on the control surface, which can be monitored on the first two group meters.

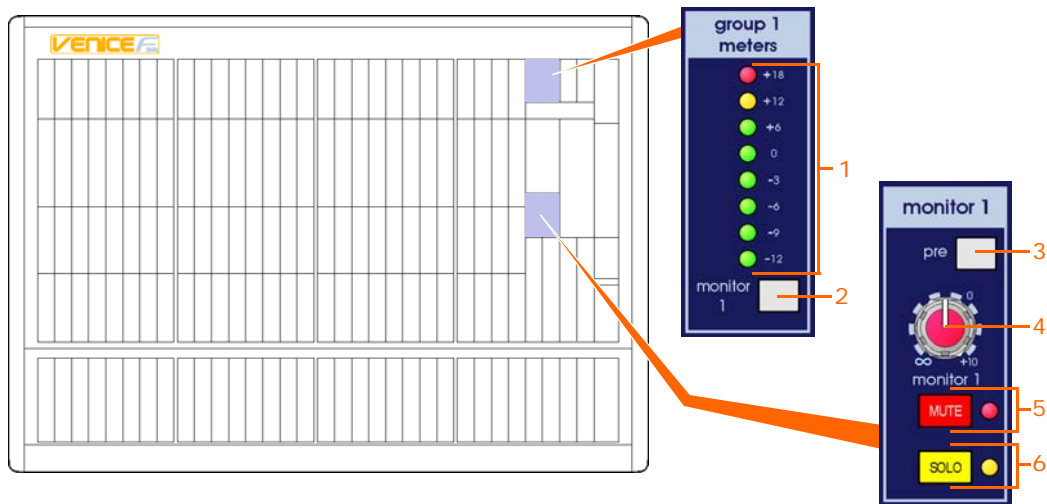

Monitor channels (1 and 2)

Item	Description
1	Meter LEDs These LEDs comprise the monitor meter when the monitor switch (immediately below) is on. This meter monitors the signal level of the monitor bus. Range is from -12dBu to +18dBu (3dBu steps from -12dBu to 0dBu, and 6dBu steps from 0dBu to +18dBu).
2	Monitor switch This is the meter changeover switch (from group).
3	pre switch This is the bus master pre-fader switch.
4	monitor 1 control knob This output level control gives continuous adjustment of the monitor output signal from +10dB to ∞ (infinity/off).

Item	Description
5	MUTE switch and red LED The MUTE switch mutes the monitor send output signal. The mute LED illuminates to show that the mute is on.
6	SOLO switch and yellow LED The SOLO switch routes the monitor send signal to the mono PFL bus and stereo AFL buses. When the SOLO switch is on, the master meters are automatically used for solo metering. The solo LED illuminates to show when solo is on.

Auxes

There are four independent aux outputs on the rear panel.

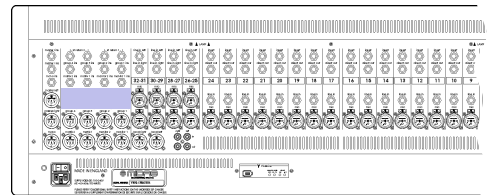

Four aux XLR outputs on the rear panel

FireWire output is available for the auxes by the overriding dual stereo input channels 25-26 and 27-28. For more information, see "FireWire" on page 58.

Each aux output is controlled by a discrete section on the control surface.

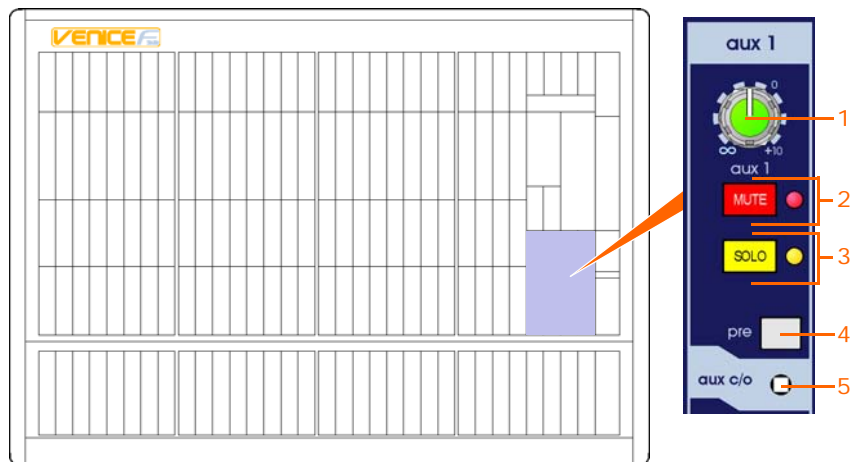

Auxes on the control surface

Item	Description
1	Control knob Adjusts the aux master level. The output level of the aux is continuously variable from ∞ (infinity/off) to +10dB.
2	MUTE switch and red LED The MUTE switch mutes the aux send signal at every point after the master send level. The LED illuminates to show when the mute is on.
3	SOLO switch and yellow LED The SOLO switch routes the aux send signal to the mono PFL bus and stereo AFL buses. The solo LED illuminates to show when solo is on.

<i>Item</i>	<i>Description</i>
4	pre switch This is the aux global control bus master pre-fader switch, which determines whether the aux contribution from the input channel is pre-fader or post-fader.
5	aux c/o switch See "Group-aux changeover" on page 56

Pre-fade aux 1-4 sends are sourced after the channel insert, mute and EQ, but before the channel fader. As a result, the actual level sent to the aux bus is proportional to the aux send control only.

Post-fade aux sends are sourced after the channel insert, mute, EQ and fader. As a result, the actual level sent to the aux bus is proportional to the aux send control *and* the channel fader.

Table 2: Typical uses of auxiliaries

<i>Application</i>	<i>Pre-/Post-fade</i>	<i>Reason</i>
Stage monitors	Pre-fade (post-EQ)	The level in the monitor stays constant, so that the engineer can change the FOH level without affecting the performer.
Effects sends	Post-fade	The level sent to the effects is proportional to the fader level, so the balance between wet (processed) and dry (unprocessed) sound stays the same, even when the channel level is changed.
Mixed recording (for the artist)	Post-fade (post-EQ)	If the aux is set to unity, the FOH mix is replicated on the aux output. This includes EQ, but excludes pan.

Master outputs (mono and stereo)

There is an output connector and insert connector on the rear panel for each of the mono, left and right master channels.

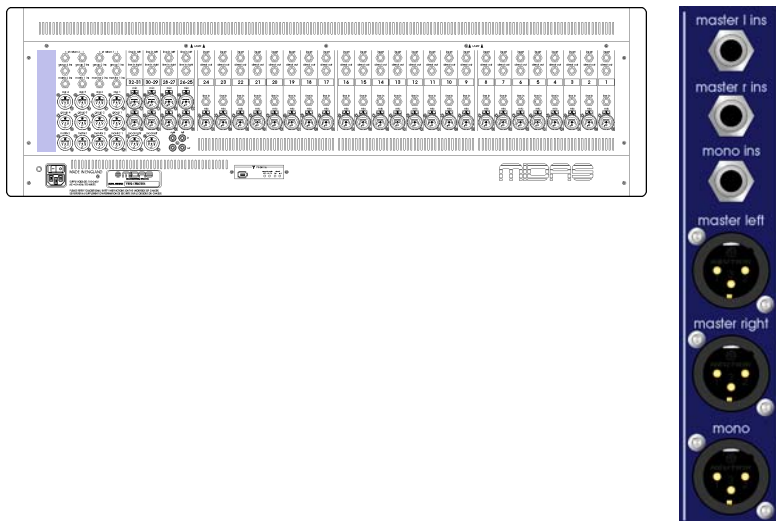

Master outputs on the rear panel

FireWire output is available for the left and right master channels by the overriding the relevant dual stereo input channel. There is no FireWire output for the mono channel. For more information, see "FireWire" on page 58.

The controls shown in this section are directly responsible for the main outputs from the console.

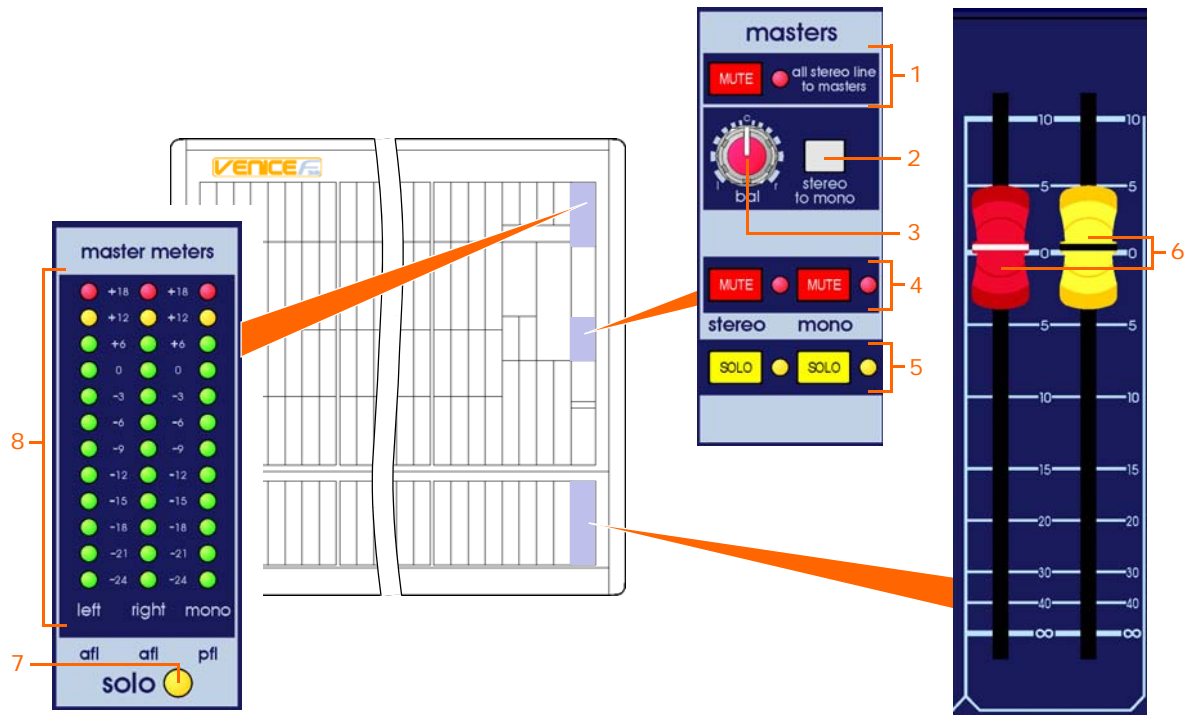

Master outputs sections on the control surface

Item	Description
1	MUTE switch and red LED This MUTE switch (in the all stereo line to masters section) mutes the stereo returns and any stereo line inputs of the stereo modules that are routed <i>directly</i> to masters, that is, when the channel/masters switch in the dual stereo input channel is set to masters (see "Stereo line inputs" on page 47). The LED illuminates to show that the switch is on.
2	stereo to mono switch When this switch is on, a sum of the stereo left and right signals are routed to the mono signal bus (post-mute and post-insert points).
3	bal control knob Provides fine adjustment of the left and right power levels, and can be used during set up to check the left and right channels separately (by panning fully left or right).
4	MUTE switches and red LEDs These MUTE switches mute the stereo/mono signals pre-fader. Each red LED illuminates when its mute is on.
5	SOLO switches and yellow LEDs The SOLO switches route the stereo/mono signal to the PFL mono and AFL stereo buses. The LED for each solo switch illuminates when its solo is on. Master solo will be overridden by any other channel/mix solos.
6	Faders These master output faders adjust the output levels, which are continuously variable from ∞ (infinity/off) to +10dB.

Item	Description
7	solo LED This yellow LED illuminates to show when the meters in the master meters section are functioning as solo meters. The solo bus levels (afl L, afl R and pfl) are shown on the solo meters. The solo meters are pre-monitor or phones output mute and level, and are unaffected by changes in the headphone level or the level sent to the local monitor outputs.
8	left, right and mono LED These are the stereo (left and right) and mono meters that monitor the peak signal levels of the master outputs (post-fader).

Signal generator and talkback

The VeniceF provides a 1kHz signal generator and a talkback mic that can be routed to a number of the console's outputs.

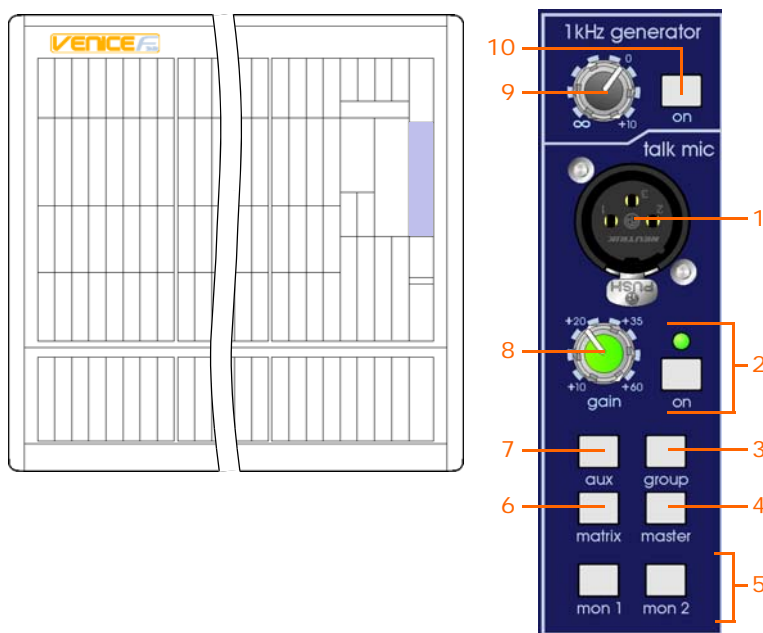

1kHz generator and talk mic sections on the control surface

Item	Description
1	talk mic input socket This socket is a conventionally-wired XLR male and is permanently supplied with 48V phantom power, allowing the connection of a condenser microphone.
2	on switch and green LED When on (button fully in), the talk mic input is enabled and routed to the talk bus, in which case both local monitor outputs are attenuated by 20dB to help prevent feedback. The green LED illuminates to show that the talk mic input is enabled.
3	group switch This is a routing button that routes the talk bus/signal generator signal to all group buses.
4	master switch This is a routing button that routes the talk bus/signal generator signal to the stereo master buses.
5	mon 1 and mon 2 switches This is a routing button that routes the talk bus/signal generator signal to the monitor 1 or monitor 2 bus.

Item	Description
6	matrix switch This is a routing button that routes the talk bus/signal generator signal to both matrix buses.
7	aux switch This is a routing button that routes the talk bus/signal generator signal to all aux buses.
8	gain control knob Adjusts the gain of the talk mic, which is continuously variable from +10dB to +60dB.
9	on switch Switches the 1kHz signal generator on/off.
10	1kHz generator control knob This control knob adjusts the level of the output and is continuously variable from ∞ (infinity/off) to +10dBu.

Note: Essentially, with all bus routing buttons switched on (enabled), the talk bus/signal generator signal is routed to all of the console's buses (except the mono master and local monitor outputs).

Playback and recording

The following four connectors on the rear panel provide discrete analogue inputs and outputs for audio playback and recording, respectively.

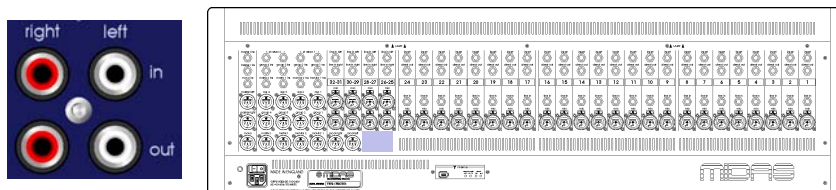

Playback/record sockets on the rear panel

Playback

The two **in (right and left)** connectors let you connect an analogue device, such as a tape recorder, to play back recorded audio material via the console.

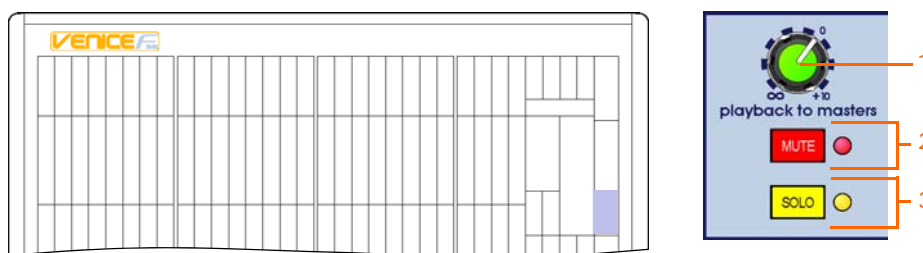

playback to masters section on the control surface

Item	Description
1	playback to masters control knob The level of the input is continuously variable from ∞ (infinity/off) to +10dB (the nominal level is referenced to -10dB).

<i>Item</i>	<i>Description</i>
2	MUTE switch and red LED The MUTE switch mutes the input signal. The LED illuminates to show when the mute is on.
3	SOLO switch and yellow LED The SOLO switch routes the input signal to the mono PFL bus and stereo AFL buses. The solo LED illuminates to show when solo is on.

Recording

The two **out (right and left)** connectors are recording outputs. They are routed via the stereo bus output and operate at a nominal -10dB. These outputs provide a direct output from the console that is *post-everything*, including mute.

Local monitor and phones

There are two local monitor outputs on the rear panel for providing a signal for monitor speakers.

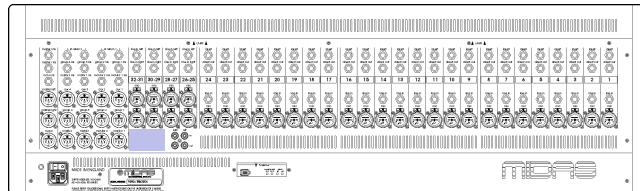

Local monitor outputs on the rear panel

A **local monitor** section on the control surface lets you connect headphones for local monitoring and adjust their signal level, and also the signal level of the local monitor outputs.

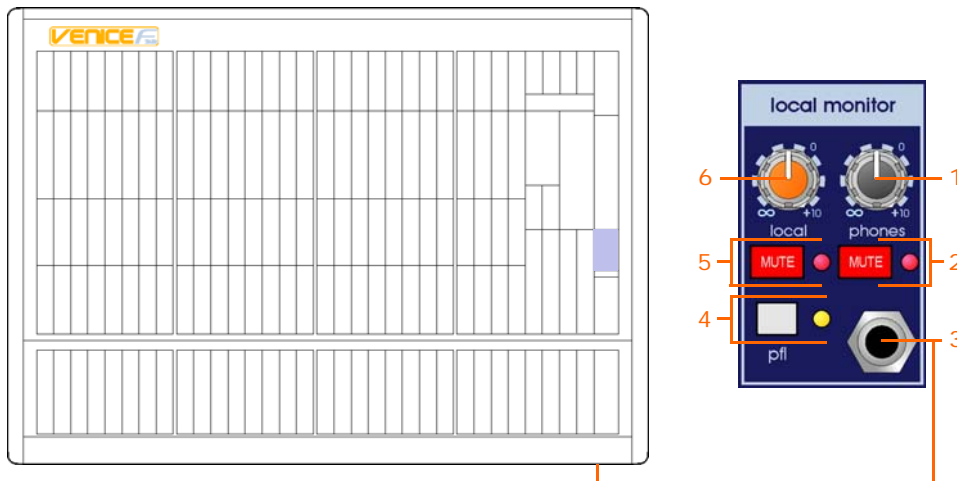

Local monitor section on the control surface and the position of the addition headphones socket on the front panel of the console

<i>Item</i>	<i>Description</i>
1	phones control knob Adjusts the headphones level, which is continuously variable from ∞ (infinity/off) to +10dB.
2	MUTE switch and red LED The MUTE switch mutes the headphone signal. The LED is illuminated when the switch is on.

<i>Item</i>	<i>Description</i>
3	Output socket The local monitor section has a 1/4" TRS Jack socket for headphones. There is an additional socket under the armrest of the console.
4	pfl switch and yellow LED When this solo switch is on (LED illuminated), the local monitor and headphones signal is sourced from the PFL mono signal, rather than the AFL stereo default.
5	MUTE switch and red LED The MUTE switch mutes the local monitor outputs. The LED illuminates when the switch is on.
6	local control knob Adjusts the local level, which is continuously variable from ∞ (infinity/off) to +10dB.

Lamps

There are sockets towards the top of the console's rear panel for connecting 12V desk lamps. They accept 4-pin female XLR connectors. **The power rating of 5W is the maximum rating per output and must not be exceeded.**

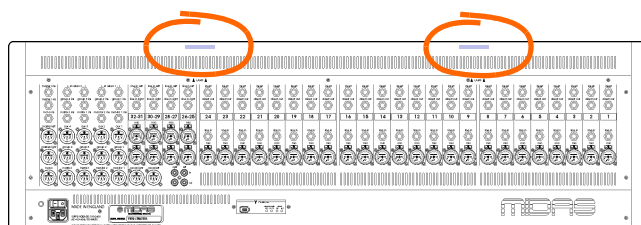

Position of the lamp sockets on a VeniceF32. The F24 also has two sockets, while the F16 has only one.

Appendix A: Functional Block Diagrams

This chapter contains the VeniceF signal path diagrams.

Overview

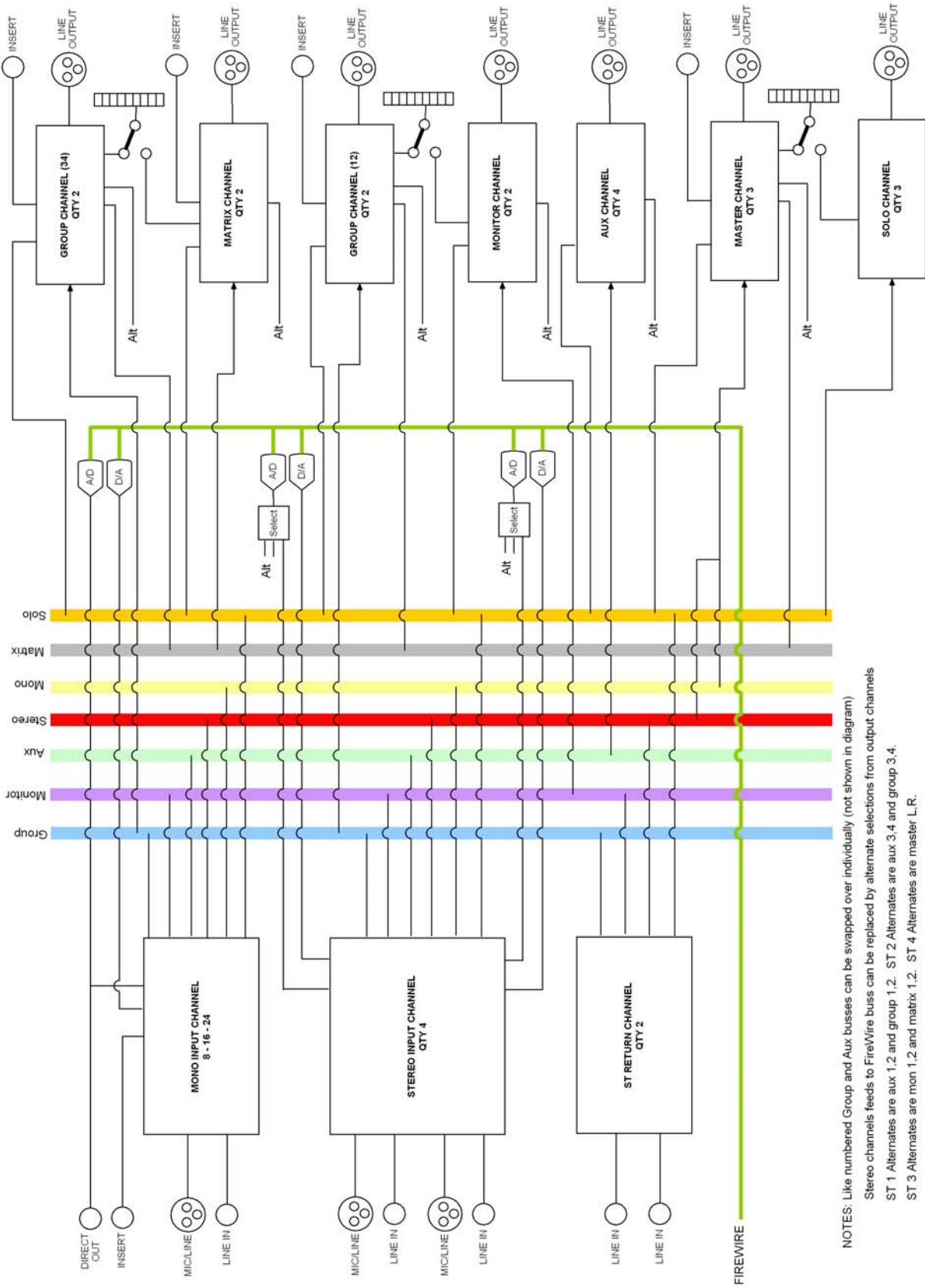

NOTES: Like numbered Group and Aux busses can be swapped over individually (not shown in diagram)
 Stereo channels feed to FireWire buss can be replaced by alternate selections from output channels
 ST 1 Alternates are aux 1,2 and group 1,2. ST 2 Alternates are aux 3,4 and group 3,4.
 ST 3 Alternates are mon 1,2 and matrix 1,2. ST 4 Alternates are master L,R.

Mono input module

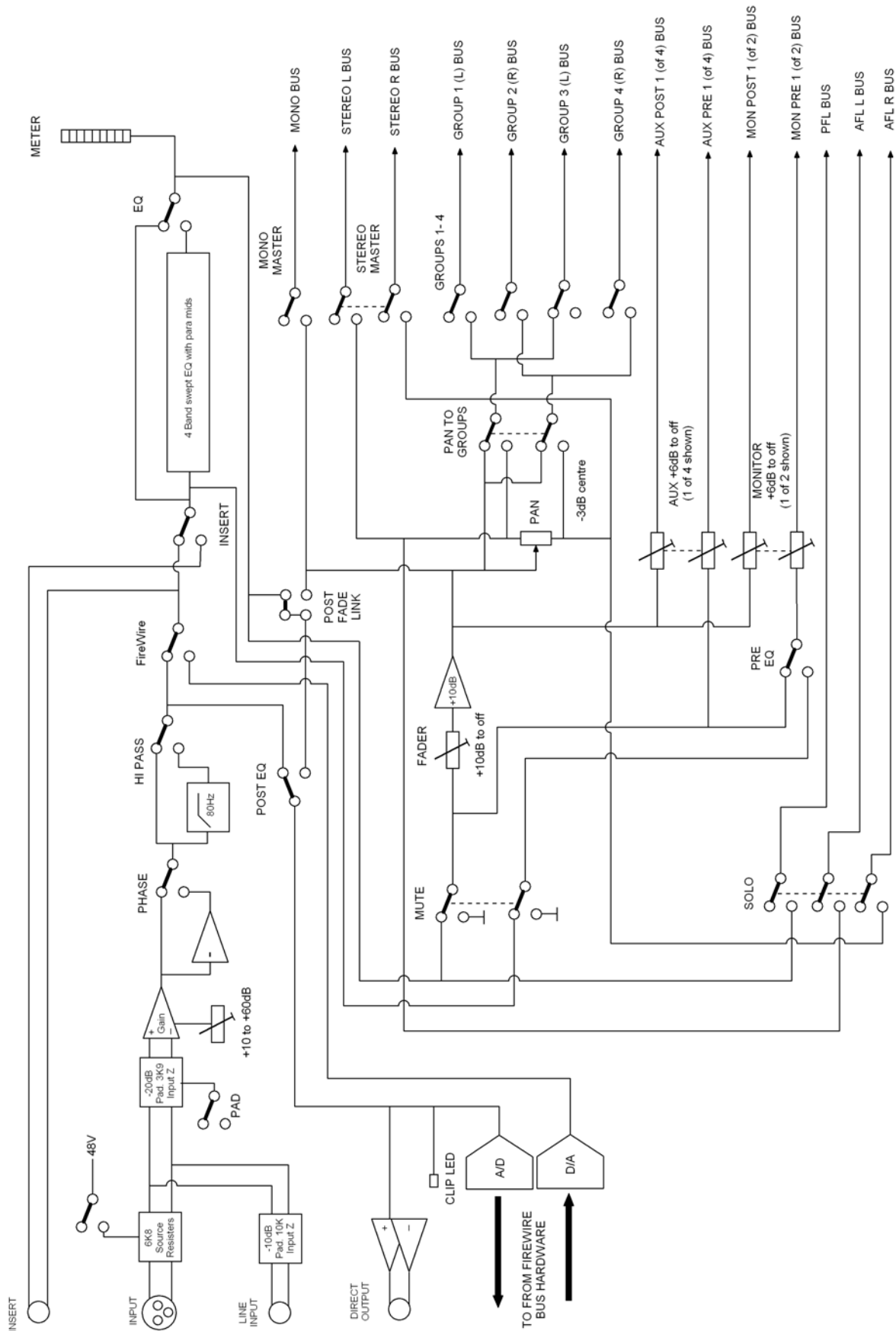

Stereo input module

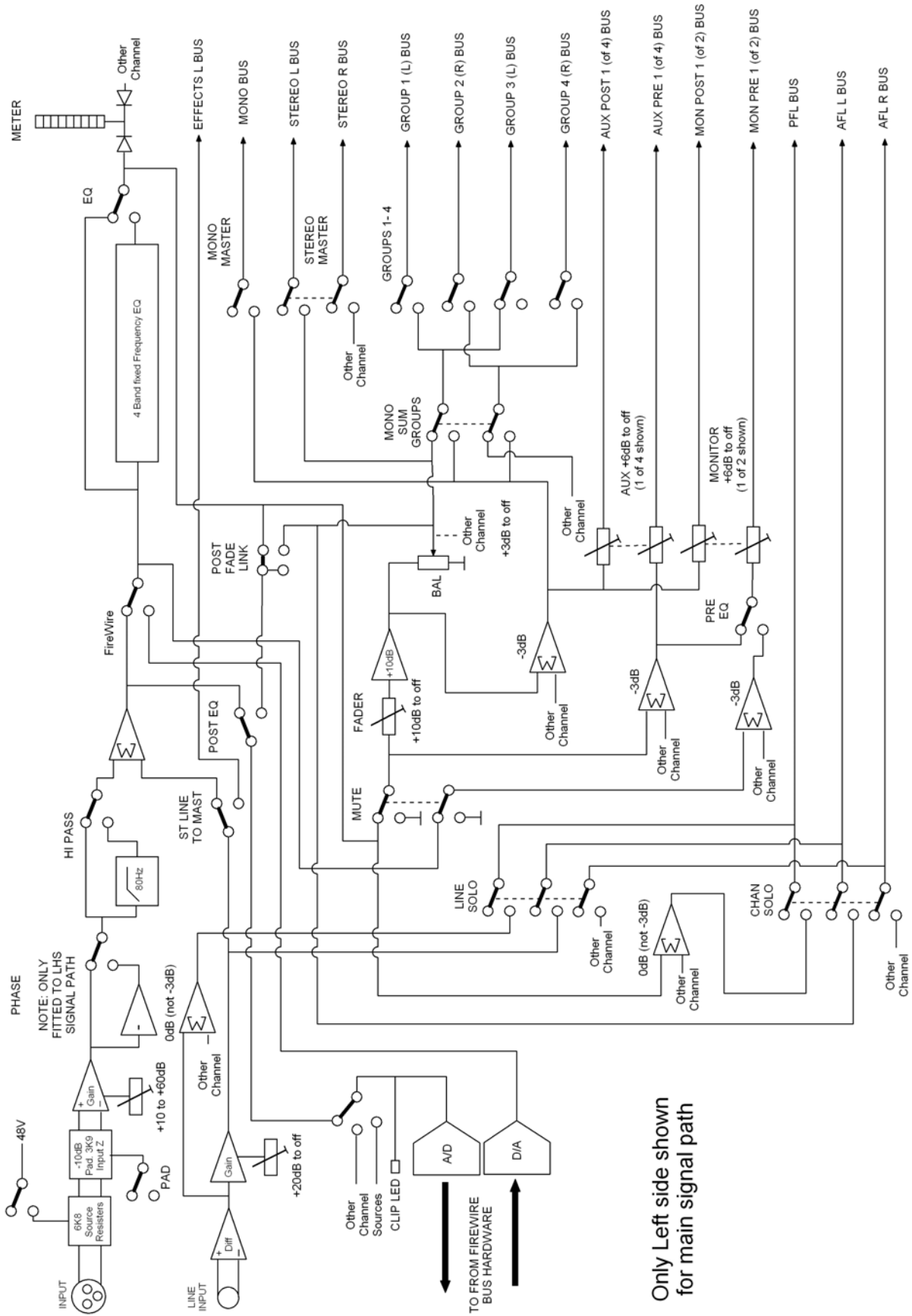

Stereo return

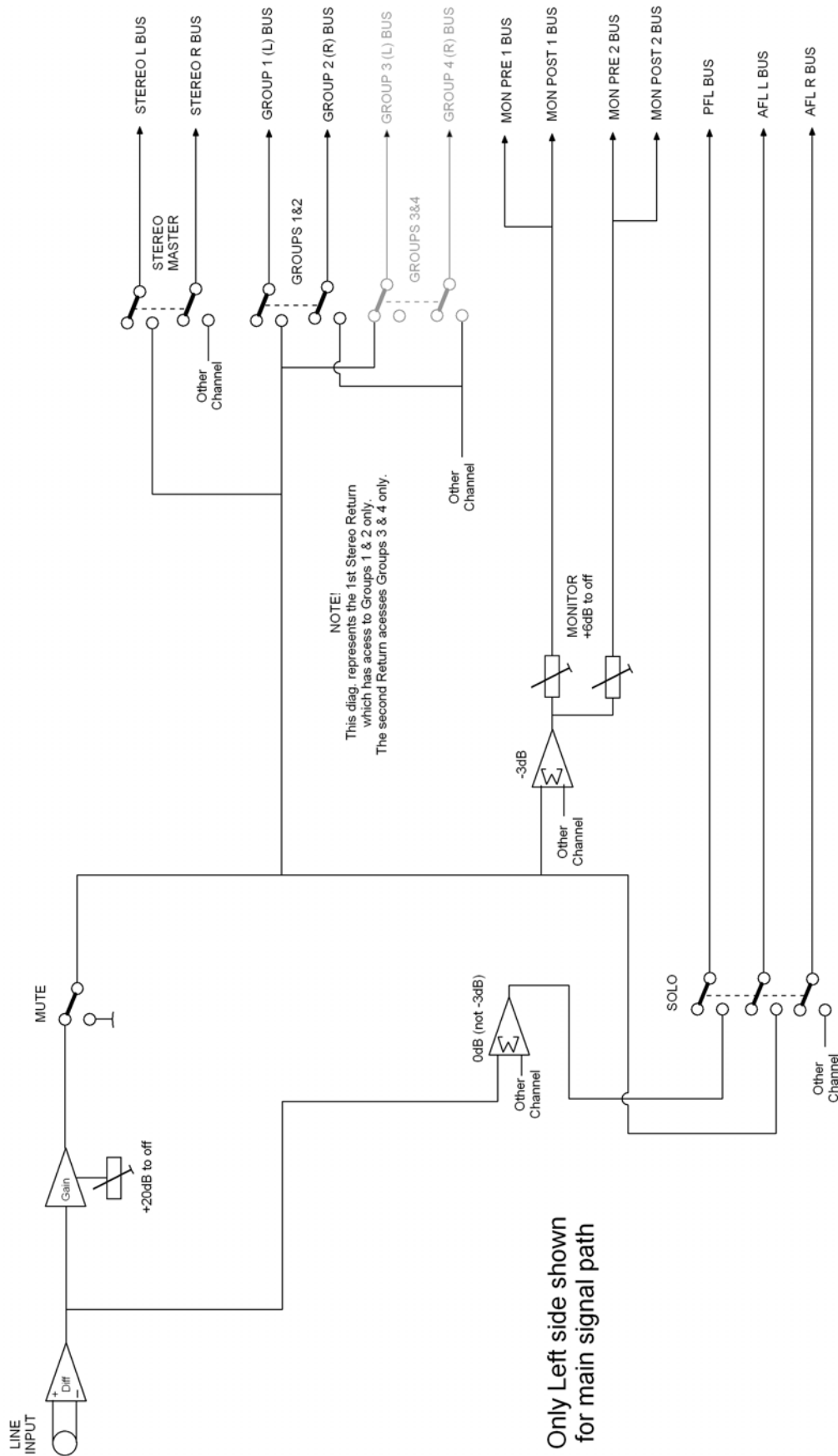

Group

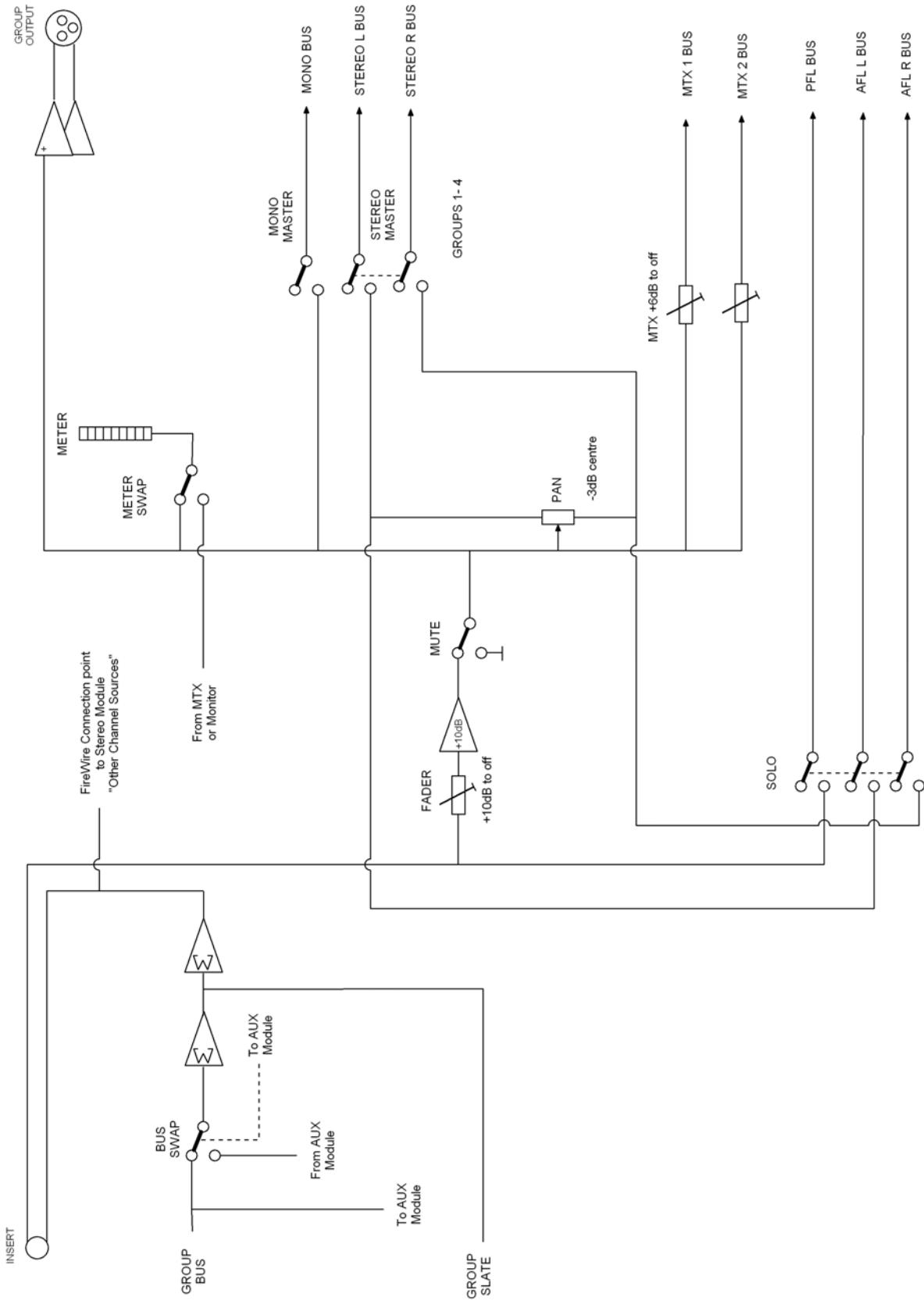

Aux

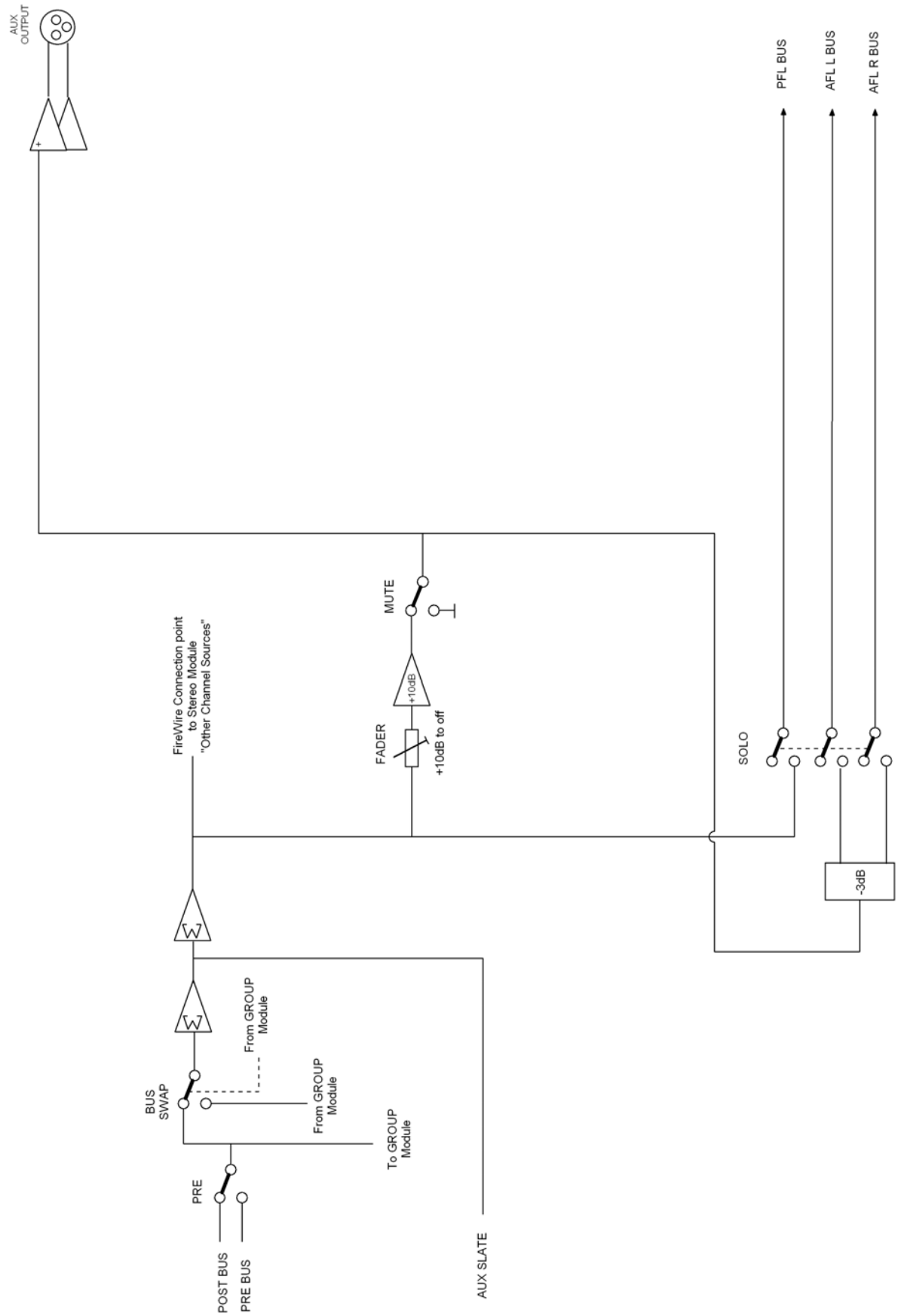

Monitor

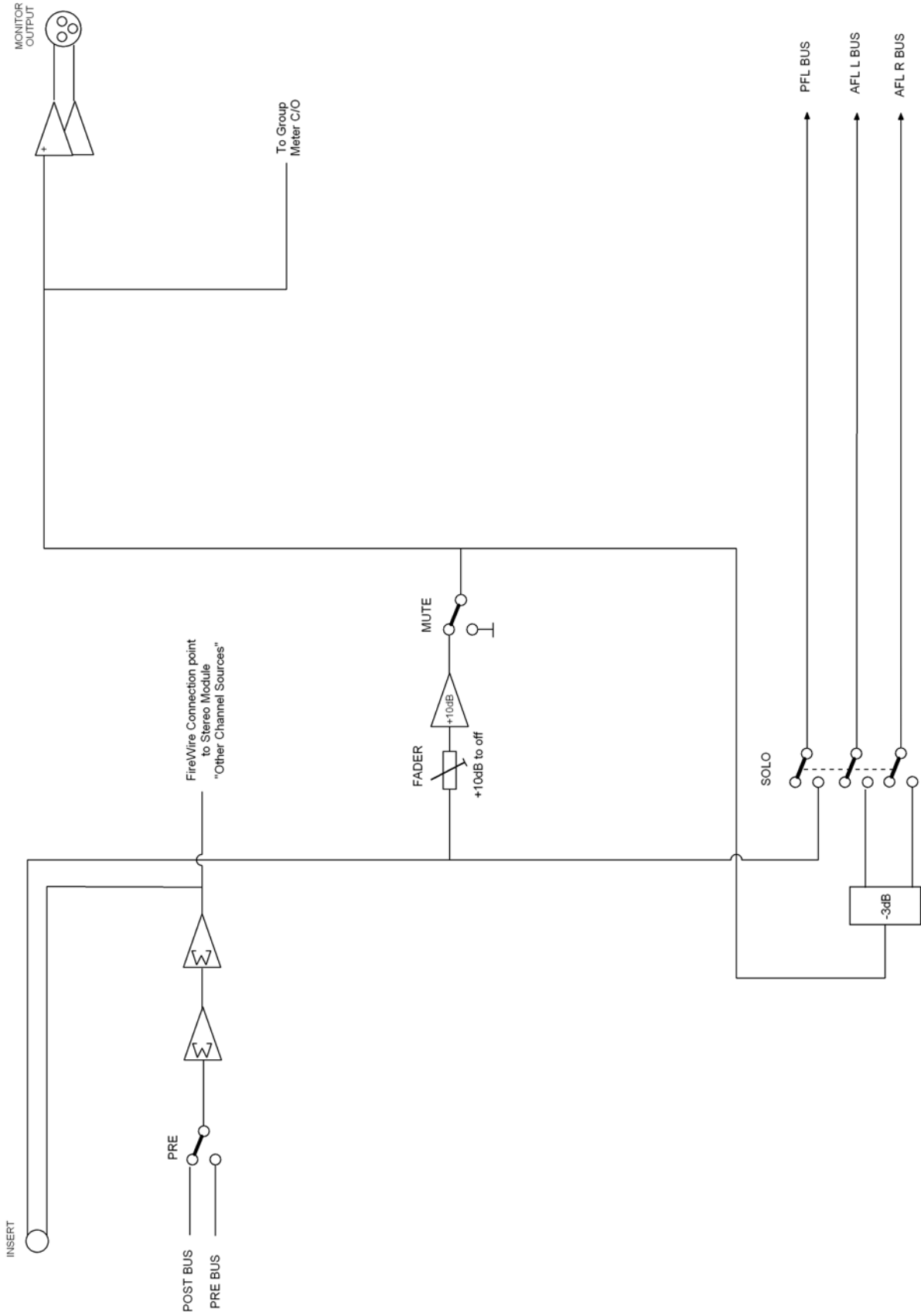

Stereo master

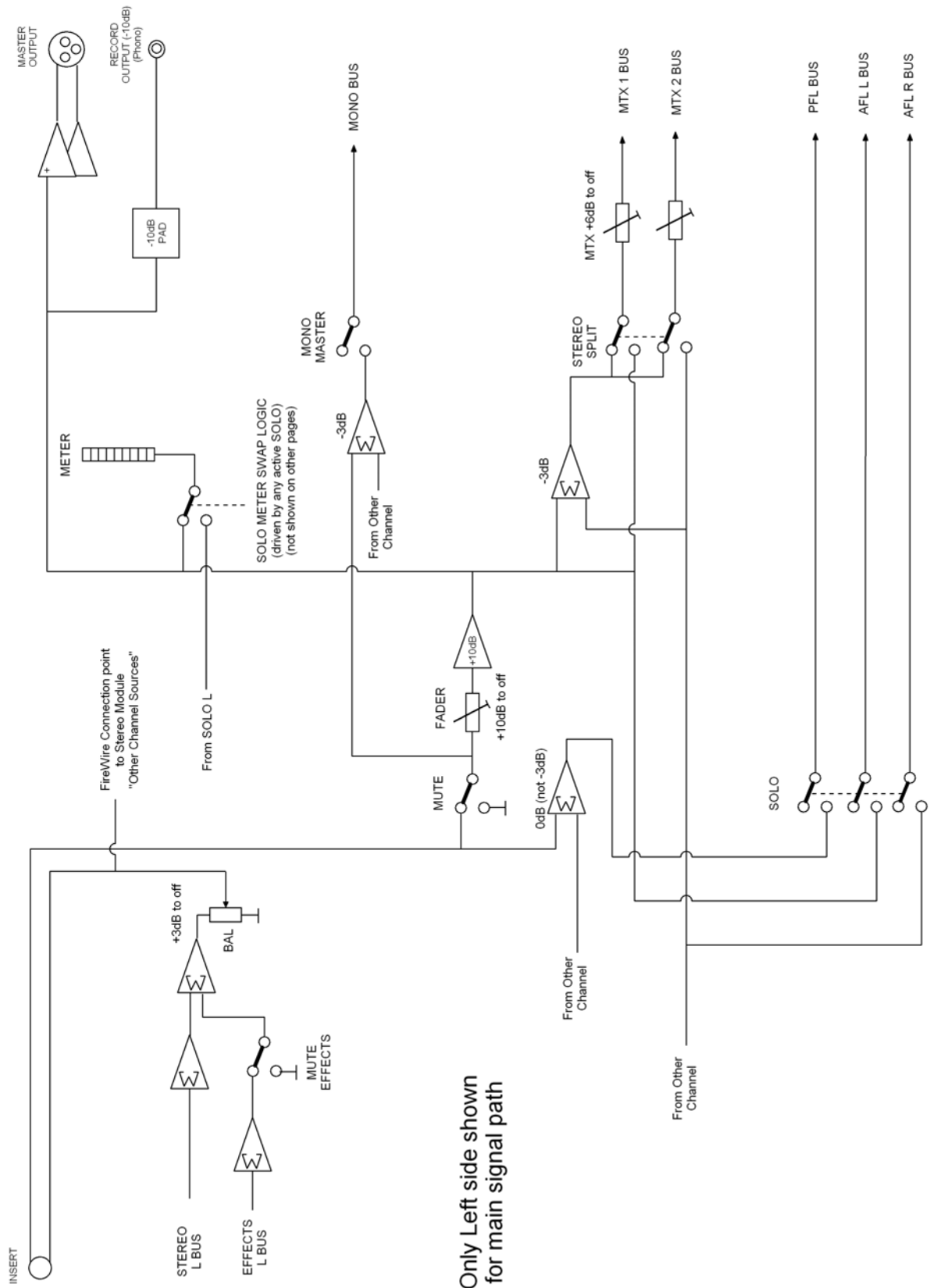

Mono master

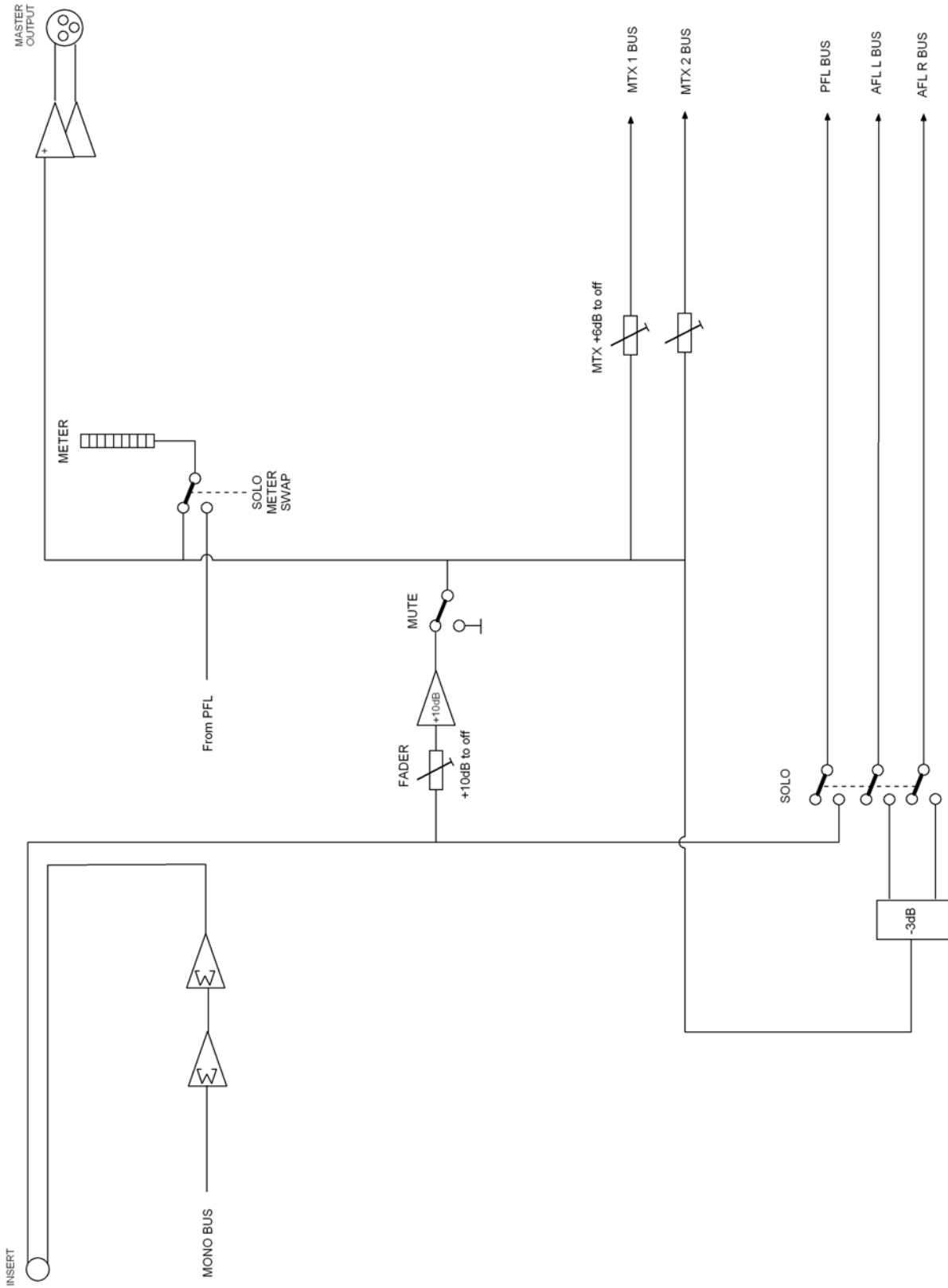

Matrix

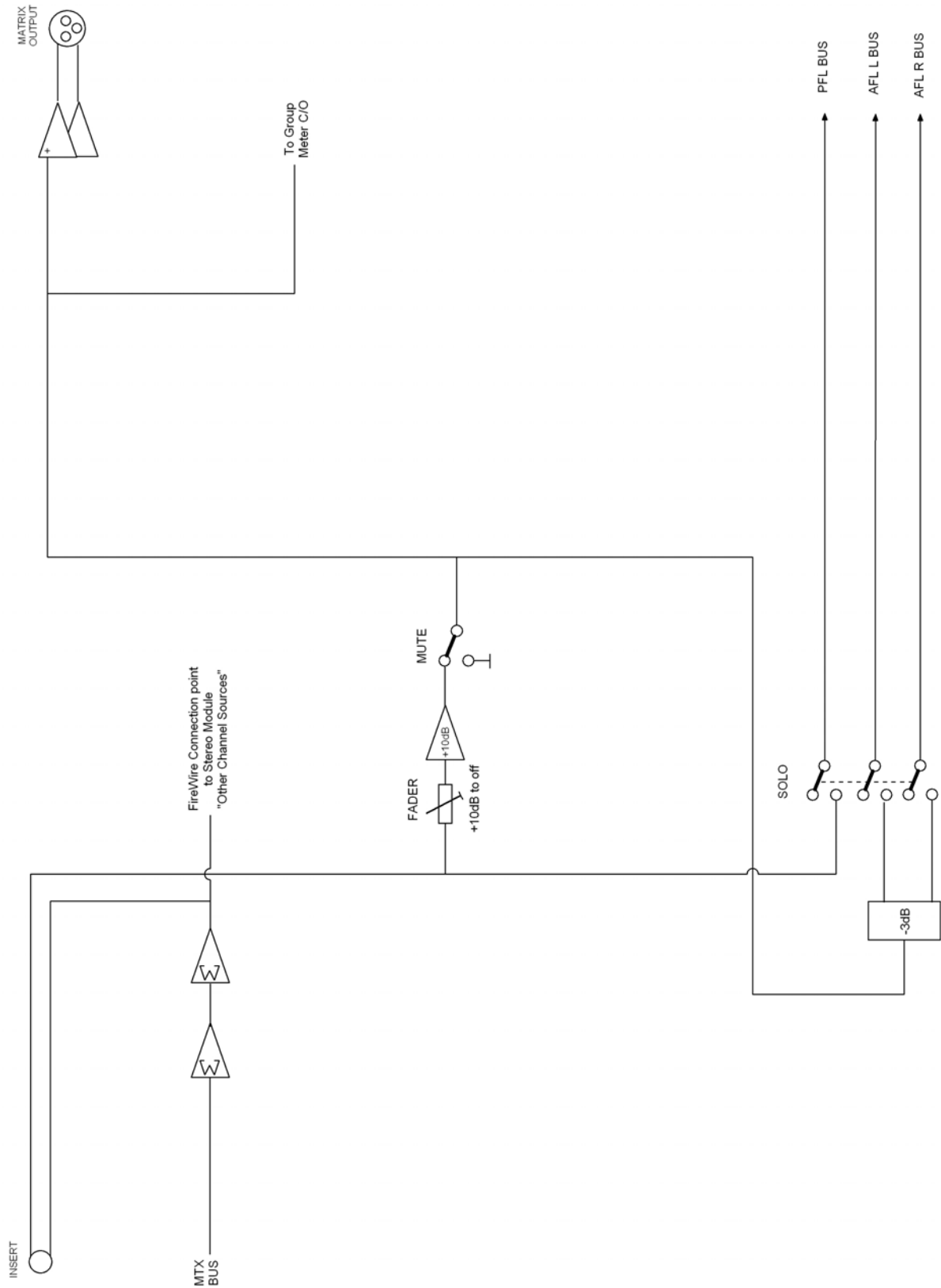

Solo and comms

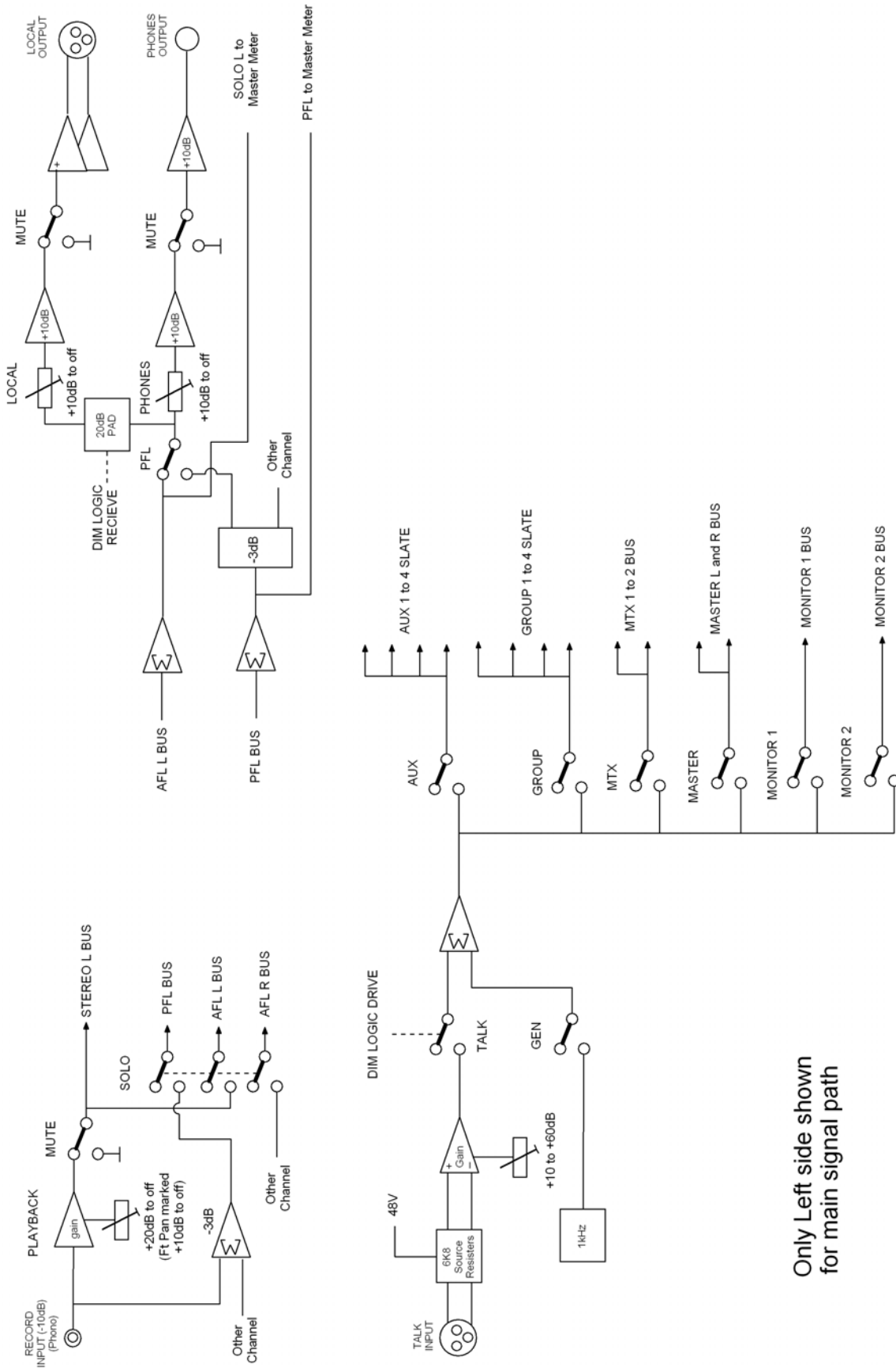

Only Left side shown for main signal path

Digital

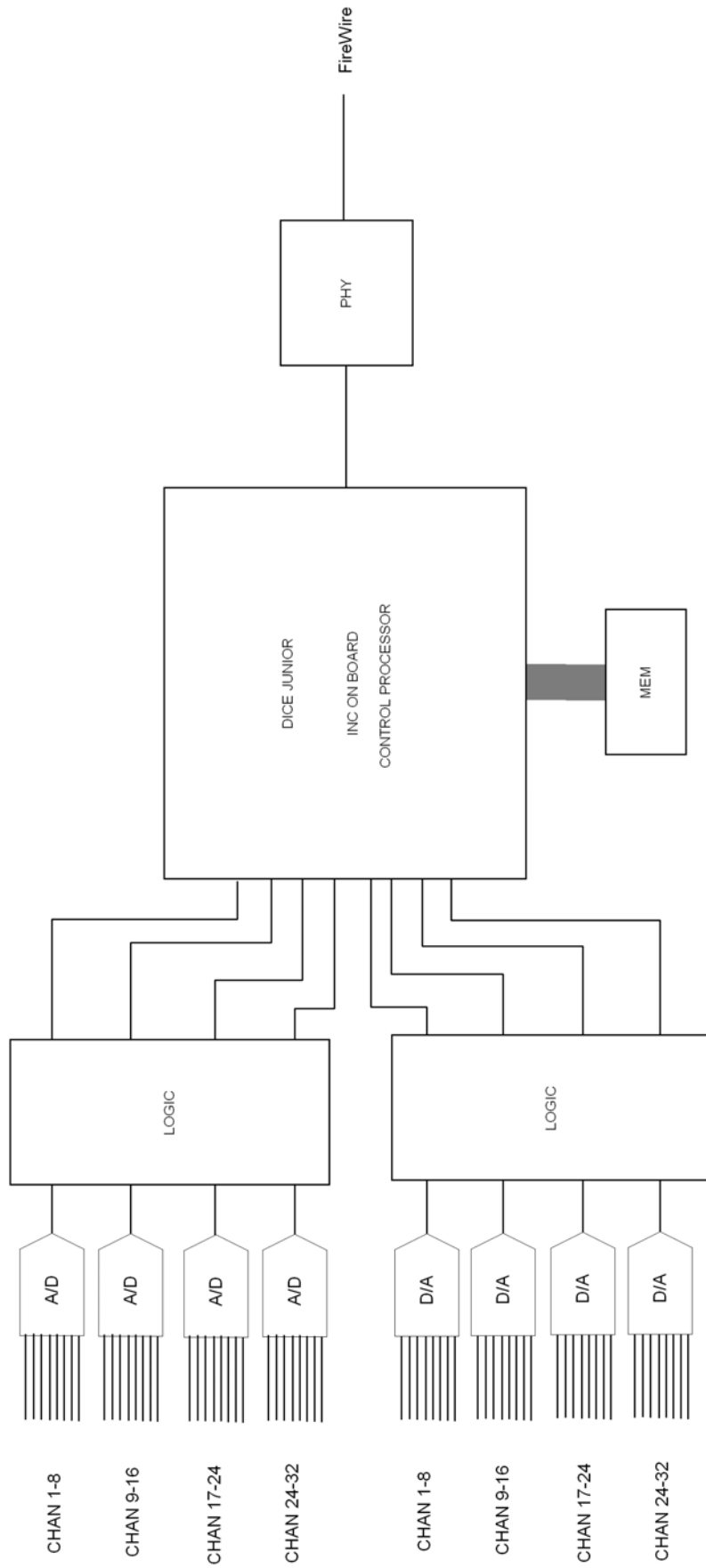

Appendix B: Technical Specification

This appendix provides the full technical specification for the VeniceF series of mixing consoles.

Due to a policy of continual improvement, Midas reserves the right to alter the function or specification at any time without notice.

Table 3: VeniceF technical specifications

<i>Item</i>	<i>Details</i>	<i>F16 and F16R</i>	<i>F24</i>	<i>F32</i>
Inputs (total)		22	30	38
Mono mic and line inputs (with inserts)		8	16	24
Stereo inputs (mic)		4	4	4
Stereo inputs (line)		4	4	4
Stereo returns		2	2	2
Playback		1	1	1
Buses		18	18	18
Groups		4	4	4
Monitors		2	2	2
Auxes		4	4	4
Masters		3	3	3
Matrices		2	2	2
Solos		3	3	3
Outputs				
Groups (with inserts)	XLR (balanced)	4	4	4
Monitors (with inserts)	XLR (balanced)	2	2	2
Auxes	XLR (balanced)	4	4	4
Matrices	XLR (balanced)	2	2	2
Masters — left, right and mono (with inserts)	XLR (balanced)	3	3	3
Playback	Phono	2	2	2
Direct outputs (mono input channels)	Balanced 1/4" TRS Jack	8	16	24
Stereo headphones	Balanced 1/4" TRS Jack	2	2	2
Local monitors	2 XLR (balanced)	2	2	2
Internal power supply				
Type		Switching	Switching	Switching
Voltage (VAC ±10%)		100 to 240	100 to 240	100 to 240
Frequency (Hz)		50 to 60	50 to 60	50 to 60
Consumption (W)		120W	150W	180W
Additional features				
Connector for desk lamps	4-pin, 12V/5W	1*	2	2
Accessories				
Dust cover		Included*	Included	Included

* F16 only.

Table 4: VeniceF performance specifications

Input impedance	Mic	2k balanced
	Line	10k balanced
Input gain	Mic	Continuously variable from 10dB to 60dB
	Line mono channel	Continuously variable from 0dB to 50dB
	Line stereo channel	Continuously variable from minus infinity to +20dB
	Line level inputs	0dB
Maximum input level	Mic	+11dBu
	Mic + pad	+31dBu
	Line mono channel	+21dBu
	Line mono channel + pad	+41dBu
	Line stereo channel	+26dBu
CMR at 100Hz	Mic (gain +40dB)	Typically 75dB
CMR at 1kHz	Mic (gain +40dB)	>80dB
	Mic + pad (gain +40dB)	>60dB
	Line mono channel (0dB)	>50dB
	Line stereo channel (0dB)	>30dB
	Line mono channel + pad	>50dB
Frequency response	Mic to mix (gain +60dB)	0dB to -1dB
Noise (20Hz to 20kHz)	Mic EIN at +60dB gain (mono channel)	-128dBu
	Mic EIN at +60dB gain (stereo channel)	-127dBu
	Mic EIN at +40dB gain (mono channel)	-125dBu
	Mic EIN at +40dB gain (stereo channel)	-124dBu
	0dB line to direct output (mono)	-90dBu
Digital input level	Sampling frequency	48kHz or 44.1kHz
	Dynamic range (20Hz to 20kHz)	105dB
System noise (20Hz to 20kHz)	Summing noise (16 channel routed with faders down)	-90dBu
	Line to mix noise (16 channels routed at 0dB, pan centre)	-86dBu
Distortion at 1kHz	Mic to mix (0dB)	0.03%
Crosstalk at 1kHz	Channel to channel	< -90dB
	Mix to mix	< -90dB
	Channel to mix	< -90dB
	Fader attenuation	> 90dB
Output impedance	All line outputs	50 ohms balanced source
	Headphones	To drive 32 ohms
Maximum output level	Line outputs (into 600R)	+21dBu
	Headphones (into 50R)	+18dBu (750mW)
Digital output level	Sampling frequency	48kHz or 44.1kHz
	Dynamic range (20Hz to 20kHz)	105dB

Nominal signal level	Mic Line	-60dBu to +10dBu 0dBu
Equaliser mono channel	Treble shelf Treble frequency Hi mid Hi mid frequency Hi mid bandwidth Lo mid bandwidth Lo mid Lo mid frequency Bass shelf Bass frequency	15dB boost/cut 2kHz to 20kHz 15dB boost/cut 400Hz to 8kHz 0.1 to 2.0 Oct 0.1 to 2.0 Oct 15dB boost/cut 100Hz to 2kHz 15dB boost/cut 20Hz to 200Hz
Equaliser stereo channel	Treble shelf Hi mid bell Lo mid bell Bass shelf	15dB boost/cut control at 12kHz 15dB boost/cut control at 3kHz (1.4 Oct) 15dB boost/cut control at 300Hz (1.4 Oct) 15dB boost/cut control at 75Hz

Dimensions

This section gives details of the external dimensions of the Venice*F* series consoles.

Table 5: Venice*F* technical specifications

<i>Item</i>	<i>F16</i>	<i>F16R</i>	<i>F24</i>	<i>F32</i>
Size (mm/inch)				
Width	600/23.6	482/19.0	804/31.7	1008/39.7
Depth	670/26.4	238/9.4	670/26.4	670/26.4
Height	278/11.0	576 (13U)/ 22.7	278/11.0	278/11.0
Weight (kg/lb)				
Net	21.2/46.7	18.6/41.0	24.5/54.0	33.6/74.1
Shipping	25.0/55.1	22.0/48.5	32.0/70.5	39.0/86.0

In the following diagrams dimensions are in millimetres, with the equivalent in inches enclosed in brackets.

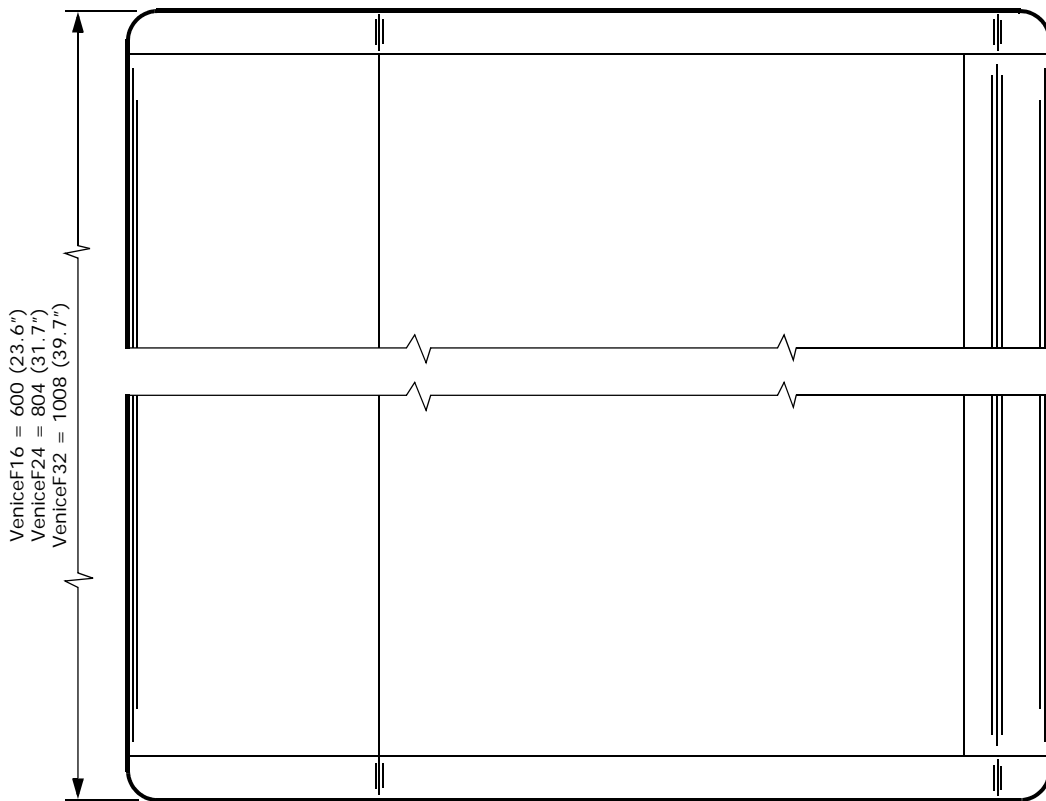
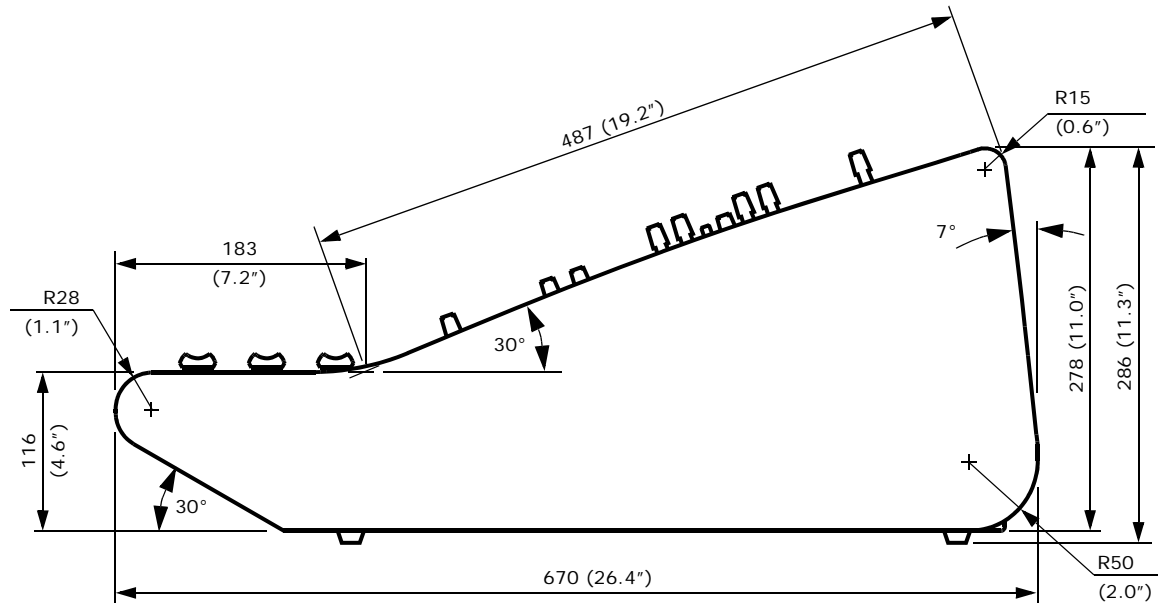

External dimensions of the F16, F24 and F32 consoles

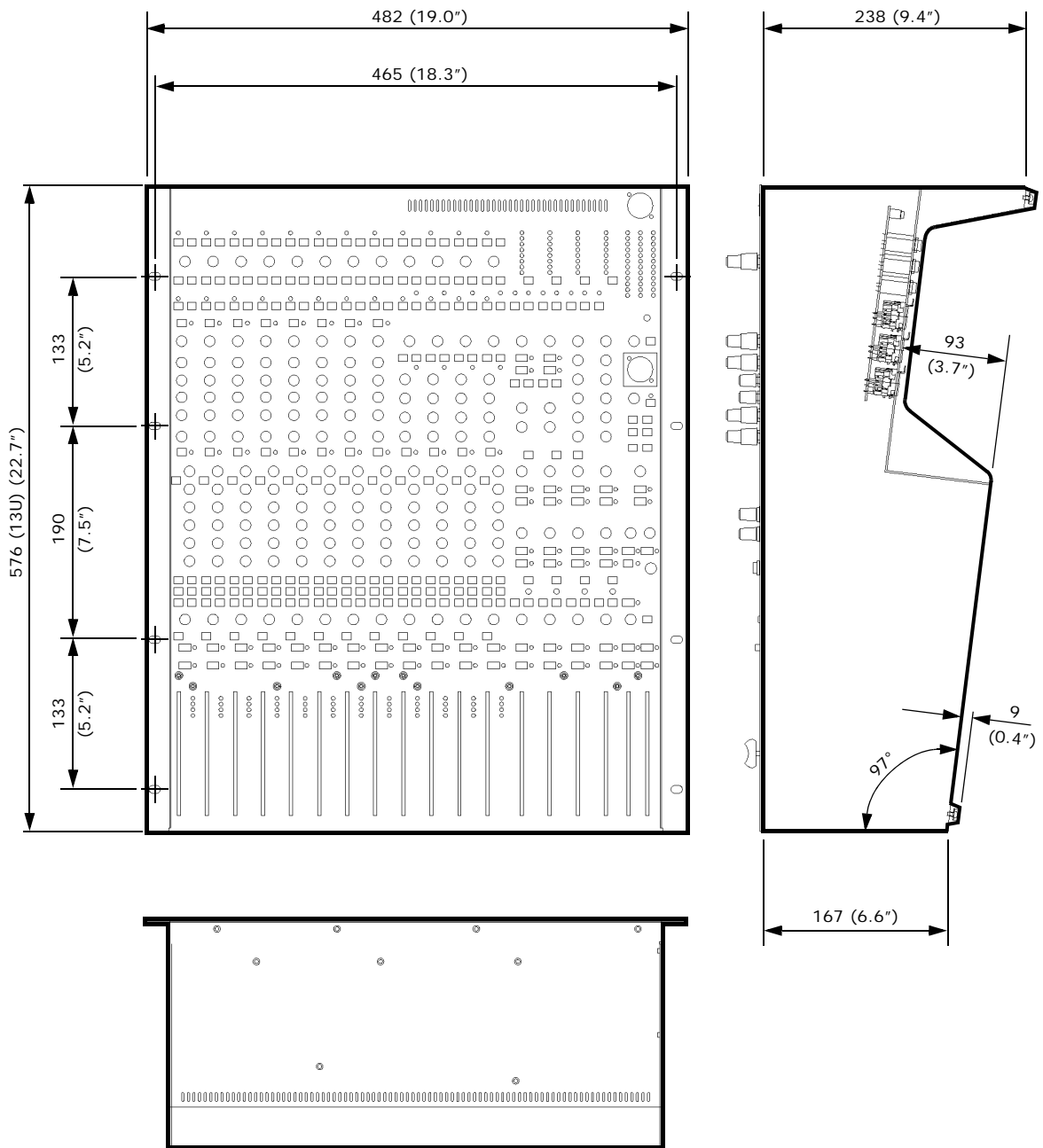

External dimensions of the F16R rack mount console

Appendix C: Application Notes

This appendix provides application notes as a guide to help you with VeniceF console operation. With its flexible routing and functionality, the VeniceF was designed with real-world sound engineers in mind, working in the real world. So, for engineers that haven't got a great deal of experience in live sound engineering, the following subsections may provide a few helpful guidelines.

Gain

The VeniceF has two types of input channel — mono and dual stereo — both of which also have microphone inputs. Gain is provided on these channels to allow the operator to obtain the optimal signal for the system:

- **Microphone gain** — range is +10dB to +60dB (-10dB to +40dB with pad switch enabled).
- **Mono channel line gain** — range is 0dB to +50dB (-20dB to 30dB with pad switch enabled).
- **Stereo channel line gain** — range is $-\infty$ (minus infinity) to +20dB.

Each channel of the VeniceF includes an LED meter, which indicates the channel level (measured after the channel insert and EQ but before the channel fader). With the insert and EQ disabled, the meter shows the level at the input in the following four stages:

- **-18dB:** signal present
- **0dB:** normal operating level
- **+12dB:** high signal level
- **+18dB:** 3dB before channel overload (clipping)

The input gain of the channel can be used to obtain the best operating level for the console. Too small a signal level (too little gain) and the best signal to noise ratio will not be achieved; too high a signal level (too much gain) and there is the chance of overloading the channel, causing distortion.

Clearly, the gain should be positioned between these two points to gain an optimal signal to noise ratio without overloading the channel. The ideal level for input channels would be around +6dB with occasional illumination of +12dB.

Headroom

A channel signal is only permitted to swing high and low by an amount fixed by the power supply. If the maximum output of the VeniceF channel strip is +21dBu (0dBu = 0.775 volts RMS) then imagine the following situation:

Headroom is the amount of spare 'swing' available to the system. If 9dB headroom was desired at all times, a maximum level of +12dB is required to retain the headroom.

To prevent overload the gain must be set to a point that even the highest output from the microphone during sound check has some headroom left to prevent any surprises during the show!

The console's buses (that is, the left and right main buses) are the point where all channel signals are summed together. In normal operation, it is unlikely that all

channels will receive the same signal at the same time so, typically, when 16 channels are summed together a gain of around 5dB to 8dB will be seen. It is important to leave some headroom in the summing amplifiers so that they do not overload, should the sum exceed the maximum level.

The effect of EQ

Channel equalisation should be used with care. Boosting or cutting equaliser bands can make monitoring your actual input level very difficult. Excessive boosting of EQ (+15dB is available on each band) will have the same effect as applying more gain to the input, taking up valuable headroom. Consider backing off the channel gain when using large amounts of boost (if you have to use large amounts of boost) to retain a sensible level at the output.

Excessive EQ cut can have a similarly undesirable effect. If a large amount of signal is cut in the equaliser section, gain may be used to 'make up' the level lost in the equaliser. However, the input pre-amplifier still has the same amount of available headroom. If gain, added to 'make up' the loss in the equaliser, exceeds the maximum level into the microphone pre-amp then the channel won't appear to be overloaded, but the microphone pre-amp will. Turning off the equaliser will reveal the true story, whereby the microphone pre-amp may be overloaded. It is worth considering whether such large amounts of EQ cut is really required, or whether it is being used rather more as a volume control (in which case the input gain could be set to a normal operating level and the output adjusted on the channel fader).



You can monitor the level pre-EQ and post-EQ using the LED meter by switching the EQ in and out during sound check.

Dynamic processing

When working with signals that are constantly at a high level the channel gain can accommodate these signals with ease. When working with varying signals, such as from a vocalist, it may be desirable to reduce the dynamic range of the signal so that the loud parts aren't so loud (and don't overload your channel input) and the quiet bits aren't too quiet (so the signal to noise ratio would be increased).

Limiters and compressors have a similar function, which is to reduce the dynamic range of a signal. The means by which they do this won't be discussed here, but these devices have the ability to reduce the level of loud signals automatically and also raise the gain to 'make up' the level as desired. The channel gain can now be set with adequate headroom to accommodate both loud and quiet signals, and the compressor can reduce the dynamic range and 'make up' any reduction in level. By inserting such a device into the channel's insert point you have the ability to remove the guesswork from setting your system gain.

However, there are still sources of potential problems. The VeniceF is able to operate at levels up to +21dBu on both the insert send and return. If the maximum input level of the compressor was less than +21dBu, it is possible to overload the input of the compressor. The only way to resolve this situation would be to drop the channel input gain so that the input level of the compressor was not being overloaded. **However, please note that the level returned from the compressor would also be lower than +21dBu and excessive use of the compressor 'make up' gain would overload the output of the compressor!**

Unity Gain

Unity gain is a gain of 1, that is, no gain or attenuation is applied to a signal.

If a signal entered a mono line level input of the VeniceF at 0dBu and the gain was set to +10dB (an internal 10dB attenuation sets the net gain to 0dB), then the signal was routed to each output at 0dB, the channel fader was set to 0dB and each output fader was set to 0dB, the output should be 0dBu (or unity). Some console manufacturers mark the 0dB level of their faders and pots 'U'.

Simple. But that's just one signal. If we have two 0dBu signals entering the VeniceF (assuming they are coherent, that is, the same level and phase) to be summed in the buses, the output would no longer be 0dBu.

Simply,

$$0\text{dBu} = 0.775 \text{ volts}$$

$$0.775 \text{ volts} + 0.775 \text{ volts} = 1.55 \text{ volts}$$

$$1.55 \text{ volts is } 0.775 \text{ volts } +6\text{dB (or a gain of 2)}$$

To retain an output of 0dBu (our previous unity level) each input must be reduced.

$$0.775 \text{ volts} / 2 = 0.3875 \text{ volts}$$

$$0.3875 \text{ volts is } 0.775 \text{ volts } -6\text{dB (or a gain of } 1/2)$$

So, each fader must be reduced to -6dB to retain the unity gain level of 0dBu on the console output. When using four inputs at 0dBu, the faders must be reduced to -12dB. Real life signals are not continuous, but the principle is the same. If you have a sinusoidal input that is nominally 0dBu on all 32 inputs with the channel faders at 0dB, the output is likely to be well above the 21dBu maximum output of the console and leave no headroom spare. With real world signals, 32 channels summed together will give around 6dB to 9dB gain because it is unlikely that all 32 channels will receive the same signal at the same time. Instead, signals will occur at different times, and there will be cancellation due to phase and frequency differences.

Signal Processing and Amplifiers

The final links in the system tend to be graphic equalisers, loudspeaker processors and finally amplifiers and speakers.

Graphic equalisers have the same problems as the VeniceF's EQ. If excessive boost is applied to the signal, the graphic equaliser's output may be overloaded. If the output of the VeniceF is higher than the maximum input level of the graphic, the input of the graphic may be overloaded.

Loudspeaker processors have similar problems. If the input level to the processor is too high, the input may be overloaded and introduce distortion into the outputs (and to the speakers!). In addition to this, any boost on the processor's outputs (say you want 3dB more bass) will cause that output to overload earlier (in this case 3dB before the other outputs).

Finally, amplifiers can introduce the most interesting results.

An amplifier has a sensitivity. That is, an input signal level that causes the amplifier to produce its maximum output level. For many amps this is 0dBu (0.775 volts RMS), others use 0dBV (1 volt RMS) others use different levels. Beyond this sensitivity, the amplifiers output will not be able to produce any more power and 'CLIP' (usually indicated by some serious looking red lights). Sending +21dBu level from the VeniceF will clip the output of most amplifiers causing damage to your loudspeaker system.

There are a number of solutions to this problem:

- Reduce the amplifier's input attenuators to a level where the amplifier and console clip at the same point.

For example, the input sensitivity is 0dBu, setting the input attenuator on the amplifier to -21dB would mean that the console would clip at the same time as the amplifier. So, operating the console sensibly the amplifier should never be clipped. The console LED meters will also accurately show the available headroom left in the entire system.

-21dB may not be a sensible level to set as many operators choose not to run the output of the console so high. That is personal choice.

- Run the output of the console at a level below 0dBu.

This solution means that you won't get full benefit of the console, and may suffer a reduced signal to noise ratio, especially when running over long signal cables. But the amplifiers should be saved from clipping.

As with many things in the audio world, use your ears. If something sounds distorted, do the following:

<i>Problem</i>	<i>Action</i>
Input gain is too high	Lower input gain
EQ has too much boost	Disable EQ
EQ has too much cut and has a high input gain	Disable EQ
There is too high a level entering the inserted processor	Disable insert
The loudspeaker controller or amplifiers are clipping	Check clipping indicators on amplifiers etc.

Routing

The flexible routing of the VeniceF allows the console to operate as both a FOH and monitor console, or as a combination of both. For operators that haven't got a great deal of experience, here are a few helpful guidelines.

FOH mode

The group-aux changeover switch on each group (see "Group-aux changeover" on page 56) should be released (in the off position) so that the group fader controls the group bus signal.

Uses for groups vary, but include:

- **Submixes** Submixes are a common way of saving time (and possibly embarrassment) when using a large number of microphones at once. For example, multiple microphones for choirs, drum kits/percussion, orchestras, etc.

The channel to be submixed should be routed to the group and any aux sends ONLY (that is, not to the master L-M-R). The fader is, as normal, used to set the relative level between the channels in the submix. The group chosen for the submix should then be routed to the master L-M-R and panned as required.

The submix is now set up. The group level can be used to control the overall level of the channels (retaining their relative levels), mute the submix output or solo the submix signal.

Note: *Muting the submix is not the same as muting the channels. Aux sends and other group sends will remain active.*

- **Common EQ/processing** Often, it is either too expensive or undesirable to apply processing to each channel individually (for example, compression on a whole choir, graphic EQ on a number of microphones, etc.). Setting up a submix as above, the signal is grouped together. Now the desired processor can be inserted into the group inserts applying the processing to all of the submix channels (in their relative levels).
- **Alternative outputs** For example, you were mixing a number of speakers in a venue and each needed a different level and processing.

Route the desired channels to any group or master output as necessary. Make sure the group is not routed to the main outputs. The group outputs should be wired into the necessary amplification and the insert points into any necessary processing (for example, delay, EQ, etc.).

The levels are now individually controllable.

MON mode

The group-aux changeover switch on each group (see "Group-aux changeover" on page 56) should be depressed (in the on position) so that the group fader controls the aux bus signal.

Channel signal should be sent to the aux, as required, and the aux sends should usually be configured to pre-fader. The console group output sockets should be wired into the necessary amplification and the insert points into any necessary processing (for example, EQ, etc.).

The monitor levels are now individually controllable on the group faders.

Dual FOH/MON Mode

The group-aux changeover switch on each group (see "Group-aux changeover" on page 56) should be depressed (in the on position) so that the group fader controls the aux bus signal for monitors or released (in the off position) so that the group fader controls the group bus signal for FOH. The usage in this split mode can be any combination of the above!

Note: *When the group-aux changeover switch is depressed, control over the groups is performed by the aux controls and hence, and group outputs may still be used. Submixes could be used by connecting the aux output sockets on the rear of the console to four unused stereo input channels and routed to the left and right master buses.*

Appendix D: Crib Sheets

This appendix provides you with a template each for the mono and dual stereo input channels. These will help you keep a record of your most important settings and make notes. If necessary, you can make copies of these pages if you need more records.

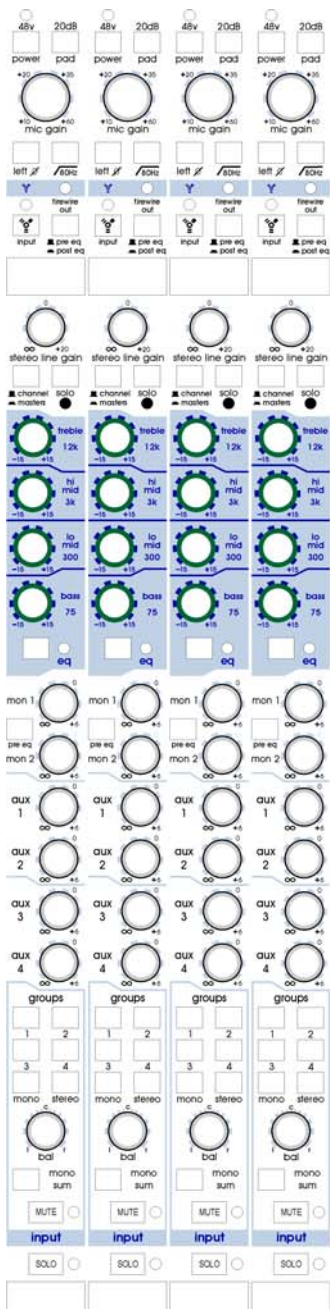

Dual stereo input channels

Notes:

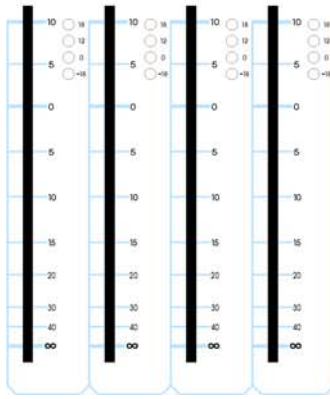

Appendix E: Best Grounding Practice

This appendix gives details of the best grounding practices for the VeniceF console in order to get the optimum performance out of it.

Safety first

The VeniceF is classified as a class 1 device and as such there is a safety requirement for the power cable to provide an earth connection to the console. This connection is bonded to all external metal parts such that in the event of a failure within the AC power systems it is impossible for any external parts of the product to become live. When connecting other equipment to the VeniceF to form an audio system, it is likely that some of these additional devices will also be class 1, so they will require a safety earth too. For your own safety, the safety of others, and to comply with the law, it is important that none of these earth connections are tampered with in any way.

Ground loops

When connecting audio signals or data between devices within an audio system, a signal ground connection must be provided that screens the signals from electromagnetic interference. This ground connection, combined with the safety earth, produces a ring of conductors often referred to as a "ground loop". Typically, this gives rise to induced currents within the components of the loop, namely the ground conductors, the chassis of the equipment and the safety earth conductors. This is not dangerous, but if the grounds are used as a reference for audio signals, as occurs with unbalanced connections, the ground currents may generate small voltages that corrupt the signal integrity. The audible results are noise added to the intended signal. Typically, this sounds like hum (from the power AC voltage), buzzing or whistles (from power supply diodes or switch mode power supplies), or digital noise (from computers).

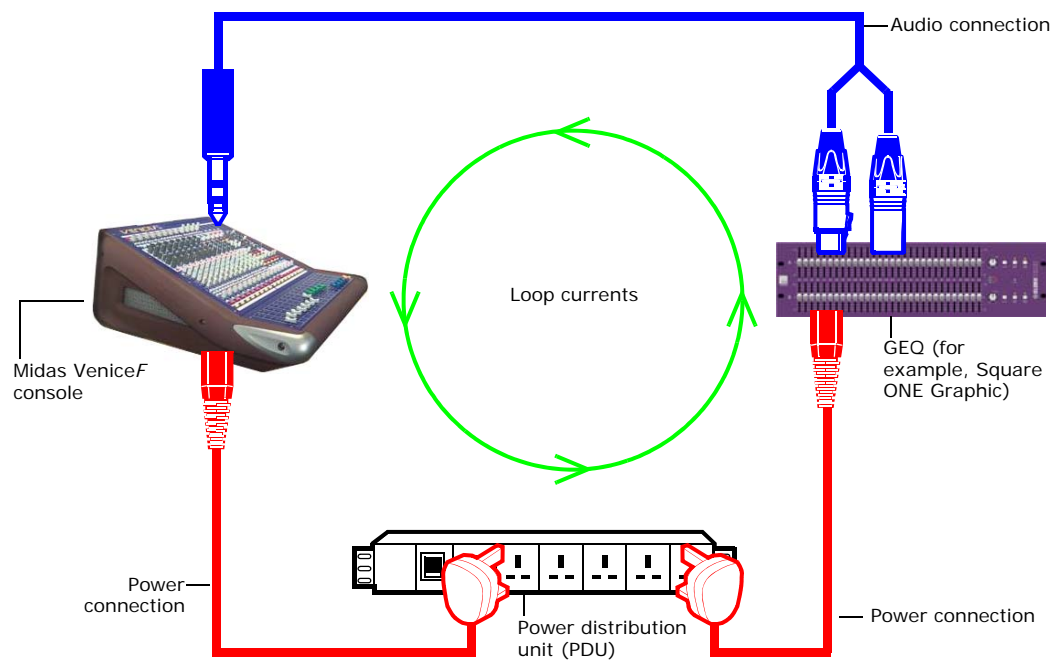

Ground loop

Noise sources

Audio manufacturers have known about these issues for many years and most equipment is designed to reduce ground loop generation to the bare minimum or to minimise the effects. But, as switch mode power supplies and computers become more common place, the earth/ground environments that audio systems operate in become more and more contaminated by noise currents from both within the system and from external sources.

The FireWire connection on the VeniceF is an example of this. The high speed nature of the connection necessitates a good screen ground to bond the computer to the VeniceF. However, if the computer is grounded via its power cable a ground loop will exist that can inject current into the console chassis and may produce currents or small voltages that can affect other externally connected equipment. The size of the injected current will vary from one computer to another, depending on the quality of the grounding and components used internally, and within its power supply. To eliminate this problem, computers with an isolated power supply are the best choice.

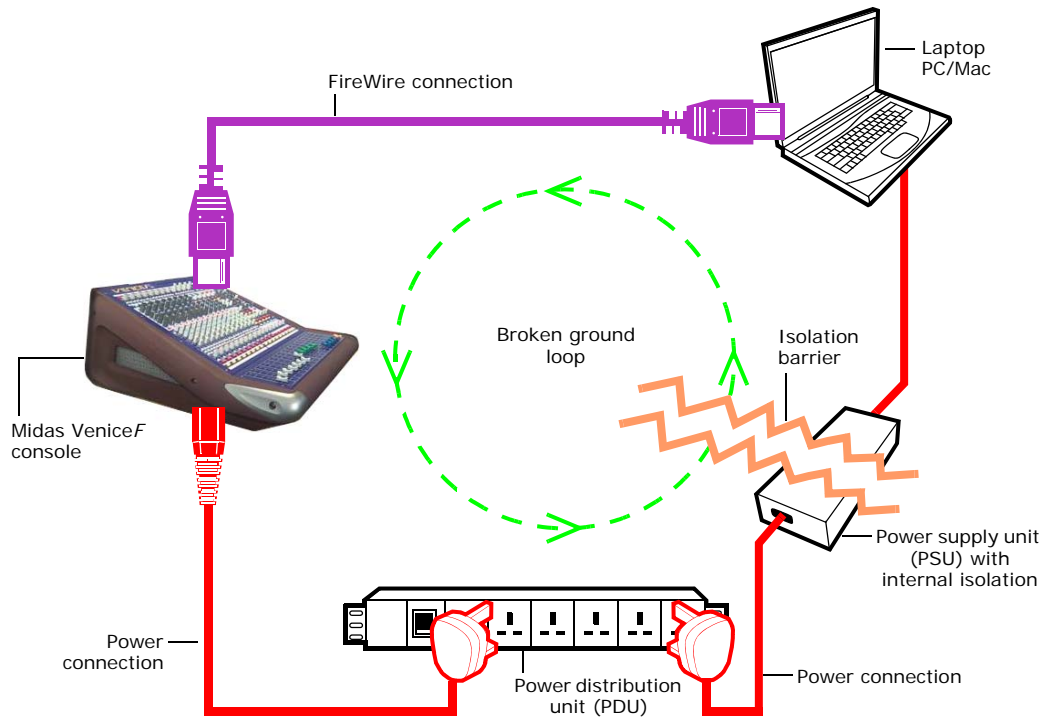

Isolated FireWire computer system. Note how the isolation barrier breaks the ground loop.

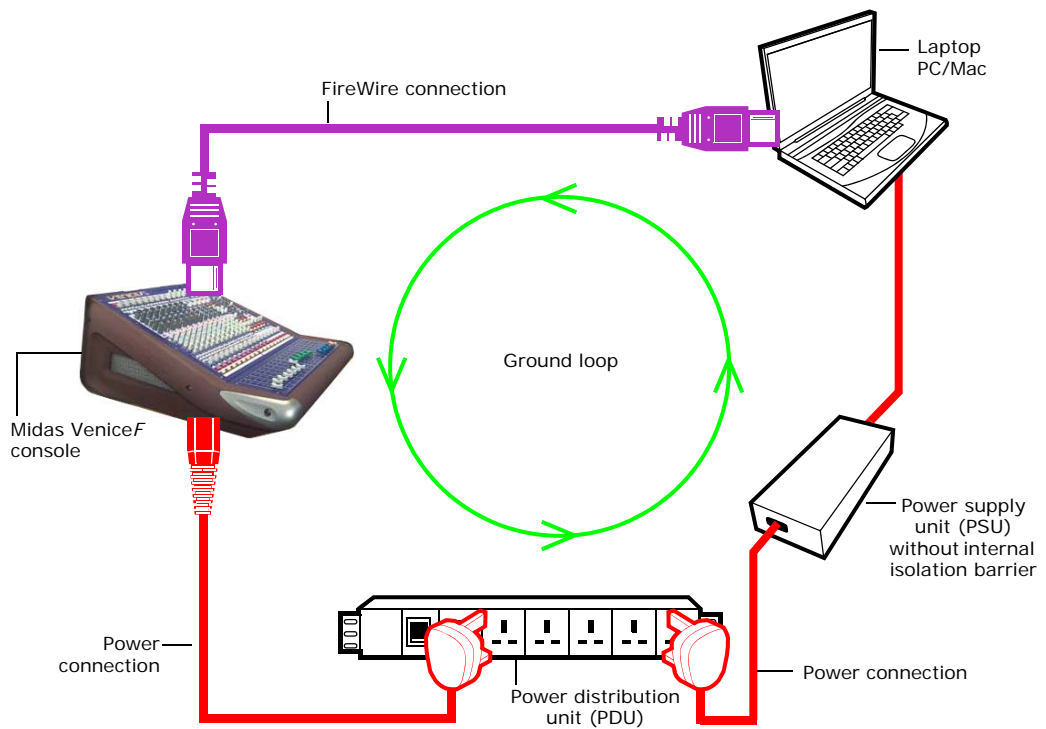

Non-isolated FireWire computer system. With no isolation barrier, the ground loop is present.

Noise solutions

The grounding on the VeniceF is very robust and often such ground loop induced noises are negligible, but to get the very best out of your console, and especially out of any less robust equipment within the overall system, some consideration should be given to good grounding practice as follows:

- **Power** Connect all equipment within the audio system to a power distribution system with a source that has been set aside for that use alone. This will provide a degree of isolation from other ground noise inducing apparatus, such as fans, lighting, etc.
- **Cable runs** Plan power cabling as far as is practical so that it follows the same physical paths as the audio connections. This reduces the area contained within any ground loops, which will minimise the currents induced from magnetic fields into their conductors. Similarly, audio cables to and from equipment racks should be dressed together to reduce loop area — additionally, producing a tidy appearance.

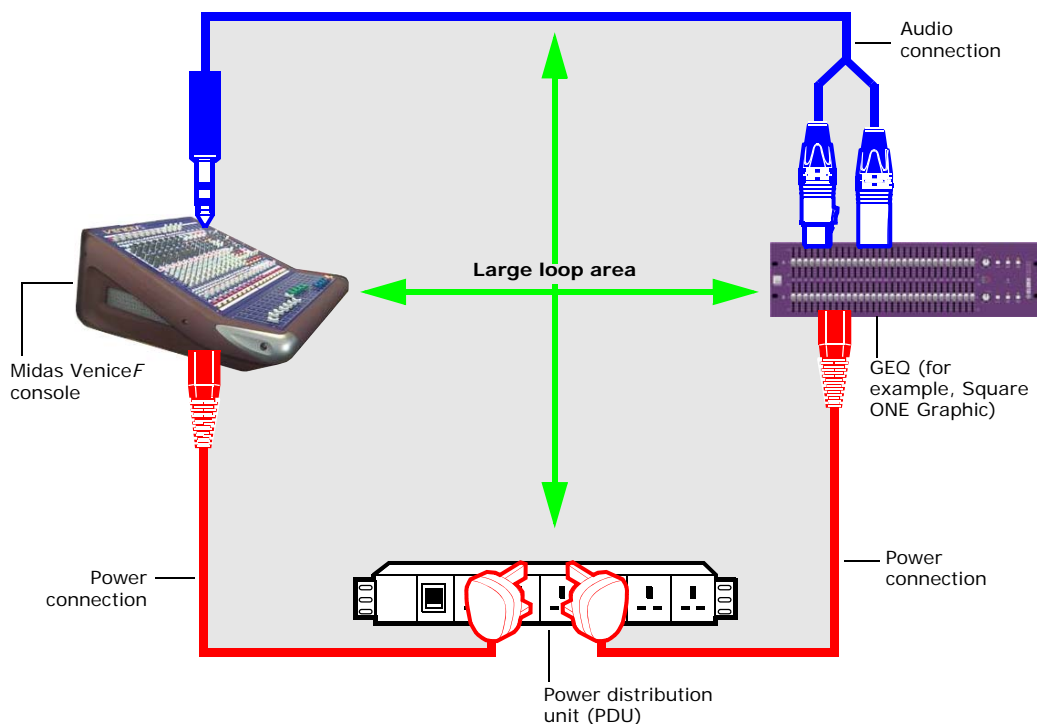

Loop area diagram showing a large loop area

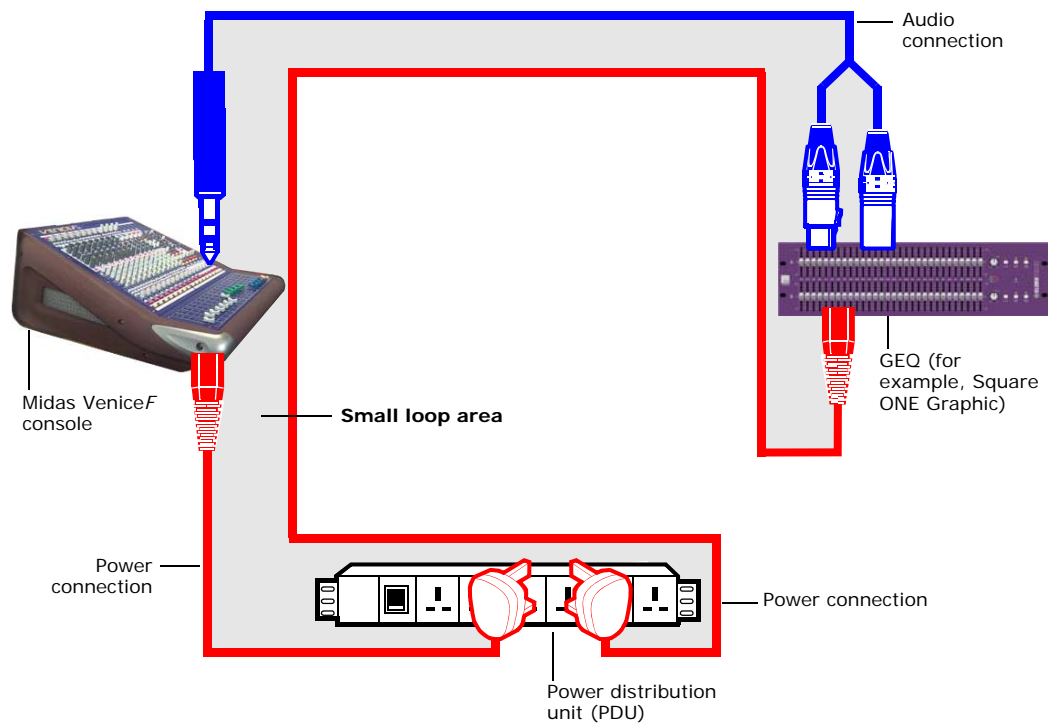

Loop area diagram showing a small loop area

Balanced connections

Balanced connections are generally immune to ground loops because the grounded screen conductor is not used as a reference for the signal conductors. Instead, each conductor of a balanced connection is a reference for the other, and any induced noise is rejected because it is common to both conductors. The process of eliminating noise like this is called common mode rejection (CMR), which is often measured as a ratio (common mode rejection ratio (CMRR)). CMRR is dependent on the performance of the sending and receiving circuits at either end of the connection.

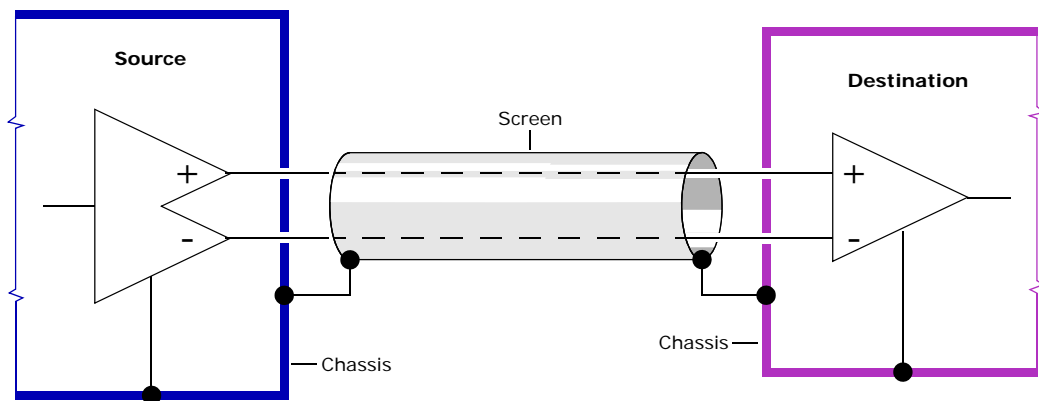

Balanced connection diagram

Balanced transformers

Active electronic circuits achieve good results, but for ultimate noise rejection, transformers are needed. Transformers colour the sound especially at low and high frequencies due to core saturation and impedance rises. They are also expensive, so they are typically only used as external problem solvers when all else fails.

Screen termination

Sometimes ground loop currents are so strong that even balanced systems can pick up some noise. This is because the currents manage to find a way into a piece of equipment's internal unbalanced circuits. This is easily cured by breaking the screen ground connection, so that it is only connected at one end of the cable. Opinions as to which end to break differ within the audio industry but:

- Induced noises in electronically balanced systems are typically best rejected by input stages, so breaking the ground there will generally give the best audio performance. This also allows any common mode AC currents from the output driver to return via the screen ground to their source rather than finding a longer path through the power cables, which may give rise to noise or crosstalk elsewhere.
- Alternately, breaking the screen connection at the send end provides a much more practical grounding scheme if cables are to be hot plugged. Then any cables that are plugged first (that is, only) into an input will have a screen and thus will not be a source of severe electromagnetic interference (which would be the case without the screen connection).
- If a transformer is utilised within the balanced connection the best CMRR performance will be obtained by breaking the screen ground at the transformer end of the cable.

With long cable runs, sometimes the impedance of the screen conductor is high enough that disconnecting one end allows some electromagnetic interference through the screen onto the signal conductors. This is typically audible as stray local radio transitions, typically at very low levels. If this is a problem, it can be cured by bridging the break in the screen connection with a capacitor. This improves the screen at high frequencies, but maintains the isolation that breaks ground loops at lower frequencies. 10nF to 50nF are good values to use and are available in ceramic packages that are small enough to fit inside connector shells. Some experimentation may be necessary, especially if multiple cables are bridging two units, because in this case the capacitors are effectively connected in parallel and their combined value will grow (for example, 32 channels at 50nF will equate to 1,600nF). It is probably better to use 10nF for this kind of multiple connection, so that the overall value only grows to 160nF.

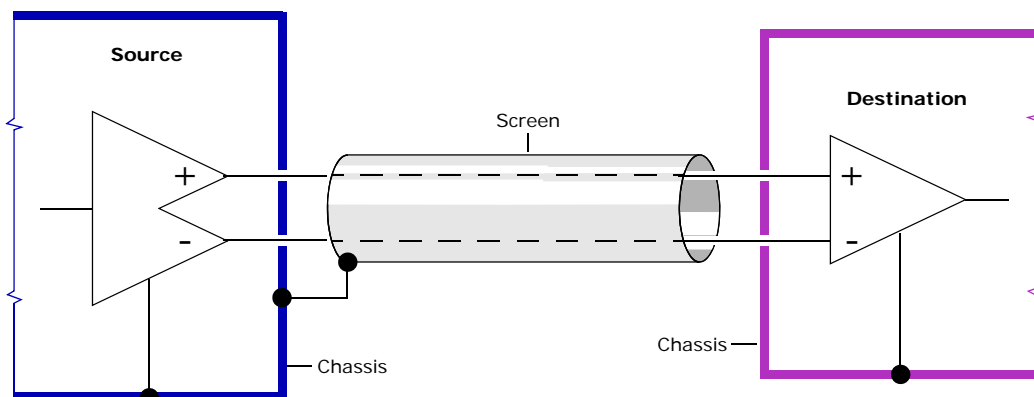

Screen termination diagram showing screen broken at destination

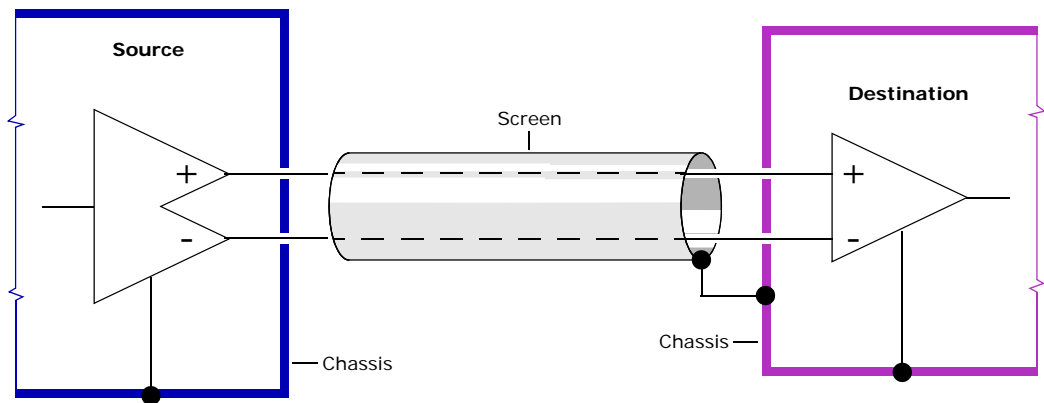

Screen termination diagram showing screen broken at source

Ground referenced connections

Many unbalanced signals are passed between pieces of equipment where one of the devices is balanced and the other is not. By careful wiring using two-core cable with an overall screen, it is possible to convert this connection so that it operates in a similar way to a balanced system, with a ground reference that is not corrupted by ground loop currents in the shield. One conductor carries the signal from the unbalanced device to the hot connection on the balanced unit, while the other conductor carries the ground as a reference from the unbalanced device to the cold connection on the balanced unit. The screen is connected at the unbalanced end only. This referenced connection works for balanced to unbalanced and vice versa.

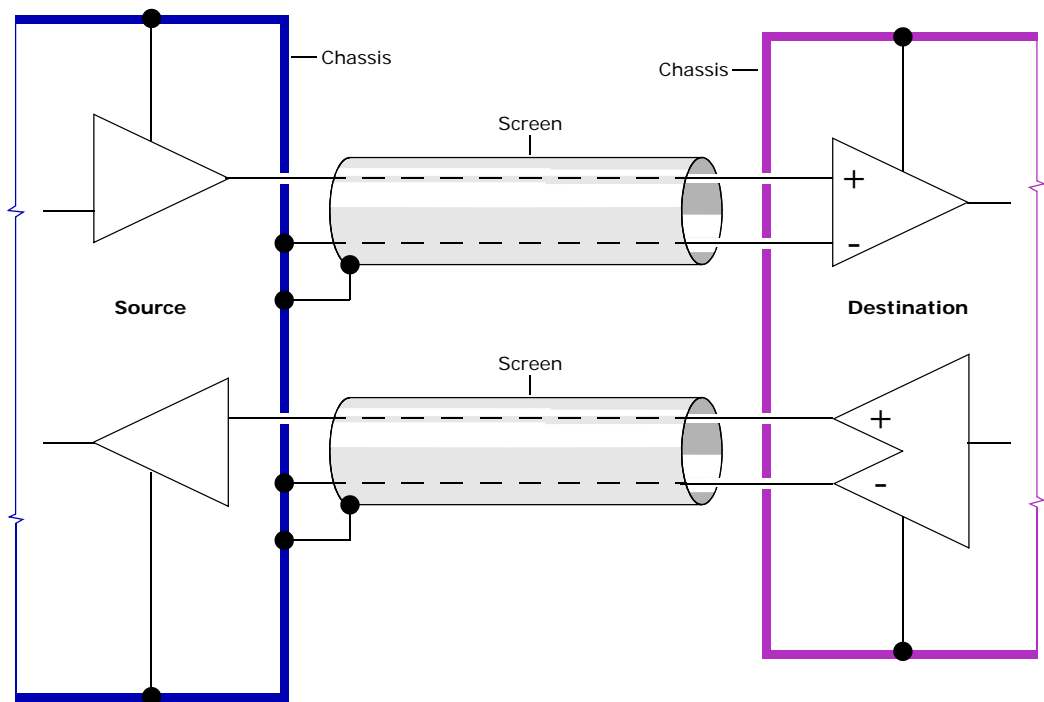

Ground referenced insert wiring diagram. For a typical example of how to wire a ground referenced insert, see Figure 1 on page 13; the example above shows the screen connection at the other end because it is more practical, as it reduces the wiring complexity within the 1/4" TRS Jack connector.

To save space and cost, as is typical for consoles at this point in the market, all inserts on the VeniceF are unbalanced, with send and return on the same jack. When

connecting balanced external processing equipment to the insert points, the connection method described in this section should be adopted so as to benefit from the CMR of the external unit.

For an example of how to wire a ground referenced insert, see Figure 2 on page 13.

Unbalanced connections

Ground loops with unbalanced signals are more difficult to deal with, but there are several good techniques available. Firstly, many sources of unbalanced signals are battery or class 2 powered devices without a safety earth connection, thus ground loops are not being generated. These signals can be connected via single conductor cables with an overall ground shield and should not present any problems.

Signal ground lift

Older processing equipment is often unbalanced, but even if it is a class 1 device, very often the internal signal ground can be isolated from the safety ground. This is normally achieved by setting an external "ground lift" switch or breaking an internal link. Refer to the equipment's manual and qualified technicians for advice on any such internal links. If ground isolation is available it should be used so that the screen ground connection from the insert points on the console provide a reference for all signals within the inserted unit, eliminating the possibility for induced noise to corrupt the signal path. Two core cables should be used with one core carrying the signal and the other carrying the ground plus an overall screen (also grounded). The screen can be connected at both ends or, as with balanced systems, it can be broken at one end if that improves performance. Some experimentation may be needed.

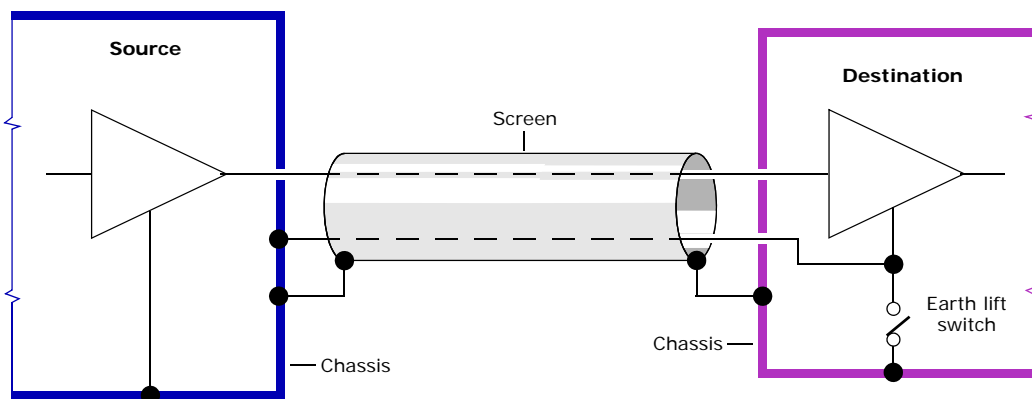

Ground lift connection on destination

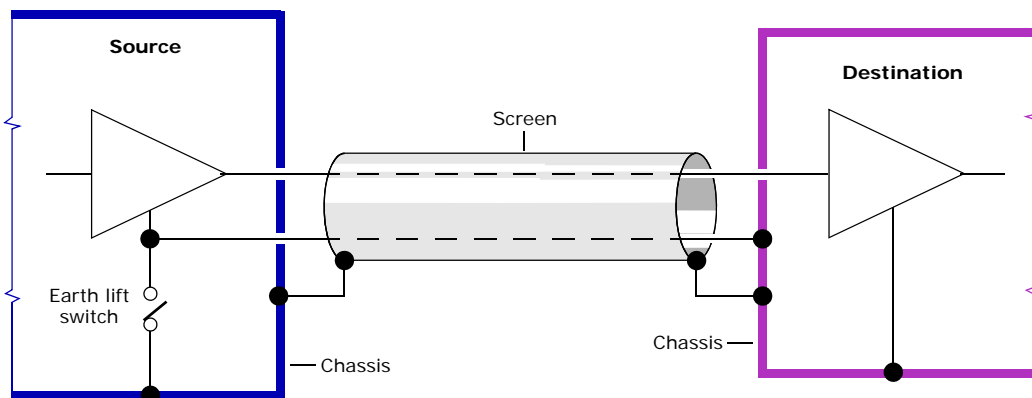

Ground lift connection on source

XLR shells

XLR pin 1s should only be used to provide a ground connection for cable screens. The shell (body) of cable XLRs also need to be connected to ground so they provide a screen for the terminals, but they should not be wired internally to the pin 1 terminal. Their ground should be prevented from contact with the panel XLR connector body. This is particularly important for unbalanced connections where an internal connection from pin 1 to the connector shell could compromise ground lifting schemes. With this wiring arrangement, joining XLR cables together to increase the overall length is best avoided, because the joint will not be properly screened. However, if absolutely necessary it is unlikely to cause major problems.

Signal ground bonding

If an unbalanced connection is required to external equipment with signal grounds that cannot be isolated from safety earth it will be difficult to eliminate ground loop currents, but their effects can usually be reduced. The currents within a ground loop will generate small voltages in the cables, including the signal grounds. Any voltages that develop in the signal grounds will appear as noise errors in the audio. If the impedance of the screen cables is reduced, the voltage developed by the ground loop will also be reduced. So, if the impedance can be zero there will be no noise. This is difficult to achieve, but ground bonding the external equipment rack to the chassis of the VeniceF will have a similar effect and will significantly reduce noise in unbalanced connections between the two locations. A binding post chassis ground is provided on the VeniceF for this purpose.

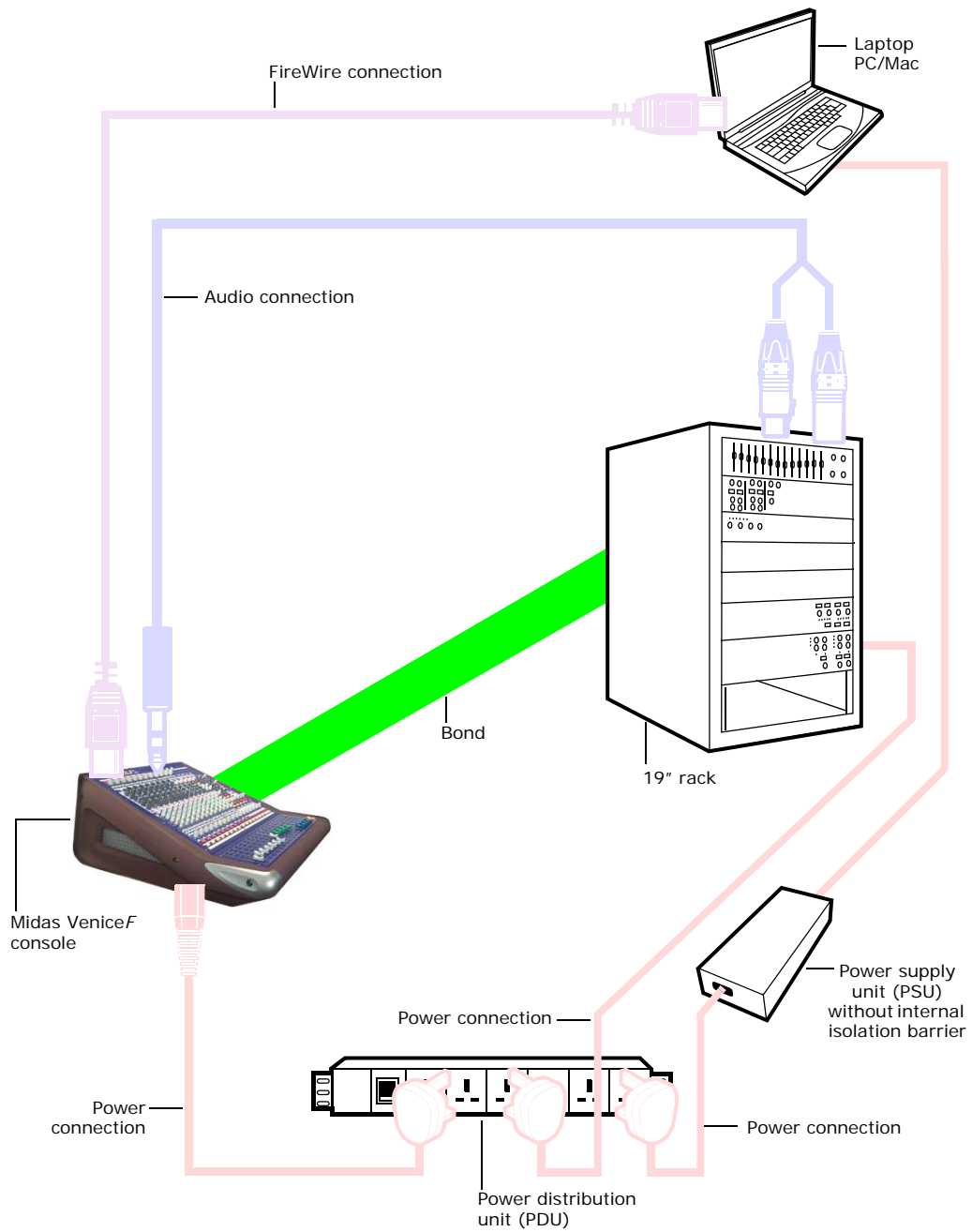

Diagram showing the bond connection between console and 19" rack

Appendix F: Service Information

This appendix give details of how to look after your VeniceF.

Routine maintenance

To help keep your VeniceF unit in good working order and to make sure it gives you optimum performance, we recommend that you carry out the following about once every month.

- Clean the console, as detailed in "Cleaning the console" below.
- Check controls for freedom of operation. As the controls are 'self-cleaning', this operation will help to prevent them from sticking.
- Check the functionality of all controls, that is, control knobs, faders, pushbuttons, LEDs, etc.
- Check the functionality of the equipment.

Cleaning the console

Switch off the console and electrically isolate it from the mains before cleaning.

Clean the console using a dry, lint-free cloth. Do not use harsh abrasives or solvents. When cleaning the console, take great care not to damage faders, pushbuttons, etc.

Troubleshooting

If you encounter ground loop problems, see Appendix E "Best Grounding Practice" on page 103.

Special accessories

To comply with part 15 of the FCC Rules, any special accessories (that is, items that cannot be readily obtained from multiple retail outlets) supplied with this equipment must be used with this equipment; do not use any alternatives as they may not fulfil the RF requirement.

Optional equipment

Unless advised otherwise, optional equipment must only be installed by service personnel and in accordance with the appropriate assembly and usage regulations.

Equipment disposal

When this equipment has come to the end of its useful life, its disposal may come under the DIRECTIVE 2002/96/EC OF THE EUROPEAN PARLIAMENT AND OF THE COUNCIL of 27 January 2003 on waste electrical and electronic equipment (WEEE).

Hazardous substances in WEEE contaminate water, soil and air and ultimately put at risk our environment and health. The directive aims to minimize the impacts of WEEE on the environment during their life times and when they become waste.

The WEEE directive addresses the disposal of products when they have reached the end of their life and contributes to the reduction of wasteful consumption of natural resources. This will help to reduce pollution, and protect the environment and ourselves.



If this equipment carries a 'crossed-out wheellie bin' (shown left), please do not dispose of WEEE as unsorted municipal waste but collect and dispose of in accordance with local WEEE legislation. The horizontal bar underneath indicates that the product was placed on the EU market after 13th August 2005.

For WEEE disposal; see our website at www.midasconsoles.com for information.

FEDERAL COMMUNICATIONS COMMISSION COMPLIANCE INFORMATION



Responsible party name: MUSIC Group Research UK Limited
Address: Klark Industrial Park, Walter Nash Road, Kidderminster. Worcestershire. DY11 7HJ. England.
Phone/Fax No: Phone: +44 1562 741515
Fax: +44 1562 745371

VeniceF16/VeniceF16R/VeniceF24/VeniceF32

complies with the FCC rules as mentioned in the following paragraph:

This equipment has been tested and found to comply with the limits for a Class A digital device, pursuant to Part 15 of the FCC Rules. These limits are designed to provide reasonable protection against harmful interference when the equipment is operated in a commercial environment. This equipment generates, uses, and can radiate radio frequency energy and, if not installed and used in accordance with the instruction manual, may cause harmful interference to radio communications. Operation of this equipment in a residential area is likely to cause harmful interference in which case the user will be required to correct the interference at his own expense.

Important information:

Changes or modifications to the equipment not expressly approved by MUSIC Group can void the user's authority to use the equipment.

Thank you for reading through this Operator Manual.
We hope you found it useful.

Please feel free to send us your comments. Our
contact details and website address can be found at
the front of this document.



MUSIC Group Research UK Limited
Klark Industrial Park, Walter Nash Road,
Kidderminster. Worcestershire. DY11 7HJ. England.
Tel: +44 1562 741515, Fax: +44 1562 745371
Email: mkt.info@music-group.com
Website: www.midasconsoles.com