

Operating Instructions <Operations and Settings>

HD Integrated Camera

Model No. **AW-HE120WP**
AW-HE120KP
AW-HE120WE
AW-HE120KE

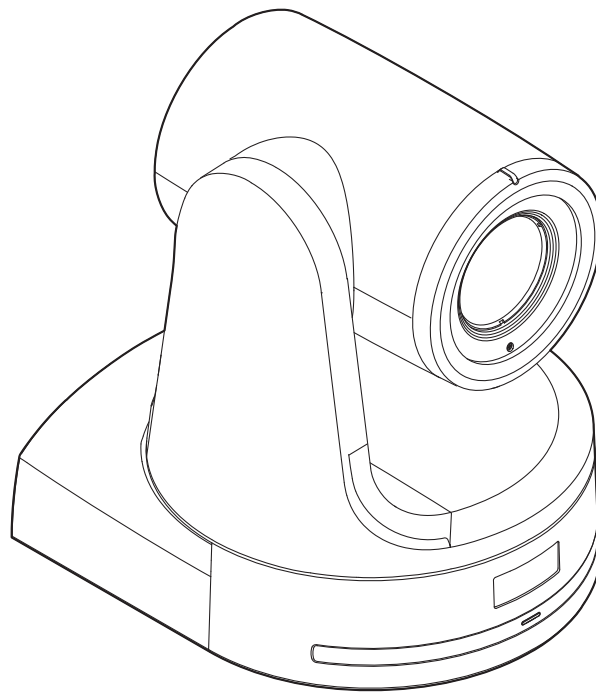

HDMI™
HIGH-DEFINITION MULTIMEDIA INTERFACE

- **How the Operating Instructions are configured**

<Basics>:

The <Basics> describes the procedure for basic operation and installation. Before installing this unit, be sure to take the time to read through <Basics> to ensure that the unit will be installed correctly.

<Operations and Settings> (this manual):

This <Operations and Settings> describes how to operate the unit and how to establish its settings.

Before use

Shooting

Adjustment

Basic operations

Camera menu

Web setting

Other settings

Reference

Trademarks and registered trademarks

- Microsoft, Windows, Windows Vista, Windows 7 and Internet Explorer are either registered trademarks or trademarks of Microsoft Corporation in the United States and other countries.
- Intel and Intel Core are trademarks or registered trademarks of Intel Corporation in the United States and other countries.
- Adobe and Reader are either registered trademarks or trademarks of Adobe Systems Incorporated in the United States and/or other countries.
- HDMI, the HDMI logo and High-Definition Multimedia Interface are the trademarks or registered trademarks of HDMI Licensing, LLC in the United States and other countries.
- Other names of companies and products contained in these Operating Instructions may be trademarks or registered trademarks of their respective owners.

About copyright and licence

Distributing, copying, disassembling, reverse compiling, reverse engineering, and also exporting in violation of export laws of the software provided with this unit are expressly prohibited.

Abbreviations

The following abbreviations are used in this manual.

- Microsoft® Windows® 7 Professional SP1 32/64-bit is abbreviated to “Windows 7”.
- Microsoft® Windows Vista® Business SP2 32-bit is abbreviated to “Windows Vista”.
- Microsoft® Windows® XP Professional SP3 and Microsoft® Windows® XP Home Edition SP3 are abbreviated to “Windows XP”.
- Windows® Internet Explorer® 8.0 and Windows® Internet Explorer® 9.0 are abbreviated to “Internet Explorer”.

For the purposes of this manual, the model numbers of the units are given as listed in the table below.

Model number of unit	Model number given in manual
AW-HE120WP	AW-HE120
AW-HE120KP	
AW-HE120WE	
AW-HE120KE	
AW-HS50N	AW-HS50
AW-HS50E	
AW-PS550N	AW-PS550
AW-PS550E	
AW-RP50N	AW-RP50
AW-RP50E	
AW-RP555N	AW-RP555
AW-RP555L	
AW-RP655N	AW-RP655
AW-RP655L	

Illustrations and screen displays featured in the manual

- What is shown in the manual's illustrations and screen displays may differ from how it is actually appears.

Contents

Before use	4	Setting the camera menu items	37
Overview	4	Setting the camera menu items	37
Required personal computer environment	4	Top Menu	37
Disclaimer of warranty	5	Camera screen	38
Network security	5	Brightness screen	38
Basic shooting operations	6	Picture 1/3 screen	40
How to turn the power on and off	7	Picture 2/3 screen	41
Turning the power on	7	Picture 3/3 screen	42
Turning the power off	8	Matrix 1/4 screen	42
Selecting the units	9	Matrix 2/4 screen	43
Selecting the shooting modes (scene files)	9	Matrix 3/4 screen	43
Types of shooting modes	9	Matrix 4/4 screen	44
How to select the shooting mode	10	System screen	45
Shooting	12	Genlock screen	45
What to do when encountering problems in the basic shooting operations	13	Output screen	46
More advanced operations	14	Other 1/3 screen	48
Manual shooting	15	Other 2/3 screen	49
Manually adjusting the focus	15	Other 3/3 screen	50
Manually adjusting the iris.....	16	Maintenance screen.....	51
Manually adjusting the shutter speed	17	Firmware VER 1/2 screen	51
Manually adjusting the gain	18	Firmware VER 2/2 screen	51
Preset memories	19	IP Network screen.....	52
White balance adjustment	22	Camera menu item table	53
White balance adjustment.....	22	Web setting screen	55
Black balance adjustment	25	Menu operations	56
Black balance adjustment	25	Control screen.....	59
Black level (master pedestal) adjustment	26	Setup screen.....	61
Black level (master pedestal) adjustment.....	26	System log displays	85
Genlock adjustment	28	Limiters	86
Genlock adjustment	28	Setting/releasing the limiters	87
Basic operations	29	Basic limiter operations.....	87
When performing the operations using the wireless remote control	31	Setting the limiters	87
Control exercised from the Multi-Function Controller AW-RP655	32	Releasing the limiters.....	88
Control exercised from the Multi Hybrid Control Panel AW-RP555	34	Resetting the limiters	88
Control exercised from the Remote Camera Controller AW-RP50	36	Safe mode	89
		Concerning the safe mode.....	89
		Detection of equipment trouble	89
		Cooling fan	89
		Notes on Windows Vista® / Windows® 7	90
		Index	96

Before use

■ Overview

- This unit is a full HD camera integrated with a pan-tilt head and featuring a newly developed 1/3-type full HD 3MOS sensor and digital signal processor (DSP).
- In addition to the optical 20× zoom lens, the unit comes with a 10× digital zoom to achieve vibrant high-quality images that have a horizontal resolution of 1000 lines.
- By connecting a controller, the camera operations can be performed smoothly by IP control or serial control.
- By connecting the unit to a personal computer through an IP network, it is possible to operate the unit from the Web browser screen.
- There is a choice of color — white in the case of the AW-HE120W or black in the case of the AW-HE120K — to suit the intended application and environment.

■ Required personal computer environment

CPU	Intel® Core™2 DUO 2.4 GHz or faster recommended
Memory	512 MB or more (When using Microsoft® Windows Vista®: 1 GB or more, and when using Microsoft® Windows® 7: 1 GB [32 bits] or 2 GB [64 bits] or more)
Network function	10Base-T or 100Base-TX port × 1
Image display function	Resolution: 1024 × 768 pixels or more Color generation: True Color 24 bits or more
Supported operating system and Web browser	Microsoft® Windows® 7 Professional SP1 64-bit*1 Microsoft® Windows® 7 Professional SP1 32-bit*1 Windows® Internet Explorer® 8.0*2 Windows® Internet Explorer® 9.0*2
	Microsoft® Windows Vista® Business SP2 32-bit Windows® Internet Explorer® 7.0
	Microsoft® Windows® XP Home Edition SP3*3 Microsoft® Windows® XP Professional Edition SP3*3 Microsoft® Internet Explorer® 6.0 SP3
	*1: This cannot be used in the Windows® XP compatibility mode. *2: This cannot be used with the 64-bit version of Internet Explorer® 8.0. *3: The Microsoft® Windows® XP Professional x64 Edition is not supported.
Other	CD-ROM drive (for using the Operating Instructions and various software) Adobe® Reader® (for browsing the Operating Instructions on the CD-ROM)

IMPORTANT

- **Failure to provide the required personal computer environment may slow down the delineation of the images on the screen, make it impossible for the web browser to work and cause other kinds of problems.**

Memo

- When using Microsoft® Windows Vista® or Microsoft® Windows® 7, refer to the “Notes on Windows Vista® / Windows® 7” (page 90) for details on the personal computer environment that is required and on the precautions and other items.

■ Disclaimer of warranty

IN NO EVENT SHALL Panasonic Corporation BE LIABLE TO ANY PARTY OR ANY PERSON, EXCEPT FOR REPLACEMENT OR REASONABLE MAINTENANCE OF THE PRODUCT, FOR THE CASES, INCLUDING BUT NOT LIMITED TO BELOW:

- ① ANY DAMAGE AND LOSS, INCLUDING WITHOUT LIMITATION, DIRECT OR INDIRECT, SPECIAL, CONSEQUENTIAL OR EXEMPLARY, ARISING OUT OF OR RELATING TO THE PRODUCT;
- ② PERSONAL INJURY OR ANY DAMAGE CAUSED BY INAPPROPRIATE USE OR NEGLIGENT OPERATION OF THE USER;
- ③ UNAUTHORIZED DISASSEMBLE, REPAIR OR MODIFICATION OF THE PRODUCT BY THE USER;
- ④ INCONVENIENCE OR ANY LOSS ARISING WHEN IMAGES ARE NOT DISPLAYED, DUE TO ANY REASON OR CAUSE INCLUDING ANY FAILURE OR PROBLEM OF THE PRODUCT;
- ⑤ ANY PROBLEM, CONSEQUENTIAL INCONVENIENCE, OR LOSS OR DAMAGE, ARISING OUT OF THE SYSTEM COMBINED BY THE DEVICES OF THIRD PARTY;
- ⑥ LOSS OF REGISTERED DATA CAUSED BY ANY FAILURE.

■ Network security

As you will use this unit connected to a network, your attention is called to the following security risks.

- ① Leakage or theft of information through this unit
- ② Use of this unit for illegal operations by persons with malicious intent
- ③ Interference with or stoppage of this unit by persons with malicious intent

It is your responsibility to take precautions such as those described below to protect yourself against the above network security risks.

- Use this unit in a network secured by a firewall, etc.
- If this unit is connected to a network that includes PCs, make sure that the system is not infected by computer viruses or other malicious entities (using a regularly updated antivirus program, anti-spyware program, etc.).
- Protect your network against unauthorized access by restricting users to those who log in with an authorized user name and password.
- Take measures by authenticating the users of the unit in order to restrict access, for example, so that the setting information contained inside the unit is not leaked over the network.
- Do not install the camera in locations where the camera or the cables can be destroyed or damaged by persons with malicious intent.
- Refrain from connections that use public lines.

Memo

Usage restrictions

Use of the same segment is recommended for the network in which the unit and the controller or personal computer are connected.

If the equipment uses connections with different segments, events based on the settings inherent to the network equipment, for instance, may occur so check this thoroughly prior to operation.

Basic shooting operations

1 Set the subject brightness to the appropriate level.

2 Turn on the power of all the units and devices in the system.

3 Select the unit to be operated.

Even when using only one unit, it must still be selected from the wireless remote control or controller.

4 Select the shooting mode.

One of four shooting modes (Scene1, Scene2, Scene3 or Scene4) — whichever one will best suit the shooting conditions — can be selected.

The shooting modes are set by the user.

For details of the factory settings, refer to pages 53 to 54.

Select the mode that satisfies the shooting conditions and suits your preferences.

When continuing to shoot in the same circumstances, there is no need to select another mode.

**5 Start shooting.
(After shooting, turn off the power of all the units and devices in the system.)**

If the settings have already been changed and the original settings are to be restored, refer to the “What to do when encountering problems in the basic shooting operations” (page 13) and “Camera screen” (page 38) in “Setting the camera menu items”.

Note

- Some of the initial settings are auto settings and cannot be operated manually. To perform manual operations for these settings, switch the auto settings to manual settings as necessary.

How to turn the power on and off

■ Turning the power on

When performing the operations using the wireless remote control

- 1 Set all the power switches of the units and devices connected in the system to ON.**
 - This unit does not have a power switch. When power is supplied to it, the status display lamp will light up orange, and the unit is set to the standby mode.
- 2 Press one of the [CAM1] to [CAM4] buttons on the wireless remote control to select the unit.**
- 3 Press the [ON/STANDBY] button on the wireless remote control for 2 seconds.**

The POWER ON mode is established, images are output, and control can be exercised.

 - The unit's status display lamp now lights up green.

Notes

- It takes maximum 30 seconds per unit for the initial settings operation to be completed. During this period, the unit cannot be operated. (Status display lamp: light up orange)
- When operation is transferred to the STANDBY mode: The current zoom, focus and iris positions are stored in the memory (POWER ON preset).
- When operation is transferred to the POWER ON mode: The zoom, focus and iris are adjusted to the positions which were stored in the memory (POWER ON preset) when operation was transferred to the STANDBY mode.

- 4 If a multiple number of units are going to be used, repeat steps 2 and 3 as required.**

The unit's status display lamp blinks green when a signal matched by the remote control ID has been received, and it blinks orange when a signal that is not matched by the remote control ID has been received.

When performing the operations using the controller

- When the AW-RP655 or AW-RP555 is connected:
- 1 Set all the power switches of the units and devices connected in the system to ON.**
 - This unit does not have a power switch. When power is supplied to it, the status display lamp will light up orange, and the unit is set to the standby mode.
 - 2 Set the [OPERATE] switch on the controller to ON.**

The POWER ON mode is established, images are output, and control can be exercised.

 - The unit's status display lamp now lights up green.

Notes

- It takes maximum 30 seconds per unit for the initial settings operation to be completed. During this period, the unit cannot be operated. (Status display lamp: light up orange)
- When operation is transferred to the STANDBY mode: The current zoom, focus and iris positions are stored in the memory (POWER ON preset).
- When operation is transferred to the POWER ON mode: The zoom, focus and iris are adjusted to the positions which were stored in the memory (POWER ON preset) when operation was transferred to the STANDBY mode.

Before setting the [OPERATE] switch on the controller to ON, be absolutely sure to set all the power switches of the units and devices connected in the system to ON.

For further details, refer to the Operating Instructions of the controller.

When the AW-RP50 is connected:

Refer to the Operating Instructions of the controller.

How to turn the power on and off (continued)

■ Turning the power off

When performing the operations using the wireless remote control

- 1 Press one of the [CAM1] to [CAM4] buttons on the wireless remote control to select the unit.**
- 2 Press the [ON/STANDBY] button on the wireless remote control for 2 seconds.**

The unit is set to the standby mode.

 - The unit's status display lamp now lights up orange.
- 3 If a multiple number of units are going to be used, repeat steps 1 and 2 as required.**
- 4 Set all the power switches of the units and devices connected in the system to OFF.**
 - This unit does not have a power switch.

Notes

- When operation is transferred to the STANDBY mode: The current zoom, focus and iris positions are stored in the memory (POWER ON preset).
- When operation is transferred to the POWER ON mode: The zoom, focus and iris are adjusted to the positions which were stored in the memory (POWER ON preset) when operation was transferred to the STANDBY mode.

When performing the operations using the controller

■ When the AW-RP655 or AW-RP555 is connected:

- 1 Set the [OPERATE] switch on the controller to OFF.**

All the cameras (including the unit) connected to the controller are set to the standby mode.

 - The unit's status display lamp now lights up orange.
- 2 Set all the power switches of the units and devices connected in the system to OFF.**
 - This unit does not have a power switch.

Notes

- When operation is transferred to the STANDBY mode: The current zoom, focus and iris positions are stored in the memory (POWER ON preset).
- When operation is transferred to the POWER ON mode: The zoom, focus and iris are adjusted to the positions which were stored in the memory (POWER ON preset) when operation was transferred to the STANDBY mode.

For further details, refer to the Operating Instructions of the controller.

■ When the AW-RP50 is connected:

Refer to the Operating Instructions of the controller.

Selecting the units

Up to four units can be operated using one wireless remote control.

Up to five units and devices can be operated using one controller.

Select the unit (or units) to be operated from the wireless remote control or controller.

Even when using only one unit, it must still be selected.

When performing the operations using the wireless remote control

To select the unit using the wireless remote control, the IR ID switches on the unit's back panel must be set.

For details of the IR ID switch settings, refer to pages 36 and 39 in the <Basics>.

1 Press the [CAM1], [CAM2], [CAM3] or [CAM4] button.

The unit's status display lamp blinks green when a signal matched by the remote control ID has been received, and it blinks orange when a signal that is not matched by the remote control ID has been received.

When performing the operations using the controller

When the AW-RP655 is connected:

1 Press the [1], [2], [3], [4] or [5] button of [CONTROL/PREVIEW MONITOR OUT SEL].

When the AW-RP555 is connected:

1 Press the [1], [2], [3], [4] or [5] button of [CONTROL].

When the AW-RP50 is connected:

Refer to the Operating Instructions of the controller.

Selecting the shooting modes (scene files)

■ Types of shooting modes

One of four shooting modes (Scene1, Scene2, Scene3 or Scene4) — whichever one will best suit the shooting conditions — can be selected.

The shooting modes are set by the user.

For details of the factory settings, refer to pages 53 to 54.

Select the mode that satisfies the shooting conditions and suits your preferences.

The settings can be changed by menu operations.

- The results of the white balance and other adjustments are stored in the memory separately by shooting mode. Be absolutely sure to select the shooting mode before making any adjustments.

Note

- Some of the initial settings are auto settings and cannot be operated manually. To perform manual operations for these settings, switch the auto settings to manual settings as necessary.

Scene1 Scene2 Scene3 Scene4

The settings of your preferences can be established in line with the shooting scene, lighting and other conditions.

Selecting the shooting modes (scene files) (continued)

■ How to select the shooting mode

When performing the operations using the wireless remote control

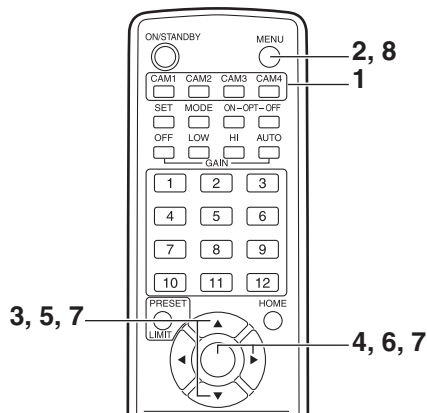

1 Press the [CAM1], [CAM2], [CAM3] or [CAM4] button to select the unit.

2 Press the [MENU] button for 2 seconds.
The Top Menu is displayed.

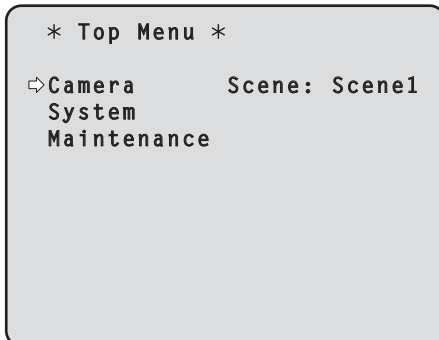

3 Press the [▲] or [▼] button to bring the cursor to "Camera".

4 Press the [○] button.

The "Camera" sub-menu is displayed on the monitor.

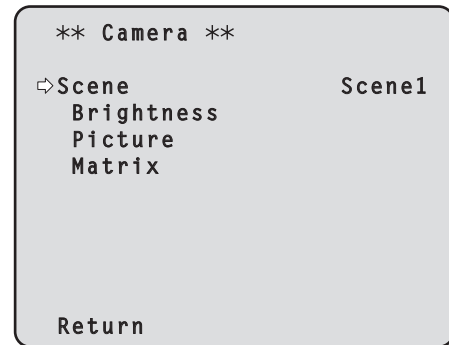

5 Press the [▲] or [▼] button to bring the cursor to "Scene".

6 Press the [○] button.
The shooting mode blinks.

7 Press the [▲] or [▼] button to select the shooting mode (Scene1, Scene2, Scene3 or Scene4) to be used, and press the [○] button to enter the selection.

8 Press the [MENU] button for 2 seconds.
The camera menu display is exited.

Selecting the shooting modes (scene files) (continued)

When performing the operations using the controller

When the AW-RP655 is connected:

- 1 Press one of the [1] to [5] buttons of [CONTROL/PREVIEW MONITOR OUT SEL] to select the unit which is to be operated.
- 2 Press the [MENU] button to set the LCD panel display to the menu mode.
- 3 Turn the jog dial (main) until CAMERA SETTING appears, and press the [OK] button.

CAMERA SETTING
→ OK Key

- 4 When the scene selection menu has appeared on the LCD panel, select the scene to be set, and press the [OK] button.

SCENE HALOGEN
→ OK Key

The scene names displayed on the LCD panel correlate with the scene files of the AW-HE120 as shown below.

AW-RP655 display	AW-HE120 scene file
HALOGEN	Scene1
FLUORESCENT	Scene2
OUTDOOR	Scene3
USER	Scene4

- 5 When the following message appears on the LCD panel, press the [MENU] button twice to exit the menu mode.

OPEN CAMERA MENU ?
→ OK Key

When the AW-RP555 is connected:

- 1 Press the [1], [2], [3], [4] or [5] button of [CONTROL] to select the unit.
- 2 Press the [1], [2], [3] or [USER] button of [SCENE FILE] to select the shooting mode.

Shooting mode	[SCENE FILE] button
Scene1	[1]
Scene2	[2]
Scene3	[3]
Scene4	[USER]

When the AW-RP50 is connected:

Refer to the Operating Instructions of the controller.

Shooting

When performing the operations using the wireless remote control

● Changing the camera's direction

Moving the camera toward the left or right (panning):
Press the [◀] or [▶] button.

Moving the camera up or down (tilting):
Press the [▲] or [▼] button.

Moving the camera diagonally:
Press the [▲] or [▼] button and [◀] or [▶] button at the same time.

Returning the camera to the reference position:
Press the [HOME] button for 2 seconds.

● Using the zoom function

Zooming in (the subject becomes magnified in size):
Press the [T] button of [ZOOM].

Zooming out (the subject becomes reduced in size):
Press the [W] button of [ZOOM].

● Switching the panning/tilting and lens operation speed

Changing the direction or zoom at high speed:
Press the [FAST] button.

Changing the direction or zoom at low speed:
Press the [SLOW] button.

The speeds at which the pan, tilt, zoom focus and iris are controlled are now switched.

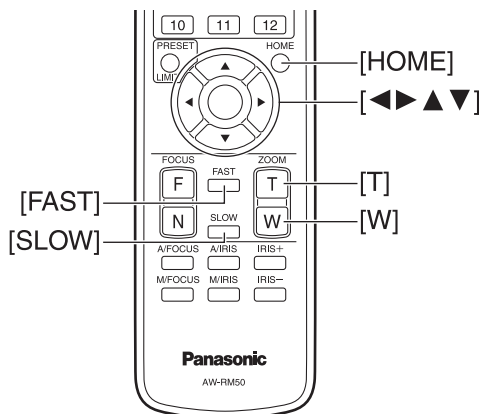

When performing the operations using the controller

● Changing the camera's direction

Moving the camera toward the left or right (panning):
Tilt the [PAN/TILT] lever toward L or R.

Moving the camera up or down (tilting):
Tilt the [PAN/TILT] lever toward UP or DOWN.

Moving the camera diagonally:
Tilt the [PAN/TILT] lever diagonally.

Returning the camera to the reference position:
If the controller has a [HOME] button, press the [HOME] button.

● Using the zoom function

Zooming in (the subject becomes magnified in size):
Tilt the [ZOOM] lever toward the TELE direction.

Zooming out (the subject becomes reduced in size):
Tilt the [ZOOM] lever toward the WIDE direction.

Note

- The indicator displays of the AW-RP655 are indicators that show the positions of the optical zoom. They will not work for electronic zooming.

● Switching the panning/tilting and lens operation speed

AW-RP655 and AW-RP555

1 Press the [SPEED] button.

Each time the [SPEED] button is pressed, the control speed is switched between the high speed (the button's lamp is off) and low speed (the button's lamp is lit).

The speeds at which the pan, tilt, zoom focus and iris are controlled are now switched.

AW-RP50

Refer to the Operating Instructions of the controller.

What to do when encountering problems in the basic shooting operations

If the trouble is not resolved by taking the action suggested below, refer to “Troubleshooting” (page 42 in the <Basics>).

When performing the operations using the wireless remote control

The unit does not move.

- Press the [CAM1], [CAM2], [CAM3] or [CAM4] button to select the unit which is to be operated.
If only one unit is being used, it is normally selected using the [CAM1] button.
- Check that the IR ID switches have been set correctly. (Refer to pages 36 and 39 in the <Basics>.)
- If the unit’s status display lamp is off or lights up orange, it means that the unit’s power is not on.
Refer to “Turning the power on” (page 7), and turn on the power.
- If the unit’s status display lamp does not blink even when the wireless remote control is operated near the unit’s wireless remote control signal light-sensing area, it means that the wireless remote control’s batteries have run down. Replace the batteries.

Multiple color bands (color bars) are displayed.

Press the [MODE] button to switch to the camera picture.

The menu screen is displayed.

Press the [MENU] button for 2 seconds to exit the camera menu.

The lens focus is not adjusted automatically.

Press the [A/FOCUS] button to switch to auto focusing.

The camera picture is too light or too dark.

1. Press the [A/IRIS] button to switch automatically to the lens iris adjustment.
2. Press the [AUTO] button of [GAIN] to switch automatically to the gain adjustment.

Something is wrong with the coloring of the camera pictures.

Refer to “Auto tracking white adjustment (ATW)” (page 24), and switch to “ATW”.

The camera menus are not displayed.

If any of the camera menus are displayed within less than a minute after the camera was restarted, the menus will be displayed in all the outputs.
Check “OSD Mix” (page 50) on the camera menu Other 3/3 screen.

When performing the operations using the controller

The unit does not move.

- Select the unit to be operated by following the procedure below.

When the AW-RP655 is connected:

Press the [1], [2], [3], [4] or [5] button of [CONTROL/ PREVIEW MONITOR OUT SEL].

When the AW-RP555 is connected:

Press the [1], [2], [3], [4] or [5] button of [CONTROL].

When the AW-RP50 is connected:

Refer to the Operating Instructions of the controller.

- If the [OPERATE] lamp on the controller is off, it means that the power of the controller is not on.
- If the unit’s status display lamp is off or lights up orange, it means that the unit’s power is not on.
Refer to “Turning the power on” (page 7), and turn on the power.

Multiple color bands (color bars) are displayed.

Press the [MODE] button to switch to the camera picture.

The menu screen is displayed.

Press the [MENU] button to exit the camera menu.

The lens focus is not adjusted automatically.

Press the [EXT(AF)] button to switch to auto focusing.

The camera picture is too light or too dark.

1. Press the [IRIS] button several times to turn on its lamp, and switch the lens iris adjustment to auto.
2. Press the [GAIN] button several times to turn on its lamp, and switch the gain adjustment to auto.

Something is wrong with the coloring of the camera pictures.

Refer to “Auto tracking white adjustment (ATW)” (page 24), and switch to “ATW”.

The camera menus are not displayed.

If any of the camera menus are displayed within less than a minute after the camera was restarted, the menus will be displayed in all the outputs.
Check “OSD Mix” (page 50) on the camera menu Other 3/3 screen.

More advanced operations

Manual shooting (see pages 15 to 18)

- Manual adjustment of focus
- Manual adjustment of iris
- Manual adjustment of shutter speed
- Manual adjustment of gain

Preset memories (see pages 19 to 21)

- Up to 100 settings for the camera direction (panning and tilting), zoom, focus, iris, gain up and white balance can be registered in the preset memories, and called.
- The number of settings that can be registered and called depends on the type of wireless remote control (12 settings) or controller that is used for operation.

White balance adjustment (see pages 22 to 24)

- This adjustment is performed to express the white accurately. Its setting also has an effect on the color tones of the entire screen.
- It must be performed when using the unit for the first time or when the unit has not been used for a prolonged period.
- It must be performed when the lighting conditions or brightness has changed.
- Once the white balance has been attained, no further adjustment is required provided that the unit is going to be used under the same conditions.

Black balance adjustment (see page 25)

- This adjustment is performed to express the black accurately. Its setting also has an effect on the color tones of the entire screen.
- It must be performed when using the unit for the first time or when the unit has not been used for a prolonged period.
- It must be performed when the ambient temperature has changed significantly and at the change of the seasons.
- Once the black balance has been attained, no further adjustment is required provided that the unit is going to be used under the same conditions.

Black level (master pedestal) adjustment (see pages 26 to 27)

- This adjustment is performed to align the black level (pedestal level) of a multiple number of cameras.
- Ask your dealer to perform this adjustment.

Genlock adjustment (see page 28)

- This adjustment is performed to achieve phase alignment by applying external synchronization (genlock) when a multiple number of cameras will be used or when the unit will be used in combination with other devices.
- Ask your dealer to perform this adjustment.

Manual shooting

■ Manually adjusting the focus

The lens focus can be adjusted manually.

When performing the operations using the wireless remote control

- 1 Press the [M/FOCUS] button to switch the focus to manual adjustment.**
- 2 Press the [F] or [N] button of [FOCUS], and adjust the focus.**

When the [F] button is pressed, the focus moves further away (far); conversely, when the [N] button is pressed, it moves nearer (near).
The speed of focusing and other adjustments can be switched to fast or slow by pressing the [FAST] or [SLOW] button, respectively.
- 3 If necessary, press the [A/FOCUS] button to return the focus to the automatic adjustment.**

When performing the operations using the controller

- When the AW-RP655 is connected:
- 1 Press the [EXT(AF)] button to switch the focus to manual adjustment.**
 - 2 Adjust the focus manually by turning the dial above the lit [FOCUS] lamp whether it is the lamp of the [PAN/TILT] lever or [ZOOM] lever.**

Furthermore, every time the [SPEED] button is pressed, the speed of the focusing and other adjustments can be switched to fast or slow.
 - 3 If necessary, press the [EXT(AF)] button to return the focus to the automatic adjustment.**

■ When the AW-RP555 is connected:

- 1 Press the [EXT(AF)] button to switch the focus to manual adjustment.**
- 2 Adjust the focus manually by tilting the [FOCUS] lever.**

Furthermore, every time the [SPEED] button is pressed, the speed of the focusing and other adjustments can be switched to fast or slow.
- 3 If necessary, press the [EXT(AF)] button to return the focus to the automatic adjustment.**

■ When the AW-RP50 is connected:

Refer to the Operating Instructions of the controller.

Note

- When the focus is set to manual, the subject may go out of focus during panning, tilting and zooming. Therefore, the unit comes with a function which compensates for this. (Focus compensation during zooming function: Focus ADJ With PTZ.) This function was set to ON at the factory. If the function has been set to OFF, either adjust the focus, as required, after zooming or set the focus to auto. (See page 49 and page 73.)

Manual shooting (continued)

■ Manually adjusting the iris

The lens iris can be adjusted manually.

When performing the operations using the wireless remote control

- 1 Press the [M/IRIS] button to switch the iris to manual adjustment.**
- 2 Adjust the iris using the [IRIS +] or [IRIS -] button.**

Press the [IRIS +] button to adjust the lens iris in the opening direction; conversely, press the [IRIS -] button to adjust the lens iris in the closing direction. The speed of the iris and other adjustments can be switched to fast or slow by pressing the [FAST] or [SLOW] button, respectively.
- 3 If necessary, press the [A/IRIS] button to return the iris to the automatic adjustment.**

When performing the operations using the controller

■ When the AW-RP655 is connected:

- 1 Press the [IRIS] button several times to turn off the button's lamp and switch to manual adjustment.**
- 2 Adjust the iris manually by turning the dial above the lit [IRIS] lamp whether it is the lamp of the [PAN/TILT] lever or [ZOOM] lever.**
- 3 If necessary, press the [IRIS] button several times and turn on its lamp to return the iris to the automatic adjustment.**

■ When the AW-RP555 is connected:

- 1 Press the [IRIS] button to turn off its lamp and switch to manual adjustment.**
- 2 Turn the [LEVEL] dial of [IRIS] to adjust the iris manually.**

The position of the [LEVEL] dial does not represent an absolute value. This is why the brightness may differ from one camera to another even when the dial is set to the same position.
- 3 If necessary, press the [IRIS] button to turn on its lamp and switch to automatic adjustment in order to return the iris to automatic adjustment.**

■ When the AW-RP50 is connected:

Refer to the Operating Instructions of the controller.

Manually adjusting the shutter speed

The shutter speed can be set using two methods. One is a method that specifies the time (where a time such as 1/250 sec. is designated), and the other is a method that specifies the frequency (where synchro scan, 60.17 Hz, etc. is designated).

When shooting a TV screen or PC monitor screen, the horizontal noise generated when the screen is shot can be minimized by adjusting the frequency to the screen frequency using synchro scan.

When performing the operations using the wireless remote control

Perform the adjustments on the Camera menu. For further details, refer to the [Shutter Mode] on page 38 and [Step/Synchro] items on page 39.

When performing the operations using the controller

The procedure is the same as for “When performing the operations using the wireless remote control” in “Basic operations” (pages 29 to 36).

When the AW-RP555 is connected:

- 1 Press the [SHUTTER] button and turn its lamp on.**
The shutter speed set ahead of time is selected.
- 2 If necessary, press the [SHUTTER] button and turn its lamp off in order to return the shutter to the OFF setting.**

● **How to set the shutter speed using the AW-RP555**

- 1 With the [MEMORY] button still held down, press the [SHUTTER] button.**

The [PRESET] [1] to [5] and [6] to [10] buttons blink alternately.

- 2 Press one of the [1] to [8] buttons or the [10] [PRESET] button — whichever button corresponds to the shutter speed which is to be set.**

Any of the shutter speeds in the table below can be set.

[When 59.94 Hz has been set as the unit’s frequency]

OFF	1/59.94	[6]	1/4000
[1]	1/100	[7]	1/10000
[2]	1/250	[8]	Synchro Scan
[3]	1/500	[9]	ELC
[4]	1/1000	[10]	OFF
[5]	1/2000		

[When 50 Hz has been set as the unit’s frequency]

OFF	1/50	[6]	1/4000
[1]	1/120	[7]	1/10000
[2]	1/250	[8]	Synchro Scan
[3]	1/500	[9]	ELC
[4]	1/1000	[10]	OFF
[5]	1/2000		

- Any change in the shutter speed is reflected the next time the [SHUTTER] button is pressed and its lamp is turned on.
- When OFF is selected, the shutter will not operate even when the [SHUTTER] button is pressed.
- Select the synchro scan setting on the menu.
- The shutter speed setting performed here is stored in the memory even when the power of the AW-RP555 is turned off.

For further details, refer to the Operating Instructions of the AW-RP555.

Manual shooting (continued)

Manually adjusting the gain

There are two ways to adjust the gain. One way involves using the buttons on the wireless remote control or controller; the other way involves using the Camera menu or Web setting.

The gain can be adjusted more precisely using the Camera menu or Web setting.

For further details, refer to the [Gain] item on page 39 and page 64.

Note

- When adjusting the gain, the light quantity may change suddenly (causing the image output to be subjected to a shock).

When performing the operations using the wireless remote control

1 Press the [OFF], [LOW] or [HI] button.

These buttons enable the gain increase to be selected in three steps.

[LOW] is used to select 9 dB; [HI] is used to select 18 dB.

2 If necessary, press the [AUTO] button in order to return the gain to the automatic adjustment (AGC).

When performing the operations using the controller

When the AW-RP655 is connected:

1 Press the [GAIN] button to turn off its lamp, and then switch to manual adjustment.

The preset gain increase amount is now selected. For further details on the gain increase amount setting, refer to the Operating Instructions of the AW-RP655.

2 If necessary, press the [GAIN] button and turn on its lamp in order to return the gain to the automatic adjustment (AGC).

When the AW-RP555 is connected:

1 Press the [GAIN] button to turn off its lamp.

Each time this button is pressed, one of the three gain increase amounts can be selected in sequence.

The current status is displayed as follows.

	[MANU] [L] lamp	[MANU] [H] lamp	[GAIN] button
0 dB	Off	Off	Off
LOW	Lit	Off	Off
HIGH	Off	Lit	Off
AUTO	Off	Off	Lit
Other	Lit	Lit	Off

2 If necessary, press the [GAIN] button several times and turn on its lamp in order to return the gain to the automatic adjustment (AGC).

When the AW-RP50 is connected:

Refer to the Operating Instructions of the controller.

In any case, the maximum gain of the automatic adjustment can be set by the camera menu or Web setting. For further details, refer to the [AGC Max Gain] item on page 39 and page 64.

Preset memories

This unit enables up to 100 settings for the camera direction (panning and tilting), zoom, focus, iris, gain and white balance to be registered in its preset memories, and called. However, the number of settings that can be registered and called depends on the type of wireless remote control or controller that is used for operation.

- The focus and iris operating modes (manual and auto settings) are neither registered nor recalled. The current focus and iris values are registered.
- The focus and iris values can be recalled only when the manual settings are applicable.
- For the white balance, the current White Balance Mode adjustment values are registered. If a preset value is recalled when AWB A or AWB B is selected, the adjustment value selected when it was registered as a preset will be recalled.
- The White Balance Mode (ATW, AWB A or AWB B) stored using the AW-RP655 are recalled only when the AW-RP655 is connected.

Notes

- When there is a large difference in the environmental temperature between the time of registration and the time the setting is called, displacement of the preset position may occur.
- If displacement occurs, perform registration again.
- When a manual operation is performed for pan, tilt, zoom, focus or iris during preset recall, the preset operation for the pan, tilt, zoom, focus or iris operation concerned will be aborted.
- If another preset has been recalled during an ongoing preset recall, the preset being recalled is aborted, and operation for the preset called last is performed instead.

When performing the operations using the wireless remote control

Twelve settings (preset No.1 to No.12) can be registered and called using the wireless remote control. The [1] to [12] buttons correspond to the unit's preset memories No.1 to No.12.

● Registering the settings in the preset memories

1 Display the picture to be shot on the monitor.

Operate the pan, tilt or zoom buttons to determine the camera angle.

Adjust the focus, iris, gain and white balance if they need to be adjusted.

2 While holding down the [PRESET] button, press the button corresponding to the preset memory number.

- If a preset memory number with an already registered setting has been selected, the existing setting will be erased and replaced with the new one.

● Calling the settings of the preset memories

1 Press the button in which the preset memory setting has been registered.

Preset memories (continued)

When performing the operations using the controller

When the AW-RP655 is connected:

Up to 50 settings can be registered and called.
The [1] to [50] buttons of [TRACING/PRESET MEMORY] correspond to the unit's preset memories No.1 to No.50.

● Registering the settings in the preset memories

1 Set to the preset memory mode.

Press the [TR/PSET] button to turn off its lamp.

2 Set to the memory recording mode.

Press the [M.LOCK] button to turn off its lamp.

3 Display the picture to be shot on the monitor.

Operate the [PAN/TILT] lever and [ZOOM] lever to determine the camera angle.
Adjust the focus, iris, gain and white balance if they need to be adjusted.

4 Hold down the [MEMORY] button.

The buttons among the [1] to [50] buttons of [TRACING/PRESET MEMORY] in which settings can be registered now start blinking in sequence.

- Preset memory settings cannot be registered in buttons whose lamps are off (since they contain tracing memory settings).

5 With the [MEMORY] button still held down, press the button of the preset memory number in which the setting is to be registered.

● Calling the settings of the preset memories

1 Set to the preset memory mode.

Press the [TR/PSET] button to turn off its lamp.

2 Press the button among the [1] to [50] buttons of [TRACING/PRESET MEMORY] in which the desired setting was registered.

● Erasing preset memory settings

1 Set to the preset memory mode.

Press the [TR/PSET] button to turn off its lamp.

2 Set the memory recording mode.

Press the [M.LOCK] button to turn off its lamp.

3 Hold down the [RESET] button.

The buttons among the [1] to [50] buttons of [TRACING/PRESET MEMORY] whose settings can be erased now start blinking in sequence.

- The settings for the buttons whose lamps are off cannot be erased (since they contain tracing memory settings).

4 With the [RESET] button still held down, press the button of the preset memory number whose setting is to be erased.

Preset memories (continued)

When the AW-RP555 is connected:

Up to 10 settings can be registered and called.
The [1] to [10] buttons of [PRESET] correspond to the unit's preset memories No.1 to No.10.

● Registering the settings in the preset memories

1 Display the picture to be shot on the monitor.

Operate the [PAN/TILT] lever and [ZOOM] lever to determine the camera angle.
Adjust the focus, iris, gain and white balance if they need to be adjusted.

2 Hold down the [MEMORY] button.

The buttons among the [1] to [10] buttons of [PRESET] in which settings can be registered now start blinking in sequence.

3 With the [MEMORY] button still held down, press the button of the preset memory number in which the setting is to be registered.

● Calling the settings of the preset memories

1 Press the button among the [1] to [10] buttons of [PRESET] in which the desired setting was registered.

● Erasing preset memory settings

1 While holding down the [MEMORY] button, press the [OP] button.

The [OP] button lamp blinks, and the standby status is established.

2 Press the [OP] button to establish the setting mode.

The [PRESET] [1] to [10] button lamps blink in sequence.
When the [ZOOM] lever, [PAN/TILT] lever or [FOCUS] lever is now operated, the mode is forcibly exited.

3 Press the [PRESET] button corresponding to the preset memory which is to be deleted.

When the AW-RP50 is connected:

Up to 100 settings can be registered and called.
For details, refer to the Operating Instructions of the controller.

White balance adjustment

■ White balance adjustment

In order for the white to be reproduced accurately, the ratio between the three primary colors (RGB) is adjusted. If the white balance has shifted out of adjustment, not only will the white be reproduced poorly but the color tones of the entire screen will also be degraded.

- **This adjustment must be performed when using the unit for the first time or when the unit has not been used for a prolonged period.**
- **It must be performed when the lighting conditions or brightness has changed.**

Either AWB (automatic white balance adjustment) which initiates automatic adjustment when the AWB button on the controller has been pressed or ATW (automatic tracking white balance adjustment) which constantly adjusts the white balance can be selected for adjustment purposes.

The results of the AWB adjustment can be stored in two memories, A and B, when “AWB A” or “AWB B” has been selected for the white balance.

- Once the white balance values have been adjusted, their setup procedure will be completed simply by selecting them using the camera menus or web settings, or by pressing the buttons on the controller, provided that they are going to be used under the same conditions as the ones established when the values were set. There is no need to set it again.
- Once a new setting is entered, the previous setting will be erased.

Use the two memories to store settings corresponding to different shooting conditions.

● Automatic adjustment (AWB: AWB A or AWB B)

When performing the operations using the wireless remote control

- 1 Shoot a white subject (such as a white wall or handkerchief) so that it fills the screen.**
 - Do not shoot shiny or very bright objects.
- Steps **2** through **8** represent the procedure for selecting the “AWB A” or “AWB B” memory. They need not be taken if a selection has already been made.

- 2 Select Scene1, Scene2, Scene3 or Scene4 as the shooting mode by following the procedure in “Selecting the shooting modes (scene files)” (page 10).**

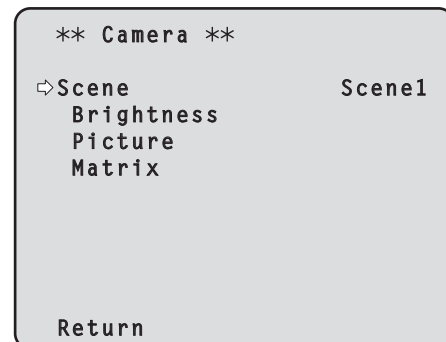

- 3 Press the [▲] or [▼] button to bring the cursor to “Picture”.**

- 4 Press the [○] button.**

The “Picture 1/3” sub-menu is displayed.

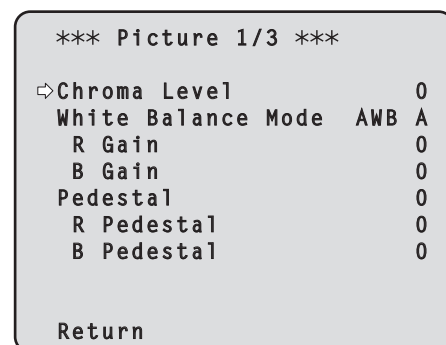

White balance adjustment (continued)

5 Press the [▲] or [▼] button to bring the cursor to “White Balance Mode”.

6 Press the [○] button.
“White Balance Mode” starts blinking.

7 Press the [▲] or [▼] button to change the White Balance Mode to be used to “AWB A” or “AWB B”, and press the [○] button to enter the selection.

8 Press the [MENU] button for 2 seconds.
The camera menu display is exited.

9 Press the [SET] button for 2 seconds.
The auto white balance adjustment (AWB) and auto black balance adjustment (ABB) are performed, and the white balance setting is entered.

- When “On” has been selected as the “OSD Status” (page 50) setting, the “AWB OK” message will appear at the center of the screen when the white balance adjustment is completed successfully.
When the black balance adjustment is completed successfully, the “ABB OK” message appears at the center of the screen.



Notes

- The black balance is set at the same time. When this takes place, the lens is closed and then the adjustment is performed so the screen will temporarily turn black.
When only the auto white balance adjustment (AWB) is to be performed, ensure that the [SET] button is pressed or held down for a period of time which does not exceed 2 seconds.
- The white balance cannot be adjusted when color bars are displayed. Press the [MODE] button to switch to the camera picture.
- When the adjustment has failed, an error message such as “OUT RANGE NG”, “HIGH LIGHT NG”, “LOW LIGHT NG” or “ATW NG” is displayed.

When performing the operations using the controller

When the AW-RP655 or AW-RP555 is connected:

1 Shoot a white subject (such as a white wall or handkerchief) so that it fills the screen.

- Do not shoot shiny or very bright objects.

2 Press the [A] button or [B] button of [WHITE BAL] to select “AWB A” or “AWB B” for the white balance.

The selected button's lamp lights.

- The white balance setting is not entered if “ATW” has been selected.

3 Press the [AWC] button.

The auto white balance adjustment (AWB) is executed, and the white balance setting is entered.

The [AWC] button's lamp blinks while the white balance is being adjusted, and its lamp goes off when the adjustment is completed successfully. Its lamp lights if the white balance could not be adjusted.

- If color bars have been selected (the [MODE] button or [BAR/CAM] button's lamp lights) or if ATW is selected (the [ATW] button's lamp lights), it means that the [AWC] button is not working or that the auto white balance adjustment has failed. (The button's lamp lights.)

White balance adjustment (continued)

■ When the AW-RP50 is connected:

Refer to the Operating Instructions of the controller.

Notes

- White balance may not be correctly set if the lighting of the object is too weak.
- Since the unit has a built-in memory, the set white balance will remain in the memory even if power is turned off. Therefore, it is not necessary to reset the white balance if the color temperature of those objects remains unchanged. However, it must be reset if the color temperature changes, such as when you move from indoors to outside, or vice versa.

● 3200K and 5600K presets

When “3200K” or “5600K” is selected for the white balance, the white balance is set using a color temperature of 3200K (equivalent to halogen light) or 5600K (equivalent to daylight), respectively.

This function works when “3200K” or “5600K” is selected instead of “AWB A” or “AWB B” by following the steps for “Automatic adjustment” in “White balance adjustment” (page 22).

(From the controller, this operation can be performed only using the menu displays. Refer to “Basic operations” (page 29).)

● Auto tracking white adjustment (ATW)

When the white balance adjustment is set to “ATW”, the white balance continues to be adjusted automatically all the time, and it is automatically corrected even when the light source or color temperature has changed to produce completely natural pictures.

This function works when “ATW” is selected instead of “AWB A” or “AWB B” by following the steps for “Automatic adjustment” in “White balance adjustment” (page 22).

Notes

- ATW might not function properly when high brightness light (ex. fluorescent lamp) beams into a screen.
- White balance may not be accurately set if there is no white object in the scene being shot.
- The white balance may shift out of adjustment when a different kind of light source such as sunlight or fluorescent lighting applies.

Black balance adjustment

■ Black balance adjustment

In order for the black to be reproduced accurately, the zero levels of the three primary colors (RGB) are adjusted. If the black balance has shifted out of adjustment, not only will the black be reproduced poorly but the color tones of the entire screen will also be degraded.

Normally, the black balance need not be re-adjusted, but it is necessary in the following situations.

- **This adjustment must be performed when using the unit for the first time or when the unit has not been used for a prolonged period.**
- **The adjustment must be performed when the ambient temperature has changed significantly and at the change of the seasons.**

● Automatic adjustment

When performing the operations using the wireless remote control

The procedure is the same as with “Automatic adjustment” in “White balance adjustment” (page 22).

The auto white balance adjustment (AWB) and auto black balance adjustment (ABB) can be performed, and the black balance setting entered.

- The white balance setting is also entered at the same time so ensure that the conditions for adjusting the white balance are met before proceeding.
- The black balance cannot be adjusted when color bars are displayed. Press the [MODE] button to switch to the camera picture.

When performing the operations using the controller

When the AW-RP655 or AW-RP555 is connected:

1 Press the [ABC] button.

The auto black balance operation is executed, and the black balance setting is entered.

The [ABC] button's lamp or LED blinks while the black balance is being adjusted, and its lamp goes off when the adjustment is completed successfully. It lights if the black balance could not be adjusted.

- If color bars have been selected (the [MODE] button or [BAR/CAM] button lights), it means that the [ABC] button is not working or that the auto black balance adjustment has failed. (The button's lamp lights.)

When the AW-RP50 is connected:

Refer to the Operating Instructions of the controller.

Black level (master pedestal) adjustment

■ Black level (master pedestal) adjustment

The black level can be adjusted when using a multiple number of cameras including the unit. Ask your dealer to perform this adjustment.

(Use an oscilloscope or waveform monitor for the adjustment.)

Adjust the black level in accordance with the units and devices used.

When performing the operations using the wireless remote control

1 Press the [M/IRIS] button.

Set the iris to the manual mode.

2 Press the [IRIS -] button.

The lens iris is stopped down.

3 Press the [▲] or [▼] button to bring the cursor to "Picture".

4 Press the [○] button.

The "Picture 1/3" sub-menu is displayed.

*** Picture 1/3 ***			
⇨ Chroma Level			0
White Balance Mode	AWB	A	
R Gain			0
B Gain			0
Pedestal			0
R Pedestal			0
B Pedestal			0
Return			

5 Press the [▲] or [▼] button to bring the cursor to "Pedestal".

*** Picture 1/3 ***			
Chroma Level			0
White Balance Mode	AWB	A	
R Gain			0
B Gain			0
⇨ Pedestal			0
R Pedestal			0
B Pedestal			0
Return			

6 Press the [○] button to start the "Pedestal" value blinking.

7 Press the [▲] or [▼] button, change the "Pedestal" value, and press the [○] button to enter the selection.

Adjust the black level to a value of approx. 0.035 V.



The pedestal values can be adjusted finely using the "R Pedestal" and "B Pedestal" settings.

8 Press the [MENU] button for 2 seconds.

The camera menu display is exited.

9 If necessary, press the [A/IRIS] button to adjust the iris automatically.

Black level (master pedestal) adjustment (continued)

When performing the operations using the controller

■ When the AW-RP655 is connected:

- 1** Press the [IRIS] button several times to turn off its lamp.
Set the iris to the manual ([MANU]) mode.
- 2** Turn the [FOCUS/IRIS] dial to stop down the lens iris.
- 3** Press the [R/B GAIN/PED] button several times so that the “PEDESTAL TOTAL” item is displayed on the LCD panel.
- 4** Turn the jog dial (main) and adjust the black level to 0.035 V.
- 5** If necessary, adjust the iris automatically.
→ Press the [IRIS] button several times to turn on its lamp.

■ When the AW-RP555 is connected:

- 1** Press the [IRIS] button several times to turn off its lamp.
Set the iris to the manual ([MANU]) mode.
- 2** Turn the [LEVEL] dial of [IRIS] to stop down the lens iris.
- 3** Follow the operation steps in “Basic operations” (page 35), and use the camera menu to perform the adjustment.

■ When the AW-RP50 is connected:

Refer to the Operating Instructions of the controller.

Genlock adjustment

■ Genlock adjustment

The genlock adjustment is performed to achieve phase alignment by applying external synchronization (genlock) when a multiple number of cameras will be used or when the unit will be used in combination with other devices.

This unit supports BBS (Black Burst Sync) and tri-level sync external synchronization signals.

Ask your dealer to perform this adjustment.

(Use a dual-trace oscilloscope for the adjustment.)

● Horizontal phase adjustment

Observe the waveforms of the external sync signal input (tri-level sync signal) and video signal output on the dual-trace oscilloscope, and use the wireless remote control or controller to bring the horizontal phase into alignment.

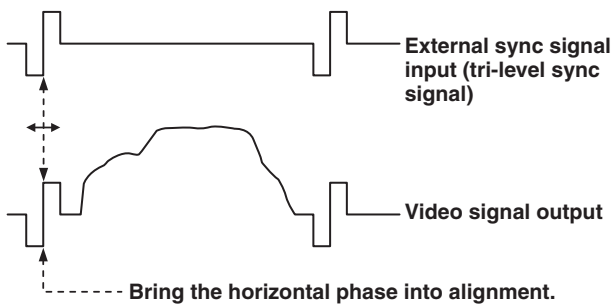

Example: When the tri-level sync phase is adjusted

When performing the operations using the wireless remote control

- 1 Follow the operation steps in “Basic operations” (page 31) to display the Top Menu.
- 2 Press the [▲] or [▼] button to bring the cursor to “System”.

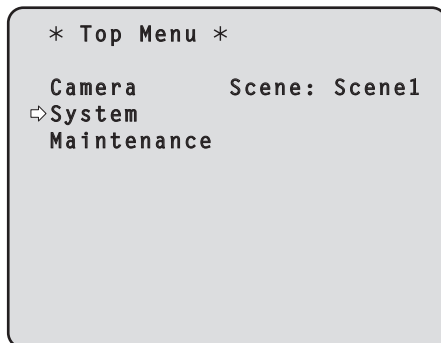

- 3 Press the [○] button.

The “System” sub-menu is displayed.

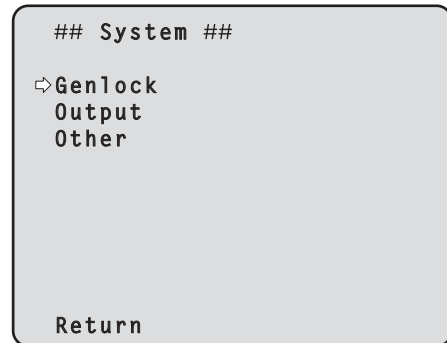

- 4 Press the [▲] or [▼] button to bring the cursor to “Genlock”, and press the [○] button.

The “Genlock” sub-menu is displayed.

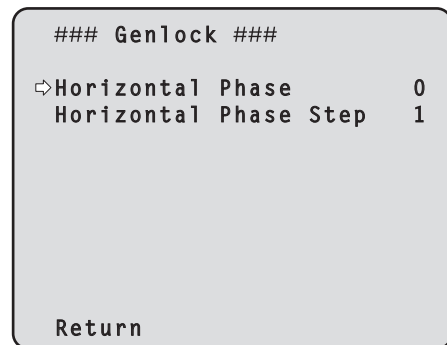

- 5 Press the [▲] or [▼] button to bring the cursor to “Horizontal Phase”, and press the [○] button.

The “Horizontal Phase” value starts blinking.

- 6 Press the [▲] or [▼] button to change the “Horizontal Phase” value, adjust the value so that the horizontal phase is brought into alignment, and press the [○] button.

The extent of the phase adjustment can be selected using “Horizontal Phase Step”.

- 7 Press the [MENU] button for 2 seconds.

The camera menu display is exited.

When performing the operations using the controller

These operations can be performed using the camera menus by following the operation steps in “Basic operations” (pages 29 to 36).

Basic operations

Camera menus are displayed on the monitor when the unit's settings are to be selected.

The monitor is connected to the video signal output connector.

The basic camera menu operations involve displaying sub-menus from the Top Menu items, and selecting settings on the sub-menus.

Some sub-menus have menu items for performing more detailed settings.

The camera menu operations are conducted using the wireless remote control.

If a controller is connected, they can also be conducted using the controller.

- It may be necessary to upgrade the controller's version in order to support the AW-HE120.
For further details, consult with your dealer.

Described below are the basic operations for changing the camera menu item settings using the wireless remote control and controller (AW-RP655, AW-RP555 or AW-RP50).

Only the steps taken using the wireless remote control will be described here for the operations conducted to select and set the items. For details of the operations conducted using the controller, substitute "controller" for "wireless remote control" when reading the basic operations. Also, refer to the Operating Instructions of the controller.

Table of operations

Camera menu operation	Wireless remote control	Controller		
		AW-RP655	AW-RP555	AW-RP50
Selecting the unit to be operated	Press the [CAM1], [CAM2], [CAM3] or [CAM4] button.	Press one of the [1] to [5] buttons of [CONTROL/ PREVIEW MONITOR OUT SEL].	Press one of the [1] to [5] buttons of [CONTROL].	Press one of the [CAMERA STATUS/SELECTION] buttons.
Displaying the Top Menu	Press the [MENU] button for 2 seconds.	<ol style="list-style-type: none"> 1. Press the [MENU] button. The display on the AW-RP655's LCD panel changes to the menu mode. 2. Turn the jog dial (main) to display "CAMERA SETTING" on the LCD panel, and press the [OK] button. 3. The scene selection menu now appears on the LCD panel so select the scene to be set, and press the [OK] button. 4. If the "OPEN CAMERA MENU? → OK Key" message appears on the LCD panel, press the [OK] button again. 	Press the [MENU] button for 2 seconds.	Press the [CAMERA OSD] button for 2 seconds.
Selecting the items	Press the [▲] or [▼] ([◀] or [▶]) button.	Turn the jog dial (main).	Press the [YES] or [NO] button.	Turn the F1 dial.
Displaying the sub-menus	Press the [○] button.	Press the jog dial (main).	Press the [ITEM] button.	Press the F1 dial.

Basic operations (continued)

Camera menu operation	Wireless remote control	Controller		
		AW-RP655	AW-RP555	AW-RP50
Returning to the previous menu	With the cursor at the [Return] position, press the [O] button.	With the cursor at the [Return] position, press the jog dial (main).	With the cursor at the [Return] position, press the [ITEM] button.	With the cursor at the [Return] position, press the F1 dial.
Changing the settings	With the cursor at the item to be changed, press the [O] button to start the item's value blinking. Use the [▲], [▼], [◀] and [▶] buttons to change the value, and press the [O] button to enter the change.	<ol style="list-style-type: none"> 1. Press the jog dial (main) to start the setting blinking. 2. Turn the jog dial (main) to change the setting. 3. Press the jog dial (main) to enter the setting (and stop the blinking). 	<ol style="list-style-type: none"> 1. Press the [ITEM] button to start the setting blinking. 2. Press the [YES] or [NO] button to change the setting. 3. Press the [ITEM] button to enter the setting (and stop the blinking). 	<ol style="list-style-type: none"> 1. Press the F1 dial to start the setting blinking. 2. Turn the F1 dial to change the setting. 3. Press the F1 dial to enter the setting (and stop the blinking).
Canceling the setting change	While the setting is blinking, press the [MENU] button quickly (for less than 2 seconds).	While the setting is blinking, press the jog dial (R).	While the setting is blinking, press the [MENU] button.	—
Exiting the camera menu operations	Press the [MENU] button for 2 seconds.	Press the [MENU] button or [R/B GAIN/PED] button.	Press the [MENU] button for 2 seconds.	Press the [CAMERA OSD] button for 2 seconds.

Notes

- Perform the menu operations and exit from the menus using the controller which displayed the Top Menu. If a menu operation has been performed or a menu has been exited using another controller, first display the Top Menu and exit from it using one controller, and then display the Top Menu and exit from it using the other controller.
- The procedures used for this unit's menu operations may differ from the ones used for the convertible cameras and HD integrated cameras which have already been released on the market. For details, refer to the Operating Instructions of the camera concerned.
- The response speed of the camera differs slightly depending on the controller used.

■ When performing the operations using the wireless remote control

- 1 Press the [CAM1], [CAM2], [CAM3] or [CAM4] button to select the unit which is to be operated.**
- 2 Press the [MENU] button for 2 seconds.**
The Top Menu is displayed.
- 3 Press the [▲] or [▼] button to bring the cursor to the item to be selected.**
Each time the [▲] or [▼] button is pressed, the cursor moves.
The cursor can be moved in the same way using the [◀] and [▶] buttons.
- 4 Press the [○] button.**
The sub-menu of the selected item is displayed.
(Some sub-menu items have a sub-menu of their own.)
- 5 Press the [▲] or [▼] button to bring the cursor to the item to be set.**
Each time the [▲] or [▼] button is pressed, the cursor moves.
The cursor can be moved in the same way using the [◀] and [▶] buttons.
With the cursor at the "Return" position, press the [○] button to return to the previous menu.
- 6 Press the [○] button.**
The value of the item to be set starts blinking.
- 7 Press the [▲] or [▼] button to change the setting.**
The setting can be changed in the same way using the [◀] and [▶] buttons.
- 8 Press the [○] button.**
The value of the item to be set is entered, and it stops blinking.
- 9 After the setting has been completed, press the [MENU] button for 2 seconds.**
The camera menu display is exited.

Basic operations (continued)

Control exercised from the Multi-Function Controller AW-RP655

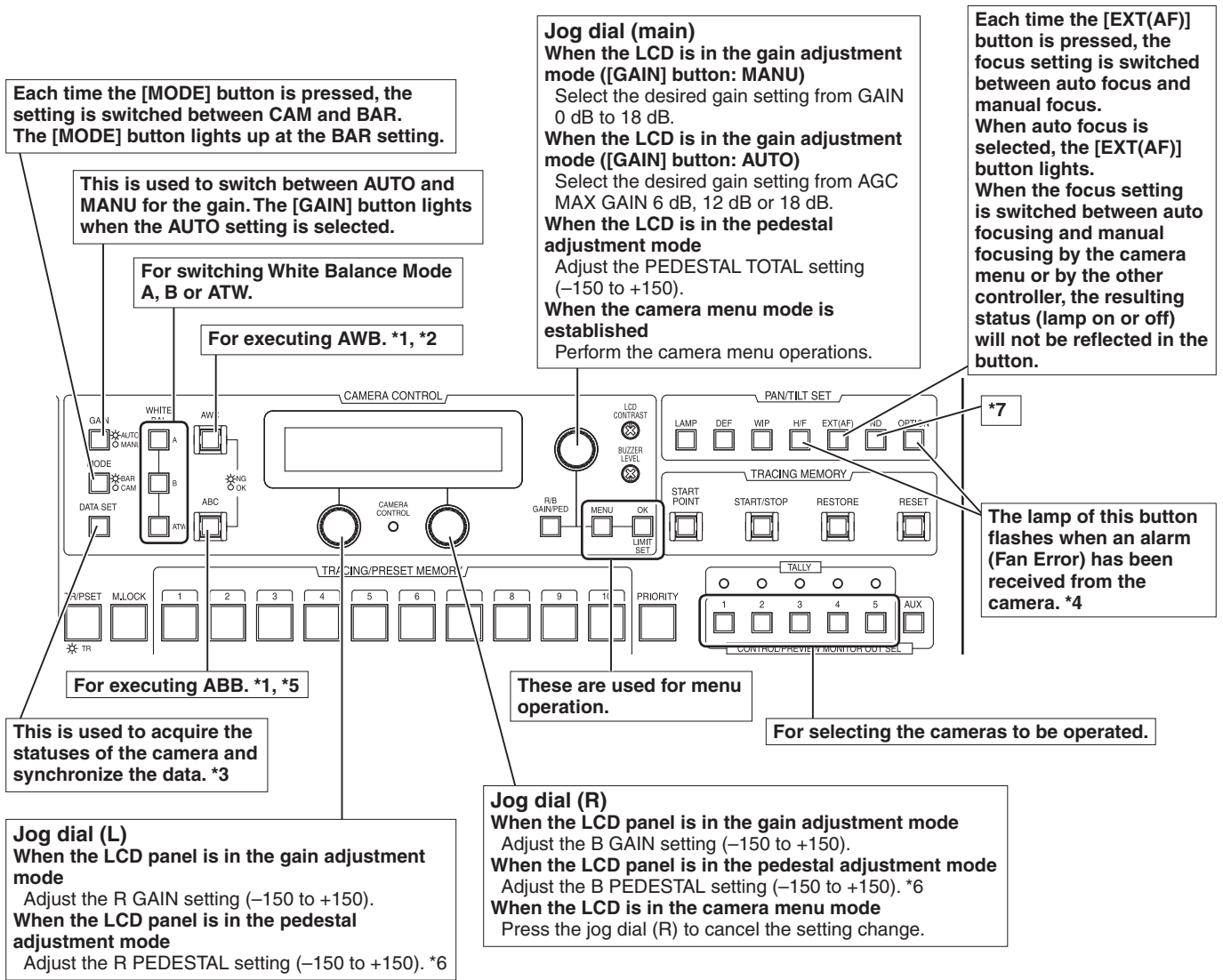

- *1: The lamp of the AWC or ABC switch flashes while automatic white balance or automatic black balance is being executed, respectively. When AWB or ABB is completed successfully, the corresponding lamp goes off; when it is not completed successfully, it lights up.
- *2: The switch lights without AWB being executed when the white balance mode of the main unit is ATW, 3200K, or 5600K, or when the Color Bar is being displayed.
- *3: SCENE FILE, CAM/BAR, and GAINUP of each SCENE, as well as the W/B MODE, R/B GAIN and T/R/B PED statuses are synchronized.

- *4: Flashing stops when communication is disconnected because the OPERATE switch has been turned OFF, CAMERA SELECT has been switched, the communication cable has been disconnected, etc.
- *5: The switch lights without ABB being executed when the Color Bar is being displayed.
- *6: The R/B GAIN adjustment is not available when the White Balance Mode is set to ATW, 3200K, or 5600K.
- *7: The ND button cannot be used. Perform the operations using the camera menu.

Basic operations (continued)

● Procedure for camera menu operation (AW-RP655)

1 Press one of the [1] to [5] buttons of [CONTROL/PREVIEW MONITOR OUT SEL] to select the unit which is to be operated.

2 Press the [MENU] button to set the LCD panel display to the menu mode.

3 Turn the jog dial (main) until CAMERA SETTING appears, and press the [OK] button.



4 When the scene selection menu has appeared on the LCD panel, select the scene to be set, and press the [OK] button.

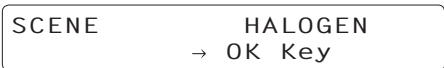

The scene names displayed on the LCD panel correlate with the scene files of the AW-HE120 as shown below.

AW-RP655 display	AW-HE120 scene file
HALOGEN	Scene1
FLUORESCENT	Scene2
OUTDOOR	Scene3
USER	Scene4

5 When the following message appears on the LCD panel, press the [OK] button again.



The camera menu of the AW-HE120 is displayed on the monitor.

6 Turn the jog dial (main) to select camera menu items of the AW-HE120 and change the data.

Turn the jog dial (main) when the cursor is to be moved up or down or the settings are to be changed. Press it when moving to the menu at the next lower hierarchical level or changing a setting at the very bottom hierarchical level.

7 Press the [MENU] button to exit the camera menu.

Notes

- Genlock is set using the camera menu for the AW-HE120.
- It may be necessary to upgrade the software version in order to operate an AW-HE120 from an AW-RP655. Ask your dealer for details.

Basic operations (continued)

Control exercised from the Multi Hybrid Control Panel AW-RP555

Each time the [GAIN] button is pressed, the setting is switched in the sequence of GAIN AUTO → 0dB → L (9dB) → H (18dB), and the mode is displayed by the LEDs as shown below.
[ON: LED lights; OFF: LED off]

	GAIN button	MANU L LED	MANU H LED
AUTO	ON	OFF	OFF
0dB	OFF	OFF	OFF
LOW	OFF	ON	OFF
HIGH	OFF	OFF	ON
Others	OFF	ON	ON

Each time the [MODE] button is pressed, the setting is switched between CAM and BAR.
The [MODE] button lights up at the BAR setting.

For selecting the cameras to be operated.

For switching the Iris mode. *3

Shutter mode selection

Each time this button is pressed, one of the shutter modes set by the controller or "shutter OFF" is selected. The [SHUTTER] button lights up in all modes except shutter OFF.

The shutter mode settings established by the [PRESET] buttons are as follows.

MODE	PRESET No.	MODE	PRESET No.
1/100**1	PRESET1	1/10000	PRESET7
1/120**2			
1/250	PRESET2	SYNCHRO-SCAN	PRESET8
1/500	PRESET3		
1/1000	PRESET4	ELC	PRESET9
1/2000	PRESET5	OFF	PRESET10
1/4000	PRESET6		

**1: "1/100" when 59.94 Hz is selected as the frequency setting of the AW-HE120.

**2: "1/120" when 50 Hz is selected as the frequency setting of the AW-HE120.

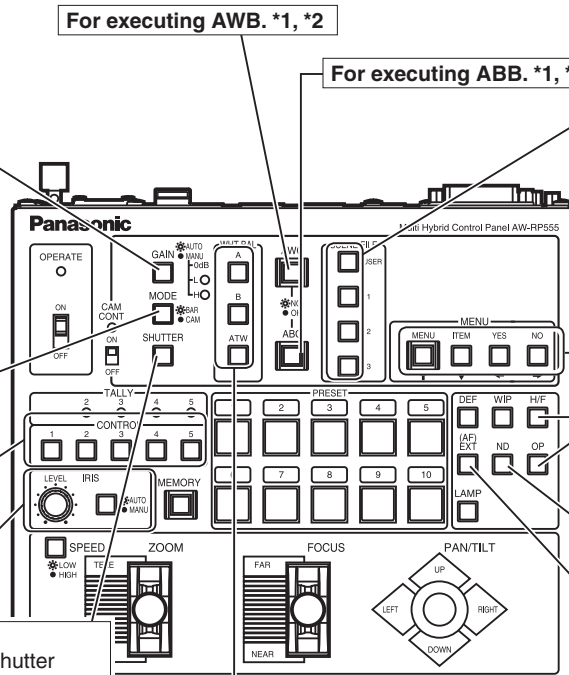

- *1: The lamp of the AWC or ABC switch flashes while automatic white balance or automatic black balance is being executed, respectively. When AWB or ABB is completed successfully, the corresponding lamp goes off; when it is not completed successfully, it lights up.
- *2: The switch lights without AWB being executed when the white balance mode of the main unit is ATW, 3200K, or 5600K, or when the Color Bar is being displayed.
- *3: When AUTO setting is established for the iris mode, this control can be used to adjust Picture Level; when MANU setting is established, it can be used to adjust the iris.

- *4: The switch lights without ABB being executed when the Color Bar is being displayed.
- *5: Flashing stops when communication is disconnected because the OPERATE switch has been turned OFF, CAMERA SELECT has been switched, the communication cable has been disconnected, etc.
- *6: The ND button cannot be used. Perform the operations using the camera menu.

Basic operations (continued)

● Procedure for camera menu operation (AW-RP555)

1 Press one of the [1] to [5] buttons of [CONTROL] to select the unit which is to be operated.

2 Press the [MENU] button of the AW-RP555 for 2 seconds.

The camera menu of the AW-HE120 is displayed on the monitor.

3 Perform one of the following steps to select the camera menu item.

If the [YES] button is pressed, the selection item moves up; if the [NO] button is pressed, it moves down.

4 Press the [ITEM] button.

The value of the item to be set starts blinking.

5 Press the [YES] or [NO] button to change the setting.

6 After deciding on the setting, press the [ITEM] button.

The value of the item to be set is entered, and it stops blinking.

7 Press the [MENU] button for 2 seconds to exit the camera menu.

Note

- It may be necessary to upgrade the software version in order to operate an AW-HE120 from an AW-RP555. Ask your dealer for details.

The scene names displayed on the panel of the AW-RP555 correlate with the scene files of the AW-HE120 as shown below.

AW-RP555 display	AW-HE120 scene file
1 (HALOGEN)	Scene1
2 (FLUORESCENT)	Scene2
3 (OUTDOOR)	Scene3
USER	Scene4

Basic operations (continued)

Control exercised from the Remote Camera Controller AW-RP50

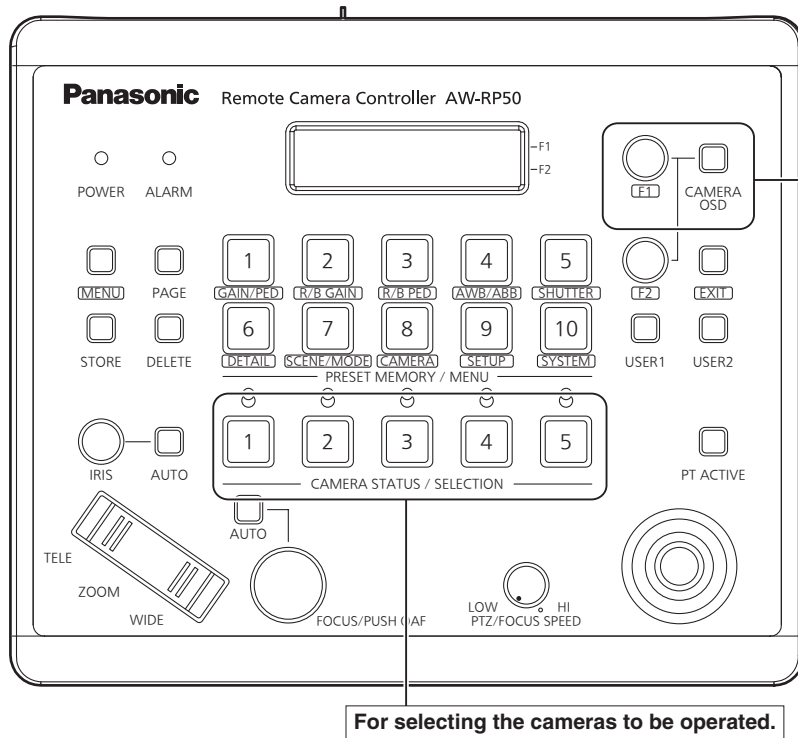

For operating the camera menus.
CAMERA OSD:
 When this is pressed for 2 seconds, the selected camera menu is displayed, overlapping the camera output image. When it is pressed for 2 seconds while a camera menu is displayed, the menu is cleared.
F1: Turn F1 to move the cursor up or down on the camera menu or change the setting. Press it when moving to the menu at the next lower hierarchical level or changing a setting at the very bottom hierarchical level.

For selecting the cameras to be operated.

Procedure for camera menu operation (AW-RP50)

1 Press one of the [CAMERA STATUS/ SELECTION] buttons to select the unit which is to be operated.

2 Press the [CAMERA OSD] button of the AW-RP50 for 2 seconds.

The camera menu of the AW-HE120 is displayed on the monitor.

3 Turn the F1 dial to select the AW-HE120 camera menu item or change the data.

Turn the F1 dial to move the cursor up or down or change the setting. Press it to move to the menu at the next lower hierarchical level or change a blinking setting at the very bottom hierarchical level.

The scene names displayed on the panel of the AW-RP50 correlate with the scene files of the AW-HE120 as shown below.

AW-RP50 display	AW-HE120 scene file
F-AUTO	Scene1
MANU1	Scene2
MANU2	Scene3
MANU3	Scene4

There are differences in the displays for the following menu items between when these items are set on the LCD of the AW-RP50 and when they are set using the camera menu.

	LCD of AW-RP50	Camera menu
Gain	Selected in a range from 0 dB to 18 dB in 3 dB steps.	Selected in a range from 0 dB to 18 dB in 1 dB steps.
Pedestal*1	21 steps from -10 to +10	301 steps from -150 to +150
R Gain*2 B Gain*2	61 steps from -30 to +30	301 steps from -150 to +150
AWB Mode White Balance Mode	3200K or 5600K cannot be selected.	3200K or 5600K can be selected.
Shutter Mode	ELC cannot be selected.	ELC can be selected.

*1: The -10 and +10 pedestal settings for the AW-RP50 correspond to -150 and +150 on the camera menu, respectively.
 *2: The -30 and +30 gain settings for the AW-RP50 correspond to -150 and +150 on the camera menu, respectively.

4 Press the [CAMERA OSD] button for 2 seconds to exit the camera menu.

Setting the camera menu items

■ Setting the camera menu items

When the unit's settings are to be selected, the camera menus are displayed on the monitor.

The monitor is connected to the video signal output connector.

The basic camera menu operations involve displaying sub-menus from the Top Menu items, and selecting settings on the sub-menus.

Some sub-menus have menu items for performing more detailed settings.

For details on the basic operations to display the camera menus and change the items using the wireless remote control or controller (AW-RP655, AW-RP555 or AW-RP50), refer to pages 29 to 36.

The “*” and “#” marks in the menu titles indicate the hierarchical level of the menu currently displayed.

For instance, “* Top Menu *” indicates the first hierarchical level whereas “** Camera **” and “## System ##” indicate that the second hierarchical level is now displayed.

Menu items accompanied by a “*” mark indicate data which is stored on a scene by scene basis; menu items accompanied by a “#” mark indicate data which is stored together for one camera regardless of the scenes.

■ Top Menu

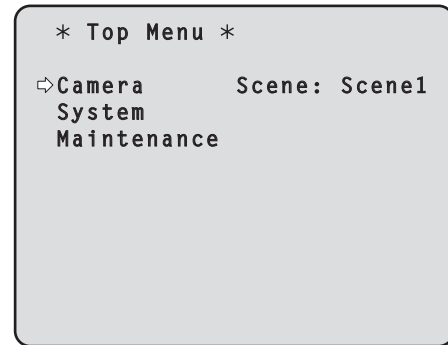

Camera

Select this to open the camera menu relating to the camera images.

System

Select this to display the System menu used to adjust the genlock (external synchronization) phase or establish the camera output image settings.

Maintenance

Select this to display the Maintenance menu used to check the camera's firmware version or initialize its settings.

Note

- The Top Menu does not have a “Return” setting. To close the menu screen, use the controller to perform the operation to close the menu screen. For details, refer to pages 29 to 36.

Setting the camera menu items (continued)

■ Camera screen

This menu is used for the camera image settings.

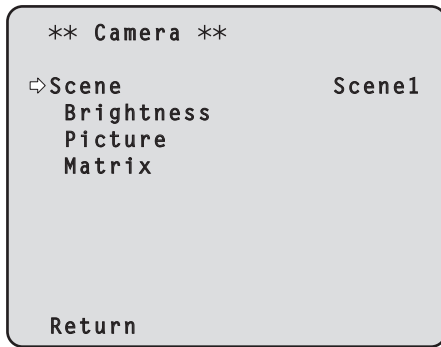

Scene

[Scene1, Scene2, Scene3, Scene4]

Selected here is the shooting mode that matches the shooting situation.

Select the mode which best suits the prevailing shooting conditions and the user's preferences.

Scene1, Scene2, Scene3, Scene4:

In these modes, the detailed settings and adjustments are established manually to match the prevailing shooting conditions and the user's preferences.

Brightness

This menu item displays the Brightness screen on which to set the brightness of the images.

Picture

This menu item displays the Picture screen on which to adjust the picture quality.

Three screens (Picture 1/3, Picture 2/3 and Picture 3/3) are provided for the picture quality adjustment menu.

Matrix

This menu item displays the Matrix screen on which to set the color matrix.

Four screens (Matrix 1/4, Matrix 2/4, Matrix 3/4 and Matrix 4/4) are provided for the color matrix adjustment menu.

Return

Use this to return to the previous menu.

■ Brightness screen

This menu item is selected to set the brightness of the pictures.

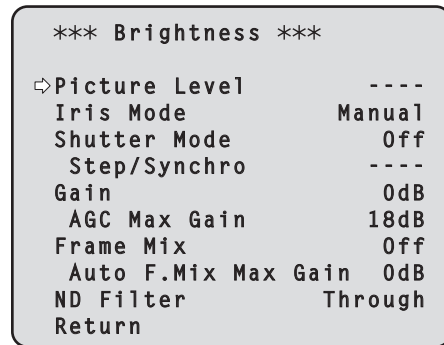

Picture Level [-10 to +10]

This menu item is selected to set the target picture level for automatic exposure compensation.

Its setting takes effect when "Auto" or "ELC" has been selected as the setting for any of the following automatic exposure compensation functions.

Iris Mode	Auto
Shutter Mode	ELC
Gain	Auto
Frame Mix	Auto

Iris Mode [Manual, Auto]

This menu item is used to select whether the iris is to be adjusted automatically or manually.

Manual: The iris is adjusted manually.

Auto: Auto exposure compensation is performed so that the target level which was set using Picture Level is reached.

Shutter Mode [Off, Step, Synchro, ELC]

Select for camera shutter speed.

Off: The shutter is set to OFF.

Step: The step shutter is set (the steps can be changed).

Synchro: The synchro shutter is set (the setting can be changed continuously).

ELC: The electronic shutter is controlled and the light quantity is adjusted automatically.

Setting the camera menu items (continued)

Step/Synchro

This is used to adjust the shutter speed in the mode which was selected as the "Shutter Mode" setting.

When a higher shutter speed is selected, fast-moving subjects do not become blurred easily but the images will be darker.

The shutter speeds that can be set are listed below.

[When 59.94 Hz has been set as the frequency]

When "Step" is selected as the "Shutter Mode"	When "Synchro" is selected as the "Shutter Mode"
1/100, 1/250, 1/500, 1/1000, 1/2000, 1/4000, 1/10000	60.17 Hz to max. 644.25 Hz (255 steps)

[When 50 Hz has been set as the frequency]

When "Step" is selected as the "Shutter Mode"	When "Synchro" is selected as the "Shutter Mode"
1/120, 1/250, 1/500, 1/1000, 1/2000, 1/4000, 1/10000	50.19 Hz to max. 537.12 Hz (255 steps)

Gain [Auto, 0dB to 18dB]

The image gain is adjusted here.

In locations which are too dark, adjust the gain upward; conversely, in locations which are too bright, adjust it downward.

When "Auto" is set, the light quantity is adjusted automatically.

The noise increases when the gain is increased.

The Gain setting is fixed at Auto when "Frame Mix" has been set to "Auto".

AGC Max Gain [6dB, 12dB, 18dB]

When "Auto" is selected as the "Gain" setting, the maximum gain-up amount can be set.

Frame Mix

[Auto, Off, 6dB, 12dB, 18dB, 24dB]

Select for frame addition (gain-up using sensor storage) amount.

When frame addition is performed, it will appear as if the images are missing some frames.

This menu item cannot be set when 1080i is used as the format.

The Gain setting is fixed at Auto when "Frame Mix" has been set to "Auto".

Auto F.Mix Max Gain

[0dB, 6dB, 12dB, 18dB, 24dB]

When "Auto" for the "Frame Mix" is selected, the maximum frame addition amount can be set.

If frame addition is performed at the Auto setting, it will appear as if the images are missing some frames.

This menu item cannot be set when 1080i is used as the format.

Note

- Under lighting generated by fluorescent lights, mercury lamps or other discharge lamps, the brightness may change synchronously, the colors may vary, and horizontal stripes may run vertically. In cases like this, it is recommended that the electronic shutter speed be set to 1/100 in areas where the power line frequency is 50 Hz and that the electronic shutter be set to OFF in areas where the power line frequency is 60 Hz.

ND Filter [Through, 1/4, 1/16, 1/64]

This is for selecting the transmissivity of the ND filter (light-dimming filter) which is incorporated in the lens.

Return

Use this to return to the previous menu.

Setting the camera menu items (continued)

Picture 1/3 screen

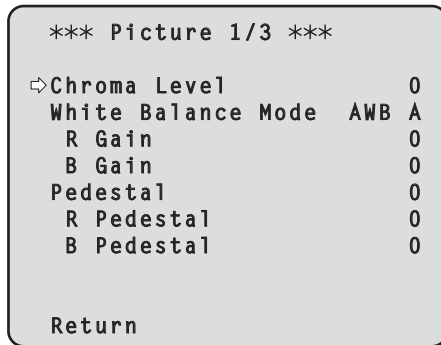

Chroma Level [-3 to +3]

Set here is the color intensity (chroma level) of the images.

White Balance Mode

[ATW, AWB A, AWB B, 3200K, 5600K]

The white balance mode is selected here. Select the mode when the coloring is not natural because of the nature of the light source or other factors. If the white color serving as the reference can be recognized, subjects can be shot with natural coloring.

ATW: In this mode, the white balance is compensated for automatically, even if changes occur in the light source or color temperature, by a process of continuous and automatic adjustment.

AWB A, AWB B:

When AWB A or AWB B is selected and the white balance is executed, the adjustment results obtained are stored in the memory selected. When AWB A or AWB B is then selected, the white balance stored in the selected memory can be recalled.

3200K: This is the white balance mode which is ideal when a 3200K halogen light is used as the light source.

5600K: This is the white balance mode which is ideal when 5600K sunlight or fluorescent lighting is used as the light source.

Note

- When preset settings have been called from the AW-RP655, the White Balance Mode which was set when the preset data was registered by the AW-RP655 will be called.

R Gain [-150 to +150]

This enables the R gain to be adjusted. Its setting takes effect when "AWB A" or "AWB B" has been selected as the "White Balance Mode" setting.

B Gain [-150 to +150]

This enables the B gain to be adjusted. Its setting takes effect when "AWB A" or "AWB B" has been selected as the "White Balance Mode" setting.

Pedestal [-150 to +150]

This item is used to adjust the black level (adjust the pedestal). These parts become darker when a negative setting is selected and, conversely, lighter when a positive setting is selected.

R Pedestal [-150 to +150]

This enables the R pedestal to be adjusted.

B Pedestal [-150 to +150]

This enables the B pedestal to be adjusted.

Return

Use this to return to the previous menu.

Picture 2/3 screen

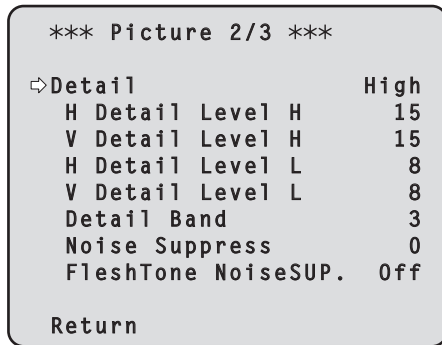

Detail [Off, Low, High]

The image detail (image sharpness) is adjusted here. When "High" is selected, the detail is enhanced.

H Detail Level H

[H Detail Level L setting value +1 to 63]

This is selected to adjust the horizontal detail compensation level when "High" has been selected as the "Detail" setting.

V Detail Level H

[V Detail Level L setting value +1 to 31]

This is selected to adjust the vertical detail compensation level when "High" has been selected as the "Detail" setting.

H Detail Level L

[1 to H Detail Level H setting value -1]

This is selected to adjust the horizontal detail compensation level when "Low" has been selected as the "Detail" setting.

V Detail Level L

[1 to V Detail Level H setting value -1]

This is selected to adjust the vertical detail compensation level when "Low" has been selected as the "Detail" setting.

Detail Band [1 to 5]

This is selected to set the boost frequency for Detail.

1: Low frequency
to
5: High frequency

When a high frequency is selected, the detail effect is added to subjects with more definition.

Noise Suppress [0 to 7]

This is selected to reduce the screen noise which is generated by the detail effect.

The higher the settings, the more the noise is reduced.

FleshTone NoiseSUP. [Off, Low, High]

This function is selected to make the skin of the subjects to be shot appear to be smoother and more attractive.

When "High" is selected, the effect is enhanced.

Return

Use this to return to the previous menu.

Setting the camera menu items (continued)

Picture 3/3 screen

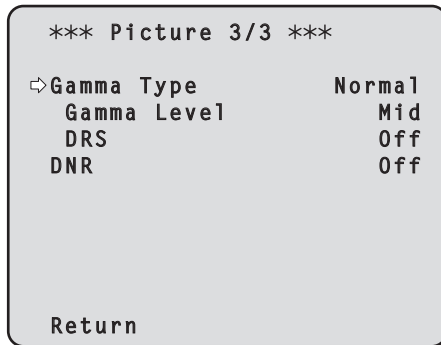

Gamma Type [Off, Normal, Cinema]

Selected here is the type of gamma curve. Normally, the “Normal” setting is used. When “Cinema” is selected, images giving off an atmosphere like movies can be shot.

Gamma Level [Low, Mid, High]

This item is used to adjust the gamma compensation level. The item’s setting takes effect when “Normal” has been selected as the “Gamma Type” setting. When “Low” is set, the images appear sedate and composed. The resulting gamma curve has a gentle gradient in the low-brightness areas, and the contrast is sharper. Conversely, when “High” is set, the tonal range in the dark area is expanded so that the images take on a lighter tone. The resulting gamma curve has a sharp gradient in the low-brightness areas, and the contrast is softer.

DRS [Off, Low, Mid, High]

Set here is the DRS function which provides just the right amount of compensation when images with significant light/dark differences are displayed. One of three settings — “Low”, “Mid” or “High” — can be selected for the effect. This may make noise more perceptible with some scenes.

Notes

- DRS takes effect only when “Normal” has been selected as the “Gamma Type” setting.
- When DRS is enabled, the digital zoom is disabled.

DNR [Off, Low, High]

Set here is the level of the digital noise reduction effect so that light, noise-free and clear images will be output even at night and in other low-brightness environments. When “Low” or “High” is selected, noise can be eliminated. However, there is an increased possibility that afterimages may occur.

Return

Use this to return to the previous menu.

Matrix 1/4 screen

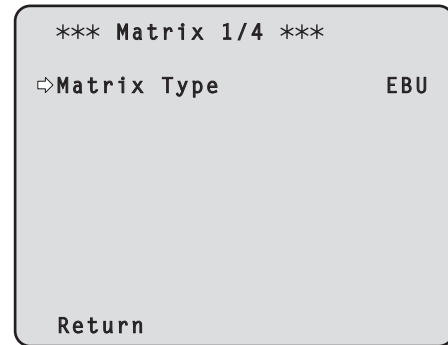

Matrix Type [Normal, EBU, NTSC, User]

This is used to select the type of color matrix.

Normal	This item is used to load the preset color matrix data and compensate for the saturation and color phase.
EBU	
NTSC	
User	On the “Matrix 2/4 screen”, the “Linear Matrix” value can be adjusted by the user. On the “Matrix 3/4 screen” or “Matrix 4/4 screen”, the “Color Correction” value can be adjusted by the user.

Return

Use this to return to the previous menu.

Setting the camera menu items (continued)

Matrix 2/4 screen

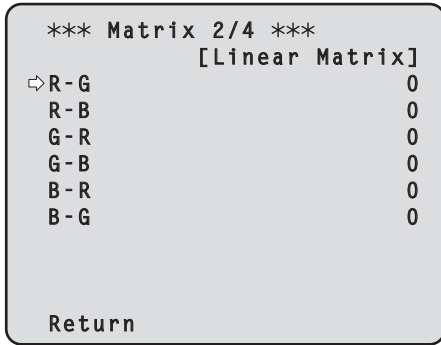

Linear Matrix

This can be set when “User” has been selected as the “Matrix Type” setting.

R-G [-31 to +31]

This is selected to adjust the colors in the R-G axis direction.

R-B [-31 to +31]

This is selected to adjust the colors in the R-B axis direction.

G-R [-31 to +31]

This is selected to adjust the colors in the G-R axis direction.

G-B [-31 to +31]

This is selected to adjust the colors in the G-B axis direction.

B-R [-31 to +31]

This is selected to adjust the colors in the B-R axis direction.

B-G [-31 to +31]

This is selected to adjust the colors in the B-G axis direction.

Return

Use this to return to the previous menu.

Matrix 3/4 screen

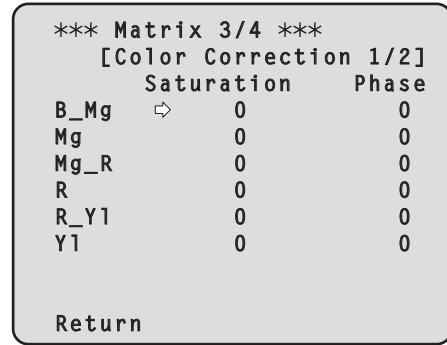

Color Correction 1/2

B_Mg Saturation [B_Mg Saturation: -127 to +127]

This is selected to increase or decrease the colors between blue and magenta.

B_Mg Phase [B_Mg Phase: -127 to +127]

This is selected to vary the hue (color phase) of the colors between blue and magenta.

Mg Saturation [Mg Saturation: -127 to +127]

This is selected to increase or decrease the magenta.

Mg Phase [Mg Phase: -127 to +127]

This is selected to vary the hue (color phase) of the magenta.

Mg_R Saturation [Mg_R Saturation: -127 to +127]

This is selected to increase or decrease the colors between magenta and red.

Mg_R Phase [Mg_R Phase: -127 to +127]

This is selected to vary the hue (color phase) of the colors between magenta and red.

R Saturation [R Saturation: -127 to +127]

This is selected to increase or decrease the red.

R Phase [R Phase: -127 to +127]

This is selected to vary the hue (color phase) of the red.

R_YI Saturation [R_YI Saturation: -127 to +127]

This is selected to increase or decrease the colors between red and yellow.

R_YI Phase [R_YI Phase: -127 to +127]

This is selected to vary the hue (color phase) of the colors between red and yellow.

YI Saturation [YI Saturation: -127 to +127]

This is selected to increase or decrease the yellow.

YI Phase [YI Phase: -127 to +127]

This is selected to vary the hue (color phase) of the yellow.

Return

Use this to return to the previous menu.

Setting the camera menu items (continued)

■ Matrix 4/4 screen

*** Matrix 4/4 ***			
[Color Correction 2/2]			
		Saturation	Phase
YI_G	⇨	0	0
G		0	0
G_Cy		0	0
Cy		0	0
Cy_B		0	0
B		0	0
Return			

Return

Use this to return to the previous menu.

Color Correction 2/2

YI_G Saturation [YI_G Saturation: -127 to +127]

This is selected to increase or decrease the colors between yellow and green.

YI_G Phase [YI_G Phase: -127 to +127]

This is selected to vary the hue (color phase) of the colors between yellow and green.

G Saturation [G Saturation: -127 to +127]

This is selected to increase or decrease the green.

G Phase [G Phase: -127 to +127]

This is selected to vary the hue (color phase) of the green.

G_Cy Saturation [G_Cy Saturation: -127 to +127]

This is selected to increase or decrease the colors between green and cyan.

G_Cy Phase [G_Cy Phase: -127 to +127]

This is selected to vary the hue (color phase) of the colors between green and cyan.

Cy Saturation [Cy Saturation: -127 to +127]

This is selected to increase or decrease the cyan.

Cy Phase [Cy Phase: -127 to +127]

This is selected to vary the hue (color phase) of the cyan.

Cy_B Saturation [Cy_B Saturation: -127 to +127]

This is selected to increase or decrease the colors between cyan and blue.

Cy_B Phase [Cy_B Phase: -127 to +127]

This is selected to vary the hue (color phase) of the colors between cyan and blue.

B Saturation [B Saturation: -127 to +127]

This is selected to increase or decrease the blue.

B Phase [B Phase: -127 to +127]

This is selected to vary the hue (color phase) of the blue.

Setting the camera menu items (continued)

■ System screen

This menu has items that relate to the genlock phase adjustment and camera's output image settings.

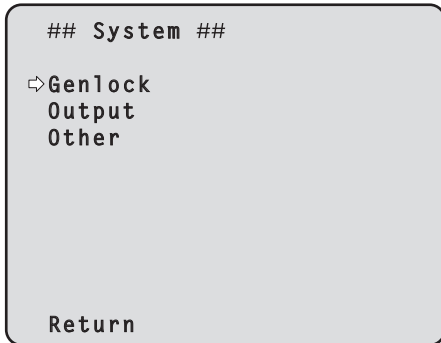

Genlock

This displays the Genlock screen on which to perform the phase adjustments.

Output

This displays the Output screen on which to select the camera's output image settings.

Other

This displays the Other screen on which to select the settings for the installation status of the camera's pan-tilt head unit and operating speed as well as the settings relating to the other functions.

Return

Use this to return to the previous menu.

■ Genlock screen

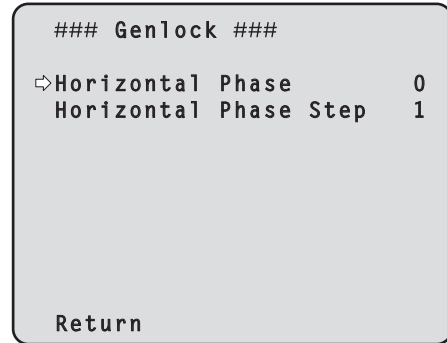

Horizontal Phase [-206 to +49]

This is used to adjust the horizontal phase during genlock.

Horizontal Phase Step [1 to 10]

This is selected to set the amount by which the "Horizontal Phase" setting is to be adjusted.

Return

Use this to return to the previous menu.

Note

- The horizontal phases of the HD and SD signals cannot be adjusted separately. Neither is it possible to adjust the chroma phase of the VIDEO OUT signals. The free run setting is used.

Setting the camera menu items (continued)

Output screen

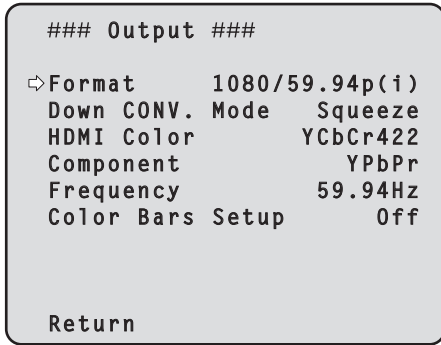

Format

[1080/59.94p(i), 1080/59.94i, 720/59.94p, 480/59.94p(i), 480/59.94i, 1080/50p(i), 1080/50i, 720/50p, 576/50p(i), 576/50i]

The video format is changed on this screen. For details on how to change the format, refer to "Changing the format" (page 47). In the case of the 1080/59.94p(i) or 1080/50p(i) format, the P signal is output to the HDMI connector, and the I signal is output to the SDI output and analog component output connectors.

Down CONV. Mode

[Squeeze, SideCut, LetterBox]

The down-conversion mode is selected here.

Squeeze	<p>This setting is used when the aspect ratio of the monitor is to be set to 16:9. If the monitor is set to the 4:3 aspect ratio, the images will be squeezed in the width direction and extended in the height direction.</p>
SideCut	<p>This setting is used when the aspect ratio of the monitor is to be set to 4:3. With the vertical height serving as the reference, the parts which extend beyond this at the two sides are cropped changing the view of the angle.</p>
LetterBox	<p>This setting is used when the aspect ratio of the monitor is to be set to 4:3. With the horizontal width serving as the reference, black bands are added at the top and bottom changing the view of the angle.</p>

- When output is selected for the color bar, the mode is fixed to Squeeze.

HDMI Color

[RGB-NOR, RGB-ENH, YCbCr422, YCbCr444]

Set here is the HDMI color output.

- When an HDMI monitor is used, use "YCbCr422" under normal circumstances.
- In cases where, for instance, HDMI (RGB) signals are converted and output to a DVI monitor, the settings required will differ depending on the color gradation supported by the monitor.

RGB-NOR	The RGB output signals are output in the 16 to 235 range.
RGB-ENH	The RGB output signals are output in the 0 to 255 range.

- If the black parts of the images appear overexposed when "RGB-NOR" has been selected, use the "RGB-ENH" setting instead.
- Conversely, if the images are displayed with a loss of dark detail when "RGB-ENH" has been selected, use the "RGB-NOR" setting instead.

Note

- If an HDMI Color setting which is not supported by the monitor has been specified, the HDMI Color setting may be changed automatically. (The menu display will remain unchanged.)

Component [YPbPr, RGB]

Either Y/Pb/Pr or RGB can be selected for the analog component signals.

Frequency [59.94Hz, 50Hz]

This item is selected to switch the frame frequency.

- When the frequency is switched, "Format" is set as follows.

59.94Hz		50Hz
1080/59.94p(i)	↔	1080/50p(i)
1080/59.94i	↔	1080/50i
720/59.94p	↔	720/50p
480/59.94p(i)	↔	576/50p(i)
480/59.94i	↔	576/50i

- For details on how to change the frequency, refer to "Changing the frequency" (page 48).

Setting the camera menu items (continued)

Color Bars Setup [Off, On]

The setting of this item takes effect only when "59.94Hz" has been selected as the "Frequency" setting. It enables the color bar setup level (Off: 0.0IRE or On: 7.5IRE) of the video output signals to be selected.

Return

Use this to return to the previous menu.

● Changing the format

When the currently selected format is to be changed to another format on the Output screen, the pre-format-change confirmation screen is displayed.

Pre-format-change confirmation screen

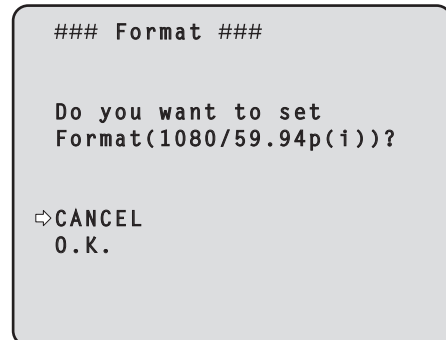

- The format to be set is displayed within the parentheses on the screen.
- When the cursor is moved to "O.K." on the pre-format-change confirmation screen and the change is entered, the post-format-change confirmation screen appears after the format has been changed.

Post-format-change confirmation screen

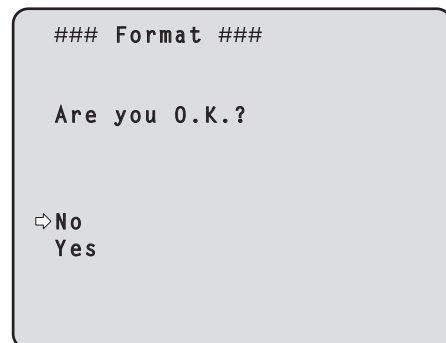

- If the cursor is moved to "Yes" and this selection is entered, the display returns to the Output screen in the post-change format.
- If the cursor is moved to "No" and this selection is entered, the display returns to the Output screen after the format has been changed back to the pre-change format.
The same operation is also performed when none of the unit's controls have been operated for a period in excess of 10 seconds.
- When an external sync signal which is not supported by the post-change format has been input, the image will be disturbed.
In a case like this, either change the external sync signal or use internal synchronization.

Setting the camera menu items (continued)

● Changing the frequency

When the currently selected frequency is to be changed to another frequency on the Output screen, the pre-frequency-change confirmation screen is displayed.

Pre-frequency-change confirmation screen

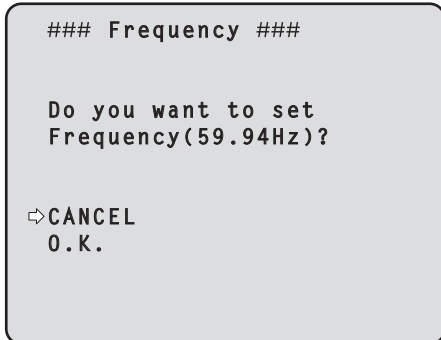

- The frequency to be set is displayed within the parentheses on the screen.
- When the cursor is moved to "O.K." on the pre-frequency-change confirmation screen and the change is entered, the post-frequency-change confirmation screen appears after the frequency has been changed.

Post-frequency-change confirmation screen

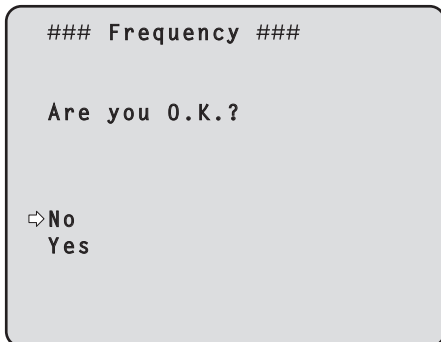

- If the cursor is moved to "Yes" and this selection is entered, the display returns to the Output screen with the post-change frequency.
- If the cursor is moved to "No" and this selection is entered, the display returns to the Output screen after the frequency has been changed back to the pre-change frequency. The same operation is also performed when none of the unit's controls have been operated for a period in excess of 10 seconds.
- When an external sync signal which is not supported by the post-change frequency has been input, the image will be disturbed. In a case like this, either change the external sync signal or use internal synchronization.

■ Other 1/3 screen

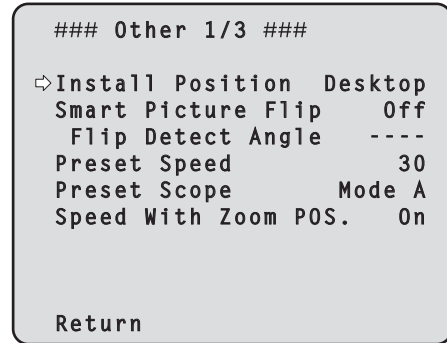

Install Position [Desktop, Hanging]

"Desktop" or "Hanging" is selected here as the method used to install the unit.

Desktop: Stand-alone installation

Hanging: Suspended installation

- When "Hanging" has been selected, the top, bottom, left and right of the images will be reversed, and up/down/left/right control for panning and tilting will also be reversed.

Smart Picture Flip [Off, Auto]

When tilt is set to the angle which was set by "Flip Detect Angle", the picture is automatically turned upside down (flipped).

Off: The picture is not turned upside down (flipped).

Auto: The picture is automatically turned upside down (flipped).

Flip Detect Angle [60° to 120°]

When "Auto" has been selected as the "Smart Picture Flip" setting, the tilt angle at which the picture is to be turned upside down (flipped) can be set here.

Preset Speed [1 to 30]

There are 30 preset pan-tilt operation speeds when regenerating the camera direction and other information which are registered in the preset memory.

Notes

- If a high value is selected for the Preset Speed setting, the image on the screen may shake when operation stops.
- When connecting the unit to the AW-RP655 for use, the "DIAGONAL SPEED (P/T SETTING)" setting of the AW-RP655 takes effect. To change the Preset Speed, change the AW-RP655 setting.

■ Other 2/3 screen

Preset Scope [Mode A, Mode B, Mode C]

Selected here are the setting items to be recalled when the contents of the preset memory are regenerated.

Mode A: Pan, Tilt, Zoom (including digital zoom), Focus, Iris, Gain, white balance adjustment value

Mode B: Pan, Tilt, Zoom (including digital zoom), Focus, Iris

Mode C: Pan, Tilt, Zoom (including digital zoom), Focus

Speed With Zoom POS. [Off, On]

“Off” or “On” is set here for the function used to adjust the pan-tilt adjustment speed in conjunction with the zoom magnification.

When “On” is set, the panning and tilting operations will become slower in the zoom status.

This function has no effect during preset operations.

Return

Use this to return to the previous menu.

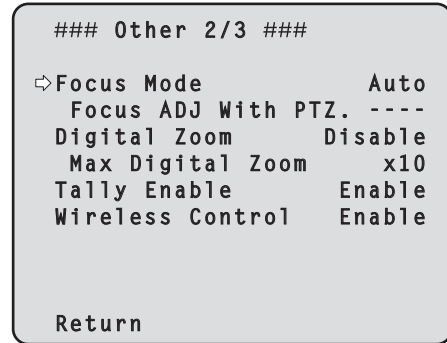

Focus Mode [Auto, Manual]

“Auto” or “Manual” is set here for the focusing function.

Auto: The subjects are always brought into focus automatically.

Manual: The focus is operated manually.

Focus ADJ With PTZ. [Off, On]

“Off” or “On” is set here for the function which compensates for out-of-focusing when it occurs during panning, tilting or zooming operations.

When “Off” is set, adjust the focus as required after zooming or set the focus to the auto mode.

This item can be selected only when “Manual” has been selected as the “Focus Mode” setting.

Digital Zoom [Disable, Enable]

“Enable” or “Disable” is set here for the digital zoom function.

If zooming is performed toward the Tele end beyond the maximum position when “Enable” has been selected, the digital zoom can be operated continuously. Zooming will stop temporarily at the position where the optical zoom and digital zoom are switched so after it has stopped at this position, proceed with zooming again.

When the setting is changed to “Disable” while already in the digital zoom region, the zoom will automatically move to the maximum position of the optical zoom.

Notes

- When DRS is enabled, the digital zoom is disabled.
- The digital zoom is set to off when color bars are displayed during digital zooming.

Setting the camera menu items (continued)

Max Digital Zoom

[x2, x3, x4, x5, x6, x7, x8, x9, x10]

The upper limit for the digital zoom magnification is set here.

Tally Enable [Disable, Enable]

“Enable” or “Disable” is set here for the function which turns on or turns off the tally lamp using the tally control signal.

Wireless Control [Disable, Enable]

“Enable” or “Disable” is set here for operations conducted from the wireless remote control.

The operations are enabled when the unit’s power is turned on from an external device other than a wireless remote control, and they are disabled when the power is turned on from a wireless remote control.

Notes

- At the point when this item’s setting is changed, the new setting is not reflected in operation. It is reflected when the unit is set to the standby mode and its power is turned on.
- Follow one of the procedures below if the item’s setting is changed by mistake and the unit can no longer be operated from a wireless remote control.

When menu operations can be performed using another control device:

- First change the item using a control device capable of performing menu operations, and then turn off the unit’s power and turn it back on.

When menu operations cannot be performed using other control devices:

1. Turn off the power of the units and devices that are connected.
2. Disconnect the unit’s power cable, and plug it back in.
3. Perform the operation for turning on the unit’s power from the wireless remote control.
4. After changing this item, turn off the unit’s power and turn it back on.

Return

Use this to return to the previous menu.

Other 3/3 screen

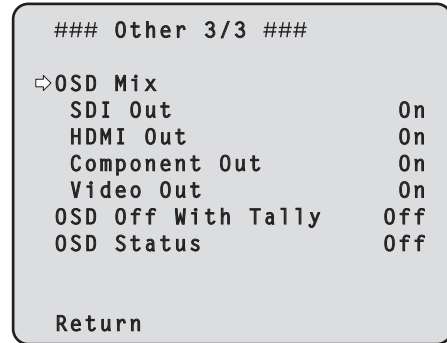

OSD Mix

Whether the camera menus, statuses and other displays are to be turned Off or On can be selected here for each output picture.

SDI Out [Off, On]

HDMI Out [Off, On]

Component Out [Off, On]

Video Out [Off, On]

Off: The camera menus and statuses are not displayed on the output pictures targeted by the setting items listed above.

On: The camera menus and statuses are displayed for the output pictures covered by the setting items listed above.

OSD Off With Tally [Off, On]

This is used to enable or disable the function for clearing the camera menu and status displays when the tally signal is received by a command or contact.

When the tally signal is released, the original camera menu displays are restored.

OSD Status [Off, On]

“On” or “Off” is set here for the status display which appears during AWB operations.

Return

Use this to return to the previous menu.

Setting the camera menu items (continued)

■ Maintenance screen

```
## Maintenance ##  
  
⇨Firmware Version  
IP Network  
Initialize  
  
Return
```

Firmware Version

This is selected to display the Firmware Version screen on which the user can check the version of the firmware which is currently installed in the unit.

IP Network

This is selected to display the IP Network screen on which the user can check the IP Address, Subnet Mask and Default Gateway settings which have been established in the unit.

Initialize

This is selected to display the Initialize screen on which the user can initialize the camera settings. For details on operation, refer to “Concerning initialization” on page 52.

Return

Use this to return to the previous menu.

■ Firmware VER 1/2 screen

```
### Firmware VER 1/2 ###  
  
CPU Software  
Interface          V01.00  
Camera Main       V01.00  
Servo             V01.00  
Network           V01.00  
EEPROM  
Interface          V01.00  
Camera Main       V01.00  
  
⇨Return
```

CPU Software Interface

This is selected to display the software version of the interface unit.

CPU Software Camera Main

This is selected to display the software version of the camera unit.

CPU Software Servo

This is selected to display the software version of the servo unit.

CPU Software Network

This is selected to display the software version of the network unit.

EEPROM Interface

This is selected to display the EEPROM version of the interface unit.

EEPROM Camera Main

This is selected to display the EEPROM version of the camera unit.

Return

Use this to return to the previous menu.

■ Firmware VER 2/2 screen

```
### Firmware VER 2/2 ###  
  
FPGA  
Frontend          V01.00  
Backend           V01.00  
Lens              V01.00  
  
⇨Return
```

FPGA Frontend

This is selected to display the FPGA version of the front end unit.

FPGA Backend

This is selected to display the FPGA version of the back end unit.

FPGA Lens

This is selected to display the FPGA version of the lens unit.

Return

Use this to return to the previous menu.

Setting the camera menu items (continued)

■ IP Network screen

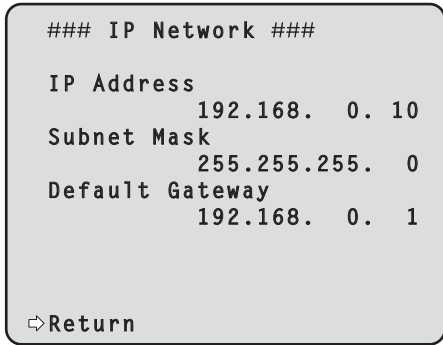

IP Address

This is selected to display the IP address which has been set for the unit.

Subnet Mask

This is selected to display the subnet mask address which has been set for the unit.

Default Gateway

This is selected to display the default gateway which has been set for the unit.

Note

- On this screen, the IP Address, Subnet Mask and Default Gateway settings can be displayed but they cannot be changed.
To change an address, use “Network” (page 78) on the Web setting screen or “Easy IP Setup Software” (page 40 in the <Basics>).

● Concerning initialization

When “Initialize” is selected on the Maintenance screen, the Initialize screen appears.

Initialize screen

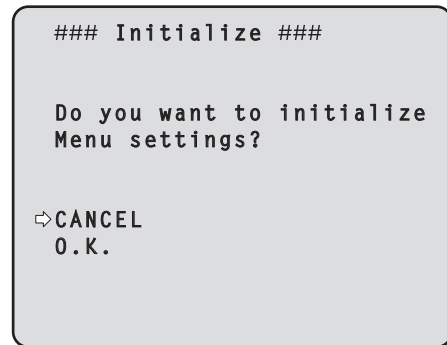

- When the cursor is moved to “O.K.” on the Initialize screen and the setting is entered, the Menu settings initialize screen is displayed for 5 seconds, and the camera settings are restored to the settings which were established when the camera was purchased. However, the Format settings and Frequency settings (see page 46) and network settings are not initialized. When the initialization operation is completed, the Top Menu screen is restored to the display.

Menu settings initialized screen

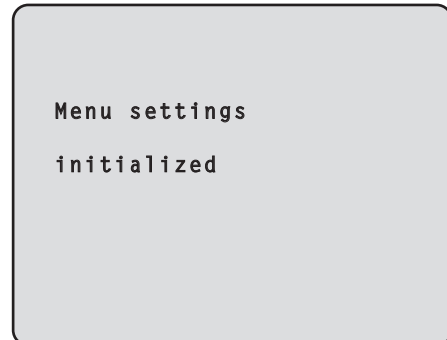

- When the cursor is moved to “CANCEL” on the Initialize screen and the setting is entered, the Menu settings unchanged screen is displayed for 5 seconds, the initialization operation is not performed, and the Maintenance screen returns to the display.

Menu settings unchanged screen

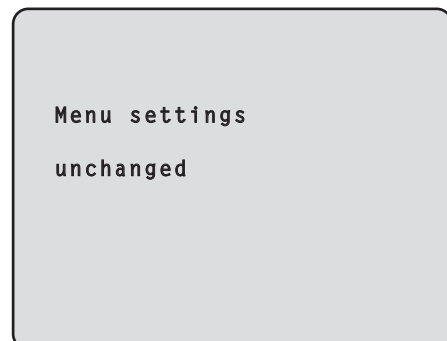

Camera menu item table

Camera menu			Item	Factory setting	Selection items	
Top Menu	Camera	Scene	Scene	Scene1	Scene1, Scene2, Scene3, Scene4	
		Brightness	Picture Level	0	-10 to +10	
			Iris Mode	Auto	Manual, Auto	
			Shutter Mode	Off	Off, Step, Synchro, ELC	
			Step/Synchro (When "Step" is selected as the "Shutter Mode")	----	[When 59.94Hz has been set as the frequency] 1/100, 1/250, 1/500, 1/1000, 1/2000, 1/4000, 1/10000 [When 50Hz has been set as the frequency] 1/120, 1/250, 1/500, 1/1000, 1/2000, 1/4000, 1/10000	
			Step/Synchro (When "Synchro" is selected as the "Shutter Mode")	----	[When 59.94Hz has been set as the frequency] 60.17Hz to 644.25Hz (1 to 255step) [When 50Hz has been set as the frequency] 50.19Hz to 537.12Hz (1 to 255step)	
			Gain	0dB	Auto, 0dB to 18dB	
			AGC Max Gain	18dB	6dB, 12dB, 18dB	
			Frame Mix	----	Auto, Off, 6dB, 12dB, 18dB, 24dB	
			Auto F.Mix Max Gain	----	0dB, 6dB, 12dB, 18dB, 24dB	
			ND Filter	Through	Through, 1/4, 1/16, 1/64	
	Picture		Picture 1/3	Chroma Level	0	-3 to +3
				White Balance Mode	AWB A	ATW, AWB A, AWB B, 3200K, 5600K
				R Gain	0	-150 to +150
				B Gain	0	-150 to +150
		Pedestal		0	-150 to +150	
		R Pedestal		0	-150 to +150	
		B Pedestal	0	-150 to +150		
		Picture 2/3	Detail	High	Off, Low, High	
			H Detail Level H	15	H Detail Level L setting value +1 to 63	
			V Detail Level H	15	V Detail Level L setting value +1 to 31	
	H Detail Level L		8	1 to H Detail Level H setting value -1		
	Picture 3/3	Gamma Type	Normal	Off, Normal, Cinema		
		Gamma Level	Mid	Low, Mid, High		
		DRS	Off	Off, Low, Mid, High		
		DNR	Off	Off, Low, High		
	Matrix	Matrix 1/4	Matrix Type	EBU	Normal, EBU, NTSC, User	
		Matrix 2/4	[Linear Matrix]			
			R-G	0	-31 to +31	
			R-B	0	-31 to +31	
			G-R	0	-31 to +31	
			G-B	0	-31 to +31	
			B-R	0	-31 to +31	
		B-G	0	-31 to +31		
		Matrix 3/4	[Color Correction 1/2]			
			B_Mg Saturation	0	-127 to +127	
			B_Mg Phase	0	-127 to +127	
			Mg Saturation	0	-127 to +127	
			Mg Phase	0	-127 to +127	
			Mg_R Saturation	0	-127 to +127	
			Mg_R Phase	0	-127 to +127	
			R Saturation	0	-127 to +127	
			R Phase	0	-127 to +127	
			R_YI Saturation	0	-127 to +127	
	R_YI Phase		0	-127 to +127		
	YI Saturation		0	-127 to +127		
	YI Phase	0	-127 to +127			

Camera menu item table (continued)

Camera menu					Item	Factory setting	Selection items		
Top Menu	Camera	Scene	Matrix	Matrix 4/4	[Color Correction 2/2]				
					YI_G Saturation	0	-127 to +127		
					YI_G Phase	0	-127 to +127		
					G Saturation	0	-127 to +127		
					G Phase	0	-127 to +127		
					G_Cy Saturation	0	-127 to +127		
					G_Cy Phase	0	-127 to +127		
					Cy Saturation	0	-127 to +127		
					Cy Phase	0	-127 to +127		
					Cy_B Saturation	0	-127 to +127		
Cy_B Phase	0	-127 to +127							
System	System	Genlock	Matrix	Matrix 4/4	Horizontal Phase	0	-206 to +49		
					Horizontal Phase Step	1	1 to 10		
					Output	Format	1080/59.94i	1080/59.94p(i), 1080/59.94i, 720/59.94p, 480/59.94p(i), 480/59.94i, 1080/50p(i), 1080/50i, 720/50p, 576/50p(i), 576/50i	
						Down CONV. Mode	Squeeze	Squeeze, SideCut, LetterBox	
						HDMI Color	YCbCr422	RGB-NOR, RGB-ENH, YCbCr422, YCbCr444	
						Component	YPbPr	YPbPr, RGB	
						Frequency	59.94Hz	59.94Hz, 50Hz	
						Color Bars Setup	Off	Off, On	
						Other	Other 1/3	Install Position	Desktop
					Smart Picture Flip	Off		Off, Auto	
Flip Detect Angle	----	60° to 120°							
Preset Speed	30	1 to 30							
Preset Scope	Mode A	Mode A, Mode B, Mode C							
Speed With Zoom POS.	On	Off, On							
Other	Other 2/3	Focus Mode	Auto	Auto, Manual					
		Focus ADJ With PTZ.	----	Off, On					
		Digital Zoom	Disable	Disable, Enable					
		Max Digital Zoom	----	x2, x3, x4, x5, x6, x7, x8, x9, x10					
		Tally Enable	Enable	Disable, Enable					
		Wireless Control	Enable	Disable, Enable					
Other	Other 3/3	OSD Mix							
		SDI Out	On	Off, On					
		HDMI Out	On	Off, On					
		Component Out	On	Off, On					
		Video Out	On	Off, On					
		OSD Off With Tally	Off	Off, On					
		OSD Status	Off	Off, On					
		Maintenance	Maintenance	Firmware Version	Matrix	Matrix 4/4	CPU Software		
Interface	Version shipped						----		
Camera Main	Version shipped						----		
Servo	Version shipped						----		
Network	Version shipped						----		
EEPROM									
Interface	Version shipped						----		
Camera Main	Version shipped						----		
FPGA									
Frontend	Version shipped						----		
Backend	Version shipped						----		
Lens	Version shipped						----		
IP Network	IP Address						192.168.0.10	----	
	Subnet Mask						255.255.255.0	----	
	Default Gateway						192.168.0.1	----	
Initialize	----						CANCEL	CANCEL, OK	

Web setting screen

Connect the unit and a personal computer, and establishing the settings on the Web browser screen.

The LAN crossover cable is used when connecting a personal computer directly to the unit's LAN connector for IP control, and the LAN straight cable is used when making the connection through a switching hub.

Select an IP address for the personal computer within the private address range while ensuring that it is different from the address of the unit.

Set the subnet mask to the same address as the unit.

For details of the required personal computer environment, refer to page 4.

Notes

- If you need to change the IP address and subnet mask, be sure to ask your dealer to make these changes for you.

Unit's IP address and subnet mask (factory settings)

IP address: 192.168.0.10

Subnet mask: 255.255.255.0

Range of private addresses:

192.168.0.0 to 192.168.0.255

- If the controller and web browser are being used at the same time, the content selected using the controller may not be reflected on the web browser display. When using both the controller and web browser, be absolutely sure to check the settings using the controller or camera menu.

Web setting screen (continued)

■ Menu operations

Start the Web browser, and enter “<http://192.168.0.10>” in the [Address] box of the Web browser. When the IP address has been changed, the URL will also change. If this is the case, set the changed IP address to the URL (<http://changed IP address/>).



- The menus can be switched by selecting the buttons on the left side of the screen.

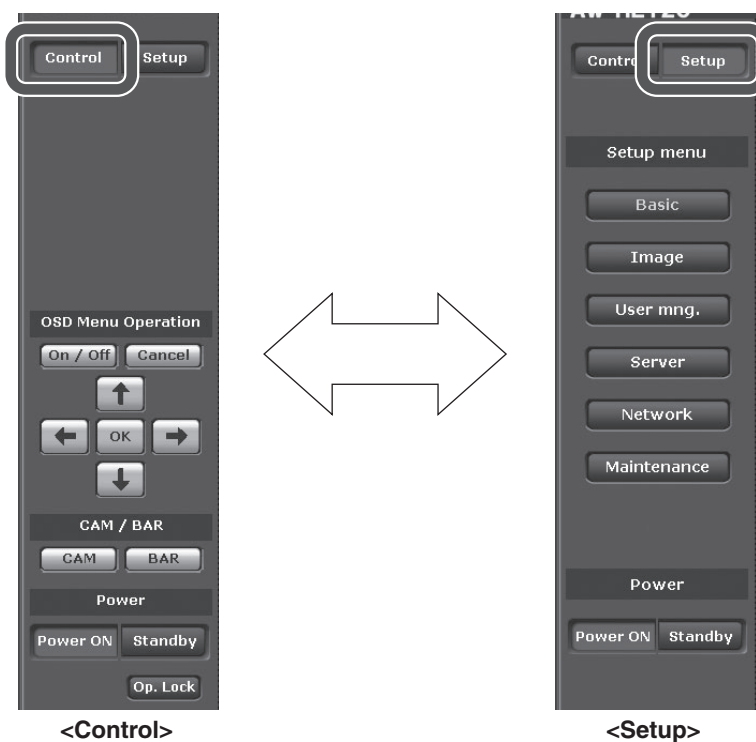

Web setting screen (continued)

• Control button / Setup button



Press the Control button to switch to the Control screen on which to control such operations as the panning, tilting, zooming and focusing of the camera. (See page 59)
 Press the Setup button to switch to the Setup screen on which to establish the camera's settings. (See page 61)

When the Setup button is pressed, the login screen shown below is displayed.



When logging in for the first time, input the following default values.

User name	admin
Password	12345

When the OK button is clicked after inputting the values, the screen shown below is displayed.
 Click the OK button.



Note

- On the User auth. screen (see page 75), register the user name and password of your choice at the earliest possible opportunity.

• OSD Menu Operation

	Use this to select whether the camera's on-screen displays are to be shown.
	It cancels the selection of the setting which is being changed. It restores the pre-change setting.
	Use these to perform the menu operations. The items are selected using the , , and buttons. If a selected item has a sub menu, this sub menu is displayed by pressing the button. When the cursor is moved to any item on the bottom-level setting screen and the button is pressed, the setting of the selected item starts flashing. A setting for a regular menu item is reflected immediately if it is changed while it is still flashing. However, there are a number of menu items (Scene, Format and Initialize) whose setting is reflected only after the button has been pressed, causing the setting to stop flashing and the new setting to be entered.

• Camera button / Color bar button (CAM/BAR)

	Use this to output the camera pictures.
	Use this to output the color bar signals. The "Down CONV. Mode" item is fixed at "Squeeze" while the color bar signals are displayed.

Web setting screen (continued)

- **Power ON button / Standby button**

Power ON Standby

The unit's power is turned on when the Power ON button is pressed.

When the Standby button is pressed, the unit is set to the standby mode.

While the standby mode is established, the control over the camera's operations exercised on the Control screen and the Image button on the Setup screen is disabled.

Notes

- If Power ON or Standby is selected too quickly, the status selected and the display shown may not correspond.
In a case like this, press the F5 key to restore the correct status display.
- When operation is transferred to the STANDBY mode: The current zoom, focus and iris positions are stored in the memory (POWER ON preset).
- When operation is transferred to the POWER ON mode: The zoom, focus and iris are transferred to the positions which were stored in the memory (POWER ON preset) when operation was transferred to the STANDBY mode.

- **Operation lock button (Op.Lock)**

Op. Lock

Use this to lock the operation of the pan, tilt, zoom, focus, brightness, speed, preset and scene operations on the control screen.
Use this also to lock the on-screen display menu operations, CAM/BAR and Power ON button/Standby button to prevent operations from being performed by accident.

Web setting screen (continued)

■ Control screen

This is the screen on which such operations as the panning, tilting, zooming and focusing of the unit can be controlled.



● Zoom

	Use this to enable or disable the digital zoom.
	Use this to adjust the zoom (magnification) to 1.0x.
	Use this to adjust the zoom (magnification) in the Wide direction.
	Use this to adjust the zoom (magnification) in the Tele direction.

● Focus

	Use this to switch between auto and manual focusing. When Auto is selected, the focus is adjusted automatically.
	Use this to adjust the focus in the Near direction. It does not work during automatic adjustments.
	When this is pressed while the focus is being adjusted manually, the focus will be temporarily adjusted automatically. It does not work during automatic adjustments.
	Use this to adjust the focus in the Far direction. It does not work during automatic adjustments.

Web setting screen (continued)

• Control pad and its buttons

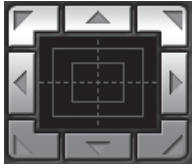

To adjust the image in the horizontal or vertical direction (panning or tilting), left-click the pad and the buttons.

The more the outside of the pad is clicked, the faster the camera operates. Adjustment is also possible by dragging the mouse.

Right-click the pad to initiate zooming and focusing.

When the top half of the pad is clicked in the up or down direction, the zoom (magnification) is adjusted in the Tele direction; conversely, when the bottom half of the pad is adjusted, the zoom is adjusted in the Wide direction.



When the left half of the pad is clicked in the left or right direction, the focus is adjusted in the Near direction; conversely when the right half of the pad is adjusted, the focus is adjusted in the Far direction.

The zooming can also be adjusted by operating the mouse wheel.

Note

- When the mouse is used for dragging and dropping from the control pad area to a position outside this area, the panning, tilting and other operations will not stop. In a case like this, click the control pad area to stop these operations.



• Brightness

	Use this to make the image darker. It does not work during automatic adjustments.
	Use this to make the image lighter. It does not work during automatic adjustments.
	Use this to switch the brightness adjustment between auto and manual. When Auto is selected, the picture brightness is adjusted automatically.

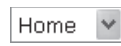

• Speed

	Use this to select the speed at which the pan, tilt, zoom and focus operations are to be performed.
---	---

• Preset

	When the preset position is selected from the pull-down menu and the Move button is clicked, the camera direction moves to the preset position which was registered ahead of time. Preset positions are registered on the preset position screen.
	The camera direction moves to the preset position which is now selected on the pull-down menu. The settings that are reproduced at this position are the settings which were established on the "Preset Scope" menu (see page 70, page 73). The camera direction moves to the home position if "Home" has been selected on the pull-down menu.

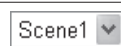
• Scene

	Use this if the scenes are to be switched when the shooting mode is selected from the pull-down menu and the Set button is clicked.
	Use this to switch to the shooting mode now being selected using the pull-down menu.

Web setting screen (continued)

■ Setup screen

Pressing the Setup button switches the display to this screen on which the unit's settings are established.

● Basic screen

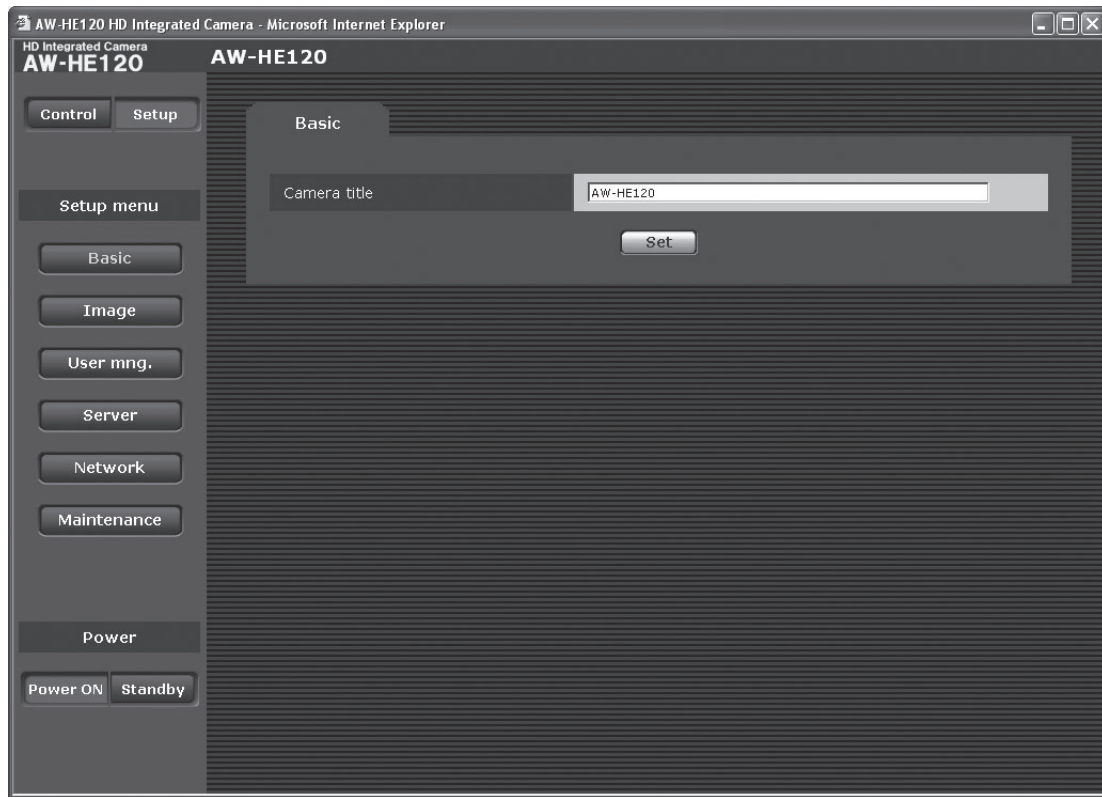

- **Basic button** 

When the Basic button is pressed, the Basic screen is displayed in the area on the right.

Camera title [0 to 20 half-size characters]

<Initial setting: AW-HE120>

Input the name of the camera here.

When the Set button is clicked, the input name appears in the camera title display area.

- **Camera title display area**



HD Integrated Camera
AW-HE120 AW-HE120

The name of the camera which was set on the Basic screen is displayed here.

Web setting screen (continued)

● Image screen

Image

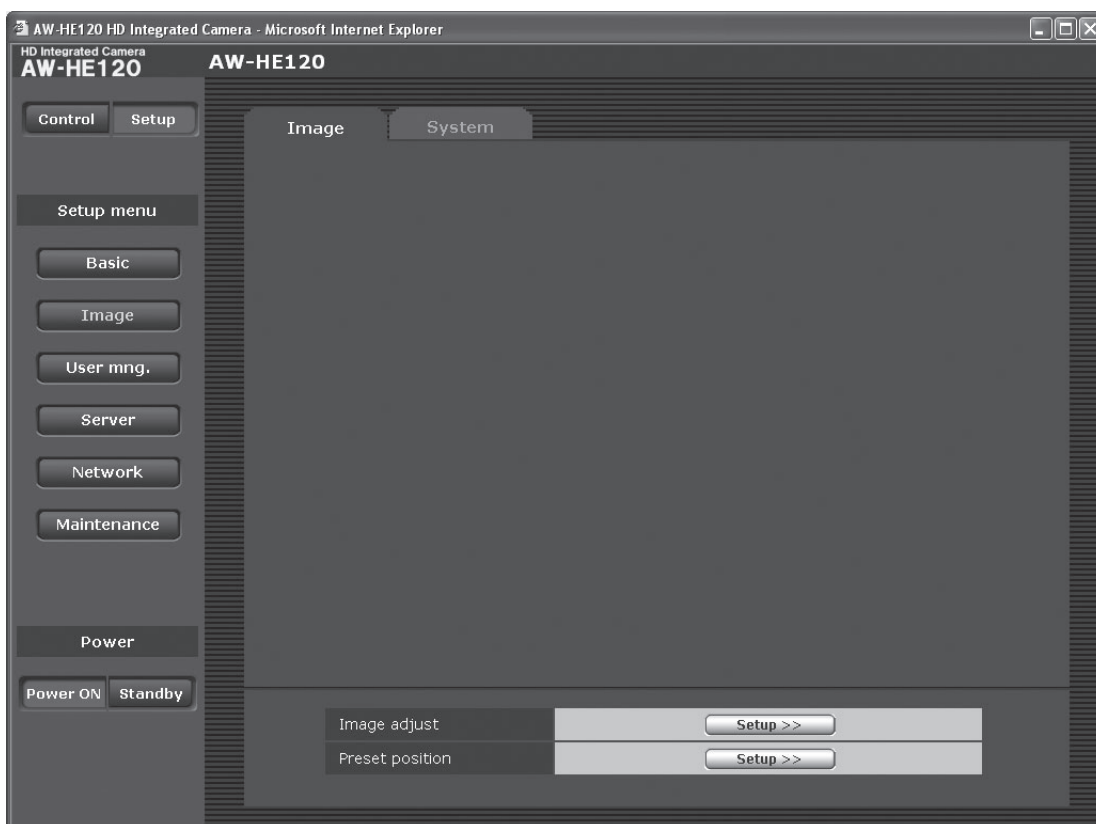

● Image

Image adjust

When the Setup button is clicked, the Image adjust screen is displayed.

Preset position

When the Setup button is clicked, the Preset position setting screen is displayed.

Web setting screen (continued)

Image adjust screen

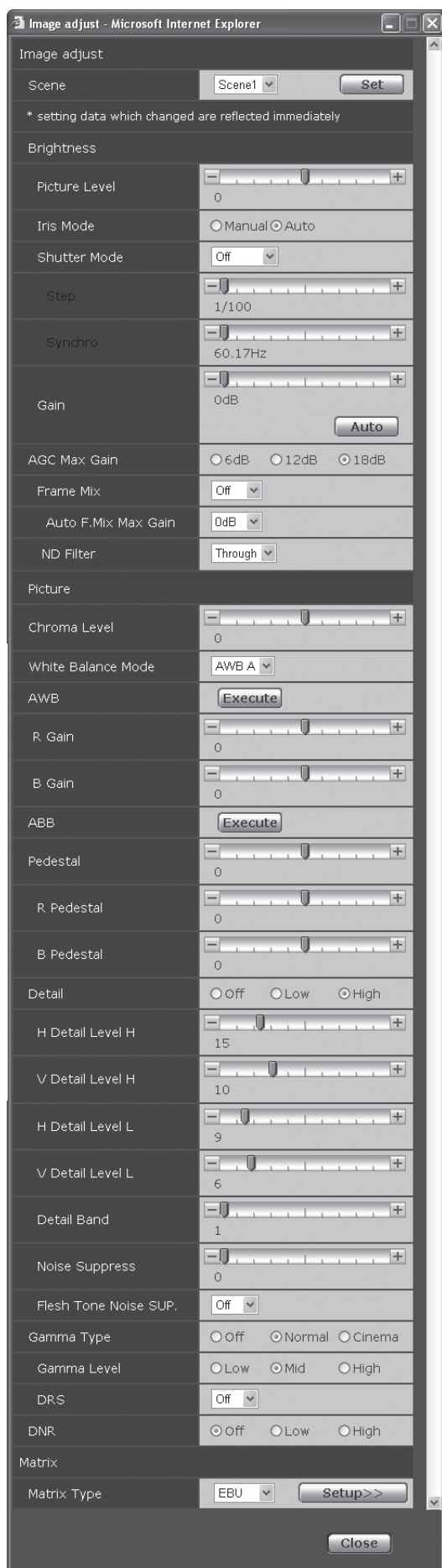

- **Scene**
[Scene1, Scene2, Scene3, Scene4]

Selected here is the shooting mode that matches the shooting situation.

Select the mode which best suits the prevailing shooting conditions and the user's preferences.

Scene1	In these modes, the detailed settings and adjustments are established manually to match the prevailing shooting conditions and the user's preferences.
Scene2	
Scene3	
Scene4	

Web setting screen (continued)

● Brightness

Picture Level [-10 to +10]

This menu item is selected to set the target picture level for automatic exposure compensation. Its setting takes effect when “Auto” or “ELC” has been selected as the setting for any of the following automatic exposure compensation functions.

Iris Mode	Auto
Shutter Mode	ELC
Gain	Auto
Frame Mix	Auto

Iris Mode [Manual, Auto]

This menu item is used to select whether the iris is to be adjusted automatically or manually.

Manual	The iris is adjusted manually.
Auto	Auto exposure compensation is performed so that the target level which was set using Picture Level is reached.

Shutter Mode [Off, Step, Synchro, ELC]

Select for camera shutter speed.

When a higher shutter speed is selected, fast-moving subjects do not become blurred easily but the images will be darker.

Off	The shutter is set to OFF.
Step	The step shutter is set (the steps can be changed).
Synchro	The synchro shutter is set (the setting can be changed continuously).
ELC	The electronic shutter is controlled and the light quantity is adjusted automatically.

The shutter speeds that can be set are listed below.

[When 59.94 Hz has been set as the frequency]

When “Step” is selected as the “Shutter Mode”	When “Synchro” is selected as the “Shutter Mode”
1/100, 1/250, 1/500, 1/1000, 1/2000, 1/4000, 1/10000	60.17 Hz to max. 644.25 Hz (255 steps)

[When 50 Hz has been set as the frequency]

When “Step” is selected as the “Shutter Mode”	When “Synchro” is selected as the “Shutter Mode”
1/120, 1/250, 1/500, 1/1000, 1/2000, 1/4000, 1/10000	50.19 Hz to max. 537.12 Hz (255 steps)

Gain [Auto, 0dB to 18dB]

The image gain is adjusted here.

In locations which are too dark, adjust the gain upward; conversely, in locations which are too bright, adjust it downward.

When “Auto” is set, the light quantity is adjusted automatically.

The noise increases when the gain is increased.

The Gain setting is fixed at Auto when “Frame Mix” has been set to “Auto”.

AGC Max Gain [6dB, 12dB, 18dB]

When “Auto” is selected as the “Gain” setting, the maximum gain-up amount can be set.

Frame Mix

[Auto, Off, 6dB, 12dB, 18dB, 24dB]

Select for frame addition (gain-up using sensor storage) amount.

When frame addition is performed, it will appear as if the images are missing some frames.

This menu item cannot be set when 1080i is used as the format.

The Gain setting is fixed at Auto when “Frame Mix” has been set to “Auto”.

Auto F.Mix Max Gain

[0dB, 6dB, 12dB, 18dB, 24dB]

When “Auto” for the “Frame Mix” is selected, the maximum frame addition amount can be set.

If frame addition is performed at the Auto setting, it will appear as if the images are missing some frames.

This menu item cannot be set when 1080i is used as the format.

Note

- Under lighting generated by fluorescent lights, mercury lamps or other discharge lamps, the brightness may change synchronously, the colors may vary, and horizontal stripes may run vertically. In cases like this, it is recommended that the electronic shutter speed be set to 1/100 in areas where the power line frequency is 50 Hz and that the electronic shutter be set to OFF in areas where the power line frequency is 60 Hz.

ND Filter [Through, 1/4, 1/16, 1/64]

This is for selecting the transmissivity of the ND filter (light-dimming filter) which is incorporated in the lens.

Web setting screen (continued)

● Picture

Chroma Level [-3 to +3]

Set here is the color intensity (chroma level) of the images.

White Balance Mode

[ATW, AWB A, AWB B, 3200K, 5600K]

The white balance mode is selected here. Select the mode when the coloring is not natural because of the nature of the light source or other factors. If the white color serving as the reference can be recognized, subjects can be shot with natural coloring.

ATW	In this mode, the white balance is compensated for automatically, even if changes occur in the light source or color temperature, by a process of continuous and automatic adjustment.
AWB A, AWB B	When AWB A or AWB B is selected and the white balance is executed, the adjustment results obtained are stored in the memory selected. When AWB A or AWB B is then selected, the white balance stored in the selected memory can be recalled.
3200K	This is the white balance mode which is ideal when a 3200K halogen light is used as the light source.
5600K	This is the white balance mode which is ideal when 5600K sunlight or fluorescent lighting is used as the light source.

Note

- When preset settings have been called from the AW-RP655, the White Balance Mode which was set when the preset data was registered by the AW-RP655 will be called.

AWB

This is used to execute automatic white balance (AWB) to set the white balance.
For details, refer to page 22.

R Gain [-150 to +150]

This enables the R gain to be adjusted. Its setting takes effect when "AWB A" or "AWB B" has been selected as the "White Balance Mode" setting.

B Gain [-150 to +150]

This enables the B gain to be adjusted. Its setting takes effect when "AWB A" or "AWB B" has been selected as the "White Balance Mode" setting.

ABB

This is used to execute automatic black balance (ABB) to set the black balance.
For details, refer to page 25.

Pedestal [-150 to +150]

This item is used to adjust the black level (adjust the pedestal).
These parts become darker when a negative setting is selected and, conversely, lighter when a positive setting is selected.

R Pedestal [-150 to +150]

This enables the R pedestal to be adjusted.

B Pedestal [-150 to +150]

This enables the B pedestal to be adjusted.

Detail [Off, Low, High]

The image detail (image sharpness) is adjusted here. When "High" is selected, the detail is enhanced.

H Detail Level H

[H Detail Level L setting value +1 to 63]

This is selected to adjust the horizontal detail compensation level when "High" has been selected as the "Detail" setting.

V Detail Level H

[V Detail Level L setting value +1 to 31]

This is selected to adjust the vertical detail compensation level when "High" has been selected as the "Detail" setting.

H Detail Level L

[1 to H Detail Level H setting value -1]

This is selected to adjust the horizontal detail compensation level when "Low" has been selected as the "Detail" setting.

V Detail Level L

[1 to V Detail Level H setting value -1]

This is selected to adjust the vertical detail compensation level when "Low" has been selected as the "Detail" setting.

Detail Band [1 to 5]

This is selected to set the boost frequency for Detail.

- 1: Low frequency
to
5: High frequency

When a high frequency is selected, the detail effect is added to subjects with more definition.

Web setting screen (continued)

Noise Suppress [0 to 7]

This is selected to reduce the screen noise which is generated by the detail effect.
The higher the settings, the more the noise is reduced.

Flesh Tone Noise SUP. [Off, Low, High]

This function is selected to make the skin of the subjects to be shot appear to be smoother and more attractive.
When “High” is selected, the effect is enhanced.

Gamma Type [Off, Normal, Cinema]

Selected here is the type of gamma curve.
Normally, the “Normal” setting is used.
When “Cinema” is selected, images giving off an atmosphere like movies can be shot.

Gamma Level [Low, Mid, High]

This item is used to adjust the gamma compensation level.
The item's setting takes effect when “Normal” has been selected as the “Gamma Type” setting.
When “Low” is set, the images appear sedate and composed. The resulting gamma curve has a gentle gradient in the low-brightness areas, and the contrast is sharper.
Conversely, when “High” is set, the tonal range in the dark area is expanded so that the images take on a lighter tone. The resulting gamma curve has a sharp gradient in the low-brightness areas, and the contrast is softer.

DRS [Off, Low, Mid, High]

Set here is the DRS function which provides just the right amount of compensation when images with significant light/dark differences are displayed.
One of three settings — “Low”, “Mid” or “High” — can be selected for the effect.
This may make noise more perceptible with some scenes.

Notes

- DRS takes effect only when “Normal” has been selected as the “Gamma Type” setting.
- When DRS is enabled, the digital zoom is disabled.

DNR [Off, Low, High]

Set here is the level of the digital noise reduction effect so that light, noise-free and clear images will be output even at night and in other low-brightness environments.
When “Low” or “High” is selected, noise can be eliminated.
However, there is an increased possibility that afterimages may occur.

• Matrix

Matrix Type

When the Setup button is clicked, the Matrix Settings screen is displayed.

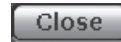

This is used to close this panel.

Web setting screen (continued)

Matrix Settings screen

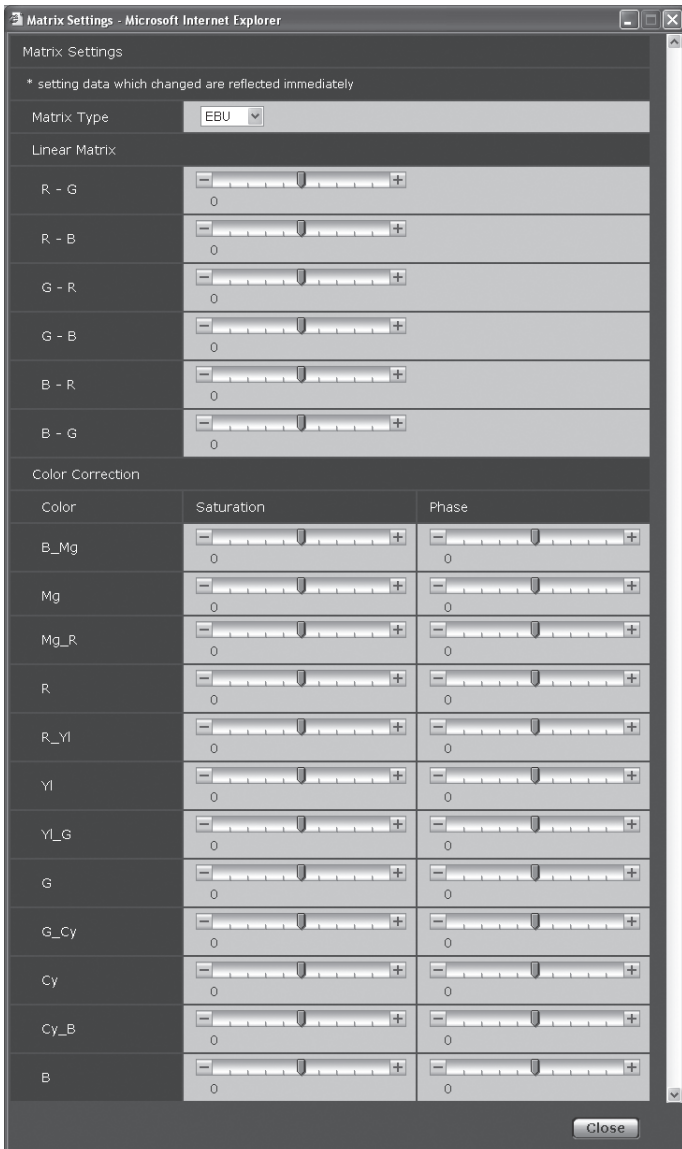

• Matrix Type

This is used to select the type of color matrix.

Normal	This item is used to load the preset color matrix data and compensate for the saturation and color phase.
EBU	
NTSC	
User	This item makes it possible for the “Linear Matrix” and “Color Correction” values to be adjusted by the user.

• Linear Matrix

These settings can be performed when “User” has been selected as the matrix type.

R-G	Use these to adjust the colors in the axis directions in a range from -31 to +31.
R-B	
G-R	
G-B	
B-R	
B-G	

• Color Correction

Use this for performing the saturation and hue (color phase) adjustments.

Saturation

Use this to adjust the saturation of the colors in a range from -127 to +127.

Phase

Use these to adjust the hue (color phase) of the colors in a range from -127 to +127.

B_Mg	Colors between blue and magenta
Mg	Magenta
Mg_R	Colors between magenta and red
R	Red
R_Yl	Colors between red and yellow
Yl	Yellow
Yl_G	Colors between yellow and green
G	Green
G_Cy	Colors between green and cyan
Cy	Cyan
Cy_B	Colors between cyan and blue
B	Blue

Web setting screen (continued)

Preset position screen



● Preset

	This selects the preset position to be operated from the pull-down menu.
	This is used to register the current status in the preset position now selected on the pull-down menu. It does not function if "Home" has been selected on the pull-down menu.
	The camera direction moves to the preset position which is now selected on the pull-down menu. The settings that are reproduced at this position are the settings which were established on the "Preset Scope" menu (see page 70, page 73). The camera direction moves to the home position if "Home" has been selected on the pull-down menu.
	This is used to delete the preset position setting which is currently being selected.

● Zoom



	Use this to adjust the zoom (magnification) in the Wide direction.
	Use this to adjust the zoom (magnification) to 1.0x.
	Use this to adjust the zoom (magnification) in the Tele direction.
	Use this to enable or disable the digital zoom.

● Focus

	Use this to adjust the focus in the Near direction. It does not work during automatic adjustments.
	When this is pressed while the focus is being adjusted manually, the focus will be temporarily adjusted automatically. It does not work during automatic adjustments.
	Use this to adjust the focus in the Far direction. It does not work during automatic adjustments.
	Use this to switch between auto and manual focusing.

Web setting screen (continued)

• Brightness

	Use this to make the image darker. It does not work during automatic adjustments.
	Use this to make the image lighter. It does not work during automatic adjustments.
	Use this to switch the picture brightness adjustment between auto and manual.

• Control pad and its buttons

	<p>To adjust the image in the horizontal or vertical direction (panning or tilting), left-click the pad and the buttons.</p> <p>The more the outside of the pad is clicked, the faster the camera operates. Adjustment is also possible by dragging the mouse.</p> <p>Right-click the pad to initiate zooming and focusing.</p> <p>When the top half of the pad is clicked in the up or down direction, the zoom (magnification) is adjusted in the Tele direction; conversely, when the bottom half of the pad is adjusted, the zoom is adjusted in the Wide direction.</p> <p>When the left half of the pad is clicked in the left or right direction, the focus is adjusted in the Near direction; conversely when the right half of the pad is adjusted, the focus is adjusted in the Far direction.</p> <p>The zooming can also be adjusted by operating the mouse wheel.</p>
---	--

Note

- When the mouse is used for dragging and dropping from the control pad area to a position outside this area, the panning, tilting and other operations will not stop. In a case like this, click the control pad area to stop these operations.

• Speed

	Use this to select the speed at which the pan, tilt, zoom and focus operations are to be performed.
---	---

• Speed With Zoom POS.

“Off” or “On” is set here for the function used to adjust the pan-tilt adjustment speed in conjunction with the zoom magnification.

Off	The panning and tilting operations will not become slower in the zoom status.
On	The panning and tilting operations will become slower in the zoom status.

This function has no effect during preset operations.

• Focus ADJ With PTZ.

“Off” or “On” is set here for the function which compensates for out-of-focusing when it occurs during panning, tilting or zooming operations.

Off	Out-of-focusing is not compensated.
On	Out-of-focusing is compensated.

When “Off” is set, adjust the focus as required after zooming or set the focus to the auto mode. This item can be selected only when “Manual” has been selected as the “Focus Mode” setting.

Web setting screen (continued)

● Preset Setting

Preset Speed [1 to 30]

There are 30 preset pan-tilt operation speeds when regenerating the camera direction and other information which are registered in the preset memory.



This is used to close this panel.

Notes

- If a high value is selected for the Preset Speed setting, the image on the screen may shake when operation stops.
- When connecting the unit to the AW-RP655 for use, the "DIAGONAL SPEED (P/T SETTING)" setting of the AW-RP655 takes effect.
To change the Preset Speed, change the AW-RP655 setting.

Preset Scope [Mode A, Mode B, Mode C]

Selected here are the setting items to be recalled when the contents of the preset memory are regenerated.

Mode A	Pan, Tilt, Zoom (including digital zoom), Focus, Iris, Gain, white balance adjustment value
Mode B	Pan, Tilt, Zoom (including digital zoom), Focus, Iris
Mode C	Pan, Tilt, Zoom (including digital zoom), Focus

● Limitation Setting

This establishes the up, down, left and right limit settings of the pan-tilt head.

First, move the pan-tilt head to the position where the limit is to be set, and press the corresponding button below to set the direction (up, down, left or right) in which the limit is to be set.

After each setting has been selected, press the Set button to enter the setting.

Tilt Up	Use this to save the current position as the upward limit.
Tilt Down	Use this to save the current position as the downward limit.
Pan Left	Use this to save the current position as the leftward limit.
Pan Right	Use this to save the current position as the rightward limit.
Set/Release	Use this to enable or disable the limit setting in each direction.

Web setting screen (continued)

System

This menu has items that relate to the genlock phase adjustment and camera's output image settings.

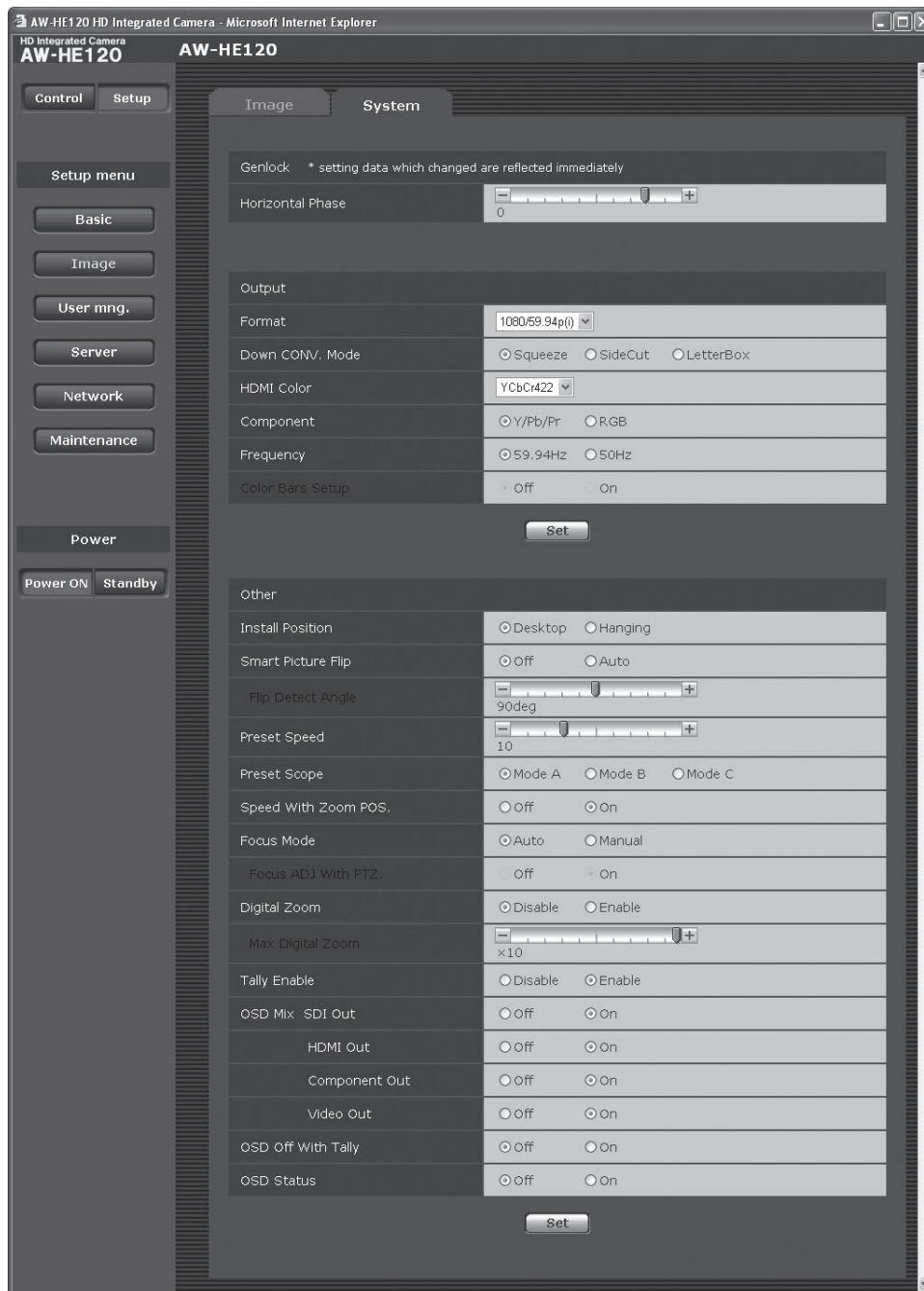

- **Genlock**

This item's setting is reflected immediately.

Horizontal Phase [-206 to +49]

This is used to adjust the horizontal phase during genlock.

Note

- The horizontal phases of the HD and SD signals cannot be adjusted separately. Neither is it possible to adjust the chroma phase of the VIDEO OUT signals. The free run setting is used.

Web setting screen (continued)

● Output

This item's setting is reflected when the Set button is pressed.

Format

[1080/59.94p(i), 1080/59.94i, 720/59.94p, 480/59.94p(i), 480/59.94i, 1080/50p(i), 1080/50i, 720/50p, 576/50p(i), 576/50i]

The video format is changed on this screen. In the case of the 1080/59.94p(i) or 1080/50p(i) format, the P signal is output to the HDMI connector, and the I signal is output to the SDI output and analog component output connectors.

Down CONV. Mode

[Squeeze, SideCut, LetterBox]

The down-conversion mode is selected here.

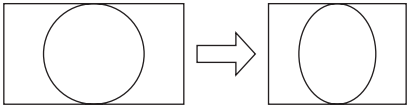
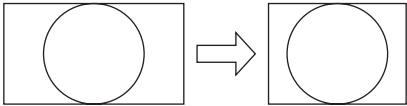
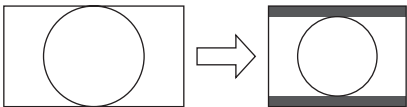
Squeeze	<p>This setting is used when the aspect ratio of the monitor is to be set to 16:9. If the monitor is set to the 4:3 aspect ratio, the images will be squeezed in the width direction and extended in the height direction.</p> 
SideCut	<p>This setting is used when the aspect ratio of the monitor is to be set to 4:3. With the vertical height serving as the reference, the parts which extend beyond this at the two sides are cropped changing the view of the angle.</p> 
LetterBox	<p>This setting is used when the aspect ratio of the monitor is to be set to 4:3. With the horizontal width serving as the reference, black bands are added at the top and bottom changing the view of the angle.</p> 

- When output is selected for the color bar, the mode is fixed to Squeeze.

HDMI Color

[RGB-NOR, RGB-ENH, YCbCr422, YCbCr444]

Set here is the HDMI color output.

- When an HDMI monitor is used, use "YCbCr422" under normal circumstances.
- In cases where, for instance, HDMI (RGB) signals are converted and output to a DVI monitor, the settings required will differ depending on the color gradation supported by the monitor.

RGB-NOR	The RGB output signals are output in the 16 to 235 range.
RGB-ENH	The RGB output signals are output in the 0 to 255 range.

- If the black parts of the images appear overexposed when "RGB-NOR" has been selected, use the "RGB-ENH" setting instead.
- Conversely, if the images are displayed with a loss of dark detail when "RGB-ENH" has been selected, use the "RGB-NOR" setting instead.

Note

- If an HDMI Color setting which is not supported by the monitor has been specified, the HDMI Color setting may be changed automatically. (The menu display will remain unchanged.)

Component [Y/Pb/Pr, RGB]

Either Y/Pb/Pr or RGB can be selected for the analog component signals.

Frequency [59.94Hz, 50Hz]

This item is selected to switch the frame frequency.

- When the frequency is switched, "Format" is set as follows.

59.94Hz		↔	50Hz	
1080/59.94p(i)			1080/50p(i)	
1080/59.94i			1080/50i	
720/59.94p			720/50p	
480/59.94p(i)			576/50p(i)	
480/59.94i			576/50i	

Color Bars Setup [Off, On]

The setting of this item takes effect only when "59.94Hz" has been selected as the "Frequency" setting.

It enables the color bar setup level (Off: 0.0IRE or On: 7.5IRE) of the video output signals to be selected.

Web setting screen (continued)

- **Other**

This item's setting is reflected when the Set button is pressed.

Install Position [Desktop, Hanging]

"Desktop" or "Hanging" is selected here as the method used to install the unit.

Desktop	Stand-alone installation
Hanging	Suspended installation

- When "Hanging" has been selected, the top, bottom, left and right of the images will be reversed, and up/down/left/right control for panning and tilting will also be reversed.

Smart Picture Flip [Off, Auto]

If, when "Auto" has been set, tilt is set to the angle selected using "Flip Detect Angle", the picture is automatically turned upside down (flipped).

Flip Detect Angle [60° to 120°]

When "Auto" has been selected as the "Smart Picture Flip" setting, the tilt angle at which the picture is to be turned upside down (flipped) can be set here.

Preset Speed [1 to 30]

There are 30 preset pan-tilt operation speeds when regenerating the camera direction and other information which are registered in the preset memory.

Notes

- If a high value is selected for the Preset Speed setting, the image on the screen may shake when operation stops.
- When connecting the unit to the AW-RP655 for use, the "DIAGONAL SPEED (P/T SETTING)" setting of the AW-RP655 takes effect.
To change the Preset Speed, change the AW-RP655 setting.

Preset Scope [Mode A, Mode B, Mode C]

Selected here are the setting items to be recalled when the contents of the preset memory are regenerated.

Mode A	Pan, Tilt, Zoom (including digital zoom), Focus, Iris, Gain, white balance adjustment value
Mode B	Pan, Tilt, Zoom (including digital zoom), Focus, Iris
Mode C	Pan, Tilt, Zoom (including digital zoom), Focus

Speed With Zoom POS. [Off, On]

"Off" or "On" is set here for the function used to adjust the pan-tilt adjustment speed in conjunction with the zoom magnification.

When "On" is set, the panning and tilting operations will become slower in the zoom status.

This function has no effect during preset operations.

Focus Mode [Auto, Manual]

"Auto" or "Manual" is set here for the focusing function.

Auto	The subjects are always brought into focus automatically.
Manual	The focus is operated manually.

Focus ADJ With PTZ. [Off, On]

"Off" or "On" is set here for the function which compensates for out-of-focusing when it occurs during panning, tilting or zooming operations.

When "Off" is set, adjust the focus as required after zooming or set the focus to the auto mode.

This item can be selected only when "Manual" has been selected as the "Focus Mode" setting.

Digital Zoom [Disable, Enable]

"Enable" or "Disable" is set here for the digital zoom function.

If zooming is performed toward the Tele end beyond the maximum position when "Enable" has been selected, the digital zoom can be operated continuously. Zooming will stop temporarily at the position where the optical zoom and digital zoom are switched so after it has stopped at this position, proceed with zooming again.

When the setting is changed to "Disable" while already in the digital zoom region, the zoom will automatically move to the maximum position of the optical zoom.

Notes

- When DRS is enabled, the digital zoom is disabled.
- The digital zoom is set to off when color bars are displayed during digital zooming.

Max Digital Zoom

[x2, x3, x4, x5, x6, x7, x8, x9, x10]

The upper limit for the digital zoom magnification is set here.

Web setting screen (continued)

Tally Enable [Disable, Enable]

“Enable” or “Disable” is set here for the function which turns on or turns off the tally lamp using the tally control signal.

OSD Mix

Whether the camera menus, statuses and other displays are to be turned Off or On can be selected here for each output picture.

SDI Out [Off, On]

HDMI Out [Off, On]

Component Out [Off, On]

Video Out [Off, On]

When “On” is set, the camera menus and statuses are displayed on the output picture targeted by the setting items listed above.

OSD Off With Tally [Off, On]

This is used to enable or disable the function for clearing the camera menu and status displays when the tally signal is received by a command or contact.

When the tally signal is released, the original camera menu displays are restored.

OSD Status [Off, On]

“On” or “Off” is set here for the status display which appears during AWB operations.

Web setting screen (continued)

● User mng.

The authorization of those users who can access the camera from a PC or AW-RP50 and those IP addresses, from which the camera can be accessed, is registered on this screen in order to restrict any other access. The screen itself consists of two tabs, “User auth.” and “Host auth.”

User auth. screen

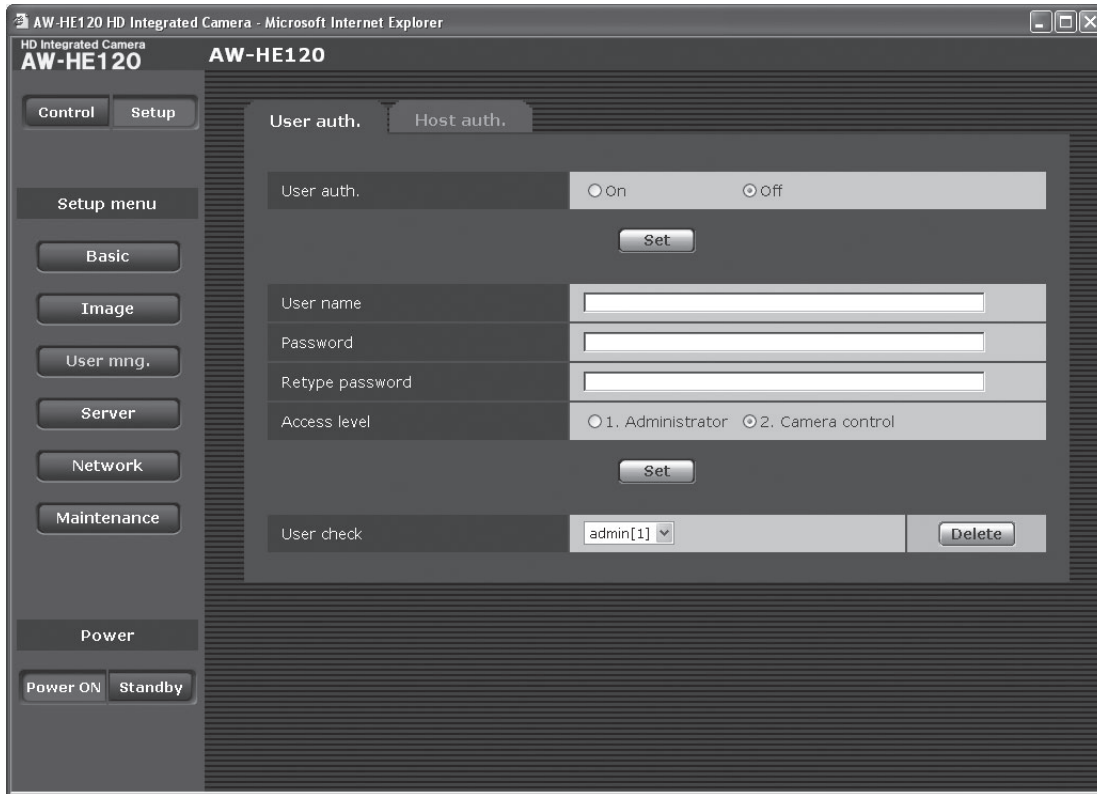

● User auth.

<Initial setting: Off>
User authorization is set to “On” or “Off” here. Enter the setting using the Set button.

Note

- Select the “Off” setting for no user authentication when the AW-RP50 remote camera controller is connected in a network.

● Access level

<Initial setting: 2. Camera control>
Select one of the following settings as the user access level. Enter the setting using the Set button.

1. Administrator	This access level allows the user to perform all the unit’s operations.
2. Camera control	This access level allows only Control screen operations to be performed.

● User name [1 to 32 half-size characters]

<Initial setting: blank>
The user name is input here. Enter the setting using the Set button.

● Password

● Retype password [4 to 32 half-size characters]

<Initial setting: blank>
The password is input here. Enter the setting using the Set button.

● User check

A pull-down menu can be opened here, and the registered users checked. A registered user is indicated in the form of “Registered user name [Access level]”. (Example: admin[1]) To delete a registered user, select the user to be deleted, and click the Delete button on the right.

Web setting screen (continued)

Host auth. screen

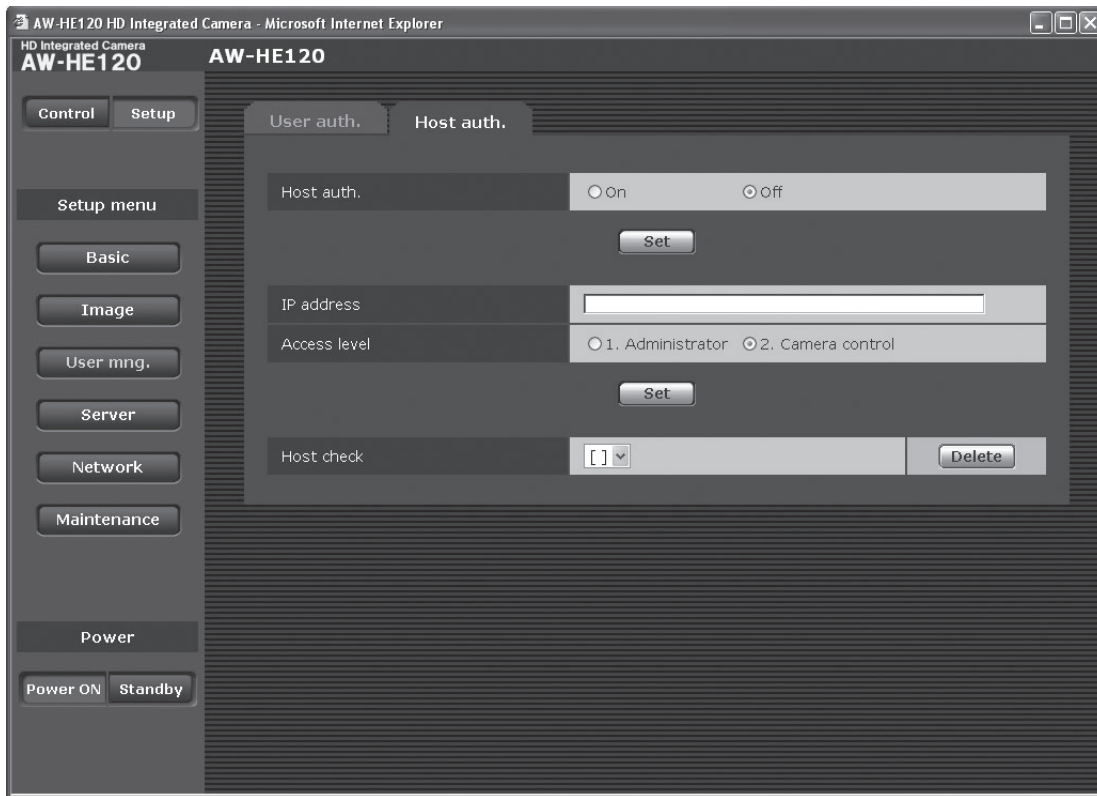

- **Host auth.**

<Initial setting: Off>

Host authorization is set to “On” or “Off” here.

Note

- Select the “Off” setting for no host authentication when the AW-RP50 remote camera controller is connected in a network.

- **Access level**

<Initial setting: 2. Camera control>

Select one of the following settings as the host access level.

- | |
|-------------------|
| 1. Administrator |
| 2. Camera control |

For details on the access level, refer to page 75.

- **IP address**

<Initial setting: blank>

The IP address of the PC from which access to the camera is allowed is input here.

The host name cannot be input as the IP address.

Memo

- When the “IP address/subnet mask length” is input, the PCs which are allowed to access the camera can be restricted on a subnet by subnet basis.
If, for instance, “192.168.0.1/24” has been input and the “2. Camera control” setting has been selected as the access level setting, the PCs from “192.168.0.1” to “192.168.0.254” will be able to access the camera at the “2. Camera control” access level.
- When an already registered IP address is input and the Set button is clicked, the host information will be overwritten.

- **Host check**

A pull-down menu can be opened here, and the IP addresses of the registered hosts checked.

A host is indicated in the form of “Registered IP address [Access level]”.

(Example: 192.168.0.21 [1])

To delete a registered host (IP address), select the host to be deleted, and click the Delete button on the right.

Web setting screen (continued)

● Server

This screen has items that relate to the NTP server addresses, port numbers and other NTP server settings.

NTP screen

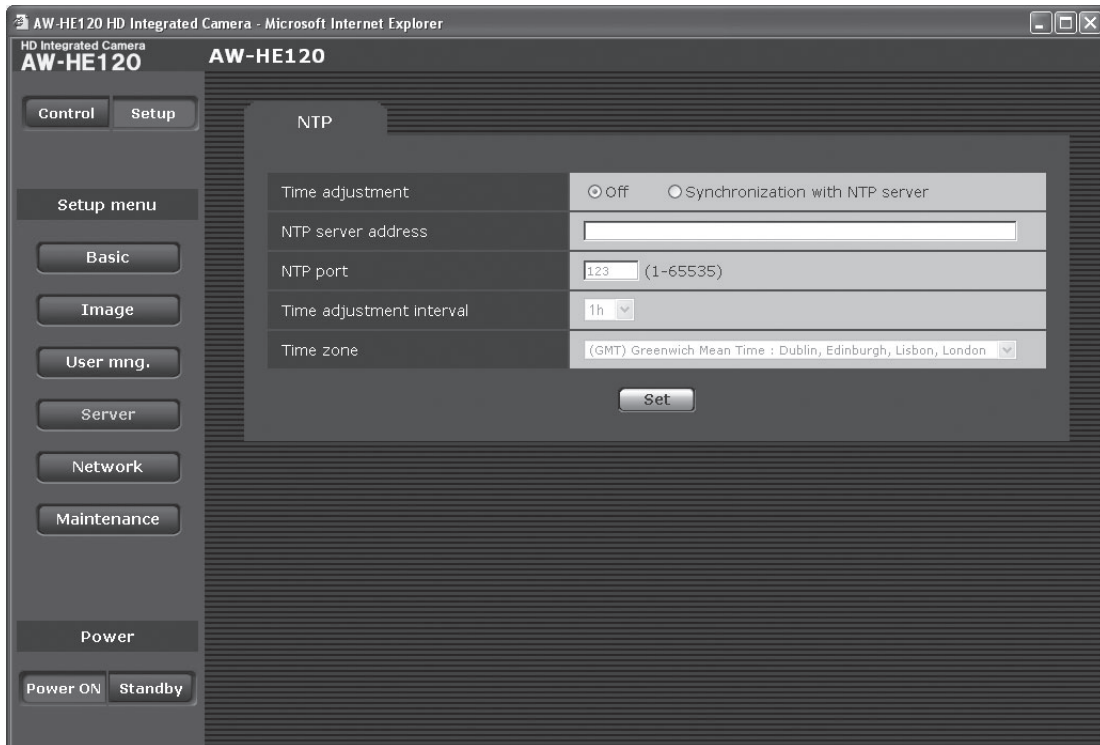

● Time adjustment

<Initial setting: Off>

Select one of the following settings as the time adjustment method.

The time is adjusted by the method selected here and used as the unit's standard time.

Off	The time is counted from 0:00 on January 1, 1990 as the unit's startup time.
Synchronization with NTP server	The time automatically adjusted in synchronization with the NTP server is used as the unit's standard time.

● NTP server address

[1 to 128 half-size characters]

<Initial setting: blank>

The host name or IP address of the NTP server is input here.

Note

- To input the "NTP server address" host name, the DNS setting must be selected on the Network screen (see page 79) of the Network settings.

● NTP port [1 to 65535]

<Initial setting: 123>

The port number of the NTP server is input here.

● Time adjustment interval

<Initial setting: 1h>

The interval (1 to 24 hours in 1-hour increments) for acquiring the time from the NTP server and updating the time is selected here.

● Time zone

<Initial setting: (GMT) Greenwich Mean Time: Dublin, Edinburgh, Lisbon, London>

Select the time zone that corresponds with the region in which the unit is going to be used.

Web setting screen (continued)

● Network

This screen has items that relate to the network settings and SNMP (Simple Network Management Protocol). It consists of the two tabs of “Network” and “SNMP”.

Network screen

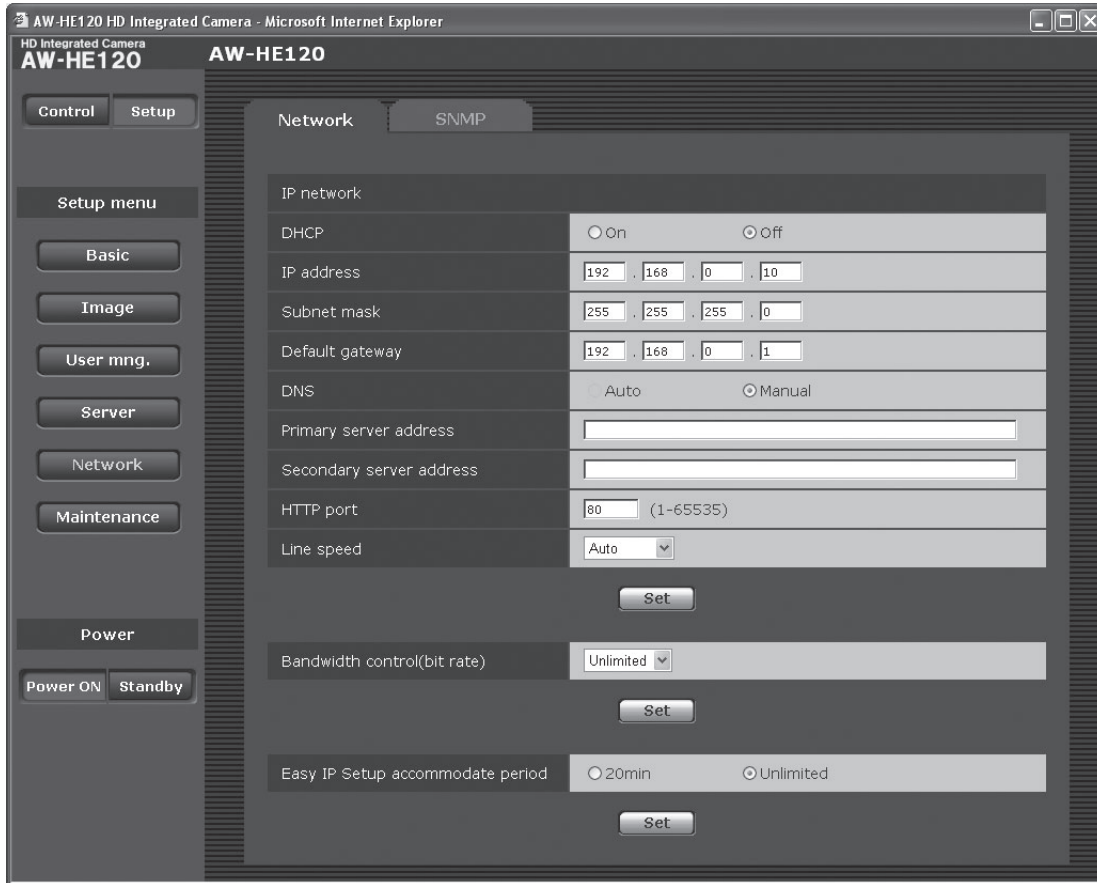

● IP network

DHCP

<Initial setting: Off>

Whether the DHCP function is to be used is set by selecting “On” or “Off” here. Set the DHCP server in such a way that the same IP address cannot be used by PCs without the DHCP function or by other network cameras. For details on the server settings, consult your network administrator.

IP address

<Initial setting: 192.168.0.10>

Input the unit's IP address here when the DHCP function is not going to be used. Input an address that will not duplicate an existing IP address which has been set for a PC or another network camera.

✎ Memo ✎

- Multiple IP addresses cannot be used even when the DHCP function is used. For details on the DHCP server settings, consult your network administrator.

Web setting screen (continued)

Subnet mask

<Initial setting: 255.255.255.0>

Input the unit's subnet mask here if the DHCP function is not going to be used.

Default gateway

<Initial setting: 192.168.0.1>

Input the unit's default gateway if the DHCP function is not going to be used.

Memo

- Multiple IP addresses cannot be used for the default gateway even when the DHCP function is used. For details on the DHCP server settings, consult your network administrator.

DNS

<Initial setting: Manual>

Whether the DNS server address is to be acquired automatically (Auto) or manually (Manual) is input here. If "Manual" has been selected, the DNS settings must be established.

If "Auto" is selected when the DHCP function is going to be used, the DNS server address is acquired automatically.

For further details, consult your system administrator.

Primary server address

Secondary server address

<Initial setting: blank>

Input the IP address of the DNS server if the "Manual" setting has been selected for "DNS".

For details on the IP address of the DNS server, consult your system administrator.

HTTP port [1 to 65535]

<Initial setting: 80>

The port number is allocated here separately.

The following port numbers are used by the unit therefore cannot be used.

Port numbers already used

20, 21, 23, 25, 42, 53, 67, 68, 69,
110, 123, 161, 162, 554, 995, 10669, 10670,
59000 to 59999, 60000 to 61000

Line speed

<Initial setting: Auto>

Select one of the following data line speeds.

Normally, it is recommended that the "Auto" default setting be used.

Auto	The line speed is set automatically.
100 M-Full	The line speed is set to 100 Mbps full duplex.
100 M-Half	The line speed is set to 100 Mbps half duplex.
10 M-Full	The line speed is set to 10 Mbps full duplex.
10 M-Half	The line speed is set to 10 Mbps half duplex.

Bandwidth control(bit rate)

<Initial setting: Unlimited>

Select one of the following data bandwidth settings.

Unlimited	384 kbps	2048 kbps
64 kbps	512 kbps	4096 kbps
128 kbps	768 kbps	8192 kbps
256 kbps	1024 kbps	

Easy IP Setup accommodate period

<Initial setting: Unlimited>

Select "20min" or "Unlimited" as the time for enabling the operation of the network settings from the Easy IP Setup Software.

20min	The setting operations from the Easy IP Setup Software are enabled for 20 minutes after the camera has started operating.
Unlimited	The setting operations from the Easy IP Setup Software are enabled at all times.

Web setting screen (continued)

SNMP screen

The settings related to the SNMP function are selected on this screen.
When the SNMP manager is used for the connection, the unit's statuses can be checked.
When the SNMP function is to be used, consult with your network administrator.

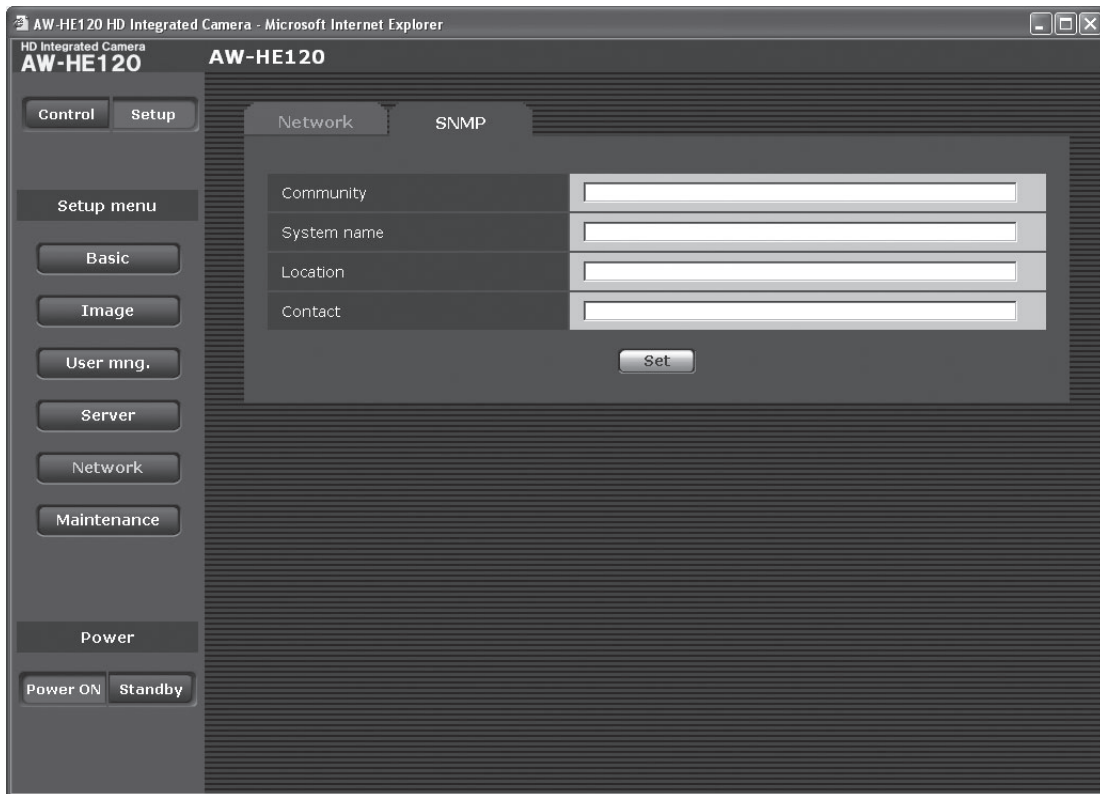

- **Community [0 to 32 half-size characters]**
<Initial setting: blank>
Input here the community name which is to be monitored.

Note

- When using the SNMP function, be absolutely sure to input the community name. This function cannot be used if the community name field is left blank.

- **Location [0 to 32 half-size characters]**
<Initial setting: blank>
Input here the location where the unit has been installed.

- **Contact [0 to 255 half-size characters]**
<Initial setting: blank>
Input here the email address or telephone number of the administrator.

- **System name [0 to 32 half-size characters]**
<Initial setting: blank>
Input here the system name for controlling the unit using the SNMP function.

Web setting screen (continued)

● Maintenance

Among the various maintenance operations performed on this screen are system log checks, system version checks and initialization of the unit.

The screen itself consists of four tabs: "System log", "Product info.", "Default reset" and "Back up".

System log screen

A maximum of a hundred system logs can be stored in the unit's internal memory.

When this maximum number has been exceeded, the old logs are overwritten successively by the new logs.

The logs are cleared when the unit's power is turned off.

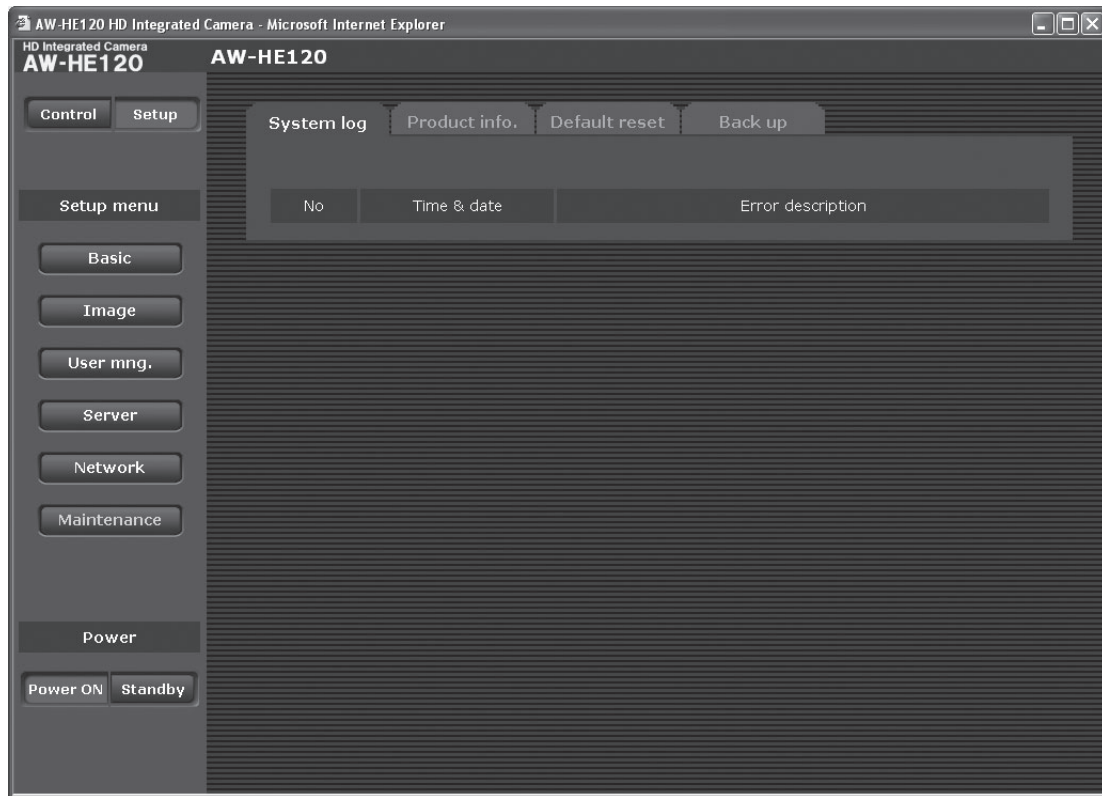

- **No**
The running numbers of the system logs are displayed here.
- **Time & date**
The times and dates when the logs were generated are displayed here.
The 24-hour system is used to display this information.

- **Error description**
Details of the error logs are displayed here.
For further details on the system logs, refer to page 85.

Web setting screen (continued)

Product info. screen

The versions of the unit's software can be checked on this screen.

The "Model no.", "MAC address", "Serial no.", "Firmware version" and other information about the unit is displayed.



- **Model no.**

The unit's model number is displayed here.

- **Mac address**

The unit's MAC address is displayed here.

- **Serial no.**

The unit's serial number is displayed here.

- **Firmware version**

- **CPU Software Interface**

This is selected to display the software version of the interface unit.

- **CPU Software Camera Main**

This is selected to display the software version of the camera unit.

- **CPU Software Servo**

This is selected to display the software version of the servo unit.

- **CPU Software Network**

This is selected to display the software version of the network unit.

- **EEPROM Interface**

This is selected to display the setting data version of the interface unit.

- **EEPROM Camera Main**

This is selected to display the setting data version of the camera unit.

- **FPGA Frontend**

This is selected to display the FPGA version of the front end unit.

- **FPGA Backend**

This is selected to display the FPGA version of the back end unit.

- **FPGA Lens**

This is selected to display the FPGA version of the lens unit.

- **Firmware file**

This is used for maintenance undertaken by the manufacturer.

Do not perform any operations in this field since the unit may end up malfunctioning.

Web setting screen (continued)

Default reset screen

The unit's setting data and HTML files are initialized and the unit is restarted on this screen.

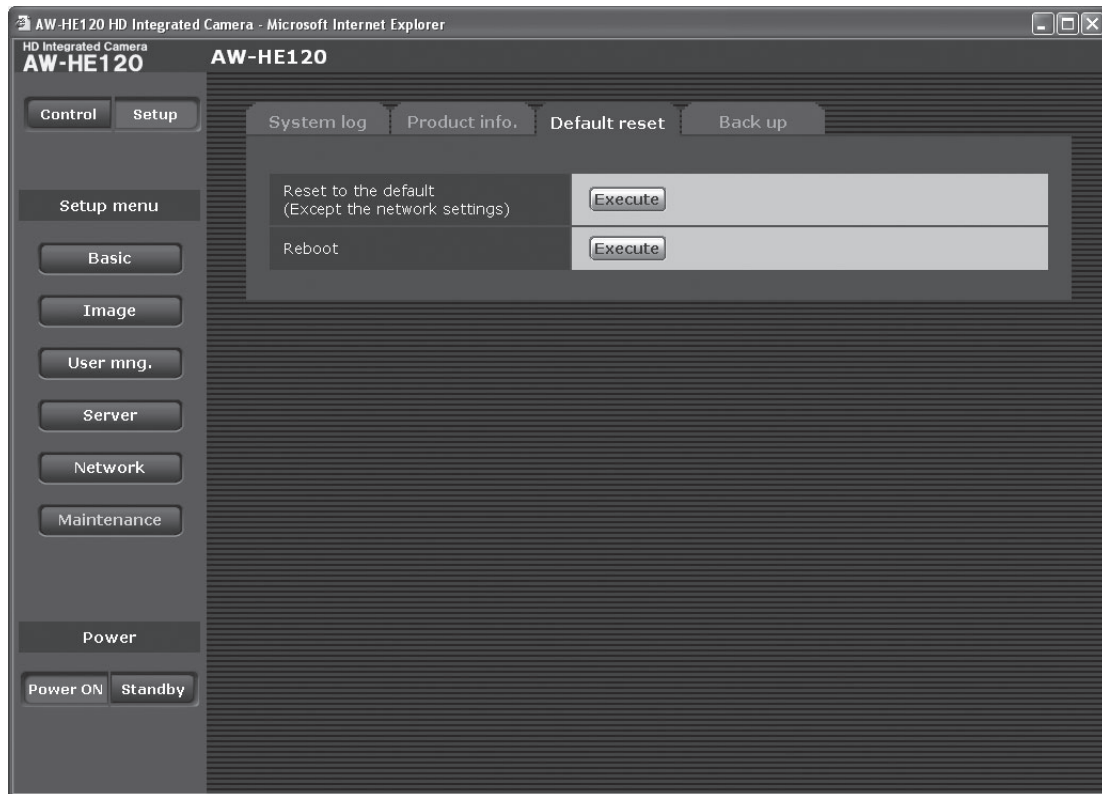

- **Reset to the default**

- **(Except the network settings)**

- When the Execute button is clicked, the unit's settings are returned to their defaults.

- The user name and password used for login are also returned to their defaults (which are "admin" and "12345", respectively).

- However, the network-related settings and the frame frequency (Frequency) and format (Format) settings are not initialized.

- When the initialization operation is started, no operations can be undertaken for about 2 minutes.

- **Reboot**

- When the Execute button is clicked, the unit is rebooted. After the unit has been rebooted, no operations can be undertaken for about 2 minutes as is the case when the unit's power is turned on.

Web setting screen (continued)

Back up screen

On this screen, the unit's settings can be saved to a personal computer or settings saved in a personal computer can be loaded into the unit for use.

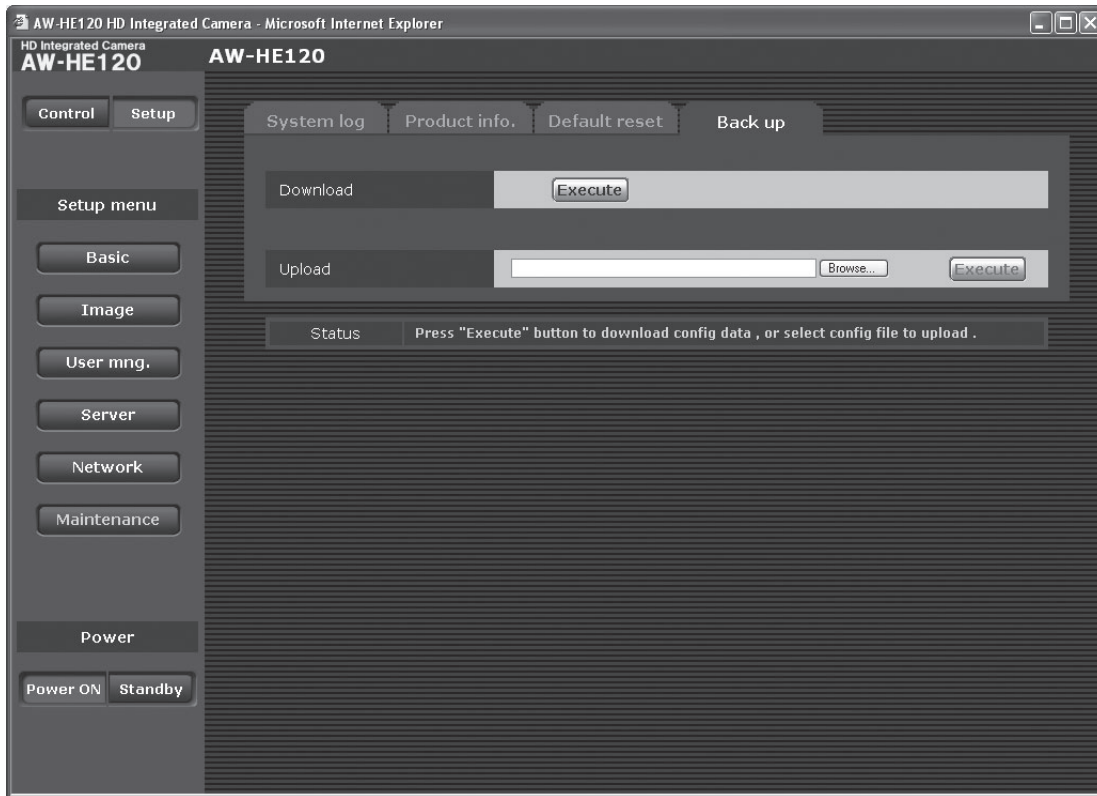

• Download

The unit's settings are saved in the personal computer. After displaying the save destination dialog box using the Execute button, specify the save destination folder. Listed below are the settings to be saved.

- Scene Scene1 settings
- Scene Scene2 settings
- Scene Scene3 settings
- Scene Scene4 settings
- System settings
- Preset settings

Memo

- It takes about 10 seconds after the Execute button has been clicked for the save destination dialog box to appear.

• Upload

The unit's setting files, which were saved in the personal computer by the download function, are uploaded. Click the Browse button to display the dialog box, and specify the saved file. Uploading starts when the Execute button is clicked. About 30 seconds later, the screen is reloaded automatically, and the uploading is completed.

Notes

- Use the files downloaded by the unit as the data to be used for uploading. Do not change the extension (.dat) of the files which have been downloaded.
- Do not turn off the unit's power while downloading or uploading is underway.
- Do not attempt to perform any operations while downloading or uploading is underway. Instead, wait until the downloading or uploading is completed.

System log displays

NTP-related error displays

Category	Display	Description of error
Connection error	No response from the NTP server.	<ul style="list-style-type: none">• The IP address of the server may be incorrect. Check the server's IP address settings again.• The NTP server may be down. Consult your server administrator.
Internal error	Undefined error.	<ul style="list-style-type: none">• A problem has occurred in the NTP function. Check the NTP settings again.
Successful NTP-based time synchronization	NTP update succeeded.	<ul style="list-style-type: none">• The time has been updated successfully.

Login-related displays

Category	Display	Description of error
Login	(User name or IP address)	<ul style="list-style-type: none">• If user authorization has been set, the name of the user who has logged onto the unit is displayed.• If host authorization has been set, the IP address of the user who has logged onto the unit is displayed.

Limiters

This unit comes with settings (referred to as “limiters”) that restrict the panning and tilting movement ranges.

Depending on the installation locations, obstacles may exist in the travel range, and the remote camera may make contact with them.

In cases like this, contact can be prevented by setting the limiters just before the obstacles.

The positions of four limiters — namely, the upper, lower, left-most and right-most limits of the travel range — can be set. Once they have been set, the positions will not be lost even after the power has been turned off.

The limiters can be set or released both by the wireless remote control and controller or web setting screen. Whatever was set or released last takes precedence. For the controller operations, refer to the Operating Instructions of the controller.

The settings of the limiters using the wireless remote control will be described here.

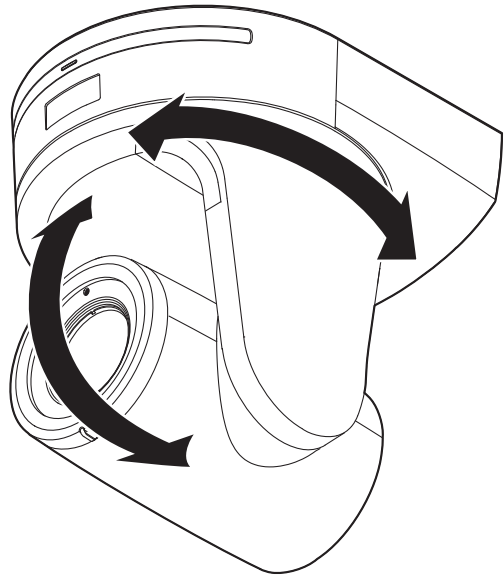

Setting/releasing the limiters

■ Basic limiter operations

1 Press the [MENU] button.

Tap the button (rather than pressing it). When it is pressed for 2 seconds, the camera menu will appear. If this happens, press the [MENU] button again for 2 seconds to clear the camera menu. Then start again from step 1.

2 Press the [▲], [▼], [◀] or [▶] button for 2 seconds while holding down the [PRESET] button.

The limiter for the upper limit, lower limit, left limit or right limit is set (or released) using these direction buttons, respectively.

The tally lamp will blink at this time.

When a limiter is set, it blinks once; when a limiter is released, it blinks twice.

If any other button was operated between steps 1 and 2, start again from step 1.

■ Setting the limiters

The limiter positions can be set by following the steps below. When the position is set, the tally lamp blinks once.

1 Press one of the [CAM1] to [CAM4] buttons to select the unit.

- **Setting the upper limit position of the movement range**

Press the [▲] or [▼] button of the wireless remote control to turn the unit as far as the position which will serve as the upper limit.

Next, perform the steps in “Basic limiter operations”. (Press the [MENU] button quickly and then press the [▲] button for 2 seconds while holding down the [PRESET] button.)

- **Setting the lower limit position of the movement range**

Press the [▲] or [▼] button of the wireless remote control to turn the unit as far as the position which will serve as the lower limit.

Next, perform the steps in “Basic limiter operations”. (Press the [MENU] button quickly and then press the [▼] button for 2 seconds while holding down the [PRESET] button.)

- **Setting the left-most limit position of the movement range**

Press the [◀] or [▶] button of the wireless remote control to turn the unit as far as the position which will serve as the left-most limit.

Next, perform the steps in “Basic limiter operations”. (Press the [MENU] button quickly and then press the [◀] button for 2 seconds while holding down the [PRESET] button.)

- **Setting the right-most limit position of the movement range**

Press the [◀] or [▶] button of the wireless remote control to turn the unit as far as the position which will serve as the right-most limit.

Next, perform the steps in “Basic limiter operations”. (Press the [MENU] button quickly and then press the [▶] button for 2 seconds while holding down the [PRESET] button.)

Setting/releasing the limiters (continued)

■ Releasing the limiters

The limiter positions that are set can be released by following the steps below.

When the position is released, the tally lamp blinks twice.

- 1 Press one of the [CAM1] to [CAM4] buttons to select the unit.**
- 2 Release the limiters by taking the steps below.**

- **Releasing the upper limit position of the movement range**
Perform the steps in “Basic limiter operations”.
(Press the [MENU] button quickly and then press the [▲] button for 2 seconds while holding down the [PRESET] button.)
- **Releasing the lower limit position of the movement range**
Perform the steps in “Basic limiter operations”.
(Press the [MENU] button quickly and then press the [▼] button for 2 seconds while holding down the [PRESET] button.)
- **Releasing the left-most limit position of the movement range**
Perform the steps in “Basic limiter operations”.
(Press the [MENU] button quickly and then press the [◀] button for 2 seconds while holding down the [PRESET] button.)
- **Releasing the right-most limit position of the movement range**
Perform the steps in “Basic limiter operations”.
(Press the [MENU] button quickly and then press the [▶] button for 2 seconds while holding down the [PRESET] button.)

■ Resetting the limiters

To reset the limiters, the currently established settings must be released.

The limiter positions that are set can be reset by following the steps below.

- 1 Release the settings of the limiter positions to be reset by following the steps in “Releasing the limiters”.**
- 2 Set the limiter positions by following the steps in “Setting the limiters”.**

Safe mode

■ Concerning the safe mode

The unit goes into the safe mode when the pan-tilt head is forcibly moved by an external force or when something impedes its rotation.

Once the safe mode has been established, some or all of the operations will no longer be acknowledged to ensure safety and prevent equipment damage.

■ Detection of equipment trouble

When the unit has detected trouble, its functions are shut down, then the unit is restarted or the initial setting operation is performed, and the normal condition of the unit is restored after about 30 seconds.

Note

- When trouble is detected, pictures may no longer be output for a while, but they will be restored in 5 seconds to 10 seconds.

■ Cooling fan

There is a cooling fan inside.

The cooling fan is a consumable part.

Replace it 3 to 5 years after installation as a general rule.

When the cooling fan malfunctions, the "Fan Error" message is displayed when the power is turned ON.



When the "Fan Error" message is displayed, request replacement of the cooling fan.

(Whenever fan replacement is necessary, be sure to ask your dealer.)

Notes on Windows Vista® / Windows® 7

When using Microsoft® Windows Vista® or Microsoft® Windows® 7, symptoms described in this document may happen.

If any of them occurred, follow the instructions to solve each problem.

The symptoms that happen when using Windows Vista® may also happen when using Windows® 7.

If using Windows® 7, refer to the section “Precautions when using Windows Vista” in addition to the section “Precautions when using Windows 7” in this document.

This document describes solutions for administrators.

- If necessary, install the viewer software.
Refer to the Operating Instructions of each device for details on how to install the viewer software.
- Descriptions in this document are based on operation check by Panasonic Corporation.
Possible symptoms may vary depending on platforms or operating system versions, etc.

■ System requirements for a PC

Refer to the section “Required personal computer environment” in the installation guide or Operating Instructions provided with the product to be used for further information about the recommended specifications of a PC.

In case there are no descriptions of Windows Vista® or Windows® 7, refer to the following.

CPU	Intel® Core™ 2 Duo 2.4 GHz or faster	
Memory	1 GB or more	
Network interface	10BASE-T/100BASE-TX 1 port	
Monitor	1024 × 768 pixels or more, 24-bit True color or better	
OS and web browser	Windows® 7 Professional SP1 64-bit*1	Windows® Internet Explorer® 8.0*2
	Windows® 7 Professional SP1 32-bit*1	Windows® Internet Explorer® 9.0*2
	Windows Vista® Business SP2 32-bit	Windows® Internet Explorer® 7.0

*1: Windows® XP compatibility mode is unavailable.

*2: Internet Explorer® 8.0 64-bit version is unavailable.

■ Trademarks and Registered Trademarks

- Microsoft, Windows, Windows Vista, Windows 7 and Internet Explorer are registered trademarks of Microsoft Corporation in the United States and other countries.
- Intel and Intel Core are trademarks or registered trademarks of Intel Corporation in the United States and other countries.
- Trademarks and registered trademarks are abbreviated in the subsequent descriptions in this document.

■ Precautions when using Windows Vista

Symptom 1

- When accessing the web browser, the following message is displayed on the information bar. “Pop-up blocked. To see this pop-up or additional options click here...”

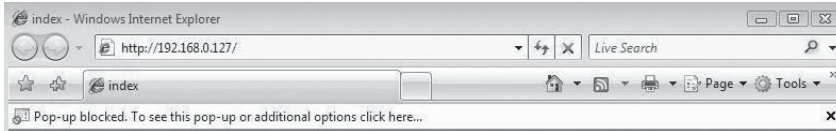

Solution

Add the IP address of the product to “Trusted sites”, and perform the security setting.

- ① Start up the web browser, and click “Internet Options” on the Tools menu.
- ② Click the [Security] tab. Then, select the “Trusted sites”. (Refer to the screenshot.)
- ③ Select “Low” for “Security level for this zone”. (If the lower setting is selected, the security level of PC will go down.)
- ④ Click the [Sites] button to open the “Trusted sites” window.
- ⑤ Enter the IP address in the textbox “Add this website to the zone:”, and click the [Add] button.
Note: Make sure “Require server verification (https:) for all sites in this zone” is unchecked. (Refer to the screenshot.)
- ⑥ After adding all IP addresses, click the [Close] button to close the “Trusted Sites” window.

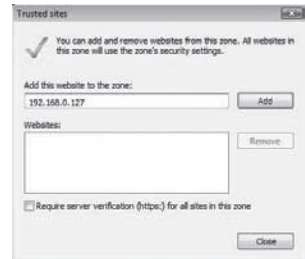

Notes on Windows Vista® / Windows® 7 (continued)

Symptom 2

- Easy IP Setup Software does not display the detected IP address.

Solution

Check the firewall settings. If firewall is activated, add the web browser or Easy IP Setup Software to the [Exceptions] tab on the “Windows Firewall Settings” menu.

- ① Open the control panel, and click “Security”.
- ② Click “Allow a program through Windows Firewall” of “Windows Firewall”. (Refer to the screenshot.)



- ③ Click the [Continue] button on the “User Account Control” window.
- ④ Click the [Exceptions] tab on the “Windows Firewall Settings” windows. Check “Internet Explorer” or “easyipsetup.exe”. (Refer to the screenshot.)
- ⑤ Click the [OK] button.

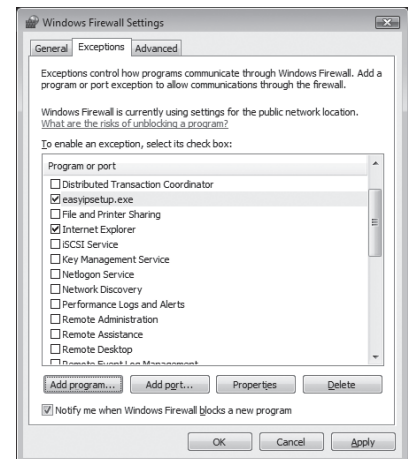

Symptom 3

- When starting the Easy IP Setup Software, a message is displayed to request the password of administrator.
- When exiting the Easy IP Setup Software, the message “This program might not have installed correctly” is displayed.

Solution

Turn off User Account Control (UAC) from the control panel of Windows Vista.

- ① Open the control panel, and click “User Accounts”.
- ② Select “User Accounts” from “User Accounts”.
- ③ Click “Turn User Account Control On or Off”.
- ④ Click the [Continue] button on the “User Account Control” window.
- ⑤ Uncheck “Use User Account Control (UAC) to help protect your computer”. (Refer to the screenshot.)
- ⑥ Click the [OK] button.



Notes on Windows Vista® / Windows® 7 (continued)

Symptom 4

- The screens of the administrator console or the windows of the browser are not displayed properly. (Refer to the screenshot.)



Solution

Check the font size (DPI) of screenshot by clicking “Personalize”– “Adjust font size (DPI)”. If the DPI is set to “Larger scale”, set to “Default scale”.

- Right-click on the desktop.
- Click “Personalize”.
- Click “Adjust font size (DPI)”.
- Click the [Continue] button on the “User Account Control” window.
- Click “Default scale” on the “DPI Scaling” window, and restart the PC. (Refer to the screenshot.)

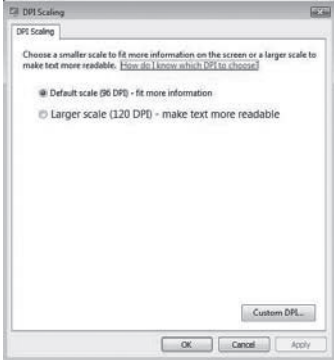

Restrictions

Restriction 1	When two browser windows are open and one is being displayed on another The back window may come to the front when the mouse pointer is placed.
Restriction 2	When accessing this product from the web browser Another window may open, and pop-up may be displayed.

■ Precautions when using Windows 7

Symptom 1

- Screen is deformed. / When activating the compatibility view, part of the screen is not displayed or a pop-up window appears to say that the screen is not displayed again.

Solution

Check “Display all websites in Compatibility View” on the “Compatibility View Settings” window.

- ① Start up the web browser, and click “Tools” on the menu bar.
- ② Click “Compatibility View Settings”.
- ③ Check “Display all websites in Compatibility View”, and click the [Close] button.
(Refer to the screenshot.)

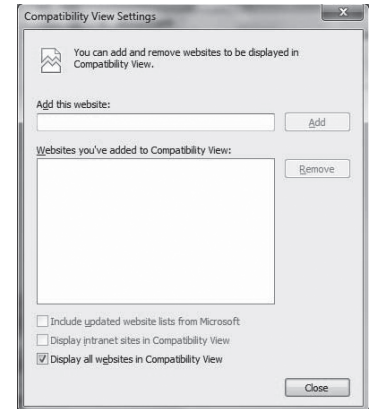

Symptom 2

- Network disconnection occurs when the PC enters the sleep mode.

Solution

After canceling the sleep mode, reload the screen as necessary.

Notes on Windows Vista® / Windows® 7 (continued)

Symptom 3

- The “Program Compatibility Assistant” is displayed after exiting the Easy IP Setup Software. (Refer to the screenshot.)

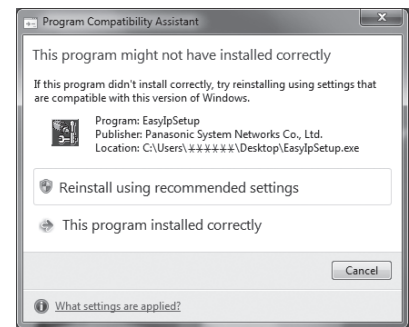

Solution

This symptom happens only when the software has been used for the first time. Select “This program installed correctly”.

● Restrictions

Restriction 1	On the setup pages for some products The display positions of setting items and setting values may not be correspondent.
Restriction 2	When using Windows 7 with some products Two web browser windows may be displayed at the same time.

Index

3

3200K and 5600K presets 24

A

Menu ABB 65

Menu Access level 75, 76

Menu AGC Max Gain 39, 64

Menu Auto F.Mix Max Gain 39, 64

Automatic adjustment (ABB) 25

Automatic adjustment (AWB) 22

Auto tracking white adjustment (ATW) 24

Menu AWB 65

AW-RP50 36

AW-RP555 34

AW-RP655 32

B

Back up screen 84

Menu Bandwidth control(bit rate) 79

Basic button 61

Basic screen 61

Menu B Gain 40, 65

Menu B Pedestal 40, 65

Menu Brightness 38, 60, 64, 69

Brightness screen 38

C

CAM/BAR 57

Menu Camera 37

Camera screen 38

Camera title 61

Camera title display area 61

Changing the format 47

Changing the frequency 48

Menu Chroma Level 40, 65

Menu Color Bars Setup 47, 72

Menu Color Correction 67

Phase 67

Saturation 67

Menu Color Correction 1/2

B_Mg Phase 43

B_Mg Saturation 43

Mg Phase 43

Mg_R Phase 43

Mg_R Saturation 43

Mg Saturation 43

R Phase 43

R Saturation 43

R_YI Phase 43

R_YI Saturation 43

YI Phase 43

YI Saturation 43

Menu Color Correction 2/2

B Phase 44

B Saturation 44

Cy_B Phase 44

Cy_B Saturation 44

Cy Phase 44

Cy Saturation 44

G_Cy Phase 44

G_Cy Saturation 44

G Phase 44

G Saturation 44

YI_G Phase 44

YI_G Saturation 44

Menu Community 80

Menu Component 46, 72

Concerning initialization 52

Menu Contact 80

Control button / Setup button 57

Control pad and its buttons 60, 69

Control screen 59

Menu CPU Software

Camera Main 51, 82

Interface 51, 82

Network 51, 82

Servo 51, 82

D

Menu Default gateway 79

Menu Default Gateway 52

Default reset screen 83

Menu Detail 41, 65

Menu Detail Band 41, 65

Menu DHCP 78

Menu Digital Zoom 49, 73

Menu DNR 42, 66

Menu DNS 79

Menu Down CONV. Mode 46, 72

Menu Download 84

Menu DRS 42, 66

E

Menu Easy IP Setup accommodate period 79

Menu EEPROM

Camera Main 51, 82

Interface 51, 82

Menu Error description 81

F

Fan Error 89

Menu Firmware file 82

Firmware VER 1/2 screen 51

Firmware VER 2/2 screen 51

Menu Firmware version 82

Menu Flesh Tone Noise SUP. 66

Menu FleshTone NoiseSUP. 41

Menu Flip Detect Angle 48, 73

Menu Focus 59, 68

Menu Focus ADJ With PTZ. 49, 69, 73

Menu Focus Mode 49, 73

Menu Format 46, 72

Menu FPGA

Backend 51, 82

Frontend 51, 82

Lens 51, 82

Menu Frame Mix 39, 64

Menu Frequency 46, 72

G

Menu Gain 39, 64

Menu Gamma Level 42, 66

Menu Gamma Type 42, 66

Menu Genlock 45, 71

Genlock screen 45

Index (continued)

H

- Menu** H Detail Level H 41, 65
- Menu** H Detail Level L 41, 65
- Menu** HDMI Color 46, 72
- Menu** Horizontal Phase 45, 71
 - Horizontal phase adjustment 28
- Menu** Horizontal Phase Step 45
- Menu** Host auth. 76
 - Host auth. screen 76
- Menu** Host check 76
- Menu** HTTP port 79

I

- Image 62
- Menu** Image adjust 62
- Image adjust screen 63
- Image screen 62
- Initialize 52
- Menu** Initialize 51
- Menu** Install Position 48, 73
- Menu** IP address 76, 78
- Menu** IP Address 52
- Menu** IP network 78
- Menu** IP Network 51
- IP Network screen 52
- Menu** Iris Mode 38, 64

L

- Menu** Limitation Setting 70
- Menu** Linear Matrix 43, 67
 - B-G 43
 - B-R 43
 - G-B 43
 - G-R 43
 - R-B 43
 - R-G 43
- Menu** Line speed 79
- Menu** Location 80

M

- Menu** Mac address 82
- Maintenance 81
- Menu** Maintenance 37
- Maintenance screen 51
- Menu** Matrix 38, 66
 - Matrix 1/4 screen 42
 - Matrix 2/4 screen 43
 - Matrix 3/4 screen 43
 - Matrix 4/4 screen 44
 - Matrix Settings screen 67
- Menu** Matrix Type 42, 66, 67
- Menu** Max Digital Zoom 50, 73
- Menu** Model no. 82
- Multi-Function Controller 32
- Multi Hybrid Control Panel 34

N

- Menu** ND Filter 39, 64
- Network 78
 - Network screen 78
- Menu** No 81
- Menu** Noise Suppress 41, 66
- Menu** NTP port 77
 - NTP screen 77
- Menu** NTP server address 77

O

- Operation lock button (Op.Lock) 58
- OSD Menu Operation 57
- Menu** OSD Mix
 - Component Out 50, 74
 - HDMI Out 50, 74
 - SDI Out 50, 74
 - Video Out 50, 74
- Menu** OSD Off With Tally 50, 74
- Menu** OSD Status 50, 74
- Menu** Other 45, 73
 - Other 1/3 screen 48
 - Other 2/3 screen 49
 - Other 3/3 screen 50
- Menu** Output 45, 72
 - Output screen 46

P

- Menu** Password 75
- Menu** Pedestal 40, 65
- Menu** Phase 43, 44
- Menu** Picture 38, 65
 - Picture 1/3 screen 40
 - Picture 2/3 screen 41
 - Picture 3/3 screen 42
- Menu** Picture Level 38, 64
- Power ON button / Standby button 58
- Menu** Preset 60, 68
 - Preset memories 19
- Menu** Preset position 62
 - Preset position screen 68
- Menu** Preset Scope 49, 70, 73
- Menu** Preset Setting 70
- Menu** Preset Speed 48, 70, 73
- Menu** Primary server address 79
- Product info. screen 82

R

- Menu** Reboot 83
- Remote Camera Controller 36
- Menu** Reset to the default 83
- Menu** R Gain 40, 65
- Menu** R Pedestal 40, 65

Index (continued)

S

Menu	Saturation	43, 44
Menu	Scene	38, 60, 63
Menu	Secondary server address	79
Menu	Serial no.	82
	Server	77
	Setup screen	61
Menu	Shutter Mode	38, 64
	Shutter speed	17, 39, 64
Menu	Smart Picture Flip	48, 73
	SNMP screen	80
Menu	Speed	60, 69
Menu	Speed With Zoom POS.	49, 69, 73
Menu	Step/Synchro	39
Menu	Subnet mask	79
Menu	Subnet Mask	52
Menu	System	37
	System log screen	81
Menu	System name	80
	System screen	45, 71

T

Menu	Tally Enable	50, 74
Menu	Time adjustment	77
Menu	Time adjustment interval	77
Menu	Time & date	81
Menu	Time zone	77
Menu	Top Menu	37
	Top Menu screen	37
	Tri-level sync signal	28

U

Menu	Upload	84
Menu	User auth.	75
	User auth. screen	75
Menu	User check	75
	User mng.	75
Menu	User name	75

V

Menu	V Detail Level H	41, 65
Menu	V Detail Level L	41, 65

W

Menu	White Balance Mode	40, 65
Menu	Wireless Control	50

Z

Menu	Zoom	59, 68
-------------	------------	--------

