

Console 1

User Manual

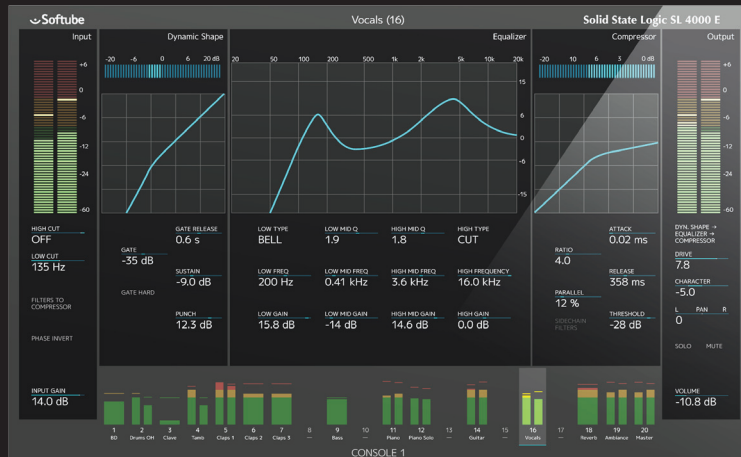

 **Softube**

User Manual

Supporting VST/VST3/AU/AAX Native. Rev. Feb 11, 2014

Softube User Manual

© 2007-2014. Amp Room, Console 1 is trademarks of Softube AB, Sweden. Softube is a registered trademark of Softube AB, Sweden. All visual and aural references to the Valley People Dyna-mite, Trident A-Range, Tonelux and Tilt are trademarks being made with written permission from PMI Audio. The Tonelux and Tilt logo, the Valley People, Dyna-mite and associated logos, and the Trident, A-Range and Triangle logo are trademarks of PMI Audio Group, used under license. Tube-Tech is a registered trademark of Lydkraft ApS, Denmark. EMI and Abbey Road are trademarks of EMI (IP) Limited. REDD, RS127 and RS135 are trademarks of EMI (IP) Limited. SSL, Solid State Logic, SL 4000 E are all trademarks of Solid State Logic, UK, used with written permission. All specifications subject to change without notice. All Rights Reserved.

Other company and product names mentioned herein are trademarks of their respective companies. Mention of third-party products is for informational purposes only and constitutes neither an endorsement nor a recommendation. Softube assumes no responsibility with regard to the performance or use of these products.

Softube products are protected by patents SE526523 and SE525332, and related patents/patent applications, including WO06054943, US11/667360, US20040258250, EP1492081, EP1815459, and JP2004183976.

Your rights to the software are governed by the accompanying software license agreement (End User License Agreement).

Disclaimer

Every effort has been made to ensure that the information in this manual is accurate. However, there are a chance that we have made mistakes, and we hope that you understand that we are only humans. Please let us know about the mistake, and we'll fix it in the mix (or in the next version of this manual).

Support

On the Softube website (www.softube.com) you will find answers to common questions (FAQ) and other topics that might interest you.

Support questions can be posted at <http://www.softube.com>, where we will help you as fast as we can!

Web: www.softube.com

E-mail: info@softube.com

Phone: +46 13 21 1623 (9 am – 5 pm CET)

Contents

1	<i>Introduction and overview</i>	5		
	The SSL SL 4000 E Channel	5		
	Console 1 Compared to Traditional Mixers	6		
2	<i>Getting started</i>	9		
	Setting Up Your First Console 1 Session	9		
	Input Section	14		
	Shape Section	15		
	Equalizer Section	16		
	Compressor Section	18		
	Output Section	19		
3	<i>Working with Console 1</i>	21		
	Track Selection	22		
	On-Screen Display.	22		
	The Input Section	24		
	Shape	26		
	Equalizer	28		
	Compressor.	30		
	The Output section	32		
	Understanding Solo Safe.	33		
4	<i>Useful Functions</i>	35		
	Select All Tracks	35		
	Create a Group	35		
	Duplicate Track Settings	36		
	Load and Save Presets	38		
	History.	39		
	MIDI Controller Mode	39		
	Using Console 1 Without the Hardware	40		
	Automation	40		
5	<i>Customizing the Channel Strip</i>	41		
	Loading Other Channel Strips and Effects	41		
	Changing the Order of the Sections	42		
	Using External Sidechain Signals	42		
	View Options	43		
6	<i>Specifications, Requirements and Troubleshooting</i>	45		
	System Requirements	45		
	Block Diagram	46		
	Troubleshooting	47		
	Hardware Specifications	48		
7	<i>END USER LICENSE AGREEMENT</i>	xlix		



1

Introduction and overview

Softube Console 1 is a new type of audio mixer. It is used together with your favorite digital audio workstation (DAW), and just like a traditional mixing console, you can route any or all DAW tracks to Console 1 and mix them from within that system. This gives you access to Console 1's world class sounding effects sections and lets you control everything from the hardware unit, using physical knobs and buttons.

So what Console 1 gives you is the great sound that has made Softube world famous, in addition to a tactile and intuitive workflow that speeds up your mix work substantially compared to mouse mixing on the computer.

The SSL SL 4000 E Channel

Included in your purchase is Softube's model of a Solid State Logic SL 4000 E, one of the most famous and coveted mixing consoles in the world. SL 4000 E consoles have been installed in hundreds of the world's leading studios, and it is said that Solid State

Logic's 4000 series have been used on more platinum selling records than all other console models combined! This is for good reason. The SL 4000 E has a signature sound that is transparent enough to work for all music styles, but still adds its touch of luxury. Things simply sound like a record when they've been run through the SL 4000 E.

With Console 1, you get the famous black knob E242 equalizer, the classic channel compressor, the very musical gate/expander and the sweet high/low cut filters from the SL 4000 E channel. We also modeled the unique harmonics, distortion and non-linearities you get from running the SL 4000 E into overdrive. Controlled by Console 1's Drive knob, you can use it subtly on all channels to glue the mix together like a slightly overdriven SL 4000 E does, or not so subtly to add edge and presence to selected sounds.

In addition, you get Softube's unique Transient Shaper, which is not modeled off the Solid State Logic SL 4000 E or any other unit for that matter. Read more about Transient Shaper in "Shape" in Chapter 4.

Softube's model of the Solid State Logic SL 4000 E channel is only available as part of the Console 1 system and not as a single plug-in. Softube will continuously release more channel strip models

to be used with Console 1, that can be purchased separately.

Console 1 Compared to Traditional Mixers

To understand what Console 1 is, it may be helpful to compare it to existing mixer types. There are quite a few differences between Console 1 and most traditional mixers—both digital and analog ones.

First of all, Console 1 is strictly made for mixing, it's not a recording mixer with microphone preamplifiers. With Console 1, you have access to one channel at the time, the one you have selected with the corresponding channel selector button on the hardware unit. This gives the hardware unit a small footprint, but still offers direct access to more functions and effects per channel compared to most physical mixing consoles—as mentioned in the previous section, equalizer, compressor, distortion, gate, high and low cut filters and our Transient Shaper. All Console 1 settings are saved with your DAW session for total recall, and each parameter can be automated using the hardware knobs. You can open a DAW session mixed using Console 1 without having the Console 1 hardware connected, and you can even adjust settings using the mouse if you happen to be away from your Console 1 hardware.

Furthermore, the Console 1 hardware has no on-board DSP power, all the audio processing takes place within your computer. This has several advantages compared to a physical mixer, such as portability, lower cost and no need for an external power supply—the Console 1 hardware is USB



Solid State Logic SL 4000 E was introduced in 1980 and is to this day used in a large number of high end studios all over the world. Softube's model includes the most sought after equalizer version, the black knob E242.

powered.

The Console 1 software is also very CPU efficient, but please refer to “System Requirements” on page 45 to see if your computer is powerful enough to use with Console 1.

And obviously, most mixers are contained in one single hardware unit. The Console 1 system consists of three different components that work in tight integration: the hardware, the On-Screen Display and the DAW plug-in.

One might say there is also a fourth component, namely the channel strip or single effect you have loaded into the separate Console 1 tracks. If you're new to Console 1, the channel strip will be the SSL SL 4000 E that is included in the purchase. There will be more plug-in channel strips for Console 1 such as that one, that can be purchased separately. And you can also load other Softube plug-ins into the system. See “Loading Other Channel Strips and Effects” in Chapter 6 of this manual.

2 Getting started

In order to install the required software and activate your license, first make sure your computer has internet access. Use any browser to visit the page

www.softube.com/console1-install

Here, you will be guided through all the necessary steps. You will be asked to enter the unique license code printed on the Quick Start guide that is enclosed in the Console 1 shipping box.

Setting Up Your First Console 1 Session

When you have gone through the registration process on Softube's web site, you are ready to set up your basic Console 1 session. You may want to save this as a template session in your DAW, so you will not have to do this for every new piece of music you start working on. Please refer to your DAW's manual on how to save a template session, as well as any other steps mentioned below that refer to actions in your DAW.

1. Connect the Console 1 hardware to an unoccupied USB port on your computer. The Softube logo in your computer's control panel will turn from grey to black.
2. Launch your preferred digital audio workstation (DAW) application. Console 1 runs with any host that supports VST2, VST3, AAX and Audio Units plug-in formats
3. Launch an empty session in your DAW.
4. Insert the Console 1 plug-in on as many tracks as you like. We recommend inserting it on all single tracks, aux channels and buses.

The audio on any track where you have inserted the Console 1 plug-in will now be

routed into the Console 1 system and back to the same DAW channel. See next section for setting the correct track name and number.

Track Name and Number

Some DAWs support automatically transferring track name and number from the DAW tracks to the corresponding Console 1 tracks. You can verify this by opening the Console 1 plug-in window on any channel in your DAW. In the lower right part of this window, you will see either “Auto” or “Manual”. “Auto” indicates that the track name and number is automatically transferred from your DAW to Console 1. In this case, you will now be able to open Console 1’s On-Screen Display (by pushing the Display On button in the top left corner of the hardware) and see all the tracks laid out just as they are in your DAW session.

In the “Manual” case, you will need to manually select to which Console 1 track the Console 1 plug-in routes the DAW channel’s audio, and also manually enter the track name for it to display in the Console 1 system. Follow these steps to set the track number:

1. Open the Console 1 plug-in window and click the track number.
2. On the Console 1 hardware, press the track selector button that corresponds to the track you would like to route the DAW signal to. The track number in the plug-in window now also corresponds to the track you selected.

Here’s a tip if you are using a DAW that doesn’t support automatic transferring of track name and number: Any time you instantiate a Console 1 plug-in, it will by default select the lowest numbered available Console 1 track. So if you start by instantiating the Console 1 plug-in on your DAW track 1, that track will be assigned to the Console 1’s track 1—since this is the lowest numbered available

track. If you then instantiate the Console 1 plug-in on the DAW track 2, this track will be assigned to Console 1’s track 2, next will be track 3 and so on.

To set the track names:

1. Open each Console 1 plug-in in your DAW and click the text “Click here to set track name”.
2. This will reveal a text field, in which you can enter the desired track name using your computer keyboard.
3. When you are done, click OK and move on to the next Console 1 plug-in you would like to name.

Solo Safe on Aux Channels and Buses

As mentioned above, we recommend that you insert the Console 1 plug-in on all your DAW channels, including single tracks, aux channels and buses. But in order for Console 1’s **Solo** function to work as expected, you should set aux channels, effects send channels, subgroup buses and the master bus—essentially, any channels in your DAW mixer that are not single audio or software instrument tracks—to **Solo Safe**. If you are using an aux channel for the incoming sound of a Rewire sound source, such as Propellerheads Reason, this can however be viewed as an instrument track. We consequently recommend you do not set this to **Solo Safe**.

See “” on page 33 if you’re interested in why this setting is needed for Console 1’s **Solo** function to behave as expected. Otherwise, simply follow these steps:

- Open the Console 1 plug-in on all aux channels (except Rewire aux channels that handle incoming sound signals), effects channels, subgroup buses and the master bus in your DAW.
- Activate **Solo Safe** setting by clicking this but-

ton in the plug-in window.

Any time you press **Solo** on the Console 1 hardware, the text "SOLO SAFE" will appear in the On-Screen Display above any channel that has been set to SOLO SAFE.

Track Number This is automatically set to correspond to the DAW track, in DAWs that support this function. If your DAW does not support automatic transfer of the track number, click the number set this manually.

Track Name This is automatically set to correspond to the DAW track, in DAWs that support this function. If your DAW does not support automatic transfer of the track name, click the name to set this manually.

Show Knobs Click to open an interface that resembles the Console 1 hardware. Here, you can adjust the settings using a computer mouse.

Solo Safe Clicking this excludes the track/channel from **Solo**. When another track is set to solo, **Solo Safe** channels will not be silenced. This option is recommended for all aux channels, subgroups and the master bus.

Auto or Manual Indicates if your DAW supports automatic transfer of track number and name, or if you need to set this manually.

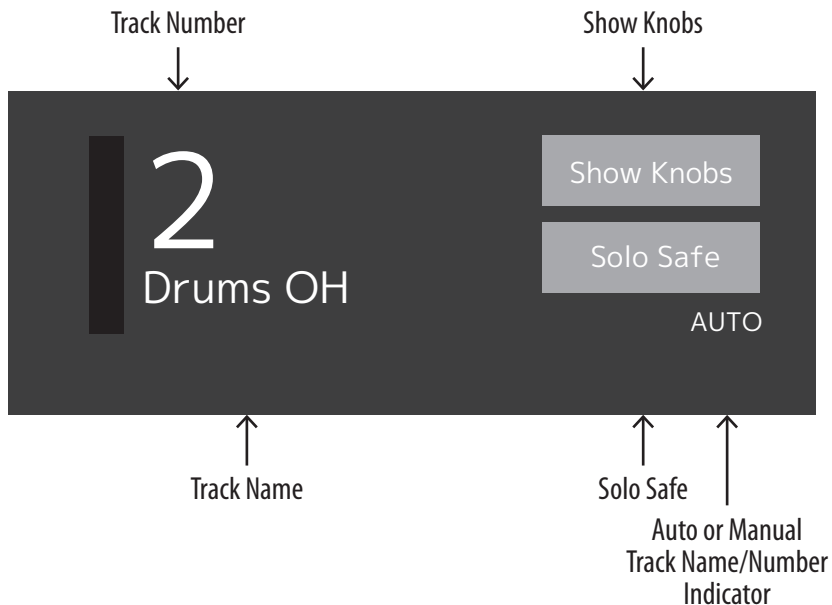

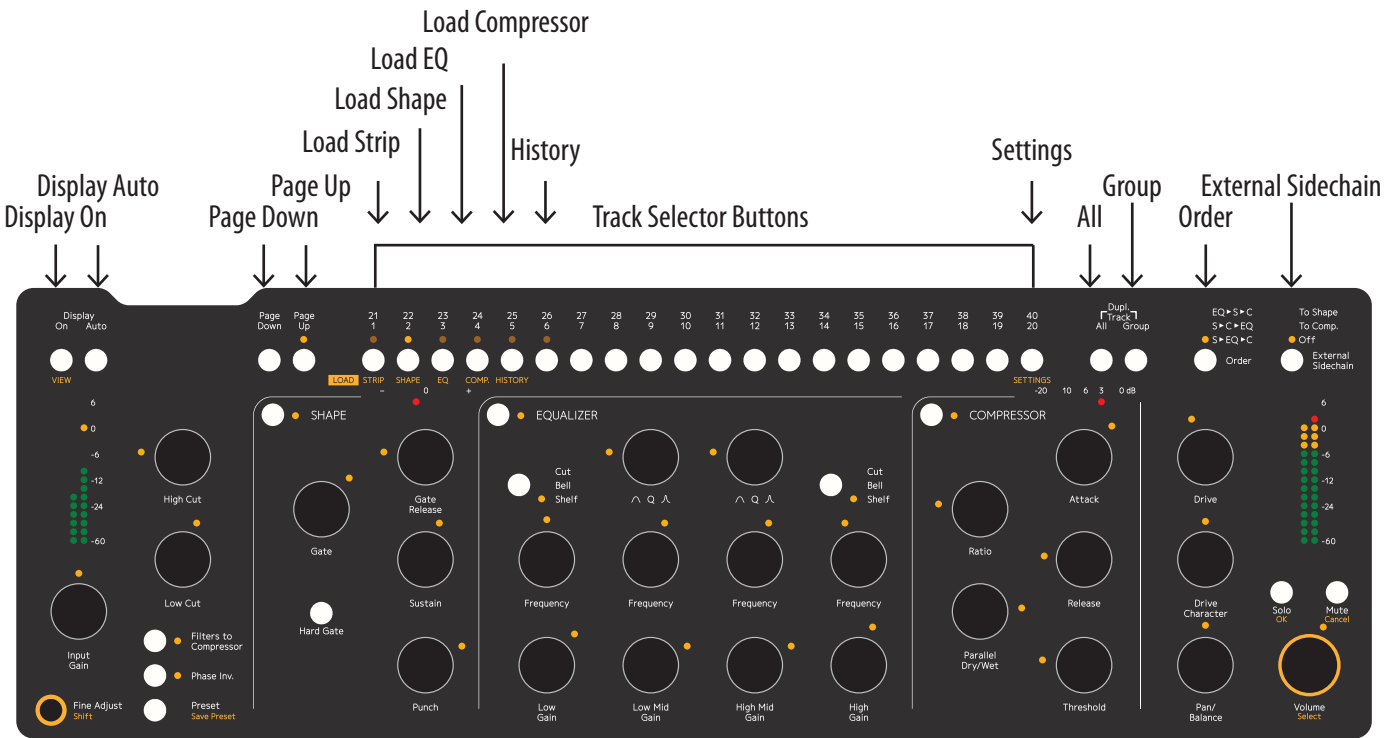

Display On Toggles Console 1's On-Screen Display on and off. Hold **Shift** and push **Display On** to enter the View settings menu.

Display Auto Sets the On-Screen Display behavior to automatic mode. In this case, the display pops up every time you change a setting, and automatically goes away a few seconds after your latest adjustment.

Page Up, Page Down Select which bank of tracks the 20 channel selector buttons control. You can have a virtually unlimited number of banks and tracks. The **Page Up** LED will light up if there are tracks on a page above the current, and vice versa with the **Page Down** LED.

Track selector buttons Select the channel you want to adjust, of 1-20 (or 21-40, 41-60 etc, depending on what page you selected with the **Page Up** and **Page Down** buttons). The selector buttons for tracks 1-5 and 20 have alternate functions, accessible by holding **Shift**.

Load Strip Selector button for track 1 (or 21, 41, 61 etc, depending on what page you are on). Hold the **Shift/Fine Adjust** button to select a new channel strip to load into the selected track (if you have more than one Console 1 compatible channel strip).

Load Shape Selector button for track 2 (or 22, 42, 62 etc, depending on what page you are on). Hold the **Shift/Fine Adjust** button to select a new Shape plug-in to load into the selected track (if you have more than one Console 1 compatible plug-in that is suitable for the Shape section).

Load EQ Selector button for track 3 (or 23, 43, 63 etc, depending on what page you are on). Hold the **Shift/Fine Adjust** button to select a new equalizer to load into the selected track (if you have more than one Console 1 compatible equalizer).

Load Compressor Selector button for track 4 (or 24, 44, 64 etc, depending on what page you are on). Hold the **Shift/Fine Adjust** button to select a new compressor to load into the selected track (if you have more than one Console 1 compatible compressor).

History Selector button for track 5 (or 25, 45, 65 etc, depending on what page you are on). Hold the **Shift/Fine Adjust** button to activate the **History** function and undo your actions.

Settings Selector button for track 20 (or 40, 60, 80 etc, depending on what page you are on). Hold the **Shift/Fine Adjust** button to enter the Settings menu.

All Press and hold to select all tracks at once. Any adjustments made while you hold this will affect all tracks. Press and hold together with **Group** button to duplicate settings from one track to another, or several others.

Group Press and hold while you select two or more tracks to form a group. Hold together with **All** button to duplicate settings from one track to another, or several others.

Order Changes the order of the three main effects sections. Default state is Shape into equalizer into compressor (s → EQ → c). Press repeatedly to toggle between this state, or shape, compressor and equalizer (s → c → EQ) or equalizer, shape and compressor (EQ → s → c).

External Sidechain Determines whether an incoming external sidechain signal should have no effect (OFF), be routed to the compressor sidechain (TO COMP) or to the sidechain of the gate part in the Shape section (TO GATE).

Input Section

Input Gain Adjusts the gain of the incoming signal of the selected track.

Input Gain meter Displays the signal level after the **Input Gain**.

High Cut Sets the cutoff frequency of the **High Cut** filter. Turn fully clockwise to bypass entirely (leave the signal intact). When **Filters to Compressor** is activated, the filter is applied to the compressor's sidechain signal.

Low Cut Sets the cutoff frequency of the **Low Cut** filter. Turn fully counterclockwise to bypass entirely (leave the signal intact). When **Filters to Compressor** is activated, the filter is applied to the compressor's sidechain signal.

Fine Adjust/Shift Hold while you adjust a knob to make the parameter change in smaller increments, or to access the extra functions labeled in orange.

Filters to Compressor Shifts the High and Low Cut filters from their default state (affecting the audio signal) to affecting the side-chain signal of the compressor.

Phase Invert Inverts the phase (polarity) of the selected channel.

Preset/Save preset Calls up the Presets menu. Press this while holding **Shift** to save the current settings as a preset.

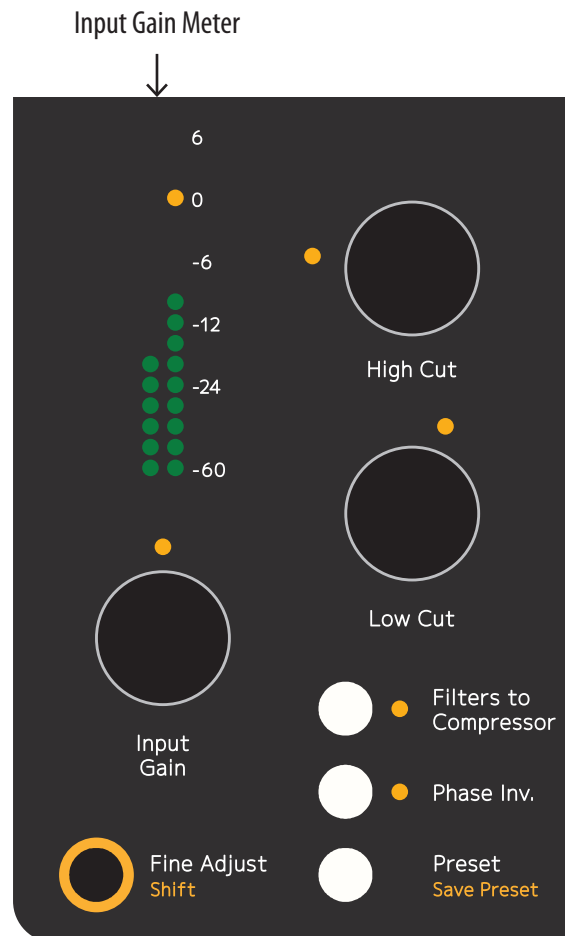

Shape Section

Shape activation Activates or bypasses the Shape section.

Shape section meter Displays the level changes caused by the Shape section.

Gate Sets the threshold level of the gate.

Gate Release Sets the release time of the gate.

Hard Gate Toggles between **HARD GATE** and **SOFT GATE** settings.

Sustain Turned clockwise from its center position, lengthens the sustain of the signal. Turned counterclockwise from its center position, shortens the sustain of the signal.

Punch Turned clockwise from its center position, makes transients stronger. Turned counterclockwise, makes transients softer.

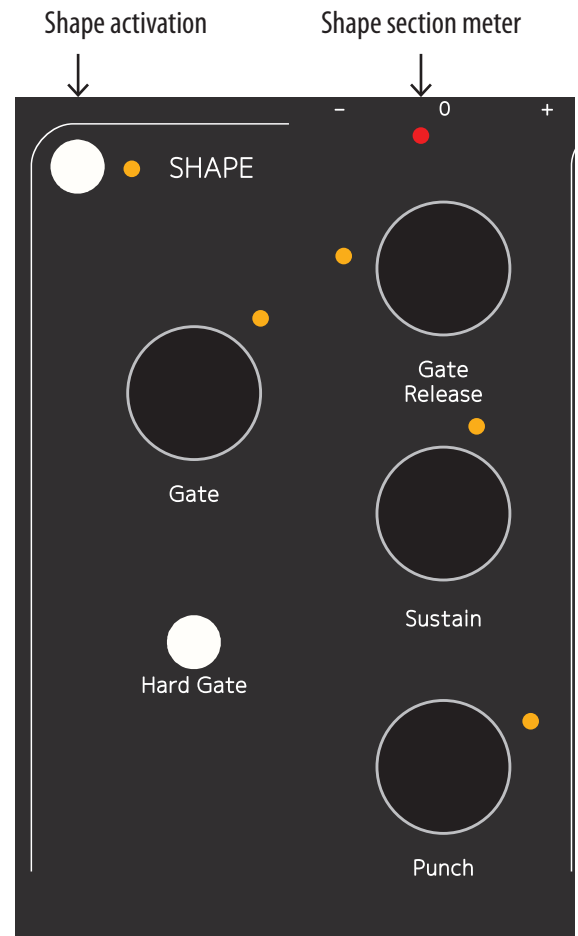

Equalizer Section

EQ activation Activates or bypasses the equalizer section.

Low Band

Cut/Bell/Shelf Sets the operating mode of the equalizer's low band.

Frequency Sets the operating frequency of the equalizer's low band.

Low Gain Turned clockwise from its center position, boosts the gain of the equalizer's low band. Turned counterclockwise from its center position, cuts the gain of the equalizer's low band.

Low Mid Band

Q Sets the width of the equalizer's low mid band.

Frequency Sets the operating frequency of the equalizer's low mid band.

Low Mid Gain Turned clockwise from its center position, boosts the gain of the equalizer's low mid band. Turned counterclockwise from its center position, cuts

EQ activation



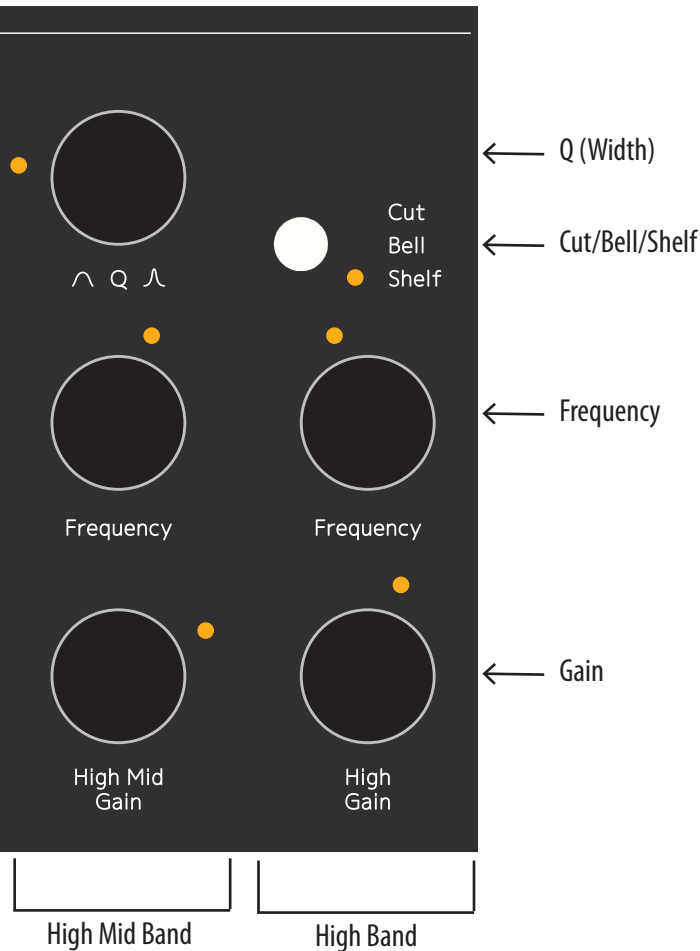

the gain of the equalizer's low mid band.

High Mid Band

Q Sets the width of the equalizer's high mid band.

Frequency Sets the operating frequency of the equalizer's high mid band.

High Mid Gain Turned clockwise from its center position, boosts the gain of the equalizer's high mid band. Turned counterclockwise from its center position, cuts the gain of the equalizer's high mid band.

High Band

Cut/Bell/Shelf Sets the operating mode of the equalizer's high band.

Frequency Sets the operating frequency of the equalizer's high band.

High Gain Turned clockwise from its center position, boosts the gain of the equalizer's high band. Turned counterclockwise from its center position, cuts the gain of the equalizer's high band.

Compressor Section

Compressor activation Activates or bypasses the compressor section.

Gain Reduction meter Displays the gain reduction caused by the compressor.

Ratio Sets the compressor's ratio.

Attack Sets the compressor's attack time.

Parallel Dry/Wet Sets the relative level of the compressed and uncompressed signal.

Release Sets the compressor's release time.

Threshold Sets the compressor's threshold.



Output Section

Drive Sets the level of the **Drive**/distortion function. Turn fully counterclockwise to bypass.

Drive Character Sets the **Drive**/distortion character.

Pan/Balance Sets the left-right placement of mono-to-stereo tracks, or the balance between left and right channels for stereo tracks. Pan is disabled for mono tracks.

Solo/OK Sets the selected tracks in Solo mode (all other channels are silenced, with the exception of tracks that have been set to **Solo Safe** in the Console 1 plug-in). In menus and dialog windows, the **Solo** button works as an "OK" button and confirms your choice in a currently opened menu.

Mute/Cancel Silences the selected track. In menus and dialog windows, the Mute button works as a "Cancel" button and cancels your choice in a currently opened menu.

Volume/Select Sets the output volume of the selected track. When **Shift** is pressed and held, use this knob to scroll in menus.

Output level meter Displays the output level of the signal that will be routed back to the DAW channel.

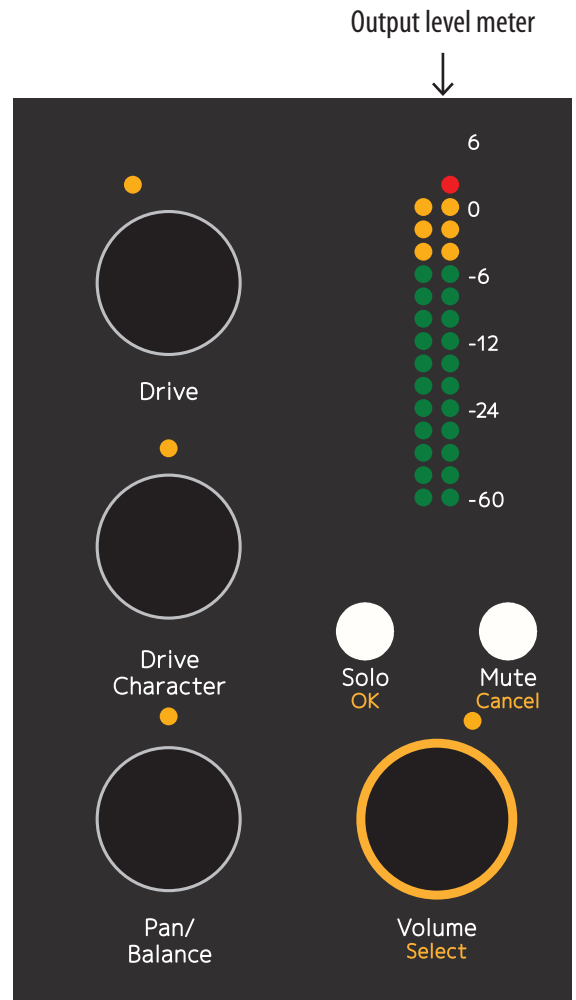

3 Working with Console 1

Console 1 has been designed to not only give you world class sound, but also extreme ease of use. Once you have everything set up, the basic workflow of Console 1 is as follows

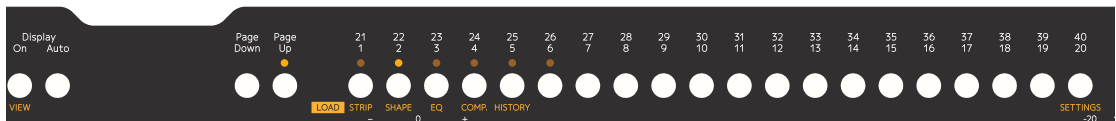

- Select a track by pressing the corresponding **Track Selector** button.
- Use the knobs to adjust the settings.
- Select another track.
- Adjust the settings.
- Repeat until your mix is great.

With that said, there are of course a few more details to look into. We will start by looking into track selection and handling, and then move on to a walkthrough of Console 1's effects sections.

Track Selection

The DAW tracks where you have initiated the Console 1 plug-in will be routed to the corresponding Console 1 track, as set in the Console 1 plug-in (See “Track Name and Number” on page 10). Pressing a **Track Selector** button on the hardware selects the corresponding track, and all knobs and buttons now control that track. The LEDs above the track selector buttons will light up if a DAW channel is routed to that track, and the LED of the currently selected track will light up brightly. LEDs next to each button and around each knob show the respective parameter’s current setting.

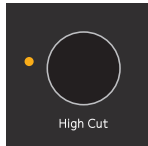

Parameter with LED showing the setting.

In the meter bridge of the On-Screen Display, you will see the track numbers and names. When music is played back, the respective track levels will be displayed here. The selected track will be highlighted in the meter bridge, and the settings of that track are reflected graphically and numerically in the On-Screen Display’s effect sections.

If you have more than 20 tracks in your mix, use the **Page Up** and **Page Down** buttons to access higher numbered tracks, in banks of 20 tracks each. The total number of available tracks is only limited by your computer’s CPU resources.

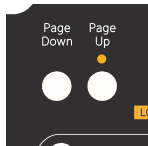

Page Up and Page Down buttons

If there are tracks on another page than the one you are currently on, the LEDs above the **Page Up** and **Page Down** buttons will show if these tracks are below and/or above the current page. If the currently selected track is on another page, the LED guiding to that page will be bright.

About CPU handling: Since Console 1 runs entirely on your computer’s CPU, a few things should be noted on the CPU usage. Most importantly, Console 1’s software part is unusually CPU efficient, and you should be able to run most sessions on today’s computers. It should also be noted that when you initiate the Console 1 plug-in on a DAW track, the default state of the Console 1 channel strip is to have all effects sections bypassed. In this state, the CPU usage is barely measurable. But of course, you still have access to functions like Solo, Mute, Volume, Phase Invert etc. Therefore, it is a good idea to create a DAW template with Console 1 active on all tracks and buses, even if you don’t plan to use any of the system’s effects. You get control over all tracks, at virtually no expense.

On-Screen Display

You can toggle on and off Console 1’s On-Screen Display with the **Display On** button on the Console 1 hardware. Turning the On-Screen Display off will reveal whatever is behind it on your computer screen—in most cases, this will be your DAW windows.

There is also an automatic mode that you activate by pressing the **Auto** button next to **Display On**. With this active, the On-Screen Display appears automatically every time you adjust a setting on the Console 1 hardware, and then disappears automatically after a few seconds, revealing whatever is behind the On-Screen Display.

If you have an extra computer screen, you can drag the On-Screen Display window there, just as any window. The On-Screen Display window can also be resized to your liking, by grabbing a corner of the window and dragging it as you wish.

Many people find that modern DAWs and plug-ins provide them with too much graphical information. Indeed, trusting your eyes over your ears is a well-known pitfall when mixing. Therefore, Console 1 works just as well with

the On-Screen Display turned off. You still select a channel and adjust the settings the same way. On the hardware, the LED rings around each knob show the current setting, so in a way, working like this resembles working on a classic analog console.

You can also choose to work with different types of views on the On-Screen Display, which you toggle through by pressing **Shift + On** on the hardware.



The On-Screen Display shows all settings for the current track, as well as output meters for the tracks on the current page.

The Input Section

In the Input Section of Console 1, you'll find the **Input Gain** knob. This adjusts the gain (volume level) of the incoming sound. Its setting is displayed numerically in the On-Screen Display. The input gain meter displays the signal level post the Input Gain knob—meaning adjustments to the Input Gain setting will be reflected in what level the meter displays. In most cases, it is a good idea to adjust the level so the signal's peaks reach between -12 and -6 dBFS.

High and Low Cut

The sweepable **High Cut** and **Low Cut** filters can be used to narrow down the frequency span of the signal. The filters' cutoff frequencies will be reflected numerically in the input section of the On-Screen Display, and will affect the graphical equalizer curve.

Many mix engineers have taken the habit of using **Low Cut** on most sound sources, except for bass instruments and kick drums, to remove unwanted low frequency rumble from the signal. **High Cut** is

useful for removing unwanted hiss from signals that do not have very much high frequency content anyways.

It is of course entirely possible to use the **High** and **Low Cut** filters

in a more creative manner—to not just clean up unwanted rumble and hiss, but to actually affect the sound source to better fit in the mix. The slope and character of the High Cut and Low Cut filters are determined by what channel strip has been loaded into the track. So in the case of the included SSL SL4000E, the High and Low Cut filters are modeled off that console. We have however extended their working range quite radically.

With the **Low Cut** knob turned fully counterclockwise, the filter is entirely bypassed. In a similar manner, the same applies to the **High Cut** filter when its knob is turned fully clockwise.

Filters to Compressor

By pressing the **Filters to Compressor** button, the High and Low Cut filters will no longer affect the sound source directly, but instead the sidechain signal of the compressor. Read more about this in “Filtering the Compressor Sidechain” on page 31.

Phase Invert

Phase Invert inverts the phase (polarity) of the signal, so that all negative parts of the signal's waveform become positive and vice versa. This is useful to correct issues where for example a microphone

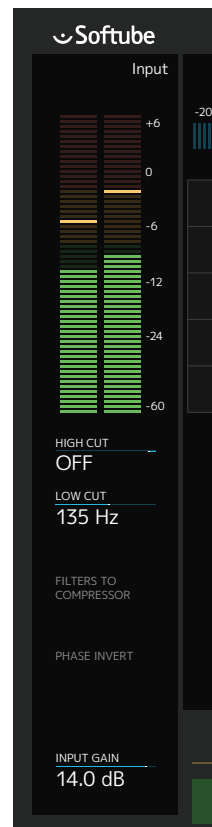

Input section on the On-Screen Display.

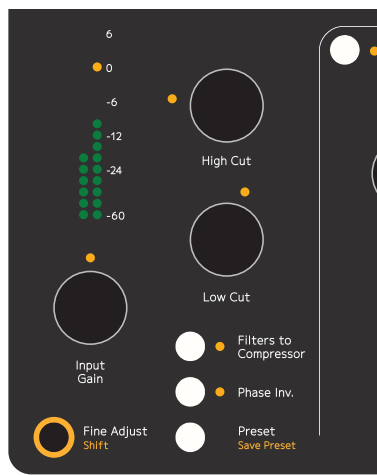

Input section on the Console 1 hardware.

cable has been miswired and the polarity inverted. It may (or may not) also improve the result when combining two microphones that are picking up the same sound source, such as top and bottom microphones on a drum or several microphones on the same guitar cabinet. When Phase Invert is active, the LED next to the button lights up, and it is also indicated in the On-Screen Display.

Fine Adjust/Shift

Holding the **Fine Adjust/Shift** button will make any settings you can adjust with a knob move in smaller increments. You can see the difference by following the numeric setting of a parameter in the On-Screen Display while holding and releasing the Fine Adjust button.

Holding Fine Adjust/Shift also gives you access to all functions screen printed in orange on the hardware.

Shape

The Shape section is a unique combination of two different types of effect, an expander/gate and Softube's own *Transient Shaper*. Toggle on and off the section with the button in the top left corner of the section. Turning the section on will light up the LED next to the Shape button and light up the Shape section in the On-Screen Display. The section's meter—both on the hardware and in the On-Screen Display—will show the gain increase or reduction caused by the section's processing of the sound, and you will also see a graphical curve in the On-Screen Display that represents the effect taking place.

An expander/gate is most commonly used to automatically remove unwanted portions of the recording. A common example is to use it on single drum tracks, where the gate opens and lets the sound through every time the drum is hit, but closes and makes the channel go silent between the drum hits, removing leakage from the rest of the drum kit. But a gate can also be used to for example

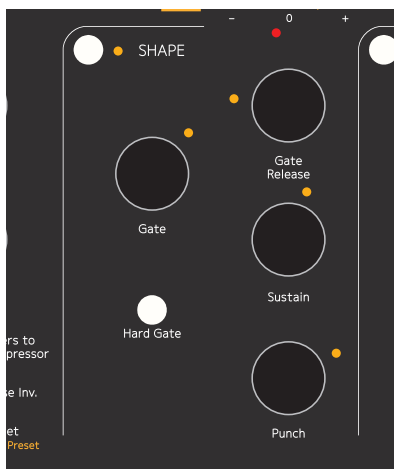

Shape section on the Console 1 hardware.



Shape section on the On-Screen Display.

shorten room reverberation in a recording, making the room appear smaller and improving separation between instruments.

Gate

The gate part of the Shape section has three parameters. The **Gate** setting determines the threshold level. The gate will open and let through any portion of the sound that exceeds this level, and close (not letting sounds through) when the signal is below it.

Pay attention when you

set this level. If it's set too high, the gate will not open every time you wish it would, meaning you will accidentally remove sounds you intended to keep. If it's set too low, the gate may instead open to sounds you intended to remove.

Gate Release

The **Gate Release** setting determines the time it takes for the gate to close after it has opened. For percussive material where you want just the hits and not much in between, you may want a shorter release time. But for a live recorded vocal, a too short release time may result in the gate abruptly shutting off the vocal sound, and remove low level vocal sounds you may would have liked to keep.

Hard Gate

The **Hard Gate** button toggles between two different gate behaviors. With **Hard Gate** engaged, the gate strictly shuts off any sound below the threshold level. With it disengaged, the gate will act as an expander. This is essentially a gate that does not completely turn off the sound below the threshold, but instead turns it down somewhat in level. This may yield a more natural sound in some cases, compared to a hard gate. When the **Hard Gate** setting is activated, the LED next to the **Hard Gate** button lights up, as well as the **Hard Gate** indicator in the On-Screen Display.

Sustain

The **Sustain** and **Punch** settings control the Transient Shaper part of the Shape section. When the **Sustain** knob is turned clockwise from its center position, the sound's sustain is increased, for example making single drums sound larger and more extended. Turned counterclockwise, the opposite happens: the sustain decreases, making sounds shorter and smaller.

Punch

Punch strengthens or softens the sound's transient, the onset of a sound. When the **Punch** button is turned clockwise from the center position, the transient will get stronger, resulting in a more spiky and attention-grabbing sound. Turned counterclockwise, the transient will get softer, making the sound's onset more rounded and unobtrusive.

Equalizer

An equalizer alters the frequency content of the sound, giving you detailed control of the sound's tone. The Console 1 equalizer has four parametric bands. Toggle on or off the entire section with the button in the top left corner of the section. The LED next to the button will light up when the section is active, and the entire section will light up in the On-Screen Display. All the equalizer settings mentioned below are displayed numerically in the On-Screen Display, as well as in the equalizer's graphical curve.

All four bands have a **Gain** setting. When the buttons are turned clockwise from their center position, these will boost the gain of the respective frequency bands. Turned counterclockwise, they will do the opposite and cut the gain of the respective frequency bands.

The four bands also each have a **Frequency** setting. These determine the center or cutoff frequencies of the respective frequency bands.

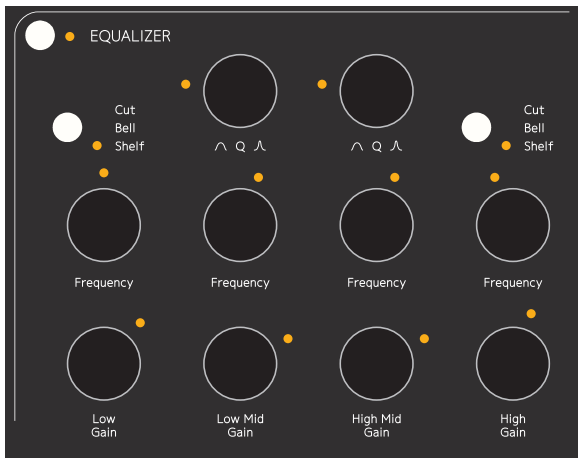

Equalizer section on the Console 1 hardware.

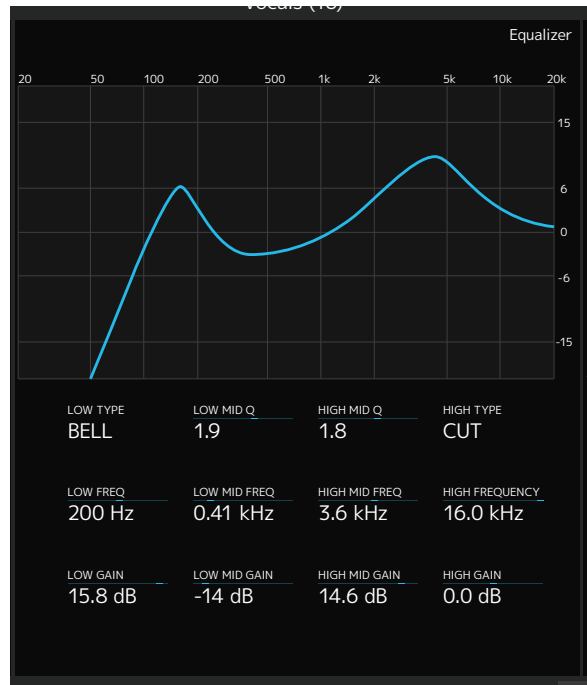

Equalizer section on the On-Screen Display.

Low Mid and High Mid Bands

The Low Mid and High Mid bands have a **Q** setting each. These set the **Q** value of the equalizer curve, determining how wide or narrow range of frequencies the equalizer band will affect.

Low and High Bands

The Low and High bands instead have a button that lets the user toggle between a **SHELF**, **BELL** or **CUT** shape of those filters. A shelf means that all frequencies below (in the case of **Low** filter) and above (in the case of the **High** filter) the cutoff frequency will be cut or boosted equally.

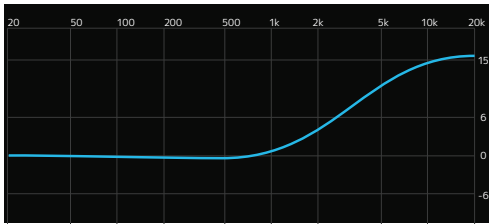

A high shelving filter.

A **BELL** curve means the EQ boosts or cuts the set center frequency and a range of frequencies above and below that, diminishing in strength the further from the center frequency it gets.

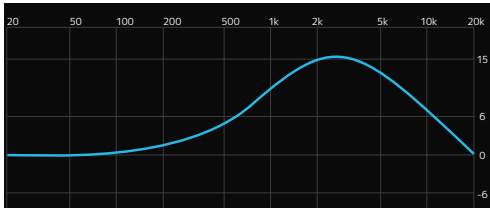

A broad high boost bell curve.

CUT means that the **High** and **Low** filters can double as high and low cut filters, just as the ones in the Input section. So these will be taking away anything below (in the case of **Low** filter) and above (in the case of the **High** filter) the cutoff frequency.

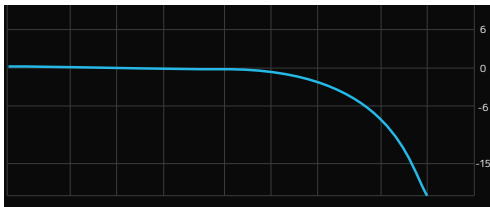

The high band set to "cut".

This is useful if you have chosen to use the **High** and **Low Cut** filters of Console 1's input section for the compressor's side chain but still want high and low cutting on the signal itself.

Please note that the graphical curve displays the actual equalizer response, calculated off the modeled analog circuitry. This curve may differ from the markings on the equalizer parameter functions, which is quite common for real world analog equalizers. The markings may not tell you the truth about what you really do when you twist the knobs, but Console 1's equalizer curve does!

Compressor

A compressor is essentially a device that acts like an automatic volume control. When the level of the incoming signal rises above a certain level—the compressor’s threshold level—the compressor will start decreasing the output level. So the difference between the loudest and the softest parts of the sound will be made smaller—the sound will be compressed. Toggle on or off Console 1’s compressor section with the button in the top left corner of the section. The LED next to the button will light up when the section is active, and the entire section will light up in the On-Screen Display. The compressor’s current behavior is displayed in the graphical curve.

Threshold

The **Threshold** setting determines the threshold level, above which the compressor will react and start decreasing the output level. A low threshold means the compressor affects most portions of the sound (the sound does not have to be very loud to

exceed the threshold), a high threshold means the compressor only affects the loudest parts of the signal.

Console 1’s Compressor section incorporates an **automatic make-up gain**, which compensates for the gain reduction the compressor causes by turning up the sound level. This applies to any compressor you load into the Compressor section, even though that function may not be part of the original standalone plug-in.

Ratio

The **Ratio** setting determines by how much the output volume will be decreased when a sound is louder than the threshold level. For example, a 4:1 ratio means the sound will be reduced to a fourth of the level that exceeded the threshold. So if a sound exceeds the level by 4 dB the compressor will turn it down to 1 dB above the threshold level. If the sound exceeds the threshold by 8 dB, the compressor will turn it down to 2 dB above the threshold level. ∞:1 means that no sound that exceeds the threshold level will ever get any louder than that level. This is often referred to as limiting.

Gain Reduction Meter

The gain reduction meter on the hardware and in the On-Screen Display displays the amount of gain reduction taking place.

Attack

The **Attack** setting determines how quickly the compressor will respond to a sound’s level exceeding the threshold. A fast attack means the compressor will respond rapidly, and quickly turn down the sound when it has exceeded the threshold level. A slow attack means that the compressor will respond slowly. Such a setting leaves a part of the sound that

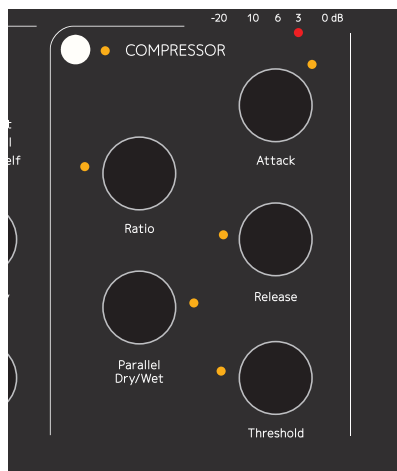

Compressor section on the Console 1 hardware.

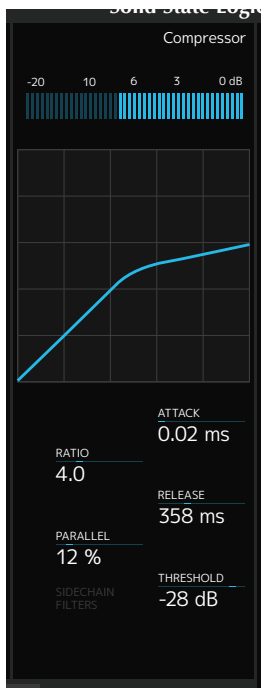

Compressor section on the On-Screen Display.

When this is turned fully counterclockwise (which is the default state), you only hear the compressed signal. By turning it clockwise, you gradually mix in the uncompressed sound. The percentage expressed in the On-Screen Display indicates the portion of uncompressed sound. One common use of the **Parallel Dry/Wet** function is to compress the sound heavily with a fast attack, and then blend in some of the original (uncompressed) signal. When set carefully, this may yield a nice balance between a sound that has a nice presence in the mix, but still sounds alive and dynamic.

Filtering the Compressor Sidechain

As mentioned in “” on page 23, you can route the

exceeded the threshold at its original level before the compressor reacts and turns down the output.

Release

The **Release** setting determines how quickly the compressor will return to its normal gain after having reduced it. A fast release may give a more obviously compressed sound, while a slow release may sound more natural, and not be as clearly perceived as being compressed.

Parallel Dry/Wet

Parallel Dry/Wet lets you blend the compressed and uncompressed signal

High and **Low Cut** filters to the compressor’s sidechain instead of applying them directly on the signal (by turning on **Filters to Compressor**). This is useful in a number of cases. It is for example a common trick to cut low end frequencies out of the compressor’s sidechain signal. Low frequencies often have a lot of energy and can cause the compressor to react stronger than one might find pleasing.

Bass Drum Compressor Filtering

For example, a bass drum can cause a compressor across the drum bus to make the cymbals “duck” with every bass drum hit. Applying **Low Cut** to the compressor sidechain would make the compressor “deaf” to the lower frequencies of the kick drum, and it would consequently not respond as strongly to them.

De-essing Example

You can also use both **High** and **Low Cut** filters across the compressor sidechain to create a tight frequency window, which will be all the compressor responds to. Most de-essers work this way, by narrowing down the frequency of the compressor’s sidechain so it only detects and responds to the s-sounds. This could also work to reduce hi-hat bleed in a snare drum microphone. When this setting is active, the LED next to the **Filters to Compressor** button will light up, and it will also be indicated in the On-Screen Display.

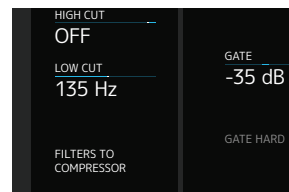
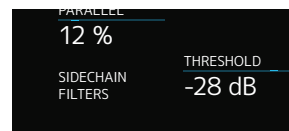

Activating **Filters to Compressor** lights up the Sidechain Filters indicator in the Compressor section (top) and the Filters to Compressor indicator in the Input section (bottom).

The Output section

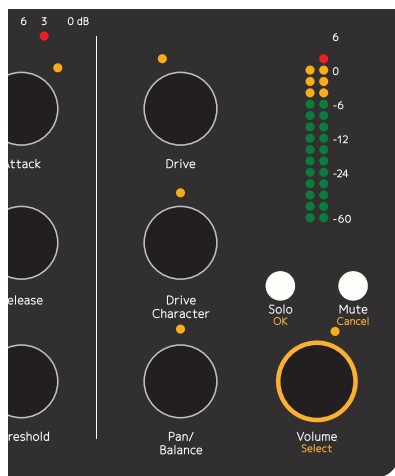

Output section on the Console 1 hardware.

Drive

The **Drive** function enables the harmonics from the original consoles, in the default case the famous non-linear characteristics of the SSL SL4000E console. In many cases, the harmonics are what glues a mix together and creates that big, analog, console sound.

If applied subtly, you'll get the harmonics, warmth and character of the original console. Turn it up more and you'll get a more aggressive sound with mid-rangy harmonics and shaved-off transients. Turn it up fully and you'll get lots of fuzz...

The Drive section is entirely bypassed when the **Drive** knob is turned fully counterclockwise, so this corresponds to running your channel with a lot of headroom and no meters reaching the red.

Gain Staging with the Drive Control

The idea behind the **Drive** is to give you the pos-

sibility to control how the console emulation is distorting, or in other words: *to control the headroom of the console.* With **Drive** is set a **OFF**, you will get no harmonics at all, and this part of the console emulation has been entirely bypassed. If you start to turn it up, and keep your levels below 0 dB (with **Output Volume** at 0 dB), you will get increased harmonics up until 5 (12 o'clock), where levels above 0 dB will start to distort. With **Drive** at 10, levels above -24 will start to distort.

If you set Drive at 5, you will get a behavior that corresponds to the real console.

Drive Character

The **Drive Character** setting alters the character of the distortion. When set to its center position, the character is neutral and perfectly mimics the overdrive response of the analog unit that was modeled—the included Solid State Logic SL4000E or another Console 1 channel strip you have purchased separately. When turned clockwise, the harmonics in the high midrange are emphasized, which can often be useful to bring a sound forward in the mix. When turned counterclockwise, the midrange instead cleans up, leaving you with a sound that is saturated, thickened and softened, but not obvi-

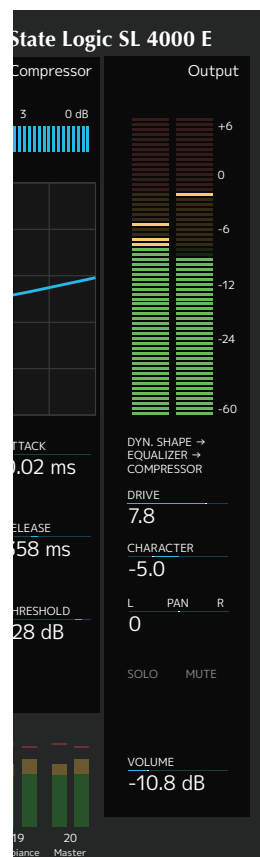

Output section on the On-Screen Display.

ously distorted. This is often useful to add a bit of sonic “glue” to complex sources, such as a bus with a whole instrument section or across the master bus.

Pan/Balance

The **Pan/Balance** setting determines the relative level of the sound source in the left and right channels. Please note that the **Pan/Balance** setting does not affect your DAW’s pan setting. In order for the Console 1 **Pan/Balance** setting to work as expected, even mono tracks must be made stereo in your DAW (or “Mono to Stereo” where applicable.) This is because panning in Console 1 only works within the framework of the DAW channel. If you do not make mono tracks into stereo in your DAW, the DAW’s own pan knob must be used for panning.

Solo

The easiest way to unsolo several tracks is to use the **All** feature. Just press **All + Solo** to toggle **Solo** on all tracks.

The **Solo** function sets the selected track in **Solo** mode. This means that all other tracks are silenced, with the exception of channels that have been set to **Solo Safe** in the Console 1 plug-in.

For more information on this, please refer to “Solo Safe on Aux Channels and Buses” on page 10 and “” on page 33.

Please note that the Solo button only affects the Console 1 system, and not the solo function of your DAW. In order for Console 1’s Solo to function as expected, all tracks of the DAW mix must be routed to the Console 1 system. Tracks that are not routed to the Console 1 system will not be silenced when the Console 1 Solo mode is engaged.

Mute

The **Mute** function silences the selected track. When **Shift** is pressed and held, the **Mute** button works as a “Cancel” button and cancels your choice in a currently open menu. Just as noted above regarding the **Solo** function, the **Mute** function does not control your DAW’s mute function, it mutes the track internally within Console 1.

Volume/Select

The **Volume/Select** setting determines the output volume of the selected track. The output volume is shown in the output section meter.

It is good practice to set this so peaks are below -6 dB and avoid peaks above 0 dB. Although the only channel where this really is important is the master bus—you should never exceed 0 dB on the master bus.

Understanding Solo Safe

Setting aux channels and buses in `SOLO SAFE` mode means that when you select a single track and press **Solo**, the buses will still be open and let sound through. If you had inserted the Console 1 plug-in on for example the master bus (to which all tracks are summed in your DAW), and then soloed one of the single tracks, this would silence all other Console 1 tracks, including the master bus. Since all tracks pass through the master bus, and this gets silenced when you set a channel to `SOLO`, there would be no sound at all. But setting the master bus in `SOLO SAFE` mode means it will be excluded from the tracks that are being silenced. If you do this and solo a single track, the master bus will keep open and you will hear the soloed track play.

Play it safe by setting all your buses, auxes, groups and the master track in **Solo Safe**.

The same logic applies to all buses/subgroups. So if you for example have routed all the drum tracks to a single stereo drum bus, and you have a Console 1 plug-in on that bus, make sure to set this in `SOLO SAFE` mode too. If you then for example solo the snare drum channel, it will play through the drum bus, and then through the master bus, and both of these will be left open if set to `SOLO SAFE`. If either of those are not set to `SOLO SAFE`, they would be silenced when you soloed the snare track, and you would get no sound at all.

It may also be a good idea to `SOLO SAFE` a Console 1 instance on an effects send channel, where you for example have a reverb or delay active. This way, setting a single track to `SOLO` will not silence the reverb. If the track you have soloed has an active asend to the reverb (set up in your DAW), and you have set the reverb's effects send channel to `SOLO SAFE`, you will hear both the dry signal and the reverb's response to that signal. If you have not set

the reverb's effects send channel to `SOLO SAFE`, you will only hear the dry signal from the soloed track and no reverb.

Solo Safe can of course also be used for single tracks that you want to be heard at all times, for example a metronome track.

4

Useful Functions

We have now gone through the essential functions of Console 1. But there are even more useful functions to make your every day music mixing life even easier.

Select All Tracks

By holding **All**, you select all tracks at once. Any adjustment you perform while holding this affects all tracks simultaneously. When holding **All**, a dialog window will appear in the On-Screen Display, informing you that all adjustments you perform currently affect all tracks.

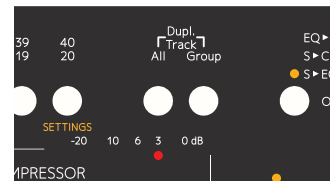

Press **All** to select all tracks at once, or **Group** to create temporary groups.

When using **All** or **Group**, only the parameters you change will affect the grouped tracks. The rest will remain unchanged.

Create a Group

You can also create temporary groups of tracks that you want to adjust simultaneously, for example all background vocal tracks. In order to do this, first select one track that you would like to be part of the group with the corresponding **Track Selector** button. Hold **Group** on the hardware, and then press the **Track Selector** buttons of the other tracks that you would like to group with the first one. A message window in the On-Screen Display will inform you of what channels you are

GROUP TRACKS

Select which tracks to group with track 1.

To exit, just release group.

A message window in the On-Screen Display displays the current action.

grouping. Release the buttons, and perform the adjustments you would like. Press **Group** again, or select another track, to dissolve the group.

Please note that selecting all or creating a group works similarly to a VCA group on a traditional mixer. This means that a Console 1 track group is not a bus to which all the tracks are routed and summed together into a single stereo channel. It is merely a function to simultaneously adjust parameters of several individual tracks at once.

When selecting **All** or creating a **Group**, changes made to **Input Gain**, **Output Volume**, **Drive**, **Drive Character**, **High Cut**, **Low Cut** and **Pan/Balance** will be performed *relative to each channel's setting*. So if you for example select all and turn down the **Output Volume**, the relative level balance between the tracks will be intact, they will all just be turned down in volume.

Conversely, when making changes to any other parameter, this will result in all the tracks getting the same setting as the currently selected one.

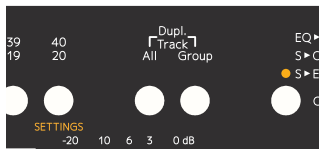

Duplicate tracks by pressing both **All** and **Group** at the same time.

Duplicate Track Settings

You can duplicate track settings and copy them from one track to another—or several others. This can be either the entire channel strip setting, or just the Shape, EQ or Compressor settings.

1. Select the track you would like to copy from using the corresponding **Track Selector** button.
2. Press and hold both **All** and **Group** buttons. A dialog window in the On-Screen Display will inform you that you are about to copy the channel strip settings of the selected track, and prompts you to select the track to which you would like to copy these settings.

COPY TRACKS

Track 1's EQ and Compressor will be copied to track 2, 3 and 4.

Release Group+All to confirm. De-select tracks to abort.

A message window in the On-Screen Display displays the current action.

3. Select the track (or tracks) you want to copy to by pressing the corresponding track selector button (or buttons), and release the **All** and **Group** buttons.

If you change your mind during this process, simply deselect the tracks you were copying to by pressing the track selector buttons again. When you now release the **All** and **Group** buttons, nothing will be copied.

Duplicate Different Sections

In order to not copy the entire channel strip setting, but just the settings of single effects sections:

1. Press and hold both the **All** and **Group** buttons.

2. When the dialog window opens, press the on/off button next to the name of the section (or sections) you would like to copy—for example the **Equalizer Activate** button.

The dialog window now informs you that you are about to duplicate the equalizer settings of the selected track. You can select and duplicate any combination of Shape, Equalizer and Compressor to other tracks.

Only by duplicating the entire channel strip can you duplicate the High/Low Cut settings and the Drive settings.

Load and Save Presets

You can call up factory presets, as well as save your own ones. A preset can contain the entire channel strip, or one or several sections, so that you for instance can create an equalizer + compressor preset.

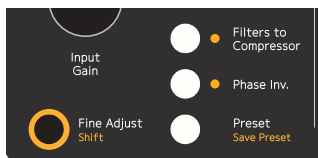

Access presets with the **Preset** button, or save your current settings by pressing **Shift + Preset**.

Load Preset

1. Press the **Preset/Save Preset** button to call up a list of entire channel strip presets. A dialog window will open in the On-Screen Display to show you a list of available presets for the channel strip you have loaded into the selected channel.

2. Select the category by using the **Output Volume/Select** knob:

FACTORY CHANNEL STRIP: the entire strip

FACTORY SHAPE: just the Shape section

FACTORY EQUALIZER: just the EQ section

FACTORY COMPRESSOR: just the compressor.

USER PRESETS: presets saved by the user.

For example, loading an Equalizer preset will only overwrite the current equalizer's setting, and will not affect the rest of the channel.

3. Select the preset by using the **Output Volume/Select** knob.

4. Confirm your selection by pressing **Solo/OK** or cancel the preset selection by pressing **Mute/Cancel**.

SELECT TYPE OF PRESET

Factory Channel Strip
Factory Shape
Factory Equalizer
Factory Compressor
User Presets

Scroll with OUTPUT VOLUME, confirm with OK (Solo), cancel with CANCEL (Mute)

Presets are easily loaded from the Console 1 hardware and shown on the On-Screen Display.

Save Preset

To save your current setting as a preset:

1. Hold **Shift** and press **Preset/Save Preset**.
2. If you want to save the entire channel strip as a preset, just press **Solo/OK**.
3. If you want to save just one or several sections, select those with the on/off buttons. Press **Solo/OK** when done.

It's easy to create a, say, EQ + Compressor preset: just select the EQ and Compressor after pressing Save Preset. Loading such preset will only overwrite the current EQ and Compressor, nothing else!

4. You will be prompted to name your new preset and save it. It will now appear in the list of available **USER PRESETS** if you call one up, as outlined above.

When saving a preset Console 1 will open a separate file browser window and close the On-Screen Display. Click on **Display On** to see the On-Screen Display again.

History

Most of today's DAWs have an unlimited undo function, so whatever mistakes you may have made can be undone. But this does most often not apply to plug-in settings. If you have gotten lost while adjusting a plug-in setting, you can usually not go back to a previous setting, unless you revert to a previously saved version of your project.

But Console 1 has an unlimited undo function for its settings, that we call *History*.

1. Hold **Shift** and press the track selector for track 5, with the orange text **History**.
2. Use the **Volume/Select** knob to scroll back (counterclockwise) and forward (clockwise) in time, and you will see the different parameters become highlighted and their parameters change back to their state before the adjustment was made.
3. When you have reached the point from which you would like to start over, stop scrolling and press **Solo/OK** (or **Mute/Cancel** if you prefer that.)

All actions and adjustments you made later than this point (the ones you just scrolled through) will be undone.

...and if you want to undo the recently undone, just enter *History* again and go back just one step.

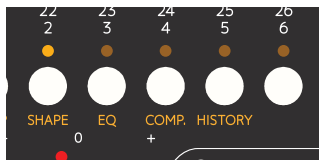

Access history by pressing **Shift** and track selector 5 (**History**)

Settings

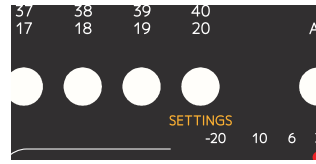

Access settings by pressing **Shift** and track selector 20 (**Settings**)

To access the Settings menu, hold **Shift** and press the track selector for track 20, with the orange text **Settings**.

MIDI Controller Mode

The normal way to use Console 1 is with the Console 1 On-Screen Display and the Console 1 plug-ins, but it is possible to use it as a generic MIDI controller. To enter the MIDI mode you need to quit the Console 1 application and reconnect the hardware.

Using Console 1 Without the Hardware

Many of today's musicians and mix engineers work with portable lap top computers, and use them in many different locations. While the Console 1 hardware is not too big or heavy to bring with you, you may not have it available at all times. For this reason, we made it possible to adjust Console 1's settings using the computer mouse.

In your DAW, open the Console 1 plug-in on the track you would like to adjust. Click **Show Knobs**, and an interface that resembles the Console 1 hardware will appear. This is fully clickable with the mouse, and you can adjust Console 1's settings from here.

Automation

All Console 1's parameters can be automated into your DAW. Automation can either be programmed, just like any plug-in in your DAW, or by using the Console 1 hardware to write the automation in real time. Please refer to your DAW's manual for further information on how this is done.

Automation in Pro Tools

Since the Console 1 controls aren't touch sensitive, automation is preferably made in Latch or Write instead of Touch mode.

5 Customizing the Channel Strip

Even though the basic functions of Console 1 as well as the included model of a Solid State Logic SL4000E should be more than adequate for any mixing tasks, there are ways of customizing the channel further. We go through these here.

Loading Other Channel Strips and Effects

The included Solid State Logic SL4000E is an excellent channel strip, but sometimes one might like to have the option of other sound characters. Either just another compressor or equalizer, or a whole other channel strip sound. Softube will continuously release new models of analog hardware in the form of channel strips that will perfectly integrate with the Console 1 system. These will be separately available for purchase. But you can also use all the other Softube plug-in equalizers, compressors and gates as part of a Console 1 channel.

Note that plug-in effects you load into the Console 1 system may not perfectly correspond to the screen printed parameters on the Console 1 hardware. Some Console 1 knobs may change or lose their function, and there may be plug-ins that have more functions than can be controlled from within Console 1. This will however all be reflected in the On-Screen Display. If you find you would like to use a function that can not be reached through the Console 1 system, we recommend that you simply launch the ordinary plug-in version in your DAW and control its settings with your mouse, just as you would have done before you got the Console 1.

Load Plug-Ins

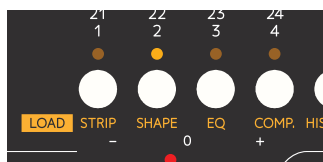

Load different strips and plug-ins by pressing **Shift** and select either **Strip**, **Shape**, **EQ** or **Comp.**

Loading Console 1 compatible channel strips and effects is done by holding **Shift** and pushing one of the first four channel selector buttons, with the orange labels

Strip, Shape, EQ and Comp.

Holding **Shift** and selecting **Strip** (track selector button 1) lets you load any Console 1 channel strip into the selected track, replacing the Solid State Logic SL4000E.

Doing so opens a menu where you see all Console 1 compatible channel strips that you have available on your system. Scroll down the list using **Volume/Select**, and press either **Solo/OK** to confirm or **Mute/Cancel** to cancel. The channel strip name and logo in the On-Screen Display will change to reflect your choice.

In a similar manner, you can choose to load single effects into the Shape, Equalizer and Compressor sections separately. Again, hold **Shift** and press track selector button 2 to load a Shape effect, track selector button 3 to load an equalizer or track selector button 4 to load a compressor. Again, a menu will appear, listing the compatible and suitable effects. Use **Volume/Select** to scroll down to the effect you would like to use, and press either **Solo/OK** to confirm, or **Mute/Cancel** to cancel.

If you load a Shape, Equalizer and/or Compressor effect, the **High Cut** and **Low Cut** filters and the **Drive** section will not change from what was included in the channel strip you are customizing. These sections only change with the channel strips.

Changing the Order of the Sections

The default order of the Console 1 effects is as they are laid out on the hardware and in the On-Screen Display: first shape, then equalizer and finally compressor.

Sometimes a different order of the effects may be desirable. For example, if you add a lot of low frequencies with the equalizer, it may be better to do this after the compressor.

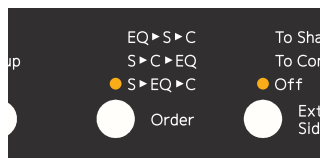

Change the order of Console 1's sections using the **Order** button.

The current order is displayed above the **Order** button and in the On-Screen Display. The default state is $s \rightarrow EQ \rightarrow c$ (shape, equalizer, compressor). To change the order of the effects sections, press the **Order** button. The other options are $EQ \rightarrow s \rightarrow c$ (equalizer, shape, compressor) and $s \rightarrow c \rightarrow EQ$ (shape, compressor, equalizer).

Using External Sidechain Signals

It is a common trick to feed an external signal into the sidechain of a compressor or a gate. Doing so means that the compressor or gate will no longer act in response to the sound signal it affects, but to the external signal which is being fed into the sidechain.

A Keying Example

An example of using the external sidechain for a gate: let's assume the gate is inserted on a track with a synth pad. The synth pad plays continuously, with no interruption. But instead, we would like it to follow the pattern of the kick drum, and have the pad appear at every kick drum hit and disappear in between. To do this, you would insert the gate on the pad track. You would then route the kick drum sound into the sidechain of that gate. Now, every time the kick drum hits, the gate will open and let the pad sound through. But in between kick drum hits, the gate will close and silence the pad track.

A Ducking Example

Used with the same signals, but on the compressor: The compressor is inserted across the synth pad signal, and the kick drum is routed to the compressor sidechain. Now, every time the kick drum hits, the compressor will react and turn down the output signal of the pad. So the pad will be its normal volume in between kick drum hits, but lower every time the kick drum hits. This is often called ducking, the pad ducks every time the kick drum hits.

Doing it with Console 1

To get this set up in Console 1, you go to the DAW channel where you have the sound source you would like to be affected by the sidechain (in the examples above, that would be the DAW channel where the pad synth is). Open the Console 1 plug-in window, and set it up to have its sidechain fed with the signal you would like to affect it (in our example, that would be the kick drum). Refer to your DAW manual for the details of setting up an external sidechain.

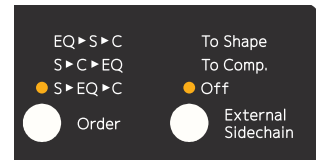

Select whether an external sidechain (if applicable) should be sent to the compressor or shape section.

Once this is in place, you can go back to the Console 1 system. With the **External Sidechain** button, you can select if you would like the external sidechain signal to be routed to your gate or to your compressor, or not have any effect at all. When set to **OFF**, the sidechain signal does not affect neither the gate nor the compressor. When set to **TO SHAPE**, the external signal gets routed to the Console 1 gate's sidechain. When set to **TO COMP**, the external signal gets routed to the Console 1 compressor's sidechain.

View Options

If you would like, you also have a few options when it comes to the appearance of the On-Screen Display. Hold **Shift** and press **Display On/View**. This will toggle through the different views available.

6

Specifications, Requirements and Troubleshooting

System Requirements

Console 1 is not yet available for Windows. Here are the system requirements for Mac OS X:

- Mac OS X 10.7 or newer
- Screen resolution 1280x800 or larger
- Any VST, VST3, AU, or AAX (Pro Tools 10.3.7, 11.0.2 or higher) compatible host application
- 1 powered USB 2.0 compatible port
- iLok License Manager (iLok USB key is NOT required)
- Broadband internet access for downloading software.

Console 1 is not available for AAX DSP.

The Console 1 plug-in supports the following sample rates: 44.1, 48, 88.2, 96, 176.4 and 192 kHz.

Block Diagram

The following schematic outlines the operation of Console 1. For the sake of simplicity, the different order of the sections (EQ before Shape before Compressor, etc) are not included. Neither are stereo/mono operation on dynamic's sidechains.

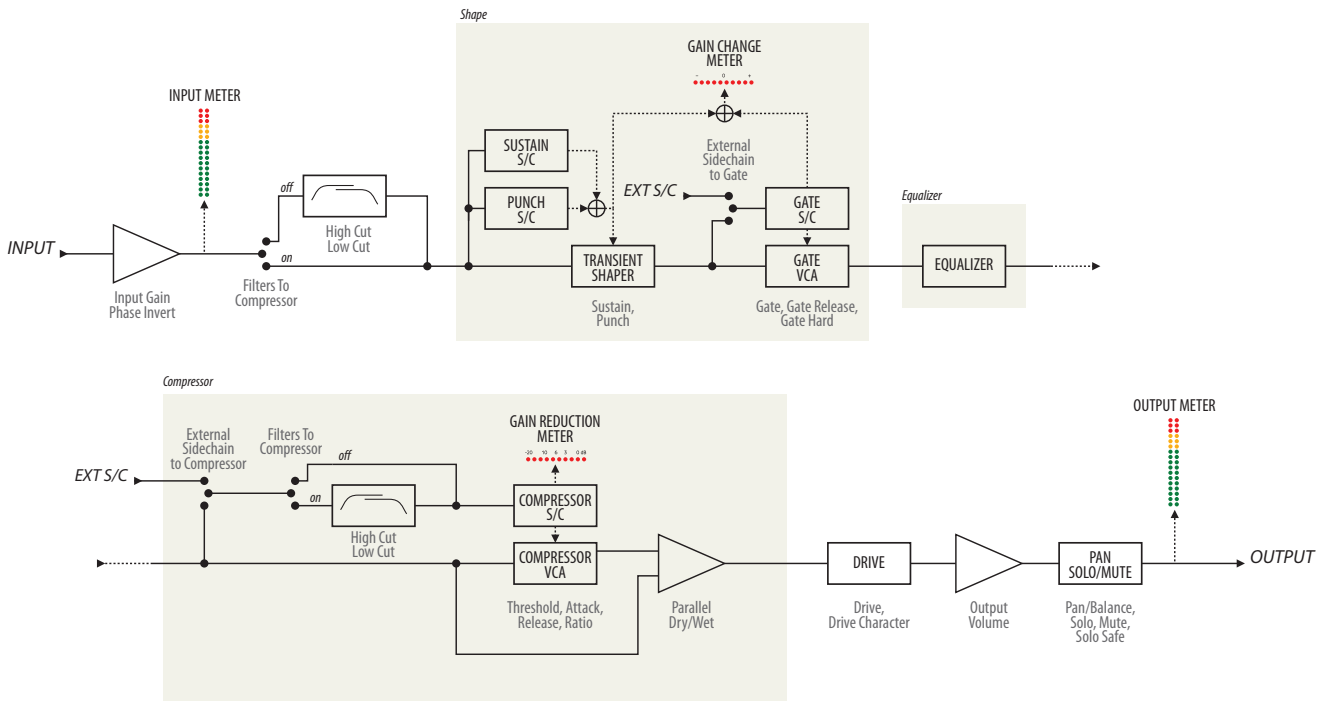

Troubleshooting

Hardware Does Not Turn On

If you're using a passive, non-powered, USB hub, the Console 1 may fail to power on because it is not getting enough power. Please connect the Console 1 to a powered USB hub, or directly to your computer.

Since Console 1 may require the full 500 mA it may interfere with other USB appliances on the same hub.

Software Errors

Even if software errors should be few, you may sometimes experience an “Unknown Error”. This is not a problem, and usually just means that “while your computer did this, it didn't do that fast enough for me”. Anyway, if you do get an “Unknown Error”, **please make sure that you have the latest version of our software installed!** If you do, please try the following steps:

1. Unplug the Console 1 hardware
2. Plug it back in again

If that didn't help, do this:

3. Exit Console 1 On-Screen Display, unplug the Console 1 hardware and quit your DAW
4. Start Console 1 On-Screen Display
5. Plug in the Console 1 hardware
6. Start your DAW again

That should definitely do it. If not, try a reboot.

Mac OS 10.8+ Firewall

The Console 1 application uses internal network

ports to communicate between plug-ins and the Console 1 application, which will trigger a firewall alert the first time the application is started. You need to click “ALLOW”, otherwise nothing will work.



You need to allow Console 1 to accept incoming network connections for it to communicate with the Console 1 plug-ins.

Please note that Console 1 is not using any *external* network traffic, like calling home or accessing Internet. All traffic occurs within your computer.

Disconnect Console 1 Before Computer Sleep

Please disconnect your Console 1 before putting your computer to sleep. For some unknown reason, Console 1 and the operating system doesn't play nice in sleep mode, and in worst case the computer might hang.

Hardware Specifications

Connectors: USB connector (Type B)

Power Supply: USB bus powered

Power: 500 mA or less

Dimensions: 428 x 42 x 189 mm (W x H x D)

Weight: 1.95 kg

Included items: USB cable, Quick Start Guide
with license code

7

END USER LICENSE AGREEMENT

This End User License Agreement ("Agreement") is a contract between you, either individual or single entity, and Softube AB ("Licensor"), a Swedish corporation regarding use of the accompanying software ("Software"). Please read through this Agreement carefully before installation and use of the Software. BY ACCEPTANCE OF THIS AGREEMENT OR by installation and/or use of the Software (THE EARLIEST OF SUCH ACTS CONSTITUTING THE EFFECTIVE DATE OF THIS AGREEMENT), you agree to be bound by the terms and conditions of this Agreement. Should you not accept the terms and conditions set forth in this Agreement, do not install the Software and delete the Software from your computer and any copies thereof.

1. The Software may not be used without a software license key. You may purchase a software license key from Licensor at the terms and conditions from time to time applied by the Licensor, which entitles you to use the Software on a perpetual basis ("Perpetual License"). You may also receive a temporary software license key which is intended to give you an opportunity to test and evaluate the Software ("Evaluation License"). Such Evaluation License is provided at the terms and conditions from time to time applied by Licensor. Please note that you are responsible for the software license key received and Licensor will not replace any lost software license keys.
2. Licensor and/or its licensors own all copyrights in and to the Software. The Software is protected by copyright laws and international copyright treaties, as well as other intellectual property laws and treaties. Any and all intellectual and other property rights to and in the Software vest in and shall remain vested in Licensor or its licensors. The Software is licensed, not sold.
3. Title and copyrights in and to the Software (including any images, photographs, animations, video, audio, music, and text incorporated into the Software), accompanying printed materials, and any copies End-Users are permitted to make herein are owned by Licensor or its licensors.
4. No right, title or interest in or to any trademark, service mark, logo, or trade name of Licensor or its licensors is granted to End-Users.
5. The End-User is granted a non-exclusive and non-transferable right to use the Software.
6. The End-User may not copy or reproduce the Software. The End-User may not transfer, sell, distribute, lend, rent, lease or in other way, directly or indirectly, dispose of the Software or any derivative work of the Software.
7. The End-User may not alter or modify the Software and may not analyze, reverse engineer, decompile or disassemble the Software or any part of the Software, incorporate the Software into any other application software, or print out the Software, except and only to the extent that such activity is expressly permitted by applicable law notwithstanding this limitation.
8. The End-User may use the Software for only as many simultaneous users, servers or other limiting parameters as are set out in the instructions of Licen-

sor according to the Agreement or otherwise.

9. The Software is installed on computer(s)/server(s) according to what is set forth in the agreement with the Licensor.
10. Except as provided for the Evaluation License, the license will continue until it is terminated. Licensor may terminate the license if you fail to comply with the terms of this Agreement. You may terminate the license at any time and for any reason. Upon termination by either party, you must delete the Software from your computer and any copies thereof.
11. Licensor warrants the media on which the Software is recorded to be free from defects in material and workmanship under normal use for a period of ninety (90) days from the date of purchase as evidenced by a copy of the receipt. Licensor's entire liability and your exclusive remedy will be replacement of the media not meeting the Licensor's limited warranty and which is returned to Licensor or an authorized representative of Licensor with a copy of the receipt. Licensor will have no responsibility to replace any media damaged by accident, abuse or misapplication.
12. The Software is provided strictly "AS IS," without warranty of any kind. ALL EXPRESSED OR IMPLIED REPRESENTATIONS AND WARRANTIES, INCLUDING ANY IMPLIED WARRANTY OF MERCHANTABILITY, FITNESS FOR A PARTICULAR PURPOSE OR NON-INFRINGEMENT, ARE HEREBY EXCLUDED. LICENSOR DOES NOT WARRANT THAT THE FUNCTIONS CONTAINED IN THE SOFTWARE WILL MEET YOUR REQUIREMENTS, OR THAT THE OPERATION OF THE SOFTWARE WILL BE INTERRUPTED OR ERROR-FREE, OR THAT DEFECTS IN THE SOFTWARE WILL BE CORRECTED. FURTHERMORE, LICENSOR DOES NOT WARRANT OR MAKE ANY REPRESENTATIONS REGARDING THE USE OR THE RESULTS OF THE USE OF THE SOFTWARE OR RELATED DOCUMENTATIONS IN TERMS OF THEIR CORRECTNESS, ACCURACY, RELIABILITY OR OTHERWISE. NOR ORAL OR WRITTEN INFORMATION OR ADVICE GIVEN BY LICENSOR OR AN AUTHORIZED REPRESENTATIVE OF LICENSOR SHALL CREATE A WARRANTY OR IN ANY WAY INCREASE THE SCOPE OF THIS WARRANTY. SHOULD THE SOFTWARE PROVE DEFECTIVE, YOU (AND NOT LICENSOR OR AN AUTHORIZED REPRESENTATIVE OF THE LICENSOR) ASSUME THE JURISDICTIONS. SOME STATES DO NOT ALLOW THE EXCLUSION OF IMPLIED WARRANTY, SO THE ABOVE EXCLUSION MAY NOT APPLY TO YOU.
13. NEITHER LICENSOR NOR ITS LICENSORS SHALL BE LIABLE FOR ANY DAMAGES SUFFERED BY YOU OR ANY THIRD PARTY AS A RESULT OF USE OR INABILITY TO USE THE SOFTWARE. IN NO EVENT WILL LICENSOR NOR ITS LICENSORS BE LIABLE FOR ANY LOST REVENUE, PROFIT OR ANTICIPATED SAVINGS, DATA, OR FOR DIRECT, INDIRECT, SPECIAL, CONSEQUENTIAL, INCIDENTAL OR PUNITIVE DAMAGES, HOWEVER CAUSED AND REGARDLESS OF THE THEORY OF LIABILITY, ARISING OUT OF THE USE OF OR INABILITY TO USE SOFTWARE, EVEN IF THAT PARTY HAS BEEN ADVISED OF THE POSSIBILITY OF SUCH DAMAGES. IN ANY CASE LICENSORS ENTIRE LIABILITY UNDER ANY PROVISION OF THIS AGREEMENT SHALL BE LIMITED TO THE AMOUNT ACTUALLY PAID BY YOU TO LICENSOR FOR THE SOFTWARE LICENCE KEY.
14. This Agreement shall be governed and construed in accordance with the laws of Sweden.

SOFTUBE LIMITED HARDWARE WARRANTY

1. Softube warrants to the end user Customer this hardware product against defects in materials and workmanship for a period of one (1) year after the date of the original purchase from Softube or from a channel authorized by Softube, provided the hardware product is unused at the time of purchase.
 2. If a defect exists, at its option Softube will (a) repair the product at no charge, using new or refurbished replacement parts, (b) exchange the product with a product that is new or which has been manufactured from new or serviceable used parts and is at least functionally equivalent to the original product, or (c) refund the purchase price of the product.
 3. A replacement product assumes the remaining warranty of the original product or 90 days, whichever provides longer coverage for the Customer. When a product or part is exchanged, any replacement item becomes the Customer's property and the replaced item Propellerhead's. When a refund is given, Customer's product becomes Softube's property.
 4. The Limited Warranty does not apply to any non-Softube hardware product or any software, even if packaged or sold with the Softube hardware. Manufacturers, suppliers, or publishers, other than Softube, may provide their own warranties to the end user purchaser, but Softube, in so far as permitted by law, provides their products "as is". Software distributed by Softube with or without the Softube brand name (including, but not limited to system software) is not covered under this Limited Hardware Warranty. Refer to the Softube End User License Agreement for details of rights with respect to Softube software use.
- Softube does not warrant that the operation of the product will be uninterrupted or error free. Softube is not responsible for damage arising from failure to follow instructions relating to the product's use.
5. It is the responsibility of the Customer to keep a separate backup copy of the system software, application software and data, and disable any security passwords. Customer is responsible for reinstalling all such software, data and passwords. Data recovery is not included in the warranty service and Softube is not responsible for data that may be lost or damaged during transit or during a repair.
 6. This Softube Limited Hardware Warranty applies only to hardware products manufactured by or for Softube that can be identified by the "Softube" trademark, trade name, or logo affixed to them. Softube Limited Hardware Warranty does not apply to any non-Softube hardware products or any software, even if packaged or sold with Softube hardware. Non-Softube manufacturers, suppliers, or publishers may provide their own warranties.
 7. This warranty does not apply: to damage caused by accident, abuse, misuse, misapplication; to damage caused by service (including upgrades and expansions) performed by anyone who is not a Softube Authorized Service Provider; to a product or part that has been modified without written permission of Softube; or if any Softube serial number has been removed or defaced.
 8. To the extent permitted by law, this warranty and the remedies set forth above are exclusive and in lieu of all other warranties, remedies and condi-

tions, whether oral or written, statutory, express or implied. As permitted by applicable law, Softube specifically disclaims any and all statutory or implied warranties, including, without limitation, warranties of merchantability and fitness for a particular purpose and warranties against hidden or latent defects. If Softube cannot lawfully disclaim statutory or implied warranties then to the extent permitted by law, all such warranties shall be limited in duration to the duration of the express warranty and to the repair or replacement service as determined by Softube in its sole discretion. No Softube distributor, agent, or employee is authorized to make any modification, extension, or addition to this warranty. If any term is held to be illegal or unenforceable, the legality or enforceability of the remaining terms shall not be affected or impaired. Except as provided in this warranty and to the maximum extent permitted by law, Softube is not responsible for direct, special, incidental or consequential damages resulting from any breach of warranty or condition, or under any other legal theory, including but not limited to loss of use; loss of revenue; loss of actual or anticipated profits (including loss of profits on contracts); loss of the use of money; loss of anticipated savings; loss of business; loss of opportunity; loss of goodwill; loss of reputation; loss of, damage to or corruption of data; or any indirect or consequential loss or damage howsoever caused including the replacement of equipment and property, any costs of recovering, programming or reproducing any program or data stored in or used with the Softube product, and any failure to maintain the confidentiality of data stored on the product. The foregoing limitation shall not apply to death or personal injury claims, or any statutory liability for intentional and gross negligent acts and/or omissions. Softube disclaims any representation that it will be able to repair any product under this warranty or make a product exchange without risk to or loss of programs or data.

Obtaining warranty service

Please visit the web site www.softube.com to access FAQ and documentation. Here you will find online help and guidance on how to operate and troubleshoot your product. If the product is still not functioning properly after making use of these resources, access the Support section at www.softube.com for instructions on how to obtain warranty service. You must follow Softube warranty processes to obtain full warranty service.

For consumers, who are covered by consumer protection laws or regulations in their country of purchase or, if different, their country of residence, the benefits conferred by this warranty are in addition to all rights and remedies conveyed by such consumer protection laws and regulations. Some countries, states and provinces do not allow the exclusion or limitation of incidental or consequential damages or allow limitations on how long an implied warranty or condition may last, so the limitations or exclusions described herein may not apply to you.



**ROCK 'N'
ROLL**

Scientists

in MONO or STEREO

MIX WITH CONFIDENCE

LINKÖPING SWEDEN

 Softube