

**Pioneer**

**DJ Controller**

# **DDJ-SB**

**serato** || **serato**  **DJ INTRO**

**<http://pioneeardj.com/support/>**

The Pioneer DJ support site shown above offers FAQs, information on software and various other types of information and services to allow you to use your product in greater comfort.

**<http://serato.com/>**

For the latest version of the Serato DJ Intro software, access Serato.com and download the software from there.

**Operating Instructions**

---

---

# Contents

## How to read this manual

- Thank you for buying this Pioneer product.  
Be sure to read both this leaflet and Read Before Use (Important)/ Quick Start Guide! Both documents include important information that you must understand before using this product.  
For instructions on obtaining the Serato DJ Intro software's manual, see *Acquiring the manual* (p.20).
- In this manual, names of screens and menus displayed on the product and on the computer screen, as well as names of buttons and terminals, etc., are indicated within brackets. (e.g.: [CUE] button, [Files] panel, [MIC] terminal)
- Please note that the screens and specifications of the software described in this manual as well as the external appearance and specifications of the hardware are currently under development and may differ from the final specifications.
- Please note that depending on the operating system version, web browser settings, etc., operation may differ from the procedures described in this manual.

This manual consists mainly of explanations of functions of this unit as hardware. For detailed instructions on operating the Serato DJ Intro software, see the Serato DJ Intro software manual.

- The Serato DJ Intro software manual can be downloaded from "Serato.com". For details, see *Downloading the Serato DJ Intro software manual* (p. 20).
- The latest version of these operating instructions can be downloaded from the Pioneer support site. For details, see *Downloading the latest version of these operating instructions* (p.20).

## 01 Before start

Features .....	3
What's in the box .....	3
Installing the software .....	3
About the driver software and setting utility software.....	5

## 02 Connections and part names

Connections .....	7
Part names and functions .....	7

## 03 Basic Operation

Connections .....	10
Starting the system.....	11
Quitting the system .....	13

## 04 Applied Operation

Using the performance pads.....	14
Using effects .....	15
Using the filter fade function .....	16
Mixing the sound of the microphone.....	17
Analyzing tracks.....	17

## 05 Utilities modes

Launching utilities mode .....	18
Changing the settings.....	18

## 06 Additional information

Troubleshooting.....	19
Acquiring the manual .....	20
Using as a controller for other DJ software.....	21
About trademarks and registered trademarks .....	22
Cautions on copyrights .....	22

# Before start

## Features

This unit is an all-in-one DJ system combining Pioneer DJ units that have earned a high reputation among professional DJs for their high operability with the "Serato DJ Intro" DJ software from Serato.

This unit is equipped with a large body and "Big Jog" dials optimum for scratching as well as performance pads allowing tracks to be arranged with such dynamic actions as tapping and rolling, so that the various functions of Serato DJ Intro can be operated intuitively and accurately. There is also a built-in sound card (audio interface), eliminating the need for complex wiring and settings so that users can start making DJ performances immediately.

### "BIG JOG"

This unit is equipped with large jog dials for smooth operability, so users can scratch with the feel of an analog player.

### "PERFORMANCE PADS"

This unit is equipped with large performance pads allowing the various functions provided with Serato DJ Intro, including the hot cue, loop and sampler functions, as well as the basic functions of the [CUE (|◀)] and [▶/||] buttons, to be operated with such dynamic actions as tapping and rolling.

Furthermore, rubber is used as the pad material to allow operation without tiring, even during long performances.

## Design

The operating interfaces required for DJs are arranged with room to spare on the large frame. Aluminum is used for the jog plates, and the plastic panel top plates have a hairline surface finish resulting in a design with a high-class look.

### "FILTER FADE"

This unit is equipped with a "Filter Fade" function that combines the crossfader and high pass filter so that any two tracks can be mixed naturally.

### "Serato DJ Intro"

This unit supports the Serato DJ Intro DJ software providing the basic functions required for DJ performances. All of the buttons and controls are preset to work together with the software, so DJ performances can be held immediately, simply by connecting this unit to a computer. Users can also upgrade to Serato DJ which provides a variety of functions, including a "Slip Mode", iZotope effects and a recording function. iZotope is a U.S. developer and manufacturer of audio technology.

### Built-in sound card (audio interface)

This unit is equipped with a built-in high quality sound card (audio interface), eliminating the need for complex wiring and settings so that users can start making DJ performances immediately.

## USB BUS POWER

This product supports USB bus power. It can be used simply by connecting it to a computer with a USB cable.

## HIGH SOUND QUALITY

This product inherits the sound quality technology developed over the years for Pioneer DJ hardware to achieve the top level of sound quality in its class.

## What's in the box

- CD-ROM (Installation Disc)
- USB cable
- Warranty (for some regions)<sup>[1]</sup>
- Read Before Use (Important)/Quick Start Guide

- [1] The included warranty is for the European region.
- For the North American region, the corresponding information is provided on the last page of both the English and French versions of the "Read Before Use (Important)/Quick Start Guide".
  - For the Japanese region, the corresponding information is provided on the last page of the Japanese version of the "Read Before Use (Important)/Quick Start Guide".

## Installing the software

### Before installing the software

For the latest version of the Serato DJ Intro software, access Serato.com and download the software from there. A software download link is also provided on the included CD-ROM.

- For details, refer to *Installation Procedure (Windows)* or *Installation procedure (Mac OS X)*.
- The user is responsible for preparing the computer, network devices and other elements of the Internet usage environment required for a connection to the Internet.

### About the driver software (Windows)

This driver software is an exclusive ASIO driver for outputting audio signals from the computer.

- There is no need to install the driver software when using Mac OS X.

### Checking the latest information on the driver software

For detailed information on this unit's designated driver software, see the Pioneer DJ support site below.

<http://pioneerdj.com/support/>

## About the Serato DJ Intro software

Serato DJ Intro is a DJ software application by Serato. DJ performances are possible by connecting the computer on which this software is installed to this unit.

### Minimum operating environment

Supported operating systems	CPU and required memory
Mac OS X: 10.8, 10.7 and 10.6	Intel® processor, Core™ Duo 1.6 GHz or better 1 GB or more of RAM
Windows: Windows 7 (SP1) and Windows Vista (SP1)	Intel® processor, Core™ 2 Duo 2.0 GHz or better 1 GB or more of RAM

Others	
Optical drive	Optical disc drive on which the CD-ROM can be read
USB port	A USB 2.0 port is required to connect the computer with this unit.
Display resolution	Resolution of 1 024 x 768 or greater
Internet connection	An Internet connection is required for registering the "Serato.com" user account and downloading the software.

- For the latest information on the required operating environment and compatibility as well as to acquire the latest operating system, refer to "Software Info" under "DDJ-SB" on the Pioneer DJ support site below.  
<http://pioneerdj.com/support/>
- Operating System support assumes you are using the latest point release for that version.
- Operation is not guaranteed on all computers, even if all the required operating environment conditions indicated here are fulfilled.
- Depending on the computer's power-saving settings, etc., the CPU and hard disk may not provide sufficient processing capabilities. For notebook computers in particular, make sure the computer is in the proper conditions to provide constant high performance (for example by keeping the AC power connected) when using Serato DJ Intro.
- Use of the Internet requires a separate contract with a provider offering Internet services and payment of provider fees.

## About the installation procedure

The installation procedure depends on the operating system (OS) on the computer you are using.

### For Windows

After installing the driver software, install the Serato DJ Intro software.

### For Mac OS X

Only install the Serato DJ Intro software.

## Installation Procedure (Windows)

Do not connect this unit and the computer until installation is completed.

- Log on as the user which was set as the computer's administrator before installing.
- If any other programs are running on the computer, quit them.

### 1 Insert the CD-ROM into the computer's optical drive.

The CD-ROM menu is displayed.

- If the CD-ROM menu does not appear when the CD-ROM is inserted, open the optical drive from [Computer (or My Computer)] in the [Start] menu, then double-click the [CD\_menu.exe] icon.

### 2 When the CD-ROM menu appears, select [Install Driver Software (Pioneer\_DDJ\_SB\_Driver\_x.xxx.exe)], then click [Start].

- To close the CD-ROM menu, click [Exit].

### 3 Proceed with installation according to the instructions on the screen.

If [Windows Security] appears on the screen while the installation is in progress, click [Install this driver software anyway] and continue with the installation.

When the installation program is completed, a completion message appears.

After installing the driver software, install the Serato DJ Intro software.

### 4 Select [Download Serato DJ Intro Software] from the CD-ROM's menu, then click [Start].

5 "An internet environment is required to access the site. Connected to the internet?" is displayed. Click [Yes].  
The web browser is launched and the Pioneer DJ support site is displayed.

### 6 Click [Software Info] under [DDJ-SB] on the Pioneer DJ support site.

7 Click the link to the Serato DJ Intro download page.  
The Serato DJ Intro download page is displayed.

### 8 Log in to your "Serato.com" user account.

- If you have already registered a user account on "Serato.com", proceed to step 10.
- If you have not completed registering your user account, do so following the procedure below.
  - Following the instructions on the screen, input your e-mail address and the password you want to set, then select the region in which you live.
  - If you check [E-mail me Serato newsletters], newsletters providing the latest information on Serato products will be sent from Serato.
  - Once user account registration is completed, you will receive an e-mail at the e-mail address you have input. Check the contents of the e-mail sent from "Serato.com".
- Be careful not to forget the e-mail address and password specified when you performed user registration. They will be required for updating the software.
- The personal information input when registering a new user account may be collected, processed and used based on the privacy policy on the Serato website.

### 9 Click the link in the e-mail message sent from "Serato.com".

This takes you to the Serato DJ Intro download page. Proceed to step 11.

### 10 Log in.

Input the e-mail address and password you have registered to log in to "Serato.com".

### 11 Download the Serato DJ Intro software from the download page.

Unzip the downloaded file, then double-click the unzipped file to launch the installer.

### 12 Read the terms of the license agreement carefully, and if you agree, select [I accept the agreement], then click [Next].

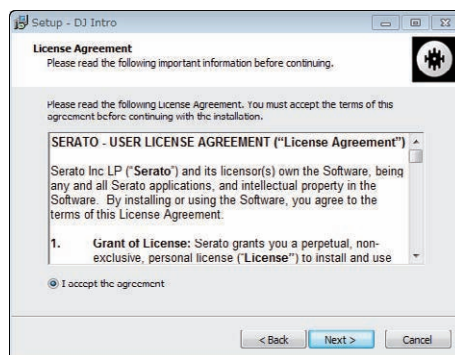

- If you do not agree to the contents of the license agreement, click [Cancel] to cancel installation.

Installation begins.

The message of successful installation appears once installation is completed.

### 13 Click [Finish] to quit the Serato DJ Intro installer.

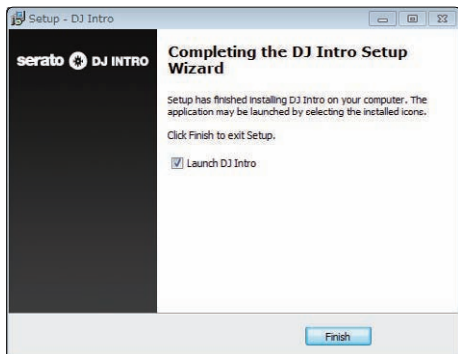

## Installation procedure (Mac OS X)

Do not connect this unit and the computer until installation is completed.

- If any other programs are running on the computer, quit them.

### 1 Insert the CD-ROM into the computer's optical drive.

The CD-ROM menu is displayed.

- If the CD-ROM menu does not appear on the screen when the CD-ROM is inserted, open the optical driver from Finder, then double-click the [CD\_menu.app] icon.

### 2 Select [Download Serato DJ Intro Software] from the CD-ROM's menu, then click [Start].

### 3 "An internet environment is required to access the site. Connected to the internet?" is displayed. Click [Yes].

The web browser is launched and the Pioneer DJ support site is displayed.

### 4 Click [Software Info] under [DDJ-SB] on the Pioneer DJ support site.

### 5 Click the link to the Serato DJ Intro download page.

The Serato DJ Intro download page is displayed.

### 6 Log in to your "Serato.com" user account.

- If you have already registered a user account on "Serato.com", proceed to step 8.
- If you have not completed registering your user account, do so following the procedure below.
  - Following the instructions on the screen, input your e-mail address and the password you want to set, then select the region in which you live.
  - If you check [E-mail me Serato newsletters], newsletters providing the latest information on Serato products will be sent from Serato.
  - Once user account registration is completed, you will receive an e-mail at the e-mail address you have input. Check the contents of the e-mail sent from "Serato.com".
- Be careful not to forget the e-mail address and password specified when you performed user registration. They will be required for updating the software.
- The personal information input when registering a new user account may be collected, processed and used based on the privacy policy on the Serato website.

### 7 Click the link in the e-mail message sent from "Serato.com".

This takes you to the Serato DJ Intro download page. Proceed to step 9.

### 8 Log in.

Input the e-mail address and password you have registered to log in to "Serato.com".

### 9 Download the Serato DJ Intro software from the download page.

Unzip the downloaded file, then double-click the unzipped file to launch the installer.

### 10 Read the terms of the license agreement carefully, and if you agree, click [Agree].

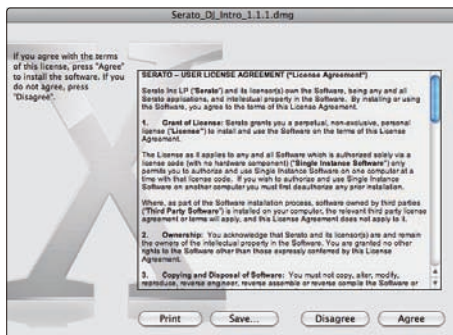

- If you do not agree to the contents of the usage agreement, click [Disagree] to cancel installation.

### 11 If the following screen appears, drag and drop the [Serato DJ Intro] icon on the [Applications] folder icon.



## About the driver software and setting utility software

This unit functions as an audio device conforming to the ASIO standards.

## Using the settings utility software

This function can only be used by those using a Windows operating system.

### ❖ Launching the settings utility software

Click the Windows [Start] menu>[All Programs]>[Pioneer]>[DDJ\_SB]>[DDJ\_SB ASIO Settings Utility].

### ❖ Adjusting the buffer size

In the same way as the buffer size setting in the Serato DJ Intro software, decreasing the value of the [Kernel Buffers] setting lowers the transfer delay (latency) of the audio data, while increasing the value reduces the tendency for dropouts in the audio data (breaks in the sound). The setting at [USB BUFFER SIZE (LATENCY)] in the Serato DJ Intro software's [SETUP] menu has priority for the buffer size. (The default setting is 512 samples/10 ms.)

- For details on making the settings on the DJ software, see the Serato DJ Intro software manual.
- If the [Buffer Size] or [Kernel Buffers] number is made large, drops in the data (breaks in the sound), etc., occur less easily, but the time lag due to transmission delays in the audio data (latency) increases.

❖ **If breaks in the sound occur with the default setting**

- 1 Launch [DDJ\_SB ASIO Settings Utility] and change [Kernel Buffers] to [4].
- 2 Set [USB BUFFER SIZE (LATENCY)] in the Serato DJ Intro software to the minimum buffer size at which no breaks in the sound occur.

❖ **If no breaks in the sound occur with the default setting**

- 1 Set [USB BUFFER SIZE (LATENCY)] in the Serato DJ Intro software to the minimum buffer size at which no breaks in the sound occur.
- 2 Launch [DDJ\_SB ASIO Settings Utility], change [Kernel Buffers] to [2], and check that no breaks in the sound occur.
- 3 If no breaks in the sound occur, set [USB BUFFER SIZE (LATENCY)] in the Serato DJ Intro software to the minimum buffer size at which no breaks in the sound occur. If breaks in the sound do occur, change [Kernel Buffers] in the [DDJ\_SB ASIO Settings Utility] to [3].

---

## **Checking the version of the driver software**

Click the Windows [Start] menu>[All Programs]>[Pioneer]>[DDJ\_SB]>[DDJ\_SB Version Display Utility].

- You can check the firmware version of this unit on the screen.
- The firmware version is not displayed when this unit is not connected to the computer or when this unit and computer are not properly communicating.

# Connections and part names

## Connections

Always disconnect the USB cable before making or changing equipment connections.

Be sure to use the USB cable included with this product.

Refer to the operating instructions for the component to be connected.

With this unit, the power is supplied by USB bus power. The unit can be used simply by connecting it to a computer using the USB cable.

- Connect the computer to which this unit is to be connected to an AC power supply.
- A USB hub cannot be used.
- In cases like the ones below, the power may be insufficient and this unit may not operate on USB bus power.
  - When the computer's USB power supply capacity is insufficient.
  - When other USB devices are connected to the computer.
  - When headphones with an impedance of less than  $32\ \Omega$  are connected.
  - When headphones are simultaneously connected to the stereo phone jack and the stereo mini-phone jack.
  - When a monaural jack is connected to the [HEADPHONES] terminal.

## Rear panel

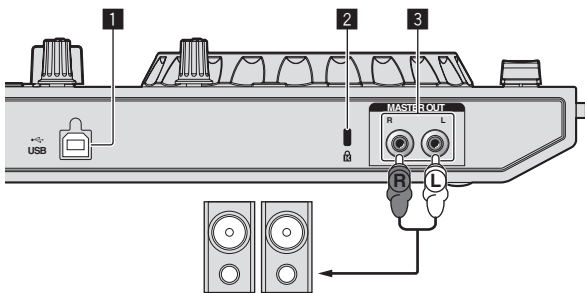

Power amplifier, powered speakers, etc.

### 1 USB terminal

Connect to a computer.

- Connect this unit and the computer directly using the included USB cable.
- A USB hub cannot be used.

### 2 Kensington security slot

### 3 MASTER OUT terminals

Connect a power amplifier, powered speakers, etc., here.

- Compatible with RCA pin-jack type unbalanced outputs.

## Main unit side panel

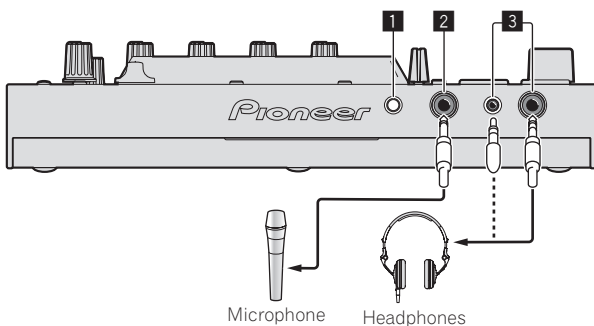

Microphone

Headphones

### 1 MIC LEVEL control

Adjusts the audio level input to the [MIC] terminal.

### 2 MIC jack

Connects a microphone here.

### 3 HEADPHONES jacks

Connect headphones here.

Both stereo phone plugs ( $\varnothing 6.3\ \text{mm}$ ) and stereo mini phone plugs ( $\varnothing 3.5\ \text{mm}$ ) can be used.

- There are two input jacks, both a stereo phones jack and a mini phones jack, but do not use both simultaneously. If both are used simultaneously, when one is disconnected and/or connected, the volume of the other may increase or decrease suddenly.

## Part names and functions

The functions of the parts introduced here are based on the functions of Serato DJ Intro.

Descriptions of functions that can be used after upgrading to Serato DJ are indicated **Serato DJ**.

For details of the functions, see the Pioneer DJ support site below.

<http://pioneerdj.com/support/>

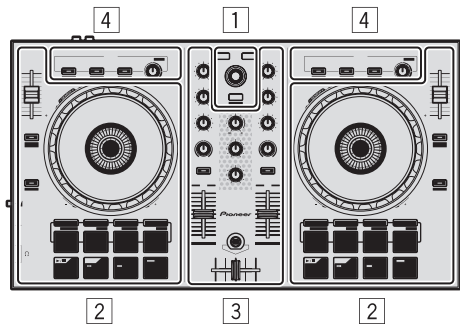

### 1 Browser section

### 2 Deck section

### 3 Mixer section

### 4 Effect section

## Browser section

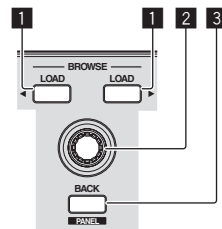

### 1 LOAD button

Press:

The selected tracks are loaded to the respective decks.

- When the [LOAD] button is pressed twice, the tracks loaded in the selected deck on the opposite side are loaded into the deck whose [LOAD] button was pressed. When this is done while a track is playing, the track is played from the same position. (Instant Double)

## 2 Rotary selector

Turn:

The cursor in the library, crates panel, etc., moves up or down.

Press:

When the cursor is positioned in the crates panel, moves the cursor to the library.

The cursor moves between the crates panel and library each time the rotary selector is pressed.

The cursor on the [Files] panel moves to a lower layer.

## 3 BACK (PANEL) button

Press:

When the cursor is positioned in the crates panel, either opens or closes the sub crates.

When the cursor is positioned in the library, moves the cursor to the crates panel.

The cursor on the [Files] panel moves to a higher layer.

[SHIFT] + press:

**Serato DJ**

The panel display switches in the order below each time the button is pressed.

Panel display off → [REC] panel → [FX] panel → [SP-6] panel →

Panel display off...

## Deck section

The deck section is used to control the two decks. There are controls and buttons for operating deck 1 on the left side of the controller, controls and buttons for operating deck 2 on the right side of the controller.

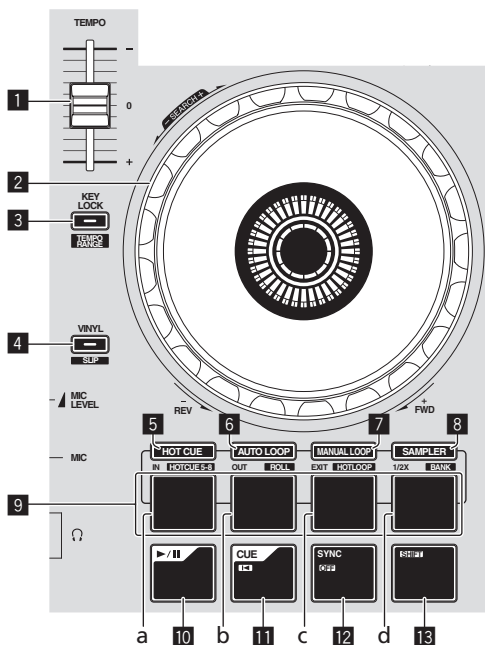

## 1 TEMPO slider

Use this to adjust the track playing speed.

## 2 Jog dial

Turn top:

When the vinyl mode is on, the scratch operation is possible.

When the vinyl mode is off, the pitch bend operation (adjustment of the playing speed) is possible.

Turn outer section:

The pitch bend operation (adjustment of the playing speed) is possible.

[SHIFT] + Turn top:

When the jog dial is spun while pressing [SHIFT] button during playback, the track is fast-forwarded/fast-reversed.

## 3 KEY LOCK (TEMPO RANGE) button

Press:

Turns the key lock function on and off.

When the key lock function is on, the key does not change even when the playing speed is changed with the [TEMPO] slider.

- The sound is digitally processed, so the sound quality decreases.

[SHIFT] + press:

The [TEMPO] slider's range of variation switches each time the button is pressed.

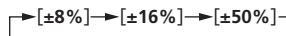

## 4 VINYL (SLIP) button

This switches the vinyl mode on/off.

[SHIFT] + press:

**Serato DJ**

Turns the slip mode on and off.

## 5 HOT CUE mode button

Press:

Sets the hot cue mode.

[SHIFT] + press:

**Serato DJ**

Sets the hot cue 5–8 mode.

## 6 AUTO LOOP mode button

Press:

Sets the auto loop mode.

[SHIFT] + press:

**Serato DJ**

Sets the roll mode.

## 7 MANUAL LOOP mode button

Press:

Sets the manual loop mode.

[SHIFT] + press:

**Serato DJ**

Sets the hot loop mode.

## 8 SAMPLER mode button

Press:

Sets the sampler mode.

[SHIFT] + press:

**Serato DJ**

Sets the bank mode.

## 9 Performance pads

- Performance pad 1
- Performance pad 2
- Performance pad 3
- Performance pad 4

Various performances can be achieved using the pads.

➡ *Using the performance pads* (p.14)

## 10 ►/|| button

Press:

Use this to play/pause tracks.

## 11 CUE (I◀) button

Press:

This is used to set, play and call out temporary cue points.

- When the [CUE (I◀)] button is pressed while pausing, the temporary cue point is set.
- When the [CUE (I◀)] button is pressed during playback, the track returns to the temporary cue point and pauses. (Back Cue)
- When the [CUE (I◀)] button is pressed and held after the track returns to the temporary cue point, playback continues as long as the button is pressed in. (Cue Sampler)



- When the [▶/II] button is pressed during cue sampling, playback continues from that point.

[SHIFT] + press:

Loads the previous track in the library. (Previous Track)

- If the current playback position is not the beginning of a track, the track returns to the beginning.

## 12 SYNC (OFF) button

Press:

The tempo (pitch) of tracks on adjacent decks can be synchronized automatically.

[SHIFT] + press:

Cancels the sync mode.

## 13 SHIFT button

When another button is pressed while pressing the [SHIFT] button, a different function is called out.

## Mixer section

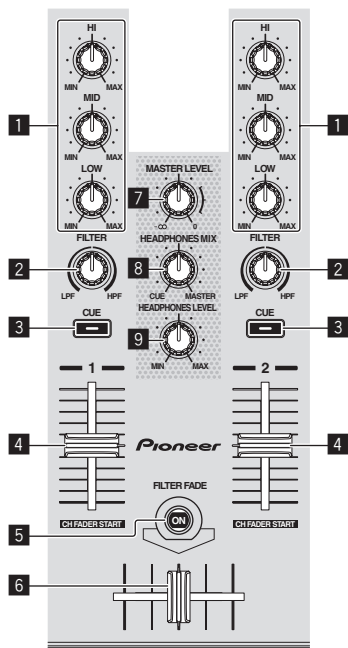

### 1 EQ (HI, MID, LOW) controls

Boosts or cuts frequencies for the different channels.

### 2 FILTER control

Applies the filter effect for the respective channel.

The original sound is output when the control is at the center position.

Turn counterclockwise: Gradually decreases the low-pass filter's cutoff frequency.

Turn clockwise: Gradually increases the high-pass filter's cutoff frequency.

### 3 Headphones CUE button

Press:

The sound of channels for which the headphones [CUE] button is pressed is output to the headphones.

- When the headphones [CUE] button is pressed again, monitoring is canceled.

### 4 Channel fader

Move:

Adjusts the level of audio signals output in each channel.

[SHIFT] + move:

**Serato DJ**

Use the channel fader start function.

## 5 FILTER FADE button

Turns the filter fade function on and off.

➔ *Using the filter fade function (p.16)*

## 6 Crossfader

Switches between the audio output of the left and right decks.

## 7 MASTER LEVEL control

Adjusts the master sound level output.

## 8 HEADPHONES MIX control

Adjusts the balance of the monitor volume between the sound of the channels for which the headphones [CUE] button is pressed and the sound of the master channel.

## 9 HEADPHONES LEVEL control

Adjusts the sound level output from the headphones.

## Effect section

This section is used to control the two effect units (FX1 and FX2).

Controls and buttons to operate the FX1 unit are located on the left side of the controller, those to operate the FX2 unit are located on the right side of the controller.

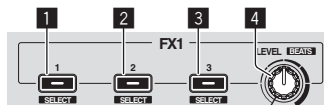

### 1 Effect 1 button

Turns the effect on/off.

[SHIFT] + press:

Switches the effect type.

### 2 Effect 2 button

Turns the effect on/off.

[SHIFT] + press:

Switches the effect type.

### 3 Effect 3 button

Turns the effect on/off.

[SHIFT] + press:

Switches the effect type.

### 4 Effect level controls

These adjust the effects' parameters.

➔ *Using effects (p.15)*

[SHIFT] + press:

Adjusts the effect time.

# Basic Operation

## Connections

1 Connect headphones to one of the [HEADPHONES] terminals.

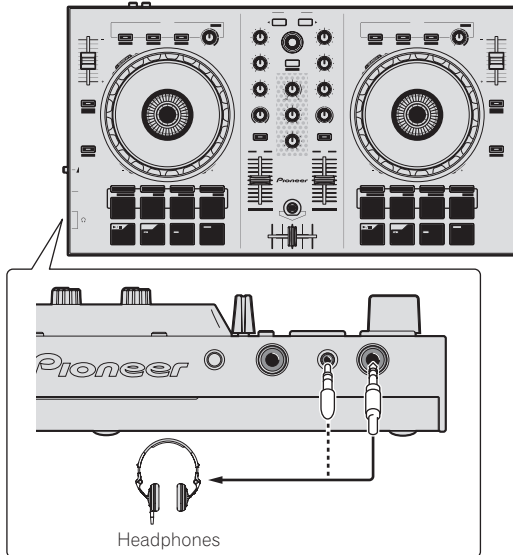

2 Connect such devices as a power amplifier, powered speakers, etc., to the [MASTER OUT] terminals.

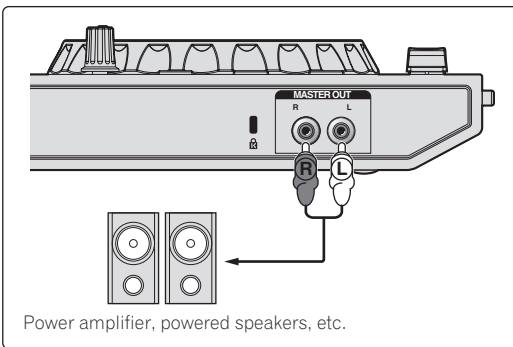

- For details on the connections of the input/output terminals, see *Connections* (p.7).

3 Turn on the computer's power.

4 Connect this unit to your computer via a USB cable.

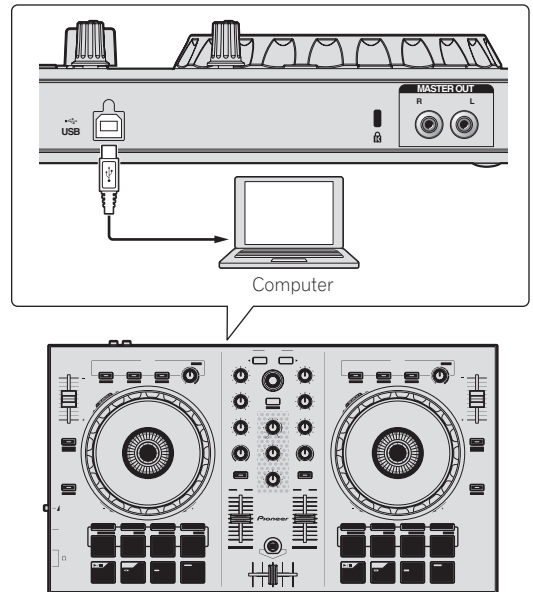

- For Windows users  
The message [Installing device driver software] may appear when this unit is first connected to the computer or when it is connected to a different USB port on the computer. Wait a while until the message [Your devices are ready for use] appears.

5 Turn on the power of the devices connected to the output terminals (power amplifier, powered speakers, etc.).

- When a microphone is connected to input terminals, the power of the microphone also turns on.

# Starting the system

## Launching Serato DJ Intro

### For Windows

From the Windows [Start] menu, click the [Serato DJ Intro] icon under [All Programs] > [Serato] > [DJ Intro].

### For Mac OS X

In Finder, open the [Applications] folder, then click the [Serato DJ Intro] icon.

## Computer screen directly after the Serato DJ Intro software is launched



## Computer screen when a track is loaded in the Serato DJ Intro software

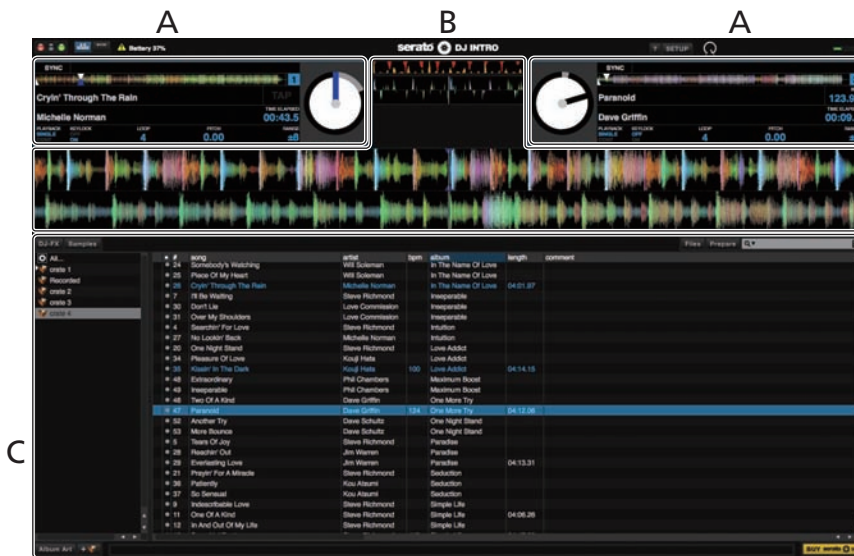

### A Deck section

The track information (the name of the loaded track, artist name, BPM, etc.), the overall waveform and other information is displayed here.

### B Waveform display

The loaded track's waveform is displayed here.

### C Browser section

Crates in which tracks in the library or sets of multiple tracks are stored are displayed here.

This manual consists mainly of explanations of functions of this unit as hardware. For detailed instructions on operating the Serato DJ Intro software, see the Serato DJ Intro software manual.

## Importing tracks

The following describes the typical procedure for importing tracks.

- There are various ways to import tracks with the Serato DJ Intro software. For details, see the Serato DJ Intro software manual.
- If you are already using Serato DJ software (Scratch Live, ITCH or Serato DJ) and have already created track libraries, the track libraries you have previously created can be used as such.

### 1 Click the [Files] key on the Serato DJ Intro software screen to open the [Files] panel.

The contents of your computer or the peripheral connected to the computer are displayed in the [Files] panel.

### 2 Click the folder on the [Files] panel containing the tracks you want to add to the library to select it.

### 3 On the Serato DJ Intro software screen, drag and drop the selected folder to the crates panel.

A crate is created and the tracks are added to the library.



- a [Files] panel
- b Crates panel

## Loading tracks and playing them

The following describes the procedure for loading tracks into deck [1] as an example.

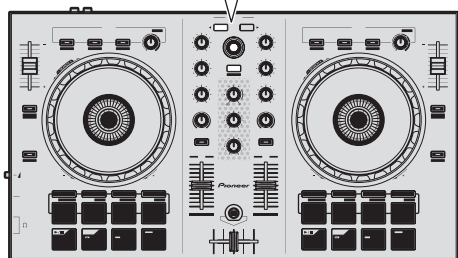
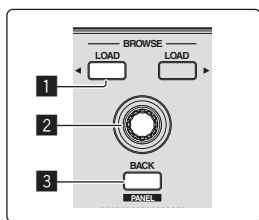

- 1 LOAD button
- 2 Rotary selector
- 3 BACK (PANEL) button

1 Press this unit's [BACK (PANEL)] button, move the cursor to the crates panel on the computer's screen, then turn the rotary selector to select the crate, etc.

2 Press the rotary selector, move the cursor to the library on the computer's screen, then turn the rotary selector and select the track.

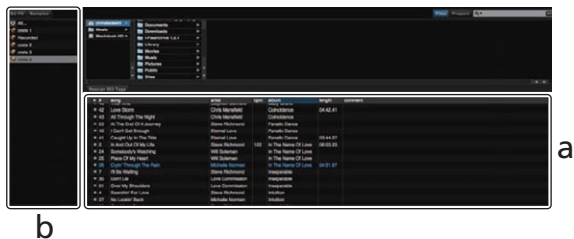

- a Library
- b Crates panel

3 Press the [LOAD] button to load the selected track onto the deck.

## Playing tracks and outputting the sound

The following describes the procedure for outputting the channel 1 sound as an example.

- Set the volume of the device connected to the **[MASTER OUT]** terminals (power amplifier, powered speakers, etc.) to an appropriate level. Note that the output sound may be loud if the volume is set too high.

### Mixer section

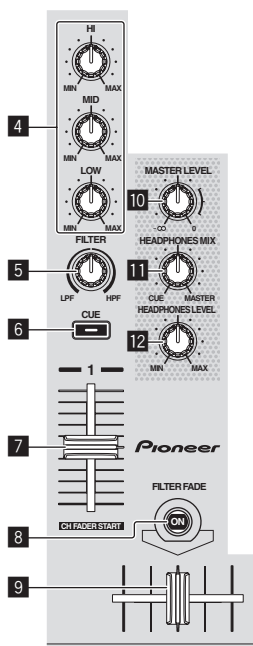

- 4 EQ (HI, MID, LOW) controls
- 5 FILTER control
- 6 Headphones CUE button
- 7 Channel fader
- 8 FILTER FADE button
- 9 Crossfader
- 10 MASTER LEVEL control
- 11 HEADPHONES MIX control
- 12 HEADPHONES LEVEL control

1 Set the positions of the controls, etc., as shown below.

Names of controls, etc.	Position
EQ (HI, MID, LOW) controls	Center
FILTER control	Center
Channel fader	Moved forward
MASTER LEVEL control	Turned fully counterclockwise

2 Press the **[▶/||]** button to play the track.

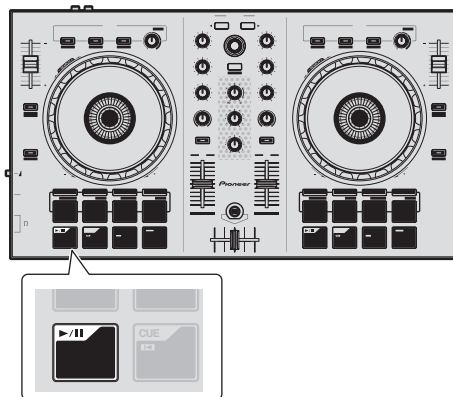

3 Move the channel fader away from you.

4 Turn the **[MASTER LEVEL]** control to adjust the audio level of the speakers.

Adjust the audio level output from the **[MASTER OUT]** terminals to an appropriate level.

## Monitoring sound with headphones

Set the positions of the controls, etc., as shown below.

Names of controls, etc.	Position
HEADPHONES MIX control	Center
HEADPHONES LEVEL control	Turned fully counterclockwise

1 Press the headphones **[CUE]** button for the channel 1.

2 Turn the **[HEADPHONES LEVEL]** control.

Adjust the sound level output from the headphones to an appropriate level.

### Note

This unit and the Serato DJ Intro software include a variety of functions enabling individualistic DJ performances. For details on the respective functions, see the operating instructions and the Serato DJ Intro software manual.

- This unit's operating instructions can be downloaded from the Pioneer DJ support site. For details, see *Downloading the latest version of these operating instructions* (p. 20).
- The Serato DJ Intro software manual can be downloaded from Serato.com. For details, see *Downloading the Serato DJ Intro software manual* (p. 20).

## Quitting the system

1 Quit Serato DJ Intro.

When the software is closed, a message for confirming that you want to close it appears on the computer's screen. Click **[Yes]** to close.

2 Disconnect the USB cable from your computer.

# Applied Operation

The descriptions from this point on are for functions not described in the Serato DJ Intro software manual that are specifically for when this unit and Serato DJ Intro are used in combination.

## Using the performance pads

There are four modes for the DDJ-SB's performance pads.

### Pad mode

These control the hot cue, auto loop, manual loop and sampler functions.

These functions are switched using the respective pad mode buttons (the [HOT CUE] mode button, [AUTO LOOP] mode button, [MANUAL LOOP] mode button and [SAMPLER] mode button).

## Using hot cues

With this function, playback can be started instantaneously from the position at which a hot cue is set.

- Up to four hot cue points can be set and saved per track.

### 1 Press the [HOT CUE] mode button.

The [HOT CUE] mode button lights and the hot cue mode is set.

### 2 In the play or pause mode, press a performance pad to set the hot cue point.

The hot cue points are assigned to the respective performance pads as shown below.

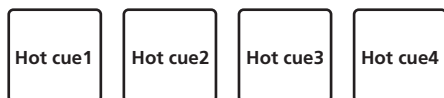

### 3 Press the performance pad at which the hot cue point was set.

Playback starts from the hot cue point.

- Set hot cue points can be cleared by pressing a performance pad while pressing the [SHIFT] button.

## Using auto loops

Use this procedure to set loops of 1, 2, 4 or 8 beats based on the track's BPM.

### 1 Press the [AUTO LOOP] mode button.

The [AUTO LOOP] mode button lights, and the unit switches to the auto loop mode.

### 2 Press a performance pad during playback to turn the auto loop on.

The auto loop beats are assigned to the respective pads as shown below.



### 3 Press the performance pad again to turn the auto loop off.

## Using manual loops

Use this procedure to set loops manually.

### 1 Press the [MANUAL LOOP] mode button.

The [MANUAL LOOP] mode button lights, and the unit switches to the manual loop mode.

### 2 During playback, press performance pad 1 to set the loop in point.

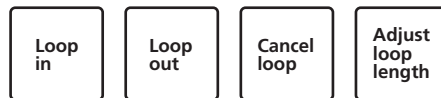

### 3 During playback, press performance pad 2 to set the loop out point.

Manual looping between the loop in point and the loop out point starts.

### 4 Press performance pad 3 during manual loop playback to cancel manual looping.

- When performance pad 3 is pressed during playback after canceling manual loop playback, playback returns to the previously set loop in point and manual loop playback resumes.

### ❖ Switching the length of manual loops

- When performance pad 4 is pressed during manual loop playback, the manual loop playback length is cut in half each time the pad is pressed.
- When performance pad 4 is pressed while pressing the [SHIFT] button during manual loop playback, the manual loop playback length is doubled each time the pad is pressed.

### ❖ Fine-adjusting the length of manual loops

- When performance pad 1 is pressed during manual loop playback, the jog dial can be used to fine-adjust the loop in point.
  - When performance pad 1 is pressed again, the fine-adjustment mode is canceled and manual loop playback resumes.
- When performance pad 2 is pressed during manual loop playback, the jog dial can be used to fine-adjust the loop out point.
  - When performance pad 2 is pressed again, the fine-adjustment mode is canceled and manual loop playback resumes.

## Using the sampler function

This procedure can be used to play tracks loaded in the sampler's sampler slots using the performance pads.

### 1 Click [Samples] on the computer screen to open the [Samples] panel on the computer screen.

### 2 Press the [SAMPLER] mode button.

The [SAMPLER] mode button lights and the mode switches to the sampler mode.

### 3 Operating the mouse on the computer's screen, drag and drop tracks to load them into the [Samples] panel's slots.

The sampler settings and loaded tracks are saved.

### 4 Press a performance pad.

The sound for the slot assigned to the pad that was pressed is played.

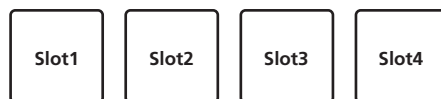

- When a performance pad is pressed while pressing the [SHIFT] button, the sound of the slot that is currently playing stops.

## Using effects

Serato DJ Intro includes two effect units, FX1 and FX2. Three effects per effect unit can be selected for the respective units. Effect unit FX1 is applied to deck 1, effect unit FX2 is to deck 2.

### Serato DJ Intro effects unit screen display

When [DJ-FX] on the computer screen is clicked, the [DJ-FX] panel is displayed on the computer screen.

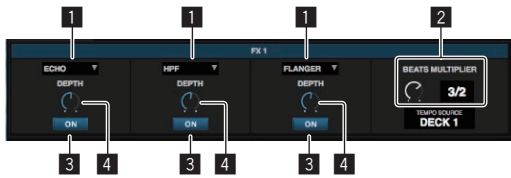

- 1 This displays the effect type.
- 2 This displays the effect time.
- 3 This displays whether the effect is on or off.
- 4 This displays the effect's level.

This unit's effect level controls control the levels of all three of Serato DJ Intro's effects simultaneously. This unit can be used to control up to three effects simultaneously.



## Operating effects

The explanation below describes operation of the first effect for effect unit FX1 as an example.

Note that the procedure described in this manual is just one example; operation is also possible using other procedures.

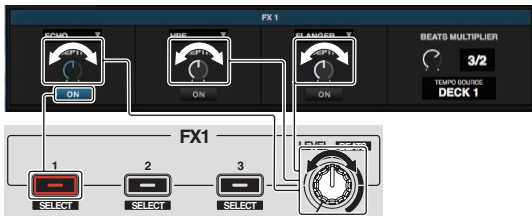

### 1 Press the effect 1 button while pressing the [SHIFT] button to select the type of the first effect.

The effect type is displayed on the Serato DJ Intro screen.

### 2 Operate an effect level control to adjust the effect level.

The positions of all three effect level controls on the Serato DJ Intro screen move simultaneously.

- The positions of the effect level controls cannot be moved individually.

### 3 Operate the effect level control while pressing the [SHIFT] button to adjust the effect time.

- To adjust the effect level and the effect time alternately, the position of the effect level control on the Serato DJ Intro screen must be matched to the position of the effect level control on this unit. For details, see *Performing the operations for adjusting the effect level and adjusting the effect time alternately* on page 16.

### 4 Press the effect 1 button to turn the first effect on.

The first effect's [ON] button on the Serato DJ Intro screen is highlighted.

- After turning the effect on, you can repeat steps 2 and 3 to adjust the effect level and effect time.

### 5 Press the effect 1 button to turn the first effect off.

## Operating the three effects simultaneously

The explanation below describes operation of three effects simultaneously as an example.

Note that the procedure described in this manual is just one example; operation is also possible using other procedures.

### Example of operation

- 1 Set the effect level to 0% (control turned all the way counterclockwise). Turn the first effect on.
- 2 While gradually raising the effect level, turn the second effect on.
- 3 While further raising the effect level, turn the third effect on.
- 4 Raise the effect level to 100% (control turned all the way clockwise). Finally, turn all three effects off.

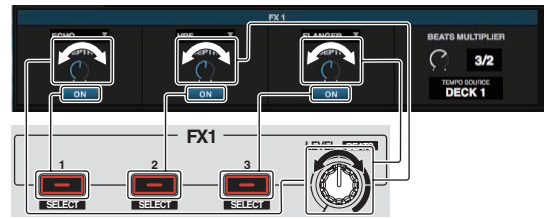
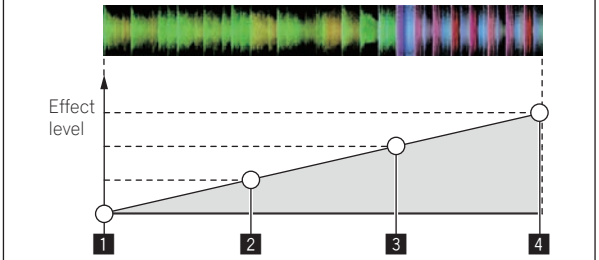

### 1 Select the effect type.

Press the effect 1 button while pressing the [SHIFT] button to select the type of the first effect.

Press the effect 2 button while pressing the [SHIFT] button to select the type of the second effect.

Press the effect 3 button while pressing the [SHIFT] button to select the type of the third effect.

### 2 Operate an effect level control to adjust the effect level.

In this example of operation, the effect level control is set at the fully counterclockwise (0%) position.

### 3 Press the effect 1 button to turn the first effect on.

The first effect turns on.

### 4 Operate an effect level control to adjust the effect level.

Turn the effect level control gradually clockwise to raise the effect level. With this operation, only the first effect is active.

### 5 Press the effect 2 button to turn the second effect on.

The first and second effects are now on simultaneously.

### 6 Operate an effect level control to adjust the effect level.

Turn the effect level control a little more clockwise to raise the effect level.

With this operation, both the first and second effects are active.

### 7 Press the effect 3 button to turn the third effect on.

The three effects are now on simultaneously.

## 8 Operate an effect level control to adjust the effect level.

Turn the effect level control a little more clockwise to raise the effect level.

With this operation, all three effects are active.

## 9 Turn the effects off.

Press the effect 1 button to turn the first effect off.

Press the effect 2 button to turn the second effect off.

Press the effect 3 button to turn the third effect off.

- When multiple effects are on, their respective effect levels are the same.

The effect levels of the respective effects cannot be adjusted individually.



When the position of the effect level controls on the Serato DJ Intro screen matches the position of the effect level controls on this unit, the effect time can be adjusted.

- Effect level: 50 % (control set to the center position)



## Performing the operations for adjusting the effect level and adjusting the effect time alternately

The explanation below describes performing the operations for adjusting the effect level and adjusting the effect time alternately as an example. Note that the procedure described in this manual is just one example; operation is also possible using other procedures.

### Example of operation

- Adjust the effect level from 0 % (control turned fully counterclockwise) to 100 % (control turned fully clockwise).
- Adjust the effect time from [1/1] to [1/2].
- Adjust the effect level from 100 % (control turned fully clockwise) to 50 % (control set to the center position).

## 1 Operate an effect level control to adjust the effect level.

Adjust the effect level from 0 % (control turned fully counterclockwise) to 100 % (control turned fully clockwise).

- Effect level: 0 % (control turned fully counterclockwise)



- Effect level: 100 % (control turned fully clockwise)



## 2 Operate the effect level control while pressing the [SHIFT] button to adjust the effect time.

Adjust the effect time from [1/1] to [1/2].

The position of the effect level controls on the Serato DJ Intro screen must be matched to the position of the effect level controls on this unit.



When the position of the effect level controls on the Serato DJ Intro screen matches the position of the effect level controls on this unit, the effect time can be adjusted.

- Effect time: [1/2]



## 3 Operate an effect level control to adjust the effect level.

Adjust the effect level from 100 % (control turned fully clockwise) to 50 % (control set to the center position).

The position of the effect level controls on the Serato DJ Intro screen must be matched to the position of the effect level controls on this unit.

## Using the filter fade function

When the filter fade function is set to on, the filter effect is applied to both decks when the crossfader is operated.

The filter (HPF) effect changes as the tracks on the two decks are mixed, so the tracks blend together smoothly and you can mix them easily without worrying about their genres and tempos.

The explanation below describes the operation of moving the crossfader from the left edge to the right edge to mix the deck 1 track with the deck 2 track as an example.

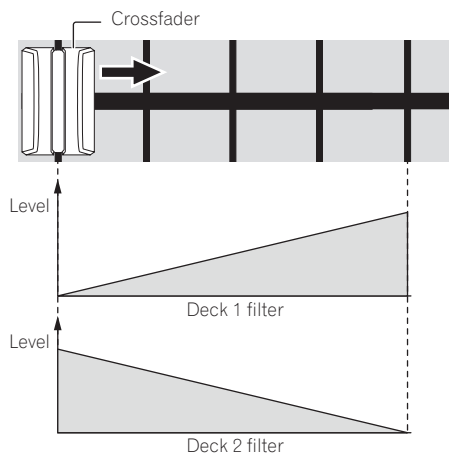

- When the crossfader is moved from the left edge towards the right, the filter (HPF) effect on the deck 1 track changes from the minimum, increasing as the fader approaches the right edge, until the filter (HPF) effect is maximum when the right edge is reached.
- When the crossfader is moved from the left edge towards the right, the filter (HPF) effect on the deck 2 track changes from the maximum, decreasing as the fader approaches the right edge, until the filter (HPF) effect is minimum when the right edge is reached.

## 1 Play tracks on decks 1 and 2.

## 2 Press the [FILTER FADE] button.

The button flashes and the filter fade function is set to on.

When the filter fade function is set to on, operation of the filter control is disabled.

## 3 Move the crossfader from the left edge to the right edge, or from the right edge to the left edge.

To mix from the deck 1 track to the deck 2 track, move the crossfader from the left edge to the right edge.

To mix from the deck 2 track to the deck 1 track, move the crossfader from the right edge to the left edge.

## 4 Press the [FILTER FADE] button again.

The button lights and the filter fade function is set to off.

When the filter control is operated while the filter fade function is set to on, the filter control position at the time the filter fade function was set to off is set.



---

---

## Mixing the sound of the microphone

When a wireless microphone or other device with a high output level is connected, the sound of the microphone may be distorted. If the output level can be switched or the gain can be adjusted, adjust the signal level input to this unit's microphone jack to the lowest level possible. For details, see the operating instructions of the connected device you are using.

### 1 Connect the microphone to the [MIC] terminal.

### 2 Start up the system.

➔ *Starting the system* (p.11)

### 3 Turn the [MIC LEVEL] control.

This adjusts the output audio level.

Pay attention that rotating to the extreme right position outputs a very loud sound.

---

---

## Analyzing tracks

When one of this unit's [LOAD] buttons is pressed and tracks are loaded onto the decks, the tracks are analyzed, but some time may be required until analysis is completed and the BPM and waveform are displayed.

When the Serato DJ Intro software is used as an offline player, tracks can be analyzed ahead of time. For tracks whose analysis has been completed, the BPM and waveform are displayed immediately when the tracks are loaded onto the decks.

For details on using the Serato DJ Intro software as an offline player and instructions on analyzing tracks, see the Serato DJ Intro software manual.

- Depending on the number of tracks, some time may be required for analysis.

# Utilities modes

The following settings can be changed:

- Channel fader start setting
- Demo mode setting
- Jog dial MIDI message sending interval setting

## Launching utilities mode

If the utilities mode is launched while the DJ application is running, the set status may not be displayed properly.

- 1 Quit the DJ application on the computer.**
- 2 Disconnect the USB cable from the main unit.**

Turn off the power of this unit.

  - Do not disconnect the USB cable from the computer.
- 3 While pressing both performance pad 1 and performance pad 4 on the left deck, connect the USB cable to the main unit.**

Utilities mode is launched.
- 4 After setting utilities mode, operate the controller for the items whose settings you want to change.**

See the explanations below for the settings that can be changed.
- 5 Disconnect the USB cable connecting this unit to the computer and save the settings.**

To save the settings, this unit's power must be turned off.

## Changing the settings

### Changing the channel fader start setting

The channel fader start function's setting can be changed.

- By default, the channel fader start mode functions without the sync mode set.

Launch utilities mode, then press one of the left deck's effect buttons.

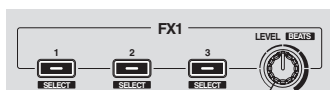

- Effect 1 button lit: Channel fader start with the sync mode set (The sync function is activated simultaneously when channel fader starting starts.)
- Effect 2 button lit: Channel fader start without the sync mode set (The sync function is not activated when channel fader starting starts.)
- Effect 3 button lit: Channel fader start function disabled

### Disabling the demo mode

On this unit, the demo mode is set if no operation is performed for 10 minutes under normal usage conditions. This demo mode can be turned off.

- By default, the demo mode is on.
- When any control or button on this unit is operated while in the demo mode, the demo mode is canceled.

Launch the utilities mode and press the [VINYL (SLIP)] button on the left side.

- [VINYL (SLIP)] button lit: Demo mode enabled
- [VINYL (SLIP)] button off: Demo mode disabled

### Adjusting the jog dial's MIDI message sending interval

This unit is equipped with a mode for adjusting the jog dial's MIDI message sending interval.

Depending on your computer's operating system and specifications, the jog dial may not operate properly if the sending interval of MIDI message for JOG dial is too short. In this case, follow the procedure below to adjust the MIDI message sending interval.

- From a short MIDI sending interval, increase the interval to a length at which no problems occur.
- The default is 3 ms.

Launch utilities mode, then press the left deck's [SAMPLER] mode button.

The MIDI sending interval setting changes each time the button is pressed. The currently set value is indicated by how the performance pads, the [▶/II] button, the [CUE (◀)] button, the [SYNC (OFF)] button and the [SHIFT] button light.

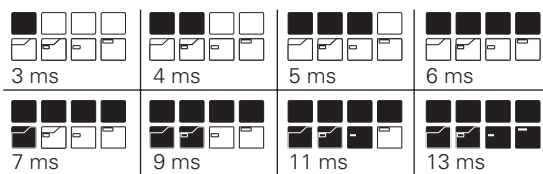

# Additional information

## Troubleshooting

- Incorrect operation is often mistaken for trouble or malfunction. If you think that there is something wrong with this component, check the points below and the [FAQ] for the [DDJ-SB] on the Pioneer DJ support site. Sometimes the problem may lie in another component. Inspect the other components and electrical appliances being used. If the problem cannot be rectified, ask your nearest Pioneer authorized service center or your dealer to carry out repair work.
- This unit may not operate properly due to static electricity or other external influences. In this case, proper operation may be restored by turning the power off, waiting 1 minute, then turning the power back on.

Problem	Check	Remedy
The power is not turned on.	Is the included USB cable properly connected?	Connect the included USB cable properly.
	Is the supply of power from the connected computer's USB port insufficient?	Connect to a USB port providing sufficient power.
		If devices not being used for the DJ performance are connected to other USB ports, also disconnect them to provide sufficient power.
This unit is not recognized.	Is the included USB cable properly connected?	Connect the included USB cable properly.
	Are you using a USB hub?	USB hubs cannot be used. Connect the computer and this unit directly using the included USB cable.
	Is the driver software properly set? (Windows)	Set the driver software properly. (With Mac OS X, no driver software is necessary.) (page 3)
	Are you using the latest version of the Serato DJ Intro software?	Update the software to the latest version.
Tracks are not displayed in the library.	Have music files been imported?	Import the music files properly. For details on importing music files, see the Serato DJ Intro software manual.
	Is a crate or subcrate that does not contain any tracks selected?	Either select a crate or subcrate that contains any tracks or add tracks to the crate or subcrate.
iTunes tracks are not displayed in the library.	Is [Show iTunes Library] on the [SETUP] menu checked?	Check [Show iTunes Library]. For details on importing music files, see the Serato DJ Intro software manual.
	Is a crate or subcrate that does not contain any tracks selected?	Either select a crate or subcrate that contains any tracks or add tracks to the crate or subcrate.
No sound or small sound.	Are the channel faders, crossfader and [MASTER LEVEL] control set to the proper positions?	Set the channel faders, crossfader and [MASTER LEVEL] control to the proper positions.
	Is the connected, power amplifier, powered speakers, etc., properly set?	Properly set the external input selection, volume, etc., on the power amplifier, powered speakers, etc.
	Are the connection cables properly connected?	Connect the connection cables properly.
	Are the terminals and plugs dirty?	Clean the terminals and plugs before making connections.
	Is the driver software properly set? (Windows)	Set the driver software properly. (With Mac OS X, no driver software is necessary.) (page 3)
Distorted sound.	Is the [MASTER LEVEL] control set to the proper position?	Adjust the [MASTER LEVEL] control according to the devices to be connected.
	Is the sound level input to the [MIC] terminal set to an appropriate level?	Set the audio level input to the terminals to a suitable level for the connected devices.
	Is a device with a high output level (such as a wireless microphone) connected?	When a wireless microphone or other device with a high output level is connected, the sound of the microphone may be distorted. If the output level can be switched or the gain can be adjusted, adjust the signal level input to this unit's microphone jack to the lowest level possible. For details, see the operating instructions of the connected device you are using.
Sound being played is interrupted when using DJ software.	Is the driver software's latency value suitable?	Set the driver software's latency to a suitable value. Set the DJ software's latency to a suitable value.
Sound is interrupted when the ASIO driver is set.	Has the ASIO driver been set with Serato DJ Intro running?	Set the ASIO driver before launching Serato DJ Intro. (page 5)
The indicator flashes and operation is strange.	—	It is sometimes possible to restore normal operation by disconnecting the included USB cable, waiting at least 1 minute, then reconnecting the USB cable. If the same problem persists, disconnect the USB cable then request repairs.
Tone does not change when the [FILTER] control is operated.	Is the filter fade function on? When the filter fade function is on, the tone does not change when the [FILTER] control is operated.	Turn the filter fade function off.

Problem	Check	Remedy
Serato DJ Intro operation is unstable.	Are you using the latest version of the software?	Free updates of Serato DJ Intro can be downloaded from the website. Use the most recent version. (page 4)
	Are you using softwares other than Serato DJ Intro at the same time?	Quit other applications to decrease the load on the computer. If operation continues to be unstable, try disabling the wireless network or other wireless connections, antivirus software, the screen saver, the low power mode, etc.
	Is another USB device connected to the computer?	Disconnect other USB devices from the computer. When another USB audio device is connected to the computer at the same time, it may not operate or be recognized normally.
	Are you using a USB hub?	USB hubs cannot be used. Connect the computer and this unit directly using the included USB cable.
	There is a problem with the USB port to which this unit is connected.	If your computer has multiple USB ports, try connecting this unit to a different USB port.
	Is this unit connected to a notebook computer running on its battery?	Supply power to the notebook computer from an AC power supply. (Depending on the notebook computer's settings, the low power mode may be set when the computer is running on its battery, automatically reducing the performance of the computer itself.)
	The USB buffer size is too small.	Raise the USB buffer size. (page 5)
The BPM is not displayed. The sync and auto loop functions do not work.	Has the track been analyzed?	Analyze the track.
	Is [Set Auto BPM] checked in the offline player settings?	Re-analyze the track with [Set Auto BPM] checked. For detailed instructions on analyzing tracks, see the Serato DJ Intro software manual.
BPM is not displayed properly.	Is the BPM analysis range set appropriately in the offline player settings?	Change the BPM analysis range, then re-analyze the track. If this does not solve the problem, set the BPM manually.

## Acquiring the manual

The operating instructions may be in a file in PDF format. Adobe® Reader® must be installed to read files in PDF format. If you do not have Adobe Reader, please install it from the download link on the CD-ROM's menu screen.

### Downloading the latest version of these operating instructions

#### 1 Insert the CD-ROM into the computer's optical drive.

The CD-ROM menu is displayed.

If the CD-ROM's menu does not appear when the CD-ROM is inserted, perform the operations below.

- For Windows  
Open the optical drive from [Computer (or My Computer)] in the [Start] menu, then double-click the [CD\_menu.exe] icon.
- For Mac OS X  
In Finder, double-click the [CD\_menu.app] icon directly.

#### 2 When the CD-ROM's menu is displayed, select [DDJ-SB: Download the Operating Instructions (PDF file)], then click [Start].

#### 3 "An internet environment is required to access the site. Connected to the internet?" is displayed. Click [Yes].

The web browser is launched and the Pioneer DJ support site is displayed.

#### 4 On the Pioneer DJ support site, click "Manuals" under "DDJ-SB".

#### 5 Click on the required language on the download page.

Downloading of the operating instructions begins.

### Downloading the Serato DJ Intro software manual

#### 1 Insert the CD-ROM into the computer's optical drive.

The CD-ROM menu is displayed.

If the CD-ROM's menu does not appear when the CD-ROM is inserted, perform the operations below.

- For Windows  
Open the optical drive from [Computer (or My Computer)] in the [Start] menu, then double-click the [CD\_menu.exe] icon.
- For Mac OS X  
In Finder, double-click the [CD\_menu.app] icon directly.

#### 2 When the CD-ROM's menu is displayed, select [Serato DJ Intro: Download the Software Manual (PDF file)], then click [Start].

#### 3 "An internet environment is required to access the site. Connected to the internet?" is displayed. Click [Yes].

The web browser is launched and the Pioneer DJ support site is displayed.

- To close the CD-ROM menu, click [Exit].

#### 4 Click [Software Info] under [DDJ-SB] on the Pioneer DJ support site.

#### 5 Click the link to the Serato DJ Intro download page.

The Serato DJ Intro download page is displayed.

#### 6 Log in to your "Serato.com" user account.

Input the e-mail address and password you have registered to log in to "Serato.com".

#### 7 From "More Downloads" on the right side of the download page, click "Serato DJ Intro x.x User Manual".

Downloading of the Serato DJ Intro software manual starts.

## Using as a controller for other DJ software

This unit also outputs the operating data for the buttons and controls in MIDI format. If you connect a computer with a built-in MIDI-compatible DJ software via a USB cable, you can operate the DJ software on this unit. The sound of music files being played on the computer can also be output from the DDJ-SB.

To use as a controller for operating DJ software other than the Serato DJ Intro software, also make the DJ software's audio and MIDI-related settings.

- For details, see your DJ software's operating instructions.

## About MIDI messages

For details on this unit's MIDI messages, see "List of MIDI Messages".

- "List of MIDI Messages" can be acquired from the following URL:  
<http://pioneerdj.com/support/>

## About the driver software (Windows)

This driver software is an exclusive ASIO driver for outputting audio signals from the computer.

- There is no need to install the driver software when using Mac OS X.
- First read the *Software end user license agreement* on page 21 carefully.

## Operating environment

### Supported operating systems

Windows® 8/Windows® 8 Pro	32-bit version	✓
	64-bit version	✓ <sup>[1]</sup>
Windows® 7 Home Premium/Professional/Ultimate	32-bit version	✓
	64-bit version	✓ <sup>[1]</sup>
Windows Vista® Home Basic/Home Premium/Business/Ultimate	32-bit version	✓
	64-bit version	✓ <sup>[1]</sup>

- [1] When using a 64-bit version of Windows, the driver software can only be used for 32-bit applications.

## Checking the latest information on the driver software

For detailed information on this unit's designated driver software, see the Pioneer DJ support site below.

<http://pioneerdj.com/support/>

## About the installation procedure

- For the operating procedure, see *Installation Procedure (Windows)*.

## ❖ Software end user license agreement

This Software End User License Agreement ("Agreement") is between you (both the individual installing the Program and any single legal entity for which the individual is acting) ("You" or "Your") and PIONEER CORPORATION ("Pioneer").

TAKING ANY STEP TO SET UP OR INSTALL THE PROGRAM MEANS THAT YOU ACCEPT ALL OF THE TERMS OF THIS LICENSE AGREEMENT. PERMISSION TO DOWNLOAD AND/OR USE THE PROGRAM IS EXPRESSLY CONDITIONED ON YOUR FOLLOWING THESE TERMS. WRITTEN OR ELECTRONIC APPROVAL IS NOT REQUIRED TO MAKE THIS AGREEMENT VALID AND ENFORCEABLE. IF YOU DO NOT AGREE TO ALL OF THE TERMS OF THIS AGREEMENT, YOU ARE NOT AUTHORIZED TO USE THE PROGRAM AND MUST STOP INSTALLING IT OR UNINSTALL IT, AS APPLICABLE.

## 1 DEFINITIONS

- 1 "Documentation" means written documentation, specifications and help content made generally available by Pioneer to aid in installing and using the Program.
- 2 "Program" means all or any part of Pioneer's software licensed to You by Pioneer under this Agreement.

## 2 PROGRAM LICENSE

- 1 Limited License. Subject to this Agreement's restrictions, Pioneer grants to You a limited, non-exclusive, non-transferable, license (without the right to sublicense):
  - a To install a single copy of the Program in Your computer or mobile device, to use the Program only for Your personal purpose complying with this Agreement and the Documentation ("Authorized Use");
  - b To use the Documentation in support of Your Authorized Use; and
  - c To make one copy of the Program solely for backup purposes, provided that all titles and trademark, copyright and restricted rights notices are reproduced on the copy.
- 2 Restrictions. You will not copy or use the Program or Documentation except as expressly permitted by this Agreement. You will not transfer, sublicense, rent, lease or lend the Program, or use it for third-party training, commercial time-sharing or service bureau use. You will not Yourself or through any third party modify, reverse engineer, disassemble or decompile the Program, except to the extent expressly permitted by applicable law, and then only after You have notified Pioneer in writing of Your intended activities.
- 3 Ownership. Pioneer or its licensor retains all right, title and interest in and to all patent, copyright, trademark, trade secret and other intellectual property rights in the Program and Documentation, and any derivative works thereof. You do not acquire any other rights, express or implied, beyond the limited license set forth in this Agreement.
- 4 No Support. Pioneer has no obligation to provide support, maintenance, upgrades, modifications or new releases for the Program or Documentation under this Agreement.

## 3 WARRANTY DISCLAIMER

THE PROGRAM AND DOCUMENTATION ARE PROVIDED "AS IS" WITHOUT ANY REPRESENTATIONS OR WARRANTIES, AND YOU AGREE TO USE THEM AT YOUR SOLE RISK. TO THE FULLEST EXTENT PERMISSIBLE BY LAW, PIONEER EXPRESSLY DISCLAIMS ALL WARRANTIES OF ANY KIND WITH RESPECT TO THE PROGRAM AND DOCUMENTATION, WHETHER EXPRESS, IMPLIED, STATUTORY, OR ARISING OUT OF COURSE OF PERFORMANCE, COURSE OF DEALING OR USAGE OF TRADE, INCLUDING ANY WARRANTIES OF MERCHANTABILITY, FITNESS FOR A PARTICULAR PURPOSE, SATISFACTORY QUALITY, ACCURACY, TITLE OR NON-INFRINGEMENT.

## 4 EXPORT CONTROL AND COMPLIANCE WITH LAWS AND REGULATIONS

You may not use or otherwise export or re-export the Program except as authorized by United States law and the laws of the jurisdiction in which the Program was obtained. In particular, but without limitation, the Program may not be exported or re-exported (a) into any U.S.-embargoed countries or (b) to anyone on the U.S. Treasury Department's Specially Designated Nationals List or the U.S. Department of Commerce Denied Persons List or Entity List. By using the Program, you represent and warrant that you are not located in any such country or on any such list. You also agree that you will not use the Program for any purposes prohibited by United States law, including, without limitation, the development, design, manufacture, or production of nuclear, missile, or chemical or biological weapons.

## 5 U.S. GOVERNMENT RESTRICTED RIGHTS

The Program and Documentations are "commercial computer software" and "commercial computer software documentation" as those terms are defined in 48 C.F.R. §252.227-7014 (a) (1) (2007) and 252.227-7014 (a) (5) (2007). The U.S. Government's rights with respect to the Program and Documentations are limited by this license pursuant to 48 C.F.R. § 12.212 (Computer software) (1995) and 48 C.F.R. §12.211 (Technical data) (1995) and/or 48 C.F.R. §227.7202-3, as applicable. As such, the Program and Documentations are being licensed to the U.S. Government end users: (a) only as "commercial items" as that term is defined in 48 C.F.R. §2.101 generally and as incorporated in DFAR 212.102; and (b) with only those limited rights as are granted to the public pursuant to this license. Under no circumstance will the U.S. Government or its end users be granted any greater rights than we grant to other users, as provided for in this license. Manufacturer is Pioneer Corporation, 1-1 Shin-Ogura, Saiwai-ku, Kawasaki-shi, Kanagawa-Ken, 212-0031 Japan

## 6 DAMAGES AND REMEDIES FOR BREACH

You agree that any breach of this Agreement's restrictions would cause Pioneer irreparable harm for which money damages alone would be inadequate. In addition to damages and any other remedies to which Pioneer may be entitled, You agree that Pioneer may seek injunctive relief to prevent the actual, threatened or continued breach of this Agreement.

## 7 TERMINATION

Pioneer may terminate this Agreement at any time upon Your breach of any provision. If this Agreement is terminated, You will stop using the Program, permanently delete it from your computer or mobile device where it resides, and destroy all copies of the Program and Documentation in Your possession, confirming to Pioneer in writing that You have done so. Sections 2.2, 2.3, 2.4, 3, 4, 5, 6, 7 and 8 will continue in effect after this Agreement's termination.

## 8 GENERAL TERMS

- 1 Limitation of Liability. In no event will Pioneer or its subsidiaries be liable in connection with this Agreement or its subject matter, under any theory of liability, for any indirect, incidental, special, consequential or punitive damages, or damages for lost profits, revenue, business, savings, data, use, or cost of substitute procurement, even if advised of the possibility of such damages or if such damages are foreseeable. In no event will Pioneer's liability for all damages exceed the amounts actually paid by You to Pioneer or its subsidiaries for the Program. The parties acknowledge that the liability limits and risk allocation in this Agreement are reflected in the Program price and are essential elements of the bargain between the parties, without which Pioneer would not have provided the Program or entered into this Agreement.
- 2 The limitations or exclusions of warranties and liability contained in this Agreement do not affect or prejudice Your statutory rights as consumer and shall apply to You only to the extent such limitations or exclusions are permitted under the laws of the jurisdiction where You are located.
- 3 Severability and Waiver. If any provision of this Agreement is held to be illegal, invalid or otherwise unenforceable, that provision will be enforced to the extent possible or, if incapable of enforcement, deemed to be severed and deleted from this Agreement, and the remainder will continue in full force and effect. The waiver by either party of any default or breach of this Agreement will not waive any other or subsequent default or breach.
- 4 No Assignment. You may not assign, sell, transfer, delegate or otherwise dispose of this Agreement or any rights or obligations under it, whether voluntarily or involuntarily, by operation of law or otherwise, without Pioneer's prior written consent. Any purported assignment, transfer or delegation by You will be null and void. Subject to the foregoing, this Agreement will be binding upon and will inure to the benefit of the parties and their respective successors and assigns.
- 5 Entire Agreement. This Agreement constitutes the entire agreement between the parties and supersedes all prior or contemporaneous agreements or representations, whether written or oral, concerning its subject matter. This Agreement may not be modified or amended without Pioneer's prior and express written consent, and no other act, document, usage or custom will be deemed to amend or modify this Agreement.
- 6 You agree that this Agreement shall be governed and construed by and under the laws of Japan.

## About trademarks and registered trademarks

- Pioneer is a registered trademark of PIONEER CORPORATION.
- Microsoft, Windows and Windows Vista are either registered trademarks or trademarks of Microsoft Corporation in the United States and/or other countries.
- Mac OS, iTunes, and Finder are trademarks of Apple Inc., registered in the U.S. and other countries.
- Intel and Intel Core are trademarks of Intel Corporation in the U.S. and/or other countries.
- ASIO is a trademark of Steinberg Media Technologies GmbH.
- Serato DJ Intro, Scratch Live, ITCH and Serato DJ are registered trademarks of Serato.

The names of companies and products mentioned herein are the trademarks of their respective owners.

This product has been licensed for nonprofit use. This product has not been licensed for commercial purposes (for profit-making use), such as broadcasting (terrestrial, satellite, cable or other types of broadcasting), streaming on the Internet, Intranet (a corporate network) or other types of networks or distributing of electronic information (online digital music distribution service). You need to acquire the corresponding licenses for such uses. For details, see <http://www.mp3licensing.com>.

## Cautions on copyrights

Recordings you have made are for your personal enjoyment and according to copyright laws may not be used without the consent of the copyright holder.

- Music recorded from CDs, etc., is protected by the copyright laws of individual countries and by international treaties. It is the full responsibility of the person who has recorded the music to ensure that it is used legally.
- When handling music downloaded from the Internet, etc., it is the full responsibility of the person who has downloaded the music to ensure that it is used in accordance with the contract concluded with the download site.

— For improvement purposes, specifications and design of this unit and the included software are subject to change without notice.

© 2013 PIONEER CORPORATION. All rights reserved.

PIONEER CORPORATION

1-1, Shin-ogura, Saiwai-ku, Kawasaki-shi, Kanagawa 212-0031, Japan  
<DR11200-A>