

ZX4

ZX4 15-inch Two-Way Passive 90° x 50°, 400W Loudspeaker System



Key Features:

- EVS15-SF 15" LF Transducer
- DH3 1.25" Voice Coil, 1" Exit Compression Driver
- 90° x 50° Coverage Pattern
- 400W Continuous (1600W) Power Handling
- Adjustable Monitor Angle (45° or 55°)
- High Sensitivity, 132 dB Maximum SPL
- Lightweight 20.2 kg (44.5 lbs)
- Integral Pole Mount



General Description:

The rugged enclosure of the Electro-Voice Zx4 is perfect for portable main mix and monitor applications, while the stylish design gives it appeal in even the trendiest of environments. At only 20.2 kg (44.5 lbs), the lightweight Zx4 allows ease of transport and set up.

Every detail of your music is reproduced from extended highs to powerful lows. The DH3 compression driver with its pure titanium diaphragm, coupled with the Zx4's large 90° x 50° horn allows for tremendous intelligibility and pattern control. The EVS15-SF 15" LF delivers tight, low bass and outstanding power handling capacity.

Zx4 is capable as an entire system. With an integral pole mount the Zx4 is ready for main mix applications in DJ, band and general entertainment use. To accommodate different stage depths, Zx4 incorporates retractable monitor feet. This allows Zx4 to be used as a stage monitor with a 45° or 55° angle.

The high tech enclosure uses injection-molded high impact polypropylene structural foam to make the Zx4 incredibly durable. The enclosure geometry elements have been carefully designed to provide maximum rigidity and bass response.

Technical Specifications:

Freq. Response ¹ (-3 dB):	60 Hz - 20 kHz
Freq. Range ¹ (-10 dB):	42 Hz - 20 kHz
Rec. Hipass Frequency:	42 Hz
Axial Sensitivity ¹ :	100 dB (1W/1m)
Max. Calculated SPL:	132 dB
Horizontal Coverage:	90°
Vertical Coverage:	50°
Power Handling:	400W Continuous, 1600W Peak
LF Transducer:	EVS15-SF, 15 in (381mm) Driver
HF Transducer:	DH3, 1 in (25.4mm) exit Compression Driver
Crossover Frequency:	1.5 kHz
Nominal Impedance:	8 Ohms
Minimum Impedance:	6.5 Ohms
Connectors:	(2) Neutrik Speakon NL4's
Enclosure Material:	Polypropylene Structural Foam
Suspension:	Enclosure has locations for 3 Single-Stud Attachment Plates and 8 Forged Steel Eyebolts - 2 on Top, 2 on Side, and 4 on Rear of Enclosure
Grille:	Polyester Powder Coated, 16GA Galvanized Steel, with Rotatable Logo
Dimensions (H x W x D):	692mm x 446mm x 411mm (27.26" x 17.57" x 16.16")
Net Weight:	20.2 kg (44.5 lbs)
Shipping Weight:	24.0 kg (52.9 lbs)

¹ Half Space Measurement.



Dimension Drawings:

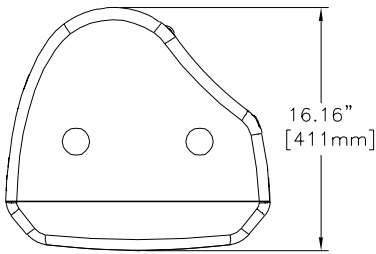

Top View

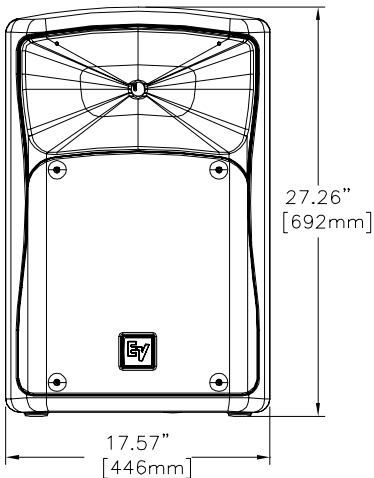

Front View

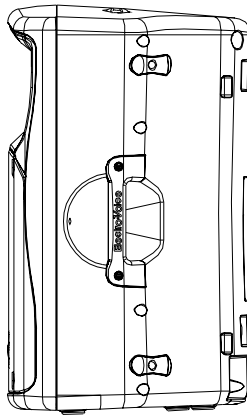

Right View

Block Diagram:

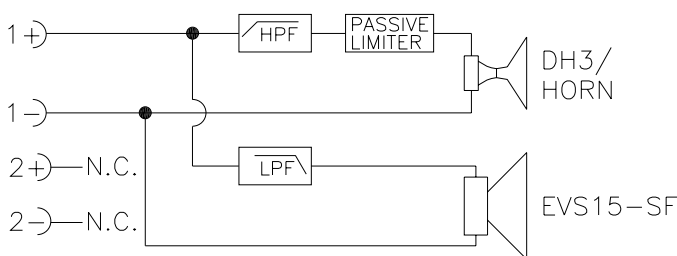

Frequency Response & Impedance:

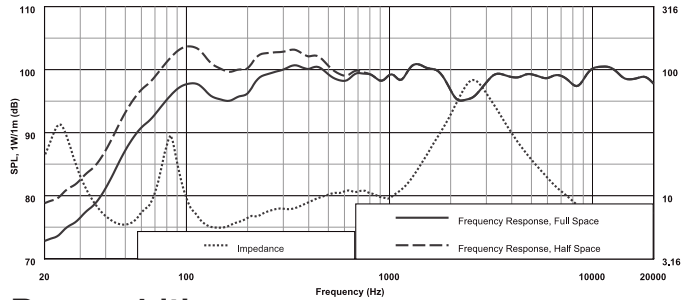

Beamwidth:

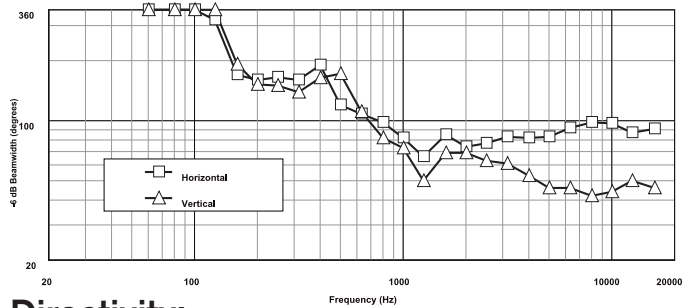

Directivity:

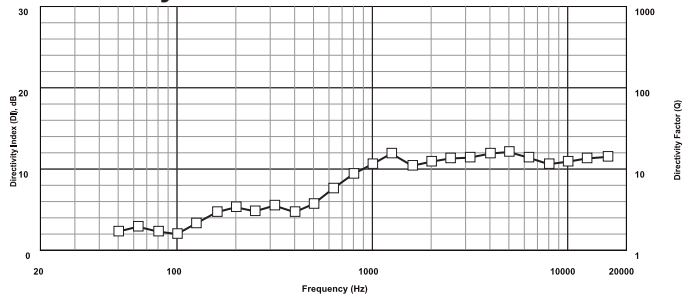

Zx4 Part Numbers

- 301774-001 Zx4, 90° x 50° Horn, Black Finish

Performance Match

- 301576-001 SbA760, 120V Single 15" Powered Sub, 760W
- D170258 CP2200, 120V Power Amplifier, 2 x 800W

Accessories

- 301626-001 MB5-B, Wall/Ceiling Mount Bracket (Black)
- 301626-002 MB5-W, Wall/Ceiling Mount Bracket (White)
- 301634-000 EBK-3, Forged M8 Eyebolt Kit, Set of Three
- 301633-000 SSK-1, Single-Stud Rigging Kit, Set of Three
- 301812-000 RK-Z, Anchor Plate Kit, Set of Three
- 593717 100BK, Tripod Speaker Stand
- 301813-001 HDC-5, Heavy-Duty Stackable Cover (Black)
- ACC000012-001 TCA-1, Truss Clamp Adapter
- ACC000007-001 VSA-1, Vertical Strong-Arm Mount
- 301811-001 HA-5, Handle Mount Adapter

⚠ CAUTION ⚠

This Zx5 Loudspeaker should be suspended overhead only in accordance with the procedures and limitations specified in the *Zx5 Users Manual* and possible manual update notices. This system should be suspended with certified rigging hardware by an authorized rigging professional and in compliance with local, state, and federal overhead suspension ordinances.

Electro-Voice

12000 Portland Avenue South, Burnsville, MN 55337
Phone: 952/884-4051, Fax: 952/884-0043

www.electrovoice.com

© Bosch Communications Systems

12/2010

Part Number 38110416 Rev D

U.S.A. and Canada only. For customer orders, contact Customer Service at:
800/392-3497 Fax: 800/955-6831

Europe, Africa, and Middle East only. For customer orders, contact Customer Service at:
+ 49 9421-706 0 Fax: + 49 9421-706 265

Other International locations. For customer orders, Contact Customer Service at:
+ 1 952 884-4051 Fax: + 1 952 887-9212

For warranty repair or service information, contact the Service Repair department at:
800/685-2606

For technical assistance, contact Technical Support at: 866/78AUDIO

Specifications subject to change without notice.