

# JFL118 Specifications



## FEATURES:

- The JFL118 is the companion subwoofer to the JFL210 and JFL213. The JFL118's simple-to-use rigging solution allows users to construct flown and ground stacked arrays with ease.
- The JFL118 is built to EAW construction standards with its rugged enclosure, sturdy finish and reinforced steel grille to stand up to life on the road.
- The JFL subwoofer offers an excellent choice for a wide range of portable and installed AV applications.

## DESCRIPTION:

The JFL118 is a light weight, high-powered, flyable, single 18-inch subwoofer that extends the low frequency response of the companion JFL210 or JFL213 full range line array loudspeakers. JFL118 subwoofers may be ground stacked, flown as part of a JFL210 or JFL213 array or flown separately alongside a JFL210 or JFL213 array. Integral, proprietary rigging will suspend up to six of any combination of JFL118 and JFL210/JFL213 enclosures with a 10:1 design factor. The optional FB121 fly bar includes multiple suspension points that allow users to easily set an array's tilt angle. The JFL118 also includes M10 threaded suspension points that allow users to deploy arrays in permanently installed applications by means of cost-effective, forged shoulder eyebolts.

The JFL118 includes a metal cup that allows up to two JFL210 or JFL213 main channel loudspeakers to be pole mounted above up to two stacked JFL118's. Alternately, JFL210 or JFL213 loudspeakers may be stacked directly atop the JFL118. In this instance, all enclosures lock together using their integral rigging.

JFL118 subwoofers utilize Neutrik® Speakon® STX Series connectors. The STX Series' all-metal housings are extremely rugged, and feature a built-in gasket providing weather protection to IP54 when used with companion NLT4FX in-line cable connectors. The rear of each JFL118 features three NL4 connectors. Two are used for subwoofer and optional high passed signal input, while the third is used as an output to loop the high-passed signal to JFL210's, JFL213's or other loudspeakers.

Six year warranty.

## 18 INCH SUBWOOFER

See *NOTES TABULAR DATA* for details

### CONFIGURATION

#### Subsystem:

	<i>Transducer</i>	<i>Loading</i>
	SUB 1x 18 in cone	Vented

#### Operating Mode:

	<i>Amplifier Channels</i>	<i>External Signal Processing</i>
	Single-amp LF	DSP w/1-way filter

### PERFORMANCE

**Operating Range:** 30 Hz to 150 Hz

#### Nominal Beamwidth:

Horz	360°
Vert	360°

#### Axial Sensitivity (SPL):

LF (whole space)	94 dB	30 Hz to 150 Hz
(half space)	100 dB	30 Hz to 150 Hz

#### Input Impedance (ohms):

	<i>Nominal</i>	<i>Minimum</i>
LF	8	7.1 @ 145 Hz

**High Pass Filter:** High Pass=>30 Hz, 12 dB/octave Butterworth

#### Accelerated Life Test:

System	80 V	800 W @ 8 ohm
--------	------	---------------

#### Calculated Axial Output Limit (whole space SPL):

	<i>Average</i>	<i>Peak</i>
LF (whole space)	123 dB	129 dB
(half space)	129 dB	135 dB

### ORDERING DATA

<i>Description</i>	<i>Part Number</i>
EAW JFL118 Black	2039875-90

#### *Optional Accessories*

Eye Bolt Forged Shoulder M10 X 1.5 X 37mm LG	0029818
Flybar JFL & HDA BLK [FB221]	2036411
ACC CASTER KIT 100 [ACC-CK100]	0032377-90

## ENCLOSURE

Material Exterior-grade Baltic birch plywood  
 Finish Wear resistant textured black paint  
 Grille Powder-coated perforated steel

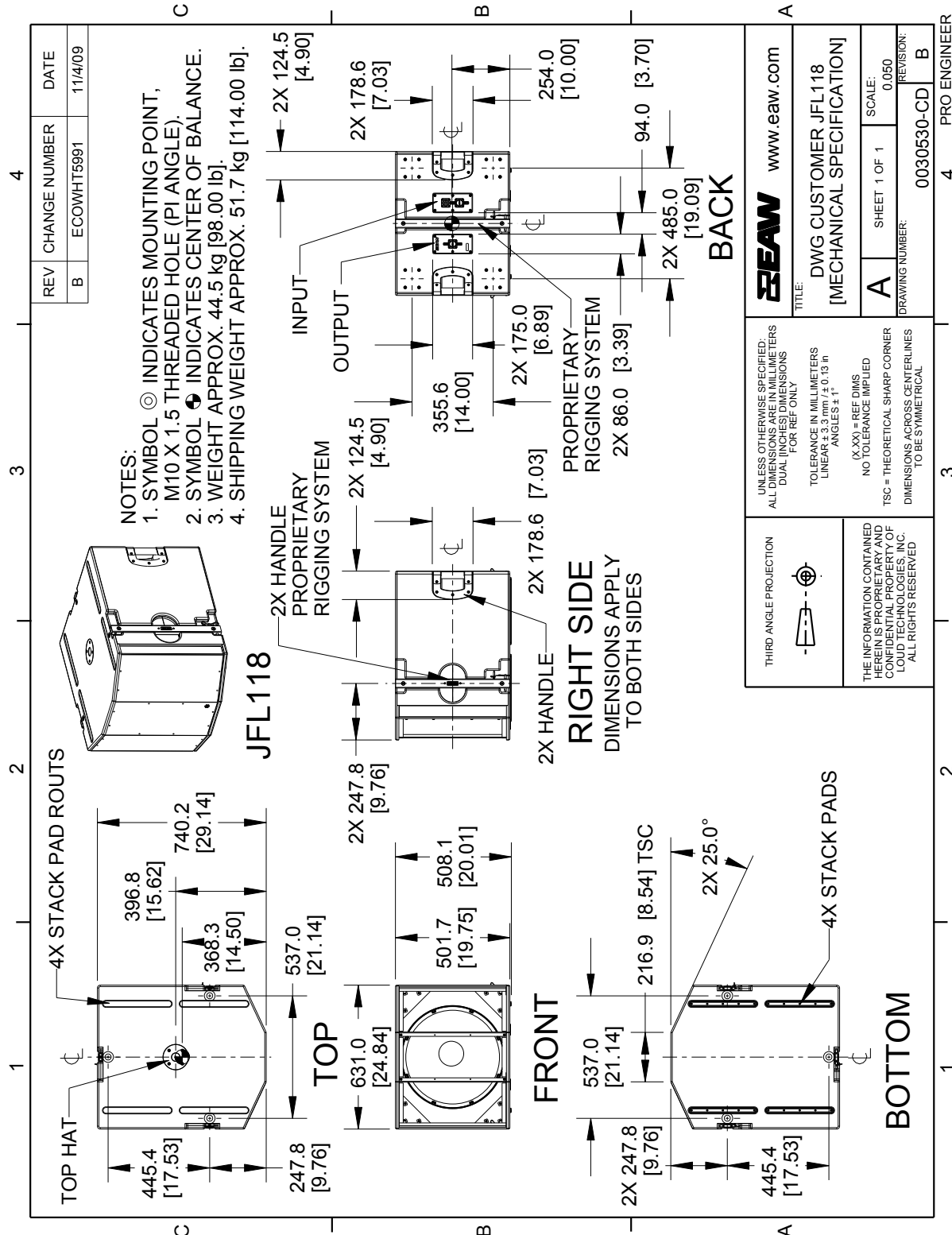

**NOTE:** This drawing has been reduced. Do not scale.

## PERFORMANCE DATA

See *NOTES GRAPHIC DATA* for details

### Frequency Response: Processed

LF = green

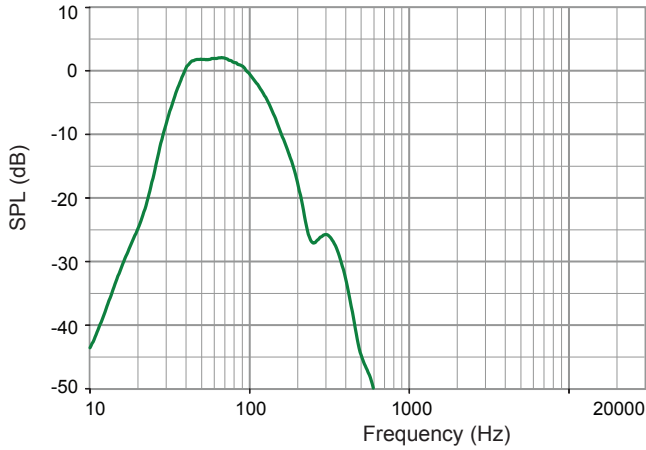

### Frequency Response: Unprocessed

LF = green

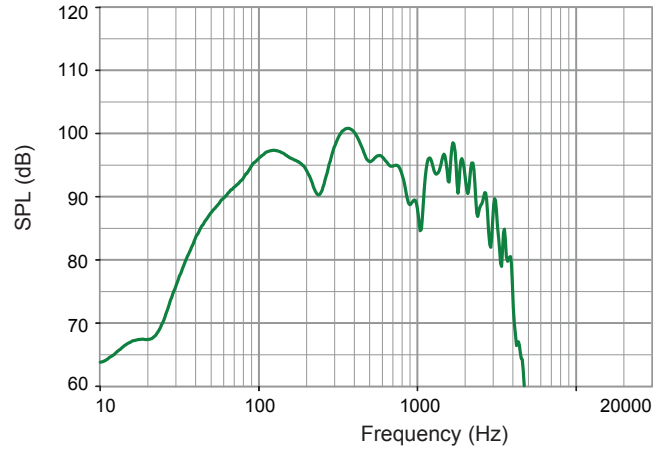

### Impedance

LF = green

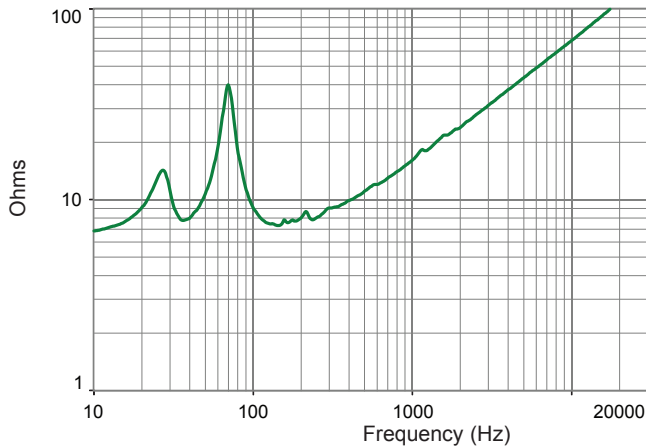

### Processor Response

LF = green

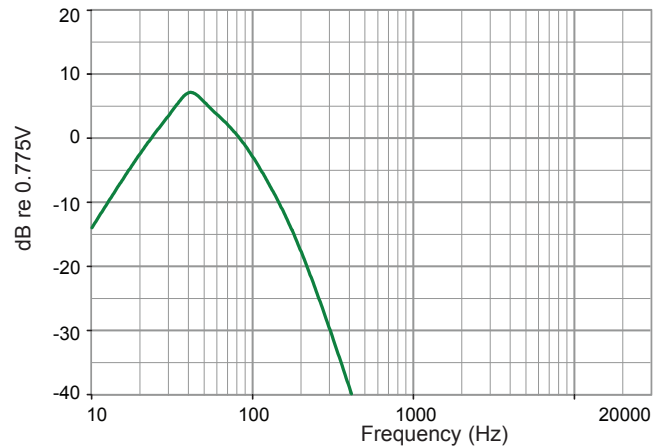

## INPUT PANELS

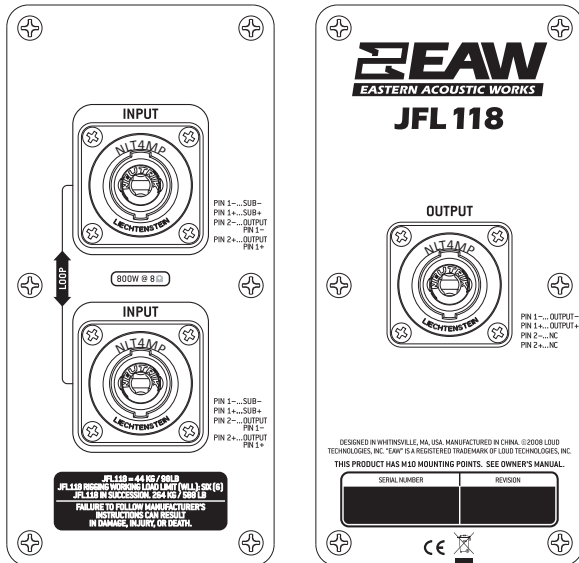

## SIGNAL DIAGRAM

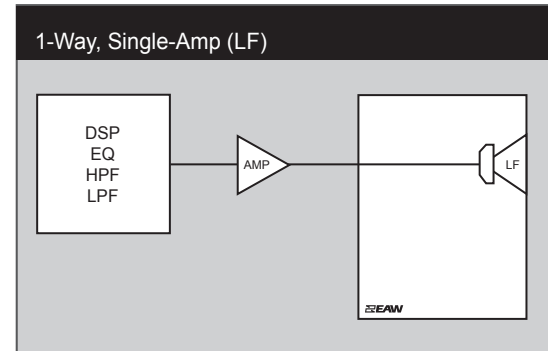

## LEGEND

- HPF:** High Pass Filter for crossover –or– Recommended High Pass Filter.
- LPF:** Low Pass Filter for crossover.
- LF/MF/HF:** Low Frequency / Mid Frequency / High Frequency.
- AMP:** User Supplied Power Amplifier –or– Integral Amplifier for NT products.
- XVR:** Passive LPFs, HPFs, and EQ integral to the loudspeaker.
- EAW Focusing:** Digital Signal Processor capable of implementing EAW Focusing.

## NOTES

### TABULAR DATA

1. **Measurement/Data Processing Systems:** Primary - FChart: proprietary EAW software; Secondary - Brüel & Kjær 2012.
2. **Microphone Systems:** Earthworks M30; Brüel & Kjær 4133
3. **Measurements:** Dual channel FFT; length: 32 768 samples; sample rate: 48 kHz; logarithmic sine wave sweep.
4. **Measurement System Qualification** (includes all uncertainties): SPL: accuracy +/-0.2 dB @ 1 kHz, precision +/-0.5 dB 20 Hz to 20 kHz, resolution 0.05 dB; Frequency: accuracy +/-1 %, precision +/-0.1 Hz, resolution the larger of 1.5 Hz or 1/48 octave; Time: accuracy +/-10.4 μs, precision +/-0.5 μs, resolution 10.4 μs; Angular: accuracy +/-1°, precision +/-0.5°, resolution 0.5°.
5. **Environment:** Measurements time-windowed and processed to eliminate room effects, approximating an anechoic environment. Data processed as anechoic or fractional space, as noted.
6. **Measurement Distance:** 7.46 m. Acoustic responses represent complex summation of the subsystems at 20 m. SPL is referenced to other distances using the Inverse Square Law.
7. **Enclosure Orientation:** For beamwidth and polar specifications, as shown in Mechanical Specification drawing.
8. **Volts:** Measured rms value of the test signal.
9. **Watts:** Per audio industry practice, "loudspeaker watts" are calculated as voltage squared divided by rated nominal impedance. Thus, these are not True Watt units of energy as defined by International Standard.
10. **SPL:** (Sound Pressure Level) Equivalent to the average level of a signal referenced to 0 dB SPL = 20 microPascals.
11. **Subsystem:** This lists the transducer(s) and their acoustic loading for each passband. Sub = Subwoofer, LF = Low Frequency, MF = Mid Frequency, HF = High Frequency.
12. **Operating Mode:** User selectable configurations. Between system elements, a comma (,) = separate amplifier channels; a slash (/) = single amplifier channel. DSP = Digital Signal Processor. **IMPORTANT:** To achieve the specified performance, the listed external signal processing must be used with EAW-provided settings.
13. **Operating Range:** Range where the processed Frequency Response stays within -10 dB SPL of the power averaged SPL within this range; measured on the geometric axis. Narrow band dips are excepted.
14. **Nominal Beamwidth:** Design angle for the -6 dB SPL points, referenced to 0 dB SPL as the highest level.
15. **Axial Sensitivity:** Power averaged SPL over the Operating Range with an input voltage that would produce 1 W at the nominal impedance; measured with no external processing on the geometric axis, referenced to 1 m.
16. **Nominal Impedance:** Selected 4, 8, or 16 ohm resistance such that the minimum impedance point is no more than 20% below this resistance over the Operating Range.
17. **Accelerated Life Test:** Maximum test input voltage applied with an EIA-426B defined spectrum; measured with recommended signal processing and Recommended Protection Filter.
18. **Calculated Axial Output Limit:** Highest average and peak SPLs possible during the Accelerated Life Test. The Peak SPL represents the 2:1 (6 dB) crest factor of the Life Test signal.
19. **High Pass Filter:** This helps protect the loudspeaker from excessive input signal levels at frequencies below the Operating Range.

### GRAPHIC DATA

1. **Resolution:** To remove insignificant fine details, 1/12 octave cepstral smoothing was applied to acoustic frequency responses and 1/3 octave cepstral smoothing was applied to the beamwidth and impedance data. Other graphs are plotted using raw data.
2. **Frequency Responses:** Variation in acoustic output level with frequency for a constant input signal. Processed: normalized to 0 dB SPL. Unprocessed inputs: 2 V (4 ohm nominal impedance), 2.83 V (8 ohm nominal impedance), or 4 V (16 ohm nominal impedance) referenced to a distance of 1 m.
3. **Processor Response:** The variation in output level with frequency for a constant input signal of 0.775 V = 0 dB reference.
4. **Beamwidth:** Average angle for each 1/3 octave frequency band where, starting from the rear of the loudspeaker, the output first reaches -6 dB SPL referenced to 0 dB SPL as the highest level. This method means the output may drop below -6 dB SPL within the beamwidth angle.
5. **Impedance:** Variation in impedance magnitude, in ohms, with frequency without regard to voltage/current phase. This means the impedance values may not be used to calculate True Watts (see 9 above).
6. **Polar Data:** Horizontal and vertical polar responses for each 1/3 octave frequency band 100 Hz to 16 kHz or Operating Range.