

PX Series

PX700W, PX750U and PX800X digital projectors

Powerful installation projector equipped to take on the most demanding integration projects.

FLEXIBILITY ENABLES PERFORMANCE

- High-performance video processing/scaling, utilizing the Hollywood Quality Video processor, is designed for computer signals as well as standard or high-definition video. The technology produces superior video processing using pixel-based, motion-adaptive de-interlacing to remove undesirable motion artifacts typical of interlaced signals. This processing creates life-like images in applications such as video conferencing.
- Bright enough for most applications: 7000 lumens (PX700W), 7500 lumens (PX750U), 8000 lumens (PX800X) with a 6-segment (RGBYCW) color wheel. For higher video quality color reproduction, BrilliantColor™ technology and a second 6-segment (RGBYCM) color wheel (included) can dramatically increase color saturation at mid and low video levels, while optimizing color gain across the full color gamut.
- VIDi technology, a Phillips innovation designed to work in conjunction with the color wheel, uses a brilliant pulse to increase the brightness of the image and a dark pulse to increase the contrast ratio
- Lens memory controls lens attributes (zoom, focus, shift) based on input resolution and input selection (NP17ZL, NP18ZL, NP19ZL, NP20ZL and NP21ZL)



INTEGRATED NETWORKING AND ASSET MANAGEMENT

- Integrated RJ45 connection for quick connection to the LAN (10/100 base-T capability)
- Optional high-speed wireless LAN IEEE 802.11b/g/n
- Desktop control allows you to securely transmit information wirelessly to the projector from a docking station or PC in another room
- Image Express Utility (IEU 2.0; compatible with Windows or Mac operating systems) dedicated projector software provides wired and wireless data transmission via peer-to-peer or over the network
 - Broadcast mode allows you to send information from one computer to several projectors
- Windows Network Projector function within Windows Vista connects directly to networked projectors without the need for additional proprietary software
- Windows Remote Desktop function allows you to control a networked computer by connecting a USB mouse and keyboard directly to the projector's USB input
- Windows Network Drive Function displays multimedia files (.jpeg, .bmp, .png, .mpeg2 or .wmv9) in the Windows shared folder on a local network using the Viewer function—all without bringing your PC into the conference room
- Windows Media Connection Function displays multimedia files (.mpeg2, .jpeg or .wmv9) stored on the Windows Media Connect server or a local network using the Viewer function—all without bringing your PC into the conference room
- Crestron Roomview Connected™

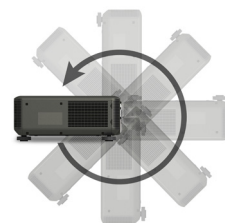

Tilt-Free Installation

PX Series models can be rotated freely (360°) in order to point up or down depending on the installation requirements.

Lens Shift

Enjoy greater installation flexibility with 50% vertical lens shift and +/- 10% horizontal lens shift. Ships lensless with a complete line of optional bayonet style lenses (6) for quick and easy exchange. Lens throw distances range from 2.6 to 179.8 feet.

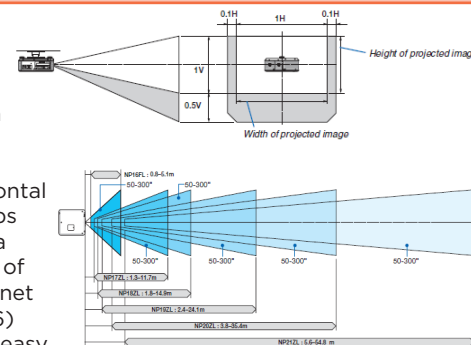

SECURITY FEATURES PROVIDE PEACE OF MIND

- Cabinet control lock setting enables user to deactivate buttons on cabinet to prevent unwanted changes to projector settings
- Logo lock restricts changes to logo saved in projector memory
- Password protection restricts unauthorized use of projector
- Email notification informs the system administrator when the lamp approaches the end of its useful life

DESIGNED WITH THE ENVIRONMENT IN MIND

- **Extended lamp life with ECO Mode™ technology** increases lamp life up to 2500 hours, while lowering power consumption
- **Power management** enables projector to automatically turn off when an incoming signal is not detected from any of the inputs
- **Auto Power On** via the RGB (15-pin) input connector when a signal is detected from a computer
- **Carbon savings meter** calculates the positive effects of operating the projector in ECO Mode, which is encouraged by an optional message at startup. A green ECO Mode button on the remote control makes the switch easy.
- **Quick start** (3 to 4 seconds) lets you begin presenting in seconds while quick shutdown (immediate power off with no cooling required after shutdown) ensures efficient energy usage
- **Sleep timer** can be set to automatically turn off the projector at set countdown times
- **Low power consumption** (0.2W in stand-by mode) minimizes energy costs
- **Direct power off** provides instantaneous shutdown of the projector



2500-hour filter life

NEC is committed to designing its products to provide long lifecycles. This commitment even extends to components within its products, including the improved filter. This virtually maintenance-free filter reduces the frequency at which cleaning is required, thereby decreasing your total cost of ownership. Filter replacement is only required at the time the lamp is replaced.



Dual lamps

The PX Series features dual lamps, providing up to 8000 lumens of light output. You can combine dual lamps for up to four different light configurations (Normal Mode with dual or single lamp and ECO Mode with dual or single lamp) and settings depending on the ambient lighting conditions.

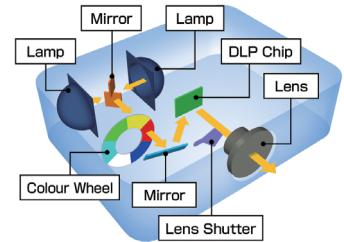

BUILT-IN SOFTWARE

Built-in stacking correction

The industry's first built-in stacking correction capabilities (up to four projectors) allows the projectors to boost an image's brightness up to 32,000 lumens, which is ideal for larger-sized screens and environments with heavy ambient light. This feature also prevents the complete loss of an image, which can happen when using only one projector.

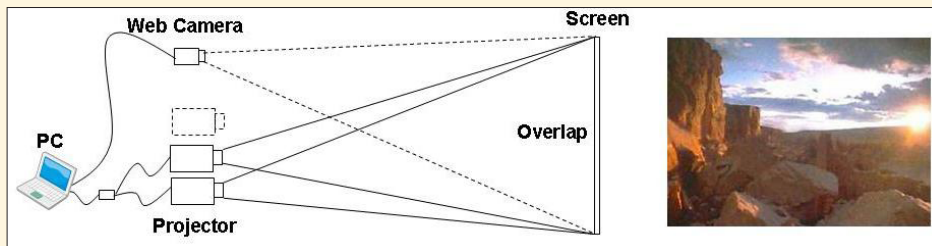

PIP/Side-by-Side

This function allows two sources to be displayed on the screen at one time in either a picture-in-picture or side-by-side configuration.

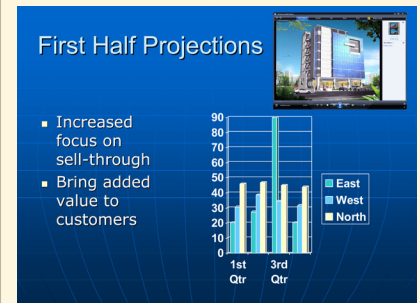

Built-in wall color correction presets

These provide for adaptive color tone correction to display properly on non-white surfaces.

On a green wall...



BEFORE auto wall correction

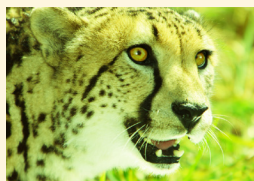

AFTER auto wall correction

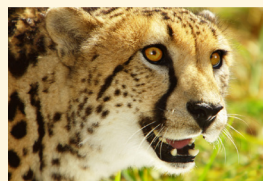

Edge blending

This function seamlessly blends multiple projected images to display a single high-resolution image.

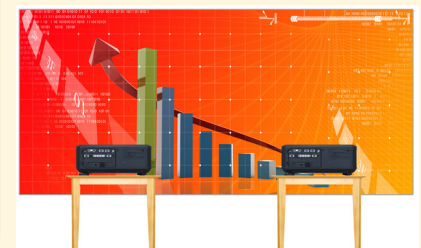

GET CONNECTED WITH A WIDE SELECTION OF INPUTS

- **Dual computer inputs** ensure quick switching between presentations

Remote control

Easy control from remote allows you to adjust lamp mode, aspect ratio, volume and image all with the touch of a button.



DisplayPort

This input provides PX Series models with expanded connectivity with advanced technology.

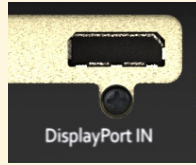

HDMI™ input

Among the PX Series' wide selection of inputs is an HDMI w/ HDCP for connecting to high-definition sources such as Blu-ray players, cable boxes, satellite receivers and personal computers.



USB Viewer

In instances when you'd prefer to leave your laptop behind for a presentation, PX Series projectors can deliver a solution. Using the presentation conversion software included with your projector, simply place your file onto a USB drive and plug it into the projector's USB port. This allows you to display images stored as .jpgs from optional USB memory.

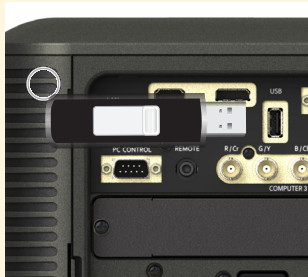

Open Pluggable Specification (OPS)

The first industry-wide standardization in option slots simplifies installation, use and maintenance, while offering superior input flexibility.



ADVANCED SOFTWARE FEATURES

Cornerstone

Enhanced keystone correction allows for horizontal, vertical and diagonal image correction for aligned images even when the projector is set up at an angle to the screen.

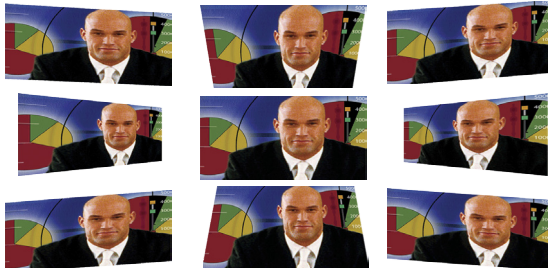

Geometric Correction

Projecting an image isn't confined to a standard flat screen or wall with the NEC PX Series. Geometric correction allows these models to project an image on spheres, cylinders, corner angles and many more non-standard surfaces.

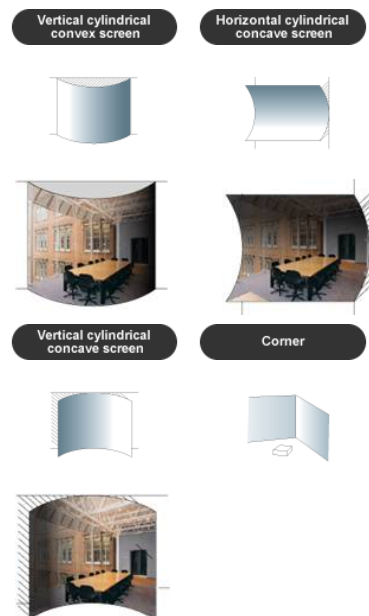

Virtual Remote™

Used via a network connection (wired/wireless), you can control the projector directly from a computer without the need for additional control cables.





UNIQUE FEATURES

3D Reform™ allows you to square the image by adjusting horizontally, vertically or diagonally when the projector cannot be placed parallel or perpendicular to the screen

Advanced AccuBlend™ ensures detailed images when non-native resolution sources are connected to the projector

AutoSense™ automatically syncs with any computer signal and features one-touch image optimization

64-step image magnification with location control

Discreet source keys for source selection

Remote diagnostics enable the user to monitor and make adjustments to the projector remotely

Built-in HTTP page for control and monitoring over a LAN network. Email notification of error messages or lamp end-of-life can be sent to remote locations.

WARRANTY

Registered owners receive a 3-year parts and labor warranty including the first year of InstaCare. The lamp is covered for one year or 500 hours, whichever comes first. InstaCare provides the original owner one year of either limited 3 business day repair/return or next business day exchange.

IN THE BOX

Remote control, remote control cable, batteries, power cord, RGB signal cable, lens cap, user's manual on CD-ROM, quick start guide, product registration card, wired and wireless network setup guide, lens anti-theft screw

ORDERING MODEL NUMBERS

NP-PX700W
NP-PX750U
NP-PX800X



Specifications for PX700W/PX750U/PX800X

OPTICAL

Display Technology
Light Output (lumens)

Resolution
Native
Maximum
Contrast Ratio (up to)
Lamp Type
Lamp Life (up to)
Screen Size (diagonal)
Throw Ratio

NP06FL
NP07ZL
NP08ZL
NP09ZL
NP10ZL
NP16FL
NP17ZL
NP18ZL
NP19ZL
NP20ZL
NP21ZL

Projection Distance
Projection Angle

Lens*
Zoom
Focus
F-number, f-number

NP06FL
NP07ZL
NP08ZL
NP09ZL
NP10ZL
NP16FL
NP17ZL
NP18ZL
NP19ZL
NP20ZL
NP21ZL
Shift
Keystone Correction

PX700W: 0.65" DMD/PX750U: 0.67" DMD/PX800X: 0.7" DMD
PX700W: 7000 normal / Eco = approx. 80% of normal mode
PX750U: 7500 normal / Eco = approx. 80% of normal mode
PX800X: 8000 normal / Eco = approx. 80% of normal mode

PX700W: WXGA 1280 x 800/PX750U: WUXGA 1920 x 1200/PX800X: XGA 1024 x 768
WUXGA 1920 x 1200
2100:1
(2) 400W AC / 320W eco
2000 hours normal / 2500 hours eco
50 to 300 in. / 1.3 to 7.6m

0.77:1
1.33 - 1.79:1
1.78 - 2.35:1
2.22 - 4.43:1
4.43 - 8.3:1
0.76:1
1.25 - 1.79:1
1.73 - 2.27:1
2.22 - 3.67:1
3.58 - 5.38:1
5.31 - 8.26:1
2.6 to 179.8 ft. / 0.8 to 54.8m
0° tele / 14.6° wide

Power
Power

F=2, f=11.4mm
F=1.8 to 2.3, f=19.3 to 25.8mm
F=1.7 to 1.9, f=26 to 34mm
F=2.1 to 2.9, f=32 to 63mm
F=2.2 to 3.1, f=63.5 to 117.4mm
F=1.85, f=11.6mm
F=1.85 to 2.5, f=18.7 to 26.5mm
F=1.64 to 1.86, f=25.7 to 33.7mm
F=1.86 to 2.48, f=32.9 to 54.2mm
F=1.85 to 2.4, f=52.8 to 79.1mm
F=1.85 to 2.48, f=78.5 to 121.9mm
Power: 50% vertical, +/- 10% horizontal
PX750U: +/- 35° horizontal, +/- 30° vertical
PX700W/PX800X: +/- 40° horizontal, +/- 30° vertical

SIGNAL COMPATIBILITY/CONNECTIVITY

Scan Rate
Horizontal
Vertical
Supported Video Standards
SD/HD Video Signal Compatibility
PC Signal Compatibility
Macintosh Compatibility
Input/Output Terminals

RGB1 (analog)
RGB2 (analog)
RGB3 (analog)
RGB4 (digital)
RGB5 (digital)
Video 1
Video 2
Option Slot
Monitor Out
External Control
Sync Compatibility
Networking
USB

15 - 108 kHz
48 - 120 Hz
NTSC, NTSC4.43, PAL, PAL-60, PAL-M, PAL-N, SECAM
480i, 480p, 576i, 576p, 720p, 1080i, 1080p
VGA, SVGA, XGA, SXGA, SXGA+, UXGA, WUXGA
Yes

VGA 15-pin D-sub
VGA 15-pin D-sub
5-BNC
HDMI w/ HDCP
DisplayPort w/ HDCP
RCA
S-Video
HD/SD-SDI
VGA 15-pin D-sub
RS-232, IR, Wired LAN, DDC/CI, USB, Wireless LAN (optional)
Separate Sync / Composite Sync / Sync on G
RJ-45 and Wireless LAN (optional)
Viewer

ELECTRICAL

Power Requirements
Input Current
Power Consumption (Normal/ECO Mode/Standby/
Standby-Power Saving

100 - 240V AC, 50/60Hz
10.8A
1006W / 810W / 33W / 0.2W

MECHANICAL

Installation Orientation
Dimensions (WxDxH)
Net Weight
Fan Noise
Regulations

Floor/Front, Floor/Rear, Ceiling/Front, Ceiling/Rear
19.8 x 20.3 x 7.6 in. / 504 x 516 x 192mm
43.4 lbs. / 19.7 kg
43 dB normal / 39 dB eco
USA: UL60950-1, FCC Part15 Class B / Canada: CSA60950-1, ICES-003 Class B

ENVIRONMENTAL

Operating Temperature
Humidity
Storage

32° - 104°F / 0° - 40°C
20-80% non-condensing
-14° - 122°F / -10° - 50°C

ACCESSORIES

NP06FL
NP07ZL
NP08ZL
NP09ZL
NP10ZL
NP16FL
NP17ZL
NP18ZL
NP19ZL
NP20ZL
NP21ZL
NP02LM1
SB-01HC
PX750CM
PXCCase-01
RMT-PJ33
NP01PW1
RGBCBL-PJPX
NP02FT
SCP200
NP22LP
N8000-8830
NECEW2-I
NECEW1-I
ADVEXON1-I
ADVEXON2-I
TBD
TBD
TBD

0.77:1 fixed short throw lens for PX700W/PX800X
1.33 - 1.79:1 zoom lens for PX700W/PX800X
1.78 - 2.35:1 zoom lens for PX700W/PX800X
2.22 - 4.43:1 zoom lens for PX700W/PX800X
4.43 - 8.3:1 zoom lens for PX700W/PX800X
0.76:1 fixed short throw lens
1.25 - 1.79:1 zoom lens w/lens memory
1.73 - 2.27:1 zoom lens w/lens memory
2.22 - 3.67:1 zoom lens w/lens memory
3.6 - 5.4:1 zoom lens w/lens memory
5.3 - 8.3:1 zoom lens w/lens memory
Wireless LAN module
HD/SD-SDI input card
Ceiling mount
ATA-certified case for shipping and secure storage
Replacement remote control
Replacement power cable
Replacement RGB signal cable
Replacement filter
Suspended ceiling plate
Replacement lamp
NEC OPS PC with Intel Core i5, 320GB Hard Drive, Windows Embedded Standard 7
Extends term of parts and labor warranty to 5 years
Extends term of parts and labor warranty to 4 years
Extends term of InstaCare service program to 2 years
Extends term of InstaCare service program to 3 years
Maintenance plan
Extends maintenance plan for 3rd year including parts & labor
Extends maintenance plan for 4th year including parts & labor

* Lens does not ship with the projector.
Additional accessories are available, including screens, carts, mount accessories and replacement cables. Visit www.necdisplay.com for details.