



BVM / PVM Series OLED Monitor

BVM-E250A / BVM-E170A

Professional OLED Master Monitor

BVM-F250A / BVM-F170A

Professional OLED Master Monitor

PVM-2541A / PVM-1741A / PVM-741

Professional OLED Picture Monitor



2012 ENGINEERING
EMMY® AWARD WINNER

TRIMASTER EL – Evolution of Viewing Angles

Continuing enhancement to meet critical user expectations

Since their market debut, TRIMASTER EL™ OLED (organic light-emitting diode) monitors have proved extremely popular, and are now recognized as a standard in the industry. As well as offering features superior to CRT monitors, TRIMASTER EL monitors continually evolve to meet the expectations of critical users who demand professional-quality picture performance.

One new feature is the improved wider viewing angles, featured in the new TRIMASTER EL OLED A Series: BVM-E250A, BVM-E170A, BVM-F250A, BVM-F170A, PVM-2541A, and PVM-1741A.

With the improved viewing angle, color shift is reduced by half*¹ when compared with their predecessor models. Therefore, the new models offer the industry-leading wide viewing angles in the professional flat panel market. Also, this feature enables group monitoring – for example, video engineers or colorists can view the display properly from many different angles, allowing more productive content creation activities.

Two of these new models offer additional benefits. The PVM-2541A and PVM-1741A are equipped with a variety of convenient new features including new waveform capabilities, vector scope, closed caption display, and camera focus in color.

If you require a portable solution, consider the improved PVM-741 7-inch*² OLED monitor which includes the same additional features as the PVM-2541A and PVM-1741A in a highly mobile unit.*³ Now you can bring PVM OLED quality imaging with you, anytime, anywhere.

Designed for every professional need, it's time you experienced the immense value of new TRIMASTER EL monitors.

*1 Sony's measurement. Results may differ between monitors.
*2 188 mm viewable area, measured diagonally.
*3 Excludes the wider viewing angles of A Series models.



Predecessor models

Front view

The new "A-Series"

* Simulated images

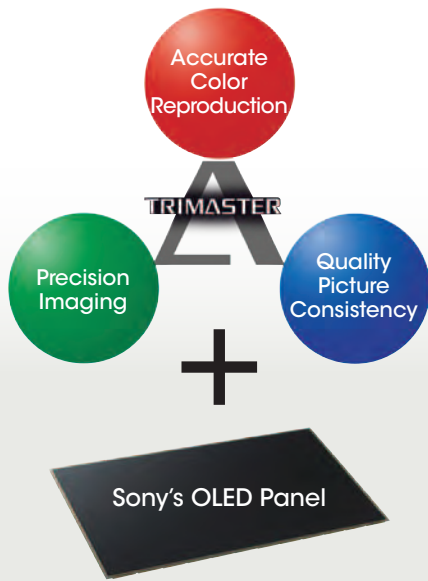

TRIMASTER EL

TRIMASTER™ Technology is a design architecture used to elicit the full performance capabilities of professional flat-panel displays. It comprises the core technologies that enable the highest level of color accuracy, precision imaging, and picture-quality consistency.

EL (Electro-Luminescence) is an ideal self-emission display device with a wide dynamic range and high picture quality. By refining TRIMASTER technology with the new EL device, Sony effectively boosts the performance expectations of the professional industry.

TRIMASTER EL Technology and Engineering All for high picture quality and reliability



Leveraging more than 30 years' experience of BVM design expertise

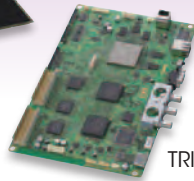
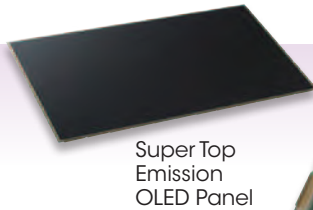

Developing Sony's original devices

Pursuing highest quality from device development to manufacturing

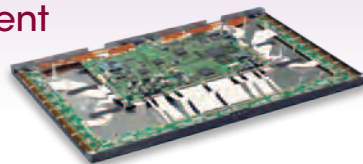

OLED Master Monitor

BVM-E / BVM-F Series – Master Monitors for critical picture evaluation

BVM-E Series for High-end Cinema / Broadcast Applications

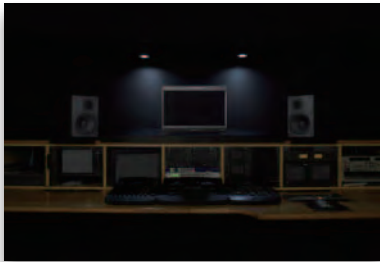

BVM-E250A



BVM-E170A



BVM-F Series for Broadcast Applications



BVM-F250A



BVM-F170A

OLED Picture Monitor

PVM Series – Picture Monitors for a wide range of monitoring application



PVM-2541A



PVM-1741A



PVM-741

Picture Monitor

Reference Monitor

Quality / Performance



PVM Series

Standard Panel

- Stunning OLED performance
- Full HD (1920 x 1080) *¹
- RGB 10bit Driver

Standard Engine

- 10-bit engine

BVM-F Series

BVM F Panel

Strictly controlled tolerance in addition to the standard panel performance.

Professional Display Engine

- 12-bit engine
- Accurate gamma control of extreme black details
- Cutting-edge I/P conversion with extremely low process delay
- Sophisticated non-linear cubic conversion color management

BVM-E Series

BVM E Panel

Designed as the highest performance panel. Used for the most critical picture evaluation needs.



Standard Features

• 3G-SDI (x 2) • RGB 4:4:4 • HDMI • Auto White Adjustment • Time code • Audio Level Meter*² • DC operation (17")

PVM Functions

- Waveform
- Audio

BVM Advanced Functions

- Option port x 4 (BKM x 6 selection)
- Dual Link*²
- DisplayPort (x1)
- Interlace display
- Pixel zoom
- HD frame capture
- 24P/PsF@72 Hz display
- 3D analysis*²

Digital Cinema Features

- 2K (2048 x 1080 RGB/XYZ) input
- ASC CDL • User LUT
- P&P (Wipe, Butterfly, Blending)

Functionality



*¹ Not applicable for PVM-741.

*² Option board required for BVM.

TRIMASTER EL – RGB 10-bit, Full HD

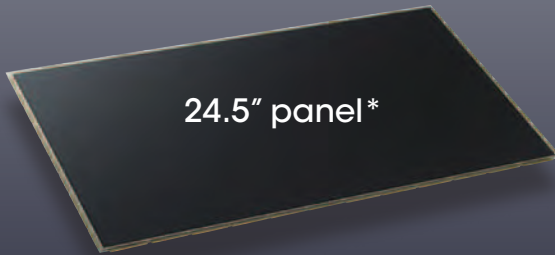

24.5" panel*



16.5" panel*

- Sony's unique Super Top Emission technology
- Deep black with wide dynamic range
- Quick response with virtually no motion blur
- Wide color gamut and accurate color reproduction

* 623.4 mm, and 419.7 mm (respectively), measured diagonally.

▲ TRIMASTER EL – Self-emitting Display Device

TRIMASTER EL creates light by recombining an electron and a hole within certain organic materials. The process of emitting light is extremely efficient when compared to other technologies currently used for display.

Its organic materials react to the control of the electrical current immediately, and do not emit light in the absence of an electrical current. In this way, the OLED display panel features superb black performance and quick response to fast-motion pictures. In addition, Sony's OLED display panel delivers a wider color gamut.

▲ Super Top Emission Technology

Sony's Super Top Emission OLED panel is designed to deliver light emission with the TFT layer on the rear side of the panel. Therefore, the top emission structure offers more efficient light emission than is typical with bottom emission structures where TFT layers are placed on the front side of the panel, limiting the light-emission aperture.

This Super Top Emission technology has a micro-cavity structure which incorporates color filters. This cavity structure uses an optical resonance effect to enhance color purity and improve light-emission efficiency. In addition, the color filter of each RGB also enhances the color purity of emitted light, and reduces ambient light reflection.

Sony's Super Top Emission OLED panel is completely sealed by a glass substrate, and the electroluminescent layer is fully isolated from outside air and moisture. This contributes to stability and reliability.

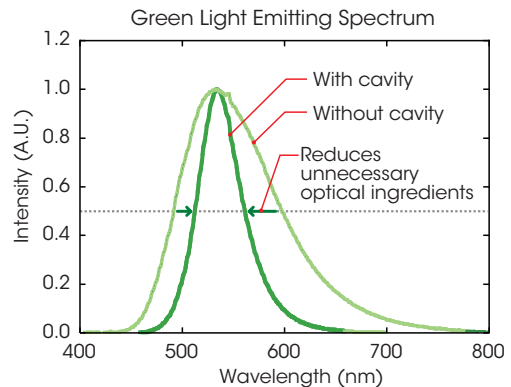
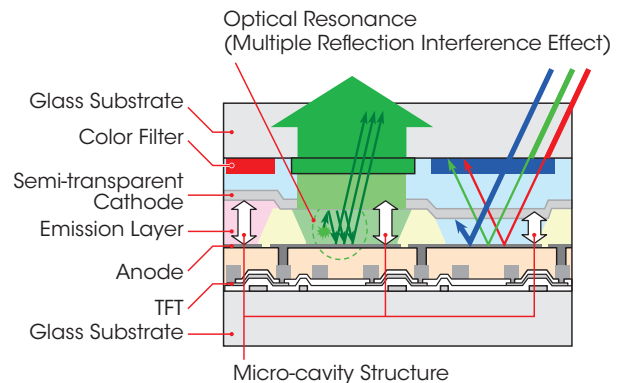



The TRIMASTER EL processor - Dedicated to eliciting full performance.

- Accurate signal processing across all signal levels
- Accurate gamma control
- Superb uniformity control

▲ Dedicated TRIMASTER EL Processor*

The BVM-E, BVM-F, and PVM Series of OLED monitors incorporate newly developed OLED-dedicated signal processors to elicit and maximize OLED panel performance. This technology allows these TRIMASTER EL™ monitors to provide the level of performance required for critical imaging. These processors accurately control gamma and uniformity, and deliver precision stability control.

* The PVM-741 is equipped with a different processing technology (ChromaTRU™).

Accurate gamma control

Since TRIMASTER EL panel can display a deeper black than any other display device, the TRIMASTER EL processor controls gamma accuracy (black reproduction) by increased signal processing bit depth.

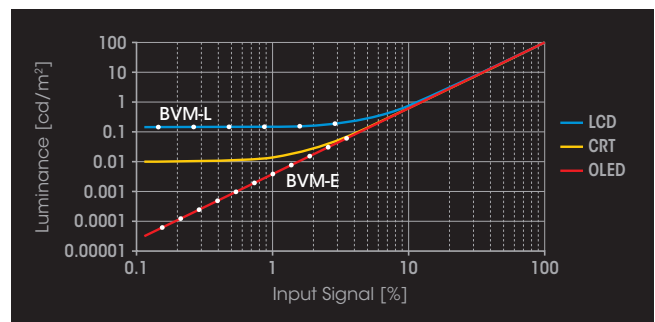

Superb uniformity control

TRIMASTER EL processor offers superb uniformity across all signal levels at every point of the screen. At the factory, OLED-panel uniformity is precisely measured and corrected using a proprietary RGB LUT (look-up table) adjustment system.

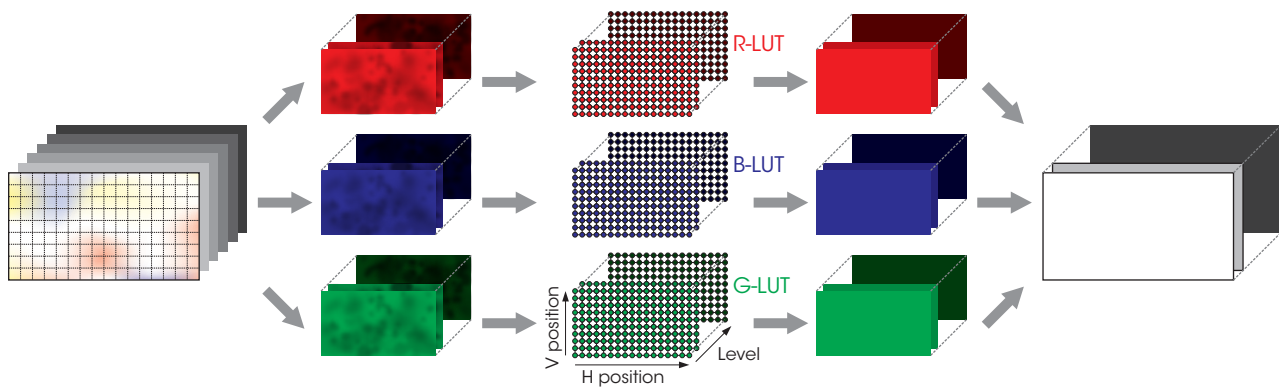

Accurate Black Reproduction

A key advantage of TRIMASTER EL is the fact that each pixel can be turned completely off. No other display technology offers this functionality. LCD either raises black luminance due to intrinsic light leakage, or reduces black luminance with artificial local dimming technologies. CRT always applies a bias voltage to place the gun at the proper operating level. All of these display devices have some limitation in accuracy of black reproduction. In comparison, TRIMASTER EL is capable of reproducing accurate black with each individual pixel, enabling users to evaluate each picture image faithfully to the signal.



LCD*



TRIMASTER EL*

* Simulated images

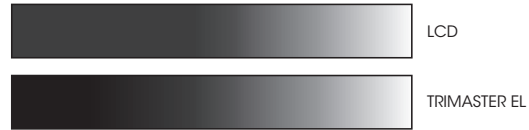
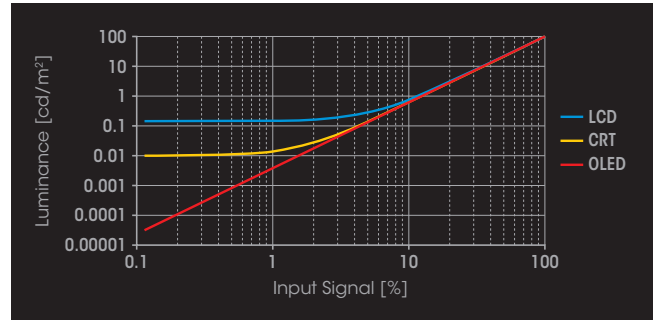

Gray scale images corresponding to the input signal

* Gray scales are simulated images.

Accurate Color Reproduction

Sony's Super Top Emission technology not only offers a wide color gamut with its purity of the three primary colors, but also maintains this wide color gamut throughout the entire luminance range. While all other display devices have limitations in reproducing accurate colors, especially in the low signal levels, TRIMASTER EL system is truly an ideal display device for picture evaluation. With OLED, users see the details in the blacks, as well as the colors.

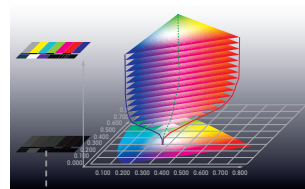

LCD*

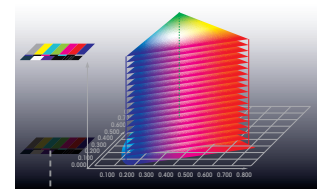

TRIMASTER EL*



* Color gamut images based on Sony's test results

Quick Response with Virtually No Motion Blur

The TRIMASTER EL gray-to-gray switching speed (measured in microseconds, μ s) is much faster than that of the LCD (measured in milliseconds, ms).* This fast response offers benefits to a variety of applications and uses. For example, in sports broadcasting, when camera pans would become blurred with an LCD, they remain sharp and clear with OLED. And with moving titles or graphics, when text can be difficult to read on an LCD, OLED displays clear text, regardless of speed or direction.

* Sony's test results.

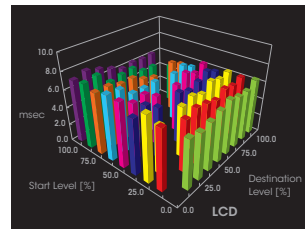

LCD



LCD*

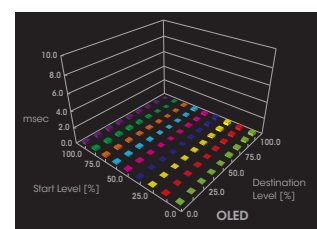

OLED



TRIMASTER EL*

* Simulated images

▲ Precision Imaging without Artifact

TRIMASTER EL monitors* incorporate the motion adaptive I/P conversion method, which detects information from multiple present and past fields. This is superior to conventional technology, which generally uses motion detection in fewer fields.

With this technology, TRIMASTER EL monitors reproduce video signals accurately without artifacts. You'll appreciate the difference immediately – for example, when there's zero tolerance for failure in shooting, you can be confident of fine patterns or delicate commercial logos.

* BVM-E / BVM-F only.

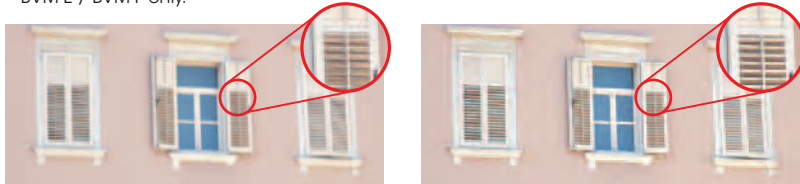

Conventional technology

TRIMASTER EL

* Simulated images

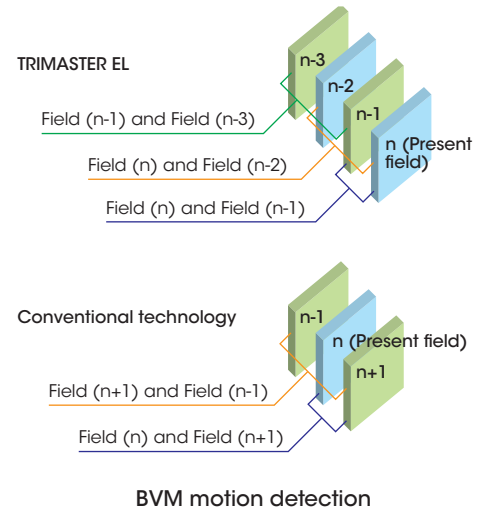

BVM motion detection

▲ Consistency/Repeatability

The performance of every TRIMASTER EL monitor is precisely adjusted and inspected on gamma, white balance, uniformity, etc., by a highly-robotized system and by professionally trained technicians at the final stage of manufacture prior to shipping. This quality control process provides substantial consistency and uniformity among TRIMASTER EL monitors.

In addition, color reproduction of BVM monitors can easily and accurately be duplicated to other BVM monitors using the Memory Stick® copy function. Color reproduction of every monitor is precisely matched, regardless of their location.



Conventional technology

TRIMASTER EL

* Simulated images



Monitors adjustment / inspection

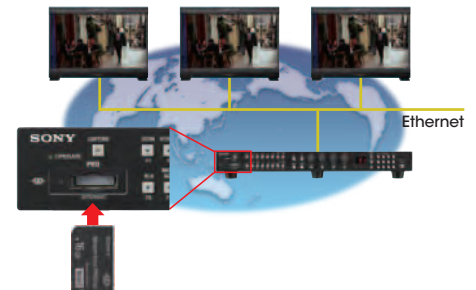

▲ Stability

TRIMASTER EL monitors are designed to control pixel-by-pixel light emission of the OLED panel. This system ensures emission stability over a long duration. You can use TRIMASTER monitors continuously over time with confidence.

In addition, Sony's Super Top Emission OLED panel is completely sealed by a glass substrate, and the electroluminescent layer is fully isolated from outside air and moisture. This also contributes to stability and reliability. TRIMASTER EL monitors can offer higher performance in terms of luminance and white balance than typical reference monitors.



Conventional technology

TRIMASTER EL

* Simulated images

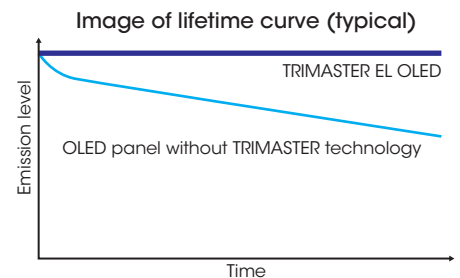

* Simulated image

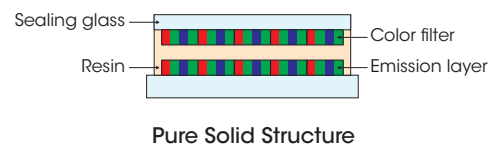

OLED Master Monitor

For Critical Picture Evaluation

BVM-E Series



BVM-E250A



BVM-E170A

BVM-F Series



BVM-F250A



BVM-F170A

The groundbreaking BVM-E250A and BVM-E170A, and BVM-F250A and BVM-F170A are reference monitors, using Sony's OLED system and incorporating leading-edge technologies to bring out the full performance capabilities required for critical picture evaluation, where accuracy is everything.

- TRIMASTER EL uses Sony's Super Top Emission technology with 10-bit RGB panels and OLED processing
- Professional display engine
 - Nonlinear Cubic Conversion color management system
 - Cutting-edge I/P conversion technology with extremely low process delay
 - 12-bit output accuracy signal processing
- Input versatility
 - Standard Input: 3G/HD/SD-SDI (x2) (selectable input), HDMI™ (HDCP) (x1), DisplayPort (x1)
 - Four option slots for input expansion: Six optional BKM boards are available for different needs
- Leading-edge features
 - Interlace Display, HD Frame Capture, Pixel Zoom, P&P (Side-by-side, Butterfly*, Wipe*, Blending*)
- Cinema features (BVM-E Series only)
 - Wide color gamut: D-Cine conforming to DCI-P3, BVM Native offering the widest color gamut
 - High frame rate: 24P/PsF, 25P/PsF are displayed at 72 Hz and 75 Hz respectively
 - 2K Cinema formats with multiple display modes (Full image display, or Native pixel-to-pixel display with an Image-slide function)
 - ASC CDL (American Society of Cinematographers Color Decision List) and User LUT
- Auto white adjustment with PC application software
- 3D signal analysis (as a 2D monitor) with optional BKM-250TG 3G-SDI input adaptor
- Closed caption display with optional BKM-244CC HD/SD-SDI closed caption adaptor

* BVM-E Series only.



Professional Display Engine (BVM-E / BVM-F Series-dedicated)

- Nonlinear Cubic Conversion color management system
- Cutting-edge I/P conversion technology with extremely low process delay
- 12-bit output accuracy signal processing

Professional Display Engine

The high-precision signal processing engine has been developed to fulfill the master monitor criteria and is optimized to maximize OLED panel performance. This engine incorporates 12-bit output accuracy at each process, and provides both a high quality I/P conversion algorithm and a highly accurate color management system.

Nonlinear Cubic Conversion color management

The nonlinear cubic conversion color management system of BVM-E and BVM-F Series master monitors use a unique 3D LUT (look-up table) to accurately reproduce the color gamuts of each broadcast standard such as ITU-R BT.709, EBU, and SMPTE-C phosphor standards. In addition, the OLED's wide color gamut enables D-Cine emulation for digital intermediate work.*

* D-Cine is a color gamut emulating the color gamut described in SMPTE RP 431-2-2007. The chromaticity of the green-red region is not covered in full; however, the color shift is subtle in this region. This feature is supported by the BVM-E Series only.

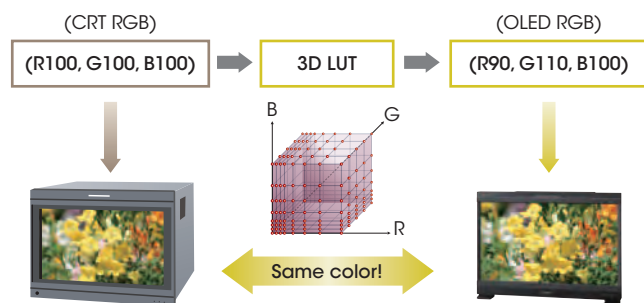

Nonlinear Cubic Conversion color management system

Cutting-edge I/P conversion with low process delay

Sony's original I/P conversion technology used in the BVM Series minimizes processing artifacts found in typical up-conversion processes. This has been improved in the BVM-E and BVM-F Series so that an interlaced image is displayed accurately and faithfully.

12-bit output accuracy signal processing

The BVM-E and BVM-F Series use a 12-bit display engine, which allows images to be reproduced with high precision for display accuracy.

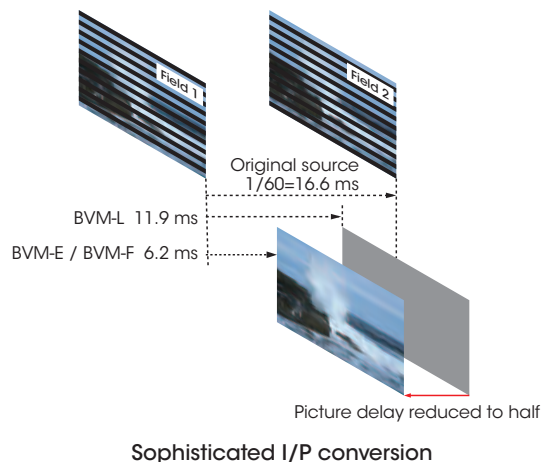
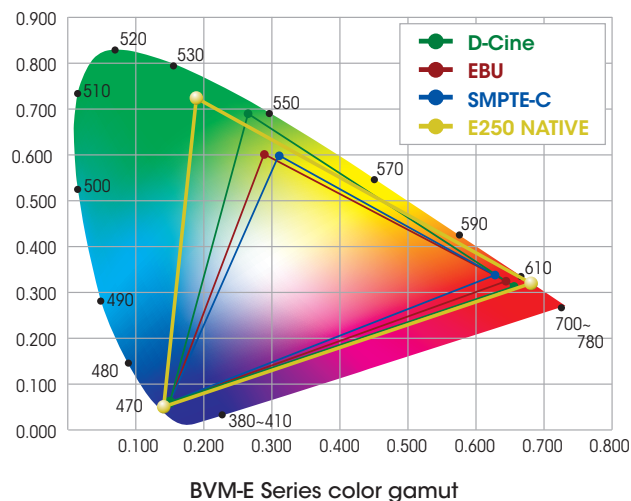

▲ BVM-E Series Digital Cinema Features

The BVM-E Series – comprising BVM-E250A and BVM-E170A master monitors – offers digital cinema features which are indispensable and ideal for high-quality creative digital cinema onset and post-production workflow.

2K (2048 x 1080, RGB/XYZ) Input

BVM-E250A and BVM-E170A master monitors are capable of 2K (2048 x 1080 resolution, RGB/XYZ) input. The 2K signal is displayed in two ways – as a full 2K image scaled into a full-HD (1920 x 1080) screen, or as a 2K native display with an image-slide function.

2048 Image-slide

The 2048 Image-slide function allows 2K resolution (2048 x 1080 pixels) images to be mapped, pixel-to-pixel, on the full-HD (1920 x 1080 pixels) panel without picture degradation. When the user needs to view the left or right edge of the picture frame, they can scroll the image in a horizontal direction.

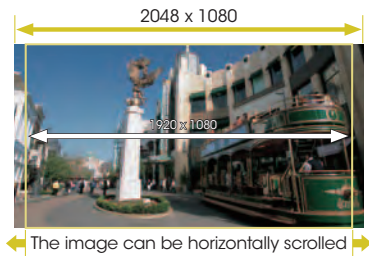

S-LOG Gamma

S-LOG gamma is a technique used in Sony’s digital cinematography cameras that allows the full latitude of the camera CCD to be maintained throughout the production chain. Unlike conventional systems, in which highlight contrast is compressed, S-LOG Gamma logarithmically converts the video signal using characteristics similar to film negatives. This keeps the camera CCD dynamic range intact, even in extreme highlight areas. Two display modes are offered:

1) S-LOG Full

This mode displays the full dynamic range of the video signal captured from Sony’s digital cinematography cameras.

2) S-LOG Standard

This mode displays image exposure levels at the lower part of the S-LOG gamma signal dynamic range, allowing image areas of regular brightness to be viewed clearly. Higher exposure levels are clipped in this mode.

Gamut Error Display

This function detects irregular signal input. When an irregular signal is detected, these master monitors indicate this with a zebra pattern over the relevant area of the picture.

Gamut Error Display is a convenient feature that instantly alerts viewers to such signals without requiring the use of a waveform monitor.



ASC CDL and User LUT Functions

BVM-E Series monitors support the ASC CDL (American Society of Cinematographers Color Decision List) and User LUT (Look-up Table) to emulate color grading.

Live images from camera onset can be altered after importing an ASC CDL format, and/or previewed using a film print emulation applied to the monitor using Look Creation Workflow.*1

Furthermore, once ASC CDL and User LUT data are created, all information*2 can be saved to Memory Stick media*3 and loaded onto the monitor from the BKM-16R*4 controller. Up to five items of ASC CDL and User LUT data can be imported to BVM-E Series monitors, so users can easily compare different color grading (see Look Application Workflow).

These features help with creative decision making and improve workflow between onset and post-production.

*1 Requires third-party software supporting the BVM-E ASC CDL and User LUT functions.

*2 Up to 1,000 data items.

*3 Can use a Memory Stick, Memory Stick PRO™, Memory Stick Duo™, Memory Stick PRO Duo™, or (with optional adaptor) Memory Stick Micro™.

*4 Requires the latest version of the BKM-16R with a product code suffix /7 or later.

Look Creation Workflow



Look Applying Workflow

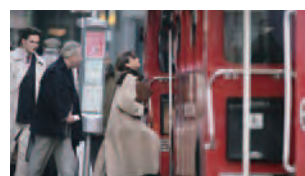
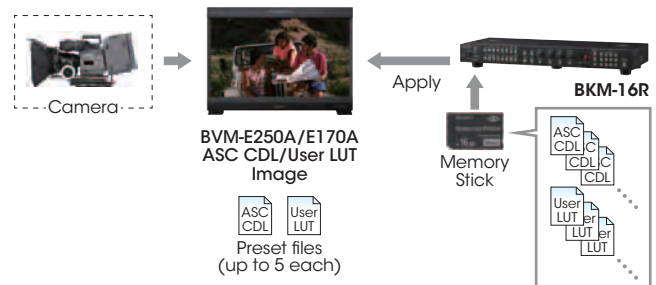

Live image from a camera



Onset graded image

* Simulated images

BVM Advanced Features

Input Versatility

Multi-format signal support

BVM-E and BVM-F Series monitors support various input signals ranging from 720 x 576/50i to 1920 x 1080/50P, 60P, digital cinema (D-Cine) 2048 x 1080/24P*, and numerous computer signals up to 1920 x 1080.

* 2048 x 1080/p signals are supported by the BVM-E Series only.

Standard 3G-SDI inputs plus versatile optional ports

These monitors are equipped with two standard 3G/HD/SD-SDI inputs and an HDMI (HDCP correspondence) input. In addition, four option ports are available. This increases system versatility and allows users to add decoders for signal formats not supported by the supplied inputs, including extra 3G-SDI, HD-SDI, or SD-SDI, and Dual-link HD-SDI, RGB, Y/Cb/Cr, Y/C, and composite signal inputs.

DisplayPort

These monitors are also equipped with a standard DisplayPort.

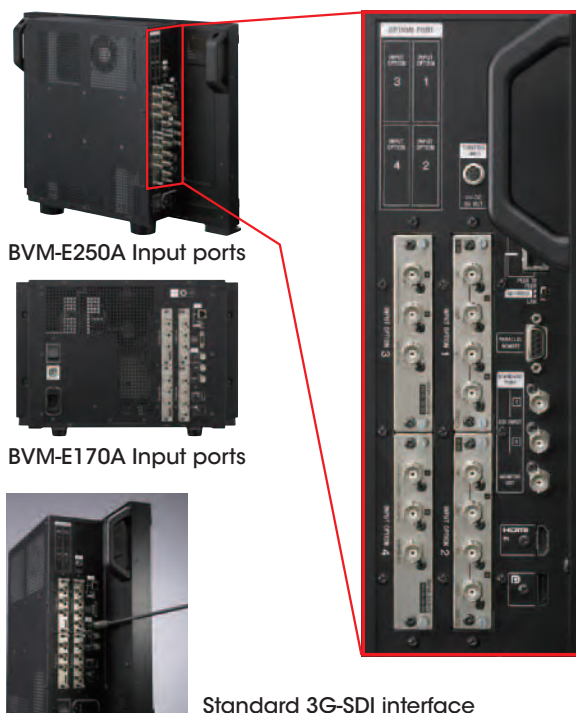

Signal-interface Options

BKM-250TG, 3G/HD/SD-SDI Input Adaptor*

- 3G/HD/SD-SDI signal input (x2)
- 3G/HD/SD-SDI monitor output (x2)

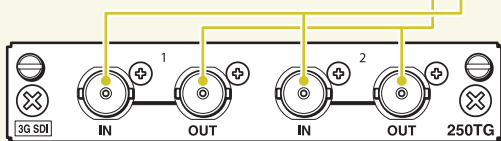

* 3G-SDI, HD-SDI and SD-SDI signals are detected automatically

BKM-244CC, HD/SD-SDI Closed Caption Adaptor*

- HD-SDI/SD-SDI signal input (x2)
- HD-SDI/SD-SDI monitor output (x1)

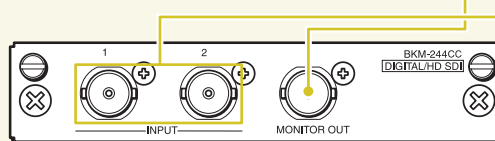

* HD-SDI and SD-SDI signals are detected automatically
* Closed-caption decoders (EIA 608 and EIA 708) are equipped

BKM-243HS, HD-SDI/SD-SDI Input Adaptor*

- HD-SDI/SD-SDI signal input (x2)
- HD-SDI/SD-SDI monitor output (x1)

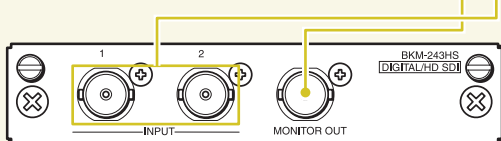

* HD-SDI and SD-SDI signals are detected automatically

BKM-229X, Analog Component Adaptor

- RGB, Y/Pb/Pr input (x1)
- EXT SYNC (x1)

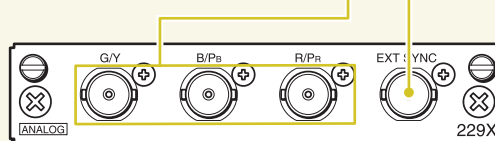

BKM-227W, NTSC/PAL Input Adaptor

- Composite input/output (x1)
- Y/C input/output (x1)

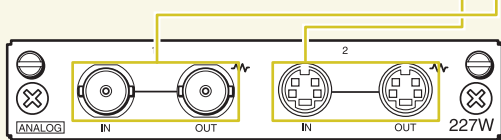

BKM-220D, SD-SDI 4:2:2 Input Adaptor

- SD-SDI signal input (x2)
- SD-SDI monitor output (x1)

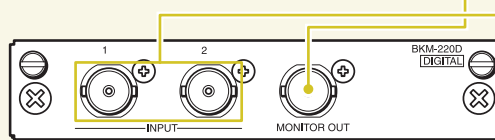

▲ Signal Analyzing Functions

Picture & Picture

The unique Picture & Picture function of the BVM-E and BVM-F Series allows simultaneous display of two input signals on the monitor's screen. This function is extremely convenient for making instant adjustments to two input sources, because there is no need to individually adjust the different characteristics of two monitors. This function comes in handy for adjustments between two cameras, special-effects creation, time-lapse shooting, and computer graphics (CG) work. The BVM-E Series offers four Picture & Picture modes and the BVM-F Series offers side-by-side mode:

■ Side-by-side

The two picture images are downscaled using a digital filter and displayed side-by-side. This feature is convenient when making white balance adjustments or determining shooting angles between two cameras.

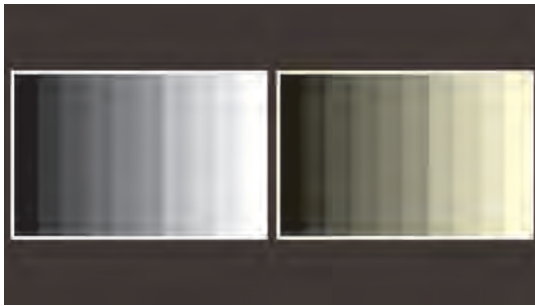

■ WIPE (BVM-E Series only)

The area of the two pictures to be displayed is selected using a vertical WIPE pattern, which is controlled from the BKM-16R.* This function is useful when picture detail of the two images must be examined on a pixel basis. This is normally used to review still images.

* Requires the latest version of the BKM-16R with a product code suffix /7 or later.

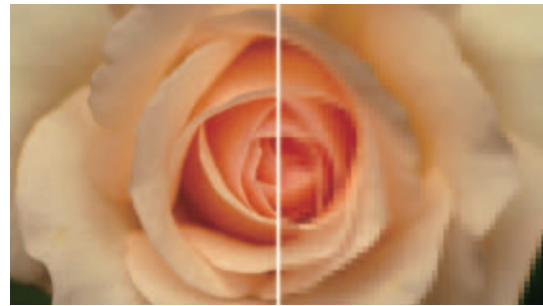

■ Butterfly (BVM-E Series only)

The two inputs are displayed as line-symmetric images on the left and right halves of the screen. By adjusting the H-position controller, the two images can be moved inward to the middle of the screen. An instant comparison of the moving images can then be made easily and accurately, without the user having to move their eyes.



■ Blending (BVM-E Series only)

The two picture images are overlapped for display, and the mix ratio is adjustable. This function is useful to verify whether a foreground signal is accurately keyed into the background signal, or when combining shoots with live action and computer-generated effects.



Pixel Zoom

Pixel Zoom is a function for magnifying images. A selected area of the displayed picture can be enlarged on a pixel basis, up to eight times in size both vertically and horizontally. Because this function does not use scaling, the desired picture content is magnified and displayed faithfully to the raw input signal. This function is useful when evaluating precise picture edges, such as for chroma keying.

* This function is effective when the input signal is displayed in "Native Scan" mode.



Error Signal

All images are simulated

3D Signal Analyzing Functions

By installing the optional BKM-250TG 3G/HD-SDI input adaptor*, the BVM-E and BVM-F Series monitors can support a variety of 3D signal analyses. The 3D signals are displayed in 2D mode.

* "Difference display" function require the BKM-250TG serial No. 7300001 or higher, and other functions require the BKM-250TG serial No. 7100001 or higher.

Difference Display

This function displays the difference between the luminance signal of the left (L) and right (R) images of the 3D signal. When the luminance levels of the two signals are the same, the signals are displayed in gray. When they are different, a monochrome image is displayed according to the variation in luminance. This function is useful for checking the amount of parallax.

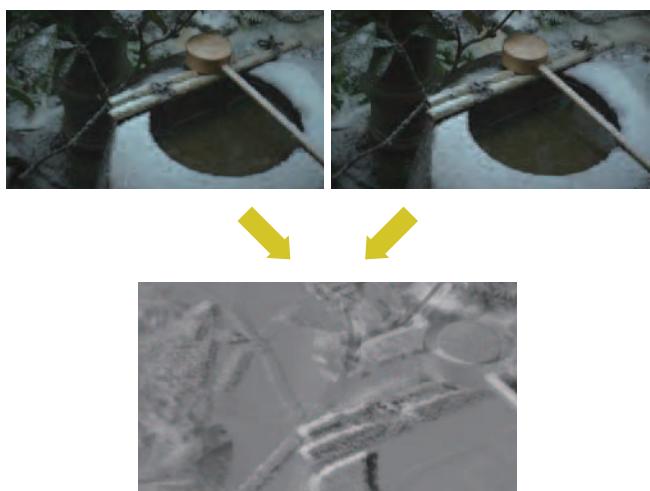

L/R Switch

Left and right signals can be swapped in a moment without inserting black frames, simply by manually pushing a function key. This instant-swap capability enables users to compare the entire images and check for any sense of incongruity or for unnatural images.

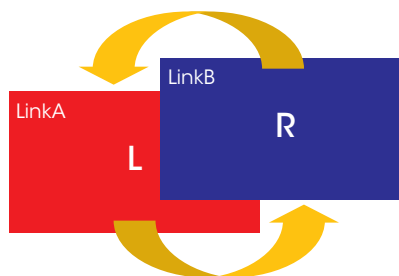

Horopter Check

This function helps users to perceive the subtle difference of depth between different objects placed on the 3D screen surface.

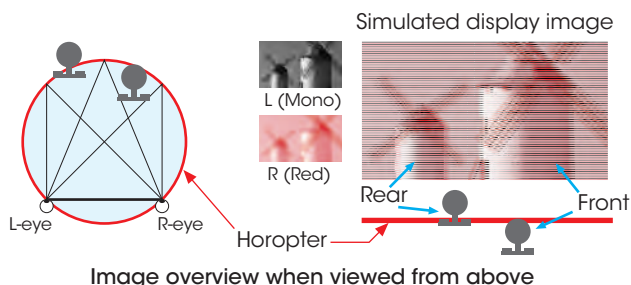

Checker Board

Left and right input signals are displayed in a grid pattern on screen. By comparing adjacent images, users can recognize a difference in brightness and the color setting of the left and right images, and thus easily adjust the camera's white balance and iris settings.

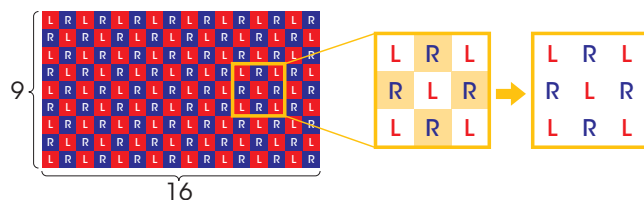

Horizontal Flip

When a half-mirror type of rig is used, either the left or right signal may be reversed horizontally. The Horizontal flip function turns the reversed image to the normal view.

* A delay in signal processing occurs, and both the left and right signals synchronize to the delayed signal.



All images are simulated

Convenient Features

Interlace Display

BVM-E and BVM-F Series monitors offer an Interlace Display feature for 1080i and SD inputs. This lets each BVM-E and BVM-F monitor display these inputs as a true interlace display. As with the Native Scan function, Interlace Display mode offers faithful reproduction of the input signal, and the displayed interlace fields are free from the picture degradation that can occur as a result of typical I/P conversion processes.

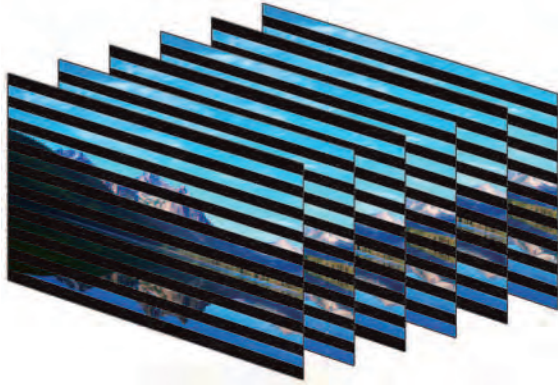

Scan Switch

The Scan Switch function allows switching between under scan (-3%), normal scan (0%), and over scan (mask of the 5% over scan portion in the normal scan).

Native Scan (pixel-to-pixel display)

Conventional flat-panel monitors reproduce images using scaling and I/P conversion due to their fixed pixel counts and progressive scanning processes. The Native Scan function is a unique display mode that reproduces images without changing the input signal's pixel count.

For example, when an SD signal is input, the BVM-E and BVM-F Series monitors will reproduce the image at a picture size of 720 x 487* pixels. For SD inputs the Native Scan function also allows the displayed image size to be doubled to 1440 x 974* by duplicating and doubling each pixel both horizontally and vertically.

* The 525/59.94i signal specified by Rec. ITU-R BT.601.

HD Frame Capture

The HD Frame Capture function of the BVM-E and BVM-F Series allows a picture frame from the 3G-SDI and HD-SDI input to be captured and saved as a picture file on Memory Stick media.* This picture file can be used as a reference for various purposes; for example, as for picture-tone adjustments between past images and for camera-framing adjustments.

* Memory Stick PRO (High-Speed) / Memory Stick PRO Duo (High-Speed) can be used.

Aspect Correction Mode

PAL and NTSC video systems are all based on rectangular pixels. Display of these formats on a square pixel panel typically distorts the image. The BVM-E and BVM-F Series use a unique process called Aspect Correction which, while still offering native pixel performance, continues to display image geometry correctly. This scaling technique used in BVM-E and BVM-F Series monitors corrects horizontal distortion while keeping the vertical pixel count correctly displayed.

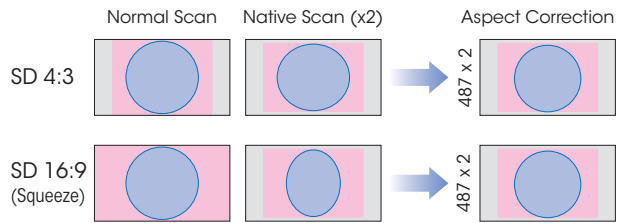

Example of NTSC signal on the 16:9 aspect panel – BVM-E250A



720 x 487 Native Scan



1440 x 974 Native Scan (720 x 487) x 2

Screen image is simulated

Aspect switch

The aspect ratio can be switched between 4:3, 16:9, 2.39:1, and 1.896:1 depending on the input signal.

16:9	↔	4:3
16:9	↔	2.39:1
1.896:1	↔	2.39:1

* The BVM-F Series monitors support 16:9 and 4:3 only.

Marker settings

BVM-E and BVM-F Series monitors can display various markers, including an aspect marker, safe area marker, and center marker. In addition to this flexible selection of marker types, detailed display settings of each marker are offered. For example, the color, brightness, horizontal/vertical position, and width of aspect markers can all be controlled, while the height and width of safe area markers can be adjusted.

Marker Variation

	Safe Area Marker		Aspect Marker*
	%	Dot (Pixel)	
Selectable Markers	80%, 88%, 90%, 93%, or variable	Flexible	16:9, 15:9, 14:9, 13:9, 4:3, 2.39:1, 2.35:1, 1.896:1, 1.85:1, or 1.66:1
Line Colors	White, Red, Green, Blue, Yellow, Cyan, or Magenta		
Line Width	1 to 5 dots (factory preset at 2 dots)		
Line Luminance	High (bright) or Low (dark)		
Blanking	—	Off: Blanking is released Black: Blanking Half: Half blanking	

* The BVM-F Series monitors support Aspect Markers of 16:9 and 4:3 only.

Marker Examples



Aspect Mode: 2.35:1,
Safe Area: Shape A,
Area Size: 80%



Aspect Mode: 14:9,
Safe Area: Shape B,
Area Size: 80%



Aspect Mode: 4:3,
Safe Area: Shape C,
Area Size: 80%

Wide Variety of Functions

The user has a wide variety of over 40 functions to choose from. Each of these can be assigned to any of the 16 function buttons (F1 to F16) on the BKM-16R* controller. Press ENTER to display the F1 to F8 (or F9 to F16) button assignment on screen.

* Requires the latest version of the BKM-16R with a product code suffix /7 or later.



ENTER button
F1 to F16 function buttons



(The next Function display)

* Screen image is simulated

Status Display

Simply assign STATUS to one of the function buttons (F1 to F16) on the BKM-16R* controller. The user can instantly grasp the whole monitor status and configurations without having to search through menus.

* Requires the latest version of the BKM-16R with a product code suffix /7 or later.



F1 to F16 function buttons

* Screen image is simulated

Modular Monitor Control Unit (BKM-16R*1)

BVM-E and BVM-F Series monitors and their control panels are provided as separate units, allowing greater flexibility for system integration. BVM-E and BVM-F Series monitors incorporate a monitor control unit (the BKM-16R) as an option. The BKM-16R can be attached beneath the monitor using the optional controller attachment stand*2, or connected remotely via an Ethernet cable.

*1 Requires the latest version of the BKM-16R with a product code suffix /7 or later, or the latest version of the BKM-37H, BKM-38H, and BKM-39H with a product code suffix /1 or later.

*2 The BVM-E250A and BVM-F250A use the BKM-37H or BKM-38H attachment stand. The BVM-E170A and BVM-F170A use the BKM-39H attachment stand.



BVM-E250A monitor
BKM-16R monitor control unit
BKM-37H attachment Stand



BVM-E170A monitor
BKM-16R monitor control unit
BKM-39H attachment Stand



BVM-F250A monitor
BKM-16R monitor control unit
BKM-38H attachment Stand

Copy function for monitor setup and adjustment data

The optional BKM-16R control unit includes a Memory Stick slot*1 to save and load monitor configuration and adjustment settings. This is useful for multiple monitor systems, allowing the transfer of one monitor's setup and adjustment data to another.*2 This data can also be transferred via the BVM's Ethernet connection.

*1 Memory Stick, Memory Stick PRO, Memory Stick Duo, Memory Stick PRO Duo, and Memory Stick Micro (an optional adaptor is required) can be used.

*2 Data can be moved between BVM-E and BVM-F Series monitors.

"+12dB Chroma UP" function

A "Chroma UP" button located on the front panel of the BKM-16R allows the chroma level to be boosted by +12 dB. This is a convenient feature for adjusting camera white balance with a higher degree of accuracy.

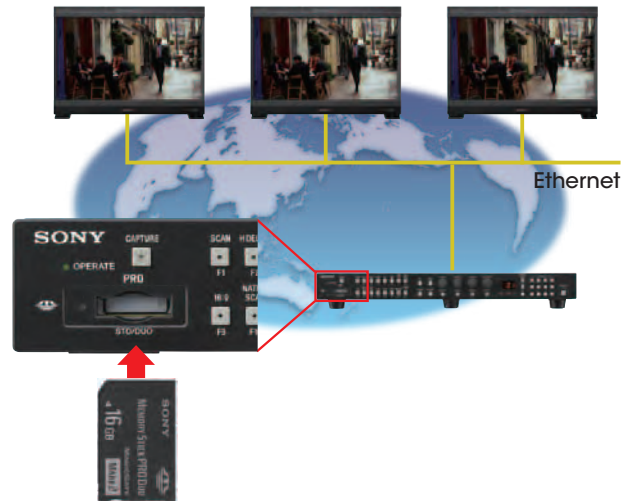

BKM-16R Monitor Control Unit



Front panel



Rear panel

Ethernet-based remote control

The BVM-E and BVM-F Series monitors and the BKM-16R Monitor Control Unit are equipped with an Ethernet port, allowing remote control of display parameters across a standard Ethernet connection. One BKM-16R Monitor Control Unit can control up to thirty-two (32) BVM* monitors.

* Includes BVM-A CRT monitors, BVM-L, PVM-L, and BVM-E/-F Series monitors.

Easy Setup and Adjustment

Auto White Adjustment*1

The BVM-E and BVM-F Series monitors employ a software-based color temperature (white balance) calibration function, which is called "Monitor_AutoWhiteAdjustment". Combined with a PC and commercially available calibration tools*2, this function enables simple adjustment of the monitor's white balance.

*1 Supported with version 1.1 or later. This software can be downloaded from sony.com/monitorssoftware

*2 Konica Minolta CA-210, CA-310, CS-200, DK-Technologies PM5639/06, X-Rite i1 Pro/i1 Pro2, Photo Research PR-655/670, Klein K-10, and JETI specbos 1211. A connector is required for each color analyzer.



"Monitor_AutoWhiteAdjustment" GUI image

Built-in Color Sensor for Auto White Adjustment

The BVM-E170A and BVM-F170A are equipped with a built-in color sensor, which allows the user to calibrate the monitor's color temperature (white balance) as needed without an external probe. Calibration performance is minimally affected by ambient light. This function ensures color and gamma consistency, and reduces user maintenance tasks.



"Character Off" button

To facilitate parameter adjustments, the On-Screen Menu indication can be taken off the screen, while in Menu mode. The On-Screen Menu indication can be toggled on or off with a simple press of a button on the BKM-16R's front panel.

Auto Chroma / Phase adjustment*

An Auto Chroma / Phase / Matrix setup function is provided on BVM-E and BVM-F Series monitors, which automatically adjusts the monitor's chroma, phase, and matrix using external color bars.

* Supports analog signal inputs only.

DC operation

The BVM-E170A and BVM-F170A can be DC operated. Due to their lightweight and small-size design, with a comparable height to the former 14-inch BVM-CRT monitors, the BVM-E170A and BVM-F170A are ideal for field and OB van applications.

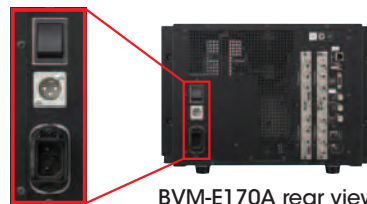

BVM-E170A rear view

Tilt stand for BVM-E250A / F250A



BVM-E250A with the optional BKM-37H* tilt stand

* Requires the latest version of the BKM-37H with a product code suffix /1 or later.

Other features

- VESA™ Mounting (200 x 100 mm pitch)*1
- EIA 19-inch Standard Rack-mountable*2
- Blue Only
- Mono
- H Delay / V Delay
- NTSC Setup Level (0%, 7.5%)
- Component Level (SMPTE / EBU-N10 or Betacam)
- Aperture
- Serial Remote (Ethernet)
- Parallel Remote (D-sub 9-pin)
- Tally Lamp (Amber)
- EXT Sync (for RGB / YUV)
- Remote Maintenance

*1 BVM-E250A / BVM-F250A only.

*2 BVM-E170A / BVM-F170A only. Mounting brackets are supplied.

OLED Picture Monitor

For Critical Picture Viewing



PVM-2541A



PVM-1741A



PVM-741

The PVM-2541A and PVM-1741A as well as the PVM-741 are all-in-one OLED picture monitors, delivering unparalleled picture quality with the performance features and functions found in more expensive monitors, all contained in a compact, stylish design.

- Sony's Super Top Emission OLED display panel with 10-bit RGB:
 - 24.5-inch* and 16.5-inch* (Full HD 1920 x 1080 pixels)
 - 7.4-inch* (Quarter HD 960 x 540 pixels)
- Wide dynamic range display
- New compact metal chassis
 - Lightweight and robust metal body
- Standard inputs
 - 3G/HD/SD-SDI input (x2), HDMI (HDCP) (x1), and Composite (x1)
- Built-in analyzers
 - Waveform monitor, vector scope, audio level meter, timecode
- Built-in closed-caption decoders (EIA 608, EIA 708)
- Camera focus function in colors
- Easy-to-use control panel
 - Rotary-type switch for quick menu access
 - Seven function-assignable buttons for direct and quick access
- DC 12V operations (PVM-1741A and PVM-741)
- Auto white adjustment with PC application software
- External remote control function (parallel and serial remote)

* 623.4 mm, 419.7 mm, and 188.0 mm (respectively), measured diagonally.

Groundbreaking Picture Performance with TRIMASTER EL Technologies

Sony's 24.5-inch*³, 16.5-inch*³, and 7.4-inch*³ Super Top Emission OLED display panels provide unparalleled black performance, a wide color gamut, and quick pixel response with virtually no motion blur. By combining TRIMASTER EL display panel (Full HD*¹, 10-bit driver) and TRIMASTER EL processing technologies*², the PVM Series of OLED monitors deliver exceptional picture quality never before seen in conventional picture monitors.

*1 The PVM-741 delivers Quarter HD (960 x 540) resolution.
*2 The PVM-741 is equipped with the ChromaTRU processing technology.
*3 Screen size measured diagonally.

Main Features

TRIMASTER EL with Full HD* and 10-bit RGB

The PVM-2541A and PVM-1741A OLED panel with Full HD resolution (1920 x 1080) and a 10-bit RGB driver, together with Sony's Super Top Emission OLED display panel, creates lifelike and smooth gradation from dark to bright portions of a scene such as in a sunrise or sunset.

* The PVM-741 delivers Quarter HD (960 x 540) resolution.



8-bit (256-levels) image* 10-bit (1024-levels) image*
* Simulated images

Superb Black Performance

Thanks to TRIMASTER EL system, deep blacks can be accurately displayed and the black portion of an image is not degraded.



Black performance image
* Simulated image

Wide Color Gamut and High-purity Deep Color Reproduction

TRIMASTER EL technology shows the largest color range of any Sony monitor ever offered. Color standards such as ITU-R BT.709, EBU, and SMPTE-C are displayed more accurately and, if desired, the OLED panel's native color gamut can be displayed. Sony's micro-cavity structure uses an optical resonance effect in combination with accurate color filters to calibrate and stabilize RGB color accuracy. This combination is also effective in reducing ambient light reflection, and consequently deep color reproduction can be achieved without degradation, particularly in bright environments.

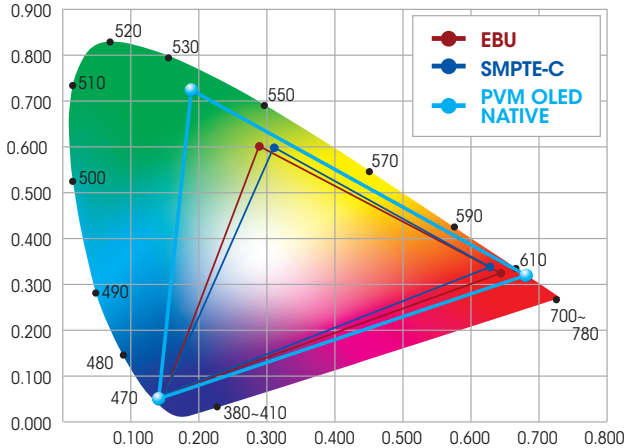

PVM Series OLED monitors color gamut

Quick Response with Blur-free Motion

Because the OLED electroluminescent layer inherently responds to any electrical current input, it emits light immediately. By this mechanism, excellent quick response characteristics can be achieved on fast-motion images. This efficient blur-free, fast response benefits a variety of applications and scenes, e.g., in sports broadcasting, monitoring of camera panning, and text scrolling.



Superb Uniformity

The PVM-2541A and PVM-1741A monitors incorporate a newly developed OLED process to bring out the full performances of the TRIMASTER EL panels. This TRIMASTER EL processor offers superb uniformity across all signal levels at every point of the screen. At the factory, the TRIMASTER EL panel uniformity is precisely measured and corrected using a sophisticated RGB LUT (look-up table) adjustment system.

I/P Mode Selection

The PVM-2541A, PVM-1741A, and PVM-741 monitors provide four I/P modes so that users can select the most suitable mode for each purpose:

- **INTER-FIELD:**
This mode interpolates images between fields. This is used for picture quality precedence (e.g., to reduce the jagged effect on moving pictures).
- **INTRA-FIELD:**
This mode interpolates images within the field, and delivers naturally reproduced images and quick picture processing. This mode is available only for 1920 x 1080 SDI signal input.
- **FIELD MERGE:**
This mode combines lines alternately in odd and even fields, regardless of picture movements. This is used for PsF (Progressive Segmented Frame) processing and still image monitoring.
- **LINE DOUBLER:**
This mode interpolates by repeating each line. This is used for editing and monitoring fast-moving images, and checking line flicker. The minimum processing time is less than one field (0.5 frames).

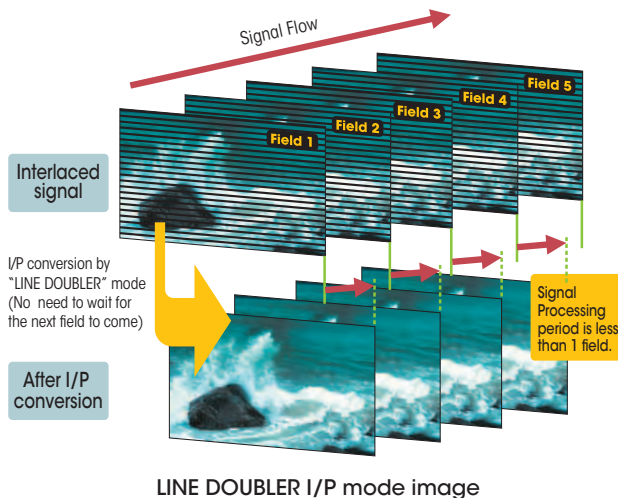

▲ Lightweight Compact Design - Flexible Mounting For Picture Monitoring

The PVM-2541A and PVM-1741A incorporate a lightweight, compact metal body. Their design offers flexibility, and can be adapted according to the application: a desktop unit with standard table feet, or used with an optional SU-561 stand, or without the stand for wall applications.

These monitors support VESA mounting with a 100 mm pitch, and EIA 19-inch standard racks.* This allows the monitors to be used for all types of application - desktop editing, office viewing, on a studio monitor wall, or installed in OB vans.

* The PVM-1741A only is available with standard rack-mount brackets.



PVM-2541A front



PVM-2541A rear



PVM-2541A side



PVM-1741A front



PVM-1741A rear



PVM-1741A side



PVM-2541A standard



PVM-2541A with optional SU-561



PVM-2541A without stand

▲ Closed-caption Display

When inputting SD-SDI or HD-SDI signals, closed-caption signals of EIA/CEA-608 and EIA/CEA-708 are decoded and displayed on screen.

▲ Easy-to-use Control Panel

A rotary-type switch and seven function-assignable buttons allow users quick and intuitive operation. Operation buttons with LED indicators enable error-free operation, even in dark environments.*

* LED lights can be switched on/off.

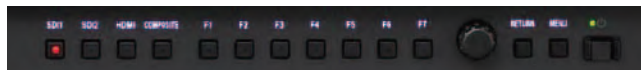

Control panel with LED lights-on

▲ Input Versatility

The PVM-2541A, PVM-1741A, and PVM-741 monitors are equipped with built-in standard input interfaces: 3G/HD/SD-SDI (x2), HDMI (HDCP) input (x1) and composite (x1).

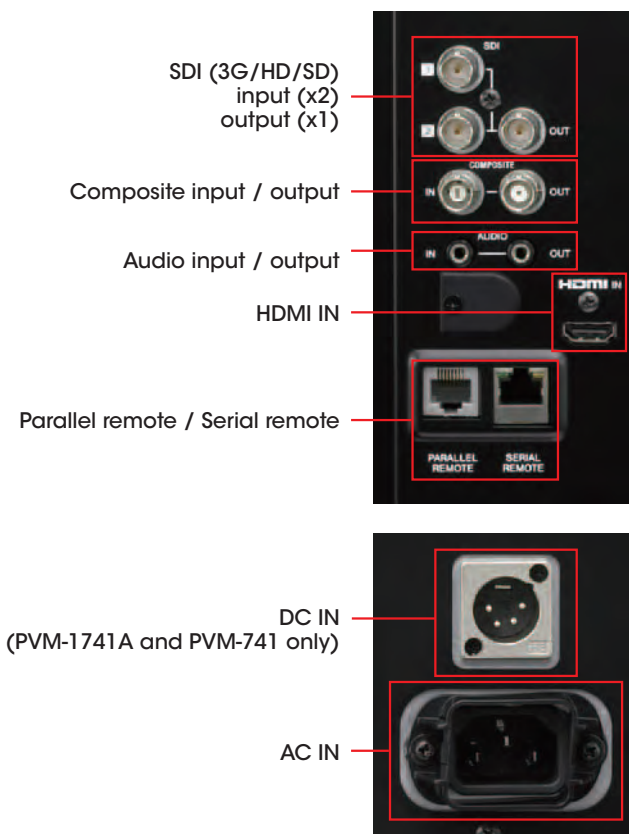

Waveform Monitor and Vector Scope Display

An input signal's waveform and vector scope with an SDI-embedded 2-channel audio level meter can be displayed on screen. Both the waveform monitor and vector scope have various modes, including a zoom function (in an area of 0 to 20 IRE) with the waveform monitor, and a zoom function (in the central black area) with the vector scope, for adjusting white balance. The waveform of a specified line can also be displayed.

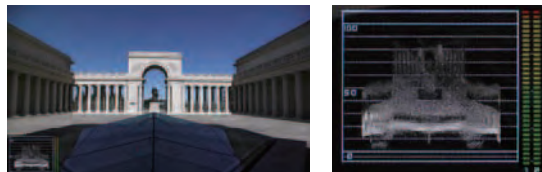

Waveform monitor

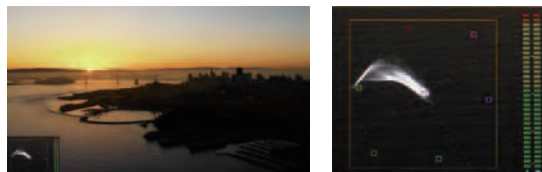

Vector scope

Time Code Display

Time code embedded on SDI signals can be displayed on screen. Users can select either LTC or VITC.

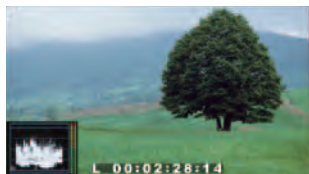

* Simulated images

Safety Area Markers

The safety area markers can be selected from 80%, 85%, 88%, 90%, and 93%.

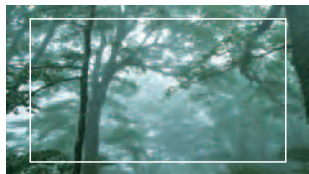

8-ch Audio Level Meter Display

When an SDI interface is connected, the embedded audio level can be displayed on screen with an 8-channel audio level meter. Channels 1 to 8 or 9 to 16 can be displayed.

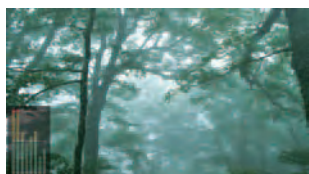

Audio level meter

Camera Focus Function

The PVM-2541A, PVM-1741A, and PVM-741 can control the aperture level of a video signal, and display images on the screen with sharpened edges to help camera focus operation. Further to this, the sharpened edges can be displayed in user-selectable colors (white, red, green, blue, and yellow) for more precise focusing. This camera focus function can even be enhanced when combined with native scan mode.

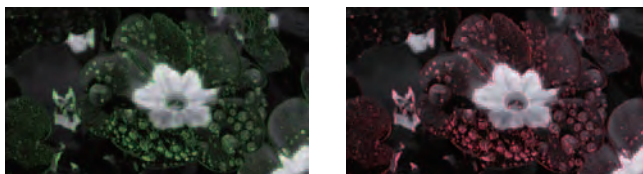

External Remote Control Function

The PVM-2541A, PVM-1741A, and PVM-741 have an external remote control capability for input/output signal selection and adjustment of various items via an Ethernet (10BASE-T/100BASE-TX) connection. Up to 32 monitors and up to four control units can be connected via Ethernet connection and controlled remotely on the network. Also these monitors support some functions of the BKM-16R – an optional remote control unit for BVM-E/BVM-F/BVM-L/PVM-L Series monitors – such as the power on/off switch and the Input Select function. *

* The PVM-2541A, PVM-1741A, and PVM-741 do not support all BKM-16R functions.

Auto White Adjustment

The PVM-2541A, PVM-1741A, and PVM-741 monitors employ a software-based color temperature (white balance) calibration function, which is called "Monitor_AutoWhiteAdjustment". Combined with a PC and commercially available calibration tools*, this function enables simple adjustment of the monitor's white balance.

* The Konica Minolta CA-210/CA-310/CS-200, DK-Technologies PM5639/06, X-Rite i1 Pro/i1 Pro2, Photo Research PR-655/670, Klein K-10, and JETI specbos 1211. Software can be downloaded from sony.com/monitorsoftware



"Monitor_AutoWhiteAdjustment" GUI image



PVM-741

*Simulated image

7.4-inch OLED panel

▲ OLED Portable Picture Monitor – PVM-741

The PVM-741 is a portable monitor in the PVM Series of OLED monitors. It packs high performance and a variety of features and functions in its robust and compact body.

- Sony's Super Top Emission OLED panel with a 10-bit driver
- Deep black and high contrast, high-purity deep color reproduction
- Quick pixel response with virtually no motion blur
- Wide color gamut and accurate gamma supporting broadcast standards (SMPTE-C, EBU, and ITU-R BT.709)
- Audio level meter, waveform monitor, and vector scope
- Two 3G/HD/SD-SDI and an HDMI input interfaces

Robust, light-weight, and compact body

Incorporating a light-weight and compact aluminum-diecast body with a detachable AR-coated protection panel, this model is flexible enough to change style according to user requirements.



AR-coated protection panel



PVM-741 installed in the optional MB-531 19" mounting bracket with MB-532 mounting panel

Retractable Carrying Handle

The PVM-741 provides a retractable carrying handle as a supplied accessory. With this carrying handle, users find it easy to carry this superb OLED performance anytime, anywhere.



PVM-741 with carrying handle

Easy Mounting into A Camera System

With 3/8-inch and 1/4-inch screw holes on its base, the PVM-741 can be installed in a camera system. Also with the supplied arm-mount bracket fixed on the top. The PVM-741 can be installed in a camera arm.

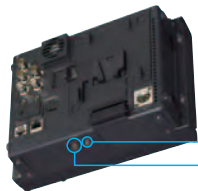

PVM-741 rear and bottom

1/4 inch hole
3/8 inch hole

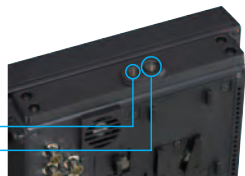

Arm-mount bracket is attached on the top

ENG Kit VF-510

For use in ENG and EFP field, the optional VF-510 ENG Kit provides a viewing hood, carrying handle, and connector protector.



PVM-741 with VF-510 ENG Kit

Camera Focus Function

The PVM-741 can control the aperture level of a video signal, and display images on the screen with sharpened edges to help camera focus operation. Further to this, the sharpened edges can be displayed in user-selectable colors (white, red, green, blue, and yellow) for more precise focusing. This camera focus function can even be enhanced when combined with native scan mode.



Waveform Monitor and Vector Scope Display

An input signal's waveform and vector scope with an SDI-embedded 2-channel audio level meter can be displayed on screen. Both the waveform monitor and vector scope have various modes, including a zoom function.

Waveform monitor

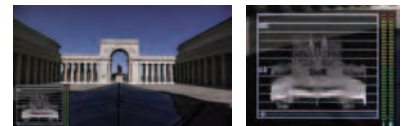

Vector scope

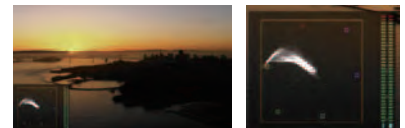

Flip function

The PVM-741 monitor has a feature to flip a picture without frame delay, horizontally, vertically, or horizontally and vertically.

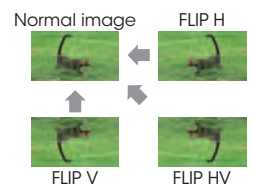

Input versatility

The PVM-741 is equipped with built-in standard input interfaces: 3G/HD/SD-SDI (x2), composite (x1), and HDMI input (x1).



BVM-E / BVM-F Series Signal Formats / Input Adaptors

Input signal	Signal system	Signal format	Standard SDI Input	BKM-220D	BKM-227W	BKM-229X	BKM-243HS BKM-244CC	BKM-250TG	
Analog composite	487/59.94i	NTSC				○			
	576/50i	PAL/SECAM				○			
	487/59.94i	PAL-M				○			
Analog Y/C	487/59.94i	NTSC				○			
	576/50i	PAL/SECAM				○			
	487/59.94i	PAL-M				○			
Analog component, RGB	1080/60i*1	Y/Pb/Pr, RGB				○			
	1080/50i					○			
	1080/24PsF*1					○			
	1080/25PsF					○			
	1080/30PsF*1					○			
	1080/24p*1					○			
	1080/25p					○			
	1080/30p*1					○			
	720/60p*1					○			
	720/50p					○			
	576/50i						○		
	487/59.94i						○		
	SD-SDI		720 x 487/59.94i	4:2:2 Y/Cb/Cr	○	○			○
720 x 576/50i		○	○			○	○		
HD-SDI	1920 x 1080/24PsF*1	10 bit 4:2:2 Y/Cb/Cr	○				○	○	
	1920 x 1080/25PsF		○			○	○		
	1920 x 1080/30PsF*1		○			○	○		
	1920 x 1080/24p*1		○			○	○		
	1920 x 1080/25p		○			○	○		
	1920 x 1080/30p*1		○			○	○		
	1920 x 1080/50i		○			○	○		
	1920 x 1080/60i*1		○			○	○		
	1280 x 720/24p*1		○			○	○		
	1280 x 720/25p		○			○	○		
	1280 x 720/30p*1		○			○	○		
	1280 x 720/50p		○			○	○		
	1280 x 720/60p*1		○			○	○		
HD-SDI dual-link	1920 x 1080/24PsF*1	10 bit 4:4:4 Y/Cb/Cr, RGB 12 bit 4:4:4 Y/Cb/Cr, RGB					○*2	○	
	1920 x 1080/25PsF					○*2	○		
	1920 x 1080/30PsF*1					○*2	○		
	1920 x 1080/24p*1					○*2	○		
	1920 x 1080/25p					○*2	○		
	1920 x 1080/30p*1					○*2	○		
	1920 x 1080/50i					○*2	○		
	1920 x 1080/60i*1				○*2	○			
	1920 x 1080/50p	10 bit 4:2:2 Y/Cb/Cr					○*2	○	
	1920 x 1080/60p*1						○*2	○	
	2048 x 1080/24PsF*1*3		10 bit/12 bit 4:4:4 RGB 12 bit 4:4:4 XYZ					○*2	○
	2048 x 1080/24p*1*3							○*2	○
	2048 x 1080/25PsF*3							○*2	○
2048 x 1080/25p*3							○*2	○	
2048 x 1080/30PsF*1*3						○*2	○		
2048 x 1080/30p*1*3					○*2	○			
3G-SDI	1920 x 1080/24PsF*1	10 bit 4:4:4 Y/Cb/Cr, RGB 12 bit 4:4:4 Y/Cb/Cr, RGB	○*4					○*4	
	1920 x 1080/25PsF		○*4				○*4		
	1920 x 1080/30PsF*1		○*4				○*4		
	1920 x 1080/24p*1		○*4				○*4		
	1920 x 1080/25p		○*4				○*4		
	1920 x 1080/30p*1		○*4				○*4		
	1920 x 1080/50i		○*4				○*4		
	1920 x 1080/60i*1	○*4				○*4			
	1920 x 1080/50p	10 bit 4:2:2 Y/Cb/Cr	○					○	
	1920 x 1080/60p*1		○				○		
	1280 x 720/24p*1		○*4				○*4		
	1280 x 720/25p	10 bit 4:4:4 Y/Cb/Cr, RGB	○*4				○*4		
	1280 x 720/30p*1		○*4				○*4		
	1280 x 720/50p		○*4				○*4		
	1280 x 720/60p*1		○*4				○*4		
	2048 x 1080/24PsF*1*3		○*4				○*4		
	2048 x 1080/24p*1*3		○*4				○*4		
	2048 x 1080/25PsF*3		○*4				○*4		
	2048 x 1080/25p*3	10 bit/12 bit 4:4:4 RGB 12 bit 4:4:4 XYZ	○*4				○*4		
	2048 x 1080/30PsF*1*3		○*4				○*4		
2048 x 1080/30p*1*3	○*4					○*4			
2048 x 1080/30p*1*3	○*4					○*4			

*1 Also compatible with 1/1.001 frame rates. *2 Two BKM-243HS or BKM-244CC are used.
 *3 Supported with the BVM-E250A and BVM-E170A only. *4 Untested.

BVM-E / BVM-F Series HDMI and DisplayPort Input Signal Formats

System	Interface sampling frequency [MHz]	Aspect ratio	Standard	HDMI		DisplayPort	
				RGB 4:4:4 8/10/12 bit Y/Cb/Cr 4:4:4 8/10/12 bit Y/Cb/Cr 4:2:2 12 bit		RGB 4:4:4 6/8/10 bit Y/Cb/Cr 4:4:4 6/8/10 bit Y/Cb/Cr 4:2:2 12 bit	
Video Signals							
640 x 480/60p*1	25.200*1	4:3	CEA-861	<input type="radio"/>	<input type="radio"/>	<input type="radio"/>	<input type="radio"/>
720 x 480/60p*1	27.027*1	4:3/16:9		<input type="radio"/>	<input type="radio"/>	<input type="radio"/>	<input type="radio"/>
1280 x 720/60p*1	74.250*1	16:9		<input type="radio"/>	<input type="radio"/>	<input type="radio"/>	<input type="radio"/>
1920 x 1080/60i*1	74.250*1	16:9	CEA-861	<input type="radio"/>	<input type="radio"/>	<input type="radio"/>	<input type="radio"/>
		2.39:1		<input type="radio"/>	<input type="radio"/>	<input type="radio"/>	<input type="radio"/>
720 (1440) x 480/60i*1	27.027*1	4:3/16:9	CEA-861	<input type="radio"/>	<input type="radio"/>	<input type="radio"/>	<input type="radio"/>
720 x 576/50p	27.000	4:3/16:9		<input type="radio"/>	<input type="radio"/>	<input type="radio"/>	<input type="radio"/>
1280 x 720/50p	74.250	16:9		<input type="radio"/>	<input type="radio"/>	<input type="radio"/>	<input type="radio"/>
1920 x 1080/50i	74.250	16:9	CEA-861	<input type="radio"/>	<input type="radio"/>	<input type="radio"/>	<input type="radio"/>
		2.39:1		<input type="radio"/>	<input type="radio"/>	<input type="radio"/>	<input type="radio"/>
720 (1440) x 576/50i	27.000	4:3/16:9	CEA-861	<input type="radio"/>	<input type="radio"/>	<input type="radio"/>	<input type="radio"/>
1920 x 1080/60p*1	148.500*1	16:9	CEA-861	<input type="radio"/>	<input type="radio"/>	<input type="radio"/>	<input type="radio"/>
		2.39:1		<input type="radio"/>	<input type="radio"/>	<input type="radio"/>	<input type="radio"/>
1920 x 1080/50p	148.500	16:9	CEA-861	<input type="radio"/>	<input type="radio"/>	<input type="radio"/>	<input type="radio"/>
		2.39:1		<input type="radio"/>	<input type="radio"/>	<input type="radio"/>	<input type="radio"/>
1920 x 1080/24p*1	74.250*1	16:9	CEA-861	<input type="radio"/>	<input type="radio"/>	<input type="radio"/>	<input type="radio"/>
		2.39:1		<input type="radio"/>	<input type="radio"/>	<input type="radio"/>	<input type="radio"/>
1920 x 1080/25p	74.250	16:9	CEA-861	<input type="radio"/>	<input type="radio"/>	<input type="radio"/>	<input type="radio"/>
		2.39:1		<input type="radio"/>	<input type="radio"/>	<input type="radio"/>	<input type="radio"/>
1920 x 1080/30p*1	74.250*1	16:9	CEA-861	<input type="radio"/>	<input type="radio"/>	<input type="radio"/>	<input type="radio"/>
		2.39:1		<input type="radio"/>	<input type="radio"/>	<input type="radio"/>	<input type="radio"/>
2048 x 1080/24p*1*2	74.250*1	1.896:1		<input type="radio"/>	<input type="radio"/>	<input type="radio"/>	<input type="radio"/>
		2.39:1		<input type="radio"/>	<input type="radio"/>	<input type="radio"/>	<input type="radio"/>
2048 x 1080/25p*2	74.250	1.896:1		<input type="radio"/>	<input type="radio"/>	<input type="radio"/>	<input type="radio"/>
		2.39:1		<input type="radio"/>	<input type="radio"/>	<input type="radio"/>	<input type="radio"/>
2048 x 1080/30p*1*2	74.250*1	1.896:1		<input type="radio"/>	<input type="radio"/>	<input type="radio"/>	<input type="radio"/>
		2.39:1		<input type="radio"/>	<input type="radio"/>	<input type="radio"/>	<input type="radio"/>
2048 x 1080/60p*1*2	148.500*1	1.896:1		<input type="radio"/>	<input type="radio"/>	<input type="radio"/>	<input type="radio"/>
		2.39:1		<input type="radio"/>	<input type="radio"/>	<input type="radio"/>	<input type="radio"/>
2048 x 1080/50p*2	148.500	1.896:1		<input type="radio"/>	<input type="radio"/>	<input type="radio"/>	<input type="radio"/>
		2.39:1		<input type="radio"/>	<input type="radio"/>	<input type="radio"/>	<input type="radio"/>
2048 x 1080/48p*1*2	148.500*1	1.896:1		<input type="radio"/>	<input type="radio"/>	<input type="radio"/>	<input type="radio"/>
		2.39:1		<input type="radio"/>	<input type="radio"/>	<input type="radio"/>	<input type="radio"/>
Computer Signals							
800 x 600/60p	40.000	4:3	VESA	<input type="radio"/>	<input type="radio"/>	<input type="radio"/>	<input type="radio"/>
1024 x 768/60p	65.000	4:3		<input type="radio"/>	<input type="radio"/>	<input type="radio"/>	<input type="radio"/>
1280 x 960/60p	108.000	4:3		<input type="radio"/>	<input type="radio"/>	<input type="radio"/>	<input type="radio"/>
1280 x 1024/60p	108.000	5:4		<input type="radio"/>	<input type="radio"/>	<input type="radio"/>	<input type="radio"/>
1400 x 1050/60p	121.750	4:3		<input type="radio"/>	<input type="radio"/>	<input type="radio"/>	<input type="radio"/>
				<input type="radio"/>	<input type="radio"/>	<input type="radio"/>	<input type="radio"/>

*1 Also compatible with 1/1.001 frame rates. *2 Supported with the BVM-E250A and BVM-E170A only.

PVM-2541A / PVM-1741A / PVM-741 Signal Formats

System	Signal standard			
	Analog composite	HD/SD-SDI	3G-SDI	HDMI
575/50i (PAL)	<input type="radio"/>	<input type="radio"/>	-	<input type="radio"/>
480/60i (NTSC)*1	<input type="radio"/>	<input type="radio"/>	-	<input type="radio"/>
576/50p	-	-	-	<input type="radio"/>
480/60p*1	-	-	-	<input type="radio"/>
640 x 480/60p*1	-	-	-	<input type="radio"/>
1080/24PsF*1*2	-	<input type="radio"/>	<input type="radio"/> *3	-
1080/25PsF*2	-	<input type="radio"/>	<input type="radio"/> *3	-
1080/30PsF*1*2	-	-	<input type="radio"/> *3	-
1080/24p*1	-	<input type="radio"/>	<input type="radio"/> *3	<input type="radio"/>
1080/25p	-	<input type="radio"/>	<input type="radio"/> *3	<input type="radio"/>
1080/30p*1	-	<input type="radio"/>	<input type="radio"/> *3	<input type="radio"/>
1080/50i	-	<input type="radio"/>	<input type="radio"/> *3	<input type="radio"/>
1080/60i*1	-	<input type="radio"/>	<input type="radio"/> *3	<input type="radio"/>
1080/50p	-	-	<input type="radio"/> *4	<input type="radio"/> *6
1080/60p*1	-	-	<input type="radio"/> *4	<input type="radio"/> *6
720/24p*1	-	-	<input type="radio"/> *5	-
720/25p	-	-	<input type="radio"/> *5	-
720/30p*1	-	-	<input type="radio"/> *5	-
720/50p	-	<input type="radio"/>	<input type="radio"/> *3	<input type="radio"/> *6
720/60p*1	-	<input type="radio"/>	<input type="radio"/> *3	<input type="radio"/> *6

*1 Compatible with 1/1.001 frame rates. *2 1080/24PsF, 25PsF, and 30PsF are displayed as 1080/48i, 50i, and 60i on the screen, respectively.

*3 10-bit 4:4:4 Y/Cb/Cr and 4:4:4 RGB of 3G-SDI signals are supported. *4 10-bit 4:2:2 Y/Cb/Cr of 3G-SDI signal is supported.

*5 10-bit 4:4:4 Y/Cb/Cr of 3G-SDI signal is supported. *6 PVM-2541A and PVM-1741A can accept DVI signals via the HDMI interface using a conversion cable.

Specifications

BVM-E Series



BVM-E250A



BVM-E170A

Picture Performance		
Panel	OLED panel	
Picture size (diagonal)	24 5/8 inches 623.4 mm	16 1/2 inches 419.7 mm
Effective picture size (H x V)	21 1/2 x 12 1/8 inches 543.4 x 305.6 mm	14 1/2 x 8 1/8 inches 365.8 x 205.7 mm
Resolution (H x V)	1920 x 1080 pixels (Full HD)	
Aspect	16:9	
Pixel efficiency	99.99%	
Panel drive	RGB 10-bit	
Panel frame rate	48 Hz / 50 Hz / 60 Hz / 72 Hz / 75 Hz (48 Hz, 60 Hz, and 72 Hz are also compatible with 1/1.001 frame rates)	
Viewing angle (panel specification)	89°/89°/89°/89° (typical) (up/down/left/right contrast > 10:1)	
Color temperature	D55, D61, D65, D93, D-Cine, and user	
Standard luminance	100 cd/m ² (preset1 to preset5) 48 cd/m ² (preset (D-Cine)) (100% white signal input)	
Color space (color gamut)	ITU-R BT.709, EBU, SMPTE-C, D-Cine ^{*1} , E250A / E170A Native ^{*2} , S-GAMUT ^{*3} The BVM-E250A / BVM-E170A individual chromaticity points: R (x = 0.681, y = 0.319) / G (x = 0.189, y = 0.724) / B (x = 0.141, y = 0.051) (typical)	
Input		
SDI	BNC (x2)	
HDMI	HDMI (x1) (HDCP correspondence, Deep Color correspondence)	
DisplayPort	DisplayPort connector (x1)	
Option port	4 ports	
Parallel remote	D-sub 9-pin (female) (x1)	
Serial remote (LAN)	Ethernet (10BASE-T/100BASE-TX), RJ-45 (x1)	
Output		
SDI	BNC (x1)	
DC 5 V out	Circle 4-pin (female) (x1)	
General		
Power requirement	AC 100 V to 240 V, 1.6 A to 0.8 A, 50/60 Hz	AC 100 V to 240 V, 1.2 A to 0.7 A, 50/60 Hz DC 24 V to 28 V, 4.5 A to 3.9 A
Power consumption	Approx. 145 W (max.) Approx. 72 W (average power consumption in the default status)	Approx. 110 W (AC), 100 W (DC) (max.) Approx. 60 W (AC), 60 W (DC) (average power consumption in the default status)
Operating temperature	32°F to 95°F (0°C to 35°C) Recommended: 68°F to 86°F (20°C to 30°C)	
Operating humidity	0% to 90% (no condensation)	
Storage and transport temperature	-4°F to +140°F (-20°C to +60°C)	
Storage and transport humidity	0% to 90%	
Operating, storage, and transport pressure	700 hPa to 1060 hPa	
Dimensions (W x H x D)	22 3/4 x 16 3/4 x 5 7/8 inches 576.0 x 424.0 x 148.0 mm	17 1/4 x 11 1/4 (10 1/2) ^{*4} x 8 1/2 inches 436.0 x 282.4 (266.4) ^{*4} x 214.7 mm
Weight	28 lb 11 oz 13.0 kg	18 lb 15 oz 8.6 kg
Supplied accessories	AC power cord (1), AC plug holder (1), Bracket (1), Operation Manual (Japanese, English, each 1), CD-ROM (1), Using the CD-ROM Manual (1)	AC power cord (1), AC plug holder (1), Rack mount bracket (left, right, each 1), Rack mount attachment screws (4), Operation Manual (Japanese, English, each 1), CD-ROM (1), Using the CD-ROM Manual (1)

*1 Chromaticity point of SMPTE RP431-2 is not covered in full.

*2 The widest color space setting of the signal reproduced by the BVM-E250A and BVM-E170A.

*3 S-GAMUT is available for displaying the color gamut of the wide color space mode S-GAMUT, which is offered with the F23 and F35 Digital cinematography cameras.

*4 Height without monitor feet.

BVM-F Series



BVM-F250A



BVM-F170A

Picture Performance		
Panel	OLED panel	
Picture size (diagonal)	24 5/8 inches 623.4 mm	16 1/2 inches 419.7 mm
Effective picture size (H x V)	21 1/2 x 12 1/8 inches 543.4 x 305.6 mm	14 1/2 x 8 1/8 inches 365.8 x 205.7 mm
Resolution (H x V)	1920 x 1080 pixels (Full HD)	
Aspect	16:9	
Pixel efficiency	99.99%	
Panel drive	RGB 10-bit	
Panel frame rate	48 Hz / 50 Hz / 60 Hz / 72 Hz / 75 Hz (48 Hz, 60 Hz, and 72 Hz are also compatible with 1/1.001 frame rates)	
Viewing angle (panel specification)	89°/89°/89°/89° (typical) (up/down/left/right contrast > 10:1)	
Color temperature	D65, D93, and user	
Standard luminance	100 cd/m ² (Preset1 to Preset5) (100% white signal input)	
Color space (color gamut)	ITU-R BT.709, EBU, SMPTE-C, F250A / F170A Native* ¹ The BVM-F250A / BVM-F170A individual chromaticity points: R (x = 0.681, y = 0.319) / G (x = 0.189, y = 0.724) / B (x = 0.141, y = 0.051) (typical)	
Input		
SDI	BNC (x2)	
HDMI	HDMI (x1) (HDCP correspondence, Deep Color correspondence)	
DisplayPort	DisplayPort connector (x1)	
Option port	4 ports	
Parallel remote	D-sub 9-pin (female) (x1)	
Serial remote (LAN)	Ethernet (10BASE-T/100BASE-TX), RJ-45 (x1)	
Output		
SDI	BNC (x1)	
DC 5 V out	Circle 4-pin (female) (x1)	
General		
Power requirement	AC 100 V to 240 V, 1.6 A to 0.8 A, 50/60 Hz	AC 100 V to 240 V, 1.2 A to 0.7 A, 50/60 Hz DC 24 V to 28 V, 4.5 A to 3.9 A
Power consumption	Approx. 145 W (max.) Approx. 72 W (average power consumption in the default status)	Approx. 110 W (AC), 100 W (DC) (max.) Approx. 60 W (AC), 60 W (DC) (average power consumption in the default status)
Operating temperature	32°F to 95°F (0°C to 35°C) Recommended: 68°F to 86°F (20°C to 30°C)	
Operating humidity	0% to 90% (no condensation)	
Storage and transport temperature	-4°F to +140°F (-20°C to +60°C)	
Storage and transport humidity	0% to 90%	
Operating, storage, and transport pressure	700 hPa to 1060 hPa	
Dimensions (W x H x D)	22 3/4 x 16 3/4 x 5 7/8 inches 576.0 x 424.0 x 148.0 mm	17 1/4 x 11 1/4 (10 1/2)* ² x 8 1/2 inches 436.0 x 282.4 (266.4)* ² x 214.7 mm
Weight	28 lb 11 oz 13.0 kg	18 lb 15 oz 8.6 kg
Supplied accessories	AC power cord (1), AC plug holder (1), Bracket (1), Operation Manual (Japanese, English, each 1), CD-ROM (1), Using the CD-ROM Manual (1)	AC power cord (1), AC plug holder (1), Rack mount bracket (left, right, each 1), Rack mount attachment screws (4), Operation Manual (Japanese, English, each 1), CD-ROM (1), Using the CD-ROM Manual (1)

*¹ The widest color space setting of the signal reproduced by the BVM-F250A and BVM-F170A.

*² Height without monitor feet.

PVM Series



PVM-2541A

PVM-1741A

PVM-741

Picture Performance			
Panel	OLED panel		
Picture size (diagonal)	24 5/8 inches 623.4 mm	16 1/2 inches 419.7 mm	7 1/2 inches 188.0 mm
Effective picture size (H x V)	21 1/2 x 12 1/8 inches 543.4 x 305.6 mm	14 1/2 x 8 1/8 inches 365.8 x 205.7 mm	6 1/2 x 3 5/8 inches 163.9 x 92.2 mm
Resolution (H x V)	1920 x 1080 pixels (Full HD)		960 x 540 pixels (QHD)
Aspect	16:9		
Panel drive	RGB 10-bit		
Viewing angle (panel specification)	89°/89°/89°/89° (typical) (up/down/left/right contrast > 10:1)		
Input			
Composite	BNC (x1), 1.0 Vp-p ±3 dB sync negative		
SDI	BNC (x2)		
HDMI	HDMI (x1) (HDCP correspondence)		
Audio	Stereo mini jack (x1), -5 dBu 47 kilohms or higher		
Parallel remote	Modular connector 8-pin (x1) (pin-assignable)		
Serial remote (LAN)	RJ-45 modular connector (Ethernet) (x1) (10BASE-T/100BASE-TX)		
DC IN connector	-	XLR-type 4-pin (male) (x1), 12 V DC (output impedance 0.05 ohms or less)	
Output			
Composite	BNC (x1), loop-through, with 75 ohms automatic termination		
SDI	BNC (x1), output signal amplitude: 800 mVp-p ±10%, output impedance: 75 ohms unbalanced		
Audio monitor out	Stereo mini jack (x1)		
Speaker (Built-in)	1.0 W (mono)	0.5 W (mono)	
Headphones output	Stereo mini jack (x1)		
General			
Power requirement	AC 100 V to 240 V, 50/60 Hz, 1.4 A to 0.6 A	AC 100 V to 240 V, 50/60 Hz, 1.0 A to 0.5 A, DC 12 V, 7.0 A	AC 100 V to 240 V, 50/60 Hz, 0.5 A to 0.3 A, DC 12 V, 1.9 A
Power consumption	Approx. 130 W (max.) Approx. 88 W (average power consumption in the default status)	Approx. 90 W (AC power supply) (max.) Approx. 70 W (AC power supply) (average power consumption in the default status)	Approx. 30 W (max.)
Operating temperature	32°F to 95°F (0°C to 35°C) Recommended: 68°F to 86°F (20°C to 30°C)		32°F to 104°F (0°C to 40°C) Recommended: 68°F to 86°F (20°C to 30°C)
Operating humidity	30% to 85% (no condensation)		
Storage and transport temperature	-4°F to +140°F (-20°C to +60°C)		
Storage and transport humidity	0% to 90%		
Operating, storage, and transport pressure	700 hPa to 1060 hPa		
Dimensions (W x H x D) (with stand)	22 3/4 x 16 3/4 x 6 3/4 inches 576.0 x 424.8 x 171.4 mm	17 1/4 x 12 1/8 x 6 3/8 inches 436.0 x 305.6 x 161.0 mm	8 7/8 x 7 1/4 x 6 3/8 inches 222.4 x 183.5 x 161.8 mm (when AC adaptor is attached)
Dimensions (W x H x D) (without stand)	22 3/4 x 16 1/8 x 4 3/8 inches 576.0 x 408.8 x 110.0 mm	17 1/4 x 11 1/2 x 4 3/4 inches 436.0 x 289.6 x 120.0 mm	8 7/8 x 6 5/8 x 2 7/8 inches 222.4 x 166 x 70 mm (when AC adaptor is detached)
Weight	23 lb 5.9 oz 10.6 kg	15 lb 14 oz 7.2 kg	4 lb 6 oz 2.0 kg
	27 lb 16 oz 12.7 kg (with an optional SU-561 monitor stand)	20 lb 8 oz 9.3 kg (with an optional SU-561 monitor stand)	5 lb 12 oz 2.6 kg (When AC adaptor is installed)
Supplied accessories	AC power cord (1), AC plug holder (1), Operating Instructions (1), CD-ROM (1), Using the CD-ROM manual (1)	AC power cord (1), AC plug holder (1), Mounting bracket (2) (including 4 screws), Operating Instructions (1), CD-ROM (1), Using the CD-ROM manual (1)	AC power cord (1), AC plug holder (1), AC adaptor (1), Handle (1), Arm mount bracket (1), Screws (4), Operating Instructions (1), CD-ROM (1), Using the CD-ROM manual (1)

Optional Accessories

BKM-250TG

INPUT/OUTPUT	
Serial digital interface	BNC (x2), Digital component signals sampling frequency: 3G-SDI: Y/Ca/Cr: 148.5 MHz/74.25 MHz/74.25 MHz, G/B/R: 148.5 MHz/148.5 MHz/148.5 MHz HD-SDI: Y/Ca/Cr: 74.25 MHz/37.125 MHz/37.125 MHz, SD-SDI: Y/Ca/Cr: 13.5 MHz/6.75 MHz/6.75 MHz
Monitor out	BNC (x2), Output signal amplitude: 800 mVp-p ±10% Output impedance: 75 ohms unbalanced
Transmission distance	3G-SDI: 70 m (approx. 230 ft) max. (When using 5C-FB coaxial cables (Fujikura) or equivalent.) HD-SDI: 100 m (approx. 328 ft) max. (When using 5C-FB coaxial cables (Fujikura) or equivalent.) SD-SDI: 200 m (approx. 656 ft) max. (When using 5C-2V coaxial cables (Fujikura) or equivalent.)
GENERAL	
Voltage	+3.3 V, +5 V (supplied from the main unit)
Power consumption	Approx. 4 W
Operating temperature	32°F to 95°F (0°C to 35°C) Recommended: 68°F to 86°F (20°C to 30°C)
Operating humidity	0% to 90% (no condensation)
Operating pressure	700 hPa to 1060 hPa
Storage and trans. temperature	-4°F to +140°F (-20°C to +60°C)
Storage and trans. humidity	0% to 90%
Storage and trans. pressure	700 hPa to 1060 hPa
Dimensions (W x H x D)	4 x 13/16 x 6 1/2 inches (100 x 20 x 162 mm)
Weight	9.5 oz (270 g)
Supplied accessories	Operating Instructions (1)

BKM-243HS

INPUT/OUTPUT	
Serial digital interface	BNC (x2), Digital component signals sampling frequency: SD-SDI: Y/R-Y/B-Y: 13.5 MHz, HD-SDI: Y/Ca/Cr: 74.25 MHz Quantization: 10 bits/sample
Monitor out	BNC (x1), Output signal amplitude: 800 mVp-p ±10% Output impedance: 75 ohms unbalanced
Transmission distance	SD-SDI: 200 m (approx. 656 ft) max. (when using 5C-2V coaxial cables (Fujikura) or equivalent) HD-SDI: 100 m (approx. 328 ft) max. (when using 5C-FB coaxial cables (Fujikura) or equivalent)
GENERAL	
Voltage	+3.3 V, +5 V (supplied from the main unit)
Power consumption	Approx. 2 W
Operating temperature	32°F to 95°F (0°C to 35°C) Recommended: 68°F to 86°F (20°C to 30°C)
Operating humidity	0% to 90% (no condensation)
Operating pressure	700 hPa to 1060 hPa
Storage and trans. temperature	-4°F to +140°F (-20°C to +60°C)
Storage and trans. humidity	0% to 90%
Storage and trans. pressure	700 hPa to 1060 hPa
Dimensions (W x H x D)	4 x 13/16 x 6 1/2 inches (100 x 20 x 162 mm)
Weight	Approx. 9 oz (250 g)
Supplied accessories	Operating Instructions (1)

BKM-244CC

INPUT/OUTPUT	
Serial digital interface	BNC (x2), Digital component signals sampling frequency: SD-SDI: Y/R-Y/B-Y: 13.5 MHz, HD-SDI: Y/Ca/Cr: 74.25 MHz Quantization: 10 bits/sample
Monitor out	BNC (x1), Output signal amplitude: 800 mVp-p ±10% Output impedance: 75 ohms unbalanced
Transmission distance	SD-SDI: 200 m (approx. 656 ft) max. (when using 5C-2V coaxial cables (Fujikura) or equivalent) HD-SDI: 100 m (approx. 328 ft) max. (when using 5C-FB coaxial cables (Fujikura) or equivalent)
GENERAL	
Voltage	+3.3 V, +5 V (supplied from the main unit)
Power consumption	Approx. 4 W
Operating temperature	32°F to 95°F (0°C to 35°C) Recommended: 68°F to 86°F (20°C to 30°C)
Operating humidity	0% to 90% (no condensation)
Operating pressure	700 hPa to 1060 hPa
Storage and trans. temperature	14°F to 104°F (-10°C to +40°C)
Storage and trans. humidity	0% to 90%
Storage and trans. pressure	700 hPa to 1060 hPa
Dimensions (W x H x D)	4 x 13/16 x 6 1/2 inches (100 x 20 x 162 mm)
Weight	9 oz (250 g)
Supplied accessories	Operating Instructions (1)

BKM-229X

INPUT/OUTPUT	
RGB / Component	BNC (x3) RGB: 0.7 Vp-p ±3 dB (Sync on Green, 0.3 Vp-p sync negative) Component: 0.7 Vp-p ±3 dB
External sync input	BNC (x1), 0.3 Vp-p to 4 Vp-p ± bipolarity ternary or negative polarity binary Mini DIN 4-pin (x1), Loop-through, with 75 ohms automatic termination
GENERAL	
Voltage	+3.3 V, +5 V (supplied from the main unit)
Power consumption	Approx. 4 W
Operating temperature	32°F to 95°F (0°C to 35°C) Recommended: 68°F to 86°F (20°C to 30°C)
Operating humidity	0% to 90% (no condensation)
Operating pressure	700 hPa to 1060 hPa
Storage and trans. temperature	-4°F to +140°F (-20°C to +60°C)
Storage and trans. humidity	0% to 90%
Storage and trans. pressure	700 hPa to 1060 hPa
Dimensions (W x H x D)	4 x 13/16 x 6 1/2 inches (100 x 20 x 162 mm)
Weight	9 oz (250 g)
Supplied accessories	Operating Instructions (1)

BKM-227W

INPUT/OUTPUT	
Composite input	BNC (x1), 1 Vp-p \pm 3 dB sync negative
Y/C input	Mini DIN 4-pin (x1) Y: 1 Vp-p \pm 3 dB sync negative C: 0.286 Vp-p \pm 3 dB (NTSC burst signal level), 0.3 Vp-p \pm 3 dB (PAL, PAL-M burst signal level)
Monitor out	BNC (x1), Loop-through, with 75 ohms automatic termination Mini DIN 4-pin (x1), Loop-through, with 75 ohms automatic termination
GENERAL	
Voltage	+3.3 V, +5 V (supplied from the main unit)
Power consumption	Approx. 1.8 W
Operating temperature	32°F to 95°F (0°C to 35°C) Recommended: 68°F to 86°F (20°C to 30°C)
Operating humidity	0% to 90% (no condensation)
Operating pressure	700 hPa to 1060 hPa
Storage and trans. temperature	-4°F to +140°F (-20°C to +60°C)
Storage and trans. humidity	0% to 90%
Storage and trans. pressure	700 hPa to 1060 hPa
Dimensions (W x H x D)	4 x 13/16 x 6 1/2 inches (100 x 20 x 162 mm)
Weight	8 oz (240 g)
Supplied accessories	Operating Instructions (1)

BKM-220D

INPUT/OUTPUT	
Serial digital interface	BNC (x2), Digital component signals sampling frequency: Y/R-Y/B-Y: 13.5 MHz Quantization: 10 bits/sample
Monitor out	BNC (x1), Output signal amplitude: 800 mVp-p \pm 10% Output impedance: 75 ohms unbalanced
Transmission distance	200 m (approx. 656 ft) max. (when using 5C-2V coaxial cables (Fujikura) or equivalent)
GENERAL	
Voltage	+5 V (supplied from the main unit)
Power consumption	Approx. 1.5 W
Operating temperature	32°F to 95°F (0°C to 35°C) Recommended: 68°F to 86°F (20°C to 30°C)
Operating humidity	0% to 90% (no condensation)
Operating pressure	700 hPa to 1060 hPa
Storage and trans. temperature	-4°F to +140°F (-20°C to +60°C)
Storage and trans. humidity	0% to 90%
Storage and trans. pressure	700 hPa to 1060 hPa
Dimensions (W x H x D)	4 x 13/16 x 6 1/2 inches (100 x 20 x 162 mm)
Weight	9 oz (250 g)
Supplied accessories	Operating Instructions (1)

BKM-16R

INPUT/OUTPUT	
LAN	10BASE-T/100BASE-TX connector: RJ-45 (x1)
DC 5 V / 12 V IN	Circle 4-pin (male) (x1)
GENERAL	
Power requirements	DC IN: 5 V, 1.1 A (supplied by the connected monitor) DC IN: 12 V, 0.5 A (supplied by the connected AC adaptor) AC adaptor: AC IN: 100 V to 240 V, 50/60 Hz, DC OUT: 12 V, 3 A
Current consumption	5 V DC, 1.1 A / 12 V DC, 0.5 A
Power consumption	Approx. 6 W
Operating temperature	32°F to 95°F (0°C to 35°C), Recommended: 68°F to 86°F (20°C to 30°C)
Operating humidity	0% to 90% (no condensation)
Operating pressure	700 hPa to 1060 hPa
Storage and trans. temperature	14°F to 104°F (-10°C to +40°C)
Storage and trans. humidity	0% to 90%
Storage and trans. pressure	700 hPa to 1060 hPa
Dimensions (W x H x D)	16 3/4 x 2 3/8 x 7 inches (424 x 58.8 x 174.9 mm)
Weight	4 lb 10 oz (2.1 kg)
Supplied accessories	AC adaptor (1), AC power cord (parts number: 1-757-562-1x1 for USA and Canada, 1-575-131-8x for Europe) (1), Rack mount brackets (2), Rack mount attachment screws (4), Function labels (2), Operation manual (1)

Optional Accessories

For BVM-E250A, BVM-E170A, BVM-F250A, and BVM-F170A



BKM-16R*1
Monitor Control Unit



BKM-250TG
3G/HD/SD-SDI Input Adaptor



BKM-244CC
HD/SD-SDI Closed Caption Adaptor



BKM-243HS
HD/SD-SDI Input Adaptor



BKM-220D
SD-SDI 4:2:2 Input Adaptor

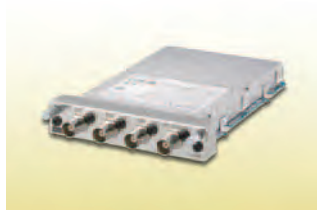

BKM-229X
Analog Component Adaptor



BKM-227W
NTSC/PAL Input Adaptor



BKM-37H*2
Controller Attachment Stand
(for BVM-E250A / BVM-F250A)



BKM-38H*2
Controller Attachment Stand
(for BVM-E250A / BVM-F250A)



BKM-39H*2
Controller Attachment Stand
(for BVM-E170A / BVM-F170A)



SMF-700
Monitor Interface Cable

For PVM-2541A and PVM-1741A



SU-561
Monitor Stand

For PVM-741



MB-531
Mounting Bracket



MB-532
Mounting Panel



VF-510
ENG Kit (Viewing Hood, Carrying
Handle and Connector Protector)

*1 Requires the latest version of the BKM-16R with a product code suffix /7 or later.

*2 Requires the latest version of the BKM-37H, BKM-38H, and BKM-39H with a product code suffix /1 or later.

*3 Optional accessories are sold separately.

Dimensions

BVM-E Series

Unit: inches (mm)

■ BVM-E250A / BVM-F250A

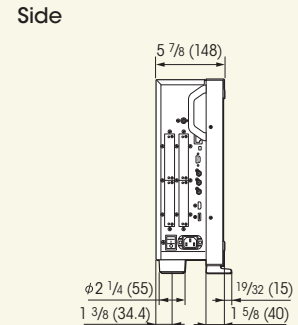
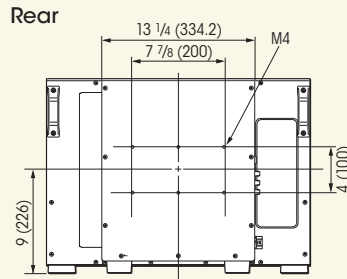
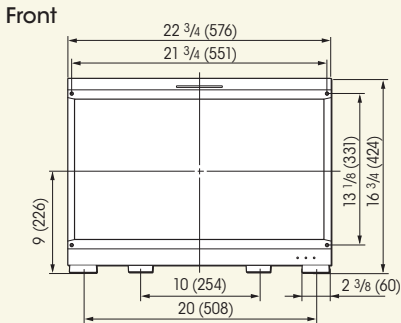

■ BVM-E250A / BVM-F250A with the optional BKM-16R and BKM-37H with a tilt

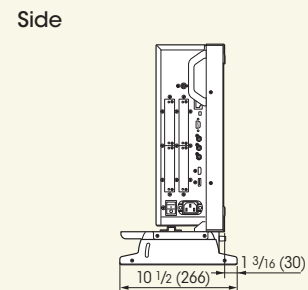
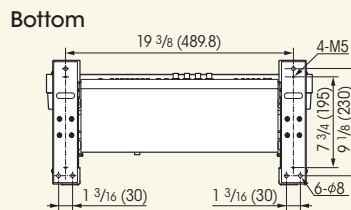
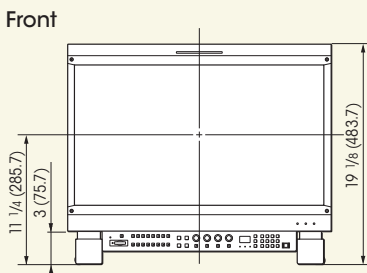

■ BVM-E250A / BVM-F250A with the optional BKM-16R and BKM-38H

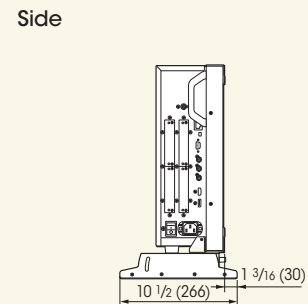
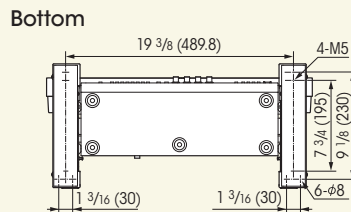
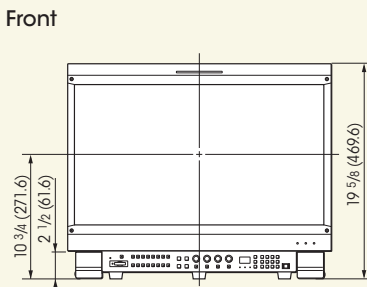

■ BVM-E170A / BVM-F170A

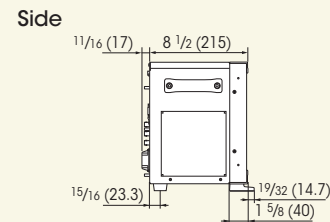
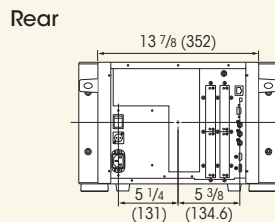
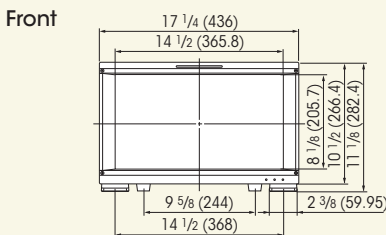

■ BVM-E170A / BVM-F170A with the optional BKM-16R and BKM-39H

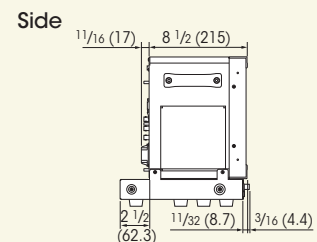
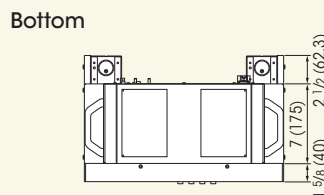
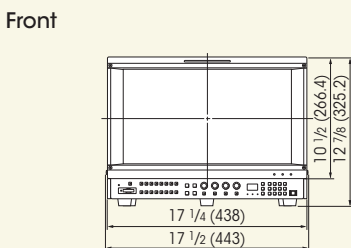

PVM Series

Unit: inches (mm)

■ PVM-2541A

Front

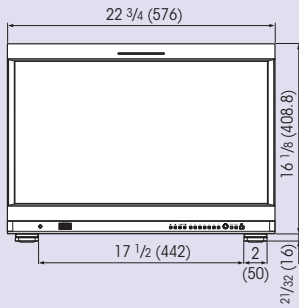

Rear

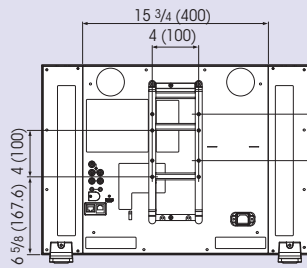

Side

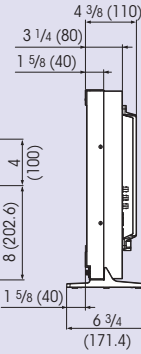

■ PVM-2541A with the optional SU-561 stand

Front

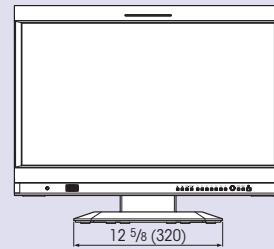

Side

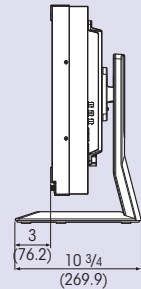

■ PVM-1741A

Front

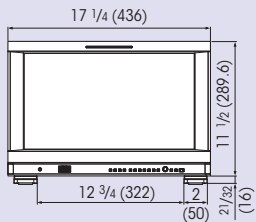

Rear

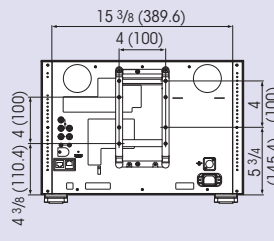

Side

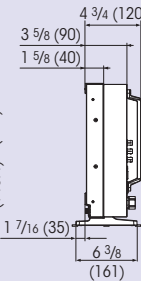

Front

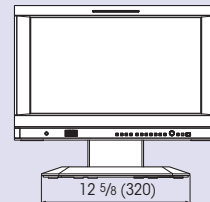

Side

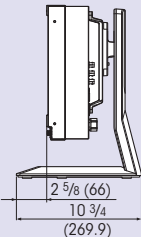

■ PVM-741

Front

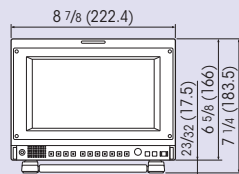

Side

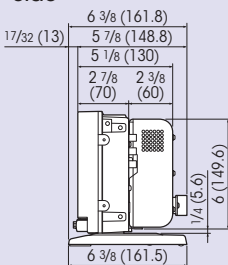

Bottom (Without the stand)

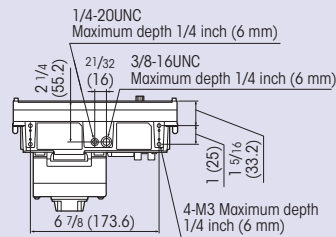

Top (With the arm mount bracket)

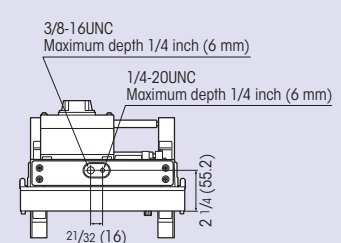

■ BKM-16R

Unit: inches (mm)

Front

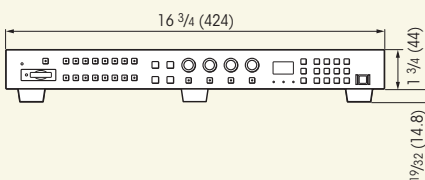

Top

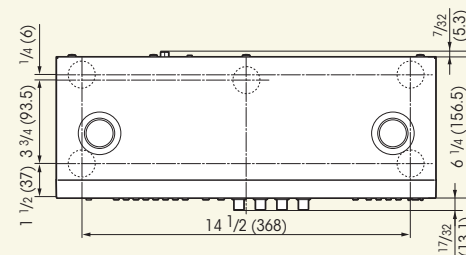

Side

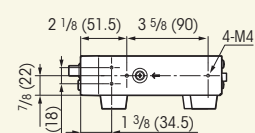

SONY

make.believe

The BVM-E250A, BVM-E170A, BVM-F250A, and BVM-F170A are produced at Sony EMCS Corporation Kosai Site, which has received ISO14001 Environmental Management System certification. The PVM-2541A, PVM-1741A, and PVM-741 are produced under control of the Sony EMCS Corporation Kosai Site.



Sony Electronics Inc.
1 Sony Drive
Park Ridge, NJ 07656
sony.com/oled

DI-0299 (MK10815V5)

©2013 Sony Corporation. All rights reserved.
Reproduction in whole or in part without written permission is prohibited.
Features and specifications are subject to change without notice.
Screen images are simulated.
The values for weight and dimension are approximate.
"SONY", "make.believe", "TRIMASTER", "TRIMASTER EL", "ChromaTRU",
"Memory Stick", "Memory Stick PRO", "Memory Stick Duo", "Memory Stick
PRO Duo", and "Memory Stick Micro" are trademarks of Sony Corporation.
HDMI is a trademark of HDMI Licensing, LLC.
All other trademarks are the properties of their respective owners.

Printed in USA (4/13)